

## Building Bins and Boxes for Compost

More and more gardeners are recycling household organic wastes by composting them. Many find that simply mounding compostable materials into a heap is unsatisfactory.

Containers such as bins and boxes can protect the compost from wind, heavy rains and hot, baking sun. Many varieties of bins and boxes can make composting easier and improve its appearance and quality. The type of container you select depends upon your personal taste, the amount of labor you want to invest and the materials you have on hand.

**Woven wire bin.** One easy to make, economical container requires only a length of woven wire fencing held together by several small chain snaps.

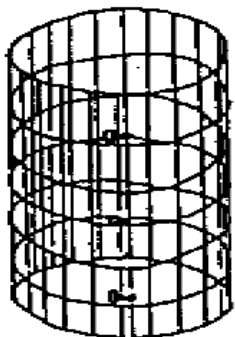
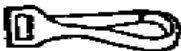

Multiply the diameter you want for the compost heap by 3.1416. That's the length of wire you should buy. Once you've purchased the fencing and picked a location for the compost heap, bring both ends of the fencing together to form a circle.

The ends of the fencing are held together by three or four small chain snaps that are available at any hardware or discount store. Simply slip the snaps over any two wires to form the enclosure.

Start building the compost heap inside this wire enclosure.

When it is half full, drive a wooden or steel stake through the center of the heap and into the soil beneath. Be sure that the stake is long enough so the top is as high as the final desired pile height. Fill to the top with compost material.

When you're ready to start a second heap, simply remove the snaps holding the ends of the fencing together. Pull the fence away from the completed heap, and erect it again at the new heap site. It takes less than a minute to remove these snaps and they can be used over and over again.

Even after the fencing is removed, the compost pile will keep a uniform shape. The stake through the center prevents it from caving in or falling apart.

If you're going to keep just one compost heap, remove the fencing when you get ready to turn the pile.

Set up the fencing within easy shoveling distance of the compost heap. Pull the stake out of the center. Now start turning the compost into the empty bin.

During dry weather spells, dig a depression in the top of each heap and water moderately. The stake will not interfere with the depression. In fact, the water will flow down the post into the center of the compost heap.

**Chicken wire bin.** A variation of the wire retainer described above can be made using chicken wire, wood stakes and soft iron baling wire. Thirty feet of ½"-woven chicken wire, 30 four-foot high stakes and about 60 feet of soft iron baling wire will make a container that will hold about 200 cubic feet of compost.

To construct this container, first mark off a rectangle about 10'x5'. Drive the stakes six inches deep along the edge of this rectangle, placing them about a foot apart. Loop the bin with a continuous strip of baling wire.

### Chicken Wire Bin

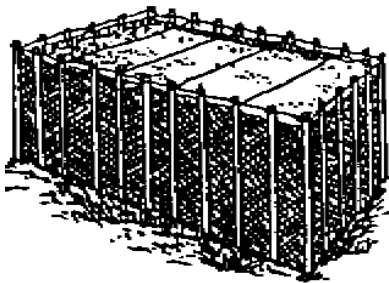

Place the chicken wire inside the stakes and fasten it by twisting small pieces of baling wire around the stakes.

Tie lengths of baling wire across the width of the container to keep the stakes from spreading when the bin is filled with compost. These cross braces looped over alternate pairs of stakes allow ample space for easy loading of your compost. As the compost presses outward against the chicken wire, the stakes will pull the soft baling wire bracings tightly around the container.

When it's time to turn the compost, remove the small ties holding the chicken wire to the wood stakes then remove the cross bracing wires. After pulling out the wooden stakes, carefully roll away the chicken wire and you'll find a nice solid

pile of compost ready for turning. Use the same materials to rebuild your container within shoveling distance of the old heap.

### Block or Brick Bins

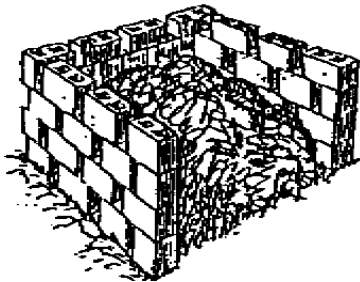

Compost bins can also be made of brick, or cement blocks, or rocks. Just lay the blocks without mortar. Leave spaces between each block to permit aeration. Pile them up to form three sides of a square container. This bin is sturdy, durable and easily accessible.

### Snow Fence Bins

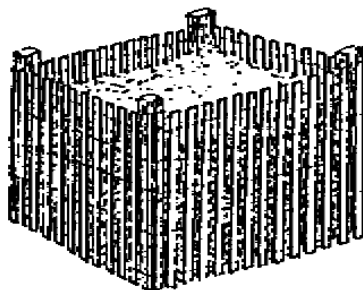

Some gardeners use pre-fabricated snow fencing for making compost bins. Snow fence bins are popular because they are simple to make and easy to move and store. To build this bin, buy the appropriate length of pre-fabricated fencing, and fasten two by fours (2 x 4s) to the bottom to form a square.

**The New Zealand Box** is another simple, efficient design developed by the Auckland Humic Club of New Zealand. There are many variations of this design. The simplest is a wooden structure 4 feet square by 4-5 feet high without top or bottom.

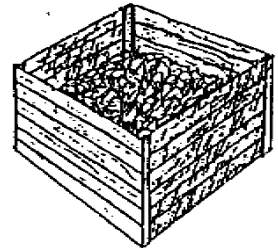

The wooden sides consist of 6-inch wide by 3/4-inch thick boards. Allow 1/2-inch of air space between each board so that air may penetrate the heap from all sides. The box is movable.

A divider in front slides down between two posts so that when you want to empty the box, you can pull the dividers upward and take them out one by one. 2 x 4s provide the structural framework for this box.

The preferred method of filling the box is to mix organic materials thoroughly with soil, lime and manure. Make one air hole in the center of the box all the way down to the ground using a crowbar. If you turn the mixture twice, you don't need to put in an air hole after the second turn.

When the compost is ready to be turned, it has to be piled outside the box and then put back again

You can save yourself some time by doubling the box size (4'x8') with a partition in the center. The material is forked from one section into the other and a new batch is then placed into the first section.

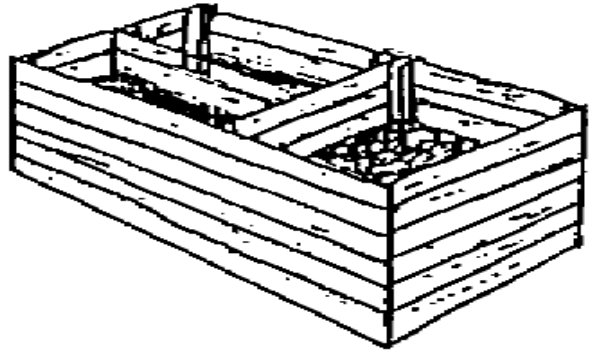

If you turn your compost heap twice, make a three section box (12'x4'). The third section/compartment can be used to cure and store the finished compost.

**The Lehigh-Keston Bin.** The Lehigh-Keston compost bin, designed by J.I. Rodale over ten years ago, has proved to be a popular design. The bin is made of wooden slats, is very portable, long lasting, and ideal for proper compost ventilation.

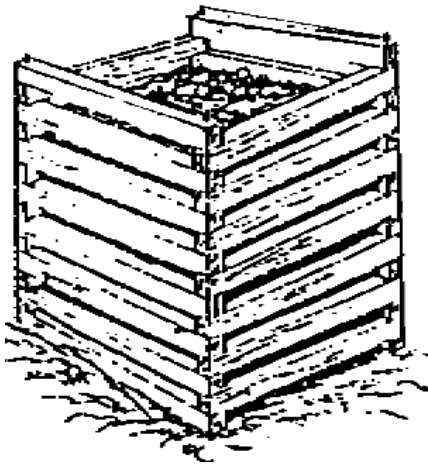

Drill holes at the ends of each slat vertically from top to bottom. Fasten together by inserting metal rods through the holes to form a square.

**Perforated Steel Drum.** A large 55-gallon steel drum with a secure lid can be used for composting. Cut holes in the sides to allow air to circulate and excess moisture to escape. At least 50 percent of the drum's overall surface should be perforated using a 1/2" drill bit.

Fill the drum about three-quarters full, secure the lid and roll it around the yard every couple of days. The material will be mixed and, most importantly, aerated by the rolling action.

This is a relatively easy system to use and to maintain. Unless weather is excessively rainy, the lid should be removed after turning to enhance air penetration.

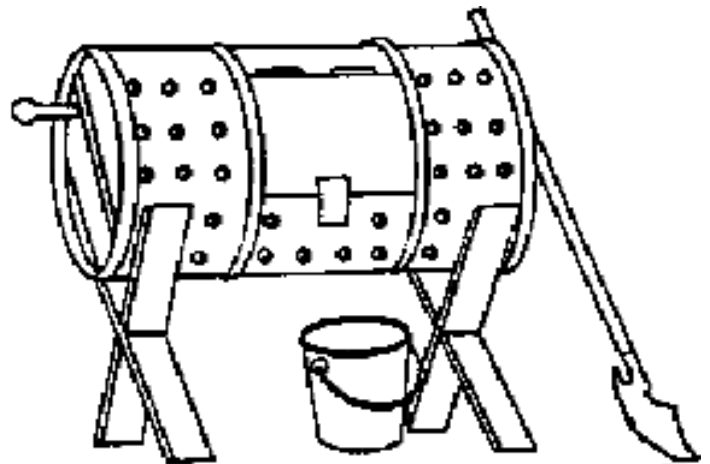

## Wood and Wire Stationary Three-Bin System

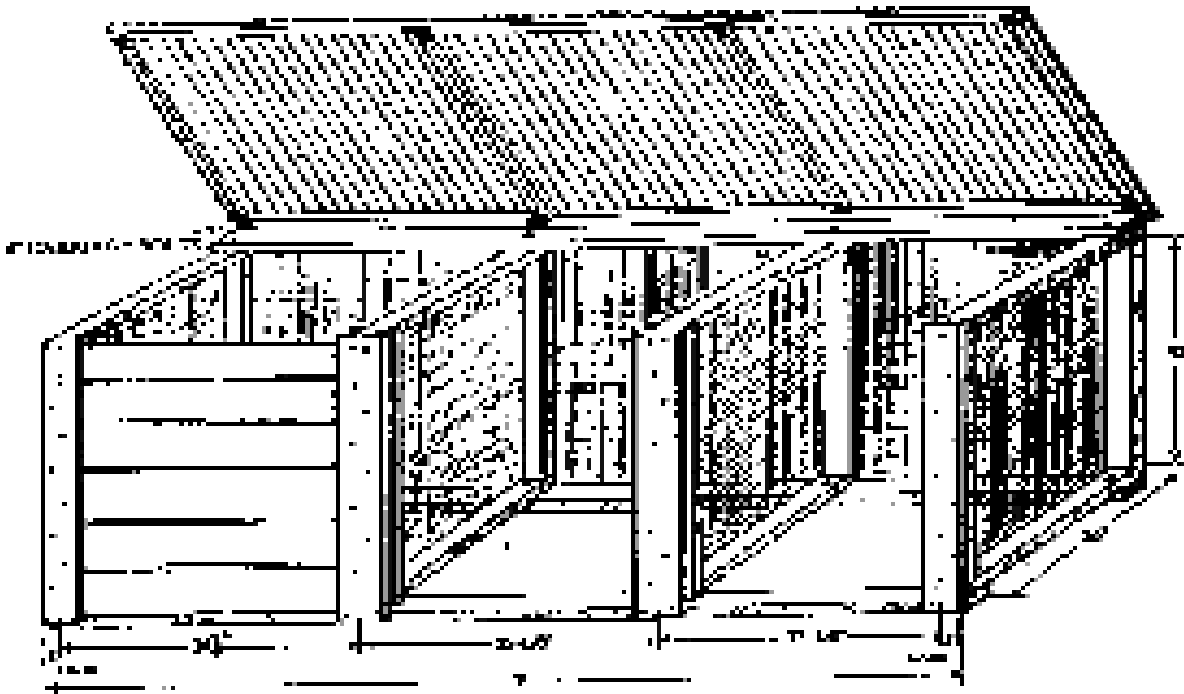

This system is used to compost large amounts of yard and kitchen wastes in a brief period of time. Wastes are stored until enough are available to fill an entire bin. Materials are then chopped, moistened and layered to ensure a hot compost. Piles are turned weekly for aeration. A pile made with a balance of fresh greens and woody materials and turned weekly can be ready to use in three weeks. The texture of the finished compost depends on the materials composted. This unit can be built for approximately \$130. Construction requires basic carpentry skills and tools.

### Materials.

- 2 – 18-foot treated 2x4s
- 4 – 12-foot, *or* 8 – 6-foot treated 2x4s
- 1 – 9-foot, **and** 2 – 6-foot 2x2s
- 1 – 16-foot cedar 2x6
- 9 – 6-foot cedar 1x6s
- 22 feet of 36-inch wide ½-inch hardware cloth
- 12 – ½-inch carriage bolts, 4-inches long
- 12 – washers **and** 12 nuts for bolts
- 3 – lbs. of 16d galvanized nails

- ½ lb. – 8d galvanized casement nails
- 250 – poultry wire staples *or* power stapler w/1" staples
- 1 – 12-foot, **and** 1 – 8-foot sheet 4 oz. clear corrugated fiberglass
- 3 – 8-foot lengths of wiggle molding

**Tools.** Hand saw or circular power saw drill with ½" and 1/8" bits; screwdriver, hammer, tin snips, tape measure, and pencil; ¾" socket or open ended wrench, carpenter's square, (option — power stapler with 1" long galvanized staples), safety glasses and ear protection.

- 40 – gasketed aluminum nails for corrugated fiberglass roofing
- 2 – 3" zinc plated hinges for lid
- 8 – flat 4" corner braces with screws
- 4 – flat 3" T-braces with screws

## Construction Details.

- **Build Dividers.** Cut two 31½" and two 36" pieces from each 12-foot 2x4. Butt end nail the four pieces into a 35"x36" square. Repeat for other three sections. Cut four 37" long sections of hardware cloth, and bend back edge 1". Stretch hardware cloth across each frame; check for squareness of the frame and staple screen tightly into place every 4" around edge.

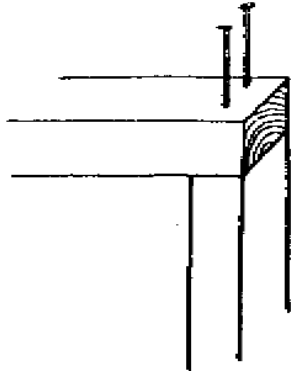

- **Set Up Dividers.** Set-up dividers parallel to one another 3 feet apart. Measure and mark centers for the two inside dividers. Cut four 9-foot pieces out of the two 18-foot 2x4 boards. Place two 9-foot base boards on top of dividers and measure the positions for the two inside dividers. Mark a center line for each divider on the 9-foot 2x4. With each divider, line up the center lines and make the base board flush against the outer edge of the divider. Drill a 1/2" hole through each junction centered 1" in from the inside edge. Secure base boards with carriage bolts, but do not tighten yet. Turn the unit right side up and repeat the process for the top 9-foot board. Using the carpenter's square or measuring between opposing corners, make sure the bin is square, and tighten all bolts securely. Fasten a 9-foot long piece of hardware cloth securely to the backside of the bin with staples every 4" around the frame.

- **Front Slats and Runners.** Cut four, 36" long 2x6s for front slat runners. Rip-cut two of these boards to 4 3/4" wide and nail them securely to the front of the outside dividers and baseboard, making them flush on top and outside edges. Save remainder of rip-cut boards for use as back runners. Center the remaining full-width boards on the front of the inside dividers flush with the top edge, and nail securely. To create back runners, cut the remaining 2x6 into a 34" long piece and then rip-cut into 4 equal pieces, 1¼"x2". Nail back runner parallel to front runners on side of divider leaving a 1-inch gap for slats. Cut all the 1x6" cedar boards into slats 31¼" long.
- **Fiberglass Lid.** Use the last 9 foot 2x4 for the back of the lid. Cut four 32½" 2x2s and one 9 foot 2x2. Lay into position on ground as illustrated on page four and check for squareness. Screw in corner braces and T-braces on bottom side of the frame. Center lid frame, brace side down on bin structure and attach with hinges. Cut wiggle board to fit the front and back 9-foot sections of the lid frame. Pre-drill wiggle board with 1/8" drill bit and nail with 8d casement nails. Cut fiberglass to fit flush with front and back edges. Overlay pieces at least one channel wide. Pre-drill fiberglass and wiggle board for each nail hole. Nail on top of every third hump with gasketed nails.

## Portable Wood & Wire Composting Bin

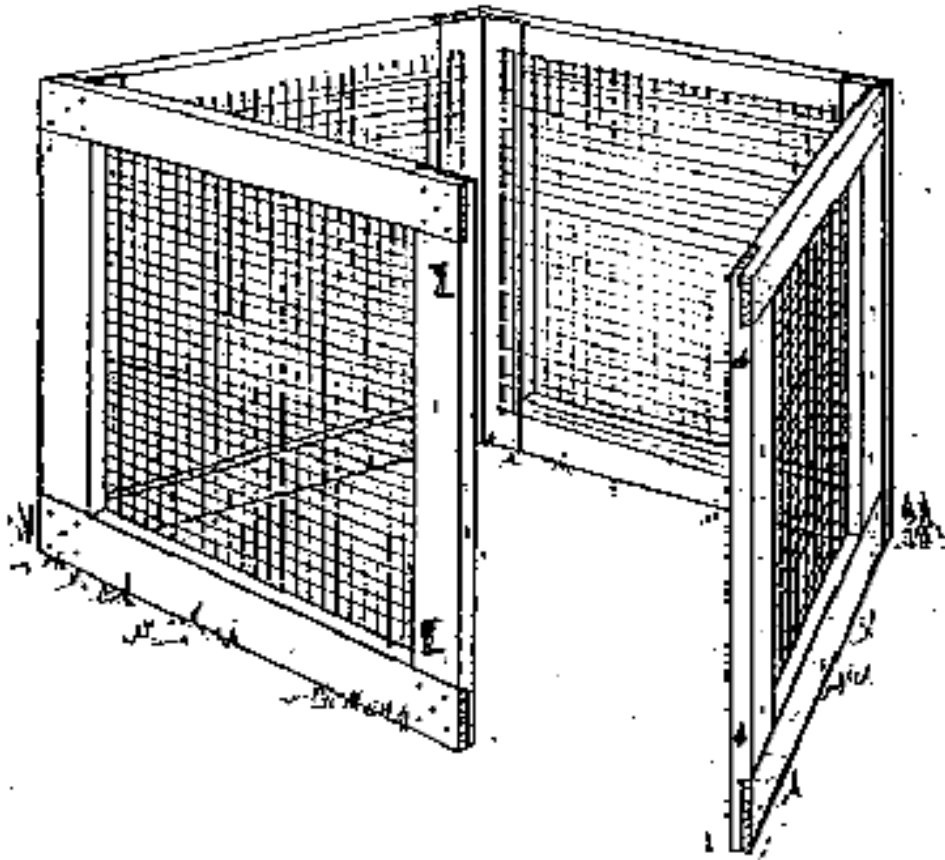

This portable bin provides a convenient way to compost moderate volumes of yard wastes with minimal labor. Yard wastes are simply added to the bin as they are generated. With no effort besides occasional moistening, compost will be ready in 6 months to 2 years. Chopping or shredding materials, maintaining adequate moisture by watering and covering with plastic or heavy fabric and occasional turning will produce finished compost in a shorter period of time. Texture of the finished compost depends on the materials composted and how long they are left in the bin. Mixing fresh greens with brown yard wastes will produce the best results.

This bin is very flexible. It fits well in small spaces, and may be used either as a yard waste holding bin or as a portable turning unit. The bin can be easily moved to turn piles or to harvest finished compost and build a new pile: Simply undo the latches, pull the sides apart and move it. Compost may then be turned into the bin at its new location, and finished compost can be removed from the bottom.

### Materials.

- 1 – 12-foot pressure treated 2x4
- 3 – 12-foot fir 2x4
- 12 feet of 36" wide ½" hardware cloth
- 100 – 1 ½" galvanized No. 8 wood screws
- 4 – 3" galvanized butt door hinges
- 150 – poultry wire staples or power stapler
- 1 – 10-oz. tube exterior wood adhesive
- 6 – large hook and eye gate latches

### Tools.

Hand saw and chisel, *or* radial arm saw with dado blade, *or* circular saw, *or* table saw. Hammer, screwdriver, tin snips, caulking gun, pencil and small carpenter's square. ***Use eye and ear protection.***

**Construction Details.** Cut each 12-foot 2x4 into four 3-foot long pieces. Cut a 3/4" deep and 3-1/2" wide section out of each end, for a total of 32 lap cuts. If using handsaw and chisel, cut 3/4" down at the 3 1/2"-line at A in diagram to right. Then cut a 1/2"-deep groove into the end of the board at B in the diagram. Place a thick wood chisel in the end groove and split the wood with a hammer to the 3 1/2" cut. If using a radial arm saw, circular saw or table saw, set blade depth to 1/3" and make multiple passes until the whole section is removed.

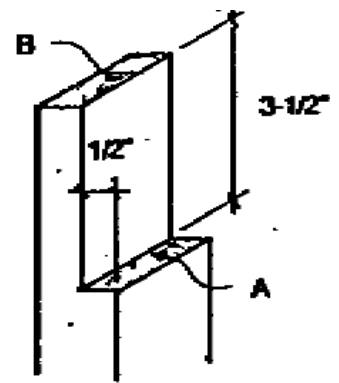

Make four, 3-foot square frames from the lap jointed 2x4s. Use one pressure treated 2x4 on each frame. Put enough construction adhesive to fill the gaps when the lap joints are screwed together. Fasten each joint with four screws.

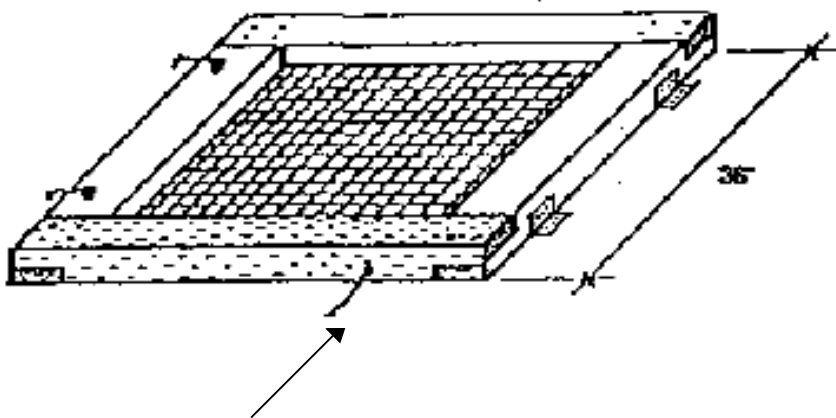

Pressure Treated Lumber on Bottom

Cut the hardware cloth with tin snips into four, 3-foot square sections. Bend the edges of the cloth back over 1" for strength. Lay one onto each of the four frames. Center and tack each corner with a poultry wire staple. Hammer place a staple every 4" along all four edges of the hardware cloth. Try to tension the cloth so it will not sag when filled with compost.

Connect each pair of frames together with two hinges. Then put the hook and eye gate latches on the other ends so that the sections latch together.

---

Plans (for Systems on pages 4, 5, 6 and 7) courtesy of: Seattle Tilth Association *and* Seattle Solid Waste Utility

Source: Wisconsin Dept. of Natural Resources Bureau of Solid Waste Management

10/1994 CCE of Chemung County

9/1999 Updated