

# Materials of Engineering

BY

HOWARD S. BEAN *Late Physicist, National Bureau of Standards*  
 HAROLD W. PAXTON *United States Steel Professor Emeritus, Carnegie Mellon University*  
 JAMES D. REDMOND *President, Technical Marketing Resources, Inc.*  
 MALCOLM BLAIR *Technical & Research Director, Steel Founders Society of America*  
 ROBERT E. EPPICH *Vice President, Technology, American Foundrymen's Society*  
 L. D. KUNSMAN *Late Fellow Engineer, Research Labs, Westinghouse Electric Corp.*  
 C. L. CARLSON *Late Fellow Engineer, Research Labs, Westinghouse Electric Corp.*  
 J. RANDOLPH KISSELL *Partner, The TGB Partnership*  
 FRANK E. GOODWIN *Vice President, Materials Science, ILZRO, Inc.*  
 DON GRAHAM *Manager, Turning Programs, Carboloy, Inc.*  
 ARTHUR COHEN *Manager, Standards and Safety Engineering, Copper Development Assn.*  
 JOHN H. TUNDERMANN *Vice President, Research & Technology, INCO Alloys International, Inc.*  
 JAMES D. SHEAROUSE, III *Senior Development Engineer, The Dow Chemical Co.*  
 PETER K. JOHNSON *Director, Marketing & Public Relations, Metal Powder Industries Federation*  
 JOHN R. SCHLEY *Manager, Technical Marketing, RMI Titanium Co.*  
 ROBERT D. BARTHOLOMEW *Engineer, Powell Labs, Ltd.*  
 DAVID A. SHIFLER *Metallurgist, Naval Surface Warfare Center*  
 HAROLD M. WERNER *Consultant*  
 RODNEY C. DEGROOT *Research Plant Pathologist, Forest Products Lab, USDA*  
 DAVID W. GREEN *Supervisory Research General Engineer, Forest Products Lab, USDA*  
 ROLAND HERNANDEZ *Research General Engineer, Forest Products Lab, USDA*  
 RUSSELL C. MOODY *Supervisory Research General Engineer, Forest Products Lab, USDA*  
 JOSEPH F. MURPHY *Supervisory General Engineer, Forest Products Lab, USDA*  
 ROBERT J. ROSS *Supervisory Research General Engineer, Forest Products Lab, USDA*  
 WILLIAM T. SIMPSON *Research Forest Products Technologist, Forest Products Lab, USDA*  
 ANTON TENWOLDE *Research Physicist, Forest Products Lab, USDA*  
 ROBERT H. WHITE *Supervisory Wood Scientist, Forest Products Lab, USDA*  
 ANTONIO F. BALDO *Professor of Mechanical Engineering, Emeritus, The City College, The City University of New York*  
 WILLIAM L. GAMBLE *Professor of Civil Engineering, University of Illinois at Urbana-Champaign*  
 ARNOLD S. VERNICK *Associate, Geraghty & Miller, Inc.*  
 JULIAN H. DANCY *Consulting Engineer. Formerly Senior Technologist, Technology Division, Fuels and Lubricants Technology Department, Texaco, Inc.*  
 STEPHEN R. SWANSON *Professor of Mechanical Engineering, University of Utah*

## 6.1 GENERAL PROPERTIES OF MATERIALS by Howard S. Bean

Chemistry .....	6-3
Specific Gravities and Densities .....	6-7
Other Physical Data .....	6-10

## 6.2 IRON AND STEEL by Harold W. Paxton and James D. Redmond

Classification of Iron and Steel .....	6-13
Steel .....	6-13

Effect of Alloying Elements on the Properties of Steel .....	6-19
Principles of Heat Treatment of Iron and Steel .....	6-19
Composite Materials .....	6-21
Thermomechanical Treatment .....	6-22
Commercial Steels .....	6-22
Tool Steels .....	6-30
Spring Steel .....	6-31
Special Alloy Steels .....	6-32

## 6-2 MATERIALS OF ENGINEERING

Stainless Steels (James D. Redmond) . . . . . 6-32

### 6.3 IRON AND STEEL CASTINGS by Malcolm Blair and Robert E. Eppich

Classification of Castings . . . . . 6-38  
Cast Iron . . . . . 6-38  
Steel Castings . . . . . 6-43

### 6.4 NONFERROUS METALS AND ALLOYS; METALLIC SPECIALITIES

Introduction (By L. D. Kunsman and C. L. Carlson, amended by staff) . . . 6-49  
Aluminum and Its Alloys (By J. Randolph Kissell) . . . . . 6-53  
Bearing Metals (By Frank E. Goodwin) . . . . . 6-61  
Cemented Carbides (By Don Graham) . . . . . 6-61  
Copper and Copper Alloys (By Arthur Cohen) . . . . . 6-65  
Jewelry Metals (Staff Contribution) . . . . . 6-74  
Low-Melting-Point Metals and Alloys (By Frank E. Goodwin) . . . . . 6-74  
Metals and Alloys for Use at Elevated Temperatures (By John H. Tundermann) . . . . . 6-77  
Metals and Alloys for Nuclear Energy Applications (By L. D. Kunsman and C. L. Carlson) . . . . . 6-82  
Magnesium and Magnesium Alloys (By James D. Shearouse, III) . . . . . 6-84  
Powdered Metals (By Peter K. Johnson) . . . . . 6-87  
Nickel and Nickel Alloys (By John H. Tundermann) . . . . . 6-88  
Titanium and Zirconium (By John R. Schley) . . . . . 6-91  
Zinc and Zinc Alloys (By Frank E. Goodwin) . . . . . 6-93

### 6.5 CORROSION by Robert D. Bartholomew and David A. Shifler

Introduction . . . . . 6-95  
Thermodynamics of Corrosion . . . . . 6-95  
Corrosion Kinetics . . . . . 6-96  
Factors Influencing Corrosion . . . . . 6-97  
Forms of Corrosion . . . . . 6-99  
Corrosion Testing . . . . . 6-103  
Corrosion Prevention or Reduction Methods . . . . . 6-104  
Corrosion in Industrial and Utility Steam-Generating Systems . . . . . 6-105  
Corrosion in Heating and Cooling Water Systems and Cooling Towers. . . 6-107  
Corrosion in the Chemical Process Industry . . . . . 6-107

### 6.6 PAINTS AND PROTECTIVE COATINGS by Harold M. Werner and Expanded by Staff

Paint Ingredients . . . . . 6-108  
Paints . . . . . 6-109  
Other Protective and Decorative Coatings . . . . . 6-110  
Varnish . . . . . 6-112

### 6.7 WOOD

By Staff, Forest Products Laboratory, USDA Forest Service, under the direction of David W. Green

Composition, Structure, and Nomenclature (By David D. Green) . . . . . 6-113  
Physical and Mechanical Properties of Clear Wood (By David Green, Robert White, Anton TenWolde, William Simpson, Joseph Murphy, and Robert Ross) . . . . . 6-113  
Properties of Lumber Products (By Russell Moody and David Green) . . . 6-119  
Properties of Structural Panel Products (By Roland Hernandez) . . . . . 6-124  
Durability of Wood in Construction (By Rodney De Groot and Robert White) . . . . . 6-126  
Commercial Lumber Standards . . . . . 6-128

### 6.8 NONMETALLIC MATERIALS by Antonio F. Baldo

Abrasives . . . . . 6-128  
Adhesives . . . . . 6-130  
Brick, Block, and Tile . . . . . 6-131

Ceramics . . . . . 6-136  
Cleansing Materials . . . . . 6-137  
Cordage . . . . . 6-137  
Electrical Insulating Materials . . . . . 6-138  
Fibers and Fabrics . . . . . 6-139  
Freezing Preventives . . . . . 6-141  
Glass . . . . . 6-142  
Natural Stones . . . . . 6-143  
Paper . . . . . 6-144  
Roofing Materials . . . . . 6-145  
Rubber and Rubberlike Materials (Elastomers) . . . . . 6-146  
Solvents . . . . . 6-148  
Thermal Insulation . . . . . 6-149  
Silicones . . . . . 6-151  
Refractories . . . . . 6-151  
Sealants . . . . . 6-155

### 6.9 CEMENT, MORTAR, AND CONCRETE by William L. Gamble

Cement . . . . . 6-159  
Lime . . . . . 6-160  
Aggregates . . . . . 6-161  
Water . . . . . 6-161  
Admixtures . . . . . 6-162  
Mortars . . . . . 6-162  
Concrete . . . . . 6-163

### 6.10 WATER by Arnold S. Vernick

Water Resources . . . . . 6-168  
Measurements and Definitions . . . . . 6-169  
Industrial Water . . . . . 6-171  
Water Pollution Control . . . . . 6-172  
Water Desalination . . . . . 6-173

### 6.11 LUBRICANTS AND LUBRICATION by Julian H. Dancy

Lubricants . . . . . 6-177  
Liquid Lubricants . . . . . 6-177  
Lubrication Regimes . . . . . 6-178  
Lubricant Testing . . . . . 6-178  
Viscosity Tests . . . . . 6-178  
Other Physical and Chemical Tests . . . . . 6-179  
Greases . . . . . 6-180  
Solid Lubricants . . . . . 6-181  
Lubrication Systems . . . . . 6-181  
Lubrication of Specific Equipment . . . . . 6-181

### 6.12 PLASTICS Staff Contribution

General Overview of Plastics . . . . . 6-185  
Raw Materials . . . . . 6-201  
Primary Fabrication Process . . . . . 6-201  
Additives . . . . . 6-201  
Adhesives and Assembly . . . . . 6-202  
Recycling . . . . . 6-202

### 6.13 FIBER COMPOSITE MATERIALS by Stephen R. Swanson

Introduction . . . . . 6-202  
Typical Advanced Composites . . . . . 6-203  
Fibers . . . . . 6-203  
Matrices . . . . . 6-203  
Material Forms and Manufacturing . . . . . 6-204  
Design and Analysis . . . . . 6-204

## 6.1 GENERAL PROPERTIES OF MATERIALS

by Howard S. Bean

REFERENCES: "International Critical Tables," McGraw-Hill. "Smithsonian Physical Tables," Smithsonian Institution. Landolt, "Landolt-Börnstein, Zahlenwerte und Funktionen aus Physik, Chemie, Astronomie, Geophysik und Technik," Springer. "Handbook of Chemistry and Physics," Chemical Rubber Co. "Book of ASTM Standards," ASTM. "ASHRAE Refrigeration Data Book," ASHRAE. Brady, "Materials Handbook," McGraw-Hill. Mantell, "Engineering Materials Handbook," McGraw-Hill. International Union of Pure and Applied Chemistry, Butterworth Scientific Publications. "U.S. Standard Atmosphere," Government Printing Office. Tables of Thermodynamic Properties of Gases, *NIST Circ.* 564, ASME Steam Tables.

Thermodynamic properties of a variety of other specific materials are listed also in Secs. 4.1, 4.2, and 9.8. Sonic properties of several materials are listed in Sec. 12.6.

### CHEMISTRY

Every **elementary substance** is made up of exceedingly small particles called **atoms** which are all alike and which cannot be further subdivided or broken up by **chemical processes**. It will be noted that this statement is

virtually a definition of the term elementary substance and a limitation of the term chemical process. There are as many different classes or families of atoms as there are **chemical elements**. See Table 6.1.1.

Two or more atoms, either of the same kind or of different kinds, are, in the case of most elements, capable of uniting with one another to form a higher order of distinct particles called **molecules**. If the molecules or atoms of which any given material is composed are all exactly alike, the material is a **pure substance**. If they are not all alike, the material is a **mixture**.

If the atoms which compose the molecules of any pure substances are all of the same kind, the substance is, as already stated, an **elementary substance**. If the atoms which compose the molecules of a pure chemical substance are not all of the same kind, the substance is a **compound substance**. The atoms are to be considered as the smallest particles which occur separately in the structure of molecules of either compound or elementary substances, so far as can be determined by ordinary chemical analysis. The molecule of an element consists of a definite (usually small) number of its atoms. The molecule of a compound consists of one or more atoms of each of its several elements, the numbers of the

Table 6.1.1 Chemical Elements<sup>a</sup>

Element	Symbol	Atomic no.	Atomic weight <sup>b</sup>	Valence
Actinium	Ac	89		
Aluminum	Al	13	26.9815	3
Americium	Am	95		
Antimony	Sb	51	121.75	3, 5
Argon <sup>c</sup>	Ar	18	39.948	0
Arsenic <sup>d</sup>	As	33	74.9216	3, 5
Astatine	At	85		
Barium	Ba	56	137.34	2
Berkelium	Bk	97		
Beryllium	Be	4	9.0122	2
Bismuth	Bi	83	208.980	3, 5
Boron <sup>d</sup>	B	5	10.811 <sup>f</sup>	3
Bromine <sup>e</sup>	Br	35	79.904 <sup>m</sup>	1, 3, 5
Cadmium	Cd	48	112.40	2
Calcium	Ca	20	40.08	2
Californium	Cf	98		
Carbon <sup>d</sup>	C	6	12.01115 <sup>f</sup>	2, 4
Cerium	Ce	58	140.12	3, 4
Cesium <sup>k</sup>	Cs	55	132.905	1
Chlorine <sup>f</sup>	Cl	17	35.453 <sup>m</sup>	1, 3, 5, 7
Chromium	Cr	24	51.996 <sup>m</sup>	2, 3, 6
Cobalt	Co	27	58.9332	2, 3
Columbium (see Niobium)				
Copper	Cu	29	63.546 <sup>m</sup>	1, 2
Curium	Cm	96		
Dysprosium	Dy	66	162.50	3
Einsteinium	Es	99		
Erbium	Er	68	167.26	3
Europium	Eu	63	151.96	2, 3
Fermium	Fm	100		
Fluorine <sup>g</sup>	F	9	18.9984	1
Francium	Fr	87		
Gadolinium	Gd	64	157.25	3
Gallium <sup>k</sup>	Ga	31	69.72	2, 3
Germanium	Ge	32	72.59	2, 4
Gold	Au	79	196.967	1, 3
Hafnium	Hf	72	178.49	4
Helium <sup>c</sup>	He	2	4.0026	0
Holmium	Ho	67	164.930	3
Hydrogen <sup>h</sup>	H	1	1.00797 <sup>f</sup>	1
Indium	In	49	114.82	1, 2, 3
Iodine <sup>d</sup>	I	53	126.9044	1, 3, 5, 7

Table 6.1.1 Chemical Elements<sup>a</sup> (Continued)

Element	Symbol	Atomic no.	Atomic weight <sup>b</sup>	Valence
Iridium	Ir	77	192.2	2, 3, 4, 6
Iron	Fe	26	55.847 <sup>m</sup>	2, 3
Krypton <sup>c</sup>	Kr	36	83.80	0
Lanthanum	La	57	138.91	3
Lead	Pb	82	207.19	2, 4
Lithium <sup>f</sup>	Li	3	6.939	1
Lutetium	Lu	71	174.97	3
Magnesium	Mg	12	24.312	2
Manganese	Mn	25	54.9380	2, 3, 4, 6, 7
Mendelevium	Md	101		
Mercury <sup>e</sup>	Hg	80	200.59	1, 2
Molybdenum	Mo	42	95.94	3, 4, 5, 6
Neodymium	Nd	60	144.24	3
Neon <sup>c</sup>	Ne	10	20.183	0
Neptunium	Np	93		
Nickel	Ni	28	58.71	2, 3, 4
Niobium	Nb	41	92.906	2, 3, 4, 5
Nitrogen <sup>f</sup>	N	7	14.0067	3, 5
Nobelium	No	102		
Osmium	Os	76	190.2	2, 3, 4, 6, 8
Oxygen <sup>f</sup>	O	8	15.9994 <sup>f</sup>	2
Palladium	Pd	46	106.4	2, 4
Phosphorus <sup>d</sup>	P	15	30.9738	3, 5
Platinum	Pt	78	195.09	2, 4
Plutonium	Pu	94		
Polonium	Po	84		2, 4
Potassium	K	19	39.102	1
Praseodymium	Pr	59	140.907	3
Promethium	Pm	61		5
Protactinium	Pa	91		
Radium	Ra	88		2
Radon <sup>j</sup>	Rn	86		0
Rhenium	Re	75	186.2	1, 4, 7
Rhodium	Rh	45	102.905	3, 4
Rubidium	Rb	37	85.47	1
Ruthenium	Ru	44	101.07	3, 4, 6, 8
Samarium	Sm	62	150.35	3
Scandium	Sc	21	44.956	3
Selenium <sup>d</sup>	Se	34	78.96	2, 4, 6
Silicon <sup>d</sup>	Si	14	28.086 <sup>f</sup>	4
Silver	Ag	47	107.868 <sup>m</sup>	1
Sodium	Na	11	22.9898	1
Strontium	Sr	38	87.62	2
Sulfur <sup>d</sup>	S	16	32.064 <sup>f</sup>	2, 4, 6
Tantalum	Ta	73	180.948	4, 5
Technetium	Tc	43		
Tellurium <sup>d</sup>	Te	52	127.60	2, 4, 6
Terbium	Tb	65	158.924	3
Thallium	Tl	81	204.37	1, 3
Thorium	Th	90	232.038	3
Thulium	Tm	69	168.934	3
Tin	Sn	50	118.69	2, 4
Titanium	Ti	22	47.90	3, 4
Tungsten	W	74	183.85	3, 4, 5, 6
Uranium	U	92	238.03	4, 6
Vanadium	V	23	50.942	1, 2, 3, 4, 5
Xenon <sup>c</sup>	Xe	54	131.30	0
Ytterbium	Yb	70	173.04	2, 3
Yttrium	Y	39	88.905	3
Zinc	Zn	30	65.37	2
Zirconium	Zr	40	91.22	4

<sup>a</sup> All the elements for which atomic weights listed are metals, except as otherwise indicated. No atomic weights are listed for most radioactive elements, as these elements have no fixed value.

<sup>b</sup> The atomic weights are based upon nuclidic mass of C<sup>12</sup> = 12.

<sup>c</sup> Inert gas. <sup>d</sup> Metalloid. <sup>e</sup> Liquid. <sup>f</sup> Gas. <sup>g</sup> Most active gas. <sup>h</sup> Lightest gas. <sup>i</sup> Lightest metal. <sup>j</sup> Not placed. <sup>k</sup> Liquid at 25°C.

<sup>l</sup> The atomic weight varies because of natural variations in the isotopic composition of the element. The observed ranges are boron, ± 0.003; carbon, ± 0.00005; hydrogen, ± 0.00001; oxygen, ± 0.0001; silicon, ± 0.001; sulfur, ± 0.003.

<sup>m</sup> The atomic weight is believed to have an experimental uncertainty of the following magnitude: bromine, ± 0.001; chlorine, ± 0.001; chromium, ± 0.001; copper, ± 0.001; iron, ± 0.003; silver, ± 0.001. For other elements, the last digit given is believed to be reliable to ± 0.5.

SOURCE: Table courtesy IUPAC and Butterworth Scientific Publications.

various kinds of atoms and their arrangement being definite and fixed and determining the character of the compound. This notion of molecules and their constituent atoms is useful for interpreting the observed fact that chemical reactions—e.g., the analysis of a compound into its elements, the synthesis of a compound from the elements, or the changing of one or more compounds into one or more different compounds—take place so that the masses of the various substances concerned in a given reaction stand in definite and fixed ratios.

It appears from recent researches that some substances which cannot by any available means be decomposed into simpler substances and which must, therefore, be defined as elements, are continually undergoing spontaneous changes or **radioactive transformation** into other substances which can be recognized as physically and chemically different from the original substance. Radium is an element by the definition given and may be considered as made up of atoms. But it is assumed that these atoms, so called because they resist all efforts to break them up and are, therefore, apparently indivisible, nevertheless split up spontaneously, at a rate which scientists have not been able to influence in any way, into other atoms, thus forming other elementary substances of totally different properties. See Table 6.1.3.

The view generally accepted at present is that the atoms of all the

chemical elements, including those not yet known to be radioactive, consist of several kinds of still smaller particles, three of which are known as **protons**, **neutrons**, and **electrons**. The protons are bound together in the atomic nucleus with other particles, including neutrons, and are positively charged. The neutrons are particles having approximately the mass of a proton but are uncharged. The electrons are negatively charged particles, all alike, external to the nucleus, and sufficient in number to neutralize the nuclear charge in an atom. The differences between the atoms of different chemical elements are due to the different numbers of these smaller particles composing them. According to the original Bohr theory, an ordinary atom is conceived as a stable system of such electrons revolving in closed orbits about the nucleus like the planets of the solar system around the sun. In a hydrogen atom, there is 1 proton and 1 electron; in a radium atom, there are 88 electrons surrounding a nucleus 226 times as massive as the hydrogen nucleus. Only a few, in general the outermost or valence electrons of such an atom, are subject to rearrangement within, or ejection from, the atom, thereby enabling it, because of its increased energy, to combine with other atoms to form molecules of either elementary substances or compounds. The **atomic number** of an element is the number of excess positive charges on the nucleus of the atom. The essential feature that dis-

**Table 6.1.2 Solubility of Inorganic Substances in Water**

(Number of grams of the anhydrous substance soluble in 1,000 g of water. The common name of the substance is given in parentheses)

Substance	Composition	Temperature, °F (°C)		
		32 (0)	122 (50)	212 (100)
Aluminum sulfate	Al <sub>2</sub> (SO <sub>4</sub> ) <sub>3</sub>	313	521	891
Aluminum potassium sulfate (potassium alum)	Al <sub>2</sub> K <sub>2</sub> (SO <sub>4</sub> ) <sub>4</sub> · 24H <sub>2</sub> O	30	170	1,540
Ammonium bicarbonate	NH <sub>4</sub> HCO <sub>3</sub>	119		
Ammonium chloride (sal ammoniac)	NH <sub>4</sub> Cl	297	504	760
Ammonium nitrate	NH <sub>4</sub> NO <sub>3</sub>	1,183	3,440	8,710
Ammonium sulfate	(NH <sub>4</sub> ) <sub>2</sub> SO <sub>4</sub>	706	847	1,033
Barium chloride	BaCl <sub>2</sub> · 2H <sub>2</sub> O	317	436	587
Barium nitrate	Ba(NO <sub>3</sub> ) <sub>2</sub>	50	172	345
Calcium carbonate (calcite)	CaCO <sub>3</sub>	0.018*		0.88
Calcium chloride	CaCl <sub>2</sub>	594		1,576
Calcium hydroxide (hydrated lime)	Ca(OH) <sub>2</sub>	1.77		0.67
Calcium nitrate	Ca(NO <sub>3</sub> ) <sub>2</sub> · 4H <sub>2</sub> O	931	3,561	3,626
Calcium sulfate (gypsum)	CaSO <sub>4</sub> · 2H <sub>2</sub> O	1.76	2.06	1.69
Copper sulfate (blue vitriol)	CuSO <sub>4</sub> · 5H <sub>2</sub> O	140	334	753
Ferrous chloride	FeCl <sub>2</sub> · 4H <sub>2</sub> O	644 <sup>§</sup>	820	1,060
Ferrous hydroxide	Fe(OH) <sub>2</sub>	0.0067 <sup>‡</sup>		
Ferrous sulfate (green vitriol or copperas)	FeSO <sub>4</sub> · 7H <sub>2</sub> O	156	482	
Ferric chloride	FeCl <sub>3</sub>	730	3,160	5,369
Lead chloride	PbCl <sub>2</sub>	6.73	16.7	33.3
Lead nitrate	Pb(NO <sub>3</sub> ) <sub>2</sub>	403		1,255
Lead sulfate	PbSO <sub>4</sub>	0.042 <sup>†</sup>		
Magnesium carbonate	MgCO <sub>3</sub>	0.13 <sup>‡</sup>		
Magnesium chloride	MgCl <sub>2</sub> · 6H <sub>2</sub> O	524		723
Magnesium hydroxide (milk of magnesia)	Mg(OH) <sub>2</sub>	0.009 <sup>‡</sup>		
Magnesium nitrate	Mg(NO <sub>3</sub> ) <sub>2</sub> · 6H <sub>2</sub> O	665	903	
Magnesium sulfate (Epsom salts)	MgSO <sub>4</sub> · 7H <sub>2</sub> O	269	500	710
Potassium carbonate (potash)	K <sub>2</sub> CO <sub>3</sub>	893	1,216	1,562
Potassium chloride	KCl	284	435	566
Potassium hydroxide (caustic potash)	KOH	971	1,414	1,773
Potassium nitrate (saltpeter or niter)	KNO <sub>3</sub>	131	851	2,477
Potassium sulfate	K <sub>2</sub> SO <sub>4</sub>	74	165	241
Sodium bicarbonate (baking soda)	NaHCO <sub>3</sub>	69	145	
Sodium carbonate (sal soda or soda ash)	NaCO <sub>3</sub> · 10H <sub>2</sub> O	204	475	452
Sodium chloride (common salt)	NaCl	357	366	392
Sodium hydroxide (caustic soda)	NaOH	420	1,448	3,388
Sodium nitrate (Chile saltpeter)	NaNO <sub>3</sub>	733	1,148	1,755
Sodium sulfate (Glauber salts)	Na <sub>2</sub> SO <sub>4</sub> · 10H <sub>2</sub> O	49	466	422
Zinc chloride	ZnCl <sub>2</sub>	2,044	4,702	6,147
Zinc nitrate	Zn(NO <sub>3</sub> ) <sub>2</sub> · 6H <sub>2</sub> O	947		
Zinc sulfate	ZnSO <sub>4</sub> · 7H <sub>2</sub> O	419	768	807

\* 59°F.

† 68°F.

‡ In cold water.

§ 50°F.

Table 6.1.3 Periodic Table of the Elements

<div style="display: flex; align-items: center;"> <div style="margin-right: 10px;"> <p>Atomic Number → <input type="text"/></p> <p>Symbol → <input type="text"/></p> <p>Valence → <input type="text"/></p> </div> <div style="margin-right: 10px;"> <p>← Element</p> </div> <div style="margin-right: 10px;"> <p>← Atomic weight based on C<sup>12</sup> = 12.00 ( ) denotes mass number of most stable known isotope</p> </div> </div>																Nonmetallic elements										Inert gases			
Light metals										Nonmetallic elements										1 Hydrogen H 1.00797 1	2 Helium He 4.0026 0								
3 Lithium Li 6.939 1			4 Beryllium Be 9.0122 2													5 Boron B 10.811 3	6 Carbon C 12.01115 2,4	7 Nitrogen N 14.0067 3,5	8 Oxygen O 15.9994 2	9 Fluorine F 18.9984 1	10 Neon Ne 20.183 0								
11 Sodium Na 22.9898 1		12 Magnesium Mg 24.312 2		Brittle metals										Ductile metals										13 Aluminum Al 26.9815 3	14 Silicon Si 28.086 4	15 Phosphorus P 30.9738 3,5	16 Sulphur S 32.064 2,4,6	17 Chlorine Cl 35.453 1,3,5,7	18 Argon Ar 39.948 0
19 Potassium K 39.102 1	20 Calcium Ca 40.08 2	21 Scandium Sc 44.956 3	22 Titanium Ti 47.90 3,4	23 Vanadium V 50.942 1,2,3,4,5	24 Chromium Cr 51.996 2,3,6	25 Manganese Mn 54.938 2,3,4,6,7	26 Iron Fe 55.847 2,3	27 Cobalt Co 58.9332 2,3	28 Nickel Ni 58.71 2,3,4	29 Copper Cu 63.546 1,2	30 Zinc Zn 65.37 2	31 Gallium Ga 69.72 2,3	32 Germanium Ge 72.59 2,4	33 Arsenic As 74.9216 3,5	34 Selenium Se 78.96 2,4,6	35 Bromine Br 79.904 1,3,5	36 Krypton Kr 83.80 0												
37 Rubidium Rd 85.47 1	38 Strontium Sr 87.62 2	39 Yttrium Y 88.905 3	40 Zirconium Zr 91.22 4	41 Niobium Nb 92.906 2,3,4,5	42 Molybdenum Mo 95.94 3,4,5,6	43 Technetium Tc (99)	44 Ruthenium Ru 101.07 3,4,6,8	45 Rhodium Rh 103.905 3,4	46 Palladium Pd 106.4 2,4	47 Silver Ag 107.868 1	48 Cadmium Cd 112.40 2	49 Indium In 114.82 1,2,3	50 Tin Sn 118.69 2,4	51 Antimony Sb 121.75 3,5	52 Tellurium Te 127.60 2,4,6	53 Iodine I 126.9044 1,3,5,7	54 Xenon Xe 131.30 0												
55 Cesium Cs 132.905 1	56 Barium Ba 137.34 2	LANTHANIDE SERIES										Rare earth elements										67 Holmium Ho 164.93 3	68 Erdium Er 167.26 3	69 Thulium Tm 168.934 3	70 Ytterbium Yb 173.04 2,3	71 Lutetium Lu 174.97 3			
		57 Lanthanum La 137.91 3	58 Cerium Ce 140.12 3,4	59 Praseodymium Pr 140.907 3	60 Neodymium Nd 144.24 3	61 Promethium Pm (147) 5	62 Samarium Sm 150.35 3	63 Europium Eu 151.96 2,3	64 Gadolinium Gd 157.25 3	65 Terbium Tb 158.924 3	66 Dysprosium Dy 162.50 3	67 Holmium Ho 164.93 3	68 Erdium Er 167.26 3	69 Thulium Tm 168.934 3	70 Ytterbium Yb 173.04 2,3	71 Lutetium Lu 174.97 3													
		72 Hafnium Hf 178.49 4	73 Tantalum Ta 180.948 4,5	74 Tungsten W 183.85 3,4,5,6	75 Rhenium Re 186.2 1,4,7	76 Osmium Os 190.2 2,3,4,6,8	77 Iridium Ir 192.2 2,3,4,6	78 Platinum Pt 195.09 2,4	79 Gold Au 196.967 1,3	80 Mercury Hg 200.59 1,2	81 Thallium Tl 204.37 1,3	82 Lead Pb 207.19 2,4	83 Bismuth Bi 208.98 3,5	84 Polonium Po (210) 2,4	85 Astatine At (210)	86 Radon Rn (212) 0													
87 Francium Fr (223)	88 Radium Ra (227) 2	ACTINIDE SERIES										Transuranium elements										97 Berkelium Bk (249)	98 Californium Cf (249)	99 Einsteinium Es (254)	100 Fermium Fm (252)	101 Mendelevium Md (256)	102 Nobelium No (254)	103 Lawrencium Lw (257)	
		89 Actinium Ac (227)	90 Thorium Th 232.038	91 Protactinium Pa (231)	92 Uranium U 238.03	93 Neptunium Np (237)	94 Plutonium Pu (242)	95 Americium Am (243)	96 Curium Cm (245)	97 Berkelium Bk (249)	98 Californium Cf (249)	99 Einsteinium Es (254)	100 Fermium Fm (252)	101 Mendelevium Md (256)	102 Nobelium No (254)	103 Lawrencium Lw (257)													

**Table 6.1.4 Solubility of Gases in Water**  
(By volume at atmospheric pressure)

	<i>t</i> , °F (°C)				<i>t</i> , °F (°C)		
	32 (0)	68 (20)	212 (100)		32 (0)	68 (20)	212 (100)
Air	0.032	0.020	0.012	Hydrogen	0.023	0.020	0.018
Acetylene	1.89	1.12		Hydrogen sulfide	5.0	2.8	0.87
Ammonia	1,250	700		Hydrochloric acid	560	480	
Carbon dioxide	1.87	0.96	0.26	Nitrogen	0.026	0.017	0.0105
Carbon monoxide	0.039	0.025		Oxygen	0.053	0.034	0.185
Chlorine	5.0	2.5	0.00	Sulfuric acid	87	43	

tinguishes one element from another is this charge of the nucleus. It also determines the position of the element in the periodic table. Modern researches have shown the existence of **isotopes**, that is, two or more species of atoms having the same atomic number and thus occupying the same place in the periodic system, but differing somewhat in atomic weight. These isotopes are chemically identical and are merely different species of the same chemical element. Most of the ordinary inactive elements have been shown to consist of a mixture of isotopes. This convenient atomic model should be regarded as only a working hypothesis for coordinating a number of phenomena about which much yet remains to be known.

**Calculation of the Percentage Composition of Substances** Add the atomic weights of the elements in the compound to obtain its molecular weight. Multiply the atomic weight of the element to be calculated by the number of atoms present (indicated in the formula by a subscript number) and by 100, and divide by the molecular weight of the compound. For example, hematite iron ore (Fe<sub>2</sub>O<sub>3</sub>) contains 69.94 percent of iron by weight, determined as follows: Molecular weight of Fe<sub>2</sub>O<sub>3</sub> = (55.84 × 2) + (16 × 3) = 159.68. Percentage of iron in compound = (55.84 × 2) × 100/159.68 = 69.94.

**SPECIFIC GRAVITIES AND DENSITIES**

**Table 6.1.5 Approximate Specific Gravities and Densities**  
(Water at 39°F and normal atmospheric pressure taken as unity) For more detailed data on any material, see the section dealing with the properties of that material. Data given are for usual room temperatures.

Substance	Specific gravity	Avg density	
		lb/ft <sup>3</sup>	kg/m <sup>3</sup>
<b>Metals, Alloys, Ores*</b>			
Aluminum, cast-hammered	2.55–2.80	165	2,643
Brass, cast-rolled	8.4–8.7	534	8,553
Bronze, aluminum	7.7	481	7,702
Bronze, 7.9–14% Sn	7.4–8.9	509	8,153
Bronze, phosphor	8.88	554	8,874
Copper, cast-rolled	8.8–8.95	556	8,906
Copper ore, pyrites	4.1–4.3	262	4,197
German silver	8.58	536	8,586
Gold, cast-hammered	19.25–19.35	1,205	19,300
Gold coin (U.S.)	17.18–17.2	1,073	17,190
Iridium	21.78–22.42	1,383	22,160
Iron, gray cast	7.03–7.13	442	7,079
Iron, cast, pig	7.2	450	7,207
Iron, wrought	7.6–7.9	485	7,658
Iron, spiegeleisen	7.5	468	7,496
Iron, ferrosilicon	6.7–7.3	437	6,984
Iron ore, hematite	5.2	325	5,206
Iron ore, limonite	3.6–4.0	237	3,796
Iron ore, magnetite	4.9–5.2	315	5,046
Iron slag	2.5–3.0	172	2,755
Lead	11.34	710	11,370
Lead ore, galena	7.3–7.6	465	7,449
Manganese	7.42	475	7,608
Manganese ore, pyrolusite	3.7–4.6	259	4,149
Mercury	13.546	847	13,570
Monel metal, rolled	8.97	555	8,688
Nickel	8.9	537	8,602

**Table 6.1.5 Approximate Specific Gravities and Densities (Continued)**

Substance	Specific gravity	Avg density	
		lb/ft <sup>3</sup>	kg/m <sup>3</sup>
Platinum, cast-hammered	21.5	1,330	21,300
Silver, cast-hammered	10.4–10.6	656	10,510
Steel, cold-drawn	7.83	489	7,832
Steel, machine	7.80	487	7,800
Steel, tool	7.70–7.73	481	7,703
Tin, cast-hammered	7.2–7.5	459	7,352
Tin ore, cassiterite	6.4–7.0	418	6,695
Tungsten	19.22	1,200	18,820
Uranium	18.7	1,170	18,740
Zinc, cast-rolled	6.9–7.2	440	7,049
Zinc, ore, blende	3.9–4.2	253	4,052
<b>Various Solids</b>			
Cereals, oats, bulk	0.41	26	417
Cereals, barley, bulk	0.62	39	625
Cereals, corn, rye, bulk	0.73	45	721
Cereals, wheat, bulk	0.77	48	769
Cork	0.22–0.26	15	240
Cotton, flax, hemp	1.47–1.50	93	1,491
Fats	0.90–0.97	58	925
Flour, loose	0.40–0.50	28	448
Flour, pressed	0.70–0.80	47	753
Glass, common	2.40–2.80	162	2,595
Glass, plate or crown	2.45–2.72	161	2,580
Glass, crystal	2.90–3.00	184	1,950
Glass, flint	3.2–4.7	247	3,960
Hay and straw, bales	0.32	20	320
Leather	0.86–1.02	59	945
Paper	0.70–1.15	58	929
Plastics (see Sec. 6.12)			
Potatoes, piled	0.67	44	705
Rubber, caoutchouc	0.92–0.96	59	946
Rubber goods	1.0–2.0	94	1,506
Salt, granulated, piled	0.77	48	769
Salt peter	2.11	132	2,115
Starch	1.53	96	1,539
Sulfur	1.93–2.07	125	2,001
Wool	1.32	82	1,315
<b>Timber, Air-Dry</b>			
Apple	0.66–0.74	44	705
Ash, black	0.55	34	545
Ash, white	0.64–0.71	42	973
Birch, sweet, yellow	0.71–0.72	44	705
Cedar, white, red	0.35	22	352
Cherry, wild red	0.43	27	433
Chestnut	0.48	30	481
Cypress	0.45–0.48	29	465
Fir, Douglas	0.48–0.55	32	513
Fir, balsam	0.40	25	401
Elm, white	0.56	35	561
Hemlock	0.45–0.50	29	465
Hickory	0.74–0.80	48	769
Locust	0.67–0.77	45	722
Mahogany	0.56–0.85	44	705
Maple, sugar	0.68	43	689
Maple, white	0.53	33	529
Oak, chestnut	0.74	46	737
Oak, live	0.87	54	866

Table 6.1.5 Approximate Specific Gravities and Densities (Continued)

Substance	Specific gravity	Avg density	
		lb/ft <sup>3</sup>	kg/m <sup>3</sup>
Oak, red, black	0.64–0.71	42	673
Oak, white	0.77	48	770
Pine, Oregon	0.51	32	513
Pine, red	0.48	30	481
Pine, white	0.43	27	433
Pine, Southern	0.61–0.67	38–42	610–673
Pine, Norway	0.55	34	541
Poplar	0.43	27	433
Redwood, California	0.42	26	417
Spruce, white, red	0.45	28	449
Teak, African	0.99	62	994
Teak, Indian	0.66–0.88	48	769
Walnut, black	0.59	37	593
Willow	0.42–0.50	28	449
<b>Various Liquids</b>			
Alcohol, ethyl (100%)	0.789	49	802
Alcohol, methyl (100%)	0.796	50	809
Acid, muriatic, 40%	1.20	75	1,201
Acid, nitric, 91%	1.50	94	1,506
Acid, sulfuric, 87%	1.80	112	1,795
Chloroform	1.500	95	1,532
Ether	0.736	46	738
Lye, soda, 66%	1.70	106	1,699
Oils, vegetable	0.91–0.94	58	930
Oils, mineral, lubricants	0.88–0.94	57	914
Turpentine	0.861–0.867	54	866
<b>Water</b>			
Water, 4°C, max density	1.0	62.426	999.97
Water, 100°C	0.9584	59.812	958.10
Water, ice	0.88–0.92	56	897
Water, snow, fresh fallen	0.125	8	128
Water, seawater	1.02–1.03	64	1,025
<b>Gases (see Sec. 4)</b>			
<b>Ashlar Masonry</b>			
Granite, syenite, gneiss	2.4–2.7	159	2,549
Limestone	2.1–2.8	153	2,450
Marble	2.4–2.8	162	2,597
Sandstone	2.0–2.6	143	2,290
Bluestone	2.3–2.6	153	2,451
<b>Rubble Masonry</b>			
Granite, syenite, gneiss	2.3–2.6	153	2,451
Limestone	2.0–2.7	147	2,355
Sandstone	1.9–2.5	137	2,194
Bluestone	2.2–2.5	147	2,355
Marble	2.3–2.7	156	2,500
<b>Dry Rubble Masonry</b>			
Granite, syenite, gneiss	1.9–2.3	130	2,082
Limestone, marble	1.9–2.1	125	2,001
Sandstone, bluestone	1.8–1.9	110	1,762
<b>Brick Masonry</b>			
Hard brick	1.8–2.3	128	2,051
Medium brick	1.6–2.0	112	1,794
Soft brick	1.4–1.9	103	1,650
Sand-lime brick	1.4–2.2	112	1,794
<b>Concrete Masonry</b>			
Cement, stone, sand	2.2–2.4	144	2,309
Cement, slag, etc.	1.9–2.3	130	2,082
Cement, cinder, etc.	1.5–1.7	100	1,602
<b>Various Building Materials</b>			
Ashes, cinders	0.64–0.72	40–45	640–721
Cement, portland, loose	1.5	94	1,505
Portland cement	3.1–3.2	196	3,140
Lime, gypsum, loose	0.85–1.00	53–64	849–1,025
Mortar, lime, set	1.4–1.9	103	1,650
		94	1,505
Mortar, portland cement	2.08–2.25	135	2,163
Slags, bank slag	1.1–1.2	67–72	1,074–1,153
Slags, bank screenings	1.5–1.9	98–117	1,570–1,874
Slags, machine slag	1.5	96	1,538
Slags, slag sand	0.8–0.9	49–55	785–849

Table 6.1.5 Approximate Specific Gravities and Densities (Continued)

Substance	Specific gravity	Avg density	
		lb/ft <sup>3</sup>	kg/m <sup>3</sup>
<b>Earth, etc., Excavated</b>			
Clay, dry	1.0	63	1,009
Clay, damp, plastic	1.76	110	1,761
Clay and gravel, dry	1.6	100	1,602
Earth, dry, loose	1.2	76	1,217
Earth, dry, packed	1.5	95	1,521
Earth, moist, loose	1.3	78	1,250
Earth, moist, packed	1.6	96	1,538
Earth, mud, flowing	1.7	108	1,730
Earth, mud, packed	1.8	115	1,841
Riprap, limestone	1.3–1.4	80–85	1,282–1,361
Riprap, sandstone	1.4	90	1,441
Riprap, shale	1.7	105	1,681
Sand, gravel, dry, loose	1.4–1.7	90–105	1,441–1,681
Sand, gravel, dry, packed	1.6–1.9	100–120	1,602–1,922
Sand, gravel, wet	1.89–2.16	126	2,019
<b>Excavations in Water</b>			
Sand or gravel	0.96	60	951
Sand or gravel and clay	1.00	65	1,041
Clay	1.28	80	1,281
River mud	1.44	90	1,432
Soil	1.12	70	1,122
Stone riprap	1.00	65	1,041
<b>Minerals</b>			
Asbestos	2.1–2.8	153	2,451
Barytes	4.50	281	4,504
Basalt	2.7–3.2	184	2,950
Bauxite	2.55	159	2,549
Bluestone	2.5–2.6	159	2,549
Borax	1.7–1.8	109	1,746
Chalk	1.8–2.8	143	2,291
Clay, marl	1.8–2.6	137	2,196
Dolomite	2.9	181	2,901
Feldspar, orthoclase	2.5–2.7	162	2,596
Gneiss	2.7–2.9	175	2,805
Granite	2.6–2.7	165	2,644
Greenstone, trap	2.8–3.2	187	2,998
Gypsum, alabaster	2.3–2.8	159	2,549
Hornblende	3.0	187	2,998
Limestone	2.1–2.86	155	2,484
Marble	2.6–2.86	170	2,725
Magnesite	3.0	187	2,998
Phosphate rock, apatite	3.2	200	3,204
Porphyry	2.6–2.9	172	2,758
Pumice, natural	0.37–0.90	40	641
Quartz, flint	2.5–2.8	165	2,645
Sandstone	2.0–2.6	143	2,291
Serpentine	2.7–2.8	171	2,740
Shale, slate	2.6–2.9	172	2,758
Soapstone, talc	2.6–2.8	169	2,709
Syenite	2.6–2.7	165	2,645
<b>Stone, Quarried, Piled</b>			
Basalt, granite, gneiss	1.5	96	1,579
Limestone, marble, quartz	1.5	95	1,572
Sandstone	1.3	82	1,314
Shale	1.5	92	1,474
Greenstone, hornblend	1.7	107	1,715
<b>Bituminous Substances</b>			
Asphaltum	1.1–1.5	81	1,298
Coal, anthracite	1.4–1.8	97	1,554
Coal, bituminous	1.2–1.5	84	1,346
Coal, lignite	1.1–1.4	78	1,250
Coal, peat, turf, dry	0.65–0.85	47	753
Coal, charcoal, pine	0.28–0.44	23	369
Coal, charcoal, oak	0.47–0.57	33	481
Coal, coke	1.0–1.4	75	1,201
Graphite	1.64–2.7	135	2,163
Paraffin	0.87–0.91	56	898
Petroleum	0.87	54	856



**Table 6.1.5 Approximate Specific Gravities and Densities (Continued)**

Substance	Specific gravity	Avg density	
		lb/ft <sup>3</sup>	kg/m <sup>3</sup>
Petroleum, refined (kerosene)	0.78–0.82	50	801
Petroleum, benzine	0.73–0.75	46	737
Petroleum, gasoline	0.70–0.75	45	721
Pitch	1.07–1.15	69	1,105
Tar, bituminous	1.20	75	1,201
<b>Coal and Coke, Piled</b>			
Coal, anthracite	0.75–0.93	47–58	753–930
Coal, bituminous, lignite	0.64–0.87	40–54	641–866
Coal, peat, turf	0.32–0.42	20–26	320–417
Coal, charcoal	0.16–0.23	10–14	160–224
Coal, coke	0.37–0.51	23–32	369–513

\* See also Sec. 6.4.

**Compressibility of Liquids**

If  $v_1$  and  $v_2$  are the volumes of the liquids at pressures of  $p_1$  and  $p_2$  atm, respectively, at any temperature, the coefficient of compressibility  $b$  is given by the equation

$$b = \frac{1}{v_1} \frac{v_1 - v_2}{p_2 - p_1}$$

The value of  $b \times 10^6$  for oils at low pressures at about 70°F varies from about 55 to 80; for mercury at 32°F, it is 3.9; for chloroform at 32°F, it is 100 and increases with the temperature to 200 at 140°F; for ethyl alcohol, it increases from about 100 at 32°F and low pressures to 125 at 104°F; for glycerin, it is about 24 at room temperature and low pressure.

**Table 6.1.6 Specific Gravity and Density of Water at Atmospheric Pressure\***  
(Weights are in vacuo)

Temp, °C	Specific gravity	Density		Temp, °C	Specific gravity	Density	
		lb/ft <sup>3</sup>	kg/m <sup>3</sup>			lb/ft <sup>3</sup>	kg/m <sup>3</sup>
0	0.99987	62.4183	999.845	40	0.99224	61.9428	992.228
2	0.99997	62.4246	999.946	42	0.99147	61.894	991.447
4	1.00000	62.4266	999.955	44	0.99066	61.844	990.647
6	0.99997	62.4246	999.946	46	0.98982	61.791	989.797
8	0.99988	62.4189	999.854	48	0.98896	61.737	988.931
10	0.99973	62.4096	999.706	50	0.98807	61.682	988.050
12	0.99952	62.3969	999.502	52	0.98715	61.624	987.121
14	0.99927	62.3811	999.272	54	0.98621	61.566	986.192
16	0.99897	62.3623	998.948	56	0.98524	61.505	985.215
18	0.99862	62.3407	998.602	58	0.98425	61.443	984.222
20	0.99823	62.3164	998.213	60	0.98324	61.380	983.213
22	0.99780	62.2894	997.780	62	0.98220	61.315	982.172
24	0.99732	62.2598	997.304	64	0.98113	61.249	981.113
26	0.99681	62.2278	996.793	66	0.98005	61.181	980.025
28	0.99626	62.1934	996.242	68	0.97894	61.112	978.920
30	0.99567	62.1568	995.656	70	0.97781	61.041	977.783
32	0.99505	62.1179	995.033	72	0.97666	60.970	976.645
34	0.99440	62.0770	994.378	74	0.97548	60.896	975.460
36	0.99371	62.0341	993.691	76	0.97428	60.821	974.259
38	0.99299	61.9893	992.973	78	0.97307	60.745	973.041

\* See also Secs. 4.2 and 6.10.

## OTHER PHYSICAL DATA

**Table 6.1.7 Average Composition of Dry Air between Sea Level and 90-km (295,000-ft) Altitude**

Element	Formula	% by Vol.	% by Mass	Molecular weight
Nitrogen	N <sub>2</sub>	78.084	75.55	28.0134
Oxygen	O <sub>2</sub>	20.948	23.15	31.9988
Argon	Ar	0.934	1.325	39.948
Carbon Dioxide	CO <sub>2</sub>	0.0314	0.0477	44.00995
Neon	Ne	0.00182	0.00127	20.183
Helium	He	0.00052	0.000072	4.0026
Krypton	Kr	0.000114	0.000409	83.80
Methane	CH <sub>4</sub>	0.0002	0.000111	16.043

From 0.0 to 0.00005 percent by volume of nine other gases.

Average composite molecular weight of air 28.9644.

SOURCE: "U.S. Standard Atmosphere," Government Printing Office.

**Table 6.1.8 Volume of Water as a Function of Pressure and Temperature**

Temp, °F (°C)	Pressure, atm								
	0	500	1,000	2,000	3,000	4,000	5,000	6,500	8,000
32 (0)	1.0000	0.9769	0.9566	0.9223	0.8954	0.8739	0.8565	0.8361	
68 (20)	1.0016	0.9804	0.9619	0.9312	0.9065	0.8855	0.8675	0.8444	0.8244
122 (50)	1.0128	0.9915	0.9732	0.9428	0.9183	0.8974	0.8792	0.8562	0.8369
176 (80)	1.0287	1.0071	0.9884	0.9568	0.9315	0.9097	0.8913	0.8679	0.8481

SOURCE: "International Critical Tables."

**Table 6.1.9 Basic Properties of Several Metals**  
(Staff contribution)\*

Material	Density, † g/cm <sup>3</sup>	Coefficient of linear thermal expansion, ‡ in/(in · °F) × 10 <sup>-6</sup>	Thermal conductivity, Btu/(h · ft · °F)	Specific heat, § Btu/(lb · °F)	Approx melting temp, °F	Modulus of elasticity, lb/in <sup>2</sup> × 10 <sup>6</sup>	Poisson's ratio	Yield stress, lb/in <sup>2</sup> × 10 <sup>3</sup>	Ultimate stress, lb/in <sup>2</sup> × 10 <sup>3</sup>	Elongation, %
Aluminum 2024-T3	2.77	12.6	110	0.23	940	10.6	0.33	50	70	18
Aluminum 6061-T6	2.70	13.5	90	0.23	1,080	10.6	0.33	40	45	17
Aluminum 7079-T6	2.74	13.7	70	0.23	900	10.4	0.33	68	78	14
Beryllium, QMV	1.85	6.4–10.2	85	0.45	2,340	40–44	0.024–0.030	27–38	33–51	1–3.5
Copper, pure	8.90	9.2	227	0.092	1,980	17.0	0.32		See "Metals Handbook"	
Gold, pure	19.32		172	0.031	1,950	10.8	0.42		18	30
Lead, pure	11.34	29.3	21.4	0.031	620	2.0	0.40–0.45	1.3	2.6	20–50
Magnesium AZ31B-H24 (sheet)	1.77	14.5	55	0.25	1,100	6.5	0.35	22	37	15
Magnesium HK31A-H24	1.79	14.0	66	0.13	1,100	6.4	0.35	29	37	8
Molybdenum, wrought	10.3	3.0	83	0.07	4,730	40.0	0.32	80	120–200	Small
Nickel, pure	8.9	7.2	53	0.11	2,650	32.0	0.31§		See "Metals Handbook"	
Platinum	21.45	5.0	40	0.031	3,217	21.3	0.39		20–24	35–40
Plutonium, alpha phase	19.0–19.7	30.0	4.8	0.034	1,184	14.0	0.15–0.21	40	60	Small
Silver, pure	10.5	11.0	241	0.056	1,760	10–11	0.37	8	18	48
Steel, AISI C1020 (hot-worked)	7.85	6.3	27	0.10	2,750	29–30	0.29	48	65	36
Steel, AISI 304 (sheet)	8.03	9.9	9.4	0.12	2,600	28	0.29	39	87	65
Tantalum	16.6	3.6	31	0.03	5,425	27.0	0.35		50–145	1–40
Thorium, induction melt	11.6	6.95	21.7	0.03	3,200	7–10	0.27	21	32	34
Titanium, B 120VCA (aged)	4.85	5.2	4.3	0.13	3,100	14.8	0.3	190	200	9
Tungsten	19.3	2.5	95	0.033	6,200	50	0.28		18–600	1–3
Uranium D-38	18.97	4.0–8.0	17	0.028	2,100	24	0.21	28	56	4

Room-temperature properties are given. For further information, consult the "Metals Handbook" or a manufacturer's publication.

\* Compiled by Anders Lundberg, University of California, and reproduced by permission.

† To obtain the preferred density units, kg/m<sup>3</sup>, multiply these values by 1,000.

‡ See also Tables 6.1.10 and 6.1.11.

§ At 25°C.

**Table 6.1.10 Coefficient of Linear Thermal Expansion for Various Materials**[Mean values between 32 and 212°F except as noted; in/(in · °F) × 10<sup>-4</sup>]

<b>Metals</b>		<b>Other Materials</b>		<b>Paraffin:</b>	
Aluminum bronze	0.094	Bakelite, bleached	0.122	32–61°F	0.592
Brass, cast	0.104	Brick	0.053	61–100°F	0.724
Brass, wire	0.107	Carbon—coke	0.030	100–120°F	2.612
Bronze	0.100	Cement, neat	0.060	Porcelain	0.02
Constantan (60 Cu, 40 Ni)	0.095	Concrete	0.060	Quartz:	
German silver	0.102	Ebonite	0.468	Parallel to axis	0.044
Iron:		Glass:		Perpend. to axis	0.074
Cast	0.059	Thermometer	0.045	Quartz, fused	0.0028
Soft forged	0.063	Hard	0.033	Rubber	0.428
Wire	0.080	Plate and crown	0.050	Vulcanite	0.400
Magnalium (85 Al, 15 Mg)	0.133	Flint	0.044	Wood (   to fiber):	
Phosphor bronze	0.094	Pyrex	0.018	Ash	0.053
Solder	0.134	Granite	0.04–0.05	Chestnut and maple	0.036
Speculum metal	0.107	Graphite	0.044	Oak	0.027
Steel:		Gutta percha	0.875	Pine	0.030
Bessemer, rolled hard	0.056	Ice	0.283	Across the fiber:	
Bessemer, rolled soft	0.063	Limestone	0.023–0.05	Chestnut and pine	0.019
Nickel (10% Ni)	0.073	Marble	0.02–0.09	Maple	0.027
Type metal	0.108	Masonry	0.025–0.050	Oak	0.030

**Table 6.1.11 Specific Heat of Various Materials**

[Mean values between 32 and 212°F; Btu/(lb · °F)]

<b>Solids</b>		<b>Granite</b>		<b>Wood:</b>	
Alloys:		Graphite	0.195	Fir	0.65
Bismuth-tin	0.040–0.045	Gypsum	0.259	Oak	0.57
Bell metal	0.086	Hornblende	0.195	Pine	0.67
Brass, yellow	0.0883	Humus (soil)	0.44	<b>Liquids</b>	
Brass, red	0.090	Ice:		Acetic acid	0.51
Bronze	0.104	– 4°F	0.465	Acetone	0.544
Constantan	0.098	32°F	0.487	Alcohol (absolute)	0.58
German silver	0.095	India rubber (Para)	0.27–0.48	Aniline	0.49
Lipowits's metal	0.040	Kaolin	0.224	Bensol	0.40
Nickel steel	0.109	Limestone	0.217	Chloroform	0.23
Rose's metal	0.050	Marble	0.210	Ether	0.54
Solders (Pb and Sn)	0.040–0.045	Oxides:		Ethyl acetate	0.478
Type metal	0.0388	Alumina (Al <sub>2</sub> O <sub>3</sub> )	0.183	Ethylene glycol	0.602
Wood's metal	0.040	Cu <sub>2</sub> O	0.111	Fusel oil	0.56
40 Pb + 60 Bi	0.0317	Lead oxide (PbO)	0.055	Gasoline	0.50
25 Pb + 75 Bi	0.030	Lodestone	0.156	Glycerin	0.58
Asbestos	0.20	Magnesia	0.222	Hydrochloric acid	0.60
Ashes	0.20	Magnetite (Fe <sub>3</sub> O <sub>4</sub> )	0.168	Kerosene	0.50
Bakelite	0.3–0.4	Silica	0.191	Naphthalene	0.31
Basalt (lava)	0.20	Soda	0.231	Machine oil	0.40
Borax	0.229	Zinc oxide (ZnO)	0.125	Mercury	0.033
Brick	0.22	Paraffin wax	0.69	Olive oil	0.40
Carbon-coke	0.203	Porcelain	0.22	Paraffin oil	0.52
Chalk	0.215	Quartz	0.17–0.28	Petroleum	0.50
Charcoal	0.20	Quicklime	0.21	Sulfuric acid	0.336
Cinders	0.18	Malt, rock	0.21	Sea water	0.94
Coal	0.3	Sand	0.195	Toluene	0.40
Concrete	0.156	Sandstone	0.22	Turpentine	0.42
Cork	0.485	Serpentine	0.25	<b>Molten metals:</b>	
Corundum	0.198	Sulfur	0.180	Bismuth (535–725°F)	0.036
Dolomite	0.222	Talc	0.209	Lead (590–680°F)	0.041
Ebonite	0.33	Tufa	0.33	Sulfur (246–297°F)	0.235
Glass:		Vulcanite	0.331	Tin (460–660°F)	0.058
Normal	0.199				
Crown	0.16				
Flint	0.12				

## 6.2 IRON AND STEEL

by Harold W. Paxton

REFERENCES: "Metals Handbook," ASM International, 10th ed., ASTM Standards, pt. 1. SAE Handbook. "Steel Products Manual," AISI. "Making, Shaping and Treating of Steel," AISE, 10th ed.

### CLASSIFICATION OF IRON AND STEEL

Iron (Fe) is not a high-purity metal commercially but contains other chemical elements which have a large effect on its physical and mechanical properties. The amount and distribution of these elements are dependent upon the method of manufacture. The most important commercial forms of iron are listed below.

**Pig iron** is the product of the blast furnace and is made by the reduction of iron ore.

**Cast iron** is an alloy of iron containing enough carbon to have a low melting temperature and which can be cast to close to final shape. It is not generally capable of being deformed before entering service.

**Gray cast iron** is an iron which, as cast, has combined carbon (in the form of cementite,  $Fe_3C$ ) not in excess of a eutectoid percentage—the balance of the carbon occurring as graphite flakes. The term "gray iron" is derived from the characteristic gray fracture of this metal.

**White cast iron** contains carbon in the combined form. The presence of cementite or iron carbide ( $Fe_3C$ ) makes this metal hard and brittle, and the absence of graphite gives the fracture a white color.

**Malleable cast iron** is an alloy in which all the combined carbon in a special white cast iron has been changed to free or temper carbon by suitable heat treatment.

**Nodular (ductile) cast iron** is produced by adding alloys of magnesium or cerium to molten iron. These additions cause the graphite to form into small nodules, resulting in a higher-strength, ductile iron.

**Ingot iron, electrolytic iron (an iron-hydrogen alloy), and wrought iron** are terms for low-carbon materials which are no longer serious items of commerce but do have considerable historical interest.

**Steel** is an alloy predominantly of iron and carbon, usually containing measurable amounts of manganese, and often readily formable.

**Carbon steel** is steel that owes its distinctive properties chiefly to the carbon it contains.

**Alloy steel** is steel that owes its distinctive properties chiefly to some element or elements other than carbon, or jointly to such other elements and carbon. Some alloy steels necessarily contain an important percentage of carbon, even as much as 1.25 percent. There is no complete agreement about where to draw the line between the alloy steels and the carbon steels.

**Basic oxygen steel and electric-furnace steel** are steels made by the basic oxygen furnace and electric furnace processes, irrespective of carbon content; the effective individual alloy content in engineering steels can range from 0.05 percent up to 3 percent, with a total usually less than 5 percent. Open-hearth and Bessemer steelmaking are no longer practiced in the United States.

Iron ore is reduced in a blast furnace to form **pig iron**, which is the raw material for practically all iron and steel products. Formerly, nearly 90 percent of the iron ore used in the United States came from the Lake Superior district; the ore had the advantages of high quality and the cheapness with which it could be mined and transported by way of the Great Lakes. With the rise of global steelmaking and the availability of high-grade ores and pellets (made on a large scale from low-grade ores) from many sources, the choice of feedstock becomes an economic decision.

The modern **blast furnace** consists of a vertical shaft up to 10 m or 40 ft in diameter and over 30 m (100 ft) high containing a descending column of iron ore, coke, and limestone and a large volume of ascend-

ing hot gas. The gas is produced by the burning of coke in the hearth of the furnace and contains about 34 percent carbon monoxide. This gas reduces the iron ore to metallic iron, which melts and picks up considerable quantities of carbon, manganese, phosphorus, sulfur, and silicon. The **gangue** (mostly silica) of the iron ore and the ash in the coke combine with the limestone to form the blast-furnace slag. The pig iron and slag are drawn off at intervals from the hearth through the iron notch and cinder notch, respectively. Some of the larger blast furnaces produce around 10,000 tons of pig iron per day. The blast furnace produces a liquid product for one of three applications: (1) the huge majority passes to the steelmaking process for refining; (2) pig iron is used in foundries for making castings; and (3) ferroalloys, which contain a considerable percentage of another metallic element, are used as addition agents in steelmaking. Compositions of commercial pig irons and two ferroalloys (ferromanganese and ferrosilicon) are listed in Table 6.2.1.

**Physical Constants of Unalloyed Iron** Some physical properties of iron and even its dilute alloys are sensitive to small changes in composition, grain size, or degree of cold work. The following are reasonably accurate for "pure" iron at or near room temperature; those with an asterisk are sensitive to these variables perhaps by 10 percent or more. Those with a dagger (†) depend measurably on temperature; more extended tables should be consulted.

Specific gravity, 7.866; melting point, 1,536°C (2,797°F); heat of fusion 277 kJ/kg (119 Btu/lbm); thermal conductivity 80.2 W/(m · °C) [557 Btu/(h · ft<sup>2</sup> · in · °F)\*†; thermal coefficient of expansion  $12 \times 10^{-6}/^{\circ}C$  ( $6.7 \times 10^{-6}/^{\circ}F$ )†; electrical resistivity 9.7  $\mu\Omega \cdot cm$ \*†; and temperature coefficient of electrical resistance 0.0065/°C (0.0036/°F).†

**Mechanical Properties** Representative mechanical properties of annealed low-carbon steel (often similar to the former ingot iron) are as follows: yield strength 130 to 150 MPa (20 to 25 ksi); tensile strength 260 to 300 MPa (40 to 50 ksi); elongation 20 to 45 percent in 2 in; reduction in area of 60 to 75 percent; Brinell hardness 65 to 100. These figures are at best approximate and depend on composition (especially trace additives) and processing variables. For more precise data, suppliers or broader databases should be consulted.

Young's modulus for ingot iron is 202,000 MPa (29,300,000 lb/in<sup>2</sup>) in both tension and compression, and the shear modulus is 81,400 MPa (11,800,000 lb/in<sup>2</sup>). Poisson's ratio is 0.28. The **effect of cold rolling** on the tensile strength, yield strength, elongation, and shape of the stress-strain curve is shown in Fig. 6.2.1, which is for Armco ingot iron but would not be substantially different for other low-carbon steels.

**Uses** Low-carbon materials weld evenly and easily in all processes, can be tailored to be readily paintable and to be enameled, and with other treatments make an excellent low-cost soft magnetic material with high permeability and low coercive force for mass-produced motors and transformers. Other uses, usually after galvanizing, include culverts, flumes, roofing, siding, and housing frames; thin plates can be used in oil and water tanks, boilers, gas holders, and various nondemanding pipes; enameled sheet retains a strong market in ranges, refrigerators, and other household goods, in spite of challenges from plastics.

### STEEL

#### Steel Manufacturing

Steel is produced by the removal of impurities from pig iron in a basic oxygen furnace or an electric furnace.

**Basic Oxygen Steel** This steel is produced by blowing pure (99 percent) oxygen either vertically under high pressure (1.2 MPa or

Table 6.2.1 Types of Pig Iron for Steelmaking and Foundry Use

Designation	Chemical composition, %*				Principal use
	Si	P	Mn	C†	
Basic pig, northern	1.50 max	0.400 max	1.01–2.00	3.5–4.4	Basic oxygen steel
In steps of	0.25		0.50		
Foundry, northern	3.50 max	0.301–0.700	0.50–1.25	3.0–4.5	A wide variety of castings
In steps of	0.25		0.25		
Foundry, southern	3.50 max	0.700–0.900	0.40–0.75	3.0–4.5	Cast-iron pipe
In steps of	0.25		0.25		
Ferromanganese (3 grades)	1.2 max	0.35 max	74–82	7.4 max	Addition of manganese to steel or cast iron
Ferrosilicon (silvery pig)	5.00–17.00	0.300 max	1.00–2.00	1.5 max	Addition of silicon to steel or cast iron

\* Excerpted from "The Making, Shaping and Treating of Steel," AISE, 1984; further information in "Steel Products Manual," AISI, and ASTM Standards, Pt. 1.

† Carbon content not specified—for information only. Usually S is 0.05 max (0.06 for ferrosilicon) but S and P for basic oxygen steel are typically much lower today.

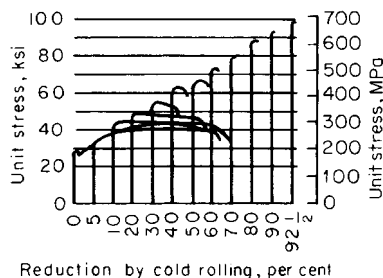

Fig. 6.2.1 Effect of cold rolling on the stress-strain relationship of Armco ingot iron. (Kenyon and Burns.)

175 lb/in<sup>2</sup>) onto the surface of molten pig iron (BOP) or through tuyeres in the base of the vessel (the Q-BOP process). Some facilities use a combination depending on local circumstances and product mix. This is an autogenous process that requires no external heat to be supplied. The furnaces are similar in shape to the former Bessemer converters but range in capacity to 275 metric tons (t) (300 net tons) or more. The barrel-shaped furnace or vessel may or may not be closed on the bottom, is open at the top, and can rotate in a vertical plane about a horizontal axis for charging and for pouring the finished steel. Selected scrap is charged into the vessel first, up to 30 percent by weight of the total charge. Molten pig iron (often purified from the raw blast-furnace hot metal to give lower sulfur, phosphorus, and sometimes silicon) is poured into the vessel. In the Q-BOP, oxygen must be flowing through the bottom tuyeres at this time to prevent clogging; further flow serves to refine the charge and carries in fluxes as powders. In the BOP process, oxygen is introduced through a water-cooled lance introduced through the top of the vessel. Within seconds after the oxygen is turned on, some iron in the charge is converted to ferrous oxide, which reacts rapidly with the impurities of the charge to remove them from the metal. As soon as reaction starts, limestone is added as a flux. Blowing is continued until the desired degree of purification is attained. The reactions take place very rapidly, and blowing of a heat is completed in about 20 min in a 200-net-ton furnace. Because of the speed of the process, a computer is used to calculate the charge required for making a given heat of steel, the rate and duration of oxygen blowing, and to regulate the quantity and timing of additions during the blow and for finishing the steel. Production rates of well over 270 t per furnace hour (300 net tons) can be attained. The comparatively low investment cost and low cost of operation have already made the basic oxygen process the largest producer of steel in the world, and along with electric furnaces, it almost completely replaces the basic open hearth as the major steelmaking process. No open hearths operate in the United States today.

**Electric Steel** The biggest change in steelmaking over the last 20 years is the fraction of steel made by remelting scrap in an electric furnace (EF), originally to serve a relatively nondemanding local market, but increasingly moving up in quality and products to compete with mills using the blast-furnace/oxygen steelmaking route. The eco-

nomics competition is fierce and has served to improve choices for customers.

Early processes used three-phase alternating current, but increasingly the movement is to a single dc electrode with a conducting hearth. The high-power densities necessitate water cooling and improved basic refractory linings. Scrap is charged into the furnace, which usually contains some of the last heat to improve efficiency. Older practices often had a second slag made after the first meltdown and refining by oxygen blowing, but today, final refining takes place outside the melting unit in a ladle furnace, which allows refining, temperature control, and alloying additions to be made without interfering with the next heat. The materials are continuously cast with various degrees of sophistication including slabs only 50 mm (2 in) thick.

The degree to which electric melting can replace more conventional methods is of great interest and depends in large part on the availability of sufficiently pure scrap at an attractive price and some improvements in surface quality to be able to make the highest-value products. Advances in EF technology are countered aggressively by new developments and cost control in traditional steelmaking; it may well be a decade or more before the pattern clarifies.

The **induction furnace** is simply a fairly small melting furnace to which the various metals are added to make the desired alloy, usually quite specialized. When steel scrap is used as a charge, it will be a high-grade scrap the composition of which is well known (see also Sec. 7).

**Ladle Metallurgy** One of the biggest contributors to quality in steel products is the concept of refining liquid steel outside the first melting unit—BOP, Q-BOP, or EF, none of which is well designed to perform the refining function. In this separate unit, gases in solution (oxygen, hydrogen, and, to a lesser extent, nitrogen) can be reduced by vacuum treatment, carbon can be adjusted to desirable very low levels by reaction with oxygen in solution, alloy elements can be added, the temperature can be adjusted, and the liquid steel can be stirred by inert gases to float out inclusions and provide a homogeneous charge to the continuous casters which are now virtually ubiquitous. Reducing oxygen in solution means a "cleaner" steel (fewer nonmetallic inclusions) and a more efficient recovery of alloying elements added with a purpose and which otherwise might end up as oxides.

**Steel Ingots** With the advent of continuous casters, ingot casting is now generally reserved for the production of relatively small volumes of material such as heavy plates and forgings which are too big for current casters. Ingot casting, apart from being inefficient in that the large volume change from liquid to solid must be handled by discarding the large void space usually at the top of the ingot (the **pipe**), also has several other undesirable features caused by the solidification pattern in a large volume, most notably significant differences in composition throughout the piece (**segregation**) leading to different properties, **inclusions** formed during solidification, and surface flaws from poor mold surfaces, splashing and other practices, which if not properly removed lead to defects in finished products (**seams, scabs, scale**, etc.). Some defects can be removed or attenuated, but others cannot; in general, with the exception of some very specialized tool and bearing steels, products from ingots are no longer state-of-the-art unless they are needed for size.

**Continuous Casting** This concept, which began with Bessemer in the 1850s, began to be a reliable production tool around 1970 and since then has replaced basically all ingot casting. Industrialized countries all continuously cast well above 90 percent of their production. Sizes cast range from 2-m (80-in)—or more—by 0.3-m (12-in) **slabs** down to 0.1-m (4-in) square or round **billets**. Multiple strands are common where production volume is important. Many heats of steel can be cast in a continuous string with changes of width possible during operation. Changes of composition are possible in succeeding ladles with a discard of the short length of mixed composition. There is great interest in casting much thinner slabs or even casting directly to sheet; this is currently possible with some quality loss, but major efforts around the world to reduce differences are underway.

By intensive process control, it is often possible to avoid cooling the cast slabs to room temperature for inspection, enabling energy savings since the slabs require less reheating before hot rolling. If for some reason the slabs are cooled to room temperature, any surface defects which might lead to quality problems can be removed—usually by **scarfing** with an oxyacetylene torch or by grinding. Since this represents a yield loss, there is a real economic incentive to avoid the formation of such defects by paying attention to casting practices.

### Mechanical Treatment of Steel

Cast steel, in the form of slabs, billets, or bars (these latter two differ somewhat arbitrarily in size) is treated further by various combinations of hot and cold deformation to produce a finished product for sale from the mill. Further treatments by fabricators usually occur before delivery to the final customer. These treatments have three purposes: (1) to change the shape by deformation or metal removal to desired tolerances; (2) to break up—at least partially—the segregation and large grain sizes inevitably formed during the solidification process and to redistribute the nonmetallic inclusions which are present; and (3) to change the properties. For example, these may be functional—strength or toughness—or largely aesthetic, such as reflectivity.

These purposes may be separable or in many cases may be acting simultaneously. An example is hot-rolled sheet or plate in which often the rolling schedule (reductions and temperature of each pass, and the cooling rate after the last reduction) is a critical path to obtain the properties and sizes desired and is often known as “heat treatment on the mill.”

Most steels are reduced after appropriate heating (to above 1,000°C) in various multistand hot rolling mills to produce **sheet**, **strip**, **plate**, **tubes**, **shaped sections**, or **bars**. More specialized deformation, e.g., by **hammer forging**, can result in working in more than one direction, with a distribution of inclusions which is not extended in one direction. Rolling, e.g., more readily imparts anisotropic properties. **Press forging** at slow strain rates changes the worked structure to greater depths and is preferred for high-quality products. The degree of reduction required to eliminate the cast structure varies from 4:1 to 10:1; clearly smaller reductions would be desirable but are currently not usual.

The slabs, blooms, and billets from the caster must be reheated in an atmosphere-controlled furnace to the working temperature, often from room temperature, but if practices permit, they may be charged hot to save energy. Coupling the hot deformation process directly to slabs at the continuous caster exit is potentially more efficient, but practical difficulties currently limit this to a small fraction of total production.

The steel is oxidized during heating to some degree, and this oxidation is removed by a combination of light deformation and high-pressure water sprays before the principal deformation is applied. There are differences in detail between processes, but as a representative example, the conventional production of wide “hot-rolled sheet” [ $>1.5$  m (60 in)] will be discussed.

The slab, about 0.3 m (12 in) thick at about 1200°C is passed through a **scale breaker** and high-pressure water sprays to remove the oxide film. It then passes through a set of **roughing passes** (possibly with some modest width reduction) to reduce the thickness to just over 25 mm (1 in), the ends are sheared perpendicular to the length to remove irregularities, and finally they are fed into a series of up to seven roll stands each of which creates a reduction of 50 to 10 percent passing

along the train. Process controls allow each mill stand to run sufficiently faster than the previous one to maintain tension and avoid pileups between stands. The temperature of the sheet is a balance between heat added by deformation and that lost by heat transfer, sometimes with interstand water sprays. Ideally the temperature should not vary between head and tail of the sheet, but this is hard to accomplish.

The deformation encourages recrystallization and even some grain growth between stands; even though the time is short, temperatures are high. Emerging from the last stand between 815 and 950°C, the austenite may or may not recrystallize, depending on the temperature. At higher temperatures, when austenite does recrystallize, the grain size is usually small (often in the 10- to 20- $\mu$ m range). At lower exit temperatures austenite grains are rolled into “pancakes” with the short dimension often less than 10  $\mu$ m. Since several ferrite grains nucleate from each austenite grain during subsequent cooling, the ferrite grain size can be as low as 3 to 6  $\mu$ m (ASTM 14 to 12). We shall see later that small ferrite grain sizes are a major contributor to the superior properties of today’s carbon steels, which provide good strength and superior toughness simultaneously and economically.

Some of these steels also incorporate strong carbide and nitride formers in small amounts to provide extra strength from precipitation hardening; the degree to which these are undissolved in austenite during hot rolling affects recrystallization significantly. The subject is too complex to treat briefly here; the interested reader is referred to the ASM “Metals Handbook,” 10th ed., vol. 1, pp. 389–423.

After the last pass, the strip may be cooled by programmed water sprays to between 510 and 730°C so that during coiling, any desired precipitation processes may take place in the coiler. The finished coil, usually 2 to 3 mm (0.080 to 0.120 in) thick and sometimes 1.3 to 1.5 mm (0.052 to 0.060 in) thick, which by now has a light oxide coating, is taken off line and either shipped directly or retained for further processing to make higher value-added products. Depending on composition, typical values of yield strength are from 210 up to 380 MPa (30 to 55 ksi), UTS in the range of 400 to 550 MPa (58 to 80 ksi), with an elongation in 200 mm (8 in) of about 20 percent. The higher strengths correspond to low-alloy steels.

About half the sheet produced is sold directly as hot-rolled sheet. The remainder is further cold-worked after scale removal by **pickling** and either is sold as cold-worked to various **tempers** or is recrystallized to form a very formable product known as **cold-rolled and annealed**, or more usually as **cold-rolled**, sheet. Strengthening by cold work is common in sheet, strip, wire, or bars. It provides an inexpensive addition to strength but at the cost of a serious loss of ductility, often a better surface finish, and finished product held to tighter tolerances. It improves springiness by increasing the yield strength, but does not change the elastic moduli. Examples of the effect of cold working on carbon-steel drawn wires are shown in Figs. 6.2.2 and 6.2.3.

To make the highest class of formable sheet is a very sophisticated operation. After pickling, the sheet is again reduced in a multistand (three, four, or five) mill with great attention paid to tolerances and surface finish. Reductions per pass range from 25 to 45 percent in early passes to 10 to 30 percent in the last pass. The considerable heat generated necessitates an oil-water mixture to cool and to provide the necessary lubrication. The finished coil is degreased prior to annealing.

The purpose of **annealing** is to provide, for the most demanding applications, pancake-shaped grains after recrystallization of the cold-worked ferrite, in a matrix with a very sharp crystal texture containing little or no carbon or nitrogen in solution. The exact metallurgy is complex but well understood. Two types of annealing are possible: slow heating, holding, and cooling of coils in a hydrogen atmosphere (box annealing) lasting several days, or continuous feeding through a furnace with a computer-controlled time-temperature cycle. The latter is much quicker but very capital-intensive and requires careful and complex process control.

As requirements for formability are reduced, production controls can be relaxed. In order of increasing cost, the series is commercial quality (CQ), drawing quality (DQ), deep drawing quality (DDQ), and extra deep drawing quality (EDDQ). Even more formable steels are possible, but they are not often commercially interesting.

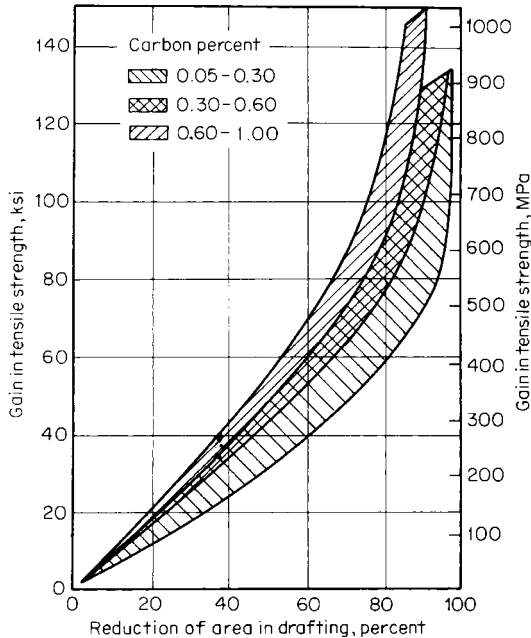

Fig. 6.2.2 Increase of tensile strength of plain carbon steel with increasing amounts of cold working by drawing through a wire-drawing die.

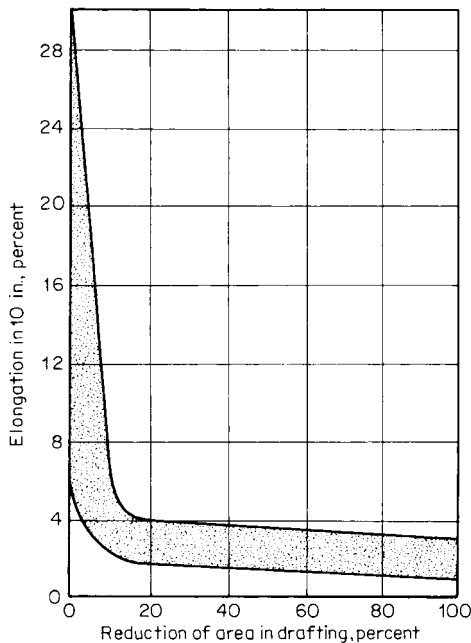

Fig. 6.2.3 Reduction in ductility of plain carbon steel with increasing amounts of cold working by drawing through a wire-drawing die.

Some other deformation processes are occasionally of interest, such as wire drawing, usually done cold, and extrusion, either hot or cold. **Hot extrusion** for materials that are difficult to work became practical through the employment of a glass lubricant. This method allows the hot extrusion of highly alloyed steels and other exotic alloys subjected to service at high loads and/or high temperatures.

### Constitution and Structure of Steel

As a result of the methods of production, the following elements are always present in steel: carbon, manganese, phosphorus, sulfur, silicon, and traces of oxygen, nitrogen, and aluminum. Various alloying elements are frequently added, such as nickel, chromium, copper, molybdenum, niobium (columbium), and vanadium. The most important of the above elements in steel is carbon, and it is necessary to understand the effect of carbon on the internal structure of steel to understand the heat treatment of carbon and low-alloy steels.

The iron-iron carbide equilibrium diagram in Fig. 6.2.4 shows the phases that are present in steels of various carbon contents over a range of temperatures under equilibrium conditions. Pure iron when heated to  $910^{\circ}\text{C}$  ( $1,670^{\circ}\text{F}$ ) changes its internal crystalline structure from a body-centered cubic arrangement of atoms, **alpha iron**, to a face-centered cubic structure, **gamma iron**. At  $1,390^{\circ}\text{C}$  ( $2,535^{\circ}\text{F}$ ), it changes back to the body-centered cubic structure, **delta iron**, and at  $1,539^{\circ}\text{C}$  ( $2,802^{\circ}\text{F}$ ) the iron melts. When carbon is added to iron, it is found that it has only slight solid solubility in alpha iron (much less than 0.001 percent at room temperature at equilibrium). These small amounts of carbon, however, are critically important in many high-tonnage applications where formability is required. On the other hand, gamma iron will hold up to 2.0 percent carbon in solution at  $1,130^{\circ}\text{C}$  ( $2,066^{\circ}\text{F}$ ). The alpha iron containing carbon or any other element in solid solution is called **ferrite**, and the gamma iron containing elements in solid solution is called **austenite**. Usually when not in solution in the iron, the carbon forms a compound  $\text{Fe}_3\text{C}$  (iron carbide) which is extremely hard and brittle and is known as **cementite**.

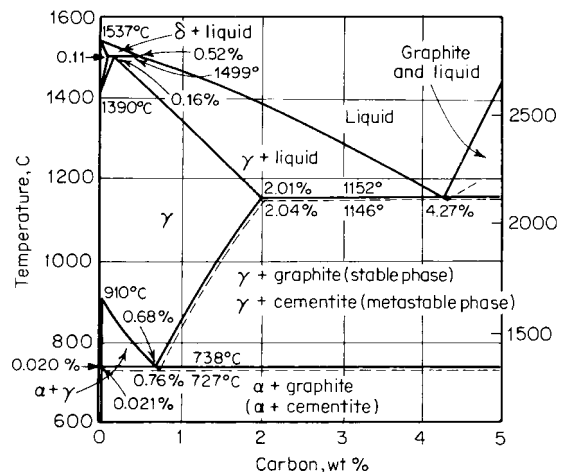

Fig. 6.2.4 Iron-iron carbide equilibrium diagram, for carbon content up to 5 percent. (Dashed lines represent equilibrium with cementite, or iron carbide; adjacent solid lines indicate equilibrium with graphite.)

The temperatures at which the phase changes occur are called **critical points** (or temperatures) and, in the diagram, represent equilibrium conditions. In practice there is a lag in the attainment of equilibrium, and the critical points are found at lower temperatures on cooling and at higher temperatures on heating than those given, the difference increasing with the rate of cooling or heating.

The various critical points have been designated by the letter **A**; when obtained on cooling, they are referred to as  $A_r$ , on the heating as  $A_c$ . The subscripts  $r$  and  $c$  refer to *refroidissement* and *chauffage*, respectively, and reflect the early French contributions to heat treatment. The various critical points are distinguished from each other by numbers after the letters, being numbered in the order in which they occur as the temperature increases.  $A_{c1}$  represents the beginning of transformation of ferrite to austenite on heating;  $A_{c3}$  the end of transformation of ferrite to austenite on heating, and  $A_{c4}$  the change from austenite to delta iron



on heating. On cooling, the critical points would be referred to as  $Ar_4$ ,  $Ar_3$ , and  $Ar_1$ , respectively. The subscript 2, not mentioned here, refers to a magnetic transformation. It must be remembered that the diagram represents the pure iron-iron carbide system at equilibrium. The varying amounts of impurities in commercial steels affect to a considerable extent the position of the curves and especially the lateral position of the eutectoid point.

Carbon steel in equilibrium at room temperature will have present both ferrite and cementite. The physical properties of ferrite are approximately those of pure iron and are characteristic of the metal. Cementite is itself hard and brittle; its shape, amount, and distribution control many of the mechanical properties of steel, as discussed later. The fact that the carbides can be dissolved in austenite is the basis of the heat treatment of steel, since the steel can be heated above the  $A_1$  critical temperature to dissolve all the carbides, and then suitable cooling through the appropriate range will produce a wide and predictable range of the desired size and distribution of carbides in the ferrite.

If austenite with the **eutectoid** composition at 0.76 percent carbon (Fig. 6.2.4) is cooled slowly through the critical temperature, ferrite and cementite are rejected simultaneously, forming alternate plates or lamellae. This microstructure is called **pearlite**, since when polished and etched it has a pearly luster. When examined under a high-power optical microscope, however, the individual plates of cementite often can be distinguished easily. If the austenite contains less carbon than the eutectoid composition (i.e., **hypoeutectoid** compositions), free ferrite will first be rejected on slow cooling through the critical temperature until the remaining austenite reaches eutectoid composition, when the simultaneous rejection of both ferrite and carbide will again occur, producing pearlite. A hypoeutectoid steel at room temperature will be composed of areas of free ferrite and areas of pearlite; the higher the carbon percentage, the greater the amount of pearlite present in the steel. If the austenite contains more carbon than the eutectoid composition (i.e., **hypereutectoid** composition) and is cooled slowly through the critical temperature, then cementite is rejected and appears at the austenitic grain boundaries, forming a continuous cementite network until the remaining austenite reaches eutectoid composition, at which time pearlite is formed. A hypereutectoid steel, when slowly cooled, will exhibit areas of pearlite surrounded by a thin network of cementite, or iron carbide.

As the cooling rate is increased, the spacing between the pearlite lamellae becomes smaller; with the resulting greater dispersion of carbide preventing slip in the iron crystals, the steel becomes harder. Also, with an increase in the rate of cooling, there is less time for the separation of excess ferrite or cementite, and the equilibrium amount of these constituents will not be precipitated before the austenite transforms to pearlite. Thus with a fast rate of cooling, pearlite may contain less or more carbon than given by the eutectoid composition. When the cooling rate becomes very rapid (as obtained by quenching), the carbon does not have sufficient time to separate out in the form of carbide, and the austenite transforms to a highly elastically stressed structure supersaturated with carbon called **martensite**. This structure is exceedingly hard but brittle and requires **tempering** to increase the ductility. Tempering consists of heating martensite to some temperature below the critical temperature, causing the carbide to precipitate in the form of small spheroids, or especially in alloy steels, as needles or platelets. The higher the tempering temperature, the larger the carbide particle size, the greater the ductility of the steel, and the lower the hardness.

In a carbon steel, it is possible to have a structure consisting either of parallel plates of carbide in a ferrite matrix, the distance between the plates depending upon the rate of cooling, or of carbide spheroids in a ferrite matrix, the size of the spheroids depending upon the temperature to which the hardened steel was heated. (Some spheroidization occurs when pearlite is heated, but only at high temperatures close to the critical temperature range.)

#### Heat-Treating Operations

The following definitions of terms have been adopted by the ASTM, SAE, and ASM in substantially identical form.

**Heat Treatment** An operation, or combination of operations, involving the heating and cooling of a metal or an alloy in the solid state, for the purpose of obtaining certain desirable conditions or properties.

**Quenching** Rapid cooling by immersion in liquids or gases or by contact with metal.

**Hardening** Heating and quenching certain iron-base alloys from a temperature either within or above the critical range for the purpose of producing a hardness superior to that obtained when the alloy is not quenched. Usually restricted to the formation of martensite.

**Annealing** A heating and cooling operation implying usually a relatively slow cooling. The purpose of such a heat treatment may be (1) to remove stresses; (2) to induce softness; (3) to alter ductility, toughness, electrical, magnetic, or other physical properties; (4) to refine the crystalline structure; (5) to remove gases; or (6) to produce a definite microstructure. The temperature of the operation and the rate of cooling depend upon the material being heat-treated and the purpose of the treatment. Certain specific heat treatments coming under the comprehensive term annealing are as follows:

**Full Annealing** Heating iron base alloys above the critical temperature range, holding above that range for a proper period of time, followed by slow cooling to below that range. The annealing temperature is usually about 50°C ( $\approx 100^\circ\text{F}$ ) above the upper limit of the critical temperature range, and the time of holding is usually not less than 1 h for each 1-in section of the heaviest objects being treated. The objects being treated are ordinarily allowed to cool slowly in the furnace. They may, however, be removed from the furnace and cooled in some medium that will prolong the time of cooling as compared with unrestricted cooling in the air.

**Process Annealing** Heating iron-base alloys to a temperature below or close to the lower limit of the critical temperature range followed by cooling as desired. This heat treatment is commonly applied in the sheet and wire industries, and the temperatures generally used are from 540 to 705°C (about 1,000 to 1,300°F).

**Normalizing** Heating iron base alloys to approximately 40°C (about 100°F) above the critical temperature range followed by cooling to below that range in still air at ordinary temperature.

**Patenting** Heating iron base alloys above the critical temperature range followed by cooling below that range in air or a molten mixture of nitrates or nitrites maintained at a temperature usually between 425 and 565°C (about 800 to 1,050°F), depending on the carbon content of the steel and the properties required of the finished product. This treatment is applied in the wire industry to medium- or high-carbon steel as a treatment to precede further wire drawing.

**Spheroidizing** Any process of heating and cooling steel that produces a rounded or globular form of carbide. The following spheroidizing methods are used: (1) Prolonged heating at a temperature just below the lower critical temperature, usually followed by relatively slow cooling. (2) In the case of small objects of high-carbon steels, the spheroidizing result is achieved more rapidly by prolonged heating to temperatures alternately within and slightly below the critical temperature range. (3) Tool steel is generally spheroidized by heating to a temperature of 750 to 805°C (about 1,380 to 1,480°F) for carbon steels and higher for many alloy tool steels, holding at heat from 1 to 4 h, and cooling slowly in the furnace.

**Tempering (also termed Drawing)** Reheating hardened steel to some temperature below the lower critical temperature, followed by any desired rate of cooling. Although the terms *tempering* and *drawing* are practically synonymous as used in commercial practice, the term *tempering* is preferred.

**Transformation Reactions in Carbon Steels** Much of, but not all, the heat treatment of steel involves heating into the region above  $Ac_3$  to form austenite, followed by cooling at a preselected rate. If the parts are large, heat flow may limit the available cooling rates. As an example selected for simplicity rather than volume of products, we may follow the possible transformations in a eutectoid steel over a range of temperature. (The reactions to produce ferrite in hypoeutectoid steels, which are by far the most common, do not differ in principle; the products are, of course, softer.) The curve is a derivative of the TTT (time-tempera-

ture-transformation) curves produced by a systematic study of austenite transformation rates isothermally on specimens thin enough to avoid heat flow complications. The data collected for many steels are found in the literature.

Figure 6.2.5 summarizes the rates of decomposition of a eutectoid carbon steel over a range of temperatures. Various cooling rates are shown diagrammatically, and it will be seen that the faster the rate of cooling, the lower the temperature of transformation, and the harder the product formed. At around 540°C (1,000°F), the austenite transforms rapidly to fine pearlite; to form martensite it is necessary to cool very rapidly through this temperature range to avoid the formation of pearlite before the specimen reaches the temperature at which the formation of martensite begins ( $M_s$ ). The minimum rate of cooling that is required to form a fully martensite structure is called the **critical cooling rate**. No matter at what rate the steel is cooled, the only products of transformation of this steel will be pearlite or martensite. However, if the steel can be given an interrupted quench in a molten bath at some temperature between 205 and 540°C (about 400 and 1,000°F), an acicular structure, called **bainite**, of considerable toughness, combining high strength with

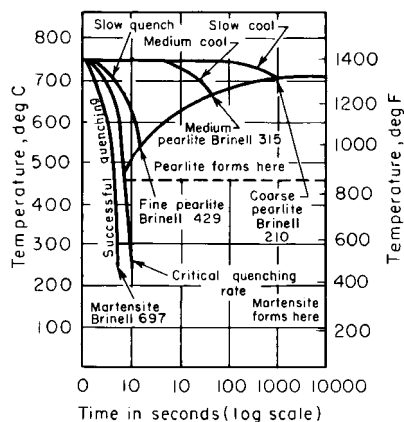

Fig. 6.2.5 Influence of cooling rate on the product of transformation in a eutectoid carbon steel.

high ductility, is obtained, and this heat treatment is known as austempering. A somewhat similar heat treatment called martempering can be utilized to produce a fully martensitic structure of high hardness, but free of the cracking, distortion, and residual stresses often associated with such a structure. Instead of quenching to room temperature, the steel is quenched to just above the martensitic transformation temperature and held for a short time to permit equalization of the temperature gradient throughout the piece. Then the steel may be cooled relatively slowly through the martensitic transformation range without superimposing thermal stresses on those introduced during transformation. The limitation of austempering and martempering for carbon steels is that these two heat treatments can be applied only to articles of small cross section, since the rate of cooling in salt baths is not sufficient to prevent the formation of pearlite in samples with diameter of more than 1/2 in.

The maximum hardness obtainable in a high-carbon steel with a fine pearlite structure is approximately 400 Brinell, although a martensitic structure would have a hardness of approximately 700 Brinell. Besides being able to obtain structures of greater hardness by forming martensite, a spheroidal structure will have considerably higher proof stress (i.e., stress to cause a permanent deformation of 0.01 percent) and ductility than a lamellar structure of the same tensile strength and hardness. It is essential, therefore, to form martensite when optimum properties are desired in the steel. This can be done with a piece of steel having a small cross section by heating the steel above the critical and quenching in water; but when the cross section is large, the cooling rate at the center of the section will not be sufficiently rapid to prevent the formation of pearlite. The characteristic of steel that determines its capacity to harden throughout the section when quenched is called **hardenability**. In

the discussion that follows, it is pointed out that hardenability is significantly affected by most alloying elements. This term should not be confused with the ability of a steel to attain a certain hardness. The intensity of hardening, i.e., the maximum hardness of the martensite formed, is very largely dependent upon the carbon content of the steel.

**Determination of Hardenability** A long-established test for hardenability is the **Jominy test** which performs controlled water cooling on one end of a standard bar. Since the thermal conductivity of steel does not vary significantly, each distance from the quenched end (DQE) corresponds to a substantially unique cooling rate, and the structure obtained is a surrogate for the TTT curve on cooling. For a detailed account of the procedure, see the SAE Handbook. The figures extracted from the Jominy test can be extended to many shapes and quenching media. In today's practices, the factors discussed below can often be used to calculate hardenability from chemical composition with considerable confidence, leaving the actual test as a referee or for circumstances where a practice is being developed.

Three main factors affect the hardenability of steel: (1) austenite composition; (2) austenite grain size; and (3) amount, nature, and distribution of undissolved or insoluble particles in the austenite. All three determine the rate of decomposition, in the range of 540°C (about 1,000°F). The slower the rate of decomposition, the larger the section that can be hardened throughout, and therefore the greater the hardenability of the steel. Everything else being equal, the higher the carbon content, the greater the hardenability; this approach, however, is often counterproductive in that other strength properties may be affected in undesirable ways. The question of **austenitic grain size** is of considerable importance in any steel that is to be heat-treated, since it affects the properties of the steel to a considerable extent. When a steel is heated to just above the critical temperature, small polyhedral grains of austenite are formed. With increase in temperature, there is an increase in the size of grains, until at temperatures close to the melting point the grains are very large. Since the transformation of austenite to ferrite and pearlite usually starts at grain boundaries, a fine-grained steel will transform more rapidly than a coarse-grained steel because the latter has much less surface area bounding the grains than a steel with a fine grain size.

The grain size of austenite at a particular temperature depends primarily on the "pinning" of the boundaries by undissolved particles. These particles, which can be aluminum nitride from the deoxidation or various carbides and/or nitrides (added for their effect on final properties), dissolve as temperature increases, allowing grain growth. While hardenability is increased by large austenite grain size, this is not usually favored since some properties of the finished product can be seriously downgraded. Small particles in the austenite will act as nuclei for the beginning of transformation in a manner similar to grain boundaries, and therefore the presence of a large number of small particles (sometimes submicroscopic in size) will also result in low hardenability.

**Determination of Austenitic Grain Size** The subject of austenite grain size is of considerable interest because of the fact noted above that the grain size developed during heat treatment has a large effect on the physical properties of the steel. In steels of similar chemical analysis, the steel developing the finer austenitic grain size will have a lower hardenability but will, in general, have greater toughness, show less tendency to crack or warp on quenching, be less susceptible to grinding cracks, have lower internal stresses, and retain less austenite than coarse-grained steel. There are several methods of determining the grain-size characteristics of a steel.

The **McQuaid-Ehn test** (ASTM E112), which involves the outlining of austenite grains by cementite after a specific carburizing treatment, is still valid. It has been largely replaced, however, by quenching from the austenitizing treatment under investigation and observing the grain size of the resulting martensite after light tempering and etching with Vilella's reagent. There are several ways to report the grain size observed under the microscope, the one used most extensively being the ASTM index numbers. In fps or English units, the numbers are based on the formula: number of grains per square inch at 100x =  $2^{N-1}$ , in which  $N$  is the grain-size index. The usual range in steels will be from 1 to 128 grains/in<sup>2</sup> at 100x, and the corresponding ASTM numbers will be 1 to 8,

although today grain sizes up to 12 are common. Whereas at one time “coarse” grain sizes were 1 to 4, and “fine” grain sizes 5 to 8, these would not serve modern requirements. Most materials in service would be no coarser than 7 or 8, and the ferritic low-alloy high-strength steels routinely approach 12 or smaller. Grain-size relationships in SI units are covered in detail in Designation E112 of ASTM Standards. For further information on grain size, refer to the ASM “Metals Handbook.”

### EFFECT OF ALLOYING ELEMENTS ON THE PROPERTIES OF STEEL

When relatively large amounts of alloying elements are added to steel, the characteristic behavior of carbon steels is not lost. Most alloy steel is medium- or high-carbon steel to which various elements have been added to modify its properties to an appreciable extent; the alloys as a minimum allow the properties characteristic of the carbon content to be fully realized even in larger sections, and in some cases may provide additional benefits. The percentage of alloy element required for a given purpose ranges from a few hundredths of 1 percent to possibly as high as 5 percent.

When ready for service, these steels will usually contain only two constituents, ferrite and carbide. The only way that an alloying element can affect the properties of the steel is to change the dispersion of carbide in the ferrite, change the properties of the ferrite, or change the characteristics of the carbide. The effect on the distribution of carbide is the most important factor, since in sections amenable to close control of structure, carbon steel is only moderately inferior to alloy steel. However, in large sections where carbon steels will fail to harden throughout the section even on a water quench, the hardenability of the steel can be increased by the addition of any alloying element (except possibly cobalt). The increase in hardenability permits the hardening of a larger section of alloy steel than of plain carbon steel. The quenching operation does not have to be so drastic. Consequently, there is a smaller difference in temperature between the surface and center during quenching, and cracking and warping resulting from sharp temperature gradients in a steel during hardening can be avoided. The elements most effective in increasing the hardenability of steel are manganese, silicon, and chromium, or combinations of small amounts of several elements such as chromium, nickel, and molybdenum in SAE 4340, where the joint effects are greater than alloys acting singly.

Elements such as molybdenum, tungsten, and vanadium are effective in increasing the hardenability when dissolved in the austenite, but not when present in the austenite in the form of carbides. When dissolved in austenite, and thus contained in solution in the resulting martensite, they can modify considerably the rate of coarsening of carbides in tempered martensite. Tempering relieves the internal stresses in the hardened steel in part by precipitating various carbides of iron at fairly low temperature, which coarsen as the tempering temperature is increased. The increasing particle separation results in a loss of hardness and strength accompanied by increased ductility. See Fig. 6.2.6. Alloying elements can cause slower coarsening rates or, in some cases at temperatures from 500 to 600°C, can cause dissolution of cementite and the precipitation of a new set of small, and thus closely spaced, alloy carbides which in some cases can cause the hardness to actually rise again with no loss in toughness or ductility. This is especially important in tool steels. The presence of these stable carbide-forming elements enables higher tempering temperatures to be used without sacrificing strength. This permits these alloy steels to have a greater ductility for a given strength, or, conversely, greater strength for a given ductility, than plain carbon steels.

The third factor which contributes to the strength of alloy steel is the presence of the alloying element in the ferrite. Any element in solid solution in a metal will increase the strength of the metal, so that these elements will materially contribute to the strength of hardened and tempered steels. The elements most effective in strengthening the ferrite are phosphorus, silicon, manganese, nickel, molybdenum, and chromium. Carbon and nitrogen are very strong ferrite strengtheners but generally are not present in interstitial solution in significant amounts, and there

are other processing reasons to actively keep the amount in solution small by adding strong carbide and/or nitride formers to give interstitial-free (IF) steels.

A final important effect of alloying elements discussed above is their influence on the austenitic grain size. Martensite formed from a fine-grained austenite has considerably greater resistance to shock than when formed from a coarse-grained austenite.

In Table 6.2.2, a summary of the effects of various alloying elements is given. Remember that this table indicates only the trends of the various elements, and the fact that one element has an important influence on one factor does not prevent it from having a completely different influence or another one.

### PRINCIPLES OF HEAT TREATMENT OF IRON AND STEEL

When heat-treating a steel for a given part, certain precautions have to be taken to develop optimum mechanical properties in the steel. Some of the major factors that have to be taken into consideration are outlined below.

**Heating** The first step in the heat treatment of steel is the heating of the material to above the critical temperature to make it fully austenitic. The **heating rate** should be sufficiently slow to avoid injury to the material through excessive thermal and transformational stresses. In general, hardened steel should be heated more slowly and uniformly than is necessary for soft stress-free materials. Large sections should not be placed in a hot furnace, the allowable size depending upon the carbon and alloy content. For high-carbon steels, care should be taken in heating sections as small as 50-mm (2-in) diameter, and in medium-carbon steels precautions are required for sizes over 150-mm (6-in) diameter. The **maximum temperature** selected will be determined by the chemical composition of the steel and its grain-size characteristics. In hypoeutectoid steel, a temperature about 25 to 50°C above the upper critical range is used, and in hypereutectoid steels, a temperature between the lower and the upper critical temperature is generally used to retain enough carbides to keep the austenite grain size small and preserve what is often limited toughness. Quenching temperatures are usually a little closer to the critical temperature for hypoeutectoid steels than to those for normalizing; annealing for softening is carried out just below  $A_{c1}$  for steels up to 0.3 percent C and just above for higher-carbon steels. Tables of suggested temperatures can be found in the ASM “Metals Handbook,” or a professional heat treater may be consulted.

The **time** at maximum temperature should be such that a uniform temperature is obtained throughout the cross section of the steel. Care should be taken to avoid undue length of time at temperature, since this will result in undesirable grain growth, scaling, or decarburization of the surface. A practical figure often given for the total time in the hot furnace is 12 min/cm (about ½ h/in) of cross-sectional thickness. When the steel has attained a uniform temperature, the **cooling rate** must be such as to develop the desired structure; slow cooling rates (furnace or air cooling) to develop the softer pearlitic structures and high cooling rates (quenching) to form the hard martensitic structures. In selecting a **quenching medium** (see ASM “Metals Handbook”), it is important to select the quenching medium for a particular job on the basis of size, shape, and allowable distortion before choosing the steel composition. It is convenient to classify steels in two groups on the basis of depth of hardening: shallow hardening and deep hardening. **Shallow-hardening steels** may be defined as those which, in the form of 25-mm- (1-in-) diameter rounds, have, after brine quenching, a completely martensitic shell not deeper than 6.4 mm (¼ in). The shallow-hardening steels are those of low or no alloy content, whereas the deep-hardening steels have a substantial content of those alloying elements that increase penetration of hardening, notably chromium, manganese, and nickel. The high cooling rates required to harden shallow-hardening steel produce severe distortion and sometimes quench cracking in all but simple, symmetric shapes having a low ratio of length to diameter or thickness. Plain carbon steels cannot be used for complicated shapes where distortion must be avoided. In this case, water quenching must be abandoned and a

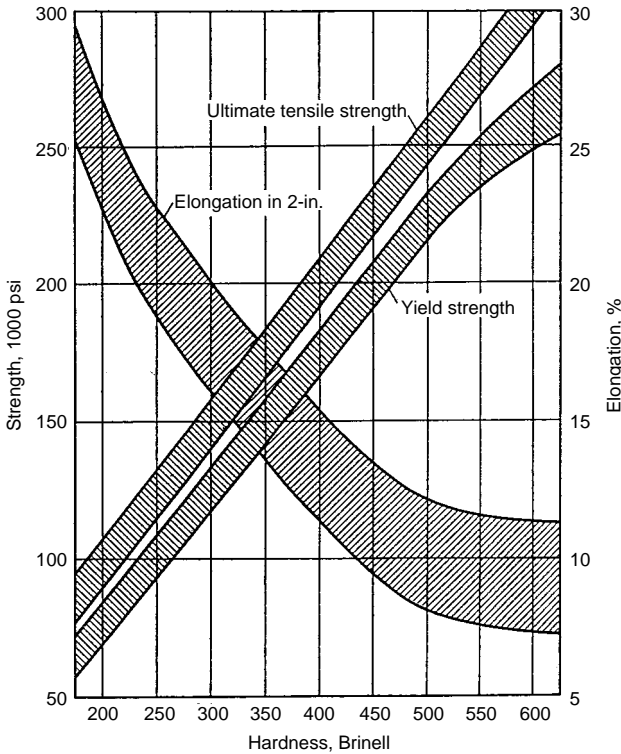

Fig. 6.2.6 Range of tensile properties in several quenched and tempered steels at the same hardness values. (Janitzky and Baeyertz. Source: ASM; reproduced by permission.)

less active quench used which materially reduces the temperature gradient during quenching. Certain oils are satisfactory but are incapable of hardening shallow-hardening steels of substantial size. A change in steel composition is required with a change from water to an oil quench. Quenching in oil does not entirely prevent distortion. When the degree of distortion produced by oil quenching is objectionable, recourse is taken to air hardening. The cooling rate in air is very much slower than in oil or water; so an exceptionally high alloy content is required. This means that a high price is paid for the advantage gained, in terms of both

metal cost and loss in machinability, though it may be well justified when applied to expensive tools or dies. In this case, danger of cracking is negligible.

**Liquids for Quenching Shallow-Hardening Steels** Shallow-hardening steels require extremely rapid surface cooling in the quench, particularly in the temperature range around 550°C (1,020°F). A submerged water spray will give the fastest and most reproducible quench practicable. Such a quench is limited in application to simple short objects which are not likely to warp. Because of difficulty in obtaining symmetric flow of the water relative to the work, the spray quench is conducive to warping. The ideal practical quench is one that will give the required surface cooling without agitation of the bath. The addition of ordinary salt, sodium chloride, greatly improves the performance of water in this respect, the best concentration being around 10 percent. Most inorganic salts are effective in suppressing the formation of vapor at the surface of the steel and thus aid in cooling steel uniformly and eliminating the formation of soft spots. To minimize the formation of vapor, water-base quenching liquids must be kept cold, preferably under 20°C (about 70°F). The addition of some other soluble materials to water such as soap is extremely detrimental because of increased formation of vapor.

**Liquids for Quenching Deeper-Hardening Steels** When oil quenching is necessary, use a steel of sufficient alloy content to produce a completely martensitic structure at the surface over the heaviest section of the work. To minimize the possibility of cracking, especially when hardening tool steels, keep the quenching oil warm, preferably between 40 and 65°C (about 100 and 150°F). If this expedient is insufficient to prevent cracking, the work may be removed just before the start of the hardening transformation and cooled in air. Whether or not transformation has started can be determined with a permanent magnet, the work being completely nonmagnetic before transformation.

The cooling characteristics of quenching oils are difficult to evaluate and have not been satisfactorily correlated with the physical properties of the oils as determined by the usual tests. The standard tests are important with regard to secondary requirements of quenching oils. Low viscosity assures free draining of oil from the work and therefore low oil loss. A high flash and fire point assures a high boiling point and reduces the fire hazard which is increased by keeping the oil warm. A low carbon residue indicates stability of properties with continued use and little sludging. The steam-emulsion number should be low to ensure low water content, water being objectionable because of its vapor-film-forming tendency and high cooling power. A low saponification number assures that the oil is of mineral base and not subject to organic deterioration of fatty oils which give rise to offensive odors. Viscosity index is a valuable property for maintenance of composition.

Table 6.2.2 Trends of Influence of Some Alloying Elements

Element	Strengthening as dissolved in ferrite	Hardenability effects if dissolved in austenite	Effect on grain coarsening in austenite if undissolved as compound	Effects on tempered hardness, strength, and toughness
Al	*	*	†	None
Cr	*	†	†	*
Co	†	Negative	None	None
Cu	†	*	None	None
Mn	†	*	*	*
Mo	*	†	†	None
Nb (Cb)	None	†‡	†	†
Ni	*	*	None	None
P	†	*	None	None
Si	*	*	None	None
Ta	†	†‡	†	†
Ti	†	†	†	†
W	*	†	†	†
V	*	†	†	†

\* Effects are moderate at best.

† Effects are strong to very strong.

‡ Effects not clear, or not used significantly.

In recent years, polymer-water mixtures have found application because of their combination of range of heat abstraction rates and relative freedom from fire hazards and environmental pollution. In all cases, the balance among productivity, danger of distortion and cracking, and minimum cost to give adequate hardenability is not simple; even though some general guides are available (e.g., "Metals Handbook," vol. 1, 10th ed.), consultation with experienced professionals is recommended.

**Effect of the Condition of Surface** The factors that affect the depth of hardening are the hardenability of the steel, the size of specimen, the quenching medium, and finally the condition of the surface of the steel before quenching. Steel that carries a heavy coating of scale will not cool so rapidly as a steel that is comparatively scale-free, and soft spots may be produced; or, in extreme cases, complete lack of hardening may result. It is therefore essential to minimize scaling as much as possible. Decarburization can also produce undesirable results such as nonuniform hardening and thus lowers the resistance of the material to alternating stresses (i.e., fatigue).

**Tempering**, as noted above, relieves quenching stresses and offers the ability to obtain useful combinations of properties through selection of tempering temperature. The ability of alloying elements to slow tempering compared to carbon steel allows higher temperatures to be used to reach a particular strength. This is accompanied by some usually modest increases in ductility and toughness. Certain high-hardenability steels are subject to delayed cracking after quenching and should be tempered without delay. Data on tempering behavior are available from many sources, such as ASM "Metals Handbook" or Bain and Paxton, "Functions of the Alloying Elements in Steel," 3d ed., ASM International.

#### Relation of Design to Heat Treatment

Care must be taken in the design of a machine part to prevent cracking or distortion during heat treatment. With proper design the entire piece may be heated and cooled at approximately the same rate during the heat-treating operation. A light section should never be joined to a heavy section. Sharp reentrant angles should be avoided. Sharp corners and inadequate fillets produce serious stress concentration, causing the actual service stresses to build up to a point where they amount to two to five times the normal working stress calculated by the engineer in the original layout. The use of generous fillets is especially desirable with all high-strength alloy steels.

The modulus of elasticity of all commercial steels, either carbon or alloy, is the same so far as practical designing is concerned. The deflection under load of a given part is, therefore, entirely a function of the section of the part and is not affected by the composition or heat treatment of the steel. Consequently if a part deflects excessively, a change in design is necessary; either a heavier section must be used or the points of support must be increased.

## COMPOSITE MATERIALS

For some applications, it is not necessary or even desirable that the part have the same composition throughout. The oldest method of utilizing this concept is to produce a high-carbon surface on low-carbon steel by **carburizing**, a high-temperature diffusion treatment, which after quenching gives a wear-resistant case 1 or 2 mm (0.04 or 0.08 in) thick on a fairly shock-resistant core. Clearly, this is an attractive process for gears and other complex machined parts. Other processes which produce a similar product are **nitriding** (which can be carried out at lower temperatures) and **carbonitriding** (a hybrid), or where corrosion resistance is important, by **chromizing**. Hard surfaces can also be obtained on a softer core by using selective heating to produce surface austenite (induction, flames, etc.) before quenching, or by depositing various hard materials on the surface by welding.

Many other types of surface treatment which provide corrosion protection and sometimes aesthetic values are common, beginning with paint or other polymeric films and ranging through enamels (a glass film); films such as zinc and its alloys which can be applied by dipping in molten baths or can be deposited electrolytically on one or both sides

(galvanizing); tinplate for cans and other containers; chromium plating; or a light coherent scale of iron oxide. These processes are continually being improved, and they may be used in combinations, e.g., paint on a galvanized surface for exposed areas of automobiles. (See Sec. 6.6.)

**Carburizing** Various methods are available depending on the production volume. Pack carburizing can handle diverse feedstock by enclosing the parts in a sealed heat-resistant alloy box with carbonates and carbonaceous material, and by heating for several hours at about 925°C. The carbon dioxide evolved reacts with carbon to form carbon monoxide as the carrier gas, which does the actual carburizing. While the process can be continuous, much of it is done as a batch process, with consequent high labor costs and uncertain quality to be balanced against the flexibility of custom carburizing.

For higher production rates, furnaces with controlled atmospheres involving hydrocarbons and carbon monoxide provide better controls, low labor costs, shorter times to produce a given case depth [4 h versus 9 h for a 1-mm (0.04-in) case], and automatic quenching. Liquid carburizing using cyanide mixtures is even quicker for thin cases, but often it is not as economical for thicker ones; its great advantage is flexibility and control in small lots.

To provide the inherent value in this material of variable composition, it must be treated to optimize the properties of case and core by a double heat treatment. In many cases, to avoid distortion of precision parts, the material is first annealed at a temperature above the carburizing temperature and is cooled at a rate to provide good machinability. The part is machined and then carburized; through careful steel selection, the austenite grain size is not large at this point, and the material can be quenched directly without danger of cracking or distortion. Next the part is tempered; any retained austenite from the low  $M_s$  of the high-carbon case has a chance to precipitate carbides, raise its  $M_s$ , and transform during cooling after tempering. Care is necessary to avoid internal stresses if the part is to be ground afterward. An alternative approach is to cool the part reasonably slowly after carburizing and then to heat-treat the case primarily by suitable quenching from a temperature typical for hypereutectoid steels between  $A_1$  and  $A_{cm}$ . This avoids some retained austenite and is helpful in high-production operations. The core is often carbon steel, but if alloys are needed for hardenability, this must be recognized in the heat treatment.

**Nitriding** A very hard, thin case can be produced by exposing an already quenched and tempered steel to an ammonia atmosphere at about 510 to 540°C, but unfortunately for periods of 50 to 90 h. The nitrogen diffuses into the steel and combines with strong nitride formers such as aluminum and chromium, which are characteristically present in steels where this process is to be used. The nitrides are small and finely dispersed; since quenching is not necessary after nitriding, dimensional control is excellent and cracking is not an issue. The core properties do not change since tempering at 550°C or higher temperature has already taken place. A typical steel composition is as follows: C, 0.2 to 0.3 percent; Mn, 0.04 to 0.6 percent; Al, 0.9 to 1.4 percent; Cr, 0.9 to 1.4 percent; and Mo, 0.15 to 0.25 percent.

**Carbonitriding (Cyaniding)** An interesting intermediate which rapidly adds both carbon and nitrogen to steels can be obtained by immersing parts in a cyanide bath just above the critical temperature of the core followed by direct quenching. A layer of about 0.25 mm (0.010 in) can be obtained in 1 h. The nitrides add to the wear resistance.

**Local Surface Hardening** For some parts which do not readily fit in a furnace, the surface can be hardened preferentially by local heating using flames, induction coils, electron beams, or lasers. The operation requires skill and experience, but in proper hands it can result in very good local control of structure, including the development of favorable surface compressive stresses to improve fatigue resistance.

**Clad steels** can be produced by one of several methods, including simple cladding by rolling a sandwich out of contact with air at a temperature high enough to bond (1,200°C); by explosive cladding where the geometry is such that the energy of the explosive causes a narrow molten zone to traverse along the interface and provide a good fusion bond; and by various casting and welding processes which can deposit a wide variety of materials (ranging from economical, tough, corrosion-

resistant, or high-thermal-conductivity materials to hard and stable carbides in a suitable matrix). Many different product shapes lend themselves to these practices.

**Chromizing** Chromizing of low-carbon steel is effective in improving corrosion resistance by developing a surface containing up to 40 percent chromium. Some forming operations can be carried out on chromized material. Most chromizing is accomplished by packing the steel to be treated in a powdered mixture of chromium and alumina and then heating to above 1,260°C (2,300°F) for 3 or 4 h in a reducing atmosphere. Another method is to expose the parts to be treated to gaseous chromium compounds at temperatures above 845°C (about 1,550°F). Flat rolled sheets for corrosive applications such as auto mufflers can thus be chromized in open-coil annealing facilities.

### THERMOMECHANICAL TREATMENT

The effects of mechanical treatment and heat treatment on the mechanical properties of steel have been discussed earlier in this section. Thermomechanical treatment consists of combining controlled (sometimes large) amounts of plastic deformation with the heat-treatment cycle to achieve improvements in yield strength beyond those attainable by the usual rolling practices alone or rolling following by a separate heat treatment. The tensile strength, of course, is increased at the same time as the yield strength (not necessarily to the same degree), and other properties such as ductility, toughness, creep resistance, and fatigue life can be improved. However, the high strength and hardness of thermomechanically treated steels limit their usefulness to the fabrication of components that require very little cold forming or machining, or very simple shapes such as strip and wire that can be used as part of a composite structure. Although the same yield strength may be achieved in a given steel by different thermomechanical treatments, the other mechanical properties (particularly the toughness) are not necessarily the same.

There are many possible combinations of deformation schedules and time-temperature relationships in heat treatment that can be used for thermomechanical treatment, and individual treatments cannot be discussed here. Table 6.2.3 classifies broadly thermomechanical treatments into three principal groups related to the time-temperature dependence of the transformation of austenite discussed earlier under heat treatment. The names in parentheses following the subclasses in the table are those of some types of thermomechanical treatments that have been used commercially or have been discussed in the literature. At one time it was thought that these procedures would grow in importance, but in fact they are still used in a very minor way with the important exception of class 1a and class 1c, which are critically important in large tonnages.

**Table 6.2.3 Classification of Thermomechanical Treatments**

Class I. Deformation before austenite transformation	
a.	Normal hot-working processes (hot/cold working)
b.	Deformation before transformation to martensite (ausforming, austforming, austenrolling, hot-cold working, marworking, warm working)
c.	Deformation before transformation to ferrite-carbide aggregates (austen-tempering)
Class II. Deformation during austenite transformation	
a.	Deformation during transformation to martensite (Zerolling and Ardeform processes)
b.	Deformation during transformation to ferrite-carbide aggregates (flow tempering of bainite and isoforming)
Class III. Deformation after austenite transformation	
a.	Deformation of martensite followed by tempering
b.	Deformation of tempered martensite followed by aging (flow tempering, marstraining, strain tempering, tempforming, warm working)
c.	Deformation of isothermal transformation products (patenting, flow tempering, warm working)

SOURCE: Radcliffe Kula, Syracuse University Press, 1964.

### COMMERCIAL STEELS

The wide variety of applications of steel for engineering purposes is due to the range of mechanical properties obtainable by changes in carbon content and heat treatment. Some typical applications of carbon steels are given in Table 6.2.4. Carbon steels can be subdivided roughly into three groups: (1) low-carbon steel, 0.01 to 0.25 percent carbon, for use where only moderate strength is required together with considerable plasticity; (2) machinery steels, 0.30 to 0.55 percent carbon, which can be heat-treated to develop high strength; and (3) tool steels, containing from 0.60 to 1.30 percent carbon (this range also includes rail and spring steels).

**Table 6.2.4 Some Typical Applications of Carbon Steels**

Percent C	Uses
0.01–0.10	Sheet, strip, tubing, wire nails
0.10–0.20	Rivets, screws, parts to be case-hardened
0.20–0.35	Structural steel, plate, forgings such as camshafts
0.35–0.45	Machinery steel—shafts, axles, connecting rods, etc.
0.45–0.55	Large forgings—crankshafts, heavy-duty gears, etc.
0.60–0.70	Bolt-heading and drop-forging dies, rails, setscrews
0.70–0.80	Shear blades, cold chisels, hammers, pickaxes, band saws
0.80–0.90	Cutting and blanking punches and dies, rock drills, hand chisels
0.90–1.00	Springs, reamers, broaches, small punches, dies
1.00–1.10	Small springs and lathe, planer, shaper, and slotter tools
1.10–1.20	Twist drills, small taps, threading dies, cutlery, small lathe tools
1.20–1.30	Files, ball races, mandrels, drawing dies, razors

The importance of various types of steel products, as measured by

consumption over the last 20 years, is shown in Fig. 6.2.7. Of approximately 100,000,000 tons used annually, some 60 percent is now low-carbon sheet and strip, roughly equally divided between hot-rolled and cold-rolled. When bars (of all compositions), plates, and structurals are added (note the log scale), it is seen that the tonnages of all others are minor. However, some of the specialized forms of steel products are very important, and their capabilities are sometimes unique. Challenges frequently arise from newer nonmetallic materials; e.g., the use of oxide cutting tools to compete with high-service-temperature tool steels. The combination of property, performance, and price must be evaluated for each case.

The chemical compositions and mechanical and physical properties of many of the steels whose uses are listed in Table 6.2.4 are covered by specifications adopted by the American Society for Testing and Materials (ASTM), the Society of Automotive Engineers (SAE), and the American Society of Mechanical Engineers (ASME); other sources include government specifications for military procurement, national specifications in other industrial countries, and smaller specialized groups with their own interests in mind. The situation is more complex than necessary because of mixtures of chemical composition ranges and property and geometric ranges. Simplification will take a great deal of time to develop, and understanding among users, when and if it is reached, will require a major educational endeavor. For the time being, most of the important specifications and equivalents are shown in the ASM "Metals Handbook," 10th ed., vol. 1.

### Understanding Some Mechanical Properties of Steels

Before we give brief outlines of some of the more important classes of steels, a discussion of the important factors influencing selection of steels and an appreciation of those for relevant competitive materials may be helpful. The easy things to measure for a material, steel or otherwise, are chemical composition and a stress-strain curve, from which one can extract such familiar quantities as yield strength, tensile strength, and ductility expressed as elongation and reduction of area. Where the application is familiar and the requirements are not particularly crucial, this is still appropriate and, in fact, may be overkill; if the necessary properties are provided, the chemical composition can vary outside the specification with few or no ill effects. However, today's

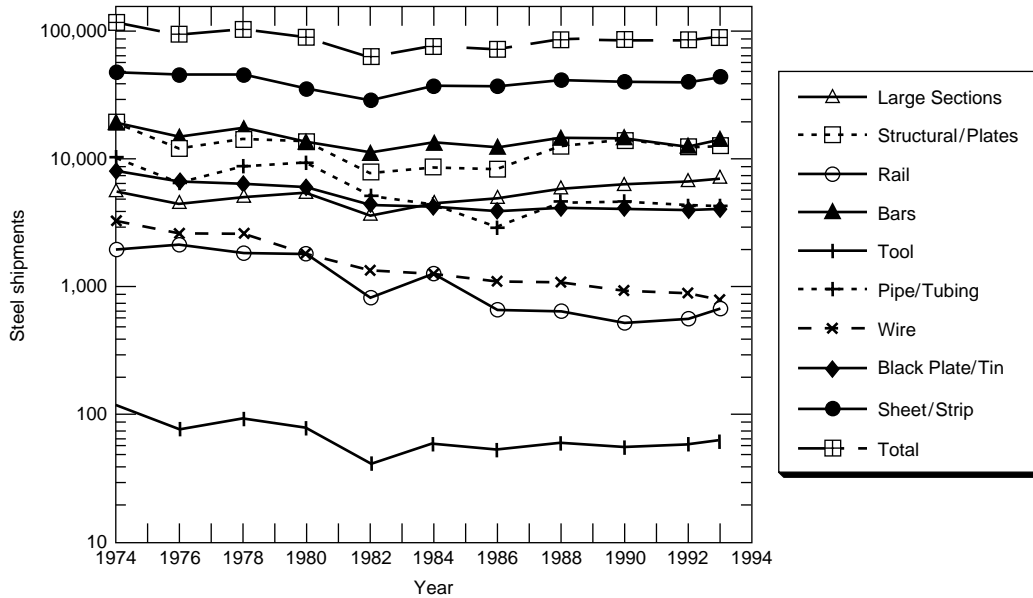

Fig. 6.2.7 Annual U.S. steel shipments, thousands of tons from 1974 to 1994.

designs emphasize total life-cycle cost and performance and often will require consideration of several other factors such as manufacturing and assembly methods; costs involving weldability (or more broadly joinability), formability, and machinability; corrosion resistance in various environments; fatigue, creep, and fracture; dimensional tolerances; and acceptable disposability at the end of the life cycle. These factors interact with each other in such complex ways that merely using tabulated data can invite disaster in extreme cases. It is not possible to cover all these issues in detail, but a survey of important factors for some of the most common ones may be helpful.

**Yield Strength** In technical terms the yield stress, which measures the onset of plastic deformation (for example, 0.1 or 0.2 percent permanent extension), occurs when significant numbers of “dislocations” move in the crystal lattice of the major phase present, usually some form of ferrite. Dislocations are line discontinuities in the lattice which allow crystal planes to slide over each other; they are always present at levels of  $10^4$  to  $10^6$  per square centimeter in undeformed metals, and this dislocation density can increase steadily to  $10^{10}$  to  $10^{12}$  per square centimeter after large deformations. Any feature which interferes with dislocation movement increases the yield stress. Such features include the following:

1. The lattice itself provides a lower limit (the **Peierls’ stress**) by

exhibiting an equivalent viscosity for movement. As a practical matter, this may be up to about 20 ksi (135 MPa) and is the same for all iron-based materials.

2. Dislocations need energy to cut through each other; thus, the stress necessary to continue deformation rises continuously as the dislocation density increases (work hardening). This is an important, inexpensive source of strength as various tempers are produced by rolling or drawing (see Table 6.2.5); it is accompanied by a significant loss of ductility.

3. Precipitates interfere with dislocation movement. The magnitude of interference depends sensitively on precipitate spacing, rising to a maximum at a spacing from 10 to 30 nm for practical additions. If a given heat treatment cannot develop these fine spacings (e.g., because the piece is so large that transformations take place at high temperatures), the strengthening is more limited. Precipitates are an important source of strength; martensite is used as an intermediate structure for carbon and alloy steels precisely because the precipitate spacing can be accurately controlled by tempering.

4. Small grain sizes, by interfering with the passage of dislocations across the boundaries, result in important increases in yield strength. To a very good approximation, the increase in yield is proportional to  $(\text{grain diameter})^{-1/2}$ . A change from ASTM 8 to 12, for example, increases the yield strength by about 100 MPa.

Table 6.2.5 Approximate Mechanical Properties for Various Tempers of Cold-Rolled Carbon Strip Steel

Temper	Tensile strength		Elongation in 50 mm or 2 in for 1.27-mm (0.050-in) thickness of strip, %	Remarks
	MPa	1,000 lb/in <sup>2</sup>		
No. 1 (hard)	621 ± 69	90 ± 10		A very stiff cold-rolled strip intended for flat blanking only, and not requiring ability to withstand cold forming
No. 2 (half-hard)	448 ± 69	65 ± 10	10 ± 6	A moderately stiff cold-rolled strip intended for limited bending
No. 3 (quarter-hard)	379 ± 69	55 ± 10	20 ± 7	A medium-soft cold-rolled strip intended for limited bending, shallow drawing, and stamping
No. 4 (skin-rolled)	331 ± 41	48 ± 6	32 ± 8	A soft ductile cold-rolled strip intended for deep drawing where no stretcher strains or fluting are permissible
No. 5 (dead-soft)	303 ± 41	44 ± 6	39 ± 6	A soft ductile cold-rolled strip intended for deep drawing where stretcher strains or fluting are permissible. Also for extrusions

SOURCE: ASTM A109. Complete specification should be consulted in ASTM Standards (latest edition).

5. Elements in solid solution also cause local lattice strains and make dislocation motion more difficult. The effect depends on the element; 1 percent P, for example, can double the hardness of iron or low-carbon steel. It is not used to this degree because of deleterious effects on toughness.

To a first approximation, these effects are additive; Fig. 6.2.8 depicts the effects of the iron lattice itself, solid solution strengthening, and grain size. Working the material would move all curves up the y axis by

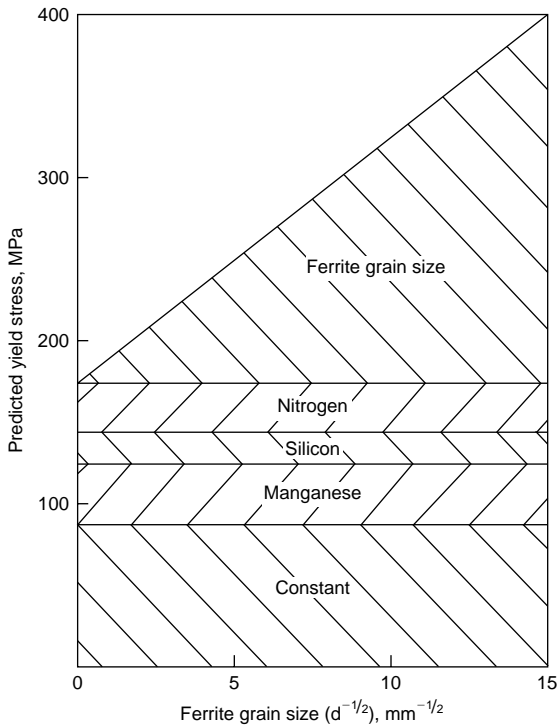

Fig. 6.2.8 The components of yield stress predicted for an air-cooled carbon-manganese steel containing 1.0 percent manganese, 0.25 percent silicon, and 0.01 percent nitrogen. (Source: Union Carbide Corp.; reproduced by permission.)

adding a work-hardening term. Figure 6.2.9 shows typical effects in an LAHS steel (see later) on the separated effects of manganese on yield strength. Manganese provides a little solid solution hardening and by its effect on ferrite grain size provides nonlinear strengthening. Figure 6.2.10 is a schematic of some combinations to obtain desired yield strengths and toughness simultaneously.

**Tensile Properties** Materials fail in tension when the increment of nominal stress from work hardening can no longer support the applied load on a decreasing diameter. The load passes through a maximum [the **ultimate tensile stress (UTS)**], and an instability (**necking**) sets in at that point. The triaxial stresses thus induced encourage the formation of internal voids nucleated at inclusions or, less commonly, at other particles such as precipitates. With increasing strain, these voids grow until they join and ultimately lead to a ductile failure.

Some plastic behavior of steels is sensitive to the number and type of inclusions. In a tensile test the UTS and **elongation to failure** are not affected much by increasing the number of inclusions (although the **uniform ductility** prior to necking is), but the **reduction in area** is; of greater importance, the energy absorbed to propagate a crack (related to the **fracture toughness**) is very sensitive to inclusion content. This relates directly to steelmaking practices, and to ladle metallurgy in particular, which has proved extremely effective in control of deleterious inclusions (not all inclusions are equally bad).

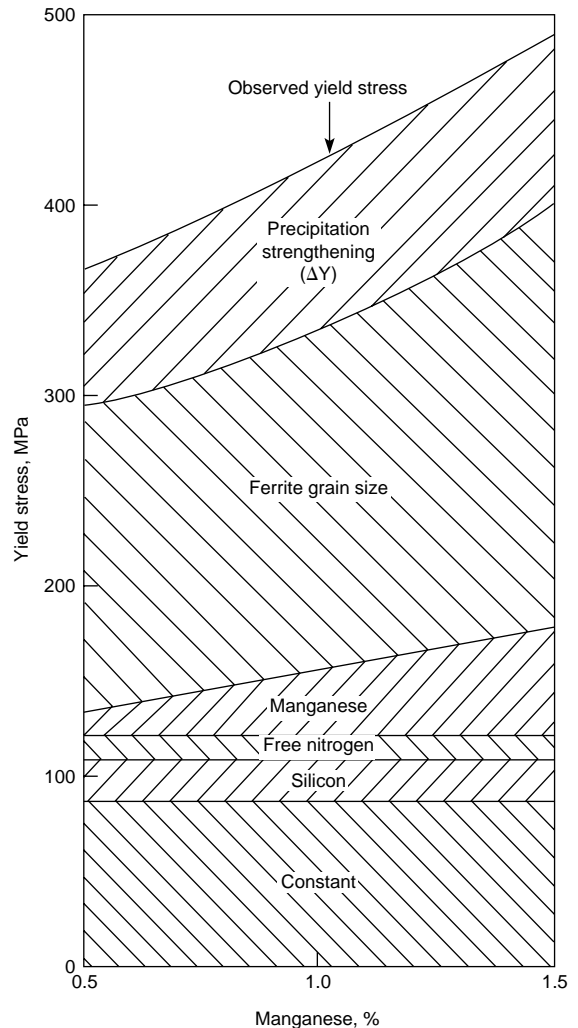

Fig. 6.2.9 The effect of increasing manganese content on the components of the yield stress of steels containing 0.2 percent carbon, 0.2 percent silicon, 0.15 percent vanadium, and 0.015 percent nitrogen, normalized from 900°C (1650°F). (Source: Union Carbide Corp.; reproduced by permission.)

**Toughness** A full treatment of this topic is not possible here, but we note the following:

1. As strength increases, toughness falls in all cases except where strengthening arises from grain-size reduction. Fine grain size thus is a double blessing; it will increase strength and toughness simultaneously.

2. The energy involved in crack growth depends on carbon content (Fig. 6.2.11). High-carbon materials have not only much lower propagation energies (e.g., the “shelf” in a Charpy test, or the value of  $K_{IC}$ ), but also higher **impact transition temperatures (ITTs)**. Below the ITT the energy for crack propagation becomes very small, and we may loosely describe the steel as “brittle.” There is, then, a real incentive to keep carbon in steel as low as possible, especially because pearlite does not increase the yield strength, but does increase the ITT, often to well above room temperature.

3. **Welding** is an important assembly technique. Since the hardenability of the steel can lead to generally undesirable martensite in the **heat-affected zone (HAZ)** and possibly to cracks in this region, the toughness of welds necessitates using steels with the lowest possible carbon



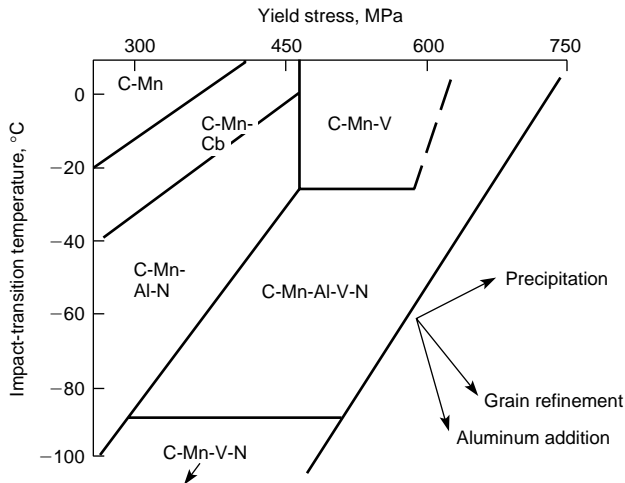

Fig. 6.2.10 Combinations of yield strength and impact transition temperature available in normalized high strength, low alloy (HSLA) steels. (Source: Union Carbide Corp.; reproduced by permission.)

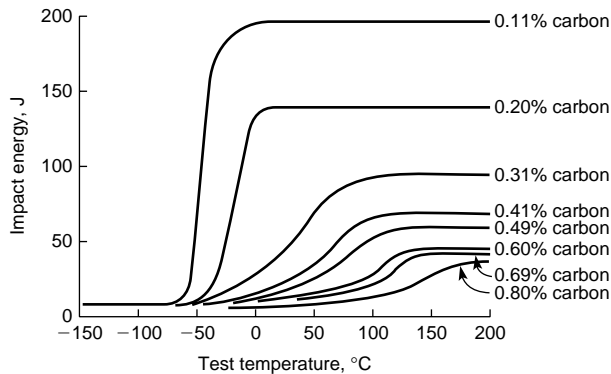

Fig. 6.2.11 The effect of carbon, and hence the pearlite content on impact transition temperature curves of ferrite-pearlite steels. (Source: Union Carbide Corp.; reproduced by permission.)

equivalent. **Carbon equivalent** is based on a formula which includes C and strong hardenability agents such as Mn, Ni, and Cr (see Sec. 6.3). Furthermore, the natural tendency of austenite to grow to a very coarse grain size near the weld metal may be desirably restrained by adding elements such as Ti, which as undissolved carbides, interfere with grain growth. In critical applications, finer grain sizes after transformation during cooling increase toughness in the HAZ.

Other mechanical properties such as fatigue strength, corrosion resistance, and formability are frequently important enough to warrant consideration, but too short a description here may be misleading; standard texts and/or professional journals and literature should be consulted when necessary.

Steel is not necessarily the only material of choice in today's competitive world. The issue revolves on the method to make a legitimate and rational choice between two or more materials with many different properties and characteristics. Consider a very simple example (see Ashby, "Materials Selection in Mechanical Design," Pergamon Press, Oxford).

A furniture designer conceives of a lightweight table—a flat sheet of toughened glass supported on slender unbraced cylindrical legs. The legs must be solid, as light as possible, and must support the tabletop

and whatever is placed on it without buckling. This involves consideration of the minimum weight and maximum aspect ratio of the legs. Examination of the mechanics shows that for minimum weight, we need a maximum value of the quantity  $M_1 = E^{1/2}/\rho$ , where  $E$  is Young's modulus and  $\rho$  is the density. For resistance to buckling, we need the maximum value of  $M_2 = E$ . If we plot  $E$  versus  $\rho$  of several materials, we can evaluate regions where both  $M_1$  and  $M_2$  are large. In doing so, we find attractive candidates are carbon-fiber-reinforced polymers (CFRPs) and certain engineering ceramics. They win out over wood, steel, and aluminum by their combination of high modulus and light weight. If we had other constraints such as cost, the CFRPs would be eliminated; as for toughness, the engineering ceramics would be unsuitable. Whenever many constraints must be satisfied simultaneously, their priority must be established. The net result is a compromise—but one which is better than an off-the-cuff guess!

This simple example can be generalized and used to develop a short list of very different alternatives in a reasonably quantitative and non-judgmental manner for a wide variety of necessary properties. Ashby (op. cit.) provides a large collection of data.

**Low-Carbon Steels** Of the many low-carbon-steel products, sheet and strip steels are becoming increasingly important. The consumption of steel in the sheet and tinplate industry has accounted for approximately 60 percent of the total steel production in the United States (Fig. 6.2.7). This large production has been made possible by refinement of continuous sheet and strip rolling mills. Applications in which large quantities of sheet are employed are tinplate for food containers; black, galvanized, and terne-coated sheets for building purposes; and high-quality sheets for automobiles, furniture, refrigerators, and countless other stamped, formed, and welded products. The difference between **sheet** and **strip** is based on width and is arbitrary. Cold working produces a better surface finish, improves the mechanical properties, and permits the rolling of thinner-gage material than hot rolling. Some hot-rolled products are sold as sheet or strip directly after coiling from the hot mill. Coils may be pickled and oiled for surface protection. Thicker coiled material up to 2 m (80 in) or more wide may be cut into plates, while thicker plates are produced directly from mills which may involve rolling a slab in two dimensions to produce widths approaching 5 m (200 in). Some plates are subject to heat treatment, occasionally elaborate, to produce particular combinations of properties for demanding applications. Structural (beams, angles, etc.) are also produced directly by hot rolling, normally without further heat treating. Bars with various cross sections are also hot-rolled; some may undergo further heat treatment depending on service requirements. Wire rods for further cold drawing are also hot-rolled.

Roughly one-half of the total hot-rolled sheet produced is cold-rolled further; the most demanding forming applications (automobiles and trucks, appliances, containers) require careful annealing, as discussed earlier. See Table 6.2.5.

Steels for deep-drawing applications must have a low yield strength and sufficient ductility for the intended purpose. This ductility arises from having a very small amount of interstitial atoms (carbon and nitrogen) in solution in the ferrite (**IF** or **interstitial-free** steels) and a sharp preferred orientation of the pancake-shaped ferrite grains. The procedures to obtain these are complex and go all the way back to steelmaking practices; they will not be discussed further here. They must also have a relatively fine grain size, since a large grain size will cause a rough finish, an "orange-peel" effect, on the deep drawn article. The sharp yield point characteristic of conventional low-carbon steel must be eliminated to prevent sudden local elongations in the sheet during forming, which result in strain marks called **stretcher strains** or **Lüders lines**. This can be done by cold working (Fig. 6.2.1), a reduction of only 1 percent in thickness usually being sufficient. This cold reduction is usually done by cold rolling, known as **temper rolling**, followed by alternate bending and reverse bending in a roller leveler. Temper rolling must always precede roller leveling because soft annealed sheets will "break" (yield locally) in the roller leveler. An important phenomenon in these temper-rolled low-carbon sheets is the return, partial or complete, of the sharp yield point after a period of

time. This is known as **aging** in steel. The return of the yield point is accompanied by an increase in hardness and a loss in ductility. While a little more expensive, IF steels do not display a yield point and would not really require temper rolling, although they normally receive about 0.25 percent to improve surface finish. (The 1 percent typically used for non-IF steels would cause harmful changes in the stress-strain curve.) With these options available, aging is no longer the problem it used to be.

High-strength hot-rolled, cold-rolled, and galvanized sheets are now available with specified yield strengths. By the use of small alloy additions of niobium, vanadium, and sometimes copper, it is possible to meet the requirements of ASTM A607-70 for hot-rolled and cold-rolled sheets—345 MPa (50,000 lb/in<sup>2</sup>) yield point, 483 MPa (70,000 lb/in<sup>2</sup>) tensile strength, and 22 percent elongation in 2 in. By further alloy additions, sheets are produced to a minimum of 448 MPa (65,000 lb/in<sup>2</sup>) yield point, 552 MPa (80,000 lb/in<sup>2</sup>) tensile strength, and 16 percent elongation in 2 in. The sheets are available in coil form and are used extensively for metallic buildings and for welding into tubes for construction of furniture, etc.

**Structural Carbon Steels** Bridges and buildings frequently are constructed with structural carbon steel meeting the requirements of ASTM A36 (Table 6.2.6). This steel has a minimum yield point of 248 MPa (36,000 lb/in<sup>2</sup>) and was developed to fill the need for a higher-strength structural carbon steel than the steels formerly covered by ASTM A7

and A373. The controlled composition of A36 steel provides good weldability and furnishes a significant improvement in the economics of steel construction. The structural carbon steels are available in the form of plates, shapes, sheet piling, and bars, all in the hot-rolled condition. A uniform strength over a range of section thickness is provided by adjusting the amount of carbon, manganese, and silicon in the A36 steel.

**High-Strength Low-Alloy Steels** These steels have in the past been referred to as “high-tensile steels” and “low-alloy steels,” but the name **high-strength low-alloy steels**, abbreviated **HSLA steels**, is now the generally accepted designation.

HSLA steels are a group of steels, intended for general structural and miscellaneous applications, that have minimum yield strengths above about 40,000 lb/in<sup>2</sup>. These steels typically contain small amounts of alloying elements to achieve their strength in the hot-rolled or normalized condition. Among the elements used in small amounts, singly or in combination, are niobium, titanium, vanadium, manganese, copper, and phosphorus. A complete listing of HSLA steels available from producers in the United States and Canada shows hundreds of brands or variations, many of which are not covered by ASTM or other specifications. Table 6.2.7 lists ASTM and SAE specifications that cover a large number of some common HSLA steels. These steels generally are available as sheet, strip, plates, bars, and shapes and often are sold as proprietary grades.

HSLA steels have characteristics and properties that result in econo-

**Table 6.2.6 Mechanical Properties of Some Constructional Steels\***

ASTM designation	Thickness range, mm (in)	Yield point, min		Tensile strength		Elongation in 200 mm (8 in) min, %	Suitable for welding?
		MPa	1,000 lb/in <sup>2</sup>	MPa	1,000 lb/in <sup>2</sup>		
Structural carbon-steel plates							
ASTM A36	To 100 mm (4 in), incl.	248	36	400–552	58–80	20	Yes
Low- and intermediate-tensile-strength carbon-steel plates							
ASTM A283	(structural quality)						
Grade A	All thicknesses	165	24	310	45	28	Yes
Grade B	All thicknesses	186	27	345	50	25	Yes
Grade C	All thicknesses	207	30	379	55	22	Yes
Grade D	All thicknesses	228	33	414	60	20	Yes
Carbon-silicon steel plates for machine parts and general construction							
ASTM A284							
Grade A	To 305 mm (12 in)	172	25	345	50	25	Yes
Grade B	To 305 mm (12 in)	159	23	379	55	23	Yes
Grade C	To 305 mm (12 in)	145	21	414	60	21	Yes
Grade D	To 200 mm (8 in)	145	21	414	60	21	Yes
Carbon-steel pressure-vessel plates							
ASTM A285							
Grade A	To 50 mm (2 in)	165	24	303–379	44–55	27	Yes
Grade B	To 50 mm (2 in)	186	27	345–414	50–60	25	Yes
Grade C	To 50 mm (2 in)	207	30	379–448	55–65	23	Yes
Structural steel for locomotives and railcars							
ASTM A113							
Grade A	All thicknesses	228	33	414–496	60–72	21	No
Grade B	All thicknesses	186	27	345–427	50–62	24	No
Grade C	All thicknesses	179	26	331–400	48–58	26	No
Structural steel for ships							
ASTM A131 (all grades)		221	32	400–490	58–71	21	No
Heat-treated constructional alloy-steel plates							
ASTM A514	To 64 mm (2½ in), incl.	700	100	800–950	115–135	18†	Yes
	Over 64 to 102 mm (2½ to 4 in), incl.	650	90	750–950	105–135	17†	Yes

\* See appropriate ASTM documents for properties of other plate steels, shapes, bars, wire, tubing, etc.

† Elongation in 50 mm (2 in), min.

Table 6.2.7 Specifications of ASTM and SAE for Some High-Strength Low-Alloy (HSLA) Steels

Society	Designation	Min yield point <sup>a</sup>		Min tensile strength		Min thickness <sup>b</sup>	
		MPa	1,000 lb/in <sup>2</sup>	MPa	1,000 lb/in <sup>2</sup>	mm	in
SAE	J410b grade 42X	290	42	414	60	9.5	3/8
ASTM	A572 grade 42	290	42	414	60	101.6	4
SAE	J410b grade 945X	310	45	414	60	9.5	3/8
ASTM	A572 grade 45	310	45	414	60	38.1	1 1/2
ASTM	A607 grade 45	310	45	414	60	<sup>c</sup>	<sup>c</sup>
ASTM	A606	310	45	448	65	<sup>c</sup>	<sup>c</sup>
SAE	J410b grades 945A, C <sup>d</sup>	310	45	448	65 <sup>e</sup>	12.7	1/2 <sup>f</sup>
SAE	J410b grade 950X	345	50	448	65	9.5	3/8
ASTM	A572 grade 50	345	50	448	65	38.1	1 1/2
ASTM	A607 grade 50	345	50	448	65	<sup>c</sup>	<sup>c</sup>
SAE	J410b grades 950A, B, C, D <sup>d</sup>	345	50	483	70	38.1	1 1/2 <sup>f</sup>
ASTM	A242	345	50	483	70	19.1	3/4 <sup>f</sup>
ASTM	A440 <sup>d</sup>	345	50	483	70	19.1	3/4 <sup>f</sup>
ASTM	A441	345	50	483	70	19.1	3/4 <sup>f</sup>
ASTM	A588	345	50	483	70	101.6	4 <sup>f</sup>
SAE	J410b grade 955X	379	55	483	70	9.5	3/8
ASTM	A572 grade 55	379	55	483	70	38.1	1 1/2
ASTM	A607 grade 55	378	55	483	70	<sup>c</sup>	<sup>c</sup>
SAE	J410b grade 960X	414	60	517	75	9.5	3/8
ASTM	A572 grade 60	414	60	517	75	25.4	1
ASTM	A607 grade 60	414	60	517	75	<sup>c</sup>	<sup>c</sup>
SAE	J410b grade 965X	448	65	552	80	9.5	3/8
ASTM	A572 grade 65	448	65	552	80	12.7	1/2
ASTM	A607 grade 65	448	65	552	80	<sup>c</sup>	<sup>c</sup>
SAE	J410b grade 970X	483	70	586	85	9.5	3/8
ASTM	A607 grade 70	483	70	586	85	<sup>c</sup>	<sup>c</sup>
SAE	J410b grade 980X	552	80	655	95	9.5	3/8

<sup>a</sup> SAE steels specify minimum yield strength.

<sup>b</sup> Applies to plates and bars, approximate web thickness for structurals.

<sup>c</sup> ASTM A606 and A607 apply to sheet and strip only.

<sup>d</sup> SAE J410b grades 945C and 950C and ASTM A440 steels are high-strength carbon-manganese steels rather than HSLA steels.

<sup>e</sup> Reduced 34.5 MPa (5,000 lb/in<sup>2</sup>) for sheet and strip.

<sup>f</sup> Available in heavier thickness at reduced strength levels.

mies to the user when the steels are properly applied. They are considerably stronger, and in many instances tougher, than structural carbon steel, yet have sufficient ductility, formability, and weldability to be fabricated successfully by customary shop methods. In addition, many of the steels have improved resistance to corrosion, so that the necessary equal service life in a thinner section or longer life in the same section is obtained in comparison with that of a structural carbon steel member. Good resistance to repeated loading and good abrasion resistance in service may be other characteristics of some of the steels. While high strength is a common characteristic of all HSLA steels, the other properties mentioned above may or may not be, singly or in combination, exhibited by any particular steel.

HSLA steels have found wide acceptance in many fields, among which are the construction of railroad cars, trucks, automobiles, trailers, and buses; welded steel bridges; television and power-transmission towers and lighting standards; columns in highrise buildings; portable liquefied petroleum gas containers; ship construction; oil storage tanks; air conditioning equipment; agricultural and earthmoving equipment.

**Dual-Phase Steels** The good properties of HSLA steels do not provide sufficient cold formability for automotive components which involve stretch forming. **Dual-phase steels** generate a microstructure of ferrite plus islands of austenite-martensite by quenching from a temperature between  $A_1$  and  $A_3$ . This leads to continuous yielding (rather than a sharp yield point) and a high work-hardening rate with a larger elongation to fracture. Modest forming strains can give a yield strength in the deformed product of 350 MPa (about 50 ksi), comparable to HSLA steels.

**Quenched and Tempered Low-Carbon Constructional Alloy Steels** These steels, having yield strengths at the 689-MPa (100,000-lb/in<sup>2</sup>) level, are covered by ASTM A514, by military specifications,

and for pressure-vessel applications, by ASME Code Case 1204. They are available in plates, shapes, and bars and are readily welded. Since they are heat-treated to a tempered martensitic structure, they retain excellent toughness at temperatures as low as  $-45^\circ\text{C}$  ( $-50^\circ\text{F}$ ). Major cost savings have been effected by using these steels in the construction of pressure vessels, in mining and earthmoving equipment, and for major members of large steel structures.

**Ultraservice Low-Carbon Alloy Steels (Quenched and Tempered)** The need for high-performance materials with higher strength-to-weight ratios for critical military needs, for hydrospace explorations, and for aerospace applications has led to the development of quenched and tempered ultraservice alloy steels. Although these steels are similar in many respects to the quenched and tempered low-carbon constructional alloy steels described above, their significantly higher notch toughness at yield strengths up to 965 MPa (140,000 lb/in<sup>2</sup>) distinguishes the ultraservice alloy steels from the constructional alloy steels. These steels are not included in the AISI-SAE classification of alloy steels. There are numerous proprietary grades of ultraservice steels in addition to those covered by ASTM designations A543 and A579. Ultraservice steels may be used in large welded structures subjected to unusually high loads, and must exhibit excellent weldability and toughness. In some applications, such as hydrospace operations, the steels must have high resistance to fatigue and corrosion (especially stress corrosion) as well.

**Maraging Steels** For performance requiring high strength and toughness and where cost is secondary, age-hardening low-carbon martensites have been developed based on the essentially carbon-free iron-nickel system. The as-quenched martensite is soft and can be shaped before an aging treatment. Two classes exist: (1) a nominal 18 percent nickel steel containing cobalt, molybdenum, and titanium with yield

strengths of 1,380 to 2,070 MPa (200 to 300 ksi) and an outstanding resistance to stress corrosion cracking (normally a major problem at these strengths) and (2) a nominal 12 percent nickel steel containing chromium, molybdenum, titanium, and aluminum adjusted to yield strengths of 1,034 to 1,379 MPa (150 to 200 ksi). The toughness of this series is the best available of any steel at these yield strengths.

**Cryogenic-Service Steels** For the economical construction of cryogenic vessels operating from room temperature down to the temperature of liquid nitrogen ( $-195^{\circ}\text{C}$  or  $-320^{\circ}\text{F}$ ) a 9 percent nickel alloy steel has been developed. The mechanical properties as specified by ASTM A353 are 517 MPa (75,000 lb/in<sup>2</sup>) minimum yield strength and 689 to 827 MPa (100,000 to 120,000 lb/in<sup>2</sup>) minimum tensile strength. The minimum Charpy impact requirement is 20.3 J (15 ft·lbf) at  $-195^{\circ}\text{C}$  ( $-320^{\circ}\text{F}$ ). For lower temperatures, it is necessary to use austenitic stainless steel.

**Machinery Steels** A large variety of carbon and alloy steels is used in the automotive and allied industries. Specifications are published by AISI and SAE on all types of steel, and these specifications should be referred to for detailed information.

A numerical index is used to identify the compositions of AISI (and SAE) steels. Most AISI and SAE alloy steels are made by the basic oxygen or basic electric furnace processes; a few steels that at one time were made in the electric furnace carry the prefix E before their number, i.e., E52100. However, with the almost complete use of ladle furnaces,

this distinction is rarely necessary today. Steels are “melted” in the BOP or EF and “made” in the ladle. A series of four numerals designates the composition of the AISI steels; the first two indicate the steel type, and the last two indicate, as far as feasible, the average carbon content in “points” or hundredths of 1 percent. Thus 1020 is a carbon steel with a carbon range of 0.18 to 0.23 percent, probably made in the basic oxygen furnace, and E4340 is a nickel-chromium molybdenum steel with 0.38 to 0.43 percent carbon made in the electric-arc furnace. The compositions for the standard steels are listed in Tables 6.2.8 and 6.2.9. A group of steels known as **H steels**, which are similar to the standard AISI steels, are being produced with a specified Jominy hardenability; these steels are identified by a suffix H added to the conventional series number. In general, these steels have a somewhat greater allowable variation in chemical composition but a smaller variation in hardenability than would be normal for a given grade of steel. This smaller variation in hardenability results in greater reproducibility of the mechanical properties of the steels on heat treatment; therefore, H steels have become increasingly important in machinery steels.

**Boron steels** are designated by the letter B inserted between the second and third digits, e.g., 50B44. The effectiveness of boron in increasing hardenability was a discovery of the late thirties, when it was noticed that heats treated with complex deoxidizers (containing boron) showed exceptionally good hardenability, high strength, and ductility after heat treatment. It was found that as little as 0.0005 percent of boron in-

Table 6.2.8 Chemical Composition of AISI Carbon Steels

AISI grade designation	Chemical composition limits (ladle analyses), %				AISI grade designation	Chemical composition limits (ladle analyses), %			
	C	Mn	P	S		C	Mn	P	S
1006	0.08 max	0.25–0.40	0.04 max	0.05 max	Resulturized (free-machining) steels*				
1008	0.10 max	0.30–0.50			1108	0.08–0.13	0.50–0.80	0.04 max	0.08–0.13
1010	0.08–0.13	0.30–0.60			1109	0.08–0.13	0.60–0.90		0.08–0.13
1012	0.10–0.15	0.30–0.60			1117	0.14–0.20	1.00–1.30		0.08–0.13
1015	0.13–0.18	0.30–0.60			1118	0.14–0.20	1.30–1.60		0.08–0.13
1016	0.13–0.18	0.60–0.90			1119	0.14–0.20	1.00–1.30		0.24–0.33
1017	0.15–0.20	0.30–0.60			1132	0.27–0.34	1.35–1.65		0.08–0.13
1018	0.15–0.20	0.60–0.90			1137	0.32–0.39	1.35–1.65		0.08–0.13
1019	0.15–0.20	0.70–1.00			1139	0.35–0.43	1.35–1.65		0.13–0.20
1020	0.18–0.23	0.30–0.60			1140	0.37–0.44	0.70–1.00		0.08–0.13
1021	0.18–0.23	0.60–0.90			1141	0.37–0.45	1.35–1.65		0.08–0.13
1022	0.18–0.23	0.70–1.00			1144	0.40–0.48	1.35–1.65		0.24–0.33
1023	0.20–0.25	0.30–0.60			1145	0.42–0.49	0.70–1.00		0.04–0.07
1025	0.22–0.28	0.30–0.60			1146	0.42–0.49	0.70–1.00		0.08–0.13
1026	0.22–0.28	0.60–0.90			1151	0.48–0.55	0.70–1.00		0.08–0.13
1030	0.28–0.34	0.60–0.90			Rephosphorized and resulturized (free-machining) steels*				
1035	0.32–0.38	0.60–0.90			1110	0.08–0.13	0.30–0.60	0.04 max	0.08–0.13
1037	0.32–0.38	0.70–1.00			1211	0.13 max	0.60–0.90	0.07–0.12	0.10–0.15
1038	0.35–0.42	0.60–0.90			1212	0.13 max	0.70–1.00	0.07–0.12	0.16–0.23
1039	0.37–0.44	0.70–1.00			1213	0.13 max	0.70–1.00	0.07–0.12	0.24–0.33
1040	0.37–0.44	0.60–0.90			1116	0.14–0.20	1.10–1.40	0.04 max	0.16–0.23
1042	0.40–0.47	0.60–0.90			1215	0.09 max	0.75–1.05	0.04–0.09	0.26–0.35
1043	0.40–0.47	0.70–1.00			12L14	0.15 max	0.85–1.15	0.04–0.09	0.26–0.35
1045	0.43–0.50	0.60–0.90			High-manganese carbon steels				
1046	0.43–0.50	0.70–0.90			1513	0.10–0.16	1.10–1.40	0.04 max	0.05 max
1049	0.46–0.53	0.60–0.90			1518	0.15–0.21	1.10–1.40		
1050	0.48–0.55	0.60–0.90			1522	0.18–0.24	1.10–1.40		
1055	0.50–0.60	0.60–0.90			1524	0.19–0.25	1.35–1.65		
1060	0.55–0.65	0.60–0.90			1525	0.23–0.29	0.80–1.10		
1064	0.60–0.70	0.50–0.80			1526	0.22–0.29	1.10–1.40		
1065	0.60–0.70	0.60–0.90			1527	0.22–0.29	1.20–1.50		
1070	0.65–0.75	0.60–0.90			1536	0.30–0.37	1.20–1.50		
1078	0.72–0.85	0.30–0.60			1541	0.36–0.44	1.35–1.65		
1080	0.75–0.88	0.60–0.90			1547	0.43–0.51	1.35–1.65		
1084	0.80–0.93	0.60–0.90			1548	0.44–0.52	1.10–1.40		
1086	0.80–0.93	0.30–0.50			1551	0.45–0.56	0.85–1.15		
1090	0.85–0.98	0.60–0.90			1552	0.47–0.55	1.20–1.50		
1095	0.90–1.03	0.30–0.50			1561	0.55–0.65	0.75–1.05		
					1566	0.60–0.71	0.85–1.15		
					1572	0.65–0.76	1.00–1.30		

Table 6.2.9 Alloy-Steel Compositions<sup>a,b,c,d</sup>

AISI no.	Chemical composition limits (ladle analyses), % <sup>c,d</sup>								
	C	Mn	P, max <sup>f</sup>	S, max <sup>f</sup>	Si	Ni	Cr	Mo	V
1330	0.28–0.33	1.60–1.90	0.035	0.040	0.20–0.35				
1335	0.33–0.38	1.60–1.90	0.035	0.040	0.20–0.35				
1340	0.38–0.43	1.60–1.90	0.035	0.040	0.20–0.35				
1345	0.43–0.48	1.60–1.90	0.035	0.040	0.20–0.35				
4012	0.09–0.14	0.75–1.00	0.035	0.040	0.20–0.35			0.15–0.25	
4023	0.20–0.25	0.70–0.90	0.035	0.040	0.20–0.35			0.20–0.30	
4024	0.20–0.25	0.70–0.90	0.035	0.035–0.050	0.20–0.35			0.20–0.30	
4027	0.25–0.30	0.70–0.90	0.035	0.040	0.20–0.35			0.20–0.30	
4028	0.25–0.30	0.70–0.90	0.035	0.035–0.050	0.20–0.35			0.20–0.30	
4037	0.35–0.40	0.70–0.90	0.035	0.040	0.20–0.35			0.20–0.30	
4047	0.45–0.50	0.70–0.90	0.035	0.040	0.20–0.35			0.20–0.30	
4118	0.18–0.23	0.70–0.90	0.035	0.040	0.20–0.35		0.40–0.60	0.08–0.15	
4130	0.28–0.33	0.40–0.60	0.035	0.040	0.20–0.35		0.80–1.10	0.15–0.25	
4137	0.35–0.40	0.70–0.90	0.035	0.040	0.20–0.35		0.80–1.10	0.15–0.25	
4140	0.38–0.43	0.75–1.00	0.035	0.040	0.20–0.35		0.80–1.10	0.15–0.25	
4142	0.40–0.45	0.75–1.00	0.035	0.040	0.20–0.35		0.80–1.10	0.15–0.25	
4145	0.43–0.48	0.75–1.00	0.035	0.040	0.20–0.35		0.80–1.10	0.15–0.25	
4147	0.45–0.50	0.75–1.00	0.035	0.040	0.20–0.35		0.80–1.10	0.15–0.25	
4150	0.48–0.53	0.75–1.00	0.035	0.040	0.20–0.35		0.80–1.10	0.15–0.25	
4320	0.17–0.22	0.45–0.65	0.035	0.040	0.20–0.35	1.65–2.00	0.40–0.60	0.20–0.30	
4340	0.38–0.43	0.60–0.80	0.035	0.040	0.20–0.35	1.65–2.00	0.70–0.90	0.20–0.30	
4419	0.18–0.23	0.45–0.65	0.035	0.040	0.20–0.35			0.45–0.60	
4615	0.13–0.18	0.45–0.65	0.035	0.040	0.20–0.35	1.65–2.00		0.20–0.30	
4620	0.17–0.22	0.45–0.65	0.035	0.040	0.20–0.35	1.65–2.00		0.20–0.30	
4621	0.18–0.23	0.70–0.90	0.035	0.040	0.20–0.35	1.65–2.00		0.20–0.30	
4626	0.24–0.29	0.45–0.65	0.035	0.040	0.20–0.35	0.70–1.00		0.15–0.25	
4718	0.16–0.21	0.70–0.90				0.90–1.20	0.35–0.55	0.30–0.40	
4720	0.17–0.22	0.50–0.70	0.035	0.040	0.20–0.35	0.90–1.20	0.35–0.55	0.15–0.25	
4815	0.13–0.18	0.40–0.60	0.035	0.040	0.20–0.35	3.25–3.75		0.20–0.30	
4817	0.15–0.20	0.40–0.60	0.035	0.040	0.20–0.35	3.25–3.75		0.20–0.30	
4820	0.18–0.23	0.50–0.70	0.035	0.040	0.20–0.35	3.25–3.75		0.20–0.30	
5015	0.12–0.17	0.30–0.50	0.035	0.040	0.20–0.35		0.30–0.50		
50B44 <sup>e</sup>	0.43–0.48	0.75–1.00	0.035	0.040	0.20–0.35		0.40–0.60		
50B46 <sup>e</sup>	0.44–0.49	0.75–1.00	0.035	0.040	0.20–0.35		0.20–0.35		
50B50 <sup>e</sup>	0.48–0.53	0.75–1.00	0.035	0.040	0.20–0.35		0.40–0.60		
50B60 <sup>e</sup>	0.56–0.64	0.75–1.00	0.035	0.040	0.20–0.35		0.40–0.60		
5120	0.17–0.22	0.70–0.90	0.035	0.040	0.20–0.35		0.70–0.90		
5130	0.28–0.33	0.70–0.90	0.035	0.040	0.20–0.35		0.80–1.10		
5132	0.30–0.35	0.60–0.80	0.035	0.040	0.20–0.35		0.75–1.00		
5135	0.33–0.38	0.60–0.80	0.035	0.040	0.20–0.35		0.80–1.05		
5145	0.43–0.48	0.70–0.90	0.035	0.040	0.20–0.35		0.70–0.90		
5147	0.46–0.51	0.70–0.95	0.035	0.040	0.20–0.35		0.85–1.15		
5150	0.48–0.53	0.70–0.90	0.035	0.040	0.20–0.35		0.70–0.90		
5155	0.51–0.59	0.70–0.90	0.035	0.040	0.20–0.35		0.70–0.90		
5160	0.56–0.64	0.75–1.00	0.035	0.040	0.20–0.35		0.70–0.90		
51B60 <sup>e</sup>	0.56–0.64	0.75–1.00	0.035	0.040	0.20–0.35		0.70–0.90		
51100 <sup>e</sup>	0.98–1.10	0.25–0.45	0.025	0.025	0.20–0.35		0.90–1.15		
52100 <sup>e</sup>	0.98–1.10	0.25–0.45	0.025	0.025	0.20–0.35		1.30–1.60		
6118	0.16–0.21	0.50–0.70	0.035	0.040	0.20–0.35		0.50–0.70		0.10–0.15
6150	0.48–0.53	0.70–0.90	0.035	0.040	0.20–0.35		0.80–1.10		0.15
81B45 <sup>e</sup>	0.43–0.48	0.75–1.00	0.035	0.040	0.20–0.35	0.20–0.40	0.35–0.55	0.08–0.15	
8615	0.13–0.18	0.70–0.90	0.035	0.040	0.20–0.35	0.40–0.70	0.40–0.60	0.15–0.25	
8617	0.15–0.20	0.70–0.90	0.035	0.040	0.20–0.35	0.40–0.70	0.40–0.60	0.15–0.25	
8620	0.18–0.23	0.70–0.90	0.035	0.040	0.20–0.35	0.40–0.70	0.40–0.60	0.15–0.25	
8622	0.20–0.25	0.70–0.90	0.035	0.040	0.20–0.35	0.40–0.70	0.40–0.60	0.15–0.25	
8625	0.23–0.28	0.70–0.90	0.035	0.040	0.20–0.35	0.40–0.70	0.40–0.60	0.15–0.25	
8627	0.25–0.30	0.70–0.90	0.035	0.040	0.20–0.35	0.40–0.70	0.40–0.60	0.15–0.25	
8630	0.28–0.33	0.70–0.90	0.035	0.040	0.20–0.35	0.40–0.70	0.40–0.60	0.15–0.25	
8637	0.35–0.40	0.75–1.00	0.035	0.040	0.20–0.35	0.40–0.70	0.40–0.60	0.15–0.25	
8640	0.38–0.43	0.75–1.00	0.035	0.040	0.20–0.35	0.40–0.70	0.40–0.60	0.15–0.25	
8642	0.40–0.45	0.75–1.00	0.035	0.040	0.20–0.35	0.40–0.70	0.40–0.60	0.15–0.25	
8645	0.43–0.48	0.75–1.00	0.035	0.040	0.20–0.35	0.40–0.70	0.40–0.60	0.15–0.25	
8655	0.51–0.59	0.75–1.00	0.035	0.040	0.20–0.35	0.40–0.70	0.40–0.60	0.15–0.25	
8720	0.18–0.23	0.70–0.90	0.035	0.040	0.20–0.35	0.40–0.70	0.40–0.60	0.20–0.30	
8740	0.38–0.43	0.75–1.00	0.035	0.040	0.20–0.35	0.40–0.70	0.40–0.60	0.20–0.30	

Table 6.2.9 Alloy-Steel Compositions<sup>a,b,c,d</sup> (Continued)

AISI no.	Chemical composition limits (ladle analyses), % <sup>c,d</sup>								
	C	Mn	P, max <sup>f</sup>	S, max <sup>f</sup>	Si	Ni	Cr	Mo	V
8822	0.20–0.25	0.75–1.00	0.035	0.040	0.20–0.35	0.40–0.70	0.40–0.60	0.30–0.40	
9255	0.51–0.59	0.70–0.95	0.035	0.040	1.80–2.20				
9260	0.56–0.64	0.75–1.00	0.035	0.040	1.80–2.20				
94B17 <sup>e</sup>	0.15–0.20	0.75–1.00	0.035	0.040	0.20–0.35	0.30–0.60	0.30–0.50	0.08–0.15	
94B30 <sup>e</sup>	0.28–0.33	0.75–1.00	0.035	0.040	0.20–0.35	0.30–0.60	0.30–0.50	0.08–0.15	

<sup>a</sup> These tables are subject to change from time to time, with new steels sometimes added, other steels eliminated, and compositions of retained steels occasionally altered. Current publications of AISI and SAE should be consulted for latest information.

<sup>b</sup> Applicable to blooms, billets, slabs, and hot-rolled and cold-rolled bars.

<sup>c</sup> These steels may be produced by the basic oxygen or basic electric steelmaking process.

<sup>d</sup> Small quantities of certain elements which are not specified or required may be found in alloy steels. These elements are considered to be incidental and are acceptable up to the following maximum amounts: copper to 0.35 percent, nickel to 0.25 percent, chromium to 0.20 percent, and molybdenum to 0.06 percent.

<sup>e</sup> Boron content is 0.0005 percent minimum.

<sup>f</sup> P max and S max can easily be much lower.

creased the hardenability of steels with 0.15 to 0.60 carbon, whereas boron contents of over 0.005 percent had an adverse effect on hot workability. Boron steels achieve special importance in times of alloy shortages, for they can replace such critical alloying elements as nickel, molybdenum, chromium, and manganese and, when properly heat-treated, possess physical properties comparable to the alloy grades they replace. Additional advantages for the use of boron in steels are a decrease in susceptibility to flaking, formation of less adherent scale, greater softness in the unhardened condition, and better machinability. It is also useful in low-carbon bainite and acicular ferrite steels.

Specific applications of these steels cannot be given, since the selection of a steel for a given part must depend upon an intimate knowledge of factors such as the availability and cost of the material, the detailed design of the part, and the severity of the service to be imposed. However, the mechanical properties desired in the part to be heat-treated will determine to a large extent the carbon and alloy content of the steel. Table 6.2.10 gives a résumé of mechanical properties that can be expected on heat-treating AISI steels, and Table 6.2.11 gives an indication of the effect of size on the mechanical properties of heat-treated steels.

The low-carbon AISI steels are used for carburized parts, cold-headed bolts and rivets, and for similar applications where high quality is required. The AISI 1100 series are low-carbon **free-cutting** steels for high-speed screw-machine stock and other machining purposes. These steels have high sulfur present in the steel in the form of manganese sulfide inclusions causing the chips to break short on machining. Manganese and phosphorus harden and embrittle the steel, which also contributes toward free machining. The high manganese contents are intended to ensure that all the sulfur is present as manganese sulfide. Lead was a common additive, but there are environmental problems; experiments have been conducted with selenium, tellurium, and bismuth as replacements.

**Cold-finished carbon-steel bars** are used for bolts, nuts, typewriter and cash register parts, motor and transmission power shafting, piston pins, bushings, oil-pump shafts and gears, etc. Representative mechanical properties of cold-drawn steel are given in Table 6.2.12. Besides improved mechanical properties, cold-finished steel has better machining properties than hot-rolled products. The surface finish and dimensional accuracy are also greatly improved by cold finishing.

**Forging steels**, at one time between 0.30 and 0.40 percent carbon and used for axles, bolts, pins, connecting rods, and similar applications, can now contain up to 0.7 percent C with microalloying additions to refine the structure (for better toughness) and to deliver precipitation strengthening. In some cases, air cooling can be used, thereby saving the cost of alloy steels. These steels are readily forged and, after heat treatment, develop considerably better mechanical properties than low-carbon steels. For heavy sections where high strength is required, such as in crankshafts and heavy-duty gears, the carbon may be increased and sufficient alloy content may be necessary to obtain the desired hardenability.

## TOOL STEELS

The application of tool steels can generally be fitted into one of the following categories or types of operations: cutting, shearing, forming, drawing, extruding, rolling, and battering. Each of these operations requires in the tool steel a particular physical property or a combination of such metallurgical characteristics as hardness, strength, toughness, wear resistance, and resistance to heat softening, before optimum performance can be realized. These considerations are of prime importance in tool selection; but hardenability, permissible distortion, surface decarburization during heat treatment, and machinability of the tool steel are a few of the additional factors to be weighed in reaching a final decision. In actual practice, the final selection of a tool steel represents a compromise of the most desirable physical properties with the best overall economic performance. Tool steels have been identified and classified by the SAE and the AISI into six major groups, based upon quenching methods, applications, special characteristics, and use in specific industries. These six classes are water-hardening, shock-resisting, cold-work, hot-work, high-speed, and special-purpose tool steels. A simplified classification of these six basic types and their subdivisions is given in Table 6.2.13.

**Water-hardening tool steels**, containing 0.60 to 1.40 percent carbon, are widely used because of their low cost, good toughness, and excellent machinability. They are shallow-hardening steels, unsuitable for nondeforming applications because of high warpage, and possess poor resistance to softening at elevated temperatures. Water-hardening tool steels have the widest applications of all major groups and are used for files, twist drills, shear knives, chisels, hammers, and forging dies.

**Shock-resisting tool steels**, with chromium-tungsten, silicon-molybdenum, or silicon-manganese as the dominant alloys, combine good hardenability with outstanding toughness. A tendency to distort easily is their greatest disadvantage. However, oil quenching can minimize this characteristic.

**Cold-work tool steels** are divided into three groups: oil-hardening, medium-alloy air-hardening, and high-carbon, high-chromium. In general, this class possesses high wear resistance and hardenability, develops little distortion, but at best is only average in toughness and in resistance to heat softening. Machinability ranges from good in the oil-hardening grade to poor in the high-carbon, high-chromium steels.

**Hot-work tool steels** are either chromium- or tungsten-based alloys possessing good nondeforming, hardenability, toughness, and resistance to heat-softening characteristics, with fair machinability and wear resistance. Either air or oil hardening can be employed. Applications are blanking, forming, extrusion, and casting dies where temperatures may rise to 540°C (1,000°F).

**High-speed tool steels**, the best-known tool steels, possess the best combination of all properties except toughness, which is not critical for high-speed cutting operations, and are either tungsten or molybdenum-base types. Cobalt is added in some cases to improve the cutting qualities in roughing operations. They retain considerable hardness at a

**Table 6.2.10 Mechanical Properties of Certain AISI Steels with Various Heat Treatments**  
Sections up to 40 mm (or 1/2 diam or thickness)

Tempering temp		Tensile strength		Yield point		Reduction of area, %	Elongation in 50 mm (2 in), %	Brinell hardness
°C	°F	MPa	1,000 lb/in <sup>2</sup>	MPa	1,000 lb/in <sup>2</sup>			
AISI 1040 quenched in water from 815°C (1,500°F)								
315	600	862	125	717	104	46	11	260
425	800	821	119	627	91	53	13	250
540	1,000	758	110	538	78	58	15	220
595	1,100	745	108	490	71	60	17	216
650	1,200	717	104	455	66	62	20	210
705	1,300	676	98	414	60	64	22	205
AISI 1340 normalized at 865°C (1,585°F), quenched in oil from 845°C (1,550°F)								
315	600	1,565	227	1,420	206	43	11	448
425	800	1,248	181	1,145	166	51	13	372
540	1,000	966	140	834	121	58	17.5	297
595	1,100	862	125	710	103	62	20	270
650	1,200	793	115	607	88	65	23	250
705	1,300	758	110	538	78	68	25.5	234
AISI 4042 normalized at 870°C (1,600°F), quenched in oil from 815°C (1,500°F)								
315	600	1,593	231	1,448	210	41	12	448
425	800	1,207	175	1,089	158	50	14	372
540	1,000	966	140	862	125	58	19	297
595	1,100	862	125	758	110	62	23	260
650	1,200	779	113	683	99	65	26	234
705	1,800	724	105	634	92	68	30	210

**Table 6.2.11 Effect of Size of Specimen on the Mechanical Properties of Some AISI Steels**

Diam of section		Tensile strength		Yield point		Reduction of area, %	Elongation in 50 mm (2 in), %	Brinell hardness
in	mm	MPa	1,000 lb/in <sup>2</sup>	MPa	1,000 lb/in <sup>2</sup>			
AISI 1040, water-quenched, tempered at 540°C (1,000°F)								
1	25	758	110	538	78	58	15	230
2	50	676	98	448	65	49	20	194
3	75	641	93	407	59	48	23	185
4	100	621	90	393	57	47	24.5	180
5	125	614	89	372	54	46	25	180
AISI 4140, oil-quenched, tempered at 540°C (1,000°F)								
1	25	1,000	145	883	128	56	18	297
2	50	986	143	802	125	58	19	297
3	75	945	137	814	118	59	20	283
4	100	869	126	758	110	60	18	270
5	125	841	122	724	105	59	17	260
AISI 8640, oil-quenched, tempered at 540°C (1,000°F)								
1	25	1,158	168	1,000	145	44	16	332
2	50	1,055	153	910	132	45	20	313
3	75	951	138	807	117	46	22	283
4	100	889	129	745	108	46	23	270
5	125	869	126	724	105	45	23	260

red heat. Very high heating temperatures are required for the heat treatment of high-speed steel and, in general, the tungsten-cobalt high-speed steels require higher quenching temperatures than the molybdenum steels. High-speed steel should be tempered at about 595°C (1,100°F) to increase the toughness; owing to a secondary hardening effect, the hardness of the tempered steels may be higher than as quenched.

**Special-purpose tool steels** are composed of the low-carbon, low-alloy, carbon-tungsten, mold, and other miscellaneous types.

**SPRING STEEL**

For small springs, steel is often supplied to spring manufacturers in a form that requires no heat treatment except perhaps a low-temperature anneal to relieve forming strains. Types of previously treated steel wire for small helical springs are **music wire** which has been given a special heat treatment called patenting and then cold-drawn to develop a high yield strength, **hard-drawn wire** which is of lower quality than music wire since it is usually made of lower-grade material and is seldom patented, and **oil-tempered wire** which has been quenched and tempered.

Table 6.2.12 Representative Average Mechanical Properties of Cold-Drawn Steel

AISI no.	Tensile strength		Yield strength		Elongation in 50 mm (2 in), %	Reduction of area, %	Brinell hardness
	MPa	1,000 lb/in <sup>2</sup>	MPa	1,000 lb/in <sup>2</sup>			
1010	462	67	379	55.0	25.0	57	137
1015	490	71	416	60.3	22.0	55	149
1020	517	75	439	63.7	20.0	52	156
1025	552	80	469	68.0	18.5	50	163
1030	600	87	509	73.9	17.5	48	179
1035	634	92	539	78.2	17.0	45	187
1040	669	97	568	82.4	16.0	40	197
1045	703	102	598	86.7	15.0	35	207
1117	552	80	469	68.0	19.0	51	163
1118	569	82.5	483	70.1	18.5	50	167
1137	724	105	615	89.2	16.0	35	217
1141	772	112	656	95.2	14.0	30	223

Sizes 16 to 50 mm (% to 2 in) diam, test specimens 50 × 13 mm (2 × 0.505 in).  
SOURCE: ASM "Metals Handbook."

Table 6.2.13 Simplified Tool-Steel Classification\*

Major grouping	Symbol	Types
Water-hardening tool steels	W	
Shock-resisting tool steels	S	
Cold-work tool steels	O	Oil hardening
	A	Medium-alloy air hardening
	D	High-carbon, high-chromium
Hot-work tool steels	H	H10–H19 chromium base
		H20–H39 tungsten base
		H40–H59 molybdenum base
High-speed tool steels	T	Tungsten base
	M	Molybdenum base
Special-purpose tool steels	F	Carbon-tungsten
	L	Low-alloy
	P	Mold steels P1–P19 low carbon P20–P39 other types

\* Each subdivision is further identified as to type by a suffix number which follows the letter symbol.

The wire usually has a Brinell hardness between 352 and 415, although this will depend on the application of the spring and the severity of the forming operation. Steel for small flat springs has either been cold-rolled or quenched and tempered to a similar hardness.

Steel for both helical and flat springs which is hardened and tempered after forming is usually supplied in an annealed condition. Plain carbon steel is satisfactory for small springs; for large springs it is necessary to use alloy steels such as chrome-vanadium or silicon-manganese steel in order to obtain a uniform structure throughout the cross section. Table 6.2.14 gives the chemical composition and heat treatment of several spring steels. It is especially important for springs that the surface of the steel be free from all defects and decarburization, which lowers fatigue strength.

## SPECIAL ALLOY STEELS

Many steel alloys with compositions tailored to specific requirements are reported periodically. Usually, the compositions and/or treatments are patented, and they are most likely to have registered trademarks and trade names. They are too numerous to be dealt with here in any great detail, but a few of the useful properties exhibited by some of those special alloys are mentioned.

Iron-silicon alloys with minimum amounts of both carbon and other alloying elements have been used by the electrical equipment industry for a long time; often these alloys are known as **electrical sheet steel**. Iron-nickel alloys with high proportions of nickel, and often with other alloying elements, elicit properties such as nonmagnetic behavior, high permeability, low hysteresis loss, low coefficient of expansion, etc.; iron-cobalt alloys combined with other alloying elements can result in materials with low resistivity and high hysteresis loss. The reader interested in the use of materials with some of these or other desired properties is directed to the extensive literature and data available.

## STAINLESS STEELS

by James D. Redmond

REFERENCES: "Design Guidelines for the Selection and Use of Stainless Steel," Specialty Steel Institute of North America (SSINA), Washington, DC. Publications of the Nickel Development Institute, Toronto, Ontario, Canada. "Metals Handbook," 10th ed., ASM International. ASTM Standards.

When the chromium content is increased to about 11 percent in an iron-chromium alloy, the resulting material is generally classified as a stainless steel. With that minimum quantity of chromium, a thin, protective, passive film forms spontaneously on the steel. This passive film acts as a barrier to prevent corrosion. Further increases in chromium content strengthen the passive film and enable it to repair itself if it is damaged in a corrosive environment. Stainless steels are also heat-resistant

Table 6.2.14 Type of Steel and Heat Treatment for Large Hot-Formed Flat, Leaf, and Helical Springs

AISI steel no.	Normalizing temp*		Quenching temp†		Tempering temp	
	°C	°F	°C	°F	°C	°F
1095	860–885	1,575–1,625	800–830	1,475–1,525	455–565	850–1,050
6150	870–900	1,600–1,650	870–900	1,600–1,650	455–565	850–1,050
9260	870–900	1,600–1,650	870–900	1,600–1,650	455–565	850–1,050
5150	870–900	1,600–1,650	800–830	1,475–1,525	455–565	850–1,050
8650	870–900	1,600–1,650	870–900	1,600–1,650	455–565	850–1,050

\* These normalizing temperatures should be used as the forming temperature whenever feasible.

† Quench in oil at 45 to 60°C (110 to 140°F).



because exposure to high temperatures (red heat and above) causes the formation of a tough oxide layer which retards further oxidation.

Other alloying elements are added to stainless steels to improve corrosion resistance in specific environments or to modify or optimize mechanical properties or characteristics. Nickel changes the crystal structure to improve ductility, toughness, and weldability. Nickel improves corrosion resistance in reducing environments such as sulfuric acid. Molybdenum increases pitting and crevice corrosion resistance in chloride environments. Carbon and nitrogen increase strength. Aluminum and silicon improve oxidation resistance. Sulfur and selenium are added to improve machinability. Titanium and niobium (columbium) are added to prevent sensitization by preferentially combining with carbon and nitrogen, thereby preventing intergranular corrosion.

**Stainless Steel Grades** There are more than 200 different grades of stainless steel. Each is alloyed to provide a combination of corrosion resistance, heat resistance, mechanical properties, or other specific characteristics. There are five families of stainless steels: austenitic, ferritic, duplex, martensitic, and precipitation hardening. Table 6.2.15 is a representative list of stainless steel grades by family and chemical composition as typically specified in ASTM Standards. The mechanical properties of many of these grades are summarized in Table 6.2.16. Note that the number designation of a stainless steel does not describe its performance when utilized to resist corrosion.

**Austenitic** stainless steels are the most widely used, and while most are designated in the 300 series, some of the highly alloyed grades, though austenitic, have other identifying grade designations, e.g., alloy 20, 904L, and the 6 percent molybdenum grades. These latter are often known by their proprietary designation. These stainless steel grades are available in virtually all wrought product forms, and many are employed as castings. Some austenitic grades in which manganese and nitrogen are substituted partially for nickel are also designated in the 200 series. Types 304 (18 Cr, 8 Ni) and 316 (17 Cr, 10 Ni, 2 Mo) are the workhorse grades, and they are utilized for a broad range of equipment and structures. Austenitic grades can be hardened by cold work but not by heat treatment; cold work increases strength with an accompanying decrease in ductility. They provide excellent corrosion resistance, respond very well to forming operations, and are readily welded. When fully annealed, they are not magnetic, but may become slightly magnetic when cold-worked. Compared to carbon steel, they have higher coefficients of thermal expansion and lower thermal conductivities. When austenitic grades are employed to resist corrosion, their performance may vary over a wide range, depending on the particular corrosive media encountered. As a general rule, increased levels of chromium, molybdenum, and nitrogen result in increased resistance to pitting and crevice corrosion in chloride environments. Type 304 is routinely used for atmospheric corrosion resistance and to handle low-chloride potable water. At the other end of the spectrum are the 6% Mo austenitic stainless steels, which have accumulated many years of service experience handling seawater in utility steam condensers and in piping systems on offshore oil and gas platforms. Highly alloyed austenitic stainless steels are subject to precipitation reactions in the range of 1,500 to 1,800°F (815 to 980°C), resulting in a reduction of their corrosion resistance and ambient-temperature impact toughness.

Low-carbon grades, or **L grades**, are restricted to very low levels of carbon (usually 0.030 wt % maximum) to reduce the possibility of sensitization due to chromium carbide formation either during welding or when exposed to a high-temperature thermal cycle. When a sensitized stainless steel is exposed subsequently to a corrosive environment, intergranular corrosion may occur. Other than improved resistance to intergranular corrosion, the low-carbon grades have the same resistance to pitting, crevice corrosion, and chloride stress corrosion cracking as the corresponding grade with the higher level of carbon (usually 0.080 wt % maximum).

There is a trend to dual-certify some pairs of stainless-steel grades. For example, an 18 Cr–8 Ni stainless steel low enough in carbon to meet the requirements of an L grade and high enough in strength to qualify as the standard carbon version may be **dual-certified**. ASTM specifications allow such a material to be certified and marked, for example, 304/304L and S30400/S30403.

**Ferritic stainless steels** are iron-chromium alloys with 11 to 30 percent chromium. They can be strengthened slightly by cold working. They are magnetic. They are difficult to produce in plate thicknesses, but are readily available in sheet and bar form. Some contain molybdenum for improved corrosion resistance in chloride environments. They exhibit excellent resistance to chloride stress corrosion cracking. Resistance to pitting and crevice corrosion is a function of the total chromium and molybdenum content. The coefficient of thermal expansion is similar to that of carbon steel. The largest quantity produced is Type 409 (11 Cr), used extensively for automobile catalytic converters, mufflers, and exhaust system components. The most highly alloyed ferritic stainless steels have a long service history in seawater-cooled utility condensers.

**Duplex stainless steels** combine some of the best features of the austenitic and the ferritic grades. Duplex stainless steels have excellent chloride stress corrosion cracking resistance and can be produced in the full range of product forms typical of the austenitic grades. Duplex stainless steels are comprised of approximately 50 percent ferrite and 50 percent austenite. They are magnetic. Their yield strength is about double that of the 300-series austenitic grades, so economies may be achieved from reduced piping and vessel wall thicknesses. The coefficient of thermal expansion of duplex stainless steels is similar to that of carbon steel and about 30 to 40 percent less than that of the austenitic grades. The general-purpose duplex grade is 2205 (22 Cr, 5 Ni, 3 Mo, 0.15 N). Because they suffer embrittlement with prolonged high-temperature exposure, ASME constructions using the duplex grades are limited to a maximum 600°F (315°C) service temperature. Duplex stainless steel names often reflect their chemical composition or are proprietary designations.

**Martensitic stainless steels** are straight chromium grades with relatively high levels of carbon. The martensitic grades can be strengthened by heat treatment. To achieve the best combination of strength, corrosion resistance, ductility, and impact toughness, they are tempered in the range of 300 to 700°F (150 to 370°C). They have a 400-series designation; 410 is the general-purpose grade. They are magnetic. The martensitic grades containing up to about 0.15 wt % carbon—e.g., grades 403, 410, and 416 (a free-machining version) can be hardened to about 45 RC. The high-carbon martensitics, such as Types 440A, B, and C, can be hardened to about 60 RC. The martensitics typically exhibit excellent wear or abrasion resistance but limited corrosion resistance. In most environments, the martensitic grades have less corrosion resistance than Type 304.

**Precipitation-hardening stainless steels** can be strengthened by a relatively low-temperature heat treatment. The low-temperature heat treatment minimizes distortion and oxidation associated with higher-temperature heat treatments. They can be heat-treated to strengths greater than can the martensitic grades. Most exhibit corrosion resistance superior to the martensitics and approach that of Type 304. While some precipitation-hardening stainless steels have a 600-series designation, they are most frequently known by names which suggest their chemical composition, for example, 17-4PH, or by proprietary names.

The commonly used stainless steels have been approved for use in ASME boiler and pressure vessel construction. Increasing the carbon content increases the maximum **allowable stress values**. Nitrogen additions are an even more powerful strengthening agent. This may be seen by comparing the allowable stresses for 304L (0.030 C maximum), 304H (0.040 C minimum), and 304N (0.10 N minimum) in Table 6.2.17. In general, increasing the total alloy content—especially chromium, molybdenum, and nitrogen—increases the allowable design stresses. However, precipitation reactions which can occur in the most highly alloyed grades limit their use to a maximum of about 750°F (400°C). The duplex grade 2205 has higher allowable stress values than even the most highly alloyed of the austenitic grades, up to a maximum service temperature of 600°F (315°C). The precipitation-hardening grades exhibit some of the highest allowable stress values but also are limited to about 650°F (345°C).

Copious amounts of information and other technical data regarding physical and mechanical properties, examples of applications and histories of service lives in specific corrosive environments, current costs, etc. are available in the references and elsewhere in the professional and trade literature.

Table 6.2.15 ASTM/AWS/AMS Chemical Composition (Wt. Pct.)<sup>a</sup>

UNS number	Grade	C	Cr	Ni	Mo	Cu	N	Other
Austenitic stainless steels								
S20100	201	0.15	16.00–18.00	3.50–5.50	— <sup>b</sup>	—	0.25	Mn: 5.50–7.50
S20200	202	0.15	17.00–19.00	4.00–6.00	—	—	0.25	Mn: 7.50–10.00
S30100	301	0.15	16.00–18.00	6.00–8.00	—	—	0.10	—
S30200	302	0.15	17.00–19.00	8.00–10.00	—	—	0.10	—
S30300	303	0.15	17.00–19.00	8.00–10.00	—	—	—	S: 0.15 min
S30323	303Se	0.15	17.00–19.00	8.00–10.00	—	—	—	Se: 0.15 min
S30400	304	0.08	18.00–20.00	8.00–10.50	—	—	0.10	—
S30403	304L	0.030	18.00–20.00	8.00–12.00	—	—	0.10	—
S30409	304H	0.04–0.10	18.00–20.00	8.00–10.50	—	—	—	—
S30451	304N	0.08	18.00–20.00	8.00–10.50	—	—	0.10–0.16	—
S30500	305	0.12	17.00–19.00	10.50–13.00	—	—	—	—
S30800	308	0.08	19.00–21.00	10.00–12.00	—	—	—	—
S30883	308L	0.03	19.50–22.00	9.00–11.00	0.05	0.75	—	Si: 0.39–0.65
S30908	309S	0.08	22.00–24.00	12.00–15.00	—	—	—	—
S31008	310S	0.08	24.00–26.00	19.00–22.00	—	—	—	—
S31600	316	0.08	16.00–18.00	10.00–14.00	2.00–3.00	—	0.10	—
S31603	316L	0.030	16.00–18.00	10.00–14.00	2.00–3.00	—	0.10	—
S31609	316H	0.04–0.10	16.00–18.00	10.00–14.00	2.00–3.00	—	0.10	—
S31703	317L	0.030	18.00–20.00	11.00–15.00	3.00–4.00	—	0.10	—
S31726	317LMN	0.030	17.00–20.00	13.50–17.50	4.0–5.0	—	0.10–0.20	—
S32100	321	0.080	17.00–19.00	9.00–12.00	—	—	0.10	Ti: 5(C + N) min; 0.70 max
S34700	347	0.080	17.00–19.00	9.00–13.00	—	—	—	Nb: 10C min; 1.00 max
N08020	Alloy 20	0.07	19.00–21.00	32.00–38.00	2.00–3.00	3.00–4.00	—	Nb + Ta: 8C min; 1.00 max
N08904	904L	0.020	19.00–23.00	23.00–28.00	4.0–5.0	1.0–2.0	0.10	—
S31254	254 SMQ <sup>c</sup>	0.020	19.50–20.50	17.50–18.50	6.00–6.50	0.50–1.00	0.18–0.22	—
N08367	AL-6XN <sup>d</sup>	0.030	20.00–22.00	23.50–25.50	6.00–7.00	0.75	0.18–0.25	—
N08926	25-6MO (3)/1925hMo <sup>e</sup>	0.020	19.00–21.00	24.00–26.00	6.0–7.0	0.5–1.0	0.15–0.25	—
S32654	654 SMO <sup>c</sup>	0.020	24.00–25.00	21.00–23.00	7.00–8.00	0.30–0.60	0.45–0.55	Mn: 2.00–4.00
Duplex stainless steels								
S31260	DP-3 <sup>e</sup>	0.030	24.0–26.0	5.50–7.50	2.50–3.50	0.20–0.80	0.10–0.30	W 0.10–0.50
S31803	2205	0.030	21.0–23.0	4.50–6.50	2.50–3.50	—	0.08–0.20	—
S32304	2304	0.030	21.5–24.5	3.00–5.00	0.05–0.60	0.05–0.60	0.05–0.20	—
S32550	Ferrallium 255 <sup>f</sup>	0.040	24.0–27.0	4.50–6.50	2.90–3.90	1.5–2.5	0.10–0.25	—
S32750	2507	0.030	24.0–26.0	6.00–8.00	3.00–5.00	0.50	0.24–0.32	—
S32900	329	0.08	23.00–28.00	2.50–5.00	1.00–2.00	—	—	—

Ferritic stainless steels								
S40500	405	0.08	11.50–14.50	0.60	—	—	—	Al: 0.10–0.30
S40900	409	0.08	10.50–11.75	0.50	—	—	—	Ti: 6xC min; 0.75 max
S43000	430	0.12	16.00–18.00	—	—	—	—	—
S43020	430F	0.12	16.00–18.00	—	—	—	—	S: 0.15 min
S43035	439	0.07	17.00–19.00	0.5	—	—	0.04	Ti: 0.20 + 4(C + N) min; 1.10 max Al: 0.15 max
S43400	434	0.12	16.00–18.00	—	0.75–1.25	—	—	—
S44400	444 (18 Cr–2 Mo)	0.025	17.5–19.5	1.00	1.75–2.50	—	0.035	Ti + Nb: 0.20 + 4(C + N) min; 0.80 max
S44600	446	0.20	23.00–27.50	—	—	—	0.25	—
S44627	E-BRITE 26-1 <sup>d</sup>	0.01	25.00–27.00	—	0.75–1.50	0.20	0.015	Nb: 0.05–0.20
S44660	SEA-CURE <sup>i</sup>	0.030	25.00–28.00	1.0–3.50	3.00–4.00	—	0.040	Ti + Nb: 0.20–1.00 and 6(C + N) min
S44735	AL 29-4C <sup>c</sup>	0.030	28.00–30.00	1.00	3.60–4.20	—	0.045	Ti + Nb: 0.20–1.00 and 6(C + N) min
Martensitic stainless steels								
S40300	403	0.15	11.50–13.50	—	—	—	—	—
S41000	410	0.15	11.50–13.50	0.75	—	—	—	—
S41008	410S	0.08	11.50–13.50	0.60	—	—	—	—
S41600	416	0.15	12.00–14.00	—	—	—	—	—
S41623	416Se	0.15	12.00–14.00	—	—	—	—	Se: 0.15 min
S42000	420	0.15 min	12.00–14.00	—	—	—	—	—
S42020	420F	0.08	12.00–14.00	0.50	—	0.60	—	S: 0.15 min
S43100	431	0.20	15.00–17.00	1.25–2.50	—	—	—	—
S44002	440A	0.60–0.75	16.00–18.00	—	0.75	—	—	—
S44003	440B	0.75–0.95	16.00–18.00	—	0.75	—	—	—
S44004	440C	0.95–1.20	16.00–18.00	—	0.75	—	—	—
S44020	440F	0.95–1.20	16.00–18.00	0.50	—	0.6	—	S: 0.15 min
Precipitation-hardening stainless steels								
S13800	XM-13/13-8Mo PH	0.05	12.25–13.25	7.50–8.50	2.00–2.50	—	0.01	Al: 0.90–1.35
S15700	632/15-7PH	0.09	14.00–16.00	6.50–7.75	2.00–3.00	—	—	Al: 0.75–1.00
S17400	630/17-4PH	0.07	15.00–17.50	3.00–5.00	—	3.00–5.00	—	Nb + Ta: 0.15–0.45
S17700	631/17-7PH	0.09	16.00–18.00	6.50–7.75	—	—	—	Al: 0.75–1.00
S35000	AMS 350	0.07–0.11	16.00–17.00	4.00–5.00	2.50–3.25	—	0.07–0.13	—
S35500	634/AMS 355	0.10–0.15	15.00–16.00	4.00–5.00	2.50–3.25	—	0.07–0.13	Mn: 0.50–1.25
S45000	XM-25/Custom 450 <sup>j</sup>	0.05	14.00–16.00	5.00–7.00	0.50–1.00	1.25–1.75	—	Nb: 8C min
S45500	XM-16/Custom 455 <sup>j</sup>	0.03	11.00–12.50	7.50–9.50	0.5	1.50–2.50	—	Ti: 0.90–1.40

<sup>a</sup> Maximum unless range or minimum is indicated.

<sup>b</sup> None required in the specification.

<sup>c</sup> Trademark of Avesta Sheffield AB.

<sup>d</sup> Trademark of Allegheny Ludlum Corp.

<sup>e</sup> Trademark of the INCO family of companies.

<sup>f</sup> Trademark of Krupp-VDM.

<sup>g</sup> Trademark of Sumitomo Metals.

<sup>h</sup> Trademark of Langley Alloys Ltd.

<sup>i</sup> Trademark of Crucible Materials Corp.

<sup>j</sup> Trademark of Carpenter Technology Corp.

Table 6.2.16 ASTM Mechanical Properties (A 240, A 276, A 479, A 564, A 582)

UNS no.	Grade	Condition*	Tensile strength, min		Yield strength, min		Elongation in 2 in or 50 mm min, %	Hardness, max	
			ksi	MPa	ksi	MPa		Brinell	Rockwell B†
Austenitic stainless steels									
S20100	201	Annealed	95	655	38	260	40.0	—‡	95
S20200	202	Annealed	90	620	38	260	40.0	241	—
S30100	301	Annealed	75	515	30	205	40.0	217	95
S30200	302	Annealed	75	515	30	205	40.0	201	92
S30300	303	Annealed	—	—	—	—	—	262	—
S30323	303Se	Annealed	—	—	—	—	—	262	—
S30400	304	Annealed	75	515	30	205	40.0	201	92
S30403	304L	Annealed	70	485	25	170	40.0	201	92
S30409	304H	Annealed	75	515	30	205	40.0	201	92
S30451	304N	Annealed	80	550	35	240	30.0	201	92
S30500	305	Annealed	75	515	30	205	40.0	183	88
S30908	309S	Annealed	75	515	30	205	40.0	217	95
S31008	310S	Annealed	75	515	30	205	40.0	217	95
S31600	316	Annealed	75	515	30	205	40.0	217	95
S31603	316L	Annealed	70	485	30	170	40.0	217	95
S31609	316H	Annealed	75	515	30	205	40.0	217	95
S31703	317L	Annealed	75	515	30	205	40.0	217	95
S31726	317LMN	Annealed	80	550	35	240	40.0	223	96
S32100	321	Annealed	75	515	30	205	40.0	217	95
S34700	347	Annealed	75	515	30	205	40.0	201	92
N08020	Alloy 20	Annealed	80	551	35	241	30.0	217	95
N08904	904L	Annealed	71	490	31	215	35.0	—	—
S31254	254 SMO	Annealed	94	650	44	300	—	223	96
N08367	AL-6XN	Annealed	95	655	45	310	30.0	233	—
N08926	25-6MO/1925hMo	Annealed	94	650	43	295	35.0	—	—
S32654	654 SMO	Annealed	109	750	62	430	40.0	250	—
Duplex stainless steels									
S31260	DP-3	Annealed	100	690	70	485	20.0	290	—
S31803	2205	Annealed	90	620	65	450	25.0	293	31HRC
S32304	2304	Annealed	87	600	58	400	25.0	290	32HRC
S32550	Ferrallium 255	Annealed	110	760	80	550	15.0	302	32HRC
S32750	2507	Annealed	116	795	80	550	15.0	310	32HRC
S32900	329	Annealed	90	620	70	485	15.0	269	28HRC
Ferritic stainless steels									
S40500	405	Annealed	60	415	25	170	20.0	179	88
S40900	409	Annealed	55	380	25	205	20.0	179	88
S43000	430	Annealed	65	450	30	205	22.0	183	89
S43020	430F	Annealed	—	—	—	—	—	262	—
S43035	439	Annealed	60	415	30	205	22.0	183	89
S43400	434	Annealed	65	450	35	240	22.0	—	—
S44400	444 (18 Cr–2 Mo)	Annealed	60	415	40	275	20.0	217	96
S44600	446	Annealed	65	515	40	275	20.0	217	96
S44627	E-BRITE 26-1	Annealed	65	450	40	275	22.0	187	90
S44660	SEA-CURE	Annealed	85	585	65	450	18.0	241	100
S44735	AL 29-4C	Annealed	80	550	60	415	18.0	255	25HRC
Martensitic stainless steels									
S40300	403	Annealed	70	485	40	275	20.0	223	—
S41000	410	Annealed	65	450	30	205	20.0	217	96
S41008	410S	Annealed	60	415	30	205	22.0	183	89
S41600	416	Annealed	—	—	—	—	—	262	—
S41623	416Se	Annealed	—	—	—	—	—	262	—
S42000	420	Annealed	—	—	—	—	—	241	—
S42020	420F	Annealed	—	—	—	—	—	262	—
S43100	431	Annealed	—	—	—	—	—	285	—
S44002	440A	Annealed	—	—	—	—	—	269	—
S44003	440B	Annealed	—	—	—	—	—	269	—
S44004	440C	Annealed	—	—	—	—	—	269	—
S44020	440F	Annealed	—	—	—	—	—	285	—

Table 6.2.16 ASTM Mechanical Properties (A 240, A 276, A 479, A 564, A 582) (Continued)

UNS no.	Grade	Condition*	Tensile strength, min		Yield strength, min		Elongation in 2 in or 50 mm min, %	Hardness, max		
			ksi	MPa	ksi	MPa		Brinell	Rockwell B†	
Precipitation-hardening stainless steels										
S13800	XM-13/13-8Mo PH	Annealed	—	—	—	—	—	363	38HRC	
		H950	220	1,520	205	1,410	10.0	430	45HRC	
		H1000	205	1,410	190	1,310	10.0	400	43HRC	
		H1050	175	1,210	165	1,140	12.0	372	40HRC	
		H1150	135	930	90	620	14.0	283	30HRC	
S15700	632/15-7PH	Annealed	—	—	—	—	—	269	100	
		RH950	200	1,380	175	1,210	7.0	415	—	
S17400	630/17-4PH	Annealed	—	—	—	—	—	363	38HRC	
		H900	190	1,310	170	1,170	10.0	388	40HRC	
		H925	170	1,170	155	1,070	10.0	375	38HRC	
		H1025	155	1,070	145	1,000	12.0	331	35HRC	
		H1100	140	965	115	795	14.0	302	31HRC	
S17700	631/17-7PH	Annealed	—	—	—	—	—	229	98	
		RH950	185	1,275	150	1,035	6.0	388	41HRC	
S35500	634/AMS 355	Annealed	—	—	—	—	—	363	—	
		H1000	170	1,170	155	1,070	12.0	341	37HRC	
S45000	XM-25/Custom 450	Annealed	130	895	95	655	10.0	321	32HRC	
		H900	180	1,240	170	1,170	10.0	363	39HRC	
		H950	170	1,170	160	1,100	10.0	341	37HRC	
		H1000	160	1,100	150	1,030	12.0	331	36HRC	
		H1100	130	895	105	725	16.0	285	30HRC	
S45500	XM-16/Custom 455	Annealed	—	—	—	—	—	331	36HRC	
		H900	235	1,620	220	1,520	8.0	444	47HRC	
		H950	220	1,520	205	1,410	10.0	415	44HRC	
		H1000	205	1,410	185	1,280	10.0	363	40HRC	

\* Condition defined in applicable ASTM specification.

† Rockwell B unless hardness Rockwell C (HRC) is indicated.

‡ None required in ASTM specifications.

Table 6.2.17 Maximum Allowable Stress Values (ksi), Plate: ASME Section I; Section III, Classes 2 and 3; Section VIII, Division 1

UNS no.	Grade	- 20 to 100°F	300°F	400°F	500°F	600°F	650°F	700°F	750°F	800°F	850°F	900°F
Austenitic stainless steels												
S30403	304L	16.7	12.8	11.7	10.9	10.3	10.5	10.0	9.8	9.7	—*	—
S30409	304H	18.8	14.1	12.9	12.1	11.4	11.2	11.1	10.8	10.6	10.4	10.2
S30451	304N	20.0	16.7	15.0	13.9	13.2	13.0	12.7	12.5	12.3	12.1	11.8
S31603	316L	16.7	12.7	11.7	10.9	10.4	10.2	10.0	9.8	9.6	9.4	—
N08904	904L	17.8	15.1	13.8	12.7	12.0	11.7	11.4	—	—	—	—
S31254	254 SMO	23.5	21.4	19.9	18.5	17.9	17.7	17.5	17.3	—	—	—
Duplex stainless steel												
S31803	2205	22.5	21.7	20.9	20.4	20.2	—	—	—	—	—	—
Ferritic stainless steels												
S40900	409	13.8	12.7	12.2	11.8	11.4	11.3	11.1	10.7	10.2	—	—
S43000	430	16.3	15.0	14.4	13.9	13.5	13.3	13.1	12.7	12.0	11.3	10.5
Precipitation-hardening stainless steel												
S17400	630/17-4	35.0	35.0	34.1	33.3	32.8	32.6	—	—	—	—	—

\* No allowable stress values at this temperature; material not recommended for service at this temperature.

## 6.3 IRON AND STEEL CASTINGS

by Malcolm Blair and Robert E. Eppich

REFERENCES: "Metals Handbook," ASM. "Iron Casting Handbook," Iron Casting Society. "Malleable Iron Castings," Malleable Founders' Society. ASTM Specifications. "Ductile Iron Handbook," American Foundrymen's Society. "Modern Casting," American Foundrymen's Society. "Ductile Iron Data for Design Engineers," Quebec Iron and Titanium (QIT). "History Cast in Metal," American Foundrymen's Society. "Steel Castings Handbook," 5th ed., Steel Founders' Society of America.

### CLASSIFICATION OF CASTINGS

**Cast-Iron Castings** The term **cast iron** covers a wide range of iron-carbon-silicon alloys containing from 2.0 to 4.0 percent carbon and from 0.5 to 3.0 percent silicon. The alloy typically also contains varying percentages of manganese, sulfur, and phosphorus along with other alloying elements such as chromium, molybdenum, copper, and titanium. For a type and grade of cast iron, these elements are specifically and closely controlled. Cast iron is classified into five basic types; each type is generally based on graphite morphology as follows:

- Gray iron
- Ductile iron
- Malleable iron
- Compacted graphite iron
- White iron

Even though chemistry is important to achieve the type of cast iron, the molten metal processing and cooling rates play major roles in developing each type. Different mechanical properties are generally associated with each of the five basic types of cast iron.

Figure 6.3.1 illustrates the range of carbon and silicon for each type.

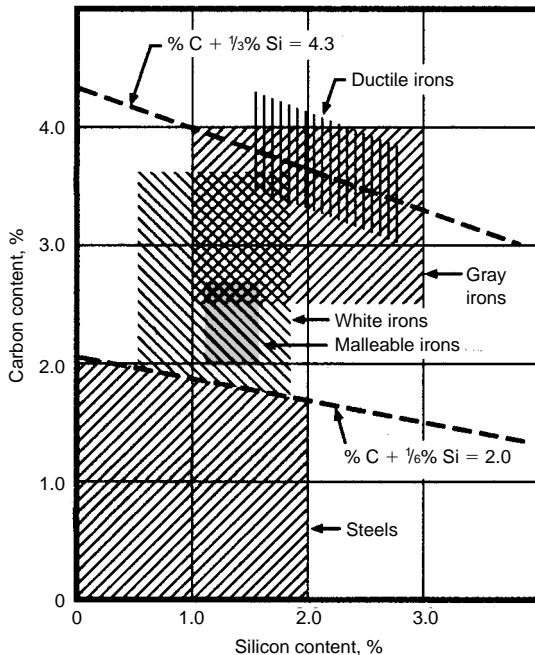

Fig. 6.3.1 Approximate ranges of carbon and silicon for steels and various cast irons. (QIT-Fer Titane, Inc.)

The chemistry for a specific grade within each type is usually up to the foundry producing the casting. There are situations where the chemistry for particular elements is specified by ASTM, SAE, and others; this should always be fully understood prior to procuring the casting.

**Steel Castings** There are two main classes of steel castings: carbon and low-alloy steel castings, and high-alloy steel castings. These classes may be broken down into the following groups: (1) **low-carbon steels** ( $C < 0.20$  percent), (2) **medium-carbon steels** ( $C$  between 0.20 and 0.50 percent), (3) **high-carbon steels** ( $C > 0.50$  percent), (4) **low-alloy steels** (total alloy  $\leq 8$  percent), and (5) **high-alloy steels** (total alloy  $> 8$  percent). The tensile strength of cast steel varies from 60,000 to 250,000 lb/in<sup>2</sup> (400 to 1,700 MPa) depending on the composition and heat treatment. Steel castings are produced weighing from ounces to over 200 tons. They find universal application where strength, toughness, and reliability are essential.

### CAST IRON

The engineering and physical properties of cast iron vary with the type of iron; the designer must match the engineering requirements with all the properties of the specific type of cast iron being considered. Machinability, e.g., is significantly affected by the type of cast iron specified. Gray cast iron is the most machinable; the white cast irons are the least machinable.

**Composition** The properties of cast iron are controlled primarily by the graphite morphology and the quantity of graphite. Also to be considered is the matrix microstructure, which may be established either during cooling from the molten state (as-cast condition) or as a result of heat treatment. Except where previous engineering evaluations have established the need for specific chemistry or the cast iron is to be produced to a specific ASTM specification, such that chemistry is a part of that specification, the foundry normally chooses the composition that will meet the specified mechanical properties and/or graphite morphology.

### Types of Cast Iron

**Gray Iron** Gray iron castings have been produced since the sixth century B.C. During solidification, when the composition and cooling rate are appropriate, carbon will precipitate in the form of graphite flakes that are interconnected within each eutectic cell. Figure 6.3.2 is a photomicrograph of a typical gray iron structure. The flakes appear black in the photograph. The sample is unetched; therefore the matrix microstructure does not show. Gray iron fractures primarily along the graphite. The fracture appears gray; hence the name *gray iron*. This graphite morphology establishes the mechanical properties. The cooling rate of the casting while it solidifies plays a major role in the size and shape of the graphite flakes. Thus the mechanical properties in a single casting can vary by as much as 10,000 lb/in<sup>2</sup> with thinner sections having higher strength (Fig. 6.3.3).

The flake graphite imparts unique characteristics to gray iron, such as excellent machinability, ability to resist galling, excellent wear resistance (provided the matrix microstructure is primarily pearlite), and excellent damping capacity. This same flake graphite exhibits essentially zero ductility and very low impact strength.

**Mechanical Properties** Gray iron tensile strength normally ranges from 20,000 to 60,000 lb/in<sup>2</sup> and is a function of chemistry, graphite morphology, and matrix microstructure. ASTM A48 recognizes nine grades based on the tensile strength of a separately cast test bar whose dimensions are selected to be compatible with the critical controlling section size of the casting. These dimensions are summarized in Table

6.3.1. Test bars are machined to the specified size prior to testing. Table 6.3.2 summarizes the various specifications under ASTM A48. Most engineering applications utilize gray iron with tensile strengths of 30,000 to 35,000 lb/in<sup>2</sup> (typically a B bar). An alternate method of specifying gray iron is to utilize SAE J431. This specification, shown in Table 6.3.3, is based on hardness (BHN) rather than tensile test bars.



Fig. 6.3.2 Gray iron with flake graphite. Unetched, 100×.

Yield strength is not normally shown and is not specified because it is not a well-defined property of the material. There is no abrupt change in the stress-strain relation as is normally observed in other material. A proof stress or load resulting in 0.1 percent permanent strain will range from 65 to 80 percent of the tensile strength.

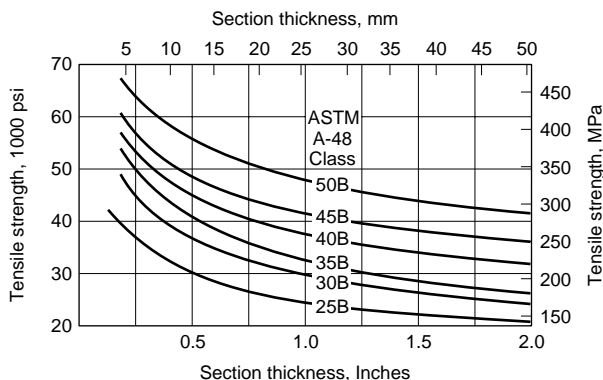

Fig. 6.3.3 The influence of casting section thickness on the tensile strength and hardness for a series of gray irons classified by their strength as cast in 1.2-in- (30-mm-) diameter, B bars. (Steel Founders Society of America.)

Table 6.3.4 summarizes the mechanical properties of gray iron as they are affected by a term called the **carbon equivalent**. Carbon equivalent is often represented by the equation

$$CE = \text{carbon (C)} + \frac{1}{3} \text{silicon (Si)} + \frac{1}{3} \text{phosphorus (P)}$$

Typical applications for gray iron are engine blocks, compressor housings, transmission cases, and valve bodies.

**Ductile Iron** Whereas gray iron has been used as an engineering material for hundreds of years, ductile iron was developed recently. It was invented in the late 1940s and patented by the International Nickel Company. By adding magnesium to the molten metal under controlled

Table 6.3.1 ASTM A48: Separately Cast Test Bars for Use when a Specific Correlation Has Not Been Established between Test Bar and Casting

Thickness of wall of controlling section of casting, in (mm)	Test bar diameter (See Table 6.3.2)
Under 0.25 (6)	S
0.25 to 0.50 (6 to 12)	A
0.51 to 1.00 (13 to 25)	B
1.01 to 2 (26 to 50)	C
Over 2 (50)	S

SOURCE: Abstracted from ASTM data, by permission.

conditions, the graphite structure becomes spherical or nodular. The material resulting has been variously named *spheroidal graphite iron*, *sg iron*, *nodular iron*, and *ductile iron*. **Ductile iron** is preferred since it also describes one of its characteristics. The structure is shown in Fig. 6.3.4. As would be expected, this nodular graphite structure, when compared to the graphite flakes in gray iron, shows significant improvement in mechanical properties. However, the machinability and thermal conductivity of ductile iron are lower than those for gray iron.

Table 6.3.2 ASTM A48: Requirements for Tensile Strength of Gray Cast Irons in Separately Cast Test Bars

Class no.	Tensile strength, min, ksi (MPa)	Nominal test bar diameter, in (mm)
20 A	20 (138)	0.88 (22.4)
20 B		1.2 (30.5)
20 C		2.0 (50.8)
20 S		Bars S*
25 A	25 (172)	0.88 (22.4)
25 B		1.2 (30.5)
25 C		2.0 (50.8)
25 S		Bars S*
30 A	30 (207)	0.88 (22.4)
30 B		1.2 (30.5)
30 C		2.0 (50.8)
30 S		Bars S*
35 A	35 (241)	0.88 (22.4)
35 B		1.2 (30.5)
35 C		2.0 (50.8)
35 S		Bars S*
40 A	40 (276)	0.88 (22.4)
40 B		1.2 (30.5)
40 C		2.0 (50.8)
40 S		Bars S*
45 A	45 (310)	0.88 (22.4)
45 B		1.2 (30.5)
45 C		2.0 (50.8)
45 S		Bars S*
50 A	50 (345)	0.88 (22.4)
50 B		1.2 (30.5)
50 C		2.0 (50.8)
50 S		Bars S*
55 A	55 (379)	0.88 (22.4)
55 B		1.2 (30.5)
55 C		2.0 (50.8)
55 S		Bars S*
60 A	60 (414)	0.88 (22.4)
60 B		1.2 (30.5)
60 C		2.0 (50.8)
60 S		Bars S*

\* All dimensions of test bar S shall be as agreed upon between the manufacturer and the purchaser.

SOURCE: Abstracted from ASTM data, by permission.

Table 6.3.3 SAE J431: Grades of Automotive Gray Iron Castings Designed by Brinell Hardness

SAE grade	Specified hardness BHN*	Minimum tensile strength (for design purposes)		Other requirements
		lb/in <sup>2</sup>	MPa	
G1800	187 max	18,000	124	
G2500	170–229	25,000	173	
G2500a†	170–229	25,000	173	3.4% min C and microstructure specified
G3000	187–241	30,000	207	
G3500	207–255	35,000	241	
G3500b†	207–255	35,000	241	3.4% min C and microstructure specified
G3500c†	207–255	35,000	241	3.5% min C and microstructure specified
G4000	217–269	40,000	276	

\* Hardness at a designated location on the castings.  
 † For applications such as brake drums, disks, and clutch plates to resist thermal shock.  
 SOURCE: Abstracted from SAE data, by permission.

The generally accepted grades of ductile iron are shown in Table 6.3.5, which summarizes ASTM A-536. In all grades the nodularity of the graphite remains the same. Thus the properties are controlled by the casting microstructure, which is influenced by both the chemistry and

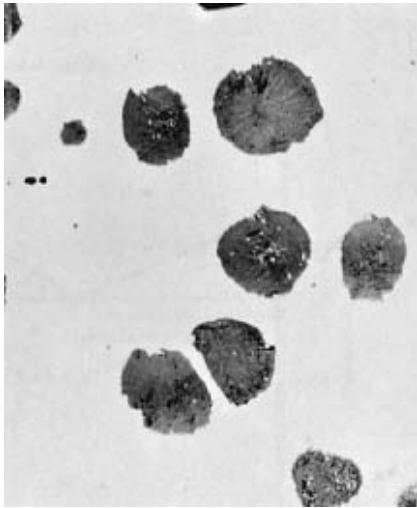

Fig. 6.3.4 Ductile iron with spherulitic graphite. Unetched, 100×.

the cooling rate after solidification. The grades exhibiting high elongation with associated lower tensile and yield properties can be produced as cast, but annealing is sometimes used to enhance these properties. Grades 60-40-18 and 60-45-12 have a ferrite microstructure. Both major elements (C and S) and minor elements (Mn, P, Cr, and others) are controlled at the foundry in order to achieve the specified properties.

Figure 6.3.5 illustrates the mechanical properties and impact strength as they are affected by temperature and test conditions.

An important new material within the nodular iron family has been developed within the last 20 years. This material, **austempered ductile iron (ADI)**, exhibits tensile strengths up to 230,000 lb/in<sup>2</sup>, but of greater significance is higher elongation, approximately 10 percent, compared to 2 percent for conventional ductile iron at equivalent tensile strength.

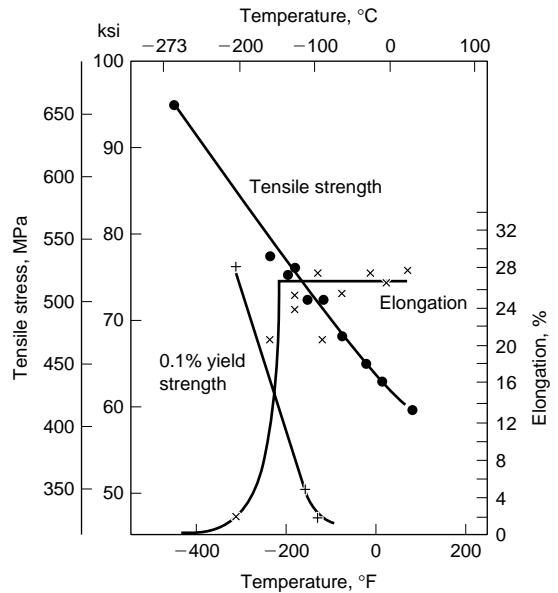

Fig. 6.3.5 Effect of temperature on low-temperature properties of ferritic ductile iron. (QIT-Fer Titane, Inc.)

Table 6.3.4 Effect of Carbon Equivalent on Mechanical Properties of Gray Cast Irons

Carbon equivalent	Tensile strength, lb/in <sup>2</sup> *	Modulus of elasticity in tension at 1/2 load, lb/in <sup>2</sup> × 10 <sup>6</sup> †	Modulus of rupture, lb/in <sup>2</sup> *	Deflection in 18-in span, in‡	Shear strength, lb/in <sup>2</sup> *	Endurance limit, lb/in <sup>2</sup> *	Compressive strength, lb/in <sup>2</sup> *	Brinell hardness, 3,000-kg load	Izod impact, unnotched, ft·lb
4.8	20,400	8.0	48,300	0.370	29,600	10,000	72,800	146	3.6
4.6	22,400	8.7	49,200	0.251	33,000	11,400	91,000	163	3.6
4.5	25,000	9.7	58,700	0.341	35,500	11,800	95,000	163	4.9
4.3	29,300	10.5	63,300	0.141	37,000	12,300	90,900	179	2.2
4.1	32,500	13.6	73,200	0.301	44,600	16,500	128,800	192	4.2
4.0	35,100	13.3	77,000	0.326	47,600	17,400	120,800	196	4.4
3.7	40,900	14.8	84,200	0.308	47,300	19,600	119,100	215	3.9
3.3	47,700	20.0	92,000	0.230	60,800	25,200	159,000	266	4.4

\* × 6.89 = kPa. † × 0.00689 = MPa. ‡ × 25.4 = mm.

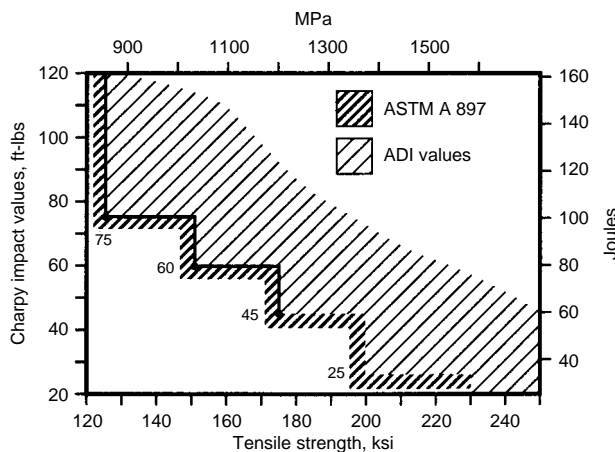

**Table 6.3.5 ASTM A536: Ductile Irons. Tensile Requirements**

	Grade 60-40-18	Grade 65-45-12	Grade 80-55-06	Grade 100-70-03	Grade 120-90-02
Tensile strength, min, lb/in <sup>2</sup>	60,000	65,000	80,000	100,000	120,000
Tensile strength, min, MPa	414	448	552	689	827
Yield strength, min, lb/in <sup>2</sup>	40,000	45,000	55,000	70,000	90,000
Yield strength, min, MPa	276	310	379	483	621
Elongation in 2 in or 50 mm, min, %	18	12	6.0	3.0	2.0

SOURCE: Abstracted from ASTM data, by permission.

The material retains the spherical graphite nodules characteristic of ductile iron, but the matrix microstructure of the heat-treated material now consists of acicular ferrite in a high-carbon austenite. Since 1990, ADI has been specified per ASTM 897. Properties associated with this specification are shown in Table 6.3.6 and are summarized in Fig. 6.3.6. Significant research has resulted in excellent documentation of other important properties such as fatigue resistance (Fig. 6.3.7), abrasion resistance (Fig. 6.3.8), and heat-treating response to specific compositions.



**Fig. 6.3.6** Austempered ductile iron mechanical properties. (QIT-Fer Titane, Inc.)

**Malleable Iron** Whiteheart malleable iron was invented in Europe in 1804. It was cast as white iron and heat-treated for many days, resulting in a material with many properties of steel. Blackheart malleable iron was invented in the United States by Seth Boyden. This material contains no free graphite in the as-cast condition, but when subjected to an extended annealing cycle (6 to 10 days), the graphite is present as irregularly shaped nodules called **temper carbon** (Fig. 6.3.9). All malleable iron castings produced currently are of blackheart malleable iron; the terms blackheart and whiteheart are obsolete.

The properties of several grades of malleable iron are shown in Table 6.3.7. The properties are similar to those of ductile iron, but the annealing cycles still range from 16 to 30 h. Production costs are higher than for ductile iron, so that virtually all new engineered products are designed to be of ductile iron. Malleable iron accounts for only 3 percent of total cast-iron production and is used mainly for pipe and electrical fittings and replacements for existing malleable-iron castings.

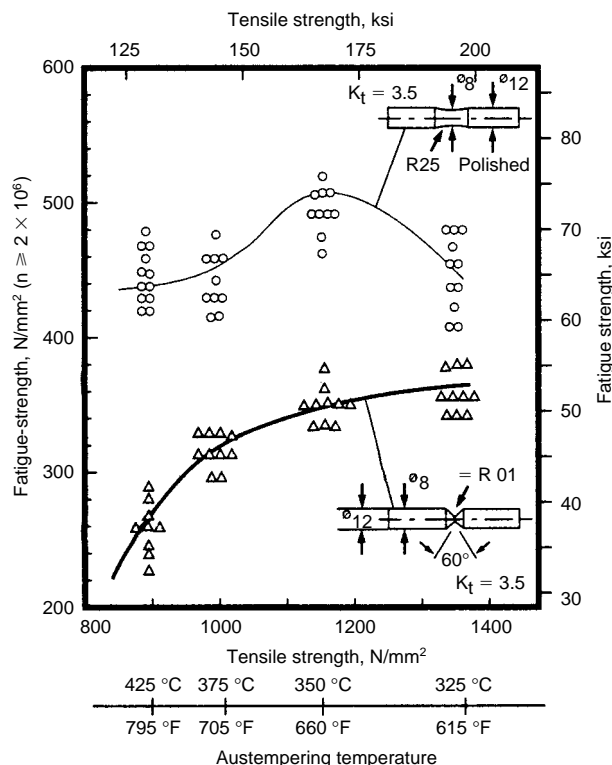

**Fig. 6.3.7** Fatigue properties of notched and unnotched ADI. (QIT-Fer Titane, Inc.)

**Table 6.3.6 ASTM A897: Austempered Ductile Irons. Mechanical Property Requirements**

	Grade 125/80/10	Grade 150/100/7	Grade 175/125/4	Grade 200/155/1	Grade 230/185/—
Tensile strength, min, ksi	125	150	175	200	230
Yield strength, min, ksi	80	100	125	155	185
Elongation in 2 in, min %	10	7	4	1	*
Impact energy, ft · lb†	75	60	45	25	*
Typical hardness, BHN, kg/mm <sup>2</sup> ‡	269–321	302–363	341–444	388–477	444–555

\* Elongation and impact requirements are not specified. Although grades 200/155/1 and 230/185/— are both primarily used for gear and wear resistance applications, Grade 200/155/1 has applications where some sacrifice in wear resistance is acceptable in order to provide a limited amount of ductility and toughness.

† Unnotched Charpy bars tested at 72 ± 7°F. The values in the table are a minimum for the average of the highest three test values of the four tested samples.

‡ Hardness is not mandatory and is shown for information only.

SOURCE: Abstracted from ASTM data, by permission.

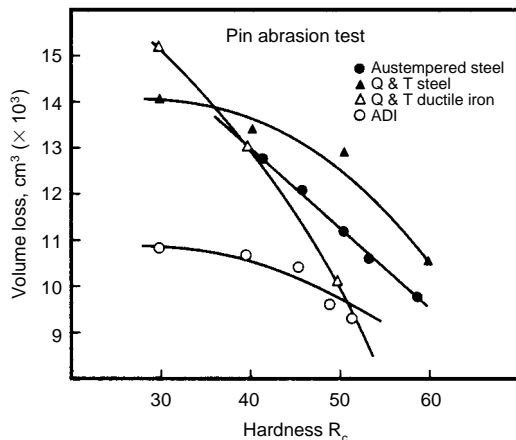

Fig. 6.3.8 Comparison of pin abrasion test results of ADI, ductile iron, and two abrasion-resistant steels. (QIT-Fer Titane, Inc.)

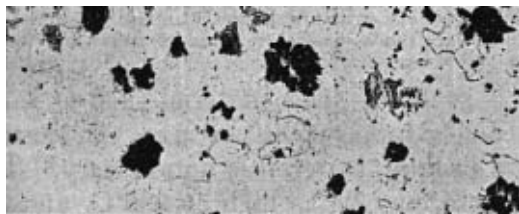

Fig. 6.3.9 Temper carbon form of graphite in malleable iron. Unetched, 100 $\times$ .

Table 6.3.7 SAE J158a: Malleable Irons. Mechanical Property Requirements

Grade	Casting hardness	Heat treatment
M 3210	156 BHN max.	Annealed
M 4504	163–217 BHN	Air-quenched and tempered
M 5003	187–241 BHN	Air-quenched and tempered
M 5503	187–241 BHN	Liquid-quenched and tempered
M 7002	229–269 BHN	Liquid-quenched and tempered
M 8501	269–302 BHN	Liquid-quenched and tempered

SOURCE: Abstracted from SAE data, by permission.

**Compacted Graphite Iron** Compacted graphite iron was developed in the mid-1970s. It is a controlled class of iron in which the graphite takes a form between that in gray iron and that in ductile iron. Figure 6.3.10 shows the typical graphite structure that is developed during casting. It was desired to produce a material that, without extensive alloying, would be stronger than the highest-strength grades of gray iron but would be more machinable than ductile iron. These objectives were met. The properties of the various grades of compacted iron are summarized in Table 6.3.8, which summarizes ASTM A842. Several other properties of this material should be considered. For example, its galling resistance is superior to that of ductile iron, and it is attractive for hydraulic applications; its thermal conductivity is superior to that of ductile iron but inferior to that of gray iron. Compacted graphite iron properties have resulted in its applications to satisfy a number of unique requirements.

**White Iron** When white iron solidifies, virtually all the carbon appears in the form of carbides. White irons are hard and brittle, and they break with a white fracture. These irons are usually alloyed with chromium and nickel; Table 6.3.9 summarizes ASTM A532. Their hardness is in the range of 500 to 600 BHN. The specific alloying that is required is a function of section size and application; there must be coordination

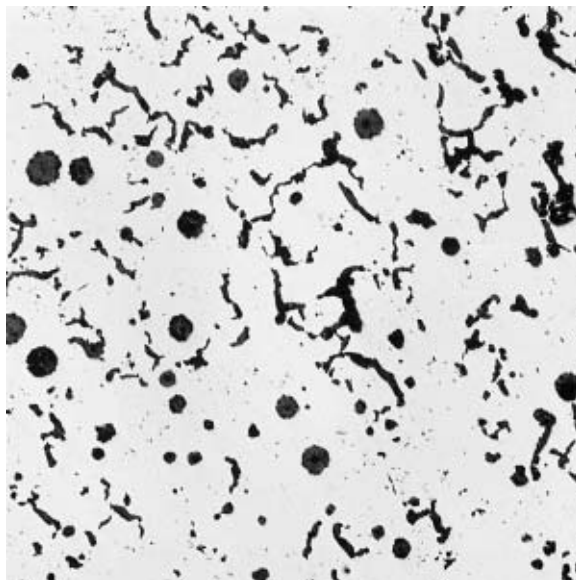

Fig. 6.3.10 Compacted graphite iron. Unetched, 100 $\times$ .

Table 6.3.8 ASTM A842: Compacted Graphite Irons. Mechanical Property Requirements

	Grade* 250	Grade 300	Grade 350	Grade 400	Grade† 450
Tensile strength, min, MPa	250	300	350	400	450
Yield strength, min, MPa	175	210	245	280	315
Elongation in 50 mm, min, %	3.0	1.5	1.0	1.0	1.0

\* The 250 grade is a ferritic grade. Heat treatment to attain required mechanical properties and microstructure shall be the option of the manufacturer.

† The 450 grade is a pearlitic grade usually produced without heat treatment with addition of certain alloys to promote pearlite as a major part of the matrix.

SOURCE: Abstracted from ASTM data, by permission.

between designer and foundry. These irons exhibit outstanding wear resistance and are used extensively in the mining industry for ballmill shell liners, balls, impellers, and slurry pumps.

**Specialty Irons** There are a number of highly alloyed gray and ductile iron grades of cast iron. These grades typically contain between 20 and 30 percent nickel along with other elements such as chromium and molybdenum. They have the graphite morphology characteristic of conventional gray or ductile iron, but alloying imparts significantly enhanced performance when wear resistance or corrosion resistance is required. Tables 6.3.10 and 6.3.11 summarize ASTM A436 for austenitic gray iron and ASTM A439 for austenitic ductile iron. This family of alloys is best known by its trade name *Ni-Resist*. Corrosion resistance of several of *Ni-Resist* alloys is summarized in Tables 6.3.12 and 6.3.13. Castings made from these alloys exhibit performance comparable to many stainless steels.

Several other specialty irons utilize silicon or aluminum as the major alloying elements. These also find specific application in corrosion or elevated-temperature environments.

#### Allowances for Iron Castings

Dimension allowances that must be applied in the production of castings arise from the fact that different metals contract at different rates during solidification and cooling. The shape of the part has a major influence on the as-cast dimensions of the casting. Some of the principal allowances are discussed briefly here.

**Table 6.3.9 ASTM A532: White Irons. Chemical Analysis Requirements**

Class	Type	Designation	Carbon	Manganese	Silicon	Nickel	Chromium	Molybdenum	Copper	Phosphorus	Sulfur
I	A	Ni-Cr-Hc	2.8–3.6	2.0 max	0.8 max	3.3–5.0	1.4–4.0	1.0 max	—	0.3 max	0.15 max
I	B	Ni-Cr-Lc	2.4–3.0	2.0 max	0.8 max	3.3–5.0	1.4–4.0	1.0 max	—	0.3 max	0.15 max
I	C	Ni-Cr-GB	2.5–3.7	2.0 max	0.8 max	4.0 max	1.0–2.5	1.0 max	—	0.3 max	0.15 max
I	D	Ni-HiCr	2.5–3.6	2.0 max	2.0 max	4.5–7.0	7.0–11.0	1.5 max	—	0.10 max	0.15 max
II	A	12% Cr	2.0–3.3	2.0 max	1.5 max	2.5 max	11.0–14.0	3.0 max	1.2 max	0.10 max	0.06 max
II	B	15% Cr-Mo	2.0–3.3	2.0 max	1.5 max	2.5 max	14.0–18.0	3.0 max	1.2 max	0.10 max	0.06 max
II	D	20% Cr-Mo	2.0–3.3	2.0 max	1.0–2.2	2.5 max	18.0–23.0	3.0 max	1.2 max	0.10 max	0.06 max
III	A	25% Cr	2.0–3.3	2.0 max	1.5 max	2.5 max	23.0–30.0	3.0 max	1.2 max	0.10 max	0.06 max

SOURCE: Abstracted from ASTM data, by permission.

**Table 6.3.10 ASTM A436: Austenitic Gray Irons. Chemical Analysis and Mechanical Property Requirements**

Element	Composition, %								
	Type 1	Type 1b	Type 2	Type 2b	Type 3	Type 4	Type 5	Type 6	
Carbon, total, max	3.00	3.00	3.00	3.00	2.60	2.60	2.40	3.00	
Silicon	1.00–2.80	1.00–2.80	1.00–2.80	1.00–2.80	1.00–2.00	5.00–6.00	1.00–2.00	1.50–2.50	
Manganese	0.5–1.5	0.5–1.5	0.5–1.5	0.5–1.5	0.5–1.5	0.5–1.5	0.5–1.5	0.5–1.5	
Nickel	13.50–17.50	13.50–17.50	18.00–22.00	18.00–22.00	28.00–32.00	29.00–32.00	34.00–36.00	18.00–22.00	
Copper	5.50–7.50	5.50–7.50	0.50 max	0.50 max	0.50 max	0.50 max	0.50 max	3.50–5.50	
Chromium	1.5–2.5	2.50–3.50	1.5–2.5	3.00–6.00*	2.50–3.50	4.50–5.50	0.10 max	1.00–2.00	
Sulfur, max	0.12	0.12	0.12	0.12	0.12	0.12	0.12	0.12	
Molybdenum, max	—	—	—	—	—	—	—	1.00	

Element	Mechanical Properties								
	Type 1	Type 1b	Type 2	Type 2b	Type 3	Type 4	Type 5	Type 6	
Tensile strength, min, ksi (MPa)	25 (172)	30 (207)	25 (172)	30 (207)	25 (172)	25 (172)	20 (138)	25 (172)	
Brinell hardness (3,000 kg)	131–183	149–212	118–174	171–248	118–159	149–212	99–124	124–174	

\* Where some matching is required, the 3.00 to 4.00 percent chromium range is recommended.  
 SOURCE: Abstracted from ASTM data, by permission.

**Table 6.3.11 ASTM A439: Austenitic Ductile Irons. Chemical Analysis and Mechanical Property Requirements**

Element	Type									
	D-2*	D-2B	D-2C	D-3*	D-3A	D-4	D-5	D-5B	D-5S	
Total carbon, max	3.00	3.00	2.90	2.60	2.60	2.60	2.40	2.40	2.30	
Silicon	1.50–3.00	1.50–3.00	1.00–3.00	1.00–2.80	1.00–2.80	5.00–6.00	1.00–2.80	1.00–2.80	4.90–5.50	
Manganese	0.70–1.25	0.70–1.25	1.80–2.40	1.00 max†	1.00 max†	1.00 max†	1.00 max†	1.00 max†	1.00 max	
Phosphorus, max	0.08	0.08	0.08	0.08	0.08	0.08	0.08	0.08	0.08	
Nickel	18.00–22.00	18.00–22.00	21.00–24.00	28.00–32.00	28.00–32.00	28.00–32.00	34.00–36.00	34.00–36.00	34.00–37.00	
Chromium	1.75–2.75	2.75–4.00	0.50 max†	2.50–3.50	1.00–1.50	4.50–5.50	0.10 max	2.00–3.00	1.75–2.25	

Element	Type									
	D-2	D-2B	D-2C	D-3	D-3A	D-4	D-5	D-5B	D-5S	
Tensile strength, min, ksi (MPa)	58 (400)	58 (400)	58 (400)	55 (379)	55 (379)	60 (414)	55 (379)	55 (379)	65 (449)	
Yield strength (0.2% offset), min, ksi (MPa)	30 (207)	30 (207)	28 (193)	30 (207)	30 (207)	—	30 (207)	30 (207)	30 (207)	
Elongation in 2 in or 50 mm, min, %	8.0	7.0	20.0	6.0	10.0	—	20.0	6.0	10	
Brinell hardness (3,000 kg)	139–202	148–211	121–171	139–202	131–193	202–273	131–185	139–193	131–193	

\* Additions of 0.7 to 1.0% of molybdenum will increase the mechanical properties above 800°F (425°C).  
 † Not intentionally added.  
 SOURCE: Abstracted from ASTM data, by permission.

**Shrinkage allowances** for iron castings are of the order of 1/8 in/ft (0.1 mm/cm). The indiscriminate adoption of this shrinkage allowance can lead to problems in iron casting dimensions. It is wise to discuss shrinkage allowances with the foundry that makes the castings before patterns are made.

**Castings finish allowances (unmachined)** and **machine finish allowances** are based on the longest dimension of the casting, although the weight of the casting may also influence these allowances. Other factors which affect allowances include pattern materials and the method of pattern construction. A useful guide is the international standard, ISO 8062 (Castings—System of Dimensional Tolerances and Machining Allowances). It is strongly recommended that designers discuss dimensional

and machine finish allowance requirements with the foundry to avoid unnecessary costs.

**STEEL CASTINGS**

**Composition** There are five classes of commercial steel castings: low-carbon steels (C < 0.20 percent), medium-carbon steels (C between 0.20 and 0.50 percent), high-carbon steels (C > 0.50 percent), low-alloy steels (total alloy ≤ 8 percent), and high-alloy steels (total alloy > 8 percent).

**Carbon Steel Castings** Carbon steel castings contain less than 1.00 percent C, along with other elements which may include Mn (0.50 to

Table 6.3.12 Corrosion Resistance of Ductile Ni-Resist Irons D-2 and D-2C

Corrosive media	Penetration, in/yr	
	Type D-2C	Type D-2
Ammonium chloride solution: 10% NH <sub>4</sub> Cl, pH 5.15, 13 days at 30°C (86°F), 6.25 ft/min	0.0280	0.0168
Ammonium sulfate solution: 10% (NH <sub>4</sub> ) <sub>2</sub> SO <sub>4</sub> , pH 5.7, 15 days at 30°C (86°F), 6.25 ft/min	0.0128	0.0111
Ethylene vapors & splash: 38% ethylene glycol, 50% diethylene glycol, 4.5% H <sub>2</sub> O, 4% Na <sub>2</sub> SO <sub>4</sub> , 2.7% NaCl, 0.8% Na <sub>2</sub> CO <sub>3</sub> + trace NaOH, pH 8 to 9, 85 days at 275–300°F	0.0023	0.0019*
Fertilizer: commercial "5-10-5", damp, 290 days at atmospheric temp	—	0.0012
Nickel chloride solution: 15% NiCl <sub>2</sub> , pH 5.3, 7 days at 30°C (86°F), 6.25 ft/min	0.0062	0.0040
Phosphoric acid, 86%, aerated at 30°C (86°F), velocity 16 ft/min, 12 days	0.213	0.235
Raw sodium chloride brine, 300 gpl of chlorides, 2.7 gpl CaO, 0.06 gpl NaOH, traces of NH <sub>3</sub> & H <sub>2</sub> S, pH 6–6.5, 61 days at 50°F, 0.1 to 0.2 fps	0.0023	0.0020*
Seawater at 26.6°C (80°F), velocity 27 ft/s, 60-day test	0.039	0.018
Soda & brine: 15.5% NaCl, 9.0% NaOH, 1.0% Na <sub>2</sub> SO <sub>4</sub> , 32 days at 180°F	0.0028	0.0015
Sodium bisulfate solution: 10% NaHSO <sub>4</sub> , pH 1.3, 13 days at 30°C (86°F), 6.25 ft/min	0.0431	0.0444
Sodium chloride solution: 5% NaCl, pH 5.6, 7 days at 30°C (86°F), 6.25 ft/min	0.0028	0.0019
Sodium hydroxide:		
50% NaOH + heavy conc. of suspended NaCl, 173 days at 55°C (131°F), 40 gal/min.	0.0002	0.0002
50% NaOH saturated with salt, 67 days at 95°C (203°F), 40 gal/min	0.0009	0.0006
50% NaOH, 10 days at 260°F, 4 days at 70°F	0.0048	0.0049
30% NaOH + heavy conc. of suspended NaCl, 82 days at 85°C (185°F)	0.0004	0.0005
74% NaOH, 19¼ days, at 260°F	0.005	0.0056
Sodium sulfate solution: 10% Na <sub>2</sub> SO <sub>4</sub> , pH 4.0, 7 days at 30°C (86°F), 6.25 ft/min	0.0136	0.0130
Sulfuric acid: 5%, at 30°C (86°F) aerated, velocity 14 ft/min, 4 days	0.120	0.104
Synthesis of sodium bicarbonate by Solvay process: 44% solid NaHCO <sub>3</sub> slurry plus 200 gpl NH <sub>4</sub> Cl, 100 gpl NH <sub>4</sub> HCO <sub>3</sub> , 80 gpl NaCl, 8 gpl NaHCO <sub>3</sub> , 40 gpl CO <sub>2</sub> , 64 days at 30°C (86°F)	0.0009	0.0003
Tap water aerated at 30°F, velocity 16 ft/min, 28 days	0.0015	0.0023
Vapor above ammonia liquor: 40% NH <sub>3</sub> , 9% CO <sub>2</sub> , 51% H <sub>2</sub> O, 109 days at 85°C (185°F), low velocity	0.011	0.025
Zinc chloride solution: 20% ZnCl <sub>2</sub> , pH 5.25, 13 days at 30°C (86°F), 6.25 ft/min	0.0125	0.0064

\*Contains 1% chromium.

SOURCE: QIT-Fer Titane, Inc.

Table 6.3.13 Oxidation Resistance of Ductile Ni-Resist, Ni-Resist, Conventional and High-Silicon Ductile Irons, and Type 309 Stainless Steel

Oxidation resistance	Penetration (in/yr)	
	Test 1	Test 2
	Ductile iron (2.5 Si)	0.042
Ductile iron (5.5 Si)	0.004	0.051
Ductile Ni-Resist type D-2	0.042	0.175
Ductile Ni-Resist type D-2C	0.07	—
Ductile Ni-Resist type D-4	0.004	0.0
Conventional Ni-Resist type 2	0.098	0.30
Type 309 stainless steel	0.0	0.0

Test 1—Furnace atmosphere—air, 4,000 h at 1,300°F.

Test 2—Furnace atmosphere—air, 600 h at 1,600–1,700°F, 600 h between 1,600–1,700°F, and 800–900°F, 600 h at 800–900°F.

SOURCE: QIT-Fer Titane, Inc.

1.00 percent), Si (0.20 to 0.70 percent), max P (0.05 percent), and max S (0.06 percent). In addition, carbon steels, regardless of whether they are cast or wrought, may contain small percentages of other elements as residuals from raw materials or additives incorporated in the steelmaking process.

**Low-Alloy Steel Castings** In a low-alloy steel casting, the alloying elements are present in percentages greater than the following: Mn, 1.00; Si, 0.70; Cu, 0.50; Cr, 0.25; Mo, 0.10; V, 0.05; W, 0.05; and Ti, 0.05. Limitations on phosphorus and sulfur contents apply to low-alloy steels as well as carbon steels unless they are specified to be different for the purpose of producing some desired effect, e.g., free machining. Carbon and low-alloy steels account for approximately 85 percent of the steel castings produced in the United States.

**High-Alloy Steel Castings** Steel castings with total alloy content greater than 8 percent are generally considered to be high-alloy, and usually the steel castings industry requires that the composition contain greater than 11 percent Cr. This Cr content requirement eliminates the potential confusion arising from including austenitic manganese steels

(Hadfield) in this group. High-alloy steels include corrosion-resistant, heat-resistant, and duplex stainless steels. Many of the cast corrosion-resistant and duplex stainless steels are similar to the wrought stainless steels, but their performance may not be the same. Table 6.3.14 lists cast high-alloy steels and similar wrought grades.

**Weight Range** Steel castings weigh from a few ounces to over 200 tons. Steel castings may be made in any thickness down to 0.25 in (6 mm), and in special processes a thickness of 0.080 in (2 mm) has been achieved. In investment castings, wall thicknesses of 0.060 in (1.5 mm) with sections tapering down to 0.030 in (0.75 mm) are common.

**Mechanical Properties** The outstanding mechanical properties of cast steel are high strength, ductility, resistance to impact, stiffness, endurance strength, and resistance to both high and low temperatures. It is also weldable. The mechanical properties of carbon steel castings are shown in Figs. 6.3.11 and 6.3.12; those of low-alloy cast steels are shown in Figs. 6.3.13 and 6.3.14.

**Tensile and Yield Strength** Ferritic steels of a given hardness or hardenability have the same tensile strength whether cast, wrought, or forged regardless of alloy content. For design purposes involving tensile and yield properties, cast, wrought, and forged properties are considered the same.

**Ductility** If the ductility values of steels are compared with the hardness values, the cast, wrought, and forged values are almost identical. The longitudinal properties of wrought and forged steels are slightly higher than those for castings. The transverse properties of the wrought and forged steels are lower, by an amount that depends on the degree of working. Since most service conditions involve several directions of loading, the isotropic behavior of cast steels is particularly advantageous (Fig. 6.3.15).

**Impact** The notched-bar impact test is used often as a measure of the toughness of materials. Cast steels have excellent impact properties at normal and low temperatures. Generally wrought steels are tested in the direction of rolling, show higher impact values than cast steels of similar composition. Transverse impact values will be 50 to 70 percent lower than these values. Cast steels do not show directional properties. If the directional properties are averaged for wrought steels, the values obtained are comparable to the values obtained for cast steels of similar

**Table 6.3.14 ACI Designations for Heat- and Corrosion-Resistant High-Alloy Castings**  
(See also Secs. 6.2 and 6.4.)

Cast desig	UNS	Wrought alloy type*	Cast desig	UNS	Wrought alloy type*
CA15	J91150	410†	CA15M	J91151	—
CA28MWV	J91422	422†	CA40	J91153	420†
CA6NM	J91540	F6NM†	CA6N	J91650	—
CB30	J91803	431†	CB7Cu-1	J92180	17-4§
CB7Cu-2	J92110	15-5§	CC50	J92615	446†
CD3MWCuN	J93380	—	CD4MCu	J93370	255§
CD3MN	J92205	2205§	CE3MN	J93404	—
CD6MN	J93371	—	CE8MN	J93345	—
CE30	J93423	—	CF8	J92600	304†
CF3	J92500	304L†	CF3M	J92800	316L†
CF10SMnN	J92972	Nitronic60‡*	CF8M	J92900	D319(316)†
CF20	J92602	302†	CF16F	J92701	303†
CF3MN	J92804	316LN†	CG8M	J93000	317†
CF8C	J92710	347†	CK20	J94202	310†
CG6MMN	J93790	Nitronic50‡	CN3MN	—	AL6XN‡ <sup>3</sup>
CG12	J93001	—	CN7MS	N02100	—
CH20	J93402	309†	CW2M	N26455	C4§
CK3MCuN	J93254	254SMO‡ <sup>2</sup>	CW6MC	N26625	625§
CN7M	N08007	—	CX2MW	N26022	C22§
CU5MCuC	—	825§	HA	—	—
CW6M	N30107	—	HD	—	327†
CW12MW	N30002	C§	HF	—	302B†
CY5SnBiM	N26055	—	HI	—	—
HC	—	446†	HL	—	—
HE	—	—	HP	—	—
HH	—	309†	HU	—	—
HK	—	310†	HX	—	—
HN	—	—	M30C	N24130	—
HT	—	330†	M35-1	N24135	400§
HW	—	—	N7M	N30007	B2§
M25S	N24025	—			
M30H	N24030	—			
M35-2	N04020	400§			
N12MV	N30012	B§			

\* Wrought alloy type references are listed only for the convenience of those who want corresponding wrought and cast grades. This table does not imply that the performance of the corresponding cast and wrought grades will be the same. Because the cast alloy chemical composition ranges are not the same as the wrought composition ranges, buyers should use cast alloy designations for proper identification of castings.

† Common description, formerly used by AISI.

‡ Proprietary trademark: †<sup>1</sup> Armco, Inc., †<sup>2</sup> Avesta Sheffield, †<sup>3</sup> Allegheny Ludlum Corp.

§ Common name used by two or more producers; not a trademark.

† ASTM designation.

NOTE: Most of the standard grades listed are covered for general applications by ASTM specifications.

SOURCE: *Steel Founders Society of America Handbook*, 5th ed.

composition. The **hardenability** of cast steels is influenced by composition and other variables in the same manner as the hardenability of wrought steels. The ratio of the **endurance limit** to the tensile strength for cast steel varies from 0.42 to 0.50, depending somewhat on the composition and heat treatment of the steel. The notch-fatigue ratio varies from 0.28 to 0.32 for cast steels and is the same for wrought steels (Fig. 6.3.16).

In **wear testing**, cast steels react similarly to wrought steels and give corresponding values depending on composition, structure, and hardness. Carbon cast steels of approximately 0.50 percent C and low-alloy cast steels of the chromium, chromium-molybdenum, nickel-chromium, chromium-vanadium, and medium-manganese types, all of which contain more than 0.40 percent C, exhibit excellent resistance to wear in service.

**Corrosion Resistance** Cast and wrought steels of similar composition and heat treatment appear to be equally resistant to corrosion in the same environments. Small amounts of copper in cast steels increase the resistance of the steel to atmospheric corrosion. High-alloy steels of chromium, chromium-nickel, and chromium-nickel-molybdenum types are normally used for corrosion service.

**Heat Resistance** Although not comparable to the high-alloy steels of the nickel-chromium types developed especially for heat resistance,

the 4.0 to 6.5 percent Cr cast steels, particularly with additions of 0.75 to 1.25 percent W, or 0.40 to 0.70 percent Mo, and 0.75 to 1.00 percent Ti, show good strength and considerable resistance to scaling up to 1,000°F (550°C).

Many cast high-alloy nickel-chromium steels have **creep and rupture** properties superior to those of wrought materials. In many cases wrought versions of the cast grades are not available due to hot-working difficulties. These cast materials may be used in service conditions up to 2,000°F (1,100°C), with some grades capable of withstanding temperatures of 2,200°F (1,200°C).

**Machinability** of carbon and alloy cast steels is comparable to that of wrought steels having equivalent strength, ductility, hardness, and similar microstructure. Factors influencing the machinability of cast steels are as follows: (1) Microstructure has a definite effect on machinability of cast steels. In some cases it is possible to improve machinability by as much as 100 to 200 percent through heat treatments which alter the microstructure. (2) Generally speaking, hardness alone cannot be taken as the criterion for predicting tool life in cutting cast steels. (3) In general, for a given structure, plain carbon steels machine better than alloy steels. (4) When machining cast carbon steel (1040) with carbides, tool life varies with the ratio of ferrite to pearlite in the microstructure of the casting, the 60:40 ratio resulting in optimum tool life.

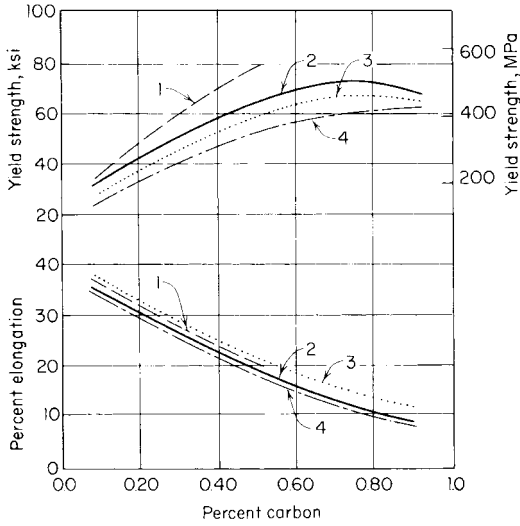

**Fig. 6.3.11** Yield strength and elongation versus carbon content for cast carbon steels. (1) Water quenched and tempered at 1,200°F; (2) normalized; (3) normalized and tempered at 1,200°F; (4) annealed.

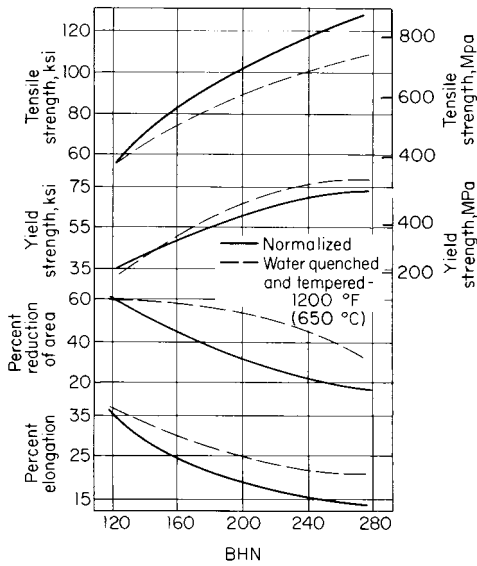
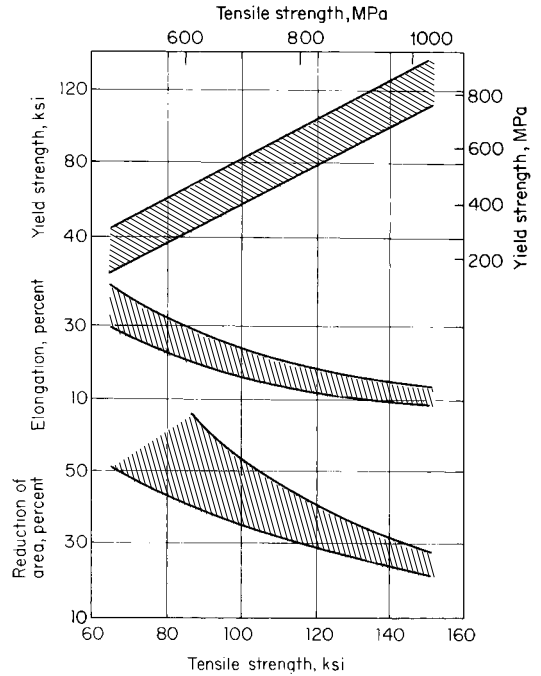

**Fig. 6.3.12** Tensile properties of carbon steel as a function of hardness.

For equal tool life, the skin of a steel casting should be machined at approximately one-half the cutting speed recommended for the base metal. The machinability of various carbon and low-alloy cast steels is given in Table 6.3.15.

**Welding** steel castings presents the same problems as welding wrought steels. It is interesting to note that cast low-alloy steels show greater resistance to underbead cracking than their wrought counterparts.

**Purchase Specifications for Steel Castings** Many steel castings are purchased according to mechanical property specifications, although more frequent use of specifications which indicate the use of steel castings may be more helpful. Note that it is now possible to order steel castings as cast equivalents of the SAE/AISI chemical composition



**Fig. 6.3.13** Properties of normalized and tempered low-alloy cast steels.

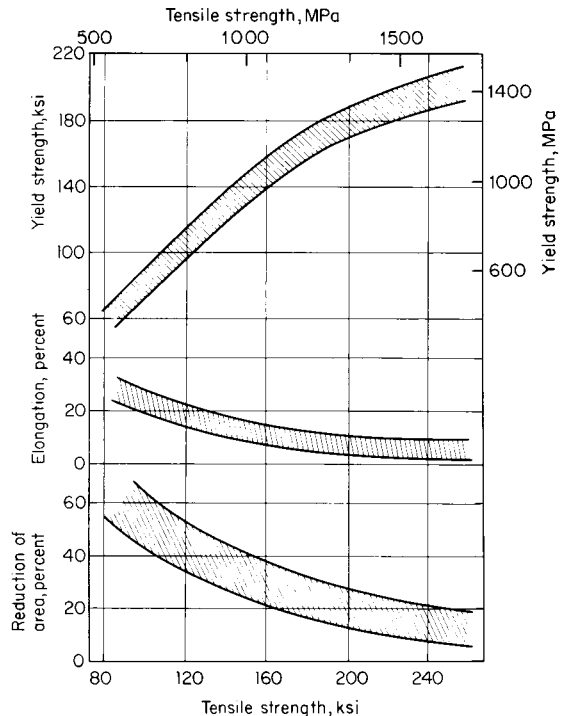

**Fig. 6.3.14** Properties of quenched and tempered low-alloy cast steels.

Table 6.3.15 Machinability Index for Cast Steels

Steel	BHN	Conventional		Metcut*	
		Carbide	HSS	HSS	Carbide
B1112 Free machining steel (wrought)	179	...	100		
1020 Annealed	122	10	90	160	400
1020 Normalized	134	6	75	135	230
1040 Double normalized	185	11	70	130	400
1040 Normalized and annealed	175	10	75	135	380
1040 Normalized	190	6	65	120	325
1040 Normalized and oil-quenched	225	6	45	80	310
1330 Normalized	187	2	40	75	140
1330 Normalized and tempered	160	3	65	120	230
4130 Annealed	175	4	55	95	260
4130 Normalized and spheroidized	175	3	50	90	200
4340 Normalized and annealed	200	3	35	60	210
4340 Normalized and spheroidized	210	6	55	95	290
4340 Quenched and tempered	300	2	25	45	200
4340 Quenched and tempered	400	1/2	20	35	180
8430 Normalized and tempered at 1,200°F (660°C)	200	3	50	90	200
8430 Normalized and tempered at 1,275°F (702°C)	180	4	60	110	240
8630 Normalized	240	2	40	75	180
8630 Annealed	175	5	65	120	290

\* The Metcut speed index number is the actual cutting speed (surface ft/min) which will give 1 h tool life in turning.

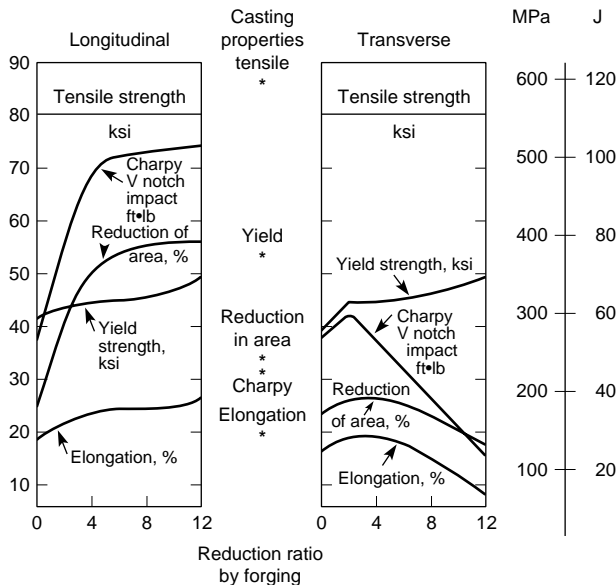

Fig. 6.3.15 Influence of forging reduction on anisotropy for a 0.35 percent carbon wrought steel. Properties for a cast of 0.35 percent carbon steel are shown with an asterisk for comparison purposes. (Steel Foundry Society of America Handbook, 5th ed.)

ranges using ASTM A915. It is preferable to order steel castings to conform with national standards such as ASTM. ASTM standards are prepared by purchasers and suppliers and are well understood by steel foundries. The property levels specified in ASTM specifications A27 and A148 are shown in Table 6.3.16. Table 6.3.17 lists current applicable ASTM steel castings standards.

**Steel Melting Practice** Steel for steel castings is produced commercially by processes similar to those used for wrought steel production, but electric arc and electric induction melting furnaces predominate. Some steel foundries also use secondary refining processes such as argon oxygen decarburization (AOD) and/or vacuum oxygen degassing (VOD). Wire injection is also used selectively depending on service and process requirements for the steel casting. In addition to the materials

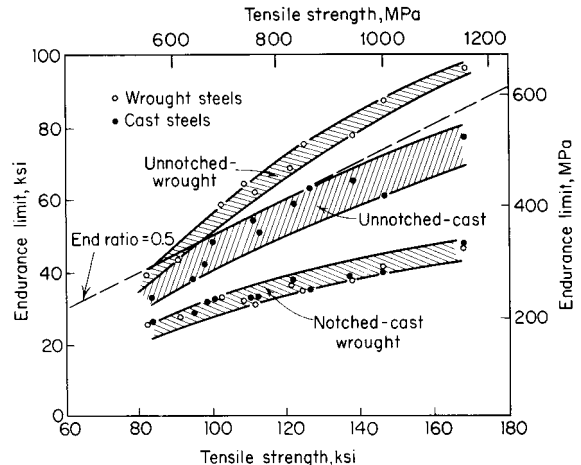

Fig. 6.3.16 Variations of endurance limit with tensile strength for comparable carbon and low-alloy cast and wrought steels.

listed in the ASTM standards, the steel casting industry will produce compositions tailored especially for particular service applications, and even in small quantity.

**Allowances for Steel Castings**

Dimensional allowances that must be applied in the production of castings are due to the fact that different metals contract at different rates during solidification and cooling. The shape of the part has a major influence on the as-cast dimensions of the casting. Some of the principal allowances are discussed briefly here.

**Shrinkage allowances** for steel castings vary from 1/32 to 1/16 in/ft (0.03 to 0.005 cm/cm). The amount most often used is 1/4 in/ft (0.021 cm/cm), but if it is applied indiscriminately, it can lead to problems in steel casting dimensions. The best policy is to discuss shrinkage allowances with the foundry that makes the castings before patterns are made.

**Minimum Section Thickness** The fluidity of steel when compared to other metals is low. In order that all sections may be completely filled, a minimum value of section thickness must be adopted that is a function of the largest dimension of the casting. These values are suggested for design use:

Table 6.3.16 ASTM Requirements for Steel Castings in A27 and A148

Grade	Tensile strength, min, ksi (MPa)	Yield point min, ksi (MPa)	Elongation, min, %	Reduction of area, min, %
ASTM A27				
U-60-30	60 (415)	30 (205)	22	30
60-30	60 (415)	30 (205)	24	35
65-35	65 (450)	35 (240)	24	35
70-36	70 (485)	36 (250)	22	30
70-40	70 (485)	40 (275)	22	30
ASTM A148				
80-40	80 (550)	40 (275)	18	30
80-50	80 (550)	50 (345)	22	35
90-60	90 (620)	60 (415)	20	40
105-85	105 (725)	85 (585)	17	35
115-95	115 (795)	95 (655)	14	30
130-115	130 (895)	115 (795)	11	25
135-125	135 (930)	125 (860)	9	22
150-135	150 (1,035)	135 (930)	7	18
160-145	160 (1,105)	145 (1,000)	6	12
165-150	165 (1,140)	150 (1,035)	5	20
165-150L	165 (1,140)	150 (1,035)	5	20
210-180	210 (1,450)	180 (1,240)	4	15
210-180L	210 (1,450)	180 (1,240)	4	15
260-210	260 (1,795)	210 (1,450)	3	6
260-210L	260 (1,795)	210 (1,450)	3	6

SOURCE: Abstracted from ASTM data, by permission.

Min section thickness		Max length of section	
in	mm	in	cm
¼	6	12	30
½	13	50	125

**Casting finish allowances** (unmachined) are based on the longest dimension of the casting, but the casting weight may also influence these allowances. Other factors which affect allowances include pattern materials and the method of pattern construction. Average values of allowance as a function of pattern type are shown in Table 6.3.18; other sources of similar data are "Steel Castings Handbook," Supplement 3, "Tolerances," SFSA, and ISO 8062 (Castings—System of Dimensional Tolerances and Machining Allowances). It is strongly recom-

mended that designers discuss allowance requirements with the foundry to avoid unnecessary costs.

**Machining finish allowances** added to the casting dimensions for machining purposes will depend entirely on the casting design. Definite values are not established for all designs, but Table 6.3.19 presents a brief guide to machining allowances on gears, wheels, and circular, flat castings.

#### Use of Steel Castings

All industries use steel castings. They are used as wheels, sideframes, bolsters, and couplings in the railroad industry; rock crushers in the mining and cement industries; components in construction vehicles; suspension parts and fifth wheels for trucks; valves; pumps; armor. High-alloy steel castings are used in highly corrosive environments in the chemical, petrochemical, and paper industries. Generally, steel castings are applied widely when strength, fatigue, and impact properties

Table 6.3.17 A Summary of ASTM Specifications for Steel and Alloy Castings

A 27	Steel Castings, Carbon, for General Application	A 451	Centrifugally Cast Austenitic Steel Pipe for High-Temperature Service
A 128	Steel Castings, Austenitic Manganese	A 487	Steel Castings, Suitable for Pressure Service
A 148	Steel Castings, High Strength, for Structural Purposes	A 494	Castings, Nickel and Nickel Alloy
A 216	Steel Castings, Carbon, Suitable for Fusion Welding, for High-Temperature Service	A 560	Castings, Chromium-Nickel Alloy
A 217	Steel Castings, Martensitic Stainless and Alloy, for Pressure-Containing Parts, Suitable for High-Temperature Service	A 660	Centrifugally Cast Carbon Steel Pipe for High-Temperature Service
A 297	Steel Castings, Iron-Chromium and Iron-Chromium-Nickel, Heat-Resistant, for General Application	A 703	Steel Castings, General Requirements, for Pressure-Containing Parts
A 351	Steel Castings, Austenitic, Austenitic-Ferritic (Duplex), for Pressure-Containing Parts	A 732	Castings, Investment, Carbon and Low-Alloy Steel for General Application, and Cobalt Alloy for High Strength at Elevated Temperatures
A 352	Steel Castings, Ferritic and Martensitic, for Pressure-Containing Parts, Suitable for Low-Temperature Service	A 743	Castings, Iron-Chromium, Iron-Chromium-Nickel, Corrosion-Resistant, for General Application
A 356	Steel Castings, Carbon, Low-Alloy, and Stainless Steel, Heavy-Walled for Steam Turbines	A 744	Castings, Iron-Chromium, Iron-Chromium-Nickel, Corrosion-Resistant, for Severe Service
A 389	Steel Castings, Alloy, Specially Heat-Treated, for Pressure-Containing Parts, Suitable for High-Temperature Service	A 747	Steel Castings, Stainless, Precipitation Hardening
A 426	Centrifugally Cast Ferritic Alloy Steel Pipe for High-Temperature Service	A 757	Steel Castings, Ferritic and Martensitic, for Pressure-Containing and Other Applications, for Low-Temperature Service
A 447	Steel Castings, Chromium-Nickel-Iron Alloy (25-12 Class), for High-Temperature Service	A 781	Castings, Steel and Alloy, Common Requirements, for General Industrial Use
		A 890	Castings, Iron-Chromium-Nickel-Molybdenum, Corrosion-Resistant, Duplex (Austenitic/Ferritic) for General Application
		A 915	Steel Castings, Carbon and Alloy, Chemical Requirements Similar to Standard Wrought Grades

SOURCE: Abstracted from ASTM data, by permission.



**Table 6.3.18 Dimensional Tolerances for Steel Castings\***  
(Deviation from the design dimension)

Pattern type	Drawing dimension, in†			
	0–3.0	3.1–7.0	7.1–20.0	20.1–100.0
Metal match plate	+ 1/32, - 1/16	+ 3/32, - 1/16	+ 1/8, - 1/16	+ 1/8, - 1/8
Metal pattern mounted on cope and drag boards	+ 1/16, - 1/16	+ 3/32, - 3/32	+ 1/8, - 3/32	+ 7/32, - 1/8
Hardwood pattern mounted on cope and drag boards	+ 3/32, - 1/16	+ 1/8, - 3/32	+ 1/8, - 3/32	+ 1/4, - 3/32

\* Surfaces that are not to be machined. † × 2.54 = cm.

**Table 6.3.19 Machining Allowances for Steel Castings**

Specific dimension or reference line (plane) distance, in		Greatest dimension of casting							
		10 in		10–20 in		20–100 in		Over 100 in*	
		0.xx in*	X/32 in*	0.xx in*	X/32 in*	0.xx in*	X/32 in*	0.xx in*	X/32 in*
Greater than	But not exceeding	+	+	+	+	+	+	+	+
0	2	0.187	6	0.218	7	0.25	8	0.312	10
2	5	0.25	8	0.281	9	0.312	10	0.437	14
5	10	0.312	10	0.344	11	0.375	12	0.531	17
10	20			0.406	13	0.468	15	0.625	20
20	50					0.562	18	0.75	24
50	75					0.656	21	0.875	28
75	100					0.75	24	1.00	32
100	500							1.25	40
Machine tolerances on section thickness									
		0.XXX in*				X/32 in*			
		+				+			
0	1/2	0.062				2			
1/2	1/2	0.092				3			
1 1/2	4	0.187				6			
4	7	0.25				8			
7	10	0.344				11			
10		0.50				16			

\* × 2.54 = cm.

are required, as well as weldability, corrosion resistance, and high-temperature strength. Often, overall economy of fabrication will dictate a steel casting as opposed to a competing product.

**Casting Design** Maximum service and properties can be obtained from castings only when they are properly designed. Design rules for castings have been prepared in detail to aid design engineers in prepar-

ing efficient designs. Engineers are referred to the following organizations for the latest publications available:

Steel Founders' Society of America, Des Plaines, IL 60016.

American Foundrymen's Society, Des Plaines, IL 60016.

Investment Casting Institute, Dallas, TX 75206.

## 6.4 NONFERROUS METALS AND ALLOYS; METALLIC SPECIALTIES

REFERENCES: Current edition of "Metals Handbook," American Society for Materials. Current listing of applicable ASTM, AISI, and SAE Standards. Publications of the various metal-producing companies. Publications of the professional and trade associations which contain educational material and physical property data for the materials promoted.

### INTRODUCTION

by L. D. Kunsman and C. L. Carlson; Amended by Staff

Seven **nonferrous metals** are of primary commercial importance: copper, zinc, lead, tin, aluminum, nickel, and magnesium. Some 40 other elements are frequently alloyed with these to make the commercially important alloys. There are also about 15 minor metals that have important specific uses. The properties of these elements are given in Table 6.4.1. (See also Sec. 4, 5, and 6.1.)

**Metallic Properties** Metals are substances that characteristically are opaque crystalline solids of high reflectivity having good electrical and thermal conductivities, a positive chemical valence, and, usually, the important combination of considerable strength and the ability to flow before fracture. These characteristics are exhibited by the metallic elements (e.g., iron, copper, aluminum, etc.), or **pure metals**, and by combinations of elements (e.g., steel, brass, dural), or **alloys**. Metals are composed of many small **crystals**, which grow individually until they fill the intervening spaces by abutting neighboring crystals. Although the external shape of these crystals and their orientation with respect to each other are usually random, within each such **grain**, or crystal, the atoms are arranged on a regular three-dimensional lattice. Most metals are arranged according to one of the three common types of **lattice**, or **crystal structure**: face-centered cubic, body-centered cubic, or hexagonal close-packed. (See Table 6.4.1.)

Table 6.4.1 Physical Constants of the Principal Alloy-Forming Elements

	Atomic no.	Atomic weight	Density, lb/in <sup>3</sup>	Melting point, °F	Boiling point, °F	Specific heat*	Latent heat of fusion, Btu/lb	Linear coef of thermal exp. per °F × 10 <sup>-6</sup>	Thermal conductivity (near 68°F), Btu/(ft <sup>2</sup> · h · °F/in)	Electrical resistivity, μΩ · cm	Modulus of elasticity (tension), lb/in <sup>2</sup> × 10 <sup>6</sup>	Crystal structure†	Transition temp., °F	Symbol
Aluminum	13	26.97	0.09751	1,220.4	4,520	0.215	170	13.3	1,540	2.655	10	FCC		Al
Antimony	51	121.76	0.239	1,166.9	2,620	0.049	68.9	4.7–7.0	131	39.0	11.3	Rhom		Sb
Arsenic	33	74.91	0.207	1,497	1,130	0.082	159	2.6		35	11	Rhom		As
Barium	56	137.36	0.13	1,300	2,980	0.068		(10)		50	1.8	BCC		Ba
Beryllium	4	9.02	0.0658	2,340	5,020	0.52	470	6.9	1,100	5.9	37	HCP		Be
Bismuth	83	209.00	0.354	520.3	2,590	0.029	22.5	7.4	58	106.8	4.6	Rhom		Bi
Boron	5	10.82	0.083	3,812	4,620	0.309		4.6		1.8 × 10 <sup>22</sup>		O		B
Cadmium	48	112.41	0.313	609.6	1,409	0.055	23.8	16.6	639	6.83	8	HCP		Cd
Calcium	20	40.08	0.056	1,560	2,625	0.149	100	12	871	3.43	3	FCC/BCC	867	Ca
Carbon	6	12.010	0.0802	6,700	8,730	0.165		0.3–2.4	165	1,375	0.7	Hex/D		C
Cerium	58	140.13	0.25	1,460	4,380	0.042	27.2			78		HCP/FCC	572/1328	Ce
Chromium	24	52.01	0.260	3,350	4,500	0.11	146	3.4	464	13	36	BCC/FCC	3344	Cr
Cobalt	27	58.94	0.32	2,723	6,420	0.099	112	6.8	479	6.24	30	HCP/FCC/HCP	783/2048	Co
Columbium (niobium)	41	92.91	0.310	4,380	5,970	0.065		4.0		13.1	15	BCC		Cb
Copper	29	63.54	0.324	1,981.4	4,700	0.092	91.1	9.2	2,730	1.673	16	FCC		Cu
Gadolinium	64	156.9	0.287									HCP		Gd
Gallium	31	69.72	0.216	85.5	3,600	0.0977	34.5	10.1	232	56.8	1	O		Ga
Germanium	32	72.60	0.192	1,756	4,890	0.086	205.7	(3.3)		60 × 10 <sup>6</sup>	11.4	D		Ge
Gold	79	197.2	0.698	1,945.4	5,380	0.031	29.0	7.9	2,060	2.19	12	FCC		Au
Hafnium	72	178.6	0.473	3,865	9,700	0.0351		(3.3)		32.4	20	HCP/BCC	3540	Hf
Hydrogen	1	1.0080	3.026 × 10 <sup>-6</sup>	-434.6	-422.9	3.45	27.0		1.18			Hex		H
Indium	49	114.76	0.264	313.5	3,630	0.057	12.2	18	175	8.37	1.57	FCT		In
Iridium	77	193.1	0.813	4,449	9,600	0.031	47	3.8	406	5.3	75	FCC		Ir
Iron	26	55.85	0.284	2,802	4,960	0.108	117	6.50	523	9.71	28.5	BCC/FCC/BCC	1663/2554	Fe
Lanthanum	57	138.92	0.223	1,535	8,000	0.0448				59	5	HCP/FCC/?	662/1427	La
Lead	82	207.21	0.4097	621.3	3,160	0.031	11.3	16.3	241	20.65	2.6	FCC		Pb
Lithium	3	6.940	0.019	367	2,500	0.79	286	31	494	11.7	1.7	BCC		Li
Magnesium	12	24.32	0.0628	1,202	2,030	0.25	160	14	1,100	4.46	6.5	HCP		Mg
Manganese	25	54.93	0.268	2,273	3,900	0.115	115	12		185	23	CCX/CCX/FCT	1340/2010/2080	Mn

	Atomic no.	Atomic weight	Density, lb/in <sup>3</sup>	Melting point, °F	Boiling point, °F	Specific heat*	Latent heat of fusion, Btu/lb	Linear coef of thermal exp. per °F × 10 <sup>-6</sup>	Thermal conductivity (near 68°F), Btu/(ft <sup>2</sup> ·h·°F/in)	Electrical resistivity, μΩ·cm	Modulus of elasticity (tension), lb/in <sup>2</sup> × 10 <sup>6</sup>	Crystal structure†	Transition temp., °F	Symbol
Mercury	80	200.61	0.4896	-37.97	675	0.033	4.9	33.8	58	94.1		Rhom		Hg
Molybdenum	42	95.95	0.369	4,750	8,670	0.061	126	3.0	1,020	5.17	50	BCC		Mo
Nickel	28	58.69	0.322	2,651	4,950	0.105	133	7.4	639	6.84	30	FCC		Ni
Niobium (see Columbium)														Nb
Nitrogen	7	14.008	0.042 × 10 <sup>-3</sup>	-346	-320.4	0.247	11.2		0.147			Hex		N
Osmium	76	190.2	0.813	4,900	9,900	0.031		2.6		9.5	80	HCP		Os
Oxygen	8	16.000	0.048 × 10 <sup>-3</sup>	-361.8	-297.4	0.218	5.9		0.171			C		O
Palladium	46	106.7	0.434	2,829	7,200	0.058	69.5	6.6	494	10.8	17	FCC		Pd
Phosphorus	15	30.98	0.0658	111.4	536	0.177	9.0	7.0		10 <sup>17</sup>		C		P
Platinum	78	195.23	0.7750	3,224.3	7,970	0.032	49	4.9	494	9.83	21	FCC		Pt
Plutonium	94	239	0.686	1,229				50-65		150		MC	6 forms	Pu
Potassium	19	39.096	0.031	145	1,420	0.177	26.1	46	697	6.15	0.5	BCC		K
Radium	88	226.05	0.18	1,300								?		Ra
Rhenium	75	186.31	0.765	5,733	10,700	0.0326	76			21	75	HCP		Re
Rhodium	45	102.91	0.4495	3,571	8,100	0.059		4.6	610	4.5	54	FCC		Rh
Selenium	34	78.96	0.174	428	1,260	0.084	29.6	21	3	12	8.4	MC/Hex	248	Se
Silicon	14	28.06	0.084	2,605	4,200	0.162	607	1.6-4.1	581	10 <sup>5</sup>	16	D		Si
Silver	47	107.88	0.379	1,760.9	4,010	0.056	45.0	10.9	2,900	1.59	11	FCC		Ag
Sodium	11	22.997	0.035	207.9	1,638	0.295	49.5	39	929	4.2	1.3	BCC		Na
Sulfur	16	32.066	0.0748	246.2	832.3	0.175	16.7	36	1.83	2 × 10 <sup>23</sup>		Rhom/FCC	204	S
Tantalum	73	180.88	0.600	5,420	9,570	0.036		3.6	377	12.4	27	BCC		Ta
Tellurium	52	127.61	0.225	840	2,530	0.047	13.1	9.3	41	2 × 10 <sup>5</sup>	6	Hex		Te
Thallium	81	204.39	0.428	577	2,655	0.031	9.1	16.6	2,700	18	12	HCP/BCC	446	Tl
Thorium	90	232.12	0.422	3,348	8,100	0.0355	35.6	6.2		18.6	11.4	FCC		Th
Tin	50	118.70	0.264	449.4	4,120	0.054	26.1	13	464	11.5	6	D/BCT	55	Sn
Titanium	22	47.90	0.164	3,074	6,395	0.139	187	4.7	119	47.8	16.8	HCP/BCC	1650	Ti
Tungsten	74	183.92	0.697	6,150	10,700	0.032	79	2.4	900	5.5	50	BCC		W
Uranium	92	238.07	0.687	2,065	7,100	0.028	19.8	11.4	186	29	29.7	O/Tet/BCC	1229/1427	U
Vanadium	23	50.95	0.217	3,452	5,430	0.120		4.3	215	26	18.4	BCC	2822	V
Zinc	30	65.38	0.258	787	1,663	0.092	43.3	9.4-22	784	5.92	12	HCP		Zn
Zirconium	40	91.22	0.23	3,326	9,030	0.066		3.1	116	41.0	11	HCP/BCC	1585	Zr

NOTE: See Sec. 1 for conversion factors to SI units.

\*Cal/(g·°C) at room temperature equals Btu/(lb·°F) at room temperature.

†FCC = face-centered cubic; BCC = body-centered cubic; C = cubic; HCP = hexagonal closest packing; Rhomb = rhombohedral; Hex = hexagonal; FCT = face-centered tetragonal; O = orthorhombic; FCO = face-centered orthorhombic; CCX = cubic complex; D = diamond cubic; BCT = body-centered tetragonal; MC = monoclinic.

SOURCE: ASM "Metals Handbook," revised and supplemented where necessary from Hampel's "Rare Metals Handbook" and elsewhere.

The several properties of metals are influenced to varying degrees by the testing or service **environment** (temperature, surrounding medium) and the **internal structure** of the metal, which is a result of its chemical composition and previous history such as casting, hot rolling, cold extrusion, annealing, and heat treatment. These relationships, and the discussions below, are best understood in the framework of the several phenomena that may occur in metals processing and service and their general effect on metallic structure and properties.

**Ores, Extractions, Refining** All metals begin with the mining of ores and are successively brought through suitable physical and chemical processes to arrive at commercially useful degrees of purity. At the higher-purity end of this process sequence, scrap metal is frequently combined with that derived from ore. Availability of suitable ores and the extracting and refining processes used are specific for each metal and largely determine the price of the metal and the impurities that are usually present in commercial metals.

**Melting** Once a metal arrives at a useful degree of purity, it is brought to the desired combination of shape and properties by a series of physical processes, each of which influences the internal structure of the metal. The first of these is usually melting, during which several elements can be combined to produce an alloy of the desired composition. Depending upon the metal, its container, the surrounding atmosphere, the addition of alloy-forming materials, or exposure to vacuum, various chemical reactions may be utilized in the melting stage to achieve optimum results.

**Casting** The molten metal of desired composition is poured into some type of mold in which the heat of fusion is dissipated and the melt becomes a solid of suitable shape for the next stage of manufacture. Such castings either are used directly (e.g., sand casting, die casting, permanent-mold casting) or are transferred to subsequent operations (e.g., ingots to rolling, billets to forging or extrusion). The principal advantage of castings is their design flexibility and low cost. The typical casting has, to a greater or lesser degree, a large crystal size (**grain size**), extraneous **inclusions** from slag or mold, and **porosity** caused by gas evolution and/or shrinking during solidification. The foundryman's art lies in minimizing the possible defects in castings while maximizing the economies of the process.

**Metalworking** (See also Sec. 13.) The major portion of all metals is subjected to additional shape and size changes in the solid state. These metalworking operations substantially alter the internal structure and eliminate many of the defects typical of castings. The usual sequence involves first **hot working** and then, quite often, **cold working**. Some metals are only hot-worked, some only cold-worked; most are both hot and cold-worked. These terms have a special meaning in metallurgical usage.

A cast metal consists of an aggregate of variously oriented grains, each one a single crystal. Upon deformation, the grains flow by a process involving the slip of blocks of atoms over each other, along definite crystallographic planes. The metal is hardened, strengthened, and rendered less ductile, and further deformation becomes more difficult. This is an important method of increasing the strength of nonferrous metals. The effect of progressive **cold rolling** on brass (Fig. 6.4.1) is typical. Terms such as "soft," "quarter hard," "half hard," and "full hard" are frequently used to indicate the degree of hardening produced by such working. For most metals, the hardness resulting from cold working is stable at room temperature, but with lead, zinc, or tin, it will decrease with time.

Upon **annealing**, or heating the cold-worked metal, the first effect is to relieve macrostresses in the object without loss of strength; indeed, the strength is often increased slightly. Above a certain temperature, softening commences and proceeds rapidly with increase in temperature (Fig. 6.4.2). The cold-worked distorted metal undergoes a change called **recrystallization**. New grains form and grow until they have consumed the old, distorted ones. The temperature at which this occurs in a given time, called the **recrystallization temperature**, is lower and the resulting grain size finer, the more severe the working of the original piece. If the original working is carried out above this temperature, it does not harden the piece, and the operation is termed **hot working**. If the annealing temperature is increased beyond the recrystallization temperature or

if the piece is held at that temperature for a long time, the average grain size increases. This generally softens and decreases the strength of the piece still further.

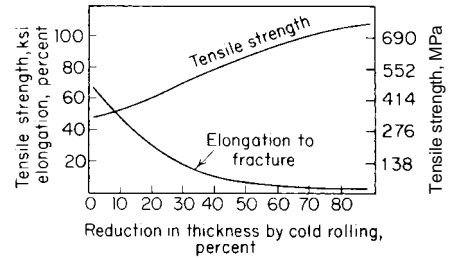

Fig. 6.4.1 Effect of cold rolling on annealed brass (Cu 72, Zn 28).

**Hot working** occurs when deformation and annealing proceed simultaneously, so that the resulting piece of new size and shape emerges in a soft condition roughly similar to the annealed condition.

**Alloys** The above remarks concerning structure and property control through casting, hot working, cold working, and annealing gener-

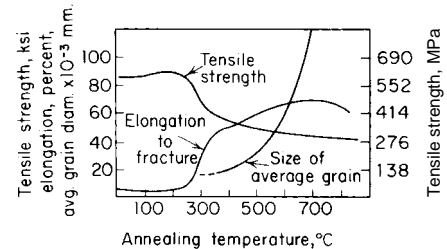

Fig. 6.4.2 Effect of annealing on cold-rolled brass (Cu 72, Zn 28).

ally apply both to pure metals and to alloys. The addition of alloying elements makes possible other means for controlling properties. In some cases, the addition to a metal A of a second element B simply results in the appearance of some new crystals of B as a **mixture** with crystals of A; the resulting properties tend to be an average of A and B. In other cases, an entirely new substance will form—the **intermetallic compound AB**, having its own set of distinctive properties (usually hard and brittle). In still other cases, element B will simply dissolve in element A to form the **solid solution A(B)**. Such solid solutions have the characteristics of the **solvent A** modified by the presence of the **solute B**, usually causing increased hardness, strength, electrical resistance, and recrystallization temperature. The most interesting case involves the combination of solid solution A(B) and the precipitation of a second constituent, either B or AB, brought about by the precipitation-hardening heat treatment, which is particularly important in the major nonferrous alloys.

**Precipitation Hardening** Many alloys, especially those of aluminum but also some alloys of copper, nickel, magnesium, and other metals, can be hardened and strengthened by heat treatment. The heat treatment is usually a two-step process which involves (1) a solution heat treatment followed by rapid quenching and (2) a precipitation or aging treatment to cause separation of a second phase from solid solution and thereby cause hardening. After a solution treatment, these alloys are comparatively soft and consist of homogeneous grains of solid solution generally indistinguishable microscopically from a pure metal. If very slowly cooled from the solution treatment temperature, the alloy will deposit crystals of a second constituent, the amount of which increases as the temperature decreases. Rapid cooling after a solution treatment will retain the supersaturated solution at room temperature, but if the alloy is subsequently reheated to a suitable temperature, fine particles of a new phase will form and in time will grow to a microscopically resolvable size. At some stage in this precipitation process the hardness, the tensile strength, and particularly the yield strength

of the alloy, will be increased considerably. If the reheating treatment is carried out too long, the alloy will overage and soften. The temperature and time for both solution and precipitation heat treatments must be closely controlled to obtain the best results. To some extent, precipitation hardening may be superimposed upon hardening resulting from cold working. Precipitation-hardened alloys have an unusually high ratio of proportional limit to tensile strength, but the endurance limit in fatigue is not increased to nearly the same extent.

**Effect of Environment** The properties of metals under "normal" conditions of 70°F and 50 percent relative humidity in clean air can be markedly changed under other conditions, with the various metals differing greatly in their degree of response to such changing conditions. The topic of **corrosion** is both important and highly specific (see Sec. 6.5). **Oxidation** is a chemical reaction specific to each metal and, wherever important, is so treated. The **effect of temperature**, however, can be profitably considered in general terms. The primary consequence of increase in temperature is increased atom movement, or **diffusion**. In the discussion above, the effects of recrystallization, hot working, solution treatment, and precipitation were all made possible by increased diffusion at elevated temperatures. The temperature at which such atom movements become appreciable is roughly proportional to the melting point of the metal. If their melting points are expressed on an absolute-temperature scale, then various metals can be expected to exhibit comparable effects at about the same fraction of their melting points. Thus the recrystallization temperatures of lead, zinc, aluminum, copper, nickel, molybdenum, and tungsten are successively higher. The consequent rule of thumb is that alloys do not have useful structural strength at temperatures above about 0.5 of their absolute melting temperatures.

## ALUMINUM AND ITS ALLOYS

by J. Randolph Kissell

REFERENCES: Kissell and Ferry, "Aluminum Structures," Wiley. Aluminum Association Publications: "Aluminum Standards and Data, 1993," "Aluminum Design Manual," "Aluminum with Food and Chemicals," and "Standards for Aluminum Sand and Permanent Mold Castings, 1992."

Aluminum owes most of its applications to its low density [about 0.1 lb/in<sup>3</sup> (0.16 kg/m<sup>3</sup>)] and to the relatively high strength of its alloys. Other uses depend upon its comparatively good corrosion resistance, good working properties, high electrical and thermal conductivity, reflectivity, and toughness at low temperatures. Designs utilizing aluminum should take into account its relatively low modulus of elasticity ( $10 \times 10^3$  ksi) ( $69 \times 10^3$  MPa) and high coefficient of thermal expansion [ $13 \times 10^{-6}/^\circ\text{F}$  ( $2.3 \times 10^{-5}/^\circ\text{C}$ )]. Commercially **pure aluminum** contains a minimum of 99 percent aluminum and is a soft and ductile metal used for many applications where high strength is not necessary. **Aluminum alloys**, on the other hand, possess better casting and machining characteristics and better mechanical properties than the pure metal and, therefore, are used more extensively.

**Aluminum alloys** are divided into two general classes: wrought alloys and cast alloys, each with its own alloy designation system as specified in ANSI H35.1, Alloy and Temper Designation Systems for Aluminum, maintained by the Aluminum Association.

**Aluminum Alloy Designation System** Wrought aluminum and aluminum alloys are designated by a four-digit number. The first digit indicates the alloy group according to the main alloying element as follows:

Aluminum, 99.00 percent or more	1xxx
Copper	2xxx
Manganese	3xxx
Silicon	4xxx
Magnesium	5xxx
Magnesium and silicon	6xxx
Zinc	7xxx
Other element	8xxx
Unused series	9xxx

The last two digits identify the aluminum alloy or indicate the aluminum purity in the case of the 1xxx series. The second digit indicates

modifications of the original alloy or impurity limits. Experimental alloys are indicated by the prefix X.

**Cast aluminum and aluminum alloys** are also designated by a four-digit number, but with a decimal point between the last two digits. The first digit indicates the alloy group according to the main alloying element as follows:

Aluminum, 99.00 percent or more	1xx.x
Copper	2xx.x
Silicon, with added copper and/or magnesium	3xx.x
Silicon	4xx.x
Magnesium	5xx.x
Zinc	7xx.x
Tin	8xx.x
Other element	9xx.x
Unused series	6xx.x

The second two digits identify the aluminum alloy or indicate the aluminum purity in the case of the 1xx.x series. The last digit indicates whether the product form is a casting (designated by 0) or ingot (designated by 1 or 2). A modification of the original alloy or impurity limits is indicated by a serial letter prefix before the numerical designation. The serial letters are assigned in alphabetical order but omitting I, O, Q, and X. The prefix X is used for experimental alloys.

The **temper** designation system applies to all aluminum and aluminum alloys, wrought and cast, except ingot. The temper designation follows the alloy designation, separated by a hyphen. The basic tempers are designated by letters as follows:

F	as fabricated (no control over thermal conditions or strain hardening)
O	annealed (the lowest-strength temper of an alloy)
H	strain-hardened (applies to wrought products only)
T	thermally treated

The H and T tempers are always followed by one or more numbers, say, T6 or H14, indicating specific sequences of treatments. The properties of alloys of H and T tempers are discussed further below.

**Wrought Aluminum Alloys** The alloys listed in Table 6.4.2 are divided into two classes: those which may be strengthened by strain hardening only (*non-heat-treatable*, designated by the H temper) and those which may be strengthened by thermal treatment (*heat-treatable*, designated by the T temper).

The heat-treatable alloys (see Table 6.4.3) first undergo **solution heat treatment** at elevated temperature to put the soluble alloying elements into solid solution. For example, alloy 6061 is heated to 990°F (530°C). This is followed by rapidly dropping the temperature, usually by quenching in water. At this point, the alloy is very workable, but if it is held at room temperature or above, strength gradually increases and ductility decreases as precipitation of constituents of the supersaturated solution begins. This gradual change in properties is called **natural aging**. Alloys that have received solution heat treatment only are designated T4 temper and may be more readily cold-worked in this condition. Some materials that are to receive severe forming operations, such as cold-driven rivets, are held in this workable condition by storing at freezing temperatures.

By applying a second heat treatment, **precipitation heat treatment** or **artificial aging**, at slightly elevated temperatures for a controlled period, further strengthening is achieved and properties are stabilized. For example, 6061 sheet is artificially aged when held at 320°F (160°C) for 18 h. Material so treated is designated T6 temper. Artificial aging changes the characteristic shape of the stress-strain curve above yielding, thus affecting the tangent modulus of elasticity. For this reason, inelastic buckling strengths are determined differently for artificially aged alloys and for alloys that have not received such treatment.

Non-heat-treatable alloys cannot be strengthened by heating, but may be given a heat treatment to stabilize mechanical properties. Strengthening is achieved by cold-working, also called *strain hardening*.

All wrought alloys may be annealed by heating to a prescribed temperature. For example, 6061 is annealed when held at 775°F (415°C) for approximately 2 to 3 h. **Annealing** reduces the alloy to its lowest strength but increases ductility. Strengths are degraded whenever strain-hard-

Table 6.4.2 Composition and Typical Room-Temperature Properties of Wrought Aluminum Alloys

Aluminum Assoc. alloy designation*	Nominal composition, % (balance aluminum)					Temper†	Density, lb/in <sup>3</sup>	Electrical conductivity, % IACS	Brinell hardness, 500-kg load, 10-mm ball	Mechanical properties		
	Cu	Si	Mn	Mg	Other elements					Tensile yield strength,‡ 1,000 lb/in <sup>2</sup>	Tensile strength, 1,000 lb/in <sup>2</sup>	Elong, %, in 2 in§
Work-hardenable alloys												
1100	0.12					0	0.098	59	23	5	13	35
						H14			32	17	18	9
						H18		57	44	22	24	5
3003	0.12		1.2			0	0.099	50	28	6	16	30
						H14		41	40	21	22	8
						H18		40	55	27	29	4
5052				2.5	0.25 Cr	0	0.097	35	47	13	28	25
						H34			68	31	38	10
						H38		35	77	37	42	7
5056		0.12	5.0		0.12 Cr	0	0.095	29	65	22	42	35
						H18		27	105	59	63	10
Heat-treatable alloys												
2011	5.5				0.4 Pb 0.4 Bi	T3	0.102	39	95	43	55	15
						T8		45	100	45	59	12
2014	4.4	0.8	0.8	0.5		0	0.101	50	45	14	27	18
						T4, 451		34	105	42	62	20
						T6, 651		40	135	60	70	13
Alclad 2014						0	0.101	40		10	25	21
						T4, 451				37	61	22
						T6, 651				60	68	10
2017	4.0	0.5	0.7	0.6		0	0.101	50	45	10	26	22
						T4, 451		34	105	40	62	22
2024	4.4		0.6	1.5		0	0.100	50	47	11	27	20
						T3		30	120	50	70	18
						T4, 351		30	120	47	68	20
Alclad 2024						0	0.100			11	26	20
						T3				45	65	18
						T4, 351				42	64	19
2025	4.4	0.8	0.8			T6	0.101	40	110	37	58	19
2219	6.3		0.3		0.18 Zr	0		44		11	25	18
					0.10 V	T351				36	52	17
					0.06 Ti	T851				51	66	10
6053		0.7	1.2		0.25 Cr	0	0.097	45	26	8	16	35
						T6		42	80	32	37	13
6061	0.28	0.6		1.0	0.20 Cr	0	0.098	47	30	8	18	25
						T6, 651		43	95	40	45	12
6063		0.4		0.7		0	0.097	58	25	7	13	25
						T6		53	73	31	35	12
7075	1.6			2.5	5.6 Zn	0	0.101		60	15	33	17
					0.23 Cr	T6, 651		33	150	73	83	11
Alclad 7075						0	0.101			14	32	17
						T6, 651				67	76	11
7178	2.0			2.8	0.23 Cr, 6.8 Zn	T6, 651	0.102	31		78	88	10

NOTE: See Sec. 1 for conversion factors for SI units.

\* Aluminum Association Standardized System of Alloy Designation adopted October 1954.

† Standard temper designations: 0 = fully annealed. H14 and H34 correspond to half-hard and H18 to H38 to hard strain-hardened tempers. T3 = solution treated and then cold-worked; T4 = solution heat-treated; T6 = solution treated and then artificially aged; T-51 = stretcher stress-relieved; T8 = solution treated, cold-worked, and artificially aged.

‡ At 0.2% offset.

§ Percent in 2 in, 1/16-in thick specimen.

Table 6.4.3 Conditions for Heat Treatment of Aluminum Alloys

Alloy	Product	Solution heat treatment		Precipitation heat treatment		
		Temp, °F	Temper designation	Temp, °F	Time of aging	Temper designation
2014	Extrusions	925–945	T4	315–325	18 h	T6
2017	Rolled or cold finished wire, rod and bar	925–945	T4	Room	4 days	
2024	Coiled Sheet	910–930	T4	Room	4 days	
6063	Extrusions	940–960	T4	340–360	8 h	T6
6061	Sheet	980–1,000	T4	310–330	18 h	T6
7075	Forgings	860–880	W	215–235 340–360	6–8 h 8–10 h	T73

°C = (°F – 32)/1.8.

\* This is a two-stage treatment.

ened or heat-treated material is reheated. The loss in strength is proportional to the time at elevated temperature. For example, 6061-T6 heated to 400°F (200°C) for no longer than 30 min or to 300°F (150°C) for 100 to 200 h suffers no appreciable loss in strength. Table 6.4.4 shows the effect of elevated temperatures on the strength of aluminum alloys.

Some common wrought alloys (by major alloying element) and applications are as follows:

**1xxx Series:** Aluminum of 99 percent purity is used in the electrical and chemical industries for its high conductivity, corrosion resistance,

**Table 6.4.4 Typical Tensile Properties of Aluminum Alloys at Elevated Temperatures**

Alloy and temper	Property*	Temp, °F*				
		75	300	400	500	700
Wrought						
1100-H18	T.S.	24	18	6	4	2.1
	Y.S.	22	14	3.5	2.6	1.6
	El.	15	20	65	75	85
2017-T4	T.S.	62	40	16	9	4.3
	Y.S.	40	30	13	7.5	3.5
	El.	22	15	35	45	70
2024-T4	T.S.	68	45	26	11	5
	Y.S.	47	36	19	9	4
	El.	19	17	27	55	100
3003-H18	T.S.	29	23	14	7.5	2.8
	Y.S.	27	16	9	4	1.8
	El.	10	11	18	60	70
3004-H38	T.S.	41	31	22	12	5
	Y.S.	36	27	15	7.5	3
	El.	6	15	30	50	90
5052-H34	T.S.	38	30	24	12	5
	Y.S.	31	27	15	7.5	3.1
	El.	16	27	45	80	130
6061-T6	T.S.	45	34	19	7.5	3
	Y.S.	40	31	15	5	1.8
	El.	17	20	28	60	95
6063-T6	T.S.	35	21	9	4.5	2.3
	Y.S.	31	20	6.5	3.5	2
	El.	18	20	40	75	105
7075-T6	T.S.	83	31	16	11	6
	Y.S.	73	27	13	9	4.6
	El.	11	30	55	65	70
Temp, °F*						
Sand castings						
355-T51	T.S.	28	24	14	10	6
	Y.S.	23	19	10	5	3
	El.	2	3	8	16	36
356-T6	T.S.	33	23	12	8	4
	Y.S.	24	20	9	5	3
	El.	4	6	18	35	60
Permanent-mold castings						
355-T51	T.S.	30	23	15	10	6
	Y.S.	24	20	10	5	3
	El.	2	4	9	33	98
356-T6	T.S.	38	21	12	8	4
	Y.S.	27	17	9	5	3
	El.	5	10	30	55	70

\*T.S., tensile strength ksi. Y.S., yield strength, ksi, 0.2 percent offset. El., elongation in 2 in. percent.

ksi × 6.895 = MPa °C = (°F - 32)/1.8.

Tensile tests made on pieces maintained at elevated temperatures for 10,000 h under no load. Stress applied at 0.05 in/(in/min) strain rate.

and workability. It is available in extruded or rolled forms and is hardened by cold working but not by heat treatment.

**2xxx Series:** These alloys are heat-treatable and may attain strengths comparable to those of steel alloys. They are less corrosion-resistant than other aluminum alloys and thus are often clad with pure aluminum or an alloy of the 6xxx series (see alclad aluminum, below). Alloys 2014 and 2024 are popular, 2024 being perhaps the most widely used aircraft alloy. Many of the alloys in this group, including 2014, are not usually welded.

**3xxx Series:** Alloys in this series are non-heat-treatable. Alloys 3003, 3004, and 3105 are popular general-purpose alloys with moderate strengths and good workability, and they are often used for sheet metal work.

**4xxx Series:** Silicon added to alloys in this group lowers the melting point, making these alloys suitable for use as weld filler wire (such as 4043) and brazing alloys.

**5xxx Series:** These alloys attain moderate-to-high strengths by strain hardening. They usually have the highest welded strengths among aluminum alloys and good corrosion resistance. Alloys 5083, 5086, 5154, 5454, and 5456 are used in welded structures, including pressure vessels. Alloy 5052 is a popular sheet metal alloy.

**6xxx Series:** Although these alloys usually are not as strong as those in the other heat-treatable series, 2xxx and 7xxx, they offer a good combination of strength and corrosion resistance. Alloys 6061 and 6063 are used widely in construction, with alloy 6061 providing better strength at a slightly greater cost.

**7xxx Series:** Heat-treating alloys in this group produces some of the highest-strength alloys, frequently used in aircraft, such as 7050, 7075, 7178, and 7475. And 7178-T651 plate has a minimum ultimate tensile strength of 84 ksi (580 MPa). Corrosion resistance is fair. Many alloys in this group (such as 7050, 7075, and 7178) are not arc-welded.

Aluminum-lithium alloys have been produced with higher strength and modulus of elasticity than those of any of the alloys previously available, but they are not as ductile.

Wrought alloys are available in a number of product forms. **Extrusions**, produced by pushing the heated metal through a die opening, are among the most useful. A great variety of custom shapes, as well as standard shapes such as I beams, angles, channels, pipe, rectangular tube, and many others, are extruded. Extrusion cross-sectional sizes may be as large as those fitting within a 31-in (790-mm) circle, but more commonly are limited to about a 12-in (305-mm) circle. Alloys extruded include 1100, 1350, 2014, 2024, 3003, 5083, 5086, 5454, 5456, 6005, 6061, 6063, 6101, 6105, 6351, 7005, 7075, and 7178. The most common are 6061 and 6063. Rod, bar, and wire are also produced rolled or cold-finished as well as extruded. Tubes may be drawn or extruded.

Flat rolled products include foil, sheet, and plate. **Foil** is defined as rolled product less than 0.006 in (0.15 mm) thick. **Sheet** thickness is less than 0.25 in (6.4 mm) but not less than 0.006 in; aluminum sheet gauge thicknesses are different from those used for steel, and decimal thicknesses are preferred when ordering. Sheet is available flat and coiled. **Plate** thickness is 0.25 in and greater, and it ranges up to about 6 in (150 mm). Minimum bend radii for sheet and plate depend on alloy and temper, but are generally greater than bend radii for mild carbon steel. Commercial roofing and siding sheet is available in a number of profiles, including corrugated, ribbed, and V-beam.

Aluminum **forgings** are produced by open-die and closed-die methods. Minimum mechanical strengths are not published for open-die forgings, so structural applications usually require closed-die forgings. Like castings, forgings may be produced in complex shapes, but have more uniform properties and better ductility than castings and are used for products such as wheels and aircraft frames. For some forging alloys, minimum mechanical properties are slightly lower in directions other than parallel to the grain flow. Alloy 6061-T6 is popular for forgings.

Minimum **mechanical properties** (typically tensile ultimate and yield strengths and elongation) are specified for most wrought alloys and tempers by the Aluminum Association in "Aluminum Standards and Data." These minimum properties are also listed in ASTM specifica-

tions, but are grouped by ASTM by product (such as sheet and plate) rather than by alloy. The minimum properties are established at levels at which 99 percent of the material is expected to conform at a confidence level of 0.95. The strengths of aluminum members subjected to axial force, bending, and shear under static and fatigue loads, listed in the Aluminum Association "Specifications for Aluminum Structures," are calculated using these minimum properties. Aluminum and some of its alloys are also used in structural applications such as storage tanks at temperatures up to 400°F (200°C), but strengths are reduced due to creep and the annealing effect of heat.

**Cast Aluminum Alloys** These are used for parts of complex shapes by sand casting, permanent mold casting, and die casting. The compositions and minimum mechanical properties of some cast aluminum alloys are given in Tables 6.4.5a to 6.4.5d. Castings generally exhibit more variation in strength and less ductility than wrought products. Tolerances, draft requirements, heat treatments, and quality standards are given in the Aluminum Association "Standards for Aluminum Sand and Permanent Mold Castings." Tolerances and the level of quality and frequency of inspection must be specified by the user if desired.

**Sand castings** (see ASTM B26) produce larger parts—up to 7,000 lb (3,200 kg)—in relatively small quantities at slow solidification rates. The sand mold is used only once. Tolerances and minimum thicknesses for sand castings are greater than those for other casting types.

**Permanent mold castings** (see ASTM B108) are produced by pouring the molten metal into a reusable mold, sometimes with a vacuum to assist the flow. While more expensive than sand castings, permanent mold castings can be used for parts with wall thicknesses as thin as about 0.09 in (2.3 mm).

In **die casting** (see ASTM B85), aluminum is injected into a reusable steel mold, or die, at high velocity; fast solidification rates are achieved.

The lowest-cost general-purpose casting alloy is 356-T6, while A356-T6 is common in aerospace applications. Alloy A444-T4 provides excellent ductility, exceeding that of many wrought alloys. These three rank among the most weldable of the casting alloys. The cast alloys utilizing copper (2xx.x) generally offer the highest strengths at elevated temperatures. In addition to end use, alloy selection should take into account fluidity, resistance to hot cracking, and pressure tightness.

**Machining** (see Sec. 13) Many aluminum alloys are easily machined without special technique at cutting speeds generally much higher than those for other metals. Pure aluminum and alloys of aluminum-manganese (3xxx) and aluminum-magnesium (5xxx) are harder to machine than alloys of aluminum-copper (2xxx) and aluminum-zinc (7xxx). The most machinable wrought alloy is 2011 in the T3, T4, T6, and T8 tempers, producing small broken chips and excellent finish; they are used where physical properties are subordinate to high machinability, such as for screw machine products. Castings are also machined; aluminum-copper (such as 201, 204, and 222), aluminum-magnesium (5xx.x), aluminum-zinc (7xx.x), and aluminum-tin (8xx.x) alloys are among the best choices.

**Joining** Mechanical fasteners (including rivets, bolts, and screws) are the most common methods of joining, because the application of heat during welding decreases the strength of aluminum alloys. Aluminum **bolts** (usually 2024-T4, 6061-T6, or 7075-T73) are available in diameters from ¼ in (6.4 mm) to 1 in (25 mm), with properties conforming to ASTM F468. Mechanical properties are given in Table 6.4.6. Aluminum nuts (usually 2024-T4, 6061-T6, and 6262-T9) are also available. Galvanized steel and 300-series stainless steel bolts are also used to join aluminum. Hole size usually exceeds bolt diameter by ⅛ in (1.6 mm) or less. **Rivets** are used to resist shear loads only; they do not develop sufficient clamping force between the parts joined and thus cannot reliably resist tensile loads. In general, rivets of composition similar to the base metal are used. Table 6.4.7 lists common aluminum rivet alloys and their minimum ultimate shear strengths. Hole diameter for cold-driven rivets may be no larger than 4 percent greater than the nominal rivet diameter; hole diameter for hot-driven rivets may be no larger than 7 percent greater than the nominal rivet diameter. **Screws** of 2024-T4, 7075-T73 aluminum, or 300-series stainless steels are often used to fasten aluminum sheet. Holes for fasteners may be punched,

drilled, or reamed, but punching is not used if the metal thickness is greater than the diameter of the hole. Applications of adhesive joining are increasing.

**Welding** (see Sec. 13) Most wrought aluminum alloys are weldable by experienced operators using either the fusion or resistance method. **Fusion welding** is typically by **gas tungsten arc welding** (GTAW), commonly called **TIG** (for tungsten inert gas) welding, or **gas metal arc welding** (GMAW), referred to as **MIG** (for metal inert gas) welding. TIG welding is usually used to join parts from about ⅛ to ⅜ in (0.8 to 3.2 mm) thick; MIG welding is usually used to weld thicker parts. The American Welding Society Standard D1.2, Structural Welding Code—Aluminum, provides specifications for structural applications of aluminum fusion-welding methods. Filler rod alloys must be chosen carefully for strength, corrosion resistance, and compatibility with the parent alloys to be welded. Cast alloys may also be welded, but are more susceptible to cracking than wrought alloy weldments. All aluminum alloys suffer a reduction in strength in the heat-affected weld zone, although this reduction is less in some of the aluminum-magnesium (5xxx series) alloys. Postweld heat treatment may be used to counter the reduction in strength caused by welding, but extreme care must be taken to avoid embrittling or warping the weldment. **Resistance welding** includes **spot welding**, often used for lap joints, and seam welding. Methods of **nondestructive testing of aluminum welds** include dye-penetrant methods to detect flaws accessible to the surface and ultrasonic and radiographic inspection.

**Brazing** is also used to join aluminum alloys with relatively high melting points, such as 1050, 1100, 3003, and 6063, using aluminum-silicon alloys such as 4047 and 4145. Aluminum may also be **soldered**, but corrosion resistance of soldered joints is inferior to that of welded, brazed, or mechanically fastened joints.

**Corrosion Resistance** Although aluminum is chemically active, the presence of a rapidly forming and firmly adherent self-healing oxide surface coating inhibits corrosive action except under conditions that tend to remove this surface film. Concentrated nitric and acetic acids are handled in aluminum not only because of its resistance to attack but also because any resulting corrosion products are colorless. For the same reason, aluminum is employed in the preparation and storage of foods and beverages. Hydrochloric acid and most alkalis dissolve the protective surface film and result in fairly rapid attack. Moderately alkaline soaps and the like can be used with aluminum if a small amount of sodium silicate is added. Aluminum is very resistant to sulfur and most of its gaseous compounds.

**Galvanic corrosion** may occur when aluminum is electrically connected by an electrolyte to another metal. Aluminum is more anodic than most metals and will be sacrificed for the benefit of the other metal, which is thereby cathodically protected from attack. Consequently, aluminum is usually isolated from other metals such as steel (but not stainless steel) where moisture is present.

Another form of corrosion is **exfoliation**, a delamination or peeling of layers of metal in planes approximately parallel to the metal surface, caused by the formation of corrosion product. Alloys with more than 3 percent magnesium (such as 5083, 5086, 5154, and 5456) and held at temperatures above 150°F (65°C) for extended periods are susceptible to this form of attack.

Care should be taken to store aluminum in a manner to avoid trapping water between adjacent flat surfaces, which causes water stains. These stains, which vary in color from dark gray to white, do not compromise strength but are difficult to remove and may be cosmetically unacceptable.

Ordinary atmospheric corrosion is resisted by aluminum and most of its alloys, and they may be used outdoors without any protective coating. (An exception is 2014-T6, which is usually painted when exposed to the elements.) The pure metal is most resistant to attack, and additions of alloying elements usually decrease corrosion resistance, particularly after heat treatment. Under severe conditions of exposure such as may prevail in marine environments or where the metal is continually in contact with wood or other absorbent material in the presence of moisture, a protective coat of paint will provide added protection.

**Alclad Aluminum** The corrosion resistance of aluminum alloys may



Table 6.4.5a Composition Limits of Aluminum Casting Alloys (Percent)

Alloy	Product*	Silicon	Iron	Copper	Manganese	Magnesium	Chromium	Nickel	Zinc	Titanium	Tin	Others	
												Each	Total
201.0	S	0.10	0.15	4.0–5.2	0.20–0.50	0.15–0.55	—	—	—	0.15–0.35	—	0.05	0.10
204.0	S&P	0.20	0.35	4.2–5.0	0.10	0.15–0.35	—	0.05	0.10	0.15–0.30	—	0.05	0.15
208.0	S&P	2.5–3.5	1.2	3.5–4.5	0.50	0.10	—	0.35	1.0	0.25	—	—	0.50
222.0	S&P	2.0	1.5	9.2–10.7	0.50	0.15–0.35	—	0.50	0.8	0.25	—	—	0.35
242.0	S&P	0.7	1.0	3.5–4.5	0.35	1.2–1.8	0.25	1.7–2.3	0.35	0.25	—	0.05	0.15
295.0	S	0.7–1.5	1.0	4.0–5.0	0.35	0.03	—	—	0.35	0.25	—	0.05	0.15
296.0	P	2.0–3.0	1.2	4.0–5.0	0.35	0.05	—	0.35	0.50	0.25	—	—	0.35
308.0	P	5.0–6.0	1.0	4.0–5.0	0.50	0.10	—	—	1.0	0.25	—	—	0.50
319.0	S&P	5.5–6.5	1.0	3.0–4.0	0.50	0.10	—	0.35	1.0	0.25	—	—	0.50
328.0	S	7.5–8.5	1.0	1.0–2.0	0.20–0.6	0.20–0.6	0.35	0.25	1.5	0.25	—	—	0.50
332.0	P	8.5–10.5	1.2	2.0–4.0	0.50	0.50–1.5	—	0.50	1.0	0.25	—	—	0.50
333.0	P	8.0–10.0	1.0	3.0–4.0	0.50	0.05–0.50	—	0.50	1.0	0.25	—	—	0.50
336.0	P	11.0–13.0	1.2	0.50–1.5	0.35	0.7–1.3	—	2.0–3.0	0.35	0.25	—	0.05	—
354.0	S&P	8.6–9.4	0.20	1.6–2.0	0.10	0.40–0.6	—	—	0.10	0.20	—	0.05	0.15
355.0	S&P	4.5–5.5	0.6	1.0–1.5	0.50	0.40–0.6	0.25	—	0.35	0.25	—	0.05	0.15
C355.0	S&P	4.5–5.5	0.20	1.0–1.5	0.10	0.40–0.6	—	—	0.10	0.20	—	0.05	0.15
356.0	S&P	6.5–7.5	0.6	0.25	0.35	0.20–0.45	—	—	0.35	0.25	—	0.05	0.15
A356.0	S&P	6.5–7.5	0.20	0.20	0.10	0.25–0.45	—	—	0.10	0.20	—	0.05	0.15
357.0	S&P	6.5–7.5	0.15	0.05	0.03	0.45–0.6	—	—	0.05	0.20	—	0.05	0.15
A357.0	S&P	6.5–7.5	0.20	0.20	0.10	0.40–0.7	—	—	0.10	0.04–0.20	—	0.05	0.15
359.0	S&P	8.5–9.5	0.20	0.20	0.10	0.50–0.7	—	—	0.10	0.20	—	0.05	0.15
360.0	D	9.0–10.0	2.0	0.6	0.35	0.40–0.6	—	0.50	0.50	—	0.15	—	0.25
A360.0	D	9.0–10.0	1.3	0.6	0.35	0.40–0.6	—	0.50	0.50	—	0.15	—	0.25
380.0	D	7.5–9.5	2.0	3.0–4.0	0.50	0.10	—	0.50	3.0	—	0.35	—	0.50
A380.0	D	7.5–9.5	1.3	3.0–4.0	0.50	0.10	—	0.50	3.0	—	0.35	—	0.50
383.0	D	9.5–11.5	1.3	2.0–3.0	0.50	0.10	—	0.30	3.0	—	0.15	—	0.50
384.0	D	10.5–12.0	1.3	3.0–4.5	0.50	0.10	—	0.50	3.0	—	0.35	—	0.50
390.0	D	16.0–18.0	1.3	4.0–5.0	0.10	0.45–0.65	—	—	0.10	0.20	—	—	0.20
B390.0	D	16.0–18.0	1.3	4.0–5.0	0.50	0.45–0.65	—	0.10	1.5	0.10	—	—	0.20
392.0	D	18.0–20.0	1.5	0.40–0.80	0.20–0.60	0.80–1.20	—	0.50	0.50	0.20	0.30	—	0.50
413.0	D	11.0–13.0	2.0	1.0	0.35	0.10	—	0.50	0.50	—	0.15	—	0.25
A413.0	D	11.0–13.0	1.3	1.0	0.35	0.10	—	0.50	0.50	—	0.15	—	0.25
C433.0	D	4.5–6.0	2.0	0.6	0.35	0.10	—	0.50	0.50	—	0.15	—	0.25
443.0	S&P	4.5–6.0	0.8	0.6	0.50	0.05	0.25	—	0.50	0.25	—	—	0.35
B443.0	S&P	4.5–6.0	0.8	0.15	0.35	0.05	—	—	0.35	0.25	—	0.05	0.15
A444.0	P	6.5–7.5	0.20	0.10	0.10	0.05	—	—	0.10	0.20	—	0.05	0.15
512.0	S	1.4–2.2	0.6	0.35	0.8	3.5–4.5	0.25	—	0.35	0.25	—	0.05	0.15
513.0	P	0.30	0.40	0.10	0.30	3.5–4.5	—	—	1.4–2.2	0.20	—	0.05	0.15
514.0	S	0.35	0.50	0.15	0.35	3.5–4.5	—	—	0.15	0.25	—	0.05	0.15
518.0	D	0.35	1.8	0.25	0.35	7.5–8.5	—	0.15	0.15	—	0.15	—	0.25
520.0	S	0.25	0.30	0.25	0.15	9.5–10.6	—	—	0.15	0.25	—	0.05	0.15
535.0	S&P	0.15	0.15	0.05	0.10–0.25	6.2–7.5	—	—	—	0.10–0.25	—	0.05	0.15
705.0	S&P	0.20	0.8	0.20	0.40–0.6	1.4–1.8	0.20–0.40	—	2.7–3.3	0.25	—	0.05	0.15
707.0	S&P	0.20	0.8	0.20	0.40–0.6	1.8–2.4	0.20–0.40	—	4.0–4.5	0.25	—	0.05	0.15
710.0	S	0.15	0.50	0.35–0.65	0.05	0.6–0.8	—	—	6.0–7.0	0.25	—	0.05	0.15
711.0	P	0.30	0.7–1.4	0.35–0.65	0.05	0.25–0.45	—	—	6.0–7.0	0.20	—	0.05	0.15
712.0	S	0.30	0.50	0.25	0.10	0.50–0.65	0.40–0.6	—	5.0–6.5	0.15–0.25	—	0.05	0.20
713.0	S&P	0.25	1.1	0.40–1.0	0.6	0.20–0.50	0.35	0.15	7.0–8.0	0.25	—	0.10	0.25
771.0	S	0.15	0.15	0.10	0.10	0.8–1.0	0.06–0.20	—	6.5–7.5	0.10–0.20	—	0.05	0.15
850.0	S&P	0.7	0.7	0.7–1.3	0.10	0.10	—	0.7–1.3	—	0.20	—	—	0.30
851.0	S&P	2.0–3.0	0.7	0.7–1.3	0.10	0.10	—	0.30–0.7	—	0.20	—	—	0.30
852.0	S&P	0.40	0.7	1.7–2.3	0.10	0.6–0.9	—	0.9–1.5	—	0.20	—	—	0.30

\* S = sand casting, P = permanent mold casting, D = die casting.

Table 6.4.5b Mechanical Properties of Aluminum Sand Castings

Alloy	Temper	Minimum properties				% Elongation in 2 in. or 4 times diameter
		Tensile strength				
		Ultimate		Yield (0.2% offset)		
ksi	(MPa)	ksi	(MPa)			
201.0	T7	60.0	(414)	50.0	(345)	3.0
204.0	T4	45.0	(310)	28.0	(193)	6.0
208.0	F	19.0	(131)	12.0	( 83)	1.5
222.0	O	23.0	(159)	—	—	—
222.0	T61	30.0	(207)	—	—	—
242.0	O	23.0	(159)	—	—	—
242.0	T571	29.0	(200)	—	—	—
242.0	T61	32.0	(221)	20.0	(138)	—
242.0	T77	24.0	(165)	13.0	( 90)	1.0
295.0	T4	29.0	(200)	13.0	( 90)	6.0
295.0	T6	32.0	(221)	20.0	(138)	3.0
295.0	T62	36.0	(248)	28.0	(193)	—
295.0	T7	29.0	(200)	16.0	(110)	3.0
319.0	F	23.0	(159)	13.0	( 90)	1.5
319.0	T5	25.0	(172)	—	—	—
319.0	T6	31.0	(214)	20.0	(138)	1.5
328.0	F	25.0	(172)	14.0	( 97)	1.0
328.0	T6	34.0	(234)	21.0	(145)	1.0
354.0	*	—	—	—	—	—
355.0	T51	25.0	(172)	18.0	(124)	—
355.0	T6	32.0	(221)	20.0	(138)	2.0
355.0	T7	35.0	(241)	—	—	—
355.0	T71	30.0	(207)	22.0	(152)	—
C355.0	T6	36.0	(248)	25.0	(172)	2.5
356.0	F	19.0	(131)	—	—	2.0
356.0	T51	23.0	(159)	16.0	(110)	—
356.0	T6	30.0	(207)	20.0	(138)	3.0
356.0	T7	31.0	(214)	29.0	(200)	—
356.0	T71	25.0	(172)	18.0	(124)	3.0
A356.0	T6	34.0	(234)	24.0	(165)	3.5
357.0	*	—	—	—	—	—
A357.0	*	—	—	—	—	—
359.0	*	—	—	—	—	—
443.0	F	17.0	(117)	7.0	( 49)	3.0
B433.0	F	17.0	(117)	6.0	( 41)	3.0
512.0	F	17.0	(117)	10.0	( 69)	—
514.0	F	22.0	(152)	9.0	( 62)	6.0
520.0	T4	42.0	(290)	22.0	(152)	12.0
535.0	F or T5	35.0	(241)	18.0	(124)	9.0
705.0	F or T5	30.0	(207)	17.0	(117)	5.0
707.0	T5	33.0	(228)	22.0	(152)	2.0
707.0	T7	37.0	(255)	30.0	(207)	1.0
710.0	F or T5	32.0	(221)	20.0	(138)	2.0
712.0	F or T5	34.0	(234)	25.0	(172)	4.0
713.0	F or T5	32.0	(221)	22.0	(152)	3.0
771.0	T5	42.0	(290)	38.0	(262)	1.5
771.0	T51	32.0	(221)	27.0	(186)	3.0
771.0	T52	36.0	(248)	30.0	(207)	1.5
771.0	T53	36.0	(248)	27.0	(186)	1.5
771.0	T6	42.0	(290)	35.0	(241)	5.0
771.0	T71	48.0	(331)	45.0	(310)	2.0
850.0	T5	16.0	(110)	—	—	5.0
851.0	T5	17.0	(117)	—	—	3.0
852.0	T5	24.0	(165)	18.0	(124)	—

Values represent properties obtained from separately cast test bars. Average properties of specimens cut from castings shall not be less than 75% of tensile and yield strength values and shall not be less than 25% of elongation values given above.

\* Mechanical properties for these alloys depend on casting process. Consult individual foundries.

be augmented by coating the material with a surface layer of high-purity aluminum or, in some cases, a more corrosion-resistant alloy of aluminum. Such products are referred to as **alclad**. This cladding becomes an integral part of the material, is metallurgically bonded, and provides cathodic protection in a manner similar to zinc galvanizing on steel. Because the cladding usually has lower strength than the base metal, alclad products have slightly lower strengths than uncoated material. Cladding thickness varies from 1.5 to 10 percent. Products available

clad are 3003 tube, 5056 wire, and 2014, 2024, 2219, 3003, 3004, 6061, 7075, 7178, and 7475 sheet and plate.

**Anodizing** The corrosion resistance of any of the alloys may also be improved by anodizing, done by making the parts to be treated the anode in an electrolytic bath such as sulfuric acid. This process produces a tough, adherent coating of aluminum oxide, usually 0.4 mil (0.01 mm) thick or greater. Any welding should be performed before anodizing, and filler alloys should be chosen judiciously for good ano-

Table 6.4.5c Mechanical Properties of Aluminum Permanent Mold Castings

Alloy	Temper	Minimum properties				% Elongation in 2 in. or 4 times diameter
		Tensile strength				
		Ultimate		Yield (0.2% offset)		
ksi	(MPa)	ksi	(MPa)			
204.0	T4	48.0	(331)	29.0	(200)	8.0
208.0	T4	33.0	(228)	15.0	(103)	4.5
208.0	T6	35.0	(241)	22.0	(152)	2.0
208.0	T7	33.0	(228)	16.0	(110)	3.0
222.0	T551	30.0	(207)	—	—	—
222.0	T65	40.0	(276)	—	—	—
242.0	T571	34.0	(234)	—	—	—
242.0	T61	40.0	(276)	—	—	—
296.0	T6	35.0	(241)	—	—	2.0
308.0	F	24.0	(165)	—	—	—
319.0	F	28.0	(193)	14.0	( 97)	1.5
319.0	T6	34.0	(234)	—	—	2.0
332.0	T5	31.0	(214)	—	—	—
333.0	F	28.0	(193)	—	—	—
333.0	T5	30.0	(207)	—	—	—
333.0	T6	35.0	(241)	—	—	—
333.0	T7	31.0	(214)	—	—	—
336.0	T551	31.0	(214)	—	—	—
336.0	T65	40.0	(276)	—	—	—
354.0	T61	48.0	(331)	37.0	(255)	3.0
354.0	T62	52.0	(359)	42.0	(290)	2.0
355.0	T51	27.0	(186)	—	—	—
355.0	T6	37.0	(255)	—	—	1.5
355.0	T62	42.0	(290)	—	—	—
355.0	T7	36.0	(248)	—	—	—
355.0	T71	34.0	(234)	27.0	(186)	—
C355.0	T61	40.0	(276)	30.0	(207)	3.0
356.0	F	21.0	(145)	—	—	3.0
356.0	T51	25.0	(172)	—	—	—
356.0	T6	33.0	(228)	22.0	(152)	3.0
356.0	T7	25.0	(172)	—	—	3.0
356.0	T71	25.0	(172)	—	—	3.0
A356.0	T61	37.0	(255)	26.0	(179)	5.0
357.0	T6	45.0	(310)	—	—	3.0
A357.0	T61	45.0	(310)	36.0	(248)	3.0
359.0	T61	45.0	(310)	34.0	(234)	4.0
359.0	T62	47.0	(324)	38.0	(262)	3.0
443.0	F	21.0	(145)	7.0	( 49)	2.0
B443.0	F	21.0	(145)	6.0	( 41)	2.5
A444.0	T4	20.0	(138)	—	—	20.0
513.0	F	22.0	(152)	12.0	( 83)	2.5
535.0	F	35.0	(241)	18.0	(124)	8.0
705.0	T5	37.0	(255)	17.0	(117)	10.0
707.0	T7	45.0	(310)	35.0	(241)	3.0
711.0	T1	28.0	(193)	18.0	(124)	7.0
713.0	T5	32.0	(221)	22.0	(152)	4.0
850.0	T5	18.0	(124)	—	—	8.0
851.0	T5	17.0	(117)	—	—	3.0
851.0	T6	18.0	(124)	—	—	8.0
852.0	T5	27.0	(186)	—	—	3.0

Values represent properties obtained from separately cast test bars. Average properties of specimens cut from castings shall not be less than 75% of tensile and yield strength values and shall not be less than 25% of elongation values given above.

dized color match with the base alloy. The film is colorless on pure aluminum and tends to be gray or colored on alloys containing silicon, copper, or other constituents. To provide a consistent color appearance after anodizing, **AQ (anodizing quality) grade** may be specified in certain alloys. Where appearance is the overriding concern, 5005 sheet and 6063 extrusions are preferred for anodizing. If a colored finish is desired, the electrolytically oxidized article may be treated with a dye solution. Care must be taken in selecting the dye when the part will be exposed to the weather, for not all have proved to be colorfast. Two-step electrolytic coloring, produced by first clear anodizing and then electrolytically depositing another metal oxide, can produce shades of bronze, burgundy, and blue.

**Painting** When one is painting or lacquering aluminum, it is impor-

tant that the surface be properly prepared prior to the application of paint. A thin anodic film makes an excellent paint base. Alternately, the aluminum surface may be chemically treated with a dilute phosphoric acid solution. Abrasion blasting may be used on parts thicker than 1/8 in (3.2 mm). Zinc chromate is frequently used as a primer, especially for corrosive environments. Most paints are baked on. That affects the strength of the metal, for baking tends to anneal it, and must be taken into account where strength is a factor. Sometimes the paint baking process is used as the artificial aging heat treatment. Aluminum sheet is available with factory-baked paint finish; minimum mechanical properties must be obtained from the supplier. High-, medium-, and low-gloss paint finishes are available and are determined in accordance with ASTM D523.

Table 6.4.5d Mechanical Properties of Aluminum Die Castings

Alloy		Typical tensile strength, ksi	Typical yield strength (0.2% offset), ksi	Typical elongation in 2 in., %
ANSI	ASTM			
360.0	SG100B	44	25	2.5
A360.0	SG100A	46	24	3.5
380.0	SC84B	46	23	2.5
A380.0	SC84A	47	23	3.5
383.0	SC102A	45	22	3.5
384.0	SC114A	48	24	2.5
390.0	SC174A	40.5	35	< 1
B390.0	SC174B	46	36	< 1
392.0	S19	42	39	< 1
413.0	S12B	43	21	2.5
A413.0	S12A	42	19	3.5
C443.0	S5C	33	14	9.0
518.0	G8A	45	28	5

ksi × 6.895 = MPa

**Aluminum Conductors** On a weight basis, aluminum has twice the electrical conductance of copper; on a volume basis, the conductivity of aluminum is about 62 percent that of copper. For electrical applications, a special, high-purity grade of aluminum is used (designated 1350, also referred to as EC) or alloyed to improve strength with minimum sacrifice in conductivity. Table 6.4.8 lists common conductor alloys and gives their strengths and conductivities in various forms and treatments. In power transmission lines, the necessary strength for long spans is

Table 6.4.6 Mechanical Properties of Aluminum Fasteners

Alloy and temper	Minimum tensile strength, ksi	Minimum shear strength, ksi
2024-T4	62	37
6061-T6	42	25
7075-T73	68	41

ksi × 6.895 = MPa

Table 6.4.7 Minimum Shear Strength of Aluminum Rivets

Alloy and temper before driving	Minimum shear strength, ksi
1100-H14	9.5
2017-T4	33
2117-T4	26
5056-H32	25
6053-T61	20
6061-T6	25
7050-T7	39

ksi × 6.895 = MPa

Table 6.4.8 Aluminum Electrical Conductors

Product, alloy, treatment* (size)	Ultimate tensile strength, ksi	Min. electrical conductivity, % IACS
<b>Drawing stock (rod)</b>		
1350-O (0.375- to 1.000-in diam)	8.5–14.0	61.8
1350-H12 and H22 (0.375- to 1.000-in diam)	12.0–17.0	61.5
1350-H14 and H24 (0.375- to 1.000-in diam)	15.0–20.0	61.4
1350-H16 and H26 (0.375- to 1.000-in diam)	17.0–22.0	61.3
5005-O (0.375-in diam)	14.0–20.0	54.3
5005-H12 and H22 (0.375-in diam)	17.0–23.0	54.0
5005-H14 and H24 (0.375-in diam)	20.0–26.0	53.9
5005-H16 and H26 (0.375-in diam)	24.0–30.0	53.8
8017-H12 and H22 (0.375-in diam)	16.0–22.0	58.0
8030-H12 (0.375-in diam)	16.0–20.5	60.0
8176-H14 (0.375-in diam)	16.0–20.0	59.0
8177-H13 and H23 (0.375-in diam)	16.0–22.0	58.0
<b>Wire</b>		
1350-H19 (0.0801- to 0.0900-in diam)	26.0 min	61.0
5005-H19 (0.0801- to 0.0900-in diam)	37.0 min	53.5
6201-T81 (0.0612- to 0.1327-in diam)	46.0 min	52.5
8176-H24 (0.0500- to 0.2040-in diam)	15.0 min	61.0
<b>Extrusions</b>		
1350-H111 (all)	8.5 min	61.0
6101-H111 (0.250 to 2.000 in thick)	12.0 min	59.0
6101-T6 (0.125 to 0.500 in thick)	29.0 min	55.0
6101-T61 (0.125 to 0.749 in thick)	20.0 min	57.0
6101-T61 (0.750 to 1.499 in thick)	18.0 min	57.0
6101-T61 (1.500 to 2.000 in thick)	15.0 min	57.0
<b>Rolled bar</b>		
1350-H12 (0.125 to 1.000 in thick)	12.0 min	61.0
<b>Sawed plate bar</b>		
1350-H112 (0.125 to 0.499 in thick)	11.0 min	61.0
1350-H112 (0.500 to 1.000 in thick)	10.0 min	61.0
1350-H112 (1.001 to 1.500 in thick)	9.0 min	61.0
<b>Sheet</b>		
1350-O (0.006 to 0.125 in thick)	8.0–14.0	61.8

ksi × 6.895 = MPa, in × 25.4 = mm

IACS = International Annealed Copper Standard.

\* Treatments: O = annealed; H = cold-worked; T = heat-treated

obtained by stranding aluminum wires about a core wire of steel (ACSR) or a higher-strength aluminum alloy.

## BEARING METALS

by Frank E. Goodwin

REFERENCES: Current edition of ASM "Metals Handbook." Publications of the various metal producers. Trade association literature containing material properties. Applicable current ASTM and SAE Standards.

**Babbitt metal** is a general term used for soft tin and lead-base alloys which are cast as bearing surfaces on steel, bronze, or cast-iron shells. Babbitts have excellent **embedability** (ability to embed foreign particles in itself) and **conformability** (ability to deform plastically to compensate for irregularities in bearing assembly) characteristics. These alloys may be run satisfactorily against a soft-steel shaft. The limitations of Babbitt alloys are the tendency to spread under high, steady loads and to fatigue under high, fluctuating loads. These limitations apply more particularly at higher temperatures, for increase in temperature between 68 and 212°F (20 and 100°C) reduces the metal's strength by 50 percent. These limitations can be overcome by properly designing the thickness and rigidity of the backing material, properly choosing the Babbitt alloy for good mechanical characteristics, and ensuring a good bond between backing and bearing materials.

The important tin- and lead-base (Babbitt) bearing alloys are listed in Table 6.4.9. Alloys 1 and 15 are used in internal-combustion engines. Alloy 1 performs satisfactorily at low temperatures, but alloy 15, an arsenic alloy, provides superior performance at elevated temperatures by virtue of its better high-temperature hardness, ability to support higher loads, and longer fatigue life. Alloys 2 and 3 contain more antimony, are harder, and are less likely to pound out. Alloys 7 and 8 are lead-base Babbitts which will function satisfactorily under moderate conditions of load and speed. Alloy B is used for diesel engine bearings. In general, increasing the lead content in tin-based Babbitt provides higher hardness, greater ease of casting, but lower strength values.

**Silver lined bearings** have an excellent record in heavy-duty applications in aircraft engines and diesels. For reciprocating engines, silver bearings normally consist of electrodeposited silver on a steel backing with an overlay of 0.001 to 0.005 in of lead. An indium flash on top of the lead overlay is used to increase corrosion resistance of the material.

**Aluminum and zinc alloys** are used for high-load, low-speed applications but have not replaced Babbitts for equipment operating under a steady high-speed load. The Al 20 to 30, Sn 3 copper alloy is bonded to a steel bearing shell. The Al 6.25, Sn 1, Ni 1, copper alloy can be either used as-cast or bonded to a bearing shell. The Al 3 cadmium alloy with varying amounts of Si, Cu, and Ni can also be used in either of these two ways. The Zn 11, Al 1, Cu 0.02, magnesium (ZA-12) and Zn 27, Al 2, Cu 0.01 magnesium (ZA-27) alloys are used in cast form, especially in continuous-cast hollow-bar form.

Mention should be made of **cast iron** as a bearing material. The flake

graphite in cast iron develops a glazed surface which is useful at surface speeds up to 130 ft/min and at loads up to 150 lb/in<sup>2</sup> approx. Because of the poor conformability of cast iron, good alignment and freedom from dirt are essential.

**Copper-base bearing alloys** have a wide range of bearing properties that fit them for many applications. Used alone or in combination with steel, Babbitt (white metal), and graphite, the bronzes and copper-leads meet the conditions of load and speed given in Table 6.4.10. **Copper-lead alloys** are cast onto steel backing strips in very thin layers (0.02 in) to provide bearing surfaces.

Three families of copper alloys are used for bearing and wear-resistant alloys in cast form: **phosphor bronzes** (Cu-Sn), Cu-Sn-Pb alloys, and **manganese bronze, aluminum bronze, and silicon bronze**. Typical compositions and applications are listed in Table 6.4.10. Phosphor bronzes have residual phosphorus ranging from 0.1 to 1 percent. Hardness increases with phosphorus content. Cu-Sn-Pb alloys have high resistance to wear, high hardness, and moderate strength. The high lead compositions are well suited for applications where lubricant may be deficient. The Mn, Al, and Si bronzes have high tensile strength, high hardness, and good resistance to shock. They are suitable for a wide range of bearing applications.

**Porous bearing materials** are used in light- and medium-duty applications as small-sized bearings and bushings. Since they can operate for long periods without an additional supply of lubricant, such bearings are useful in inaccessible or inconvenient places where lubrication would be difficult. Porous bearings are made by pressing mixtures of copper and tin (bronze), and often graphite, Teflon, or iron and graphite, and sintering these in a reducing atmosphere without melting. Iron-based, oil-impregnated sintered bearings are often used. By controlling the conditions under which the bearings are made, porosity may be adjusted so that interconnecting voids of up to 35 percent of the total volume may be available for impregnation by lubricants. Applicable specifications for these bearings are given in Tables 6.4.11 and 6.4.12.

**Miscellaneous** A great variety of materials, e.g., rubber, wood, phenolic, carbon-graphite, ceramets, ceramics, and plastics, are in use for special applications. Carbon-graphite is used where contamination by oil or grease lubricants is undesirable (e.g., textile machinery, pharmaceutical equipment, milk and food processing) and for elevated-temperature applications. Notable among plastic materials are Teflon and nylon, the polycarbonate Lexan, and the acetal Delrin. Since Lexan and Delrin can be injection-molded easily, bearings can be formed quite economically from these materials.

## CEMENTED CARBIDES

by Don Graham

REFERENCE: Schwartzkopf and Kieffer, "Refractory Hard Metals," Macmillan. German, "Powder Metallurgy Science," 2d ed., Metal Powder Industries Federation. "Powder Metallurgy Design Manual," 2d ed., Metal Powder Industries Federation, Princeton, NJ. Goetzal, "Treatise on Powder Metallurgy," Interscience. Schwartzkopf, "Powder Metallurgy," Macmillan.

Table 6.4.9 Compositions and Properties of Some Babbitt Alloys

ASTM B23 grade	Composition, %					Compressive ultimate strength		Brinell hardness	
	Sn	Sb	Pb	Cu	As	68°F, lb/in <sup>2</sup>	20°C, MPa	68°F (20°C)	212°F (100°C)
1	91.0	4.5	0.35	4.5	—	12.9	88.6	17	8
2	89.0	7.5	0.35	3.5	—	14.9	103	24.5	12
3	84.0	8.0	0.35	8.0	—	17.6	121	27.0	14.5
7	10.0	15.0	74.5	0.5	0.45	15.7	108	22.5	10.5
8	5.0	15.0	79.5	0.5	0.45	15.6	108	20.0	9.5
15	1.0	16.0	82.5	0.5	1.10	—	—	21.0	13.0
Other alloys									
B	0.8	12.5	83.3	0.1	3.05	—	—		
ASTM B102, alloy Py 1815A	65	15	18	2	0.15	15	103	23	10

SOURCE: ASTM, reprinted with permission.

Table 6.4.10 Compositions, Properties, and Applications of Some Copper-Base Bearing Metals

Specifications	Composition, %						Minimum tensile strength		Applications
	Cu	Sn	Pb	Zn	P	Other	ksi	MPa	
C86100, SAE J462	64	—	—	24	—	3 Fe, 5 Al, 4 Mn	119	820	Extra-heavy-duty bearings
C87610, ASTM B30	90	—	0.2	5	—	4 Si	66	455	High-strength bearings
C90700, ASTM B505	89	11	0.3	—	0.2	—	44	305	Wormgears and wheels; high-speed low-load bearings
C91100	84	16	—	—	—	—	35	240	Heavy load, low-speed bearings
C91300	81	19	—	—	—	—	35	240	Heavy load, low-speed bearings
C93200, SAE J462	83	7	7	3	—	—	35	240	General utility bearings, automobile fittings
C93700, ASTM B22	80	10	10	—	—	—	35	240	High-speed, high-pressure bearings, good corrosion resistance
C93800, ASTM B584	78	7	15	—	—	—	30	205	General utility bearings, backing for Babbit bearings
C94300, ASTM B584	70	5	25	—	—	—	27	185	Low-load, high-speed bearings

SOURCE: ASTM, reprinted with permission.

**Cemented carbides** are a commercially and technically important class of composite material. Comprised primarily of hard tungsten carbide (WC) grains cemented together with a cobalt (Co) binder, they can contain major alloying additions of titanium carbide (TiC), titanium carbonitride (TiCN), tantalum carbide (TaC), niobium carbide (NbC), chromium carbide (CrC), etc., and minor additions of other elements. Because of the extremely high hardness, stiffness, and wear resistance of these materials, their primary use is in cutting tools for the material (usually metal, wood, composite, or rock) removal industry. Secondary applications are as varied as pen balls, food processing equipment, fuel pumps, wear surfaces, fishing line guide rings, and large high-pressure components. Since their introduction in the mid-1920s, a very large variety of grades of carbides has been developed and put into use in a diverse number of applications. They are ubiquitous throughout industry, particularly so in the high-production metalworking sector.

Most cemented carbide parts are produced by **powder metallurgical techniques**. Powders of WC, Co, and sometimes TiC and TaC are blended by either ball or attritor milling. The mixed powder is then **compacted** under very high pressure in appropriately shaped molds. Pressed parts are **sintered** at temperatures between 1,250 and 1,500°C, depending on the composition of the powder. During the sintering process, cobalt melts and wets the carbide particles. On cooling, cobalt “cements” the carbide grains together. Essentially complete densification takes place during sintering. While binder metals such as iron or nickel are sometimes used, cobalt is preferred because of its ability to wet the tungsten carbide. A cemented carbide workpiece should be as close as possible to its final shape before sintering, for the final product is extremely hard and can be shaped further only by grinding with silicon carbide or diamond wheels.

The metal removal industry consumes most of the cemented carbide that is produced. Tips having unique geometries, called **inserts**, are pressed and sintered. Many of these pressed and sintered parts are ready for use directly after sintering. Others are finish-ground and/or honed to

close tolerances, often with a slight radius imparted to the cutting edge. Both procedures induce longer tool life between sharpenings.

The first cemented carbides developed consisted only of WC and Co. As cutting speeds increased, temperatures at the tool/workpiece interface increased. In the presence of iron or steel at high temperatures, carbide tools interact chemically with the work material and result in “cratering,” or removal of tool material at the cutting edge. Additions of secondary carbides like TiC and TaC minimize cratering by virtue of their greater chemical stability. Because of the desire for even higher metal removal rates (and accompanying higher temperatures), **chemical vapor deposition (CVD)** overlay coatings were developed. Titanium carbide coatings became available in 1969; titanium nitride coatings followed shortly after that. Aluminum oxide coatings for very high-speed operations first appeared in 1973. Coatings usually result in tool life increases of 50 percent; in some extreme cases, phenomenal increases of 10,000 percent have been reported. The CVD coatings have the synergistic effect not only to increase wear resistance (i.e., reduce cratering), but also to allow much higher cutting speeds (i.e., operating cutting temperatures).

In the late 1980s, **physical vapor deposition (PVD)** coatings became popular for specific applications. Coatings such as titanium nitride (TiN), titanium aluminum nitride (TiAlN), titanium carbonitride (TiCN), zirconium nitride (ZrN), chromium-based coatings, and amorphous coatings are used for special-purpose applications such as machining of high-temperature alloys, machining of ductile irons at low speeds, and as wear surfaces. About 70 percent of all cemented carbide tools sold today are coated, strong testimony to the effectiveness of coatings.

#### Design Considerations

Cemented carbide, in common with all **brittle materials**, may fragment in service, particularly under conditions of impact or upon release from high compressive loading. Precautionary measures must be taken to

Table 6.4.11 Oil-Impregnated Iron-Base Sintered Bearings (ASTM Standard B439-83)

Element	Composition, %			
	Grade 1	Grade 2	Grade 3	Grade 4
Copper			7.0–11.0	18.0–22.0
Iron	96.25 min	95.9 min	Remainder*	Remainder*
Total other elements by difference, max	3.0	3.0	3.0	3.0
Combined carbon† (on basis of iron only)	0.25 max	0.25–0.60	—	—
Silicon, max	0.3	0.3	—	—
Aluminum, max	0.2	0.2	—	—

\* Total of iron plus copper shall be 97% min.

† The combined carbon may be a metallographic estimate of the carbon in the iron.

SOURCE: ASTM, reprinted with permission.

Table 6.4.12 Oil-Impregnated Sintered Bronze Bearings (ASTM Standard B438-83)

Element	Composition, %			
	Grade 1		Grade 2	
	Class A	Class B	Class A	Class B
Copper	87.5–90.5	87.5–90.5	82.6–88.5	82.6–88.5
Tin	9.5–10.5	9.5–10.5	9.5–10.5	9.5–10.5
Graphite, max	0.1	1.75	0.1	1.75
Lead	*	*	2.0–4.0	2.0–4.0
Iron, max	1.0	1.0	1.0	1.0
Total other elements by difference, max	0.5	0.5	1.0	1.0

\* Included in other elements.

SOURCE: ASTM, reprinted with permission.

ensure that personnel and equipment are protected from flying fragments and sharp edges when working with carbides.

Failure of brittle materials frequently occurs as a result of tensile stress at or near the surface; thus the strength of brittle materials is very dependent on surface conditions. Chips, scratches, thermal cracks, and grinding marks, which decrease the strength and breakage resistance of cemented carbide parts, should be avoided. Even electric-discharge machined (EDM) surfaces should be ground or lapped to a depth of 0.05 mm to remove damaged material.

Special care must be taken when one is grinding cemented carbides. Adequate ventilation of grinding spaces must comply with existing government regulations applicable to the health and safety of the workplace environment. During the fabrication of cemented carbide parts, particularly during grinding of tools and components, adequate provisions must be made for the removal and collection of generated dusts and cutting fluid mists that contain microscopic metal particles, even though those concentrations may be very low. Although the elements contained in these alloys are not radioactive, note that they may become radioactive when exposed to a sufficiently strong radiation source. The cobalt in the cemented carbide alloys, in particular, could be made radioactive.

### Physical and Mechanical Properties

Typical property data are shown in Table 6.4.13. In addition to being an effective binder, cobalt is the primary component that determines mechanical properties. For example, as cobalt content increases, toughness increases but hardness and wear resistance decrease. This tradeoff is illustrated in Table 6.4.13. A secondary factor that affects mechanical properties is WC grain size. Finer grain size leads to increased hardness and wear resistance but lower toughness.

**Mechanical Properties** The outstanding feature of these materials is their hardness, high compressive strength, stiffness, and wear resistance. Unfortunately, but as might be expected of hard materials, toughness and ductility of carbides are low. Table 6.4.13 lists some **mechanical** and **physical property** data for typical and popular cemented carbide compositions.

**Hardness and Wear Resistance** Most applications of cemented carbide alloys involve wear and abrasive conditions. In general, the wear resistance of these materials can be estimated based on hardness. Note that wear is a complex process and can occur by means other than normal abrasion. Should wear occur by microchipping, fracture, chemical attack, or metallurgical interactions, it will be obvious that performance does not correlate directly with hardness.

The data presented in Table 6.4.13 under the heading Abrasion Resistance were determined by using an abrasive wheel. Results from this simplified test should be used only as a rough guide in the selection of those alloys, since abrasive wear that occurs under actual service conditions is usually complex and varies greatly with particular circumstances. The performance characteristics of a given grade are, of course, best determined under actual service conditions.

In many applications, cemented carbides are subjected to relatively

high operating temperatures. For example, the temperatures of the interface between the chip and the cutting edge of a carbide cutting tool may reach between 500 and 1,100°C. Wear parts may have point contact temperatures in this range. The extent to which the cemented carbide maintains its hardness at the elevated temperatures encountered in use is an important consideration. The cemented carbides not only have high room-temperature hardness, but also maintain hardness at elevated temperatures better than do steels and cast alloys.

**Corrosion Resistance** The corrosion resistance of the various cemented carbide alloys is fairly good when compared with other materials, and they may be employed very advantageously in some corrosive environments where outstanding wear resistance is required. Generally they are not employed where corrosion resistance alone is the requirement because other materials usually can be found which are either cheaper or more corrosion-resistant.

Corrosion may cause strength deterioration due to the preferential attack on the binder matrix phase. This results in the creation of microscopic surface defects to which cemented carbides, in common with other brittle materials, are sensitive.

Special corrosion-resistant grades have been developed in which the cobalt binder has been modified or replaced by other metals or alloys, resulting in improved resistance to acid attack. Other factors such as temperature, pressure, and surface condition may significantly influence corrosive behavior, so that specific tests under actual operating conditions should be performed when possible to select a cemented carbide grade for service under corrosive conditions.

### Micrograin Carbides

As **carbide grain size decreases**, hardness increases but toughness decreases. However, once the WC grain size diameter drops below approximately 1  $\mu\text{m}$ , this tradeoff becomes much more favorable. Further decreases in grain size result in further increase in hardness but are accompanied by a much smaller drop in toughness. As a result, **micrograin cemented carbides** have outstanding hardness, wear resistance, and compressive strength combined with surprising toughness. This combination of properties makes these grades particularly useful in machining nickel-, cobalt-, and iron-based superalloys and other difficult-to-machine alloys, such as refractories and titanium alloys.

### Cermets

Another class of cemented carbides is called **cermets**. These alloys usually are composed of TiC or TiCN with a binder of nickel, nickel-iron, or nickel-molybdenum with small amounts of other elements such as cobalt. These alloys usually find application in the high-speed finish machining of steels, stainless steels, and occasionally, cast irons and high-temperature alloys. As a rule, cermets are wear-resistant but less tough than traditional cemented tungsten carbides. Recent processing improvements, such as sinter HIP (hot isostatic pressing) and a better understanding of the alloying characteristics of cermets, have helped improve their toughness immensely, so that very tough cermets are currently available.

**Table 6.4.13 Properties of Cemented Carbides**

Composition, wt. %	Grain size, $\mu\text{m}$	Hardness, $R_a$	Abrasion resistance, 1/vol. loss $\text{cm}^3$	Density, $\text{g}/\text{cm}^3$	Transverse rupture strength, 1,000 $\text{lb}/\text{in}^2$	Ultimate compressive strength, 1,000 $\text{lb}/\text{in}^2$	Ultimate tensile strength, 1,000 $\text{lb}/\text{in}^2$	Modulus of elasticity, $10^6 \text{ lb}/\text{in}^2$	Proportional limit, 1,000 $\text{lb}/\text{in}^2$	Ductility, % elong	Fracture toughness, $(\text{lb}/\text{in}^2)(\sqrt{\text{in}})$	Thermal expansion 75 to 400°F, $\text{in}/(\text{in} \cdot ^\circ\text{F}) \times 10^{-6}$	Thermal conductivity, $\text{cal}/(\text{s} \cdot ^\circ\text{C} \cdot \text{cm})$	Electrical resistivity, $\mu\Omega \cdot \text{cm}$
WC-3% Co	1.7	93	60	15.3	290	850		98	350			2.2	0.3	17
WC-6% Co	0.8	93.5	62	15										
WC-6% Co	1.1	92.8	60	15	335	860	160	92	370	0.2		2.9		
WC-6% Co	2.1	92	35	15	380	790		92	280		9,200	2.5	0.25	17
WC-6% Co	3	91	15	15	400	750	220	92	210		11,500	2.4	0.25	17
WC-9% Co	4	89.5	10	14.7	425	660		87	140		13,000	2.7	0.25	
WC-10% Co	1.8	91	13	14.6	440	750		85	230		11,500			
WC-10% Co	5.2	89	7	14.5	460	630		85	130			2.5		17
WC-13% Co	4	88.2	4	14.2	500	600		81	140	0.3	14,500	3	0.25	17
WC-16% Co	4	86.8	3	13.9	500	560	270	77	100	0.4	15,800	3.2	0.02	
WC-25% Co	3.7	84	2	13	440	450		67	60		21,000	3.5	0.2	18
Other materials*														
Tool steel (T-8)		85 (66 $R_c$ )	2	8.4	575	600		34				6.5		
Carbon steel (1095)		79 (55 $R_c$ )		7.8			300	30					0.12	20
Cast iron				7.3	105			15-30						
Copper				8.9								9.2	0.94	1.67

\*Data for other materials are included to aid in comparing carbide properties with those of the referenced materials.



## COPPER AND COPPER ALLOYS

by Arthur Cohen

REFERENCES: ASM "Metals Handbook," Applicable current ASTM and SAE Standards. Publications of the Copper Development Association Standards promulgated by industrial associations related to specific types of products.

**Copper and copper alloys** constitute one of the major groups of commercial metals. They are widely used because of their excellent electrical and thermal conductivities, outstanding corrosion resistance, and ease of fabrication. They are generally nonmagnetic and can be readily joined by conventional soldering, brazing, and welding processes (gas and resistance).

**Primary Copper**

Copper used in the manufacture of fabricated brass mill or wire and cable products may originate in the ore body of open-pit or underground mines or from rigidly controlled recycled high-grade copper scrap.

Traditional sulfide ores require conventional crushing, milling, concentration by flotation, smelting to form a matte, conversion to blister copper, and final refining by either the **electrolytic** or the **electrowinning** processes to produce copper cathode, which is fully described in ASTM B115 Electrolytic Cathode Copper. This **electrochemical refining** step results in the deposition of virtually pure copper, with the major impurity being oxygen.

Probably the single most important innovation in the copper industry in the past 30 years has been the introduction of **continuous cast wire rod** technology. Within this period, the traditional 250-lb wire bar has been almost completely replaced domestically (and largely internationally) with continuous cast wire rod product produced to meet the requirements of ASTM B49 Copper Redraw Rod for Electrical Purposes.

**Generic Classification of Copper Alloys**

The most common way to categorize wrought and cast copper and copper alloys is to divide them into six families: coppers, high-copper alloys, brasses, bronzes, copper nickels, and nickel silvers. They are further subdivided and identified via the **Unified Numbering System (UNS)** for metals and alloys.

The designation system is an orderly method of defining and identifying the alloys. The copper section is administered by the Copper Development Association, but it is not a specification. It eliminates the limitations and conflicts of alloy designations previously used and at the same time provides a workable method for the identification marking of mill and foundry products.

In the designation system, numbers from C10000 through C79999 denote **wrought alloys**. **Cast alloys** are numbered from C80000 through C999999. Within these two categories, compositions are further grouped into families of coppers and copper alloys shown in Table 6.4.14.

**Coppers** These metals have a designated minimum copper content of 99.3 percent or higher.

**High-Copper Alloys** In wrought form, these are alloys with designated copper contents less than 99.3 percent but more than 96 percent which do not fall into any other copper alloy group. The cast high-copper alloys have designated copper contents in excess of 94 percent, to which silver may be added for special properties.

**Brasses** These alloys contain zinc as the principal alloying element with or without other designated alloying elements such as iron, aluminum, nickel, and silicon. The wrought alloys comprise three main families of brasses: copper-zinc alloys; copper-zinc-lead alloys (leaded brasses); and copper-zinc-tin alloys (tin brasses). The cast alloys comprise four main families of brasses: copper-tin-zinc alloys (red, semired, and yellow brasses); **manganese bronze** alloys (high-strength yellow brasses); leaded manganese bronze alloys (leaded high-strength yellow brasses); and copper-zinc-silicon alloys (silicon brasses and bronzes). Ingot for remelting for the manufacture of castings may vary slightly from the ranges shown.

**Bronzes** Broadly speaking, bronzes are copper alloys in which the major element is not zinc or nickel. Originally *bronze* described alloys with tin as the only or principal alloying element. Today, the term generally is used not by itself, but with a modifying adjective. For wrought alloys, there are four main families of bronzes: copper-tin-phosphorus alloys (phosphor bronzes); copper-tin-lead-phosphorus alloys (leaded phosphor bronzes); copper-aluminum alloys (aluminum bronzes); and copper-silicon alloys (silicon bronzes).

The cast alloys comprise four main families of bronzes: copper-tin alloys (tin bronzes); copper-tin-lead alloys (leaded and high leaded tin

**Table 6.4.14 Generic Classification of Copper Alloys**

Generic name	UNS Nos.	Composition
<b>Wrought alloys</b>		
Coppers	C10100–C15815	> 99% Cu
High-copper alloys	C16200–C19900	> 96% Cu
Brasses	C21000–C28000	Cu-Zn
Leaded brasses	C31200–C38500	Cu-Zn-Pb
Tin brasses	C40400–C48600	Cu-Zn-Sn-Pb
Phosphor bronzes	C50100–C52400	Cu-Sn-P
Leaded phosphor bronzes	C53200–C54400	Cu-Sn-Pb-P
Copper-phosphorus and copper-silver-phosphorus alloys	C55180–C55284	Cu-P-Ag
Aluminum bronzes	C60800–C64210	Cu-Al-Ni-Fe-Si-Sn
Silicon bronzes	C64700–C66100	Cu-Si-Sn
Other copper-zinc alloys	C66400–C69710	—
Copper nickels	C70100–C72950	Cu-Ni-Fe
Nickel silvers	C73500–C79800	Cu-Ni-Zn
<b>Cast alloys</b>		
Coppers	C80100–C81200	> 99% Cu
High-copper alloys	C81400–C82800	> 94% Cu
Red and leaded red brasses	C83300–C84800	Cu-Zn-Sn-Pb (75–89% Cu)
Yellow and leaded yellow brasses	C85200–C85800	Cu-Zn-Sn-Pb (57–74% Cu)
Manganese bronzes and leaded manganese bronzes	C86100–C86800	Cu-Zn-Mn-Fe-Pb
Silicon bronzes, silicon brasses	C87300–C87800	Cu-Zn-Si
Tin bronzes and leaded tin bronzes	C90200–C94500	Cu-Sn-Zn-Pb
Nickel-tin bronzes	C94700–C94900	Cu-Ni-Sn-Zn-Pb
Aluminum bronzes	C95200–C95900	Cu-Al-Fe-Ni
Copper nickels	C96200–C96900	Cu-Ni-Fe
Nickel silvers	C97300–C97800	Cu-Ni-Zn-Pb-Sn
Leaded coppers	C98200–C98840	Cu-Pb
Miscellaneous alloys	C99300–C99750	—

Table 6.4.15 ASTM B601 Temper Designation Codes for Copper and Copper Alloys

Temper designation	Former temper name or material conditioned	Temper designation	Former temper name or material condition	Temper designation	Former temper name or material condition
Cold-worked tempers <sup>a</sup>		Annealed tempers <sup>d</sup>		Mill-hardened tempers	
H00	1/8 hard	O10	Cast and annealed (homogenized)	TM00	AM
H01	1/4 hard	O11	As cast and precipitation heat-treated	TM01	1/4 HM
H02	1/2 hard	O20	Hot-forged and annealed	TM02	1/2 HM
H03	3/4 hard	O25	Hot-rolled and annealed	TM04	HM
H04	Hard	O30	Hot-extruded and annealed	TM06	XHM
H06	Extra hard	O31	Extruded and precipitation heat-treated	TM08	XHMS
H08	Spring	O40	Hot-pierced and annealed	Quench-hardened tempers	
H10	Extra spring	O50	Light anneal	TQ00	Quench-hardened
H12	Special spring	O60	Soft anneal	TQ30	Quench-hardened and tempered
H13	Ultra spring	O61	Annealed	TQ50	Quench-hardened and temper-annealed
H14	Super spring	O65	Drawing anneal	TQ55	Quench-hardened and temper-annealed, cold-drawn and stress-relieved
Cold-worked tempers <sup>b</sup>		O68	Deep-drawing anneal	TQ75	Interrupted quench-hardened
H50	Extruded and drawn	O70	Dead soft anneal	Precipitation-hardened, cold-worked, and thermal-stress-relieved tempers	
H52	Pierced and drawn	O80	Annealed to temper-1/8 hard	TR01	TL01 and stress-relieved
H55	Light drawn	O81	Annealed to temper-1/4 hard	TR02	TL02 and stress-relieved
H58	Drawn general-purpose	O82	Annealed to temper-1/2 hard	TR04	TL04 and stress-relieved
H60	Cold heading; forming	Annealed tempers <sup>e</sup>		Tempers of welded tubing <sup>f</sup>	
H63	Rivet	OS005	Nominal Avg. grain size, 0.005 mm	WH00	Welded and drawn: 1/8 hard
H64	Screw	OS010	Nominal Avg. grain size, 0.010 mm	WH01	Welded and drawn: 1/4 hard
H66	Bolt	OS015	Nominal Avg. grain size, 0.015 mm	WH02	Welded and drawn: 1/2 hard
H70	Bending	OS025	Nominal Avg. grain size, 0.025 mm	WH03	Welded and drawn: 3/4 hard
H80	Hard-drawn	OS035	Nominal Avg. grain size, 0.035 mm	WH04	Welded and drawn: full hard
H85	Medium hard-drawn electrical wire	OS050	Nominal Avg. grain size, 0.050 mm	WH06	Welded and drawn: extra hard
H86	Hard-drawn electrical wire	OS060	Nominal Avg. grain size, 0.060 mm	WM00	As welded from H00 (1/8-hard) strip
H90	As-finned	OS070	Nominal Avg. grain size, 0.070 mm	WM01	As welded from H01 (1/4-hard) strip
Cold-worked and stress-relieved tempers		OS100	Nominal Avg. grain size, 0.100 mm	WM02	As welded from H02 (1/2-hard) strip
HR01	H01 and stress-relieved	OS120	Nominal Avg. grain size, 0.120 mm	WM03	As welded from H03 (3/4-hard) strip
HR02	H02 and stress-relieved	OS150	Nominal Avg. grain size, 0.150 mm	WM04	As welded from H04 (hard) strip
HR04	H04 and stress-relieved	OS200	Nominal Avg. grain size, 0.200 mm	WM06	As welded from H06 (extra hard) strip
HR08	H08 and stress-relieved	Solution-treated temper		WM08	As welded from H08 (spring) strip
HR10	H10 and stress-relieved	TB00	Solution heat-treated (A)	WM10	As welded from H10 (extra spring) strip
HR20	As-finned	Solution-treated and cold-worked tempers		WM15	WM50 and stress-relieved
HR50	Drawn and stress-relieved	TD00	TB00 cold-worked: 1/8 hard	WM20	WM00 and stress-relieved
Cold-rolled and order-strengthened tempers <sup>c</sup>		TD01	TB00 cold-worked: 1/4 hard	WM21	WM01 and stress-relieved
HT04	H04 and treated	TD02	TB00 cold-worked: 1/2 hard	WM22	WM02 and stress-relieved
HT08	H08 and treated	TD03	TB00 cold-worked: 3/4 hard	WM50	As welded from annealed strip
As-manufactured tempers		TD04	TB00 cold-worked: hard	W050	Welded and light annealed
M01	As sand cast	Solution treated and precipitation-hardened temper		WR00	WM00; drawn and stress-relieved
M02	As centrifugal cast	TF00	TB00 and precipitation-hardened	WR01	WM01; drawn and stress-relieved
M03	As plaster cast	Cold-worked and precipitation-hardened tempers		WR02	WM02; drawn and stress-relieved
M04	As pressure die cast	TH01	TD01 and precipitation-hardened	WR03	WM03; drawn and stress-relieved
M05	As permanent mold cast	TH02	TD02 and precipitation-hardened	WR04	WM04; drawn and stress-relieved
M06	As investment cast	TH03	TD03 and precipitation-hardened	WR06	WM06; drawn and stress-relieved
M07	As continuous cast	TH04	TD04 and precipitation-hardened		
M10	As hot-forged and air-cooled	Precipitation-hardened or spinodal heat treated and cold-worked tempers			
M11	As forged and quenched	TL00	TF00 cold-worked: 1/8 hard		
M20	As hot-rolled	TL01	TF01 cold-worked: 1/4 hard		
M30	As hot-extruded	TL02	TF00 cold-worked: 1/2 hard		
M40	As hot-pierced	TL04	TF00 cold-worked: hard		
M45	As hot-pierced and rerolled	TL08	TF00 cold-worked: spring		
		TL10	TF00 cold-worked: extra spring		

<sup>a</sup> Cold-worked tempers to meet standard requirements based on cold rolling or cold drawing.

<sup>b</sup> Cold-worked tempers to meet standard requirements based on temper names applicable to specific products.

<sup>c</sup> Tempers produced by controlled amounts of cold work followed by a thermal treatment to produce order strengthening.

<sup>d</sup> Annealed to meet mechanical properties.

<sup>e</sup> Annealed to meet nominal average grain size.

<sup>f</sup> Tempers of fully finished tubing that has been drawn or annealed to produce specified mechanical properties or that has been annealed to produce a prescribed nominal average grain size are commonly identified by the property H, O, or OS temper designation.

SOURCE: ASTM, reprinted with permission.

bronzes); copper-tin-nickel alloys (nickel-tin bronzes); and copper-aluminum alloys (aluminum bronzes).

The family of alloys known as **manganese bronzes**, in which zinc is the major alloying element, is included in the brasses.

**Copper-Nickels** These are alloys with nickel as the principal alloying element, with or without other designated alloying elements.

**Copper-Nickel-Zinc Alloys** Known commonly as **nickel silvers**, these are alloys which contain zinc and nickel as the principal and secondary alloying elements, with or without other designated elements.

**Leaded Coppers** These comprise a series of cast alloys of copper with 20 percent or more lead, sometimes with a small amount of silver, but without tin or zinc.

**Miscellaneous Alloys** Alloys whose chemical compositions do not fall into any of previously described categories are combined under "miscellaneous alloys."

### Temper Designations

**Temper designations** for wrought copper and copper alloys were originally specified on the basis of cold reduction imparted by the rolling of sheet or drawing of wire. Designations for rod, seamless tube, welded tube, extrusions, castings and heat-treated products were not covered. In 1974, ASTM B601 Standard Practice for Temper Designations for Copper and Copper Alloys—Wrought and Cast, based on an alphanumeric code, was created to accommodate this deficiency. The general temper designation codes listed in ASTM B601 by process and product are shown in Table 6.4.15.

### Coppers

Coppers include the **oxygen-free coppers** (C10100 and C10200), made by melting prime-quality cathode copper under nonoxidizing conditions. These coppers are particularly suitable for applications requiring high electrical and thermal conductivities coupled with exceptional ductility and freedom from hydrogen embrittlement.

The most common copper is C11000—**electrolytic tough pitch**. Its electrical conductivity exceeds 100 percent IACS and is invariably selected for most wire and cable applications. Selective properties of wire produced to ASTM B1 Hard Drawn Copper Wire, B2 Medium Hard Drawn Copper Wire, and B3 Soft or Annealed Copper Wire are shown in Table 6.4.16.

Where resistance to softening along with improved fatigue strength is required, small amounts of silver are added. This permits the silver-containing coppers to retain the effects of cold working to a higher temperature than pure copper (about 600°F versus about 400°F), a property particularly useful where comparatively high temperatures are to be withstood, as in soldering operations or for stressed conductors designed to operate at moderately elevated temperatures.

If superior **machinability** is required, C14500 (tellurium copper), C14700 (sulfur copper), or C18700 (leaded copper) can be selected. With these coppers, superior machinability is gained at a modest sacrifice in electrical conductivity.

Similarly, chromium and zirconium are added to increase elevated-temperature strength with little decrease in conductivity.

Copper-beryllium alloys are **precipitation-hardening alloys** that combine moderate conductivity with very high strengths. To achieve these properties, a typical heat treatment would involve a solution heat treatment for 1 h at 1,450°F (788°C) followed by water quenching, then a precipitation heat treatment at 600°F (316°C) for 3 h.

### Wrought Copper Alloys (Brasses and Bronzes)

There are approximately 230 wrought brass and bronze compositions. The most widely used is alloy C26000, which corresponds to a 70:30 copper-zinc composition and is most frequently specified unless high corrosion resistance or special properties of other alloys are required. For example, alloy C36000—free-cutting brass—is selected when extensive machining must be done, particularly on automatic screw machines. Other alloys containing aluminum, silicon, or nickel are specified for their outstanding corrosion resistance. The other properties of greatest importance include mechanical strength, fatigue resistance, ability to take a good finish, corrosion resistance, electrical and thermal conductivities, color, ease of fabrication, and machinability.

The bronzes are divided into five alloy families: phosphor bronzes, aluminum bronzes, silicon bronzes, copper nickels, and nickel silvers.

**Phosphor Bronzes** Three tin bronzes, commonly referred to as **phosphor bronzes**, are the dominant alloys in this family. They contain 5, 8, and 10 percent tin and are identified, respectively, as alloys C51000, C52100, and C52400. Containing up to 0.4 percent phosphorus, which improves the casting qualities and hardens them somewhat, these alloys have excellent elastic properties.

**Aluminum Bronzes** These alloys with 5 and 8 percent aluminum find application because of their high strength and corrosion resistance, and sometimes because of their golden color. Those with 10 percent aluminum content or higher are very plastic when hot and have exceptionally high strength, particularly after heat treatment.

**Silicon Bronzes** There are three dominant alloys in this family in which silicon is the primary alloying agent but which also contain appreciable amounts of zinc, iron, tin, or manganese. These alloys are as corrosion-resistant as copper (slightly more so in some solutions) and possess excellent hot workability with high strengths. Their outstanding characteristic is that of ready weldability by all methods. The alloys are extensively fabricated by arc or acetylene welding into tanks and vessels for hot-water storage and chemical processing.

**Copper Nickels** These alloys are extremely malleable and may be worked extensively without annealing. Because of their excellent corrosion resistance, they are used for condenser tubes for the most severe service. Alloys containing nickel have the best high-temperature properties of any copper alloy.

**Nickel Silvers** Nickel silvers are white and are often applied because of this property. They are tarnish resistant under atmospheric conditions. Nickel silver is the base for most silver-plated ware.

Overall, the primary selection criteria can be met satisfactorily by one or more of the alloys listed in Table 6.4.17.

Table 6.4.16 Mechanical Properties of Copper Wire

Diameter		Hard-drawn			Medium hard		Soft or annealed	
		Tensile strength (nominal)		Elongation (nominal) in 10 in (250 mm), % min	Tensile strength		Elongation in 10 in (250 mm), % min	Elongation (nominal) in 10 in (250 mm), % min
in	mm	ksi	MPa		ksi	MPa		
0.460	11.7	49.0	340	3.8	42.0–49.0	290–340	3.8	35
0.325	8.3	54.5	375	2.4	45.0–52.0	310–360	3.0	35
0.229	5.8	59.0	405	1.7	48.0–55.0	330–380	2.2	30
0.162	4.1	62.1	430	1.4	49.0–56.0	340–385	1.5	30
0.114	2.9	64.3	445	1.2	50.0–57.0	345–395	1.3	30
0.081	2.05	65.7	455	1.1	51.0–58.0	350–400	1.1	25
0.057	1.45	66.4	460	1.0	52.0–59.0	360–405	1.0	25
0.040	1.02	67.0	460	1.0	53.0–60.0	365–415	1.0	25

SOURCE: ASTM, abstracted with permission.

Table 6.4.17 Composition and Properties of Selected Wrought Copper and Copper Alloys

Alloy no. (and name)	Nominal composition, %	Commercial forms <sup>a</sup>	Mechanical properties <sup>b</sup>				
			Tensile strength		Yield strength		Elongation in 2 in (50 mm), % <sup>b</sup>
			ksi	MPa	ksi	MPa	
C10200 (oxygen-free copper)	99.95 Cu	F, R, W, T, P, S	32–66	221–455	10–53	69–365	55–4
C11000 (electrolytic tough pitch copper)	99.90 Cu, 0.04 O	F, R, W, T, P, S	32–66	221–455	10–53	69–365	55–4
C12200 (phosphorus-deoxidized copper, high residual phosphorus)	99.90 Cu, 0.02 P	F, R, T, P	32–55	221–379	10–50	69–345	45–8
C14500 (phosphorus-deoxidized tellurium-bearing copper)	99.5 Cu, 0.50 Te, 0.008 P	F, R, W, T	32–56	221–386	10–51	69–352	50–3
C14700 (sulfur-bearing copper)	99.6 Cu, 0.40 S	R, W	32–57	221–393	10–55	69–379	52–8
C15000 (zirconium copper)	99.8 Cu, 0.15 Zr	R, W	29–76	200–524	6–72	41–496	54–1.5
C17000 (beryllium copper)	99.5 Cu, 1.7 Be, 0.20 Co	F, R	70–190	483–1,310	32–170	221–1,172	45–3
C17200 (beryllium copper)	99.5 Cu, 1.9 Be, 0.20 Co	F, R, W, T, P, S	68–212	469–1,462	25–195	172–1,344	48–1
C18200 (chromium copper)	99.0 Cu <sup>c</sup> , 1.0 Cr	F, W, R, S, T	34–86	234–593	14–77	97–531	40–5
C18700 (lead copper)	99.0 Cu, 1.0 Pb	R	32–55	221–379	10–50	69–345	45–8
C19400	97.5 Cu, 2.4 Fe, 0.13 Zn, 0.03 P	F	45–76	310–524	24–73	165–503	32–2
C21000 (gilding, 95%)	95.0 Cu, 5.0 Zn	F, W	34–64	234–441	10–58	69–400	45–4
C22000 (commercial bronze, 90%)	90.0 Cu, 10.0 Zn	F, R, W, T	37–72	255–496	10–62	69–427	50–3
C23000 (red brass, 85%)	85.0 Cu, 15.0 Zn	F, W, T, P	39–105	269–724	10–63	69–434	55–3
C24000 (low brass, 80%)	80.0 Cu, 20.0 Zn	F, W	42–125	290–862	12–65	83–448	55–3
C26000 (cartridge brass, 70%)	70.0 Cu, 30.0 Zn	F, R, W, T	44–130	303–896	11–65	76–448	66–3
C26800, C27000 (yellow brass)	65.0 Cu, 35.0 Zn	F, R, W	46–128	317–883	14–62	97–427	65–3
C28000 (Muntz metal)	60.0 Cu, 40.0 Zn	F, R, T	54–74	372–510	21–55	145–379	52–10
C31400 (lead commercial bronze)	89.0 Cu, 1.8 Pb, 9.2 Zn	F, R	37–60	255–414	12–55	83–379	45–10
C33500 (low-lead brass)	65.0 Cu, 0.5 Pb, 34.5 Zn	F	46–74	317–510	14–60	97–414	65–8
C34000 (medium-lead brass)	65.0 Cu, 1.0 Pb, 34.0 Zn	F, R, W, S	47–88	324–607	15–60	103–414	60–7
C34200 (high-lead brass)	64.5 Cu, 2.0 Pb, 33.5 Zn	F, R	49–85	338–586	17–62	117–427	52–5
C35000 (medium-lead brass)	62.5 Cu, 1.1 Pb, 36.4 Zn	F, R	45–95	310–655	13–70	90–483	66–1
C35300 (high-lead brass)	62.0 Cu, 1.8 Pb, 36.2 Zn	F, R	49–85	338–586	17–62	117–427	52–5
C35600 (extra-high-lead brass)	63.0 Cu, 2.5 Pb, 34.5 Zn	F	49–74	338–510	17–60	117–414	50–7
C36000 (free-cutting brass)	61.5 Cu, 3.0 Pb, 35.5 Zn	F, R, S	49–68	338–469	18–45	124–310	53–18
C36500 (to C36800 (lead Muntz metal) <sup>c</sup>	60.0 Cu <sup>c</sup> , 0.6 Pb, 39.4 Zn	F	54	372	20	138	45
C37000 (free-cutting Muntz metal)	60.0 Cu, 1.0 Pb, 39.0 Zn	T	54–80	372–552	20–60	138–414	40–6
C37700 (forging brass) <sup>d</sup>	59.0 Cu, 2.0 Pb, 39.0 Zn	R, S	52	359	20	138	45
C38500 (architectural bronze) <sup>d</sup>	57.0 Cu, 3.0 Pb, 40.0 Zn	R, S	60	414	20	138	30
C40500	95.0 Cu, 1.0 Sn, 4.0 Zn	F	39–78	269–538	12–70	83–483	49–3
C41300	90.0 Cu, 1.0 Sn, 9.0 Zn	F, R, W	41–105	283–724	12–82	83–565	45–2
C43500	81.0 Cu, 0.9 Sn, 18.1 Zn	F, T	46–80	317–552	16–68	110–469	46–7
C44300, C44400, C44500 (inhibited admiralty)	71.0 Cu, 28.0 Zn, 1.0 Sn	F, W, T	48–55	331–379	18–22	124–152	65–60
C46400 (to C46700 (naval brass))	60.0 Cu, 39.3 Zn, 0.7 Sn	F, R, T, S	55–88	379–607	25–66	172–455	50–17
C48200 (naval brass, medium-lead)	60.5 Cu, 0.7 Pb, 0.8 Sn, 38.0 Zn	F, R, S	56–75	386–517	25–53	172–365	43–15
C48500 (lead naval brass)	60.0 Cu, 1.8 Pb, 37.5 Zn, 0.7 Sn	F, R, S	55–77	379–531	25–53	172–365	40–15
C51000 (phosphor bronze, 5% A)	95.0 Cu, 5.0 Sn, trace P	F, R, W, T	47–140	324–965	19–80	131–552	64–2
C51100	95.6 Cu, 4.2 Sn, 0.2 P	F	46–103	317–710	50–80	345–552	48–2
C52100 (phosphor bronze, 8% C)	92.0 Cu, 8.0 Sn, trace P	F, R, W	55–140	379–965	24–80	165–552	70–2
C52400 (phosphor bronze, 10% D)	99.0 Cu, 10.0 Sn, trace P	F, R, W	66–147	455–1,014	28	193	70–3
C54400 (free-cutting phosphor bronze)	88.0 Cu, 4.0 Pb, 4.0 Zn, 4.0 Sn	F, R	44–75	303–517	19–63	131–434	50–16
C60800 (aluminum bronze, 5%)	95.0 Cu, 5.0 Al	T	60	414	27	186	55
C61000	92.0 Cu, 8.0 Al	R, W	70–80	483–552	30–55	207–379	65–25
C61300	92.7 Cu, 0.3 Sn, 7.0 Al	F, R, T, P, S	70–85	483–586	30–58	207–400	42–35
C61400 (aluminum bronze, D)	91.0 Cu, 7.0 Al, 2.0 Fe	F, R, W, T, P, S	76–89	524–614	33–60	228–414	45–32
C63000	82.0 Cu, 3.0 Fe, 10.0 Al, 5.0 Ni	F, R	90–118	621–814	50–75	345–517	20–15
C63200	82.0 Cu, 4.0 Fe, 9.0 Al, 5.0 Ni	F, R	90–105	621–724	45–53	310–365	25–20
C64200	91.2 Cu, 7.0 Al	F, R	75–102	517–703	35–68	241–469	32–22
C65100 (low-silicon bronze, B)	98.5 Cu, 1.5 Si	R, W, T	40–95	276–655	15–69	103–476	55–11
C65500 (high-silicon bronze, A)	97.0 Cu, 3.0 Si	F, R, W, T	56–145	386–1,000	21–70	145–483	63–3
C67500 (manganese bronze, A)	58.5 Cu, 1.4 Fe, 39.0 Zn, 1.0 Sn, 0.1 Mn	R, S	65–84	448–579	30–60	207–414	33–19
C68700 (aluminum brass, arsenical)	77.5 Cu, 20.5 Zn, 2.0 Al, 0.1 As	T	60	414	27	186	55
C70600 (copper nickel, 10%)	88.7 Cu, 1.3 Fe, 10.0 Ni	F, T	44–60	303–414	16–57	110–393	42–10
C71500 (copper nickel, 30%)	70.0 Cu, 30.0 Ni	F, R, T	54–75	372–517	20–70	138–483	45–15
C72500	88.2 Cu, 9.5 Ni, 2.3 Sn	F, R, W, T	55–120	379–827	22–108	152–745	35–1
C74500 (nickel silver, 65–10)	65.0 Cu, 25.0 Zn, 10.0 Ni	F, W	49–130	338–896	18–76	124–524	50–1
C75200 (nickel silver, 65–18)	65.0 Cu, 17.0 Zn, 18.0 Ni	F, R, W	56–103	386–710	25–90	172–621	45–3
C77000 (nickel silver, 55–18)	55.0 Cu, 27.0 Zn, 18.0 Ni	F, R, W	60–145	414–1,000	27–90	186–621	40–2
C78200 (lead nickel silver, 65–8–2)	65.0 Cu, 2.0 Pb, 25.0 Zn, 8.0 Ni	F	53–91	365–627	23–76	159–524	40–3

<sup>a</sup> F, flat products; R, rod; W, wire; T, tube; P, pipe; S, shapes.

<sup>b</sup> Ranges are from softest to hardest commercial forms. The strength of the standard copper alloys depends on the temper (annealed grain size or degree of cold work) and the section thickness of the mill product. Ranges cover standard tempers for each alloy.

<sup>c</sup> Values are for as-hot-rolled material.

<sup>d</sup> Values are for as-extruded material.

<sup>e</sup> Rod, 61.0 Cu min.

SOURCE: Copper Development Association Inc.

Machinability rating, % <sup>c</sup>	Melting point		Density, lb/in <sup>3</sup>	Specific gravity	Coefficient of thermal expansion × 10 <sup>-6</sup> at 77–572°F (25–300°C)	Electrical conductivity (annealed) % IACS	Thermal conductivity Btu · ft/(h · ft <sup>2</sup> · °F) [cal · cm/(s · cm <sup>2</sup> · °C)]
	Solidus, °F (°C)	Liquidus, °F (°C)					
20	1,981 (1,083)	1,981 (1,083)	0.323	8.94	9.8 (17.7)	101	226 (0.934)
20	1,949 (1,065)	1,981 (1,083)	0.321–0.323	8.89–8.94	9.8 (17.7)	101	226 (0.934)
20	1,981 (1,083)	1,981 (1,083)	0.323	8.94	9.8 (17.7)	85	196 (0.81)
85	1,924 (1,051)	1,967 (1,075)	0.323	8.94	9.9 (17.8)	93	205 (0.85)
85	1,953 (1,067)	1,969 (1,076)	0.323	8.94	9.8 (17.7)	95	216 (0.89)
20	1,796 (980)	1,976 (1,080)	0.321	8.89	9.8 (17.7)	93	212 (0.876)
20	1,590 (865)	1,800 (980)	0.304	8.41	9.9 (17.8)	22	62–75 (0.26–0.31)
20	1,590 (865)	1,800 (980)	0.298	8.26	9.9 (17.8)	22	62–75 (0.26–0.31)
20	1,958 (1,070)	1,967 (1,075)	0.321	8.89	9.8 (17.6)	80	187 (0.77)
85	1,747 (953)	1,976 (1,080)	0.323	8.94	9.8 (17.6)	96	218 (0.93)
20	1,980 (1,080)	1,990 (1,090)	0.322	8.91	9.8 (17.9)	65	150 (0.625)
20	1,920 (1,050)	1,950 (1,065)	0.320	8.86	10.0 (18.1)	56	135 (0.56)
20	1,870 (1,020)	1,910 (1,045)	0.318	8.80	10.2 (18.4)	44	109 (0.45)
30	1,810 (990)	1,880 (1,025)	0.316	8.75	10.4 (18.7)	37	92 (0.38)
30	1,770 (965)	1,830 (1,000)	0.313	8.67	10.6 (19.1)	32	81 (0.33)
30	1,680 (915)	1,750 (955)	0.308	8.53	11.1 (19.9)	28	70 (0.29)
30	1,660 (905)	1,710 (930)	0.306	8.47	11.3 (20.3)	27	67 (0.28)
40	1,650 (900)	1,660 (905)	0.303	8.39	11.6 (20.8)	28	71 (0.29)
80	1,850 (1,010)	1,900 (1,040)	0.319	8.83	10.2 (18.4)	42	104 (0.43)
60	1,650 (900)	1,700 (925)	0.306	8.47	11.3 (20.3)	26	67 (0.28)
70	1,630 (885)	1,700 (925)	0.306	8.47	11.3 (20.3)	26	67 (0.28)
90	1,630 (885)	1,670 (910)	0.306	8.47	11.3 (20.3)	26	67 (0.28)
70	1,640 (895)	1,680 (915)	0.305	8.44	11.3 (20.3)	26	67 (0.28)
90	1,630 (885)	1,670 (910)	0.306	8.47	11.3 (20.3)	26	67 (0.28)
100	1,630 (885)	1,660 (905)	0.307	8.50	11.4 (20.5)	26	67 (0.28)
100	1,630 (885)	1,650 (900)	0.307	8.50	11.4 (20.5)	26	67 (0.28)
60	1,630 (885)	1,650 (900)	0.304	8.41	11.6 (20.8)	28	71 (0.29)
70	1,630 (885)	1,650 (900)	0.304	8.41	11.6 (20.8)	27	69 (0.28)
80	1,620 (880)	1,640 (895)	0.305	8.44	11.5 (20.7)	27	69 (0.28)
90	1,610 (875)	1,630 (890)	0.306	8.47	11.6 (20.8)	28	71 (0.29)
20	1,875 (1,025)	1,940 (1,060)	0.319	8.83	— (—)	41	95 (0.43)
20	1,850 (1,010)	1,900 (1,038)	0.318	8.80	10.3 (18.6)	30	77 (0.32)
30	1,770 (965)	1,840 (1,005)	0.313	8.66	10.8 (19.4)	28	— (—)
30	1,650 (900)	1,720 (935)	0.308	8.53	11.2 (20.2)	25	64 (0.26)
30	1,630 (885)	1,650 (900)	0.304	8.41	11.8 (21.2)	26	67 (0.28)
50	1,630 (885)	1,650 (900)	0.305	8.44	11.8 (21.2)	26	67 (0.28)
70	1,630 (885)	1,650 (900)	0.305	8.44	11.8 (21.2)	26	67 (0.28)
20	1,750 (950)	1,920 (1,050)	0.320	8.86	9.9 (17.8)	15	40 (0.17)
20	1,785 (975)	1,945 (1,060)	0.320	8.86	9.9 (17.8)	20	48.4 (0.20)
20	1,620 (880)	1,880 (1,020)	0.318	8.80	10.1 (18.2)	13	36 (0.15)
20	1,550 (845)	1,830 (1,000)	0.317	8.78	10.2 (18.4)	11	29 (0.12)
80	1,700 (930)	1,830 (1,000)	0.321	8.89	9.6 (17.3)	19	50 (0.21)
20	1,920 (1,050)	1,945 (1,063)	0.295	8.17	10.0 (18.1)	17	46 (0.19)
20	—	1,905 (1,040)	0.281	7.78	9.9 (17.9)	15	40 (0.17)
30	1,905 (1,040)	1,915 (1,045)	0.287	7.95	9.0 (16.2)	12	32 (0.13)
20	1,905 (1,040)	1,915 (1,045)	0.285	7.89	9.0 (16.2)	14	39 (0.16)
30	1,895 (1,035)	1,930 (1,054)	0.274	7.58	9.0 (16.2)	7	22.6 (0.09)
30	1,905 (1,040)	1,940 (1,060)	0.276	7.64	9.0 (16.2)	7	20 (0.086)
60	1,800 (985)	1,840 (1,005)	0.278	7.69	10.0 (18.1)	8	26 (0.108)
30	1,890 (1,030)	1,940 (1,060)	0.316	8.75	9.9 (17.9)	12	33 (0.14)
30	1,780 (970)	1,880 (1,025)	0.308	8.53	10.0 (18.0)	7	21 (0.09)
30	1,590 (865)	1,630 (890)	0.302	8.36	11.8 (21.2)	24	61 (0.26)
30	1,740 (950)	1,765 (965)	0.296	8.33	10.3 (18.5)	23	58 (0.24)
20	2,010 (1,100)	2,100 (1,150)	0.323	8.94	9.5 (17.1)	9.0	26 (0.11)
20	2,140 (1,170)	2,260 (1,240)	0.323	8.94	9.0 (16.2)	4.6	17 (0.07)
20	1,940 (1,060)	2,065 (1,130)	0.321	8.89	9.2 (16.5)	11	31 (0.13)
20	— (—)	1,870 (1,020)	0.314	8.69	9.1 (16.4)	9.0	26 (0.11)
20	1,960 (1,070)	2,030 (1,110)	0.316	8.73	9.0 (16.2)	6.0	19 (0.08)
30	— (—)	1,930 (1,055)	0.314	8.70	9.3 (16.7)	5.5	17 (0.07)
60	1,780 (970)	1,830 (1,000)	0.314	8.69	10.3 (18.5)	10.9	28 (0.11)

**Cast Copper-Base Alloys**

Casting makes it possible to produce parts with shapes that cannot be achieved easily by fabrication methods such as forming or machining. Often it is more economical to produce a part as a casting than to fabricate it by other means.

Copper alloy castings serve in applications that require superior corrosion resistance, high thermal or electrical conductivity, good bearing surface qualities, or other special properties.

All copper alloys can be successfully **sand-cast**, for this process allows the greatest flexibility in casting size and shape and is the most economical and widely used casting method, especially for limited production quantities. Permanent mold casting is best suited for tin, silicon, aluminum, and manganese bronzes, as well as yellow brasses. Most copper alloys can be cast by the centrifugal process.

**Brass die castings** are made when great dimensional accuracy and/or a better surface finish is desired. While inferior in properties to hot-pressed parts, die castings are adaptable to a wider range of designs, for they can be made with intricate coring and with considerable variation in section thickness.

The estimated market distribution of the dominant copper alloys by end-use application is shown in Table 6.4.18. Chemical compositions and selective mechanical and physical properties of the dominant alloys used to produce sand castings are listed in Table 6.4.19.

Test results obtained on **standard test bars** (either attached to the casting or separately poured) indicate the quality of the metal used but not the specific properties of the casting itself because of variations of thickness, soundness, and other factors. The ideal casting is one with a fairly uniform metal section with ample fillets and a gradual transition from thin to thick parts.

**Properties and Processing of Copper Alloys**

**Mechanical Properties** Cold working copper and copper alloys increases both tensile and yield strengths, with the more pronounced increase imparted to yield strength. For most alloys, tensile strength of the hardest cold-worked temper is approximately twice the tensile strength of the annealed temper, whereas the yield strength of the hardest cold-worked temper can be up to 5 to 6 times that of the annealed temper. While hardness is a measure of temper, it is not an accurate one, because the determination of hardness is dependent upon the alloy, its strength level, and the method used to test for hardness.

All the brasses may be **hot-worked** irrespective of their lead content. Even for alloys having less than 60 percent copper and containing the beta phase in the microstructure, the process permits more extensive changes in shape than cold working because of the plastic (ductile) nature of the beta phase at elevated temperatures, even in the presence of lead. Hence a single hot-working operation can often replace a sequence of forming and annealing operations. Alloys for **extrusion, forging, or hot pressing** contain the beta phase in varying amounts.

**Extruded** sections of many copper alloys are made in a wide variety of shapes. In addition to architectural applications of extrusions, extrusion is an important production process since many objects such as hinges, pinions, brackets, and lock barrels can be extruded directly from bars.

While the copper-zinc alloys (brasses) may contain up to 40 percent zinc, those with 30 to 35 percent zinc find the greatest application for they exhibit high ductility and can be readily cold-worked. With decreasing zinc content, the mechanical properties and corrosion resistance of the alloys approach those of copper. The properties of these alloys are listed in Table 6.4.20.

**Heat Treating** Figures 6.4.3 and 6.4.4 show the progressive effects of cold rolling and annealing of alloy C26000 flat products. **Cold rolling** clearly increases the hardness and the tensile and yield strengths while concurrently decreasing the ductility.

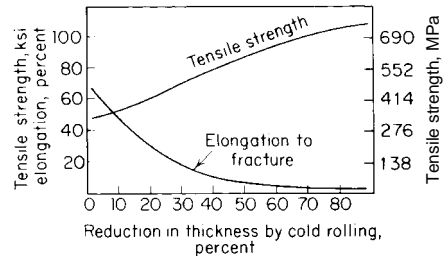

Fig. 6.4.3 Effect of cold working on annealed brass (alloy C26000).

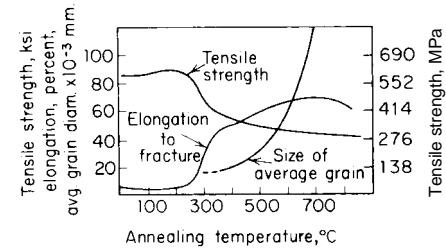

Fig. 6.4.4 Effect of annealing on cold-rolled brass (alloy C26000).

**Table 6.4.18 Estimated Casting Shipment Distribution by Alloy for End-Use Application**

End use	Dominant copper alloys—Estimated
Plumbing and heating	C84400 (75%), C83800/C84800 (25%)
Industrial valves and fittings	C83600 (45%), C83800/C84400 (15%) C90300 (5%), C92200 (15%), Misc. (20%)
Bearings and bushings	C93200 (80%), C93700 (20%)
Water meters, hydrants, and water system components	C83600 (25%), C84400 (75%)
Electrical connectors and components	C83300 (50%), C83600 (20%), C95400 (15%), C94600 (15%)
Pumps, impellers, and related components	C92200 (20%), C95400/C95500 (50%), Misc. (30%)
Outdoor sprinkler systems	C84400 (100%)
Heavy equipment components	C86300 (80%), C95500 (20%)
Hardware, plaques, and giftware	C83600 (15%), C85200/C85400/C85700 (50%), C92200 (35%)
Marine	C86500 (30%), C95800 (50%), C96200 (5%), C96400 (15%)
Locksets	C85200 (90%), Misc. (10%)
Railroad journal bearings and related parts	C93200 (90%), Misc. (10%)
Other	C87300 (35%), C87610 (65%)

**Table 6.4.19 Composition and Properties of Selected Cast Copper Alloys**

Alloy Number (and name)	Nominal composition, %	Mechanical properties					Melting point		Density, lb/in <sup>3</sup>	Specific gravity	Coefficient of thermal expansion × 10 <sup>-6</sup> at 77–572°F (25–300°C)	Electrical conductivity (annealed), % IACS	Thermal conductivity, Btu · ft/(h · ft <sup>2</sup> · °F) [cal · cm/(s · cm <sup>2</sup> · °C)]
		Tensile strength		Yield strength		Elongation in 50 mm (2 in), % <sup>b</sup>	Solidus °F (°C)	Liquidus °F (°C)					
		ksi	MPa	ksi	MPa								
C83600	85 Cu, 5 Sn, 5 Pb, 5 Zn	37	255	17	117	30	1,570 (855)	1,850 (1,010)	0.318	8.83	10.0 (18.0)	15	41.6 (0.172)
C83800	83 Cu, 4 Sn, 6 Pb, 7 Zn	35	240	16	110	25	1,550 (845)	1,840 (1,005)	0.312	8.64	10.0 (18.0)	15	41.9 (0.173)
C84400	81 Cu, 3 Sn, 7 Pb, 9 Zn	34	235	15	105	26	1,540 (840)	1,840 (1,005)	0.314	8.70	10.0 (18.0)	16.4	41.9 (0.173)
C84800	76 Cu, 3 Sn, 6 Pb, 15 Zn	37	255	14	97	35	1,530 (832)	1,750 (954)	0.310	8.58	10.4 (18.7)	16.4	41.6 (0.172)
C85200	72 Cu, 1 Sn, 3 Pb, 24 Zn	38	260	13	90	35	1,700 (925)	1,725 (940)	0.307	8.50	11.5 (21)	18.6	48.5 (0.20)
C85400	67 Cu, 1 Sn, 3 Pb, 29 Zn	34	235	12	83	35	1,700 (925)	1,725 (940)	0.305	8.45	11.2 (20.2)	19.6	51 (0.21)
C86300	62 Cu, 26 Zn, 3 Fe, 6 Al, 3 Mn	119	820	67	460	18	1,625 (885)	1,693 (923)	0.278	7.69	12 (22)	9	21 (0.085)
C87300	95 Cu, 1 Mn, 4 Si	55	380	25	170	30	1,680 (916)	1,510 (821)	0.302	8.36	10.9 (19.6)	6.7	28 (0.113)
C87610	92 Cu, 4 Zn, 4 Si	55	380	25	170	30	— (—)	— (—)	0.302	8.36	— (—)	6.0	— (—)
C90300	88 Cu, 8 Sn, 4 Zn	45	310	21	145	30	1,570 (854)	1,830 (1,000)	0.318	8.80	10.0 (18.0)	12	43 (0.18)
C92200	88 Cu, 6 Sn, 1.5 Pb, 3.5 Zn	40	275	20	140	30	1,520 (825)	1,810 (990)	0.312	8.64	10.0 (18.0)	14.3	40 (0.17)
C93200	83 Cu, 7 Sn, 7 Pb, 3 Zn	35	240	18	125	20	1,570 (855)	1,790 (975)	0.322	8.93	10.0 (18.0)	12	34 (0.14)
C93700	80 Cu, 10 Sn, 10 Sn	35	240	18	125	20	1,403 (762)	1,705 (930)	0.323	8.95	10.3 (18.5)	10	27 (0.11)
C95400	88.5 Cu, 4 Fe, 10.5 Al	75	515	30	205	12	1,880 (1,025)	1,900 (1,040)	0.269	7.45	9.0 (16.2)	13	34 (0.14)
C95400 (TQ50)	88.5 Cu, 4 Fe, 10.5 Al	90	620	45	310	6	1,880 (1,025)	1,900 (1,040)	0.269	7.45	9.0 (16.2)	13	34 (0.14)
C95500	81 Cu, 4 Fe, 11 Al, 4 Ni	90	620	40	275	6	1,930 (1,055)	1,900 (1,040)	0.272	7.53	9.0 (16.2)	8.5	24 (0.10)
C95500 (TQ50)	81 Cu, 4 Fe, 11 Al, 4 Ni	110	760	60	415	5	1,930 (1,055)	1,900 (1,040)	0.272	7.53	9.0 (16.2)	8.5	24 (0.10)
C95800	81.5 Cu, 4 Fe, 9 Al, 4 Ni, 1.5 Mn	85	585	35	240	15	1,910 (1,045)	1,940 (1,060)	0.276	7.64	9.0 (16.2)	7.1	21 (0.085)
C96200	88.5 Cu, 1.5 Fe, 10 Ni	45	310	25	172	20	2,010 (1,100)	2,100 (1,150)	0.323	8.94	9.5 (17.3)	11	26 (0.11)
C96400	69 Cu, 1 Fe, 30 Ni	68	470	27	255	28	2,140 (1,170)	2,260 (1,240)	0.323	8.94	9.0 (16.2)	5	17 (0.068)
C97600	64 Cu, 4 Pb, 20 Ni, 4 Sn, 8 Zn	45	310	24	165	20	2,027 (1,108)	2,089 (1,143)	0.321	8.90	9.3 (17)	5	13 (0.075)

Table 6.4.20 Mechanical Properties of Rolled Yellow Brass (Alloy C26800)

Standard temper designation (ASTM B 601)*	Nominal grain size, mm	Tensile strength		Approximate Rockwell hardness†	
		ksi	MPa	F	30T
OS120	0.120	—	—	50–62	21 max
OS070	0.070	—	—	52–67	3–27
OS050	0.050	—	—	61–73	20–35
OS035	0.035	—	—	65–76	25–38
OS025	0.025	—	—	67–79	27–42
OS015	0.015	—	—	72–85	33–50

Standard temper designation (ASTM B 601)*	Former temper designation	Tensile strength		Approximate Rockwell hardness‡			
		ksi	MPa	B scale		Superficial 30-T	
				0.020 (0.058) to 0.036 in (0.914 mm) incl	Over 0.036 in (0.914 mm)	0.012 (0.305) to 0.028 in (0.711 mm) incl	Over 0.028 in (0.711 mm)
M20	As hot-rolled	40–50	275–345	—	—	—	—
H01	Quarter-hard	49–59	340–405	40–61	44–65	43–57	46–60
H02	Half-hard	55–65	380–450	57–71	60–74	54–64	56–66
H03	Three-quarters hard	62–72	425–495	70–77	73–80	65–69	67–71
H04	Hard	68–78	470–540	76–82	78–84	68–72	69–73
H06	Extra hard	79–89	545–615	83–87	85–89	73–75	74–76
H08	Spring	86–95	595–655	87–90	89–92	75–77	76–78
H10	Extra spring	90–99	620–685	88–91	90–93	76–78	77–79

\* Refer to Table 6.4.15 for definition of temper designations.

† Rockwell hardness values apply as follows: The F scale applies to metal 0.020 in (0.508 mm) in thickness and over; the 30-T scale applies to metal 0.015 in (0.381 mm) in thickness and over.

‡ Rockwell hardness values apply as follows: The B scale values apply to metal 0.020 in (0.508 mm) and over in thickness, and the 30-T scale values apply to metal 0.012 in (0.305 mm) and over in thickness.

SOURCE: ASTM, abstracted with permission.

**Work-hardened** metals are restored to a soft state by annealing. Single-phase alloys are transferred into unstressed crystals by **recovery**, **recrystallization**, and **grain growth**. In severely deformed metal, recrystallization occurs at lower temperatures than in lightly deformed metal. Also, the grains are smaller and more uniform in size when severely deformed metal is recrystallized.

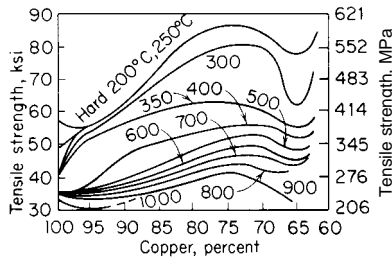

Fig. 6.4.5 Tensile strengths of copper-zinc alloys.

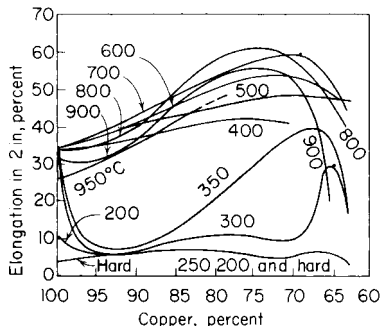

Fig. 6.4.6 Percent of elongation in 2 in. of copper-zinc alloys.

Grain size can be controlled by proper selection of cold-working and annealing practices. Large amounts of prior cold work, rapid heating to annealing temperature, and short annealing times foster formation of fine grains. Larger grains are normally produced by a combination of limited deformation and long annealing times.

Practically all wrought copper alloys are used in the cold-worked condition to gain additional strength. Articles are often made from annealed stock and depend on the cold work of the forming operation to shape and harden them. When the cold work involved is too small to do this, brass rolled to a degree of temper consistent with final requirements should be used.

Brass for springs should be rolled as hard as is consistent with the subsequent forming operations. For articles requiring sharp bends, or for deep-drawing operations, annealed brass must be used. In general, smaller grain sizes are preferred.

Table 6.4.20 summarizes the ASTM B36 specification requirements for alloy C26800 (65 : 35 copper-zinc) for various rolled and annealed tempers.

**Effect of Temperature** Copper and all its alloys increase in strength slightly and uniformly as temperature decreases from room temperature. No low-temperature brittleness is encountered. Copper is useless for prolonged-stress service much above 400°F (204°C), but some of its alloys may be used up to 550°F (287°C). For restricted service above this temperature, only copper-nickel and copper-aluminum alloys have satisfactory properties.

For specific data, see Elevated-Temperature Properties of Copper Base Alloys, ASTM STP 181; Low-Temperature Properties of Copper and Selected Copper Alloys, *NBS Mono.* 101, 1967; and Wilkens and Bunn, "Copper and Copper Base Alloys," McGraw-Hill, 1943.

**Electrical and Thermal Conductivities** The brasses (essentially copper-zinc alloys) have relatively good **electrical and thermal conductivities**, although the levels are somewhat lower than those of the coppers because of the effect of solute atoms on the copper lattice. For this reason, copper and high-copper alloys are preferred over the brasses containing more than a few percent total alloy content when high electrical or thermal conductivity is required for the application.



**Machinability** Machinability of copper alloys is governed by their metallurgical structure and related properties. In that regard, they are divided into three subgroups. All leaded brasses are yellow, have moderate electrical conductivity and fair hot-working qualities, but are relatively poor with respect to fabrication when compared with C26000.

While they all have excellent to satisfactory machinability ratings, the most important alloy for machined products is C36000, **free-cutting brass**, which is the standard material for automatic screw machine work where the very highest machinability is necessary.

ASTM B16 Free-Cutting Brass Rod, Bar, and Shapes for Use in Screw Machines is the dominant specification. Use of this material will often result in considerable savings over the use of steel. Most copper alloys are readily machined by usual methods using standard tools designed for steel, but machining is done at higher cutting speeds. Consideration of the wide range of characteristics presented by various types of copper alloys and the adaptation of machining practice to the particular material concerned will improve the end results to a marked degree.

**Group A** is composed of alloys of homogeneous structure: copper, wrought bronzes up to 10 percent tin, brasses and nickel silvers up to 37 percent zinc, aluminum bronzes up to 8 percent aluminum, silicon bronzes, and copper nickel. These alloys are all tough and ductile and form long, continuous chips. When they are severely cold-worked, they approach the group B classification in their characteristics.

**Group B** includes lead-free alloys of duplex structure, some cast bronzes, and most of the high-strength copper alloys. They form continuous but brittle chips by a process of intermittent shearing against the tool edge. Chatter will result unless work and tool are rigid.

Many of the basic **Group C** brasses and bronzes are rendered particularly adaptable for machining operations by the addition of 0.5 to 3.0 percent lead, which resides in the structure as minute, uniformly distributed droplets. They serve to break the chip and lubricate the tool cutting edge. Chips are fine, almost needlelike, and are readily removed. Very little heat is evolved, but the tendency to chatter is greater than for Group A alloys. Lead additions may be made to most copper alloys, but its low melting point makes hot working impossible. Tellurium and sulfur additions are used in place of lead when the combination of hot workability and good machinability is desired.

For **turning operations**, the tough alloys of Group A need a sharp top rake angle (20° to 30° for copper and copper nickel; 12° to 16° for the brasses, bronzes, and silicon bronzes with high-speed tools; 8° to 12° with carbide tools, except for copper, for which 16° is recommended). Type C (leaded) materials require a much smaller rake angle to minimize chatter, a maximum of 8° with high-speed steels and 3° to 6° with carbide. Type B materials are intermediate, working best with 6° to 12° rake angle with high-speed tools and 3° to 8° with carbide, the higher angle being used for the tougher materials. Side clearance angle should be 5° to 7° except for tough, "sticky" materials like copper and copper nickel, where a side rake of 10° to 15° is better.

Many copper alloys will **drill** satisfactorily with standard helix angle drills. Straight fluted tools (helix angle 0°) are preferable for the Group C leaded alloys. A helix angle of 10° is preferred for Group B and 40° for copper and copper nickel. Feed rates generally are 2 to 3 times faster than those used for steel. With Type B alloy, a fairly coarse feed helps to break the chip, and with Type A, a fine feed and high speed give best results, provided that sufficient feed is used to prevent rubbing and work hardening.

**Corrosion Resistance** For over half a century, copper has been the preferred material for tubing used, to convey potable water in domestic plumbing systems because of its outstanding corrosion resistance. In outdoor exposure, however, copper alloys containing less than 20 percent zinc are preferred because of their resistance to stress corrosion cracking, a form of corrosion originally called **season cracking**. For this type of corrosion to occur, a combination of tensile stress (either residual or applied) and the presence of a specific chemical reagent such as ammonia, mercury, mercury compounds, and cyanides is necessary. Stress relief annealing after forming alleviates the tendency for stress corrosion cracking. Alloys that are either zinc-free or contain less

than 15 percent zinc generally are not susceptible to stress corrosion cracking.

Arsenical copper (C14200), arsenical admiralty metal (C44300), and arsenical aluminum brass (C68700) were once popular **condenser tube alloys** for freshwater power plant applications. They have been successfully replaced largely with alloy 706 (90:10 copper-nickel). In seawater or brackish water, copper, admiralty metal, and aluminum brass are even less suitable because of their inability to form protective films.

Caution must be exercised, for copper and its alloys are not suitable for use in oxidizing acidic solutions or in the presence of moist ammonia and its compounds. Specific alloys are also limited to maximum flow velocities.

**Fabrication** Practically any of the copper alloys listed in Table 6.4.17 can be obtained in sheet, rod, and wire form, and many can be obtained as tubes. Most, in the annealed condition, will withstand extensive amounts of cold work and may be shaped to the desired form by deep drawing, flanging, forming, bending, and similar operations. If extensive cold work is planned, the material should be purchased in the annealed condition, and it may need intermediate annealing either to avoid metal failure or to minimize power consumption. Annealing is done at 900 to 1,300°F (482 to 704°C), depending on the alloy, and is usually followed by air cooling. Because of the ready workability of brass, it is often less costly to use than steel. Brass may be drawn at higher speeds than ferrous metals and with less wear on the tools. In cupping operations, a take-in of 45 percent is usual and on some jobs, it may be larger. Brass hardened by cold working is softened by annealing at about 1,100 F (593°C).

#### Joining by Welding, Soldering, and Brazing

**Welding** Deoxidized copper will **weld** satisfactorily by the oxyacetylene method. Sufficient heat input to overcome its high thermal conductivity must be maintained by the use of torches considerably more powerful than those customary for steel, and preferably by additional preheating. The filler rod must be deoxidized. Gas-shielded arc welding is preferred. Tough-pitch copper will not result in high-strength welds because of embrittlement due to the oxygen content. Copper may be arc-welded, using shielded metal arc, gas metal arc (MIG), or gas tungsten arc (TIG) welding procedures using experienced operators. Filler rods of phosphor bronze or silicon bronze will give strong welds more consistently and are used where the presence of a weld of different composition and corrosion-resistance characteristics is not harmful. Brass may be welded by the oxyacetylene process but not by arc welding. A filler rod of about the same composition is used, although silicon is frequently added to prevent zinc fumes.

Copper-silicon alloys respond remarkably well to welding by all methods. The conductivity is not too high, and the alloy is, to a large extent, self-fluxing.

Applicable specifications for joining copper and copper alloys by welding include

- ANSI/AWS A5.6 Covered Copper and Copper Alloy Arc Welding Electrodes
- ANSI/AWS A5.7 Copper and Copper Alloy Bare Welding Rods and Electrodes
- ANSI/AWS A5.27 Copper and Copper Alloy Rods for Oxyfuel Gas Welding

The **fluxes** used for brazing copper joints are water-based and function by dissolving and removing residual oxides from the metal surface; they protect the metal from reoxidation during heating and promote wetting of the joined surfaces by the brazing filler metal.

**Soldering** Soldered joints with **capillary fittings** are used in plumbing for water and sanitary drainage lines. Such joints depend on capillary action drawing free-flowing molten solder into the gap between the fitting and the tube.

Flux acts as a cleaning and wetting agent which permits uniform spreading of the molten solder over the surfaces to be joined.

Selection of a solder depends primarily on the operating pressure and temperature of the system. Lead-free solders required for joining copper

tube and fittings in potable water systems are covered by ASTM B32 Solder Metal.

As in brazing, the functions of soldering flux are to remove residual oxides, promote wetting, and protect the surfaces being soldered from oxidation during heating.

Fluxes best suited for soldering copper and copper alloy tube should meet the requirements of ASTM B813 Liquid and Paste Fluxes for Soldering Applications of Copper and Copper Alloy Tube with the joining accomplished per ASTM B828 Making Capillary Joints by Soldering of Copper and Copper Alloy Tube and Fittings.

## JEWELRY METALS

### Staff Contribution

REFERENCES: ASM "Metals Handbook." Publications of the metal-producing companies. Standards applicable to classes of metals available from manufacturers' associations. Trade literature pertinent to each specific metal.

**Gold** is used primarily as a monetary standard; the small amount put to metallurgical use is for jewelry or decorative purposes, in dental work, for fountain-pen nibs, and as an electrodeposited protecting coating. Electroplated gold is widely used for electronic junction points (transistors and the like) and at the mating ends of telephone junction wires. An alloy with palladium has been used as a platinum substitute for laboratory vessels, but its present price is so high that it does not compete with platinum.

**Silver** has the highest electrical conductivity of any metal, and it found some use in bus bars during World War II, when copper was in short supply. Since its density is higher than that of copper and since government silver frequently has deleterious impurities, it offers no advantage over copper as an electrical conductor. Heavy-duty electrical contacts are usually made of silver. It is used in aircraft bearings and solders. Its largest commercial use is in tableware as sterling silver, which contains 92.5 percent silver (the remainder is usually copper). United States coinage used to contain 90 percent silver, 10 percent copper, but coinage is now manufactured from a debased alloy consisting of copper sandwiched between thin sheets of nickel.

**Platinum** has many uses because of its high melting point, chemical inertness, and catalytic activity. It is the standard catalyst for the oxidation of sulfur dioxide in the manufacture of sulfuric acid. Because it is inert toward most chemicals, even at elevated temperatures, it can be used for laboratory apparatus. It is the only metal that can be used for an electric heating element about 2,300°F without a protective atmosphere. Thermocouples of platinum with platinum-rhodium alloy are standard for high temperatures. Platinum and platinum alloys are used in large amounts in feeding mechanisms of glass-working equipment to ensure constancy of the orifice dimensions that fix the size of glass products. They are also used for electrical contacts, in dental work, in aircraft spark-plug electrodes, and as jewelry. It has been used for a long time as a catalyst in refining of gasoline and is in widespread use in automotive catalytic converters as a pollution control device.

**Palladium** follows platinum in importance and abundance among the platinum metals and resembles platinum in most of its properties. Its density and melting point are the lowest of the platinum metals, and it forms an oxide coating at a dull-red heat so that it cannot be heated in air above 800°F (426°C) approx. In the finely divided form, it is an excellent hydrogenation catalyst. It is as ductile as gold and is beaten into leaf as thin as gold leaf. Its hardened alloys find some use in dentistry, jewelry, and electrical contacts.

**Iridium** is one of the platinum metals. Its chief use are as a hardener for platinum jewelry alloys and as platinum contacts. Its alloys with osmium are used for tipping fountain-pen nibs. Isotope Ir 192 is one of the basic materials used in radiation therapy and is widely employed as a radioactive implant in oncological surgical procedures. It is the most corrosion-resistant element known.

**Rhodium** is used mainly as an alloying addition to platinum. It is a component of many of the pen-tipping alloys. Because of its high re-

flectivity and freedom from oxidation films, it is frequently used as an electroplate for jewelry and for reflectors for motion-picture projectors, aircraft searchlights, and the like.

## LOW-MELTING-POINT METALS AND ALLOYS

by Frank E. Goodwin

REFERENCES: Current edition of ASM "Metals Handbook." Current listing of applicable ASTM and AWS standards. Publications of the various metal-producing companies.

Metals with low-melting temperatures offer a diversity of industrial applications. In this field, much use is made of the **eutectic**-type alloy, in which two or more elements are combined in proper proportion so as to have a minimum melting temperature. Such alloys melt at a single, fixed temperature, as does a pure metal, rather than over a range of temperatures, as with most alloys.

**Liquid Metals** A few metals are used in their liquid state. **Mercury** [mp, -39.37°F (-40°C)] is the only metal that is liquid below room temperature. In addition to its use in thermometers, scientific instruments, and electrical contacts, it is a constituent of some very low-melting alloys. Its application in dental amalgams is unique and familiar to all. It has been used as a heat-exchange fluid, as have **sodium** and the sodium-potassium alloy **NaK** (see Sec. 9.8).

Moving up the temperature scale, **tin** melts at 449.4°F (232°C) and finds its largest single use in coating steel to make tinplate. Tin may be applied to steel, copper, or cast iron by hot-dipping, although for steel this method has been replaced largely by electrodeposition onto continuous strips of rolled steel. Typical tin coating thicknesses are 40  $\mu\text{m}$  (1  $\mu\text{m}$ ). **Solders** constitute an important use of tin. Sn-Pb solders are widely used, although Sn-Sb and Sn-Ag solders can be used in applications requiring lead-free compositions. Tin is alloyed in bronzes and battery grid material. Alloys of 12 to 25 percent Sn, with the balance lead, are applied to steel by hot-dipping and are known as **terneplate**.

Modern  **pewter** is a tarnish-resistant alloy used only for ornamental ware and is composed of 91 to 93 percent Sn, 1 to 8 percent Sb, and 0.25 to 3 percent Cu. Alloys used for casting are lower in copper than those used for spinning hollowware. Pewter does not require intermediate annealing during fabrication. Lead was a traditional constituent of pewter but has been eliminated in modern compositions because of the propensity for lead to leach out into fluids contained in pewter vessels.

Pure **lead** melts at 620°F (327°C), and four grades of purities are recognized as standard; see Table 6.4.21. Corroding lead and common lead are 99.94 percent pure, while chemical lead and copper-bearing lead are 99.9 percent pure. Corroding lead is used primarily in the chemical industry, with most used to manufacture white lead or litharge (lead monoxide, PbO). Chemical lead contains residual copper that improves both its corrosion resistance and stiffness, allowing its extensive employment in chemical plants to withstand corrosion, particularly from sulfuric acid. Copper-bearing lead also has high corrosion resistance because of its copper content. Common lead is used for alloying and for battery oxides. Lead is strengthened by alloying with antimony at levels between 0 and 15 percent. Lead-tin alloys with tin levels over the entire composition range are widely used.

The largest use of lead is in **lead-acid batteries**. Deep cycling batteries typically use Pb 6.7 antimony, while Pb 0.1 Ca 0.3 tin alloys are used for maintenance-free batteries found in automobiles. Battery alloys usually have a minimum tensile strength of 6,000 lb/in<sup>2</sup> (41 MPa) and 20 percent elongation. Pb 0.85 percent antimony alloy is also used for sheathing of high-voltage power cables. Other cable sheathing alloys are based on Sn-Cd, Sn-Sb, or Te-Cu combined with lead. The lead content in cable sheathing alloys always exceeds 99 percent.

**Lead sheet** for construction applications, primarily in the chemical industries, is based on either pure lead or Pb 6 antimony. When cold-rolled, this alloy has a tensile strength of 4,100 lb/in<sup>2</sup> (28.3 MPa) and an elongation of 47 percent. Lead sheet is usually  $\frac{3}{64}$  in (1.2 mm) thick and weighs 3 lb/ft<sup>2</sup> (15 kg/m<sup>2</sup>). **Architectural uses for lead** are numerous,

**Table 6.4.21 Composition Specifications for Lead, According to ASTM B-29-79**

Element	Composition, wt %			
	Corroding lead	Common lead	Chemical lead	Copper-bearing lead
Silver, max	0.015	0.005	0.020	0.020
Silver, min	—	—	0.002	—
Copper, max	0.0015	0.0015	0.080	0.080
Copper, min	—	—	0.040	0.040
Silver and copper together, max	0.025	—	—	—
Arsenic, antimony, and tin together, max	0.002	0.002	0.002	0.002
Zinc, max	0.001	0.001	0.001	0.001
Iron, max	0.002	0.002	0.002	0.002
Bismuth, max	0.050	0.050	0.005	0.025
Lead (by difference), min	99.94	99.94	99.90	99.90

SOURCE: ASTM, reprinted with permission.

**Table 6.4.22 Compositions and Properties of Type Metal**

Service	Composition, %			Liquidus		Solidus		Brinell hardness*
	Sn	Sb	Pb	°F	°C	°F	°C	
Electrotype	4	3	93	561	294	473	245	12.5
Linotype	5	11	84	475	246	462	239	22
Stereotype	6.5	13	80.5	485	252	462	239	22
Monotype	8	17	75	520	271	462	239	27

\* 0.39-in (10-mm) ball, 550-lb (250-kg) load

SOURCE: "Metals Handbook," ASM International, 10th ed.

primarily directed to applications where water is to be contained (shower and tiled bathing areas overlaid by ceramic tile). Often, copper is lead-coated to serve as roof flashing or valleys; in those applications, the otherwise offending verdigris coating which would develop on pure copper sheet is inhibited.

**Ammunition** for both sports and military purposes uses alloys containing percentages up to 8 Sb and 2 As. **Bullets** have somewhat higher alloy content than shot.

**Type metals** use the hardest and strongest lead alloys. Typical compositions are shown in Table 6.4.22. A small amount of copper may be added to increase hardness. Electrotype metal contains the lowest alloy content because it serves only as a backing to the shell and need not be hard. Linotype, or slug casting metal, must be fluid and capable of rapid solidification for its use in composition of newspaper type; thus metal of nearly eutectic composition is used. It is rarely used as the actual printing surface and therefore need not be as hard as stereotype and monotype materials. Repeated remelting of type metal gradually results in changes in the original composition due to oxidation and loss of

original ingredients. Likewise, the alloy is often contaminated by shop dirt and residue from fluxes. In the ordinary course of its use, type metal composition is checked regularly and adjusted as required to restore its original properties. (Note that printing using type metal is termed *hot metal*, in contrast to printing methods which eliminate type metal altogether, or *cold type*. Hot-metal techniques are obsolescent, although they are still employed where the existing machinery exists and is in use.)

**Fusible Alloys** (See Table 6.4.23.) These alloys are used typically as fusible links in sprinkler heads, as electric cutouts, as fire-door links, for making castings, for patterns in making match plates, for making electroforming molds, for setting punches in multiple dies, and for dyeing cloth. Some fusible alloys can be cast or sprayed on wood, paper, and other materials without damaging the base materials, and many of these alloys can be used for making hermetic seals. Since some of these alloys melt below the boiling point of water, they can be used in bending tubing. The properly prepared tubing is filled with the molten alloy and allowed to solidify, and after bending, the alloy is melted out by immer-

**Table 6.4.23 Compositions, Properties, and Applications of Fusible Alloys**

Composition, %					Solidus		Liquidus		Typical application
Sn	Bi	Pb	Cd	In	°F	°C	°F	°C	
8.3	44.7	22.6	5.3	19.10	117	47	117	47	Dental models, part anchoring, lens chucking
13.3	50	26.7	10.0	—	158	70	158	70	Bushings and locators in jigs and fixtures, lens chucking, reentrant tooling, founding cores and patterns, light sheet-metal embossing dies, tube bending
—	55.5	44.5	—	—	255	124	255	124	Inserts in wood, plastics, bolt anchors, founding cores and patterns, embossing dies, press-form blocks, duplicating plaster patterns, tube bending, hobbyist parts
12.4	50.5	27.8	9.3	—	163	73	158	70	Wood's metal-sprinkler heads
14.5	48.0	28.5	(9% Sb)	—	440	227	217	103	Punch and die assemblies, small bearings, anchoring for machinery, tooling, forming blocks, stripper plates in stamping dies
60	40	—	—	—	338	170	281	138	Locator members in tools and fixtures, electroforming cores, dies for lost-wax patterns, plastic casting molds, prosthetic development work, encapsulating avionic components, spray metallizing, pantograph tracer molds

SOURCE: "Metals Handbook," ASM International, 10th ed.

sion of the tube in boiling water. The volume changes during the solidification of a fusible alloy are, to a large extent, governed by the bismuth content of the alloy. As a general rule, alloys containing more than about 55 percent bismuth expand and those containing less than about 48 percent bismuth contract during solidification; those containing 48 to 55 percent bismuth exhibit little change in volume. The change in volume due to cooling of the solid metal is a simple linear shrinkage, but some of the fusible alloys owe much of their industrial importance to other volume changes, caused by change in structure of the solid alloy, which permit the production of castings having dimensions equal to, or greater than, those of the mold in which the metal was cast.

For **fire-sprinkler heads**, with a rating of 160°F (71°C) **Wood's metal** is used for the fusible-solder-alloy link. Wood's metal gives the most suitable degree of sensitivity at this temperature, but in tropical countries and in situations where industrial processes create a hot atmosphere (e.g., baking ovens, foundries), solders having a higher melting point must be used. Alloys of eutectic compositions are used since they melt sharply at a specific temperature.

Fusible alloys are also used as molds for thermoplastics, for the production of artificial jewelry in pastes and plastic materials, in foundry patterns, chucking glass lenses, as hold-down bolts, and inserts in plastics and wood.

**Solders** are filler metals that produce coalescence of metal parts by melting the solder while heating the base metals below their melting point. To be termed *soldering* (versus brazing), the operating temperature must not exceed 840°F (450°C). The filler metal is distributed between the closely fitting faying surfaces of the joint by capillary action. Compositions of solder alloys are shown in Table 6.4.24. The Pb 63 tin eutectic composition has the lowest melting point—361°F (183°C)—of the binary tin-lead solders. For joints in copper pipe and cables, a wide melting range is needed. Solders containing less than 5 percent Sn are used to seal precoated containers and in applications where the surface temperatures exceed 250°F (120°C). Solders with 10 to 20 percent Sn are used for repairing automobile radiators and bodies, while compositions containing 40 to 50 percent Sn are used for manufacture of automobile radiators, electrical and electronic connections, roofing seams, and heating units. Silver is added to tin-lead solders for electronics applications to reduce the dissolution of silver from the substrate. Sb-containing solders should not be used to join base metals containing zinc, including galvanized iron and brass. A 95.5 percent Sn 4 Cu 0.5 Ag solder has supplanted lead-containing solders in potable water plumbing.

**Table 6.4.25 Brazing Filler Metals**

AWS-ASTM filler-metal classification	Base metals joined
BAlSi (aluminum-silicon)	Aluminum and aluminum alloys
BCuP (copper-phosphorus)	Copper and copper alloys; limited use on tungsten and molybdenum; should not be used on ferrous or nickel-base metals
BAg (silver)	Ferrous and non-ferrous metals except aluminum and magnesium; iron, nickel, cobalt-base alloys; thin-base metals
BCu (copper)	Ferrous and non-ferrous metals except aluminum and magnesium
RBCuZn (copper-zinc)	Ferrous and non-ferrous metals except aluminum and magnesium; corrosion resistance generally inadequate for joining copper, silicon, bronze, copper, nickel, or stainless steel
BMg (magnesium)	Magnesium-base metals
BNi (nickel)	AISI 300 and 400 stainless steels; nickel- and cobalt-base alloys; also carbon steel, low-alloy steels, and copper where specific properties are desired

**Table 6.4.26 Compositions and Melting Ranges of Brazing Alloys**

AWS designation	Nominal composition, %	Melting temp, °F
BAG-1	45 Ag, 15 Cu, 16 Zn, 24 Cd	1,125–1,145
BNI-7	13 Cr, 10 P, bal. Ni	1,630
BAu-4	81.5 Au, bal. Ni	1,740
BAlSi-2	7.5 Si, bal. Al	1,070–1,135
BAlSi-5	10 Si, 4 Cu, 10 Zn, bal. Al	960–1,040
BCuP-5	80 Cu, 15 Ag, 5 P	1,190–1,475
BCuP-2	93 Cu, 7 P	1,310–1,460
BAG-1a	50 Ag, 15.5 Cu, 16.5 Zn, 18 Cd	1,160–1,175
BAG-7	56 Ag, 22 Cu, 17 Zn, 5 Sn	1,145–1,205
RBCuZn-A	59 Cu, 40 Zn, 0.6 Sn	1,630–1,650
RBCuZn-D	48 Cu, 41 Zn, 10 Ni, 0.15 Si, 0.25 P	1,690–1,715
BCu-1	99.90 Cu, min	1,980
BCu-1a	99.9 Cu, min	1,980
BCu-2	86.5 Cu, min	1,980

°C = (°F – 32)/1.8.

SOURCE: "Metals Handbook," ASM.

**Table 6.4.24 Compositions and Properties of Selected Solder Alloys**

Composition, %		Solidus temperature		Liquidus temperature		Uses
Tin	Lead	°C	°F	°C	°F	
2	98	316	601	322	611	Side seams for can manufacturing
5	95	305	581	312	594	Coating and joining metals
10	90	268	514	302	576	Sealing cellular automobile radiators, filling seams or dents
15	85	227	440	288	550	Sealing cellular automobile radiators, filling seams or dents
20	80	183	361	277	531	Coating and joining metals, or filling dents or seams in automobile bodies
25	75	183	361	266	511	Machine and torch soldering
30	70	183	361	255	491	
35	65	183	361	247	477	General-purpose and wiping solder
40	60	183	361	238	460	Wiping solder for joining lead pipes and cable sheaths; also for automobile radiator cores and heating units
45	55	183	361	227	441	Automobile radiator cores and roofing seams
50	50	183	361	216	421	Most popular general-purpose solder
60	40	183	361	190	374	Primarily for electronic soldering applications where low soldering temperatures are required
63	37	183	361	183	361	Lowest-melting (eutectic) solder for electronic applications
40	58 (2% Sb)	185	365	231	448	General-purpose, not recommended on zinc-containing materials
95	0 (5% Sb)	232	450	240	464	Joints on copper, electrical plumbing, heating, not recommended on zinc-containing metals
0	97.5 (2.5% Ag)	304	580	308	580	Copper, brass, not recommended in humid environments
95.5	0 (4% Cu, 0.5% Ag)	226	440	260	500	Potable water plumbing

SOURCE: "Metals Handbook," vol. 2, 10th ed., p. 553.

**Brazing** is similar to soldering but is defined as using filler metals which melt at or above 840°F (450°C). As in soldering, the base metal is not melted. Typical applications of brazing filler metals classified by AWS and ASTM are listed in Table 6.4.25; their compositions and melting points are given in Table 6.4.26.

## METALS AND ALLOYS FOR USE AT ELEVATED TEMPERATURES

by John H. Tundermann

REFERENCES: "High Temperature High Strength Alloys," AISI. Simmons and Krivobok, Compilation of Chemical Compositions and Rupture Strength of Super-strength Alloys, *ASTM Tech. Pub.* 170-A. "Metals Handbook," ASM. Smith, "Properties of Metals at Elevated Temperatures," McGraw-Hill. Clark, "High-Temperature Alloys," Pittman. Cross, Materials for Gas Turbine Engines, *Metal Progress*, March 1965. "Heat Resistant Materials," ASM Handbook, vol. 3, 9th ed., pp. 187–350. Lambert, "Refractory Metals and Alloys," ASM Handbook, vol. 2, 10th ed., pp. 556–585. Watson et al., "Electrical Resistance Alloys," ASM Handbook, vol. 2, 10th ed., pp. 822–839.

Some of data presented here refer to materials with names which are proprietary and registered trademarks. They include Inconel, Incoloy, and Nimonic (Inco Alloys International); Hastelloy (Haynes International); MAR M (Martin Marietta Corp.); and René (General Electric Co.).

Metals are used for an increasing variety of applications at elevated temperatures, "elevated" being a relative term that depends upon the specific metal and the specific service environment. Elevated-temperature properties of the common metals and alloys are cited in the several subsections contained within this section. This subsection deals with metals and alloys whose prime use is in **high-temperature applications**. [Typical operating temperatures are compressors, 750°F (399°C); steam turbines, 1,100°F (593°C); gas turbines, 2,000°F (1,093°C); resistance-heating elements, 2,400°F (1,316°C); electronic vacuum tubes, 3,500°F (1,926°C), and lamps, 4,500°F (2,482°C).] In general, alloys for high-temperature service must have melting points above the operating temperature, low vapor pressures at that temperature, resistance to attack (oxidation, sulfidation, corrosion) in the operating environment, and sufficient strength to withstand the applied load for the service life without deforming beyond permissible limits. At high temperatures, atomic diffusion becomes appreciable, so that time is an important factor with respect to surface chemical reactions, to **creep** (slow deformation under constant load), and to internal changes within the alloy during service. The effects of time and temperature are conveniently combined by the empirical **Larson-Miller parameter**  $P = T(C + \log t) \times 10^{-3}$ ,

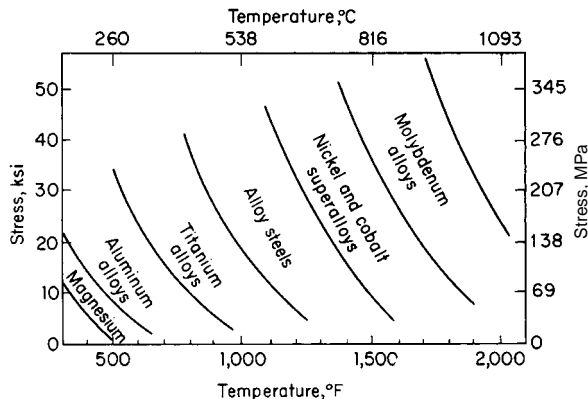

Fig. 6.4.7 Stress-temperature application ranges for several alloy types; stress to produce rupture in 1,000 h.

where  $T$  = test temp in °R (°F + 460) and  $t$  = test time, h. The constant  $C$  depends upon the material but is frequently taken to be 20.

Many alloys have been developed specifically for such applications. The selection of an alloy for a specific high-temperature application is strongly influenced by service conditions (stress, stress fluctuations, temperature, heat shock, atmosphere, service life), and there are hundreds of alloys from which to choose. The following illustrations, data, and discussion should be regarded as examples. Vendor literature and more extensive references should be consulted.

Figure 6.4.7 indicates the general stress-temperature range in which various alloy types find application in elevated-temperature service. Figure 6.4.8 indicates the important effect of time on the strength of alloys at high temperatures, comparing a familiar stainless steel (type 304) with **superalloy** (M252).

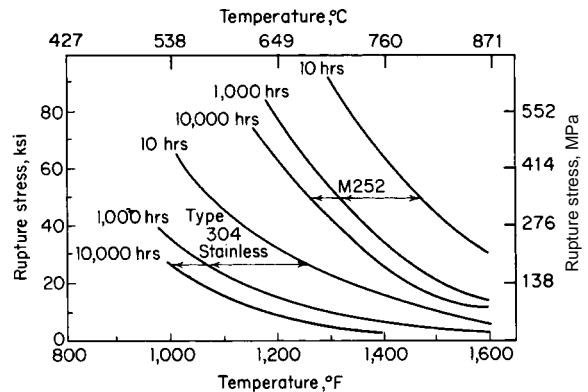

Fig. 6.4.8 Effect of time on rupture strength of type 304 stainless steel and alloy M252.

**Common Heat-Resisting Alloys** A number of alloys containing large amounts of **chromium** and **nickel** are available. These have excellent oxidation resistance at elevated temperatures. Several of them have been developed as electrical-resistance heating elements; others are modifications of stainless steels, developed for general corrosion resistance. Selected data on these alloys are summarized in Table 6.4.27. The maximum temperature value given is for resistance to oxidation with a reasonable life. At higher temperatures, failure will be rapid because of scaling. At lower temperatures, much longer life will be obtained. At the maximum useful temperature, the metal may be very weak and frequently must be supported to prevent sagging. Under load, these alloys are generally useful only at considerably lower temperatures, say up to 1,200°F (649°C) max, depending upon permissible creep rate and the load.

**Superalloys** were developed largely to meet the needs of aircraft gas turbines, but they have also been used in other applications demanding high strength at high temperatures. These alloys are based on nickel and/or cobalt, to which are added (typically) chromium for oxidation resistance and a complex of other elements which contribute to hot strength, both by solid solution hardening and by forming relatively stable dispersions of fine particles. Hardening by cold work, hardening by precipitation-hardening heat treatments, and hardening by deliberately arranging for slow precipitation during service are all methods used to enhance the properties of these alloys. **Fabrication** of these alloys is difficult since they are designed to resist distortion even at elevated temperatures. Forging temperatures of about 2,300°F (1,260°C) are used with small reductions and slow rates of working. Many of these alloys are fabricated by precision casting. Cast alloys that are given a strengthening heat treatment often have better properties than wrought alloys, but the shapes that can be made are limited.

Vacuum melting is an important factor in the production of superalloys. The advantages which result from its application include the abil-

Table 6.4.27 Properties of Common Heat-Resisting Alloys

Alloy		Max temp for oxidation resistance		Nominal chemical composition, %					Specific gravity	Coef of thermal expansion per $^{\circ}\text{F} \times 10^{-6}$ ( $0-1,200^{\circ}\text{F}$ )	Stress to rupture in 1,000 h, ksi			0.2 percent offset yield strength, ksi		
UNS no.	Name	$^{\circ}\text{F}$	$^{\circ}\text{C}$	C	Cr	Ni	Fe	Other			1,200 $^{\circ}\text{F}$ (649 $^{\circ}\text{C}$ )	1,500 $^{\circ}\text{F}$ (816 $^{\circ}\text{C}$ )	1,800 $^{\circ}\text{F}$ (982 $^{\circ}\text{C}$ )	Room temp	1,000 $^{\circ}\text{F}$ (538 $^{\circ}\text{C}$ )	1,200 $^{\circ}\text{F}$ (649 $^{\circ}\text{C}$ )
N 06004	62 Ni, 15 Cr	1,700	926		15	62	Bal		8.19	9.35						
N 06003	80 Ni, 20 Cr	2,100	1,148		20	80			8.4	9.8			63			
	Kanthal	2,450	1,371		25		Bal	3 Co, 5 Al	7.15							
N 06600	Inconel alloy 600	2,050	1,121		13	79	Bal		8.4		14.5	3.7	36	22	22	
G 10150	1,015	1,000	537	0.15			Bal		7.8	8.36	2.7		42	20	10	
S 50200	502	1,150	621	0.12	5		Bal	0.5 Mo	7.8	7.31	6	1.5	27	18	12	
S 44600	446	2,000	1,093	0.12	26	0.3	Bal		7.6	6.67	4	1.2				
S 30400	304	1,650	871	0.06	18	9	Bal		7.9	10.4	11	3.5	32	14	11	
S 34700	347	1,650	871	0.08	18.5	11.5	Bal	0.8 Nb	8.0	10.7	20		41	31	26	
S 31600	316	1,650	871	0.07	18	13	Bal	2.5 Mo	8.0	10.3	25	7	41	22	21	
S 31000	310	2,000	1,093	0.12	25	20	Bal		7.9	9.8	13.2	3.0	2.7	34	28	25
S 32100	321	1,650	899	0.06	18	10	Bal	0.5 Ti	8.0	10.7	17.5	3.7	39	27	25	
	NA 22H	2,200	1,204	0.5	28	48	Bal	5W		8.6	30	18	3.6			
N 06617	Inconel alloy 617	2,050	1,121	0.1	22	Bal	3	9 Mo, 12.5 Co, 1.2 Al, 0.6 Ti	8.36	6.4	52	14	4	43	29	25
N 08800	Inconel alloy 800	1,800	982	0.1	21	32	Bal		7.94	7.9	24	7	2	36	26	26
N 08330	330	1,850	1,010	0.05	19	36	Bal		8.08	8.3		5	1.3	40	26	21

ity to melt higher percentages of reactive metals, improved mechanical properties (particularly fatigue strength), decreased scatter in mechanical properties, and improved billet-to-bar stock-conversion ratios in wrought alloys.

Table 6.4.28 to 6.4.31 list compositions and properties of some superalloys, and Fig. 6.4.9 indicates the temperature dependence of the rupture strength of a number of such alloys.

**Cast tool alloys** are another important group of materials having high-temperature strength and wear resistance. They are principally alloys of cobalt, chromium, and tungsten. They are hard and brittle, and they must be cast and ground to shape. Their most important application is for hard facing, but they compete with high-speed steels and cemented carbides for many applications, in certain instances being superior to both. (See Cemented Carbides, Sec. 6.4.) Typical compositions are given in Table 6.4.32; typical properties are: elastic modulus = 35 ×

10<sup>6</sup> lb/in<sup>2</sup> (242 GPa); specific gravity = 8.8; hardness, BHN at room temp = 660; 1,500 $^{\circ}\text{F}$  (815 $^{\circ}\text{C}$ ), 435, and 2,000 $^{\circ}\text{F}$  (1,093 $^{\circ}\text{C}$ ) 340.

For still higher-temperature applications, the possible choices are limited to a few metals with high melting points, all characterized by limited availability and by difficulty of extraction and fabrication. Advanced alloys of metals such as chromium, niobium, molybdenum, tantalum, and tungsten are still being developed. Table 6.4.33 cites properties of some of these alloys. Wrought tool steel materials are described in "Tool Steels," ASM Handbook, vol. 3, 9th ed., pp. 421–447.

**Chromium** with room-temperature ductility has been prepared experimentally as a pure metal and as strong high-temperature alloys. It is not generally available on a commercial basis. Large quantities of chromium are used as melt additions to steels, stainless steels, and nickel-base alloys.

**Molybdenum** is similar to tungsten in most of its properties. It can be

Table 6.4.28 Wrought Superalloys, Compositions\*

Common designation	Chemical composition, %												Other
	C	Mn	Si	Cr	Ni	Co	Mo	W	Nb	Ti	Al	Fe	
19-9D L	0.2	0.5	0.6	19	9	....	1.2	1.25	0.3	0.3	....	Bal	
Timken	0.1	0.5	0.5	16	25	....	6	....	....	....	....	Bal	0.15 N
L.C. N-155	0.1	0.5	0.5	20	20	20	3	2	1	....	....	Bal	0.15 N
S-590	0.4	0.5	0.5	20	20	20	4	4	4	....	....	Bal	
S-816	0.4	0.5	0.5	20	20	Bal	4	4	4	....	....	4	
Nimonic alloy 80A	0.05	0.7	0.5	20	76	....	....	....	....	2.3	1.0	0.5	
K-42-B	0.05	0.7	0.7	18	42	22	....	....	....	2.0	0.2	14	
Hastelloy alloy B	0.1	0.5	0.5	..	65	....	28	....	....	....	....	6	0.4 V
M 252†	0.10	1.0	0.7	19	53.5	10	10	....	....	2.5	0.75	2	
J1570	0.20	0.1‡	0.2‡	20	29	37.5	....	7	....	4.1	....	2	
HS-R235	0.10	....	....	16	Bal	1.5	6	....	....	3.0	1.8	8	
Hastelloy alloy X	0.10	....	....	21	48	2.0	9	1.0	....	....	....	18	
HS 25 (L605)	0.05	1.5	1.0‡	20	10	53	....	15	....	....	....	1.0	
A-286	0.05	....	....	15	26	....	1.3	....	....	2.0	0.35	55	0.3 V
Inconel alloy 718	0.05	0.2	0.2	19	52.5	....	3	....	5	0.9	0.5	18.5	
Inconel alloy X-750	0.1	1.0	0.5	15	72	1.0	....	....	....	2.5	0.7	7	

\* For a complete list of superalloys, both wrought and cast, experimental and under development, see *ASTM Spec. Pub. 170*, "Compilation of Chemical Compositions and Rupture Strengths of Superstrength Alloys."

† Waspalloy has a similar composition (except for lower Mo content), and similar properties.

‡ Max.

Table 6.4.29 Wrought Superalloys, Properties

Alloy		Max temp under load		Coef of thermal expansion, in/(in · °F) × 10 <sup>-6</sup> (70–1,200°F)	Specific gravity	Short-time tensile properties, ksi										
						Stress to rupture, ksi			Yield strength 0.2% offset				Tensile strength			
						At 1,200°F	At 1,500°F		Room	1,200°F	1,500°F	1,800°F	Room	1,200°F	1,500°F	1,800°F
UNS	Name	°F	°C			1,000 h	100 h	1,000 h								
K63198	19-9 DL	1,200	649	9.7	7.75	38	17	10	115	39	30		140	75	33	13
	Timken	1,350	732	9.25	8.06	36	13.5	9	96*	70*	16*		134	90	40	18
R30155	L.C. N-155	1,400	760	9.4	8.2	48	20.0	15	53	40	33	12	115	53	35	19
	S-590	1,450	788	8.0	8.34	40	19.0	15	78*	70	47	20	140	82	60	22
R30816	S-816	1,500	816	8.3	8.66	53	29.0	18	63*	45	41		140	112	73	25
N07080	Nimonic alloy 80A	1,450	788	7.56		56	24	15	80*	73	47		150	101	69	
	K-42-B	1,400	760	8.5	8.23	38	22	15	105	84	52		158	117	54	
N10001	Hastelloy alloy B	1,450	788	6.9	9.24	36	17	10	58	42			135	94	66	24
N07252	M 252	1,500	816	7.55	8.25	70	26	18	90	75	65		160	140	80	20
	J 1570	1,600	871	8.42	8.66	84	34	24	81	70	71	17	152	135	82	20
	HS-R235	1,600	871	8.34	7.88	70	35	23	100	90	80	22	170	145	83	25
N06002	Hastelloy alloy X	1,350	732			30	14	10	56	41	37		113	83	52	15
R30605	HS 25 (L605)	1,500	816			54	22	18	70	35			75	50	23	
K66286	A-286	1,350	732			45	13.8	7.7								
N07718	Inconel alloy 718	1,400	760	7.2	8.19	54	19	13	152	126			186	149		
N07750	Inconel alloy X-750	1,300	704	7.0	8.25				92	82	45		162	120	52	

\* 0.02 percent offset.

prepared in the massive form by powder metallurgy techniques, by inert-atmosphere or vacuum-arc melting. Its most serious limitation is its ready formation of a volatile oxide at temperatures of 1,400°F approx. In the worked form, it is inferior to tungsten in melting point, tensile strength, vapor pressure, and hardness, but in the recrystallized condition, the ultimate strength and elongation are higher. Tensile strengths up to 350,000 lb/in<sup>2</sup> (2,413 MPa) have been reported for hard-drawn wire, and to 170,000 lb/in<sup>2</sup> (1,172 MPa) for soft wire. In the hard-drawn condition, molybdenum has an elongation of 2 to 5 percent, but after recrystallizing, this increases to 10 to 25 percent. Young's modulus is 50 × 10<sup>6</sup> lb/in<sup>2</sup> (345 GPa). It costs about the same as tungsten, per pound, but its density is much less. It has considerably better forming properties than tungsten and is extensively used for anodes, grids, and supports in vacuum tubes, lamps, and X-ray tubes. Molybde-

num is generally used for winding electric furnaces for temperatures up to 3,000°F (1,649°C). As it must be protected against oxidation, such furnaces are usually operated in hydrogen. It is the common material for cathodes for radar devices, heat radiation shields, rocket nozzles and other missile components, and hot-working tools and die-casting cores in the metalworking industry. Its principal use is still as an alloying addition to steels, especially tool steels and high-temperature steels.

**Molybdenum alloys** have found increased use in aerospace and commercial structural applications, where their high stiffness, microstructural stability, and creep strength at high temperatures are required. They are generally stronger than niobium alloys but are not ductile in the welded condition. Molybdenum alloys are resistant to alkali metal corrosion.

**Niobium** (also known as **columbium**) is available as a pure metal and

Table 6.4.30 Cast Superalloys, Nominal Composition

Common designation	Chemical composition, %										
	C	Mn	Si	Cr	Ni	Co	Mo	W	Nb	Fe	Other*
Vitallium (Haynes 21)	0.25	0.6	0.6	27	2	Bal	6	—	—	1	—
61 (Haynes 23)	0.4	0.6	0.6	26	1.5	Bal	—	5	—	1	—
422-19 (Haynes 30)	0.4	0.6	0.6	26	16	Bal	6	—	—	1	—
X-40 (Haynes 31)	0.4	0.6	0.6	25	10	Bal	—	7	—	1	—
S-816	0.4	0.6	0.6	20	20	Bal	4	4	4	5	—
HE 1049	0.45	0.7	0.7	25	10	45	—	15	—	1.5	0.4B
Hastelloy alloy C	0.10	0.8	0.7	16	56	1	17	4	—	5.0	0.3V
B 1900 + Hf	0.1	—	—	8	Bal	10	6	—	—	—	{ 6 Al 4 Ta 1 Ti 1.5 Hf
MAR-M 247	0.15	—	—	8.5	Bal	10	0.5	10	—	—	{ 5.5 Al 3Ta 1 Ti 1.5 Hf
René 80	0.15	—	—	14	Bal	9.5	4	4	—	—	3 Al 5 Ti
MO-RE 2	0.2	0.3	0.3	32	48	—	—	15	—	Bal	1 Al

\* Trace elements not shown.

**Table 6.4.31 Cast Superalloys, Properties**

Common designation	Max temp under load		Coef of thermal expansion, in/(in · °F) × 10 <sup>-6</sup> (70–1,200°F)	Specific gravity	Stress to rupture in 1,000 h, ksi			Short-time tensile properties, ksi							
	°F	°C			1,200°F	1,500°F	1,800°F	Yield strength, 0.2% offset				Tensile strength			
								Room 68°F (20°C)	1,200°F (650°C)	1,500°F (816°C)	1,800°F (982°C)	Room 68°F (20°C)	1,200°F (650°C)	1,500°F (816°C)	1,800°F (982°C)
Vitallium (Haynes 21)	1,500	816	8.35	8.3	44	14	7	82	71	49		101	89	59	33
61 (Haynes 23)	1,500	816	8.5	8.53	47	22	5.5	58	74	40	33	105	97	58	45
422-19 (Haynes 30)	1,500	816	8.07	8.31		21	7	55	37*	48		98	59*	64	37
N-40 (Haynes 31)	1,500	816	8.18	8.60	46	23	9.8	74	37*	44		101	77*	59	29
S-816	1,500	816	8.27	8.66	46	21	9.8					112			
HE 1049	1,650	899		8.9	75	35	7	80	72	62	36	90	82	81	52
Hastelloy alloy C			7.73	8.91	42.5	14.5	1.4	54	50			130	87	51	19
B 1900 + Hf	1,800	982	7.7	8.22		55	15	120	134	109	60	140	146	126	80
MAR-M 247	1,700	927		8.53			18	117	117	108	48	140	152	130	76
René 80	1,700	927		8.16			15	124	105	90		149	149	123	

\* Specimen not aged.



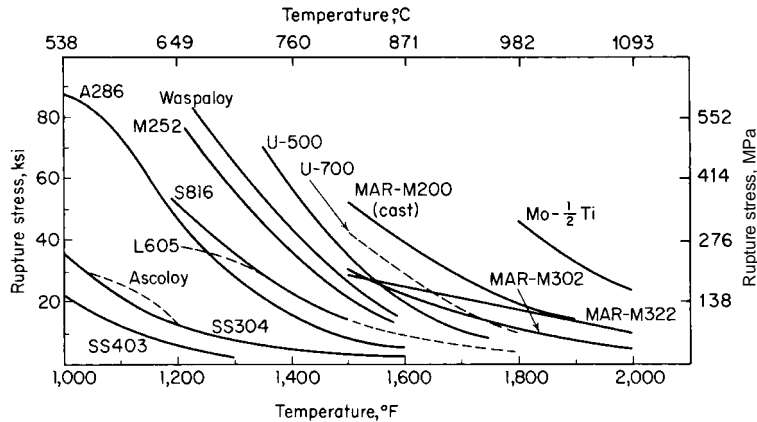

Fig. 6.4.9 Temperature dependence of strengths of some high-temperature alloys; stress to produce rupture in 1,000 h.

Table 6.4.32 Typical Compositions of Cast Tool Alloys

Name	C	Cr	W	Co	Fe	V	Ta	B	Other
Rexalloy	3	32	20	45					
Stellite 98 M2	3	28	18	35	9	4	0.1	0.1	3 Ni
Tantung G-2	3	15	21	40	...	...	19	0.2	
Borcoloy no. 6	0.7	5	18	20	Bal	1.3	...	0.7	6 Mo
Colmonoy WCR 100	...	10	15	...	Bal	...	...	3	

as the base of several niobium alloys. The alloys are used in nuclear applications at temperatures of 1,800 to 2,200°F (980 to 1,205°C) because of their low thermal neutron cross section, high strength, and good corrosion resistance in liquid or gaseous alkali metal atmospheres. Niobium alloys are used in leading edges, rocket nozzles, and guidance structures for hypersonic flight vehicles. A niobium-46.5 percent titanium alloy is used as a low-temperature superconductor material for magnets in magnetic resonance imaging machines.

**Tantalum** has a melting point that is surpassed only by tungsten. Its early use was as an electric-lamp filament material. It is more ductile than molybdenum or tungsten; the elongation for annealed material may be as high as 40 percent. The tensile strength of annealed sheet is about 50,000 lb/in<sup>2</sup> (345 MPa). In this form, it is used primarily in electronic capacitors. It is also used in chemical-processing equipment, where its high rate of heat transfer (compared with glass or ceramics) is particularly important, although it is equivalent to glass in corrosion resistance. Its corrosion resistance also makes it attractive for surgical implants. Like tungsten and molybdenum, it is prepared by powder metallurgy techniques; thus, the size of the piece that can be fabricated is limited by

the size of the original pressed compact. Tantalum carbide is used in cemented-carbide tools, where it decreases the tendency to seize and crater. The stability of the anodic oxide film on tantalum leads to rectifier and capacitor applications. Tantalum and its alloys become competitive with niobium at temperatures above 2,700°F (1,482°C). As in the case of niobium, these materials are resistant to liquid or vapor metal corrosion and have excellent ductility even in the welded condition.

**Tungsten** has a high melting point, which makes it useful for high-temperature structural applications. The massive metal is usually prepared by powder metallurgy from hydrogen-reduced powder. As a metal, its chief use is as filaments in incandescent lamps and electronic tubes, since its vapor pressure is low at high temperatures. Tensile strengths over 600,000 lb/in<sup>2</sup> (4,136 MPa) have been reported for fine tungsten wires; in larger sizes (0.040 in), tensile strength is only 200,000 lb/in<sup>2</sup> (1,379 MPa). The hard-drawn wire has an elongation of 2 to 4 percent, but the recrystallized wire is brittle. Young's modulus is 60 million lb/in<sup>2</sup> (415 GPa). It can be sealed directly to hard glass and so is used for lead-in wires. A considerable proportion of tungsten rod and sheet is used for electrical contacts in the form of disks cut from rod or

Table 6.4.33 Properties of Selected Refractory Metals

Alloy	Melting temp, °F	Density, lb/in <sup>3</sup> at 75°F	Elastic modulus at 75°F	Ductile-to-brittle transition temp, °F	Tensile strength, ksi (recrystallized condition)				
					75°F	1,800°F	2,200°F	3,000°F	3,500°F
Chromium	3,450	0.760	42	625		12	8		
Columbium	4,474	0.310	16	-185	45	12	10		
F48 (15 W, 5 Mo, 1 Zr, 0.05 C)			25		121	75	50		
Cb74 or Cb752 (10 W, 2 Zr)		0.326			84	60	36		
Molybdenum	4,730	0.369	47	85	75	34	22	6	3
Mo (½ Ti)					110	70	48	8	4
TZM (0.5 Ti, 0.08 Zr)					130	85	70	14	5
Tantalum	5,425	0.600	27	< -320	30	22	15	8	4
Ta (10 W)						65	35	12	8
Rhenium	5,460	0.759	68	< 75	170	85	60	25	11
Tungsten	6,170	0.697	58	645	85	36	32	19	10
W (10 Mo)								28	10
W (2 ThO <sub>2</sub> )							40	30	25

sheet and brazed to supporting elements. The major part of the tungsten used is made into ferroalloys for addition to steels or into tungsten carbide for cutting tools. Other applications include elements of electronic tubes, X-ray tube anodes, and arc-welding electrodes. Alloys of tungsten that are commercially available are W-3 Re, W-25 Re, and thoriated tungsten. The rhenium-bearing alloys are more ductile than unalloyed tungsten at room temperature. Thoriated tungsten is stronger than unalloyed tungsten at temperatures up to the recrystallization temperature.

## METALS AND ALLOYS FOR NUCLEAR ENERGY APPLICATIONS

by L. D. Kunsman and C. L. Carlson; Amended by Staff

REFERENCES: Glasstone, "Principles of Nuclear Reactor Engineering," Van Nostrand. Hausner and Roboff, "Materials for Nuclear Power Reactors," Reinhold. Publications of the builders of reactors (General Electric Co., Westinghouse Corp., General Atomic Co.) and suppliers of metal used in reactor components. See also Sec. 9.8 commentary and other portions of Sec. 6.4.

The advent of atomic energy not only created a demand for new metals and alloys but also focused attention on certain properties and combinations of properties which theretofore had been of little consequence. Reactor technology requires special materials for fuels, fuel cladding, moderators, reflectors, controls, heat-transfer mediums, operating mechanisms, and auxiliary structures. Some of the properties pertinent to such applications are given in a general way in Table 6.4.34. In general, outside the reflector, only normal engineering requirements need be considered.

**Nuclear Properties** A most important consideration in the design of a nuclear reactor is the control of the number and speed of the neutrons resulting from fission of the fuel. The designer must have knowledge of the effectiveness of various materials in slowing down neutrons or in capturing them. The slowing-down power depends not only on the relative energy loss per atomic collision but also on the number of collisions per second per unit volume. The former will be larger, the lower the atomic weight, and the latter larger, the greater the atomic density and the higher the probability of a scattering collision. The effectiveness of a moderator is frequently expressed in terms of the moderating ratio, the ratio of the slowing-down power to the capture cross section. The capturing and scattering tendencies are measured in terms of nuclear cross section in barns ( $10^{-24}$  cm<sup>2</sup>). Data for some of the materials of interest

are given in Tables 6.4.35 to 6.4.37. The absorption data apply to slow, or thermal, neutrons; entirely different cross sections obtain for fast neutrons, for which few materials have significantly high capture affinity. Fast neutrons have energies of about  $10^6$  eV, while slow, or thermal,

**Table 6.4.35 Moderating Properties of Materials**

Moderator	Slowing-down power, cm <sup>-1</sup>	Moderating ratio
H <sub>2</sub> O	1.53	70
D <sub>2</sub> O	0.177	21,000
He	$1.6 \times 10^{-5}$	83
Be	0.16	150
BeO	0.11	180
C (graphite)	0.063	170

SOURCE: Adapted from Glas, "Principles of Nuclear Reactor Engineering," Van Nostrand.

neutrons have energies of about  $2.5 \times 10^{-2}$  eV. Special consideration must frequently be given to the presence of small amounts of high cross-section elements such as Co or W which are either normal incidental impurities in nickel alloys and steels or important components of high-temperature alloys.

**Table 6.4.36 Slow-Neutron Absorption by Structural Materials**

Material	Relative neutron absorption per cm <sup>3</sup> × 10 <sup>3</sup>	Relative neutron absorption for pipes of equal strength, 68°F (20°C)	Melting point	
			°F	°C
Magnesium	3.5	10	1,200	649
Aluminum	13	102	1,230	666
Stainless steel	226	234	2,730	1,499
Zirconium	12.6	16	3,330	1,816

SOURCE: Leeser, *Materials & Methods*, 41, 1955, p. 98.

**Effects of Radiation** Irradiation affects the properties of solids in a number of ways: dimensional changes; decrease in density; increase in hardness, yield, and tensile strengths; decrease in ductility; decrease in electrical conductivity; change in magnetic susceptibility. Another consideration is the activation of certain alloying elements by irradiation. Tantalum<sup>181</sup> and Co<sup>60</sup> have moderate radioactivity but long half-

**Table 6.4.34 Requirements of Materials for Nuclear Reactor Components**

Component	Neutron absorption cross section	Effect in slowing neutrons	Strength	Resistance to radiation damage	Thermal conductivity	Corrosion resistance	Cost	Other	Typical material
Moderator and reflector	Low	High	Adequate	—	—	High	Low	Low atomic wt	H <sub>2</sub> O, graphite, Be
Fuel*	Low	—	Adequate	High	High	High	Low	—	U, Th, Pu
Control rod	High	—	Adequate	Adequate	High	—	—	—	Cd, B <sub>4</sub> C
Shield	High	High	High	—	—	—	—	High $\gamma$ radiation absorption	Concrete
Cladding	Low	—	Adequate	—	High	High	Low	—	Al, Zr, stainless steel
Structural	Low	—	High	Adequate	—	High	—	—	Zr, stainless steel
Coolant	Low	—	—	—	High	—	—	Low corrosion rate, high heat capacity	H <sub>2</sub> O, Na, NaK, CO <sub>2</sub> , He

U, Th, and Pu are used as fuels in the forms of metals, oxides, and carbides.

Table 6.4.37 Slow-Neutron Absorption Cross Sections

Low		Intermediate		High	
Element	Cross section, barns	Element	Cross section, barns	Element	Cross section, barns
Oxygen	0.0016	Zinc	1.0	Manganese	12
Carbon	0.0045	Columbium	1.2	Tungsten	18
Beryllium	0.009	Barium	1.2	Tantalum	21
Fluorine	0.01	Strontium	1.3	Chlorine	32
Bismuth	0.015	Nitrogen	1.7	Cobalt	35
Magnesium	0.07	Potassium	2.0	Silver	60
Silicon	0.1	Germanium	2.3	Lithium	67
Phosphorus	0.15	Iron	2.4	Gold	95
Zirconium	0.18	Molybdenum	2.4	Hafnium	100
Lead	0.18	Gallium	2.8	Mercury	340
Aluminum	0.22	Chromium	2.9	Iridium	470
Hydrogen	0.32	Thallium	3.3	Boron	715
Calcium	0.42	Copper	3.6	Cadmium	3,000
Sodium	0.48	Nickel	4.5	Samarium	8,000
Sulphur	0.49	Tellurium	4.5	Gadolinium	36,000
Tin	0.6	Vanadium	4.8		
		Antimony	5.3		
		Titanium	5.8		

SOURCE: Leeser, *Materials & Methods*, 41, 1955, p. 98.

lives; isotopes having short lives but high-activity levels include Cr<sup>51</sup>, Mn<sup>56</sup>, and Fe<sup>59</sup>.

**Metallic Coolants** The need for the efficient transfer of large quantities of heat in a reactor has led to use of several metallic coolants. These have raised new problems of pumping, valving, and corrosion. In addition to their thermal and flow properties, consideration must also be given the nuclear properties of prospective coolants. Extensive thermal, flow, and corrosion data on metallic coolants are given in the "Liquid Metals Handbook," published by USNRC. The resistances of common materials to liquid sodium and NaK are given qualitatively in Table 6.4.38. Water, however, remains the most-used coolant; it is used under pressure as a single-phase liquid, as a boiling two-phase coolant, or as steam in a superheat reactor.

**Fuels** There are, at present, only three fissionable materials, U<sup>233</sup>, U<sup>235</sup>, and Pu<sup>239</sup>. Of these, only U<sup>235</sup> occurs naturally as an isotopic "impurity" with natural uranium U<sup>238</sup>. Uranium<sup>233</sup> may be prepared from natural thorium, and Pu<sup>239</sup> from U<sup>238</sup> by neutron bombardment. Both uranium and thorium are prepared by conversion of the oxide to the tetrafluoride and subsequent reduction to the metal.

The properties of **uranium** are considerably affected by the three allotropic changes which it undergoes, the low-temperature forms being highly anisotropic. The strength of the metal is low (see Table 6.4.39) and decreases rapidly with increasing temperature. The corrosion resistance is also poor. Aluminum-base alloys containing uranium-aluminum intermetallic compounds have been used to achieve improved properties. **Thorium** is even softer than uranium but is very ductile. Like

uranium it corrodes readily, particularly at elevated temperatures. Owing to its crystal structure, its properties are isotropic. **Plutonium** is unusual in possessing six allotropic forms, many of which have anomalous physical properties. The electrical resistivity of the alpha phase is greater than that for any other metallic element. Because of the poor corrosion resistance of nuclear-fuel metals, most fuels in power reactors today are in the form of oxide UO<sub>2</sub>, ThO<sub>2</sub>, or PuO<sub>2</sub>, or mixtures of these. The carbides UC and UC<sub>2</sub> are also of interest in reactors using liquid-metal coolants.

**Control-Rod Materials** Considerations of neutron absorption cross sections and melting points limit the possible control-rod materials to a very small group of elements, of which only four—boron, cadmium, hafnium, and gadolinium—have thus far been prominent. **Boron** is a very light metal of high hardness (~3,000 Knoop) prepared by thermal or hydrogen reduction of BCl<sub>3</sub>. Because of its high melting point, solid shapes of boron are prepared by powder-metallurgy techniques. Boron has a very high electrical resistivity at room temperature but becomes conductive at high temperatures. The metal in bulk form is oxidation-resistant below 1,800°F (982°C) but reacts readily with most halogens at only moderate temperatures. Rather than the elemental form, boron is generally used as boron steel or as the carbide, oxide, or nitride. **Cadmium** is a highly ductile metal of moderate hardness which is recovered as a by-product in zinc smelting. Its properties greatly resemble those of zinc. The relatively low melting point renders it least attractive as a control rod of the four metals cited. **Hafnium** metal is reduced from hafnium tetrachloride by sodium and subsequently purified by the io-

Table 6.4.38 Resistance of Materials to Liquid Sodium and NaK\*

	Good	Limited	Poor
<1,000°F	Carbon steels, low-alloy steels, alloy steels, stainless steels, nickel alloys, cobalt alloys, refractory metals, beryllium, aluminum oxide, magnesium oxide, aluminum bronze	Gray cast iron, copper, aluminum alloys, magnesium alloys, glasses	Sb, Bi, Cd, Ca, Au, Pb, Se, Ag, S, Sn, Teflon
1,000–1,600°F	Armco iron, stainless steels, nickel alloys,† cobalt alloys, refractory metals‡	Carbon steels, alloy steels, Monel, titanium, zirconium, beryllium, aluminum oxide, magnesium oxide	Gray cast iron, copper alloys, Teflon, Sb, Bi, Cd, Ca, Au, Pb, Se, Ag, S, Sn, Pt, Si, Magnesium alloys

\* For more complete details, see "Liquid Metals Handbook."

† Except Monel.

‡ Except titanium and zirconium.

Table 6.4.39 Mechanical Properties of Metals for Nuclear Reactors

Material	Room temp						Elevated temp*			
	Longitudinal			Transverse			Charpy impact ft · lb	°F	Ult str, ksi	Elong, %
	Yield strength, ksi	Ult strength, ksi	Elong,† %	Ult str, ksi	Elong,† %					
Beryllium:										
Cast, extruded and annealed		40	1.82	16.6	0.18		392	62	23.5	
Flake, extruded and annealed		63.7	5.0	25.5	0.30		752	43	29	
Powder, hot-extruded	39.5	81.8	15.8	45.2	2.3	4.1	1,112	23	8.5	
Powder, vacuum hot-pressed	32.1	45.2	2.3	45.2	2.3	0.8	1,472	5.2	10.5	
Zirconium:										
Kroll-50% CW		82.6				14.8	250	32		
Kroll-annealed		49.0					500	23		
Iodide	15.9	35.9	31			2.5–6.0	700	17		
							900	12		
							1,500	3		
Uranium	25	53	<10			15	302	27		
							1,112	12		
Thorium	27	37.5	40				570	22		
							930	17.5		

\* All elevated-temperature data on beryllium for hot-extruded powder; on zirconium for iodide material.

† Beryllium is extremely notch-sensitive. The tabulated data have been obtained under very carefully controlled conditions, but ductility values in practice will be found in general to be much lower and essentially zero in the transverse direction.

dide hot-wire process. It is harder and less readily worked than zirconium, to which it is otherwise very similar in both chemical and physical properties. Hafnium reacts easily with oxygen, and its properties are sensitive to traces of most gases. The very high absorption cross section of **gadolinium** renders it advantageous for fast-acting control rods. This metal is one of the rare earths and as yet is of very limited availability. It is most frequently employed as the oxide.

**Beryllium** Great interest attaches to beryllium because it is unique among the metals with respect to its very low neutron-absorption cross section and high neutron-slowing power. It may also serve as a source of neutrons when subjected to alpha-particle bombardment. Beryllium is currently prepared almost entirely by magnesium reduction of the fluoride, although fused-salt electrolysis is also practicable and has been used. The high affinity of the metal for oxygen and nitrogen renders its processing and fabrication especially difficult. At one time, beryllium was regarded as almost hopelessly brittle. Special techniques, such as vacuum hot pressing, or vacuum casting followed by hot extrusion of clad slugs, led to material having marginally acceptable, though highly directional, mechanical properties. The extreme toxicity of beryllium powder necessitates special precautions in all operations.

**Zirconium** Zirconium's importance in nuclear technology derives from its low neutron-absorption cross section, excellent corrosion resistance, and high strength at moderate temperatures. The metal is produced by magnesium reduction of the tetrachloride (Kroll process). The Kroll product is usually converted to ingot form by consumable-electrode-arc melting. An important step in the processing for many applications is the difficult chemical separation of the 1½ to 3 percent hafnium with which zirconium is contaminated. Unless removed, this small hafnium content results in a prohibitive increase in absorption cross section from 0.18 to 3.5 barns. The mechanical properties of zirconium are particularly sensitive to impurity content and fabrication technique. In spite of the high melting point, the mechanical properties are poor at high temperatures, principally because of the allotropic transformation at 1,585°F (863°C). A satisfactory annealing temperature is 1,100°F (593°C). The low-temperature corrosion behavior is excellent but is seriously affected by impurities. The oxidation resistance at high temperatures is poor. Special alloys (Zircaloys) have been developed having greatly improved oxidation resistance in the intermediate-temperature range. These alloys have a nominal content of 1.5 percent Sn and minor additions of iron-group elements.

**Stainless Steel** Although stainless steel has a higher thermal neu-

tron-absorption cross section than do the zirconium alloys, its good corrosion resistance, high strength, low cost, and ease of fabrication make it a strong competitor with zirconium alloys as a fuel-cladding material for water-cooled power-reactor applications. Types 348 and 304 stainless are used in major reactors.

## MAGNESIUM AND MAGNESIUM ALLOYS

by James D. Shearouse, III

REFERENCES: "Metals Handbook," ASM. Beck, "Technology of Magnesium and Its Alloys," Annual Book of Standards, ASTM. Publications of the Dow Chemical Co.

Magnesium is the lightest metal of structural importance [108 lb/ft<sup>3</sup> (1.740 g/cm<sup>3</sup>)]. The principal uses for **pure magnesium** are in aluminum alloys, steel desulfurization, and production of nodular iron. Principal uses for **magnesium alloys** are die castings (for automotive and computer applications), wrought products, and, to a lesser extent, gravity castings (usually for aircraft and aerospace components). Because of its chemical reactivity, magnesium can be used in pyrotechnic material and for sacrificial galvanic protection of other metals. Since magnesium in its molten state reacts with the oxygen in air, a protective atmosphere containing sulfur hexafluoride is employed as a controlled atmosphere.

Commercially pure magnesium contains 99.8 percent magnesium and is produced by extraction from seawater or by reduction from magnesite and dolomite ores. Chief impurities are iron, silicon, manganese, and aluminum. The major use of magnesium, consuming about 50 percent of total magnesium production, is as a component of aluminum alloys for beverage can stock. Another use for primary magnesium is in steel desulfurization. Magnesium, usually mixed with lime or calcium carbide, is injected beneath the surface of molten steel to reduce the sulfur content.

A growing application for **magnesium alloys** is die cast automotive components. Their light weight can be used to help achieve reduced fuel consumption, while high-ductility alloys are used for interior components which must absorb impact energy during collisions. These alloys can be cast by hot or cold chamber die-casting methods, producing a diverse group of components ranging from gear cases to steering wheel frames. Some vehicles use magnesium die castings as structural members to serve as instrument panel support beams and steering columns.

Designs employing magnesium must account for the relatively low value of the modulus of elasticity ( $6.5 \times 10^6$  lb/in<sup>2</sup>) and high thermal coefficient of expansion [ $14 \times 10^{-6}$  per °F at 32°F (0°C) and  $16 \times 10^{-6}$  for 68 to 752°F (20 to 400°C)]. (See Tables 6.4.40 and 6.4.41.)

The development of jet engines and high-velocity aircraft, missiles, and spacecraft led to the development of magnesium alloys with improved **elevated-temperature properties**. These alloys employ the addition of some combination of rare earth elements, yttrium, manganese, zirconium, or, in the past, thorium. Such alloys have extended the useful temperatures at which magnesium can serve in structural applications to as high as 700 to 800°F.

**Magnesium alloy forgings** are used for applications requiring properties superior to those obtainable in castings. They are generally **press-forged**. Alloy AZ61 is a general-purpose alloy, while alloys AZ80A-T5 and ZK60A-T5 are used for the highest-strength press forgings of simple design. These alloys are aged to increase strength.

A wide range of extruded shapes are available in a number of compositions. Alloys AZ31B, AZ61A, AZ80A-T5, and ZK60A-T5 increase in cost and strength in the order named. **Impact extrusion** produces smaller, symmetric tubular parts.

**Sheet** is available in several alloys (see Table 6.4.41), in both the soft (annealed) and the hard (cold-rolled) tempers. Magnesium alloy sheet usually is hot-formed at temperatures between 400 and 650°F, although simple bends of large radius are made cold.

**Joining** Magnesium alloys are joined by **riveting** or **welding**. Riveting is most common. Aluminum alloy rivets are used; alloy 5052 is preferred, to minimize contact corrosion. Other aluminum alloy rivets

can be used, but they are not as effective in inhibiting contact corrosion. Rivets should be anodized to prevent contact corrosion. Adhesive bonding is another accepted method for joining magnesium. It saves weight and improves fatigue strength and corrosion resistance.

**Arc welding** with inert-gas (helium or argon) shielding of the molten metal produces satisfactory joints. Butt joints are preferred, but any type of welded joint permissible for mild steel can be used. After welding, a stress relief anneal is necessary. Typical stress relief anneal times are 15 min at 500°F (260°C) for annealed alloys and 1 h at 400°F (204°C) for cold-rolled alloys.

**Machining** Magnesium in all forms is a free-machining metal. Standard tools such as those used for brass and steel can be used with slight modification. Relief angles should be from 7° to 12°; rake angles from 0° to 15°. High-speed steel is satisfactory and is used for most drills, taps, and reamers. Suitable grades of cemented carbides are better for production work and should be used where the tool design permits it. Finely divided magnesium constitutes a fire hazard, and good house-keeping in production areas is essential. (see also Sec. 13.4.)

**Corrosion Resistance and Surface Protection** All magnesium alloys display good resistance to ordinary inland atmospheric exposure, to most alkalis, and to many organic chemicals. High-purity alloys introduced in the mid-1980s demonstrate excellent corrosion resistance and are used in under-vehicle applications without coatings. However, galvanic couples formed by contact with most other metals, or by contamination of the surface with other metals during fabrication, can cause rapid attack of the magnesium when exposed to salt water. Protective treatments or coated fasteners can be used to isolate galvanic couples and prevent this type of corrosion.

Table 6.4.40 Typical Mechanical Properties of Magnesium Casting Alloys

Alloy	Con- dition or tem- per*	Nominal composition, % (balance Mg plus trace elements)					Tensile strength, ksi	Tensile yield strength, ksi	Elonga- tion, %, in 2 in	Shear strength, ksi	Strength, ksi		Hardness BHN	Elec- trical conduc- tivity, % IACS‡
		Al	Zn	Mn, min	Zr	Other					Ten- sile	Yield		
<b>Permanent mold and sand casting alloys:</b>														
AM100A	-T6	10.0		0.10			40	22	1	22			70	14
AZ63A	-F	6.0	3.0	0.15			29	14	6	18	60	40	50	14
	-T4						40	13	12	17	60	44	55	12
	-T5						30	14	4	17	60	40	55	
	-T6						40	19	5	20	75	52	73	15
AZ81A	-T4	7.5	0.7	0.13			40	12	15	17	60	44	55	12
AZ91E	-F	8.7	0.7	0.17			24	14	2	18	60	40	52	13
	-T4						40	12	14	17	60	44	53	11
	-T5						26	17	3					
	-T6						40	19	5	20	75	52	66	13
AZ92A	-F	9.0	2.0	0.10			24	14	2	18	50	46	65	12
	-T4						40	14	9	20	68	46	63	10
	-T5						26	16	2	19	50	46	70	
	-T6						40	21	2	22	80	65	84	14
EZ33A	-T5		2.5		0.8	3.5 RE†	23	15	3	22	57	40	50	25
K1A	-F				0.7		25	7	19	8				31
QE22A	-T6				0.7	2.0 RE, † 2.5 Ag	40	30	4	23				25
ZE41A	-T5		4.0		0.7	1.3 RE†	30	20	3.5	22	70	51	62	31
ZK51A	-T5		4.5		0.8		40	24	8	22	72	47	65	27
ZK61A	-T6		6.0		0.8		45	28	10	26			70	27
<b>Die casting alloys:</b>														
AZ91D	-F	9.0	0.7	0.15			34	23	3	20			75	
AM60B	-F	6.0	0.22 max	0.24			32	19	6-8				62	
AM50A	-F	5.0	0.22 max	0.26			32	18	8-10				57	
AS41B	-F	4.2	0.12 max	0.35		1.0 Si	31	18	6				75	
AE42X1	-F	4.0	0.22 max	0.25		2.4 RE†	33	20	8-10				57	

ksi  $\times$  6.895 = MPa

\* - F = as cast; - T4 = artificially aged; - T5 = solution heat-treated; - T6 = solution heat-treated.

† RE = rare-earth mixture.

‡ Percent electrical conductivity/100 approximately equals thermal conductivity in cgs units.

**Table 6.4.41 Properties of Wrought Magnesium Alloys**

Alloy and temper*	Nominal composition, % (balance Mg plus trace elements)				Physical properties			Room-temperature mechanical properties (typical)							
					Density, lb/in <sup>3</sup>	Thermal conductivity, cgs units, 68°F (20°C)	Electrical resistivity, $\mu\Omega \cdot \text{cm}$ , 68°F (20°C)	Tensile strength, ksi	Tensile yield strength, ksi	Elongation in 2 in, %	Compressive yield strength, ksi	Shear strength, ksi	Bearing strength, ksi		Hardness BHN
	Ten-sile	Yield													
Extruded bars, rods, shapes															
AZ31B-F	3.0		1.0		0.0639	0.18	9.2	38	29	15	14	19	56	33	49
AZ61A-F	6.5		1.0		0.0647	0.14	12.5	45	33	16	19	22	68	40	60
AZ80A-T5	8.5		0.5		0.0649	0.12	14.5	55	40	7	35	24	60	58	82
ZK60A-F			5.7	0.5	0.0659	0.28	6.0	49	38	14	33	24	76	56	75
-T5			5.7	0.5	0.0659	0.29	5.7	53	44	11	36	26	79	59	82
Extruded tube															
AZ31B-F	3.0		1.0		0.0639	0.18	9.2	36	24	16	12				46
AZ61A-F	6.5		1.0		0.0647	0.14	12.5	41	24	14	16				50
ZK60A-F			5.7	0.5	0.0659	0.28	6.0	47	35	13	25				75
-T5			5.7	0.5	0.0659	0.29	5.7	50	40	11	30				82
M1A		1.2			0.0635	0.31	5.4	37	26	11	12				
Sheet and plate															
AZ31B-H24	3.0		1.0		0.0639	0.18	9.2	42	32	15	26	29	77	47	73
								40	29	17	23	28	72	45	
								39	27	19	19	27	70	40	
AZ31B-O	3.0		1.0		0.0639	0.18	9.2	37	22	21	16	26	66	37	56
M1A		1.2			0.0635	0.31	5.4	37	26	11	12				
Tooling plate															
AZ31B	3.0		1.0		0.0639	0.18	9.2	35	19	12	10				
Tread plate															
AZ31B	3.0		1.0		0.0639	0.18	9.2	35	19	14	11				52

See Sec. 1 for conversion factors to SI units.

NOTE: For all above alloys: coefficient of thermal expansion = 0.0000145; modulus of elasticity = 6,500,000 lb/in<sup>2</sup>; modulus of rigidity = 2,400,000 lb/in<sup>2</sup>; Poisson's ratio = 0.35.

\* Temper: - F = as fabricated; - H24 = strain-hardened, then partially annealed; - O = fully annealed; - T5 = artificially aged.

## POWDERED METALS

by Peter K. Johnson

REFERENCES: German, "Powder Metallurgy Science," 2d ed., Metal Powder Industries Federation, Princeton, NJ. "Powder Metallurgy Design Manual," 2d ed., Metal Powder Industries Federation.

**Powder metallurgy (PM)** is an automated manufacturing process to make precision metal parts from metal powders or particulate materials. Basically a net or near-net shape metalworking process, a PM operation usually results in a finished part containing more than 97 percent of the starting raw material. Most PM parts weigh less than 5 lb (2.26 kg), although parts weighing as much as 35 lb (15.89 kg) can be fabricated in conventional PM equipment.

In contrast to other metal-forming techniques, PM parts are shaped directly from powders, whereas castings originate from molten metal, and wrought parts are shaped by deformation of hot or cold metal, or by machining (Fig. 6.4.10). The PM process is cost-effective in manufacturing simple or complex shapes at, or very close to, final dimensions in production rates which can range from a few hundred to several thousand parts per hour. Normally, only a minimum amount of machining is required.

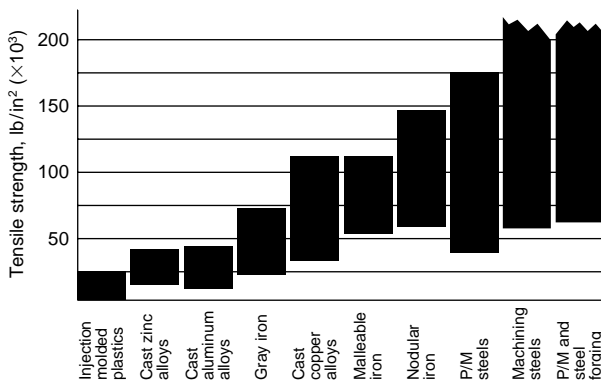

Fig. 6.4.10 Comparison of material strengths.

Powder metallurgy predates melting and casting of iron and other metals. Egyptians made iron tools, using PM techniques from at least 3000 B.C. Ancient Inca Indians made jewelry and artifacts from precious metal powders. The first modern PM product was the tungsten filament for electric light bulbs, developed in the early 1900s. Oil-impregnated PM bearings were introduced for automotive use in the 1920s. This was followed by tungsten carbide cutting tool materials in the 1930s, automobile parts in the 1960s and 1970s, aircraft gas-turbine engine parts in the 1980s, and **powder forged (PF)** and **metal injection molding (MIM)** parts in the 1990s.

PM parts are used in a variety of end products such as lock hardware, garden tractors, snowmobiles, automobile automatic transmissions and engines, auto antilock brake systems (ABS), washing machines, power tools, hardware, firearms, copiers, and postage meters, off-road equipment, hunting knives, hydraulic assemblies, X-ray shielding, oil and gas drilling well-head components, and medical equipment. The typical five- or six-passenger car contains about 30 lb of PM parts, a figure that could increase within the next several years. Iron powder is used as a carrier for toner in electrostatic copying machines. People in the United States consume about 2 million lb of iron powder annually in iron-enriched cereals and breads. Copper powder is used in antifouling paints for boat hulls and in metallic pigmented inks for packaging and printing. Aluminum powder is used in solid-fuel booster rockets for the space shuttle program. The spectrum of applications of powdered metals is very wide indeed.

There are five major processes that consolidate metal powders into

precision shapes: conventional powder metallurgy (PM) (the dominant sector of the industry), metal injection molding (MIM), powder forging (PF), hot isostatic pressing (HIP), and cold isostatic pressing (CIP).

PM processes use a variety of alloys, giving designers a wide range of material properties (Tables 6.4.42 to 6.4.44). Major alloy groups include powdered iron and alloy steels, stainless steel, bronze, and brass. Powders of aluminum, copper, tungsten carbide, tungsten, and heavy-metal alloys, tantalum, molybdenum, superalloys, titanium, high-speed tool steels, and precious metals are successfully fabricated by PM techniques.

A PM microstructure can be designed to have controlled microporosity. This inherent advantage of the PM process can often provide special useful product properties. Sound and vibration damping can be enhanced. Components are impregnated with oil to function as self-lubricating bearings, resin impregnated to seal interconnecting microporosity, infiltrated with a lower-melting-point metal to increase strength and impact resistance, and steam-treated to increase corrosion resistance and seal microporosity. The amount and characteristics of the microporosity can be controlled within limits through powder characteristics, powder composition, and the compaction and sintering processes.

Powder metallurgy offers the following advantages to the designer:

1. PM eliminates or minimizes machining.
2. It eliminates or minimizes material losses.
3. It maintains close dimensional tolerances.
4. It offers the possibility of utilizing a wide variety of alloyed materials.
5. PM produces good surface finishes.
6. It provides components that may be heat-treated for increased strength or wear resistance.
7. It provides part-to-part reproducibility.
8. It provides controlled microporosity for self-lubrication or filtration.
9. PM facilitates the manufacture of complex or unique shapes that would be impractical or impossible with other metalworking processes.
10. It is suitable for moderate- to high-volume production.
11. It offers long-term performance reliability for parts in critical applications.

**Metal powders** are materials precisely engineered to meet a wide range of performance requirements. Major metal powder production processes include atomization (water, gas, centrifugal); chemical (reduction of oxides, precipitation from a liquid, precipitation from a gas) and thermal; and electrolytic. **Particle shape**, size, and size distribution strongly influence the characteristics of powders, particularly their behavior during die filling, compaction, and sintering. The range of shapes covers highly spherical, highly irregular, flake, dendritic (needlelike), and sponge (porous). Metal powders are classified as elemental, partially alloyed, or prealloyed.

The three basic steps for producing conventional-density PM parts are mixing, compacting, and sintering.

Elemental or prealloyed metal powders are mixed with lubricants and/or other alloy additions to produce a homogeneous mixture.

In compacting, a controlled amount of mixed powder is automatically gravity-fed into a precision die and is compacted, usually at room temperatures at pressures as low as 10 or as high as 60 or more tons/in<sup>2</sup> (138 to 827 MPa), depending on the density requirements of the part. Normally compacting pressures in the range of 30 to 50 tons/in<sup>2</sup> (414 to 690 MPa) are used. Special mechanical or hydraulic presses are equipped with very rigid dies designed to withstand the extremely high loads experienced during compaction. Compacting loose powder produces a *green compact* which, with conventional pressing techniques, has the size and shape of the finished part when ejected from the die and is sufficiently rigid to permit in-process handling and transport to a sintering furnace. Other specialized compacting and alternate forming methods can be used, such as powder forging, isostatic pressing, extrusion, injection molding, and spray forming.

During sintering, the green part is placed on a wide mesh belt and moves slowly through a controlled-atmosphere furnace. The parts are

Table 6.4.42 Properties of Powdered Ferrous Metals

Material	Density, g/cm <sup>3</sup>	Tensile strength*		Comments
		MPa	lb/in <sup>2</sup>	
Carbon steel				
MPIF F-0008	6.9	370†	54,000†	Often cost-effective
0.8% combined carbon (c.c.)	6.9	585‡	85,000‡	
Copper steel				
MPIF FC-0208	6.7	415†	60,000†	Good sintered strength
2% Cu, 0.8% c.c.	6.7	585‡	85,000‡	
Nickel steel				
MPIF FN-0205	6.9	345†	50,000†	Good heat-treated strength, impact energy
2% Ni, 0.5% c.c.	6.9	825‡	120,000‡	
MPIF FN-0405	6.9	385†	56,000†	
4% Ni, 0.5% c.c.	6.9	845‡	123,000‡	
Infiltrated steel				
MPIF FX-1005	7.3	530†	77,000†	Good strength, closed-off internal porosity
10% Cu, 0.5% c.c.	7.3	825‡	120,000‡	
MPIF FX-2008	7.3	550†	80,000†	
20% Cu, 0.8% c.c.	7.3	690‡	100,000‡	
Low-alloy steel, prealloyed Ni, Mo, Mn				
MPIF FL-4605 HT	6.95	895‡	130,000‡	Good hardenability, consistency in heat treatment
Stainless steels				
MPIF SS-316 N2 (316 stainless)	6.5	415†	60,000†	Good corrosion resistance, appearance
MPIF SS-410 HT (410 stainless)	6.5	725‡	105,000‡	

\* Reference: MPIF Standard 35, Materials Standards for P/M Structural Parts. Strength and density given as typical values.

† As sintered.

‡ Heat-treated.

Table 6.4.43 Properties of Powdered Nonferrous Metals

Material	Use and characteristics
Copper	Electrical components
Bronze	Self-lubricating bearings: @ 6.6 g/cm <sup>3</sup> oiled density, 160 MPa (23,000 lb/in <sup>2</sup> ) K strength,*
MPIF CTG-1001	17% oil content by volume
10% tin, 1% graphite	
Brass	Electrical components, applications requiring good corrosion resistance, appearance, and ductility @ 7.9 g/cm <sup>3</sup> , yield strength 75 MPa (11,000 lb/in <sup>2</sup> )
MPIF CZ-1000	
10% zinc	@ 7.9 g/cm <sup>3</sup> , yield strength 125 MPa (18,300 lb/in <sup>2</sup> )
MPIF CZ-3000	
30% zinc	
Nickel silver	Improved corrosion resistance, toughness @ 7.9 g/cm <sup>3</sup> , yield strength 140 MPa (20,000 lb/in <sup>2</sup> )
MPIF CNZ-1818	
18% nickel, 18% zinc	
Aluminum alloy	Good corrosion resistance, lightweight, good electrical and thermal conductivity
Titanium	Good strength/mass ratio, corrosion resistance

\* Radial crushing constant. See MPIF Standard 35, Materials Standards for P/M Self-Lubricating Bearings.

Table 6.4.44 Properties of Powdered Soft Magnetic Metals

Material	Density, g/cm <sup>3</sup>	Maximum magnetic induction, kG*	Coercive field, Oe
Iron, low-density	6.6	10.0	2.0
Iron, high-density	7.2	12.5	1.7
Phosphorous iron, 0.45% P	7.0	12.0	1.5
Silicon iron, 3% Si	7.0	11.0	1.2
Nickel iron, 50% Ni	7.0	11.0	0.3
410 Stainless steel	7.1	10.0	2.0
430 Stainless steel	7.1	10.0	2.0

\* Magnetic field—15 oersteds (Oe).

heated to below the melting point of the base metal, held at the sintering temperature, and then cooled. Basically a solid-state diffusion process, sintering transforms compacted mechanical bonds between the powder particles to metallurgical bonds. Sintering gives the PM part its primary functional properties. PM parts generally are ready for use after sinter-

ing. If required, parts can also be repressed, impregnated, machined, tumbled, plated, or heat-treated. Depending on the material and processing technique, PM parts demonstrate tensile strengths exceeding 200,000 lb/in<sup>2</sup> (1,379 MPa).

Conventional PM bearings generally can absorb additive-free, non-automotive-grade engine oils into 10 to 30 percent of their compacted volume. Impregnation is brought about either by vacuum techniques or by soaking the finished parts in hot oil. Frictional heat generated during operation of the machinery heats the impregnated PM part, causing the oil to expand and flow to the bearing surface. Upon cooling, the flow is reversed, and oil is drawn into the pores by capillary action.

Development continues in the five major processes cited previously that function with metal powders as the raw material. The basic advantages of the processes make it attractive to seek wider application in a host of new products, to increase the size and complexity of parts that can be handled, and to expand further the types of powders that can be processed. Included among the newer materials are advanced particulates such as intermetallics, cermets, composites, nanoscale materials, and aluminides.

## NICKEL AND NICKEL ALLOYS

by John H. Tundermann

REFERENCES: Mankins and Lamb, "Nickel and Nickel Alloys," ASM Handbook, vol. 2, 10th ed., pp. 428–445. Tundermann et al., "Nickel and Nickel Alloys," Kirk Othmer Encyclopedia of Chemical Technology, vol. 17, Frantz, "Low Expansion Alloys," ASM Handbook, vol. 2, 10th ed., pp. 889–896.

Nickel is refined from sulfide and lateritic (oxide) ores using pyrometallurgical, hydrometallurgical, and other specialized processes. Sulfide ores are used to produce just over 50 percent of the nickel presently used in the world. High-purity nickel (99.7+ percent) products are produced via electrolytic, carbonyl, and powder processes.

Electroplating accounts for about 10 percent of the total annual consumption of nickel. Normal nickel electroplate has properties approximating those of wrought nickel, but special baths and techniques can give much harder plates. Bonds between nickel and the base metal are usually strong. The largest use of nickel in plating is for corrosion



Table 6.4.45 Nominal Compositions, %, of Selected Nickel Alloys

Alloy	Ni	Cu	Fe	Cr	Mo	Al	Si	Mn	W	C	Co	Nb	Ti	Y <sub>2</sub> O <sub>3</sub>
Nickel 200	99.5	0.05	0.1				0.05	0.25		0.05				
Duranickel alloy 301	93.5	0.2	0.2			4.4	0.5	0.3		0.2			0.5	
Monel alloy 400	65.5	31.5	1.5				0.25	1.0		0.15				
Monel alloy K-500	65.5	29.5	1.0			3.0	0.15	0.5		0.15				
Hastelloy alloy C-276	56		5	15.5	16		0.05	1.0	4	0.02	2.5			
Inconel alloy 600	75.5	0.5	8	15.5			0.2	0.5		0.08				
Inconel alloy 625	62		2.5	22	9	0.2	0.2	0.2		0.05		3.5	0.2	
Inconel alloy 718	52.5		18.5	19	3	0.5	0.2	0.2		0.04		5	0.9	
Inconel alloy X-750	71	0.5	7	15.5		0.7	0.5	1.0		0.08	1.0		2.5	
Inconel alloy MA 754	78.5			20		0.3				0.05			0.5	0.6
Incoloy alloy 825	42	2.2	30	21	3	0.1	0.25	0.5		0.03			0.9	
Incoloy alloy 909	38		42				0.4			0.1	13.0	4.7	1.5	
Hastelloy alloy X	45		19.5	22	9		1.0	1.0	0.6	0.1	1.5			

protection of iron and steel parts and zinc-base die castings for automotive use. A 0.04- to 0.08-mm (1.5- to 3-mil) nickel plate is covered with a chromium plate only about one hundredth as thick to give a bright, tarnish-resistant, hard surface. Nickel electrodeposits are also used to facilitate brazing of chromium-containing alloys, to reclaim worn parts, and for electroformed parts.

Wrought nickel and nickel alloys are made by several melting techniques followed by hot and cold working to produce a wide range of product forms such as plate, tube, sheet, strip, rod, and wire.

The nominal composition and typical properties of selected commercial nickel and various nickel alloys are summarized in Tables 6.4.45 to 6.4.48.

Commercially pure nickels, known as Nickel 200 and 201, are available as sheet, rod, wire, tubing, and other fabricated forms. They are used where the thermal or electrical properties of nickel are required and where corrosion resistance is needed in parts that have to be worked extensively.

Commercial nickel may be forged or rolled at 871 to 1,260°C (1,600 to 2,300°F). It becomes increasingly harder below 871°C (1,600°F) but has no brittle range. The recrystallization temperature of cold-worked pure nickel is about 349°C (660°F), but commercial nickel recrystallizes at about 538°C (1,100°F) and is usually annealed at temperatures between 538 and 954°C (1,100 and 1,750°F).

The addition of certain elements to nickel renders it responsive to precipitation or aging treatments to increase its strength and hardness. In the unhardened or quenched state, Duranickel alloy 301 fabricates almost as easily as pure nickel, and when finished, it may be hardened by heating for about 8 h at 538 to 593°C (1,000 to 1,100°F). Intermediate anneals during fabrication are at 900 to 954°C (1,650 to 1,750°F). The increase in strength due to aging may be superimposed on that due to cold work.

Nickel castings are usually made in sand molds by using special techniques because of the high temperatures involved. The addition of

1.5 percent silicon and lesser amounts of carbon and manganese is necessary to obtain good casting properties. Data on nickel and nickel alloy castings can be found in Spear, "Corrosion-Resistant Nickel Alloy Castings," ASM Handbook, vol. 3, 9th ed, pp. 175-178.

Nickel has good to excellent resistance to corrosion in caustics and nonoxidizing acids such as hydrochloric, sulfuric, and organic acids, but poor resistance to strongly oxidizing acids such as nitric acid. Nickel is resistant to corrosion by chlorine, fluorine, and molten salts.

Nickel is used as a catalyst for the hydrogenation of organic fats and for several industrial processes. Porous nickel electrodes are used for battery and fuel cell applications.

**Nickel-Copper Alloys** Alloys containing less than 50 percent nickel are discussed under "Copper and Copper Alloys." **Monel** alloy 400 (see Tables 6.4.45 to 6.4.47) is a nickel-rich alloy that combines high strength, high ductility, and excellent resistance to corrosion. It is a homogeneous solid-solution alloy; hence its strength can be increased by cold working alone. In the annealed state, its tensile strength is about 480 MPa (70 ksi), and this may be increased to 1,170 MPa (170 ksi) in hard-drawn wire. It is available in practically all fabricated forms. Alloy 400 is hot-worked in the range 871 to 1,177°C (1,600 to 2,150°F) after rapid heating in a reducing, sulfur-free atmosphere. It can be cold-worked in the same manner as mild steel, but requires more power. Very heavily cold-worked alloy 400 may commence to recrystallize at 427°C (800°F), but in normal practice no softening will occur below 649°C (1,200°F). Annealing can be done for 2 to 5 h at about 760°C (1,400°F) or for 2 to 5 min at about 940°C (1,725°F). Nonscaling, sulfur-free atmospheres are required.

Because of its toughness, alloy 400 must be machined with high-speed tools with slower cutting speeds and lighter cuts than mild steel. A special grade containing sulfur, Monel alloy 405, should be used where high cutting speeds must be maintained. This alloy is essentially the same as the sulfur-free alloy in mechanical properties and corrosion resistance, and it can be hot-forged.

Table 6.4.46 Typical Physical Properties of Selected Alloys

Alloy	UNS no.	Density, g/cm <sup>3</sup>	Elastic modulus, GPa	Specific heat (20°C), J/(Kg · K)	Thermal expansion (20°-93°C), μm/(m · K)	Thermal conductivity (20°C), W/(m · K)	Electrical resistivity (annealed), μΩ · m
Nickel 200	N02200	8.89	204	456	13.3	70	0.096
Duranickel alloy 301	N03301	8.25	207	435	13.0	23.8	0.424
Monel alloy 400	N04400	8.80	180	427	13.9	21.8	0.547
Monel alloy K-500	N05500	8.44	180	419	13.9	17.5	0.615
Hastelloy alloy C-276	N10276	8.89	205	427	11.2	9.8	1.29
Inconel alloy 600	N06600	8.47	207	444	13.3	14.9	1.19
Inconel alloy 625	N06625	8.44	207	410	12.8	9.8	1.29
Inconel alloy 718	N07718	8.19	211	450	13.0	11.4	1.25
Inconel alloy X-750	N07750	8.25	207	431	12.6	12.0	1.22
Inconel alloy MA 754	N07754	8.30	160	440	12.2	14.3	1.075
Incoloy alloy 825	N08825	8.14	206	440	14.0	11.1	1.13
Incoloy alloy 909	N19909	8.30	159	427	7.7	14.8	0.728
Hastelloy alloy X	N06002	8.23	205	461	13.3	11.6	1.16

**Table 6.4.47 Typical Mechanical Properties of Selected Nickel Alloys**

Alloy	Yield strength, MPa	Tensile strength, MPa	Elongation, % in 2 in	Hardness
Nickel 201	150	462	47	110 HB
Duranickel alloy 301	862	1,170	25	35 HRC
Monel alloy 400	240	550	40	130 HB
Monel alloy K-500	790	1,100	20	300 HB
Hastelloy alloy C-276	355	790	60	90 HRB
Inconel alloy 600	310	655	40	36 HRC
Inconel alloy 625	520	930	42	190 HB
Inconel alloy 718	1,036	1,240	12	45 HRC
Inconel alloy X-750	690	1,137	20	330 HB
Inconel alloy MA 754	585	965	22	25 HRC
Incoloy alloy 825	310	690	45	75 HRB
Incoloy alloy 909	1,035	1,275	15	38 HRC
Hastelloy alloy X	355	793	45	90 HRB

The short-time tensile strengths of alloy 400 at elevated temperatures are summarized in Table 6.4.48.

The fatigue endurance limit of alloy 400 is about 240 MPa (34 ksi) when annealed and 325 MPa (47 ksi) when hard-drawn. The action of corrosion during fatigue is much less drastic on alloy 400 than on steels of equal or higher endurance limit.

Alloy 400 is highly resistant to atmospheric action, seawater, steam, foodstuffs, and many industrial chemicals. It deteriorates rapidly in the presence of moist chlorine and ferric, stannic, or mercuric salts in acid solutions. It must not be exposed when hot to molten metals, sulfur, or gaseous products of combustion containing sulfur.

Small additions of aluminum and titanium to the alloy 400 base nickel-copper alloy produces precipitation-hardenable Monel alloy K-500. This alloy is sufficiently ductile in the annealed state to permit drawing, forming, bending, or other cold-working operations but work-hardens rapidly and requires more power than mild steel. It is hot-worked at 927 to 1,177°C (1,700 to 2,150°F) and should be quenched from 871°C (1,600°F) if the metal is to be further worked or hardened. Heat treatment consists of quenching from 871°C (1,600°F), cold working if desired, and reheating for 10 to 16 h at 538 to 593°C (1,000 to 1,100°F). If no cold working is intended, the quench may be omitted on sections less than 50 mm (2 in) thick and the alloy hardened at 593°C (1,100°F). The properties of the heat-treated alloy remain quite stable, at

least up to 538°C (1,000°F). It is nonmagnetic down to -101°C (-150°F).

**Heat-Resistant Nickel-Chromium and Nickel-Chromium-Iron Alloys** See "Metals and Alloys for Use at Elevated Temperatures" for further information on high-temperature properties of nickel alloys.

The addition of chromium to nickel improves strength and corrosion resistance at elevated temperature. Nickel chromium alloys such as 80 Ni 20 Cr are extensively used in electrical resistance heating applications. Typically, additions of up to 4 percent aluminum and 1 percent yttrium are made to these alloys to increase hot oxidation and corrosion resistance. Incorporating fine dispersions of inert oxides to this system significantly enhances high-temperature properties and microstructural stability. **Inconel** alloy MA 754, which contains 0.6 percent Y<sub>2</sub>O<sub>3</sub>, exhibits good fatigue strength and corrosion resistance at 1,100°C (2,010°F) and is used in gas-turbine engines and other extreme service applications.

Inconel alloy 600 is a nickel-chromium-iron alloy. Alloy 600 is a high-strength nonmagnetic [at -40°C (-40°F)] alloy which is used widely for corrosion- and heat-resisting applications at temperatures up to 1,204°C (2,200°F) in sulfidizing atmospheres. In sulfidizing atmospheres, the maximum recommended temperature is 816°C (1,500°F). Inconel alloy X-750 is an age-hardenable modification suitable for stressed applications at temperatures up to 649 to 816°C (1,200 to 1,500°F). The addition of molybdenum to this system provides alloys, e.g., Hastelloy alloy X, with additional solid-solution strengthening and good oxidation resistance up to 1,200°C (2,200°F).

The combination of useful strength and oxidation resistance makes nickel alloys frequent choices for high-temperature service. Table 6.4.48 indicates the changes in mechanical properties with temperature.

**Corrosion-Resistant Nickel-Molybdenum and Nickel-Iron-Chromium Alloys** A series of solid-solution nickel alloys containing molybdenum exhibit superior resistance to corrosion by hot concentrated acids such as hydrochloric, sulfuric, and nitric acids. Hastelloy alloy C-276, which also contains chromium, tungsten, and cobalt, is resistant to a wide range of chemical process environments including strong oxidizing acids, chloride solutions, and other acids and salts. Incoloy alloy 825, a nickel-iron-chromium alloy with additions of molybdenum, is especially resistant to sulfuric and phosphoric acids. These alloys are used in pollution control, chemical processing, acid production, pulp and paper production, waste treatment, and oil and gas applications. Although these types of alloys are used extensively in aqueous environments, they also have good elevated-temperature properties.

**Table 6.4.48 Short-Time High-Temperature Properties of Hot-Rolled Nickel and Its Alloys\***

	Temperature, °C							
	21	316	427	540	650	816	982	1,093
Nickel 200†								
Tensile strength, MPa	505	575	525	315	235	170	55	
Yield strength 0.2% offset, MPa	165	150	145	115	105			
Elongation, % in 2 in	40	50	52	55	57	65	91	
Monel alloy 400								
Tensile strength, MPa	560	540	490	350	205	110	55	
Yield strength 0.2% offset, MPa	220	195	200	160	125	60		
Elongation, % in 2 in	46	51	52	29	34	58	45	
Inconel alloy 600								
Tensile strength, MPa	585	545	570	545	490	220	105	75
Yield strength 0.2% offset, MPa	385	185	195	150	150			
Elongation, % in 2 in	50	51	50	21	5	23	51	67
Inconel alloy 718								
Tensile strength, MPa	1,280			1,140	1,030			
Yield strength 0.2% offset, MPa	1,050			945	870			
Elongation, % in 2 in	22			26	15			

\* See also data on metals and alloys for use at elevated temperature elsewhere in Sec. 6.4.

† Nickel 200 is not recommended for use above 316°C; low-carbon nickel 201 is the preferred substitute.

**Nickel-Iron Alloys** Nickel is slightly ferromagnetic but loses its magnetism at a temperature of 368°C (695°F) when pure. For commercial nickel, this temperature is about 343°C (650°F). Monel alloy 400 is lightly magnetic and loses all ferromagnetism above 93°C (200°F). The degree of ferromagnetism and the temperature at which ferromagnetism is lost are very sensitive to variations in composition and mechanical and thermal treatments.

An important group of soft magnetic alloys is the nickel irons and their modifications, which exhibit high initial permeability, high maximum magnetization, and low residual magnetization. Nickel-iron alloys also exhibit low coefficients of thermal expansion that closely match those of many glasses and are therefore often used for glass-sealing applications. Nickel-iron alloys such as Incoloy alloy 909, which contains cobalt, niobium, and titanium, have found wide applications in gas-turbine and rocket engines, springs and instruments, and as controlled-expansion alloys designed to provide high strength and low coefficients of thermal expansion up to 650°C (1,200°F).

**Low-Temperature Properties of Nickel Alloys** Several nickel-base alloys have very good properties at low temperatures, in contrast to ferrous alloys whose impact strength (the index of brittleness) falls off very rapidly with decreasing temperature. The impact strength remains nearly constant with most nickel-rich alloys, while the tensile and yield strengths increase as they do in the other alloys. Specific data on low-temperature properties may be found in White and Siebert, "Literature Survey of Low-Temperature Properties of Metals," Edwards, and "Mechanical Properties of Metals at Low Temperatures," *NBS Circ* 520, 1952.

**Welding Alloys** Nickel alloys can be welded with similar-composition welding materials and basic welding processes such as gas tungsten arc welding (GTAW), gas metal arc welding (GMAW), shielded metal arc welding (SMAW), brazing, and soldering. The procedures used are similar to those for stainless steels. Nickel-base welding products are also used to weld dissimilar materials. Nickel-base filler metals, especially with high molybdenum contents, are typically used to weld other alloys to ensure adequate pitting and crevice corrosion resistance in final weld deposits. Nickel and nickel iron welding electrodes are used to weld cast irons.

(Note: Inconel, Incoloy, and Monel are trademarks of the Inco family of companies. Hastelloy is a trademark of Haynes International.)

## TITANIUM AND ZIRCONIUM

by John R. Schley

REFERENCES: J. Donachie, "Titanium, A Technical Guide," ASM International, Metals Park, OH. "Titanium, The Choice," rev. 1990, Titanium Development Association, Boulder, CO. ASM Metals Handbook, "Corrosion," vol. 13, 1987 edition, ASM International, Metals Park, OH. Schemel, "ASTM Manual on Zirconium and Hafnium," ASTM STP-639, Philadelphia, PA. "Corrosion of Zirconium Alloys," ASTM STP 368, Philadelphia. "Zircadyne Properties and Applications," Teledyne Wah Chang Albany, Albany, OR. "Basic Design Facts about Titanium," RMI Titanium Company, Niles, OH.

### Titanium

The metal titanium is the ninth most abundant element in the earth's surface and the fourth most abundant structural metal after aluminum, iron, and magnesium. It is a soft, ductile, silvery-gray metal with a density about 60 percent of that of steel and a melting point of 1,675°C (3,047°F). A combination of low density and high strength makes titanium attractive for structural applications, particularly in the aerospace industry. These characteristics, coupled with excellent corrosion resistance, have led to the widespread use of titanium in the chemical processing industries and in oil production and refining.

Like iron, titanium can exist in two crystalline forms: hexagonal close-packed (hcp) below 883°C (1,621°F) and body-centered cubic (bcc) at higher temperatures up to the melting point. Titanium combines readily with many common metals such as aluminum, vanadium, zirconium, tin, and iron and is available in a variety of alloy compositions offering a broad range of mechanical and corrosion properties. Certain of these compositions are heat-treatable in the same manner as steels.

### Production Processes

The commercial production of titanium begins with an ore, either ilmenite (FeTiO<sub>3</sub>) or rutile (TiO<sub>2</sub>), more often the latter, which passes through a series of chemical reduction steps leading to elemental titanium particles, referred to as **titanium sponge**. The sponge raw material then follows a sequence of processing operations resembling those employed in steelmaking operations. Beginning with the melting of titanium or titanium alloy ingots, the process follows a hot-working sequence of ingot breakdown by forging, then rolling to sheet, plate, or bar product. Titanium is commercially available in all common mill product forms such as billet and bar, sheet and plate, as well as tubing and pipe. It also is rendered into castings.

### Mechanical Properties

Commercial titanium products fall into three structural categories corresponding to the allotropic forms of the metal. The alpha structure is present in **commercially pure** (CP) products and in certain alloys containing alloying elements that promote the alpha structure. The alpha-beta form occurs in a series of alloys that have a mixed structure at room temperature, and the beta class of alloys contains elements that stabilize the beta structure down to room temperature. Strength characteristics of the alpha-beta and beta alloys can be varied by heat treatment. Typical alloys in each class are shown in Table 6.4.49, together with their nominal compositions and tensile properties in the annealed condition. Certain of these alloys can be solution-heat-treated and aged to higher strengths.

### Corrosion Properties

Titanium possesses outstanding **corrosion resistance** to a wide variety of environments. This characteristic is due to the presence of a protective, strongly adherent oxide film on the metal surface. This film is normally transparent, and titanium is capable of healing the film almost instantly in any environment where a trace of moisture or oxygen is present. It is very stable and is only attacked by a few substances, most notably hydrofluoric acid. Titanium is unique in its ability to handle certain chemicals such as chlorine, chlorine chemicals, and chlorides. It is essentially inert in seawater, for example. The unalloyed CP grades typically are used for corrosion applications in industrial service, although the alloyed varieties are used increasingly for service where higher strength is required.

### Fabrication

Titanium is cast and forged by conventional practices. Both means of fabrication are extensively used, particularly for the aerospace industry. Wrought titanium is readily fabricated in the same manner as and on the same equipment used to fabricate stainless steels and nickel alloys. For example, cold forming and hot forming of sheet and plate are done on press brakes and hydraulic presses with practices modified to accommodate the forming characteristics of titanium. Titanium is machinable by all customary methods, again using practices recommended for titanium. Welding is the most common method used for joining titanium, for the metal is readily weldable. The standard welding process is **gas tungsten arc welding** (GTAW), or **TIG**. Two other welding processes, **plasma arc welding** (PAW) and **gas metal arc welding** (GMAW), or MIG, are used to a lesser extent. Since titanium reacts readily with the atmospheric gases oxygen and nitrogen, precautions must be taken to use an inert-gas shield to keep air away from the hot weld metal during welding. Usual standard practices apply to accomplish this. Titanium can be torch-cut by **oxyacetylene flame** or by **plasma torch**, but care must be taken to remove contaminated surface metal. For all titanium fabricating practices cited above, instructional handbooks and other reference materials are available. Inexperienced individuals are well advised to consult a titanium supplier or fabricator.

### Applications

Titanium as a material of construction offers the unique combination of wide-ranging corrosion resistance, low density, and high strength. For this reason, titanium is applied broadly for applications that generally

Table 6.4.49 Typical Commercial Titanium Alloys

Designation	Tensile strength		0.2% Yield strength		Elongation, %	Nominal composition, wt %						Impurity limits, wt %				
	MPa	ksi	MPa	ksi		Al	V	Sn	Zr	Mo	Other	N (max)	C (max)	H (max)	Fe (max)	O (max)
<b>Unalloyed (CP grades):</b>																
ASTM grade 1	240	35	170	25	24	—	—	—	—	—	—	0.03	0.10	0.015	0.20	0.18
ASTM grade 2	340	50	280	40	20	—	—	—	—	—	—	0.03	0.10	0.015	0.30	0.25
ASTM grade 7	340	50	280	40	20	—	—	—	—	0.2 Pd	—	0.03	0.10	0.015	0.30	0.25
<b>Alpha and near-alpha alloys:</b>																
Ti-6 Al-2 Sn-4 Zr-2 Mo	900	130	830	120	10	6.0	—	2.0	4.0	2.0	—	0.05	0.05	0.0125	0.25	0.15
Ti-8 Al-1 Mo-1 V	930	135	830	120	10	8.0	1.0	—	1.0	—	—	0.05	0.08	0.012	0.30	0.12
Ti-5 Al-2.5 Sn*	830	120	790	115	10	5.0	—	2.5	—	—	—	0.05	0.08	0.02	0.50	0.20
<b>Alpha-beta alloys:</b>																
Ti-3 Al-2.5 V	620	90	520	75	15	3.0	2.5	—	—	—	—	0.015	0.05	0.015	0.30	0.12
Ti-6 Al-2 V*	900	130	830	120	10	6.0	4.0	—	—	—	—	0.05	0.10	0.0125	0.30	0.20
Ti-6 Al-6 V-2 Sn*	1,030	150	970	140	8	6.0	6.0	2.0	—	—	0.75 Cu	—	—	—	—	—
Ti-6 Al-2 Sn-4 Zr-6 Mo†	1,170	170	1,100	160	8	6.0	—	2.0	4.0	6.0	—	0.04	0.04	0.0125	0.15	0.15
<b>Beta alloys:</b>																
Ti-10 V-2 Fe-3 Al†	1,170	180	1,100	170	8	3.0	10.0	—	—	—	—	0.05	0.05	0.015	2.2	0.13
Ti-15 V-3 Al-3 Sn-3 Cr†	1,240	180	1,170	170	10	3.0	15.0	3.0	—	—	3.0 Cr	0.03	0.03	0.015	0.30	0.13
Ti-3 Al-8 V-6 Cr-4 Mo-4 Zr*	900	130	860	125	16	3.0	8.0	—	4.0	4.0	6.0 Cr	0.03	0.05	0.020	0.25	0.12

\* Mechanical properties given for annealed condition; may be solution-treated and aged to increase strength.

† Mechanical properties given for solution-treated and aged condition.

are categorized as aerospace and nonaerospace, the latter termed *industrial*. The **aerospace applications** consume about 70 percent of the annual production of titanium, and the titanium alloys rather than the CP grades predominate since these applications depend primarily on titanium's high strength/weight ratio. This category is best represented by **aircraft gas-turbine engines**, the largest single consumer of titanium, followed by **airframe structural members** ranging from fuselage frames, wing beams, and landing gear to springs and fasteners. **Spacecraft** also take a growing share of titanium. Nonaerospace or **industrial applications** more often use titanium for its corrosion resistance, sometimes coupled with a requirement for high strength. The unalloyed, commercially pure grades predominate in most corrosion applications and are typically represented by equipment such as heat exchangers, vessels, and piping.

A recent and growing trend is the application of titanium in the offshore oil industry for service on and around offshore platforms. As applied there, titanium uses are similar to those onshore, but with a growing trend toward large-diameter pipe for subsea service. Strength is a major consideration in these applications, and titanium alloys are utilized increasingly.

In the automotive field, the irreversible mandate for lightweight,

fuel-efficient vehicles appears to portend a large use of titanium and its alloys.

### Zirconium

**Zirconium** was isolated as a metal in 1824 but was only developed commercially in the late 1940s, concurrently with titanium. Its first use was in nuclear reactor cores, and this is still a major application. Zirconium bears a close relationship to titanium in physical and mechanical properties, but has a higher density, closer to that of steel. Its melting point is 1,852°C (3,365°F) and, like titanium, it exhibits two allotropic crystalline forms. The pure metal is body-centered cubic (bcc) above 865°C (1,590°F) and hexagonal close-packed (hcp) below this temperature. Zirconium is available commercially in unalloyed form and in several alloyed versions, combined most often with small percentages of niobium or tin. It is corrosion-resistant in a wide range of environments.

Zirconium is derived from naturally occurring zircon sand processed in a manner similar to titanium ores and yielding a **zirconium sponge**. The sponge is converted to mill products in the same manner as titanium sponge. The principal commercial compositions intended for corrosion applications together with corresponding mechanical properties are listed in Tables 6.4.50 and 6.4.51.

Table 6.4.50 Chemical Compositions of Zirconium Alloys (Percent)

Grade (ASTM designation)	R60702	R60704	R60705	R60706
Zr + Hf, min	99.2	97.5	95.5	95.5
Hafnium, max	4.5	4.5	4.5	4.5
Fe + Cr	max 0.20	0.2–0.4	max 0.2	max 0.2
Tin	—	1.0–2.0	—	—
Hydrogen, max	0.005	0.005	0.005	0.005
Nitrogen, max	0.025	0.025	0.025	0.025
Carbon, max	0.05	0.05	0.05	0.05
Niobium	—	—	2.0–3.0	2.0–3.0
Oxygen, max	0.16	0.18	0.18	0.16

Table 6.4.51 Minimum ASTM Requirements for the Mechanical Properties of Zirconium at Room Temperature (Cold-Worked and Annealed)

Grade (ASTM designation)	R60702	R60704	R60705	R60706
Tensile strength, min, ksi (MPa)	55 (379)	60 (413)	80 (552)	74 (510)
Yield strength, min, ksi (MPa)	30 (207)	35 (241)	55 (379)	50 (345)
Elongation (0.2% offset), min, percent	16	14	16	20
Bend test radius*	5T	5T	3T	2.5T

\* Bend tests are not applicable to material over 0.187 in (4.75 mm) thick and T equals the thickness of the bend test

Zirconium is a reactive metal that owes its **corrosion resistance** to the formation of a dense, stable, and highly adherent oxide on the metal surface. It is resistant to most organic and mineral acids, strong alkalis, and some molten salts. A notable corrosion characteristic is its resistance to both strongly reducing hydrochloric acid and highly oxidizing nitric acid, relatively unique among metallic corrosion-resistant materials.

Zirconium and its alloys can be machined, formed, and welded by conventional means and practices much like those for stainless steels and identical to those for titanium. Cast shapes are available for equipment such as pumps and valves, and the wrought metal is produced in all standard mill product forms. Persons undertaking the fabrication of zirconium for the first time are well advised to consult a zirconium supplier.

The traditional application of zirconium in the nuclear power industry takes the form of fuel element cladding for reactor fuel bundles. The zirconium material used here is an alloy designated **Zircaloy**, containing about 1.5 percent tin and small additions of nickel, chromium, and iron. It is selected because of its low neutron cross section coupled with the necessary strength and resistance to water corrosion at reactor operating temperatures. Most zirconium is employed here. An interesting non-corrosion zirconium application in photography had been its use as a foil in flash bulbs, but the advent of the electronic flash has curtailed this. An active and growing corrosion application centers on fabricated chemical processing equipment, notably heat exchangers, but also a variety of other standard equipment.

## ZINC AND ZINC ALLOYS

by Frank E. Goodwin

REFERENCES: Porter, "Zinc Handbook," Marcel Dekker, New York. ASM "Metals Handbook," 10th ed., vol. 2. ASTM, "Annual Book of Standards." "NADCA Product Specification Standards for Die Casting," Die Casting Development Council.

Zinc, one of the least expensive nonferrous metals, is produced from sulfide, silicate, or carbonate ores by a process involving concentration and roasting followed either by thermal reduction in a zinc-lead blast furnace or by leaching out the oxide with sulfuric acid and electrolyzing the solution after purification. Zinc distilled from blast-furnace production typically contains Pb, Cd, and Fe impurities that may be eliminated by fractional distillation to produce zinc of 99.99+ percent purity. Metal of equal purity can be directly produced by the electrolytic process. Zinc ingot range from cast balls weighing a fraction of a pound to a 1.1-ton [1 metric ton (t)] "jumbo" blocks. Over 20 percent of zinc metal produced each year is from recycled scrap.

The three standard grades of zinc available in the United States are described in ASTM specification B-6 (see Table 6.4.52). **Special high grade** is overwhelmingly the most commercially important and is used in all applications except as a coating for steel articles galvanized after fabrication. In other applications, notably die casting, the higher levels of impurities present in grades other than special high grade can have harmful effects on corrosion resistance, dimensional stability, and formability. Special high grade is also used as the starting point for brasses containing zinc.

### Galvanized Coatings

Protective coatings for steel constitute the largest use of zinc and rely upon the galvanic or sacrificial property of zinc relative to steel. Lead can be added to produce the solidified surface pattern called **spangle** preferred on unpainted articles. The addition of aluminum in amounts of 5 and 55 percent results in coatings with improved corrosion resistance termed **Galfan** and **Galvalume**, respectively.

### Zinc Die Castings

Zinc alloys are particularly well suited for making die castings since the melting point is reasonably low, resulting in long die life even with ordinary steels. High accuracies and good surface finish are possible.

Table 6.4.52 ASTM Specification B-6-77 for Slab Zinc

Grade	Composition, %			
	Lead, max	Iron, max	Cadmium, max	Zinc, min, by difference
Special high grade*	0.003	0.003	0.003	99.990
High grade	0.03	0.02	0.02	99.90
Prime western†	1.4	0.05	0.20	98.0

\* Tin in special high grade shall not exceed 0.001%.

† Aluminum in prime western zinc shall not exceed 0.05%.

SOURCE: ASTM, reprinted with permission.

Alloys currently used for die castings in the United States are covered by ASTM Specifications B-86 and B-669. Nominal compositions and typical properties of these compositions are given in Table 6.4.53. The low limits of impurities are necessary to avoid disintegration of the casting by intergranular corrosion under moist atmospheric conditions. The presence of magnesium or nickel prevents this if the impurities are not higher than the specification values. The mechanical properties shown in Table 6.4.53 are from die-cast test pieces of 0.25-in (6.4-mm) section thickness. Zinc die castings can be produced with section thicknesses as low as 0.03 in (0.75 mm) so that considerable variations in properties from those listed must be expected. These die-casting alloys generally increase in strength with increasing aluminum content. The 8, 12, and 27 percent alloys can also be gravity-cast by other means.

Increasing copper content results in growth of dimensions at elevated temperatures. A measurement of the expansion of the die casting after exposure to water vapor at 203°F (95°C) for 10 days is a suitable index of not only stability but also freedom from susceptibility to intergranular corrosion. When held at room temperature, the copper-containing alloys begin to shrink immediately after removal from the dies; total **shrinkage** will be approximately two-thirds complete in 5 weeks. The maximum extent of this **shrinkage** is about 0.001 in/in (10  $\mu\text{m}/\text{cm}$ ). The copper-free alloys do not exhibit this effect. Stabilization may be effected by heating the alloys for 3 to 6 h at 203°F (95°C), followed by air cooling to room temperature.

### Wrought Zinc

Zinc rolled in the form of sheet, strip, or plate of various thicknesses is used extensively for automobile trim, dry-cell battery cans, fuses, and plumbing applications. Compositions of standard alloys are shown in Table 6.4.54. In addition, a comparatively new series of alloys containing titanium, exhibiting increased strength and creep resistance together with low thermal expansion, has become popular in Europe. A typical analysis is 0.5 to 0.8 percent Cu, 0.08 to 0.16 percent Ti, and maximum values of 0.2 percent Pb, 0.015 percent Fe, 0.01 percent Cd, 0.01 percent Mn, and 0.02 percent Cr. All alloys are produced by hot rolling followed by cold rolling when some stiffness and temper are required. Deep-drawing or forming operations are carried out on the softer grades, while limited forming to produce architectural items, plumbing, and automotive trim can be carried out using the harder grades.

Alloys containing 0.65 to 1.025 percent Cu are significantly stronger than unalloyed zinc and can be work-hardened. The addition of 0.01 percent Mg allows design stresses up to 10,000 lb/in<sup>2</sup> (69 MPa). The Zn-Cu-Ti alloy is much stronger, with a typical tensile strength of 25,000 lb/in<sup>2</sup> (172 MPa).

**Rolled zinc** may be easily formed by all standard techniques. The deformation behavior of rolled zinc and its alloys varies with direction; its crystal structure renders it nonisotropic. In spite of this, it can be formed into parts similar to those made of copper, aluminum, and brass, and usually with the same tools, provided the temperature is not below 70°F (21°C). More severe operations can best be performed at temperatures up to 125°F (52°C). When a cupping operation is performed, a take-in of 40 percent on the first draw is usual. Warm, soapy water is widely used as a lubricant. The soft grades are self-annealing at room temperature, but harder grades respond to deformation better if they are annealed between operations. The copper-free zincs are annealed at 212°F (100°C) and the zinc-copper alloys at 440°C (220°C). Welding is

Table 6.4.53 Composition and Typical Properties of Zinc-Base Die Casting Alloys

Element	Composition, %					
	UNS Z33521 (AG40A) Alloy 3	UNS Z33522 (AG40B) Alloy 7	UNS Z35530 (AC41A) Alloy 5	UNS Z25630 ZA-8	UNS Z35630 ZA-12	UNS Z35840 ZA-27
Copper	0.25 max	0.25 max	0.75–1.25	0.8–1.3	0.5–1.25	2.0–2.5
Aluminum	3.5–4.3	3.5–4.3	3.5–4.3	8.0–8.8	10.5–11.5	25.0–28.0
Magnesium	0.020–0.05	0.005–0.020	0.03–0.08	0.015–0.030	0.015–0.030	0.010–0.020
Iron, max	0.100	0.075	0.100	0.10	0.075	0.10
Lead, max	0.005	0.0030	0.005	0.004	0.004	0.004
Cadmium, max	0.004	0.0020	0.004	0.003	0.003	0.003
Tin, max	0.003	0.0010	0.003	0.002	0.002	0.002
Nickel	—	0.005–0.020	—	—	—	—
Zinc	Rest	Rest	Rest	Rest	Rest	Rest
Yield strength						
lb/in <sup>2</sup>	32	32	39	41–43	45–48	52–55
MPa	221	221	269	283–296	310–331	359–379
Tensile strength						
lb/in <sup>2</sup>	41.0	41.0	47.7	54	59	62
MPa	283	283	329	372	400	426
Elongation in 2 in (5 cm), %	10	14	7	6–10	4–7	2.0–3.5
Charpy impact on square specimens						
ft/lb	43	43	48	24–35	15–27	7–12
J	58	58	65	32–48	20–37	9–16
Brinell Hardness number on square specimens, 500-kg load, 10-mm ball, 30 s	82	80	91	100–106	95–105	116–122

SOURCE: ASTM, reprinted with permission.

Compositions from ASTM Specifications B-86-83 and B-669-84. Properties from NADCA Product Specification Standards for Die Castings.

Table 6.4.54 Typical Composition of Rolled Zinc ASTM Specification B69-66, %

Lead	Iron, max	Cadmium	Copper	Magnesium	Zinc
0.05 max	0.010	0.005 max	0.001 max	—	Remainder
0.05–0.12	0.012	0.005 max	0.001 max	—	Remainder
0.30–0.65	0.020	0.20–0.35	0.005 max	—	Remainder
0.05–0.12	0.012	0.005 max	0.65–1.25	—	Remainder
0.05–0.12	0.015	0.005 max	0.75–1.25	0.007–0.02	Remainder

SOURCE: ASTM, reprinted with permission.

possible with a wire of composition similar to the base metals. Soldering with typical tin-lead alloys is exceptionally easy. The impact extrusion process is widely used for producing battery cups and similar articles.

#### Effect of Temperature

Properties of zinc and zinc alloys are very sensitive to temperature. Creep resistance decreases with increasing temperature, and this must be

considered in designing articles to withstand continuous load. When steel screws are used to fasten zinc die castings, maximum long-term clamping load will be reached if an engagement length 4 times the diameter of the screw is used along with cut (rather than rolled) threads on the fasteners.

## 6.5 CORROSION

by Robert D. Bartholomew and David A. Shifler

REFERENCES: Uhlig, "The Corrosion Handbook," Wiley, New York. Evans, "An Introduction to Metallic Corrosion," 3d ed., Edward Arnold & ASM International, Metals Park, OH. van Delinder (ed.), "Corrosion Basics—An Introduction," NACE International, Houston. Wranglen, "An Introduction to Corrosion and Protection of Metals," Chapman and Hall, London. Fontana, "Corrosion Engineering," 3d ed., McGraw-Hill, New York. Jones, "Principles and Prevention of Corrosion," Macmillan, New York. Scully, "The Fundamentals of Corrosion," 3d ed., Pergamon, New York. Kaesche, "Metallic Corrosion," 2d ed., NACE International, Houston. Sheir (ed.), "Corrosion," 2d ed., Newnes-Butter-

worths, London. "Corrosion," vol. 13, "Metals Handbook," 9th ed., ASM International, Metals Park, OH. Gellings, "Introduction to Corrosion Prevention and Control," Delft University Press, Delft, The Netherlands. Pourbaix, "Atlas of Electrochemical Equilibria in Aqueous Solutions," NACE International, Houston. Prentice, "Electrochemical Engineering Principles," Prentice-Hall, Englewood Cliffs, NJ. Bockris and Reddy, "Modern Electrochemistry," Plenum, New York. Bockris and Khan, "Surface Electrochemistry—A Molecular Level Approach," Plenum, New York.

## INTRODUCTION

**Corrosion** is the deterioration of a material or its properties due to its reaction with the environment. Materials may include metals and alloys, nonmetals, woods, ceramics, plastics, composites, etc. Although corrosion as a science is barely 150 years old, its effects have affected people for thousands of years. The importance of understanding the causes, initiation, and propagation of corrosion and the methods for controlling its degradation is threefold. First, corrosion generates an **economic impact** through materials losses and failures of various structures and components. An SSINA-Battelle study estimated that the combined economic loss to the United States in 1995 due to metal and alloy corrosion (nonmetals not included) was \$300 billion [*Mater. Perf.* v. 34, No. 6, p. 5 (1995)]. Studies of corrosion costs in other countries have determined that 3 to 4 percent of GNP is related to economic losses from corrosion. These estimates consider only the direct economic costs. Indirect costs are difficult to assess but can include plant downtime, loss of products or services, lowered efficiency, contamination, and overdesign of structures and components. Application of current corrosion control technology (discussed later) could recover or avoid 15 to 20 percent of the costs due to corrosion.

Second, an important consideration of corrosion prevention or control is improved **safety**. Catastrophic degradation and failures of pressure vessels, petrochemical plants, boilers, airplane sections, tanks containing toxic materials, and automotive parts have led to thousands of personal injuries and deaths, which often result in subsequent litigation. If the safety of individual workers or the public is endangered in some manner by selection of a material or use of a corrosion control method, that approach should be abandoned. Once assurance is given that this criterion is met through proper materials selection and improved design and corrosion control methods, other factors can be evaluated to provide the optimum solution.

Third, understanding factors leading to corrosion can **conserve resources**. The world's supply of easily extractable raw materials is limited. Corrosion also imparts wastage of energy water resources, and raw or processed materials.

Corrosion can occur through chemical or electrochemical reactions and is usually an interfacial process between a material and its environment. Deterioration solely by physical means such as erosion, galling, or fretting is not generally considered corrosion. **Chemical corrosion** may be a heterogeneous reaction which occurs at the metal/environment interface and involves the material (metal) itself as one of the reactants. Such occurrences may include metals in strong acidic or alkaline solutions, high-temperature oxidation metal/gas reactions where the oxide or compound is volatile, breakdown of chemical bonds in polymers, dissolution of solid metals or alloys in a liquid metal (e.g., aluminum in mercury), or dissolution of metals in fused halides or nonaqueous solutions.

However, even in acidic or alkaline solutions and in most high-temperature environments, **electrochemical corrosion** consisting of two or more partial reactions involves the transfer of electrons or charges. An electrochemical reaction requires (1) an anode, (2) a cathode, (3) an electrolyte, and (4) a complete electric circuit. In the reaction of a metal (M) in hydrochloric acid, the metal is oxidized and electrons are generated at the anode [see Eq. (6.5.1)]. At the same time, hydrogen cations are reduced and electrons are consumed, to evolve hydrogen gas at the cathode—the **hydrogen evolution reaction** (HER) described in Eq. (6.5.2).



Generally, oxidation occurs at the anode, while reduction occurs at the cathode. Corrosion is usually involved at the anode where the metal or alloy is oxidized; this causes dissolution, wastage, and penetration. Cathodic reactions significant to corrosion are few. These may include, in addition to HER, the following:

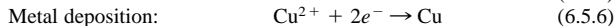
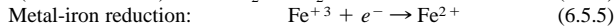
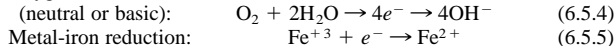
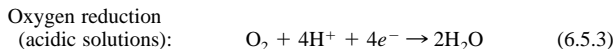

## THERMODYNAMICS OF CORROSION

For an anodic oxidation reaction of metal to occur, a simultaneous reduction must take place. In corroding metal systems, the anodic and cathodic half-reactions are mutually dependent and form a galvanic or spontaneous cell. A cell in which electrons are driven by an external energy source in the direction counter to the spontaneous half-reactions is termed an **electrolytic cell**. A metal establishes a potential or emf with respect to its environment and is dependent on the ionic strength and composition of the electrolyte, the temperature, the metal or alloy itself, and other factors. The potential of a metal at the anode in solution arises from the release of positively charged metal cations together with the creation of a negatively charged metal. The standard potential of a metal is defined by fixing the equilibrium concentration of its ions at unit activity and under reversible (zero net current) and standard conditions (1 atm, 101 kPa; 25°C). At equilibrium, the net current density ( $\mu A/cm^2$ ) of an electrochemical reaction is zero. The nonzero anodic and cathodic currents are equal and opposite, and the absolute magnitude of either current at equilibrium is equal to the exchange current density (that is,  $i_{an} = i_{cath} = i_o$ ).

The potential, a measure of the driving influence of an electrochemical reaction, cannot be evaluated in absolute terms, but is determined by the difference between it and another reference electrode. Common **standard reference electrodes** used are saturated calomel electrode (SCE, 0.2416 V) and saturated Cu/CuSO<sub>4</sub> (0.337 V) whose potentials are measured relative to **standard hydrogen electrode** (SHE), which by definition is 0.000 V under standard conditions. Positive electrochemical potentials of half-cell reactions versus the SHE (written as a reduction reaction) are more easily reduced and noble, while negative values signify half-cell reactions that are more difficult to reduce and, conversely, more easily oxidized or active than the SHE. The signs of the potentials are reversed if the SHE and half-cell reactions of interest are written as oxidation reactions. The potential of a galvanic cell is the sum of the potentials of the anodic and cathodic half-cells in the environment surrounding them.

From thermodynamics, the potential of an electrochemical reaction is a measure of the **Gibbs free energy**  $\Delta G = -nFE$ , where  $n$  is the number of electrons participating in the reaction,  $F$  is Faraday's constant (96,480 C/mol), and  $E$  is the electrode potential. The potential of the galvanic cell will depend on the concentrations of the reactants and products of the respective partial reactions, and on the pH in aqueous solutions. The potential can be related to the Gibbs free energy by the **Nernst equation**

$$\Delta E = \Delta E^\circ + \frac{2.3RT}{nF} \log \frac{(\text{ox})^x}{(\text{red})^y}$$

where  $\Delta E^\circ$  is the standard electrode potential, (ox) is the activity of an oxidized species, (red) is the activity of the reduced species, and  $x$  and  $y$  are stoichiometric coefficients involved in the respective half-cell reactions. Corrosion will not occur unless the spontaneous direction of the reaction (that is,  $\Delta G < 0$ ) indicates metal oxidation. The application of thermodynamics to corrosion phenomena has been generalized by use of **potential-pH plots** or **Pourbaix diagrams**. Such diagrams are constructed from calculations based on the Nernst equation and solubility data for various metal compounds. As shown in Fig. 6.5.1, it is possible to differentiate regions of potential versus pH in which iron either is immune or will potentially passivate from regions in which corrosion will thermodynamically occur. The main uses of these diagrams are to: (1) predict the spontaneous directions of reactions, (2) estimate the composition of corrosion products, and (3) predict environmental changes that will prevent or reduce corrosion. The major limitations of Pourbaix diagrams are that (1) only pure metals, and not alloys, are usually considered; (2) pH is assumed to remain constant, whereas HER may alter the pH; (3) they do not provide information on metastable

films; (4) possible aggressive solutions containing  $\text{Cl}^-$ ,  $\text{Br}^-$ ,  $\text{I}^-$ , or  $\text{NH}_4^+$  are not usually considered; and (5) they do not predict the kinetics or corrosion rates of the different electrochemical reactions. The predictions possible are based on the metal, solution, and temperature designated in the diagrams. Higher-temperature potential-pH diagrams

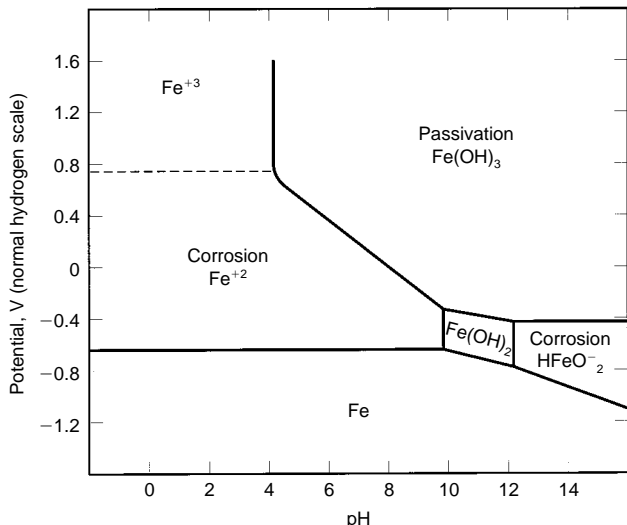

Fig. 6.5.1 Simplified potential-pH diagram for the Fe-H<sub>2</sub>O system. (Pourbaix, "Atlas of Electrochemical Equilibria in Aqueous Solutions.")

have been developed (*Computer-Calculated Potential-pH Diagrams to 300°C*, NP-3137, vol. 2. Electric Power Research Institute, Palo Alto, CA). **Ellingham diagrams** provide thermodynamically derived data for pure metals in gaseous environments to predict stable phases, although they also do not predict the kinetics of these reactions.

## CORROSION KINETICS

Corrosion is thermodynamically possible for most environmental conditions. It is of primary importance to assess the kinetics of corrosion. While free energy and electrode potential are thermodynamic parameters of an electrochemical reaction, the equilibrium exchange current density  $i_0$  is a fundamental kinetic property of the reaction. It is dependent on the material, surface properties, and temperature.

Anodic or cathodic electrochemical reactions such as established in Eqs. (6.5.1) to (6.5.6) often proceed at finite rates. When a cell is short-circuited, net oxidation and reduction occur at the anode and cathode, respectively. The potentials of these electrodes will no longer be at equilibrium. This deviation from **equilibrium potential** is termed **polarization** and results from the flow of a net current. Overvoltage or overpotential is a measure of polarization. Deviations from the equilibrium potential may be caused by (1) concentration polarization, (2) activation polarization, (3) resistance polarization, or (4) mixed polarization. **Concentration polarization**  $\eta_c$  is caused by the limiting diffusion of the electrolyte and is generally important only for cathodic reactions. For example, at high reduction rates of HER, the cathode surface will become depleted of hydrogen ions. If the reduction is increased further, the diffusion rate of hydrogen ions to the cathode will approach a limiting diffusion current density  $i_L$ . This limiting current density can be increased by agitation, higher temperatures, and higher reactant concentrations.

**Activation polarization**  $\eta_a$  refers to the electrochemical process that is controlled by the slow rate-determining step at the metal/electrolyte interface. Activation polarization is characteristic of cathodic reactions such as HER and metal-ion deposition or dissolution. The relationship between activation polarization and the rate of reaction  $i_A$  at the anode is  $\eta_{a(A)} = \beta_A \log i_A/i_{a_0}$ , where  $\beta_A$  represents the Tafel slope ( $\sim 0.60$  to

0.120 V per decade of current) of the anodic half-reaction. A similar expression can be written for the cathodic half-reaction.

**Resistance polarization**  $\eta_R$  includes the ohmic potential drop through a portion of the electrolyte surrounding the electrode, or the ohmic resistance in a metal-reaction product film on the electrode surface, or both. High-resistivity solutions and insulating films deposited at either the cathode or anode restrict or completely block contact between the metal and the solution and will promote a high-resistance polarization. **Mixed polarization** occurs in most systems and is the sum of  $\eta_c$ ,  $\eta_a$ , and  $\eta_R$ . Given  $\beta$ ,  $i_L$ , and  $i_0$ , the kinetics of almost any corrosion reaction can be described.

When polarization occurs mostly at the anodes of a cell, the corrosion reaction is anodically controlled. When polarization develops mostly at the cathode, the corrosion rate is cathodically controlled. Resistance control occurs when the electrolyte resistance is so high that the resultant current is insufficient to polarize either the anode or the cathode. Mixed control is common in most systems in which both anodes and cathodes are polarized to some degree.

Hydrogen overpotential is a dominant factor in controlling the corrosion rate of many metals either in deaerated water or in nonoxidizing acids at cathodic areas; the overpotential is dependent on the metal, temperature, and surface roughness. The result of hydrogen overpotential often will be a surface film of hydrogen atoms. Decreasing pH usually will promote the HER reaction and corrosion rate; acids and acidic salts create a corrosive environment for many metals. Conversely, high-pH conditions may increase hydrogen overpotential and decrease corrosion and may provide excellent protection even without film formation, such as when caustic agents, ammonia, or amines are added to condensate or to demineralized or completely softened water.

Oxygen dissolved in water reacts with the atomic hydrogen film on cathodic regions of the metal surface by depolarization and enables corrosion to continue. The rate of corrosion is approximately limited by the rate at which oxygen diffuses toward the cathode (**oxygen polarization**); thus, extensive corrosion occurs near or at the waterline of a partially immersed or filled steel specimen. In systems where both hydrogen ions and oxygen are present, the initial predominant cathodic reaction will be the one that is most thermodynamically and kinetically favorable.

Corrosion rates have been expressed in a variety of ways. Mills per year (mils/yr) and  $\mu\text{m/yr}$  (SI) are desirable forms in which to measure corrosion or penetration rates and to predict the life of a component from the weight loss data of a corrosion test, as shown by Eqs. (6.5.7a) and (6.5.7b).

$$\text{mils/yr} = \frac{534W}{DAT} \quad (6.5.7a)$$

$$\mu\text{m/yr} = \frac{87,600W}{DAT} \quad (6.5.7b)$$

where  $W$  = weight loss, mg;  $D$  = density of specimen,  $\text{g/cm}^3$ ;  $A$  = area of specimen (mpy; sq. in.) ( $\mu\text{m/yr.}$ , sq. cm);  $T$  = exposure time, h. The corrosion rate considered detrimental for a metal or an alloy will depend on its initial cost, design life, cost of materials replacement, environment, and temperature.

During metallic corrosion, the sum of the anodic currents must equal the sum of the cathodic currents. The corrosion potential of the metal surface is defined by the intersection of the anodic and cathodic polarization curves, where anodic and cathodic currents are equal. Figure 6.5.2 illustrates an idealized polarization curve common for most metals, while Fig. 6.5.3 displays typical anodic dissolution behavior of **active/passive metals** such as iron, chromium, cobalt, molybdenum, nickel, titanium, and alloys containing major amounts of these elements. Anodic currents increase with higher anodic potentials until a critical anodic current density  $i_{pp}$  is reached at the primary passive potential  $E_{pp}$ . Higher anodic potentials will result in formation of a **passive film**.

Generally, metals and alloys (with the possible exception of gold) are not in their most stable thermodynamic state. Corrosion tends to convert



these pure materials back to their stable thermodynamic form. The major factor controlling corrosion of metals and alloys is the nature of the **protective, passive film** in the environment. **Passivity** may be defined as the loss of chemical reactivity under certain environmental conditions. A second definition is illustrated by Fig. 6.5.3; a metal becomes passive if, on increasing its potential to more anodic or positive values, the rate of anodic dissolution decreases (even though the rate should increase as the potential increases). A metal can passivate by (1) chemisorption of the solvent, (2) salt film formation, (3) oxide/oxyhydroxide

## FACTORS INFLUENCING CORROSION

A number of factors influence the stability and breakdown of the **passive film**, and include (1) surface finish, (2) metallurgy, (3) stress, (4) heat treatment, and (5) environment. Polished surfaces generally resist corrosion initiation better than rough surfaces. Surface roughness tends to increase the kinetics of the corrosion reaction by increasing the exchange current density of the HER or the oxygen reduction at the cathodes.

Metallurgical structures and properties often have major effects on corrosion. Regions of varying composition exist along the surface of most metals or alloys. These local compositional changes have different potentials that may initiate local-action cells. Nonmetallic inclusions, particularly sulfide inclusions, are known to initiate corrosion on carbon and stainless steels. The size, shape, and distribution of sulfide inclusions in 304 stainless steel may have a large impact on dissolution kinetics and pitting susceptibility and growth. Elements such as chromium and nickel improve the corrosion resistance of carbon steel by improving the stability of the passive oxide film. Copper (0.2 percent) added to carbon steel improves the atmospheric corrosion resistance of weathering steels.

Stresses, particularly tensile stresses, affect corrosion behavior. These stresses may be either applied or residual. **Residual stresses** may either arise from dislocation pileups or stacking faults due to deforming or cold-working the metal; these may arise from forming, heat-treating, machining, welding, and fabrication operations. Cold working increases the stresses applied to the individual grains by distorting the crystals. Corrosion at cold-worked sites is not increased in natural waters, but increases severalfold in acidic solutions. Possible segregation of carbon and nitrogen occurs during cold working. Welding can induce residual stresses and provide sites that are subject to preferential corrosion and cracking. The welding of two dissimilar metals with different thermal expansion coefficients may restrict expansion of one member and induce applied stresses during service. Thermal fluctuations of fabrication bends or attachments welded to components may cause applied stresses to develop that may lead to cracking.

Improper **heat treatment** or welding can influence the microstructure of different alloys by causing either precipitation of deleterious phases at alloy grain boundaries or (as is the case of austenitic stainless steels) depletion of chromium in grain boundary zones, which decreases the local corrosion resistance. **Welding** also can cause phase transformations, formation of secondary precipitates, and induce stresses in and around the weld. Rapid quenching of steels from austenizing temperatures may form martensite, a distorted tetragonal structure, that often suffers from preferential corrosion.

The nature of the **environment** can affect the rate and form of corrosion. Environments include (1) natural and treated waters, (2) the atmosphere, (3) soil, (4) microbiological organisms, and (5) high temperature. Corrosivity in freshwater varies with oxygen content, hardness, chloride and sulfur content, temperature, and velocity. Water contains colloidal or suspended matter and dissolved solids and gases. All these constituents may stimulate or suppress corrosion either by affecting the cathodic or anodic reaction or by forming a protective barrier. Oxygen is probably the most significant constituent affecting corrosion in neutral and alkaline solutions; hydrogen ions are more significant in acidic solutions. **Freshwater** can be hard or soft. In **hard waters**, calcium carbonate often deposits on the metal surface and protects it; pitting may occur if the calcareous coating is not complete. **Soft waters** are usually more corrosive because protective deposits do not form. Several saturation indices are used to provide scaling tendencies. Nitrates and chlorides increase aqueous conductivity and reduce the effectiveness of natural protective films. The chloride/bicarbonate ratio has been observed to predict the probability of dezincification. Sulfides in polluted waters tend to cause pitting. Deposits on metal surfaces may lead to local stagnant conditions which may lead to pitting. High velocities usually increase corrosion rates by removing corrosion products which otherwise might suppress the anodic reaction and by stimulating the cathodic reaction by providing more oxygen. **High-purity water**, used in nuclear

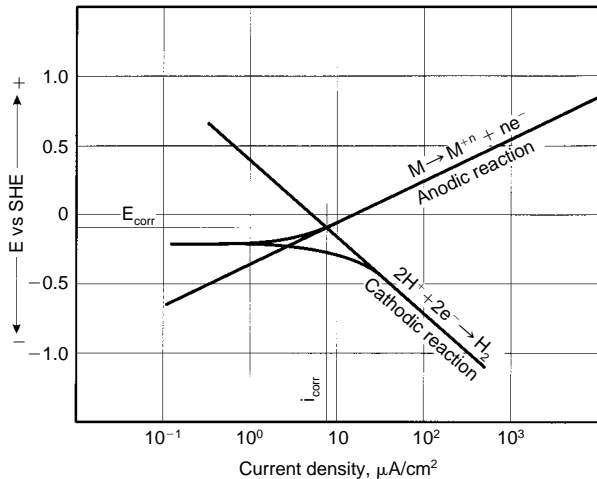

Fig. 6.5.2 Idealized polarization common for most metals at  $E_{\text{corr}}$ , where anodic ( $i_{\text{corr}} = i_a$ ) and cathodic currents are equal. (Adapted from "Fontana's Book on Corrosive Engineering," McGraw-Hill.)

formation (Hoar et al., *Corr. Sci.*, **5**, 1965, p. 279; Agladze et al., *Prot. of Metals*, **22**, 1987, p. 404), and (4) electropolymerization (Shifler et al., *Electrochim. Acta*, **38**, 1993, p. 881). The stability of the passive film will depend on its chemical, ionic, and electronic properties; its degree of crystallinity; the film's flexibility; and the film mechanical properties in a given environment [Frankenthal and Kruger (eds.), "Passivity of Metals—Proc. of the Fourth International Symposium on Passivity," Electrochemical Society, Pennington, NJ]. The **oxide/oxyhydroxide** film is the most common passive film at ambient temperatures in most environments. The passive layer thickness, whether considered as an adsorbed oxygen structure or an oxide film, is generally 50 nm or less.

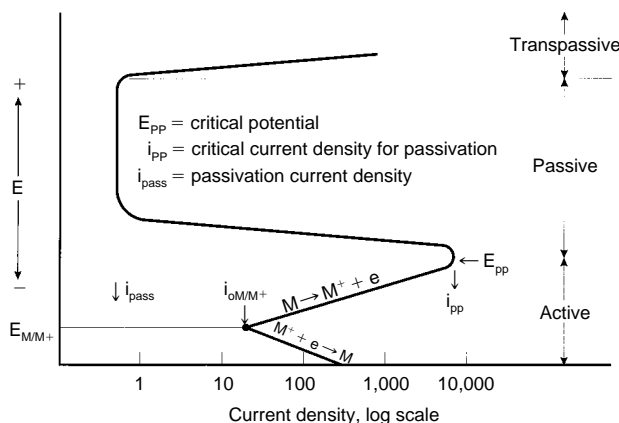

Fig. 6.5.3 Idealized anodic polarization curve for active/passive metals that exhibit passivity. Three different potential regions are identified. (Adapted from "Fontana's Book on Corrosive Engineering," McGraw-Hill.)

and high-pressure power units, decreases corrosion by increasing the electrical resistance of the fluid. Temperature effects in aqueous systems are complex, depending on the nature of the cathodic and anodic reactions.

**Seawater** is roughly equivalent to 3½ percent sodium chloride, but also contains a number of other major constituents and traces of almost all naturally occurring elements. Seawater has a higher conductivity than freshwater, which alone can increase the corrosion of many metals. The high conductivity permits larger areas to participate in corrosion reactions. The high chloride content in seawater can increase localized breakdown of oxide films. The pH of seawater is usually 8.1 to 8.3. Plant photosynthesis and decomposition of marine organisms can raise or lower the pH, respectively. Because of the relatively high pH, the most important cathodic reaction in seawater corrosion processes is oxygen reduction. Highly aerated waters, such as tidal splash zones, are usually regions of very high corrosion rates. Barnacles attached to metal surfaces can cause localized attack if present in discontinuous barriers. Copper and copper alloys have the natural ability to suppress barnacles and other **microfouling organisms**. Sand, salt, and abrasive particles suspended in seawater can aggravate erosion corrosion. Increased seawater temperatures generally increase corrosivity (Laque, "Marine Corrosion—Causes and Prevention," Wiley-Interscience, New York).

In general, **atmospheric corrosion** is the result of the conjoint action of oxygen and water, although contaminants such as sodium chloride and sulfur dioxide accelerate corrosion rates. In the absence of moisture (below 60 to 70 percent relative humidity), most metals corrode very slowly at ambient temperatures. Water is required to provide an electrolyte for charge transfer. Damp corrosion requires moisture from the atmosphere; wet corrosion occurs when water pockets or visible water layers are formed on the metal surface due to salt spray, rain, or dew formation. The solubility of the corrosion products can affect the corrosion rate during wet corrosion; soluble corrosion products usually increase corrosion rates.

Time of wetness is a critical variable that determines the duration of the electrochemical corrosion processes in atmospheric corrosion. Temperature, climatic conditions, relative humidity, and surface shape and conditions that affect time of wetness also influence the corrosion rate. Metal surfaces that retain moisture generally corrode faster than surfaces exposed to rain. Atmospheres can be classified as rural, marine, or industrial. Rural atmospheres tend to have the lowest corrosion rates. The presence of NaCl near coastal shores increases the aggressiveness of the atmosphere. Industrial atmospheres are more corrosive than rural atmospheres because of sulfur compounds. Under humid conditions SO<sub>2</sub> can promote the formation of sulfurous or sulfuric acid. Other contaminants include nitrogen compounds, H<sub>2</sub>S, and dust particles. Dust particles adhere to the metal surface and absorb water, prolonging the time of wetness; these particles may include chlorides that tend to break down passive films [Ailor (ed.), "Atmospheric Corrosion," Wiley-Interscience, New York].

Soil is a complex, dynamic environment that changes continuously, both chemically and physically, with the seasons of the year. Characterizing the **corrosivity of soil** is difficult at best. **Soil resistivity** is a measure of the concentration and mobility of ions required to migrate through the soil electrolyte to a metal surface for a corrosion reaction to continue. Soil resistivity is an important parameter in underground corrosion; high resistivity values often suggest low corrosion rates. The mineralogical composition and earth type affect the grain size, effective surface area, and pore size which, in turn, affect soil corrosivity. Further, soil corrosivity can be strongly influenced by certain chemical species, microorganisms, and soil acidity or alkalinity. A certain water content in soil is required for corrosion to occur. Oxygen also is generally required for corrosion processes, although steel corrosion can occur under oxygen-free, anaerobic conditions in the presence of **sulfate-reducing bacteria** (SRB). Soil water can regulate the oxygen supply and its transport. [Romanoff, *Underground Corrosion*, NBS Circ., 579, 1957, available from NACE International, Houston; Escalante (ed.), "Underground Corrosion," STP 741, ASTM, Philadelphia].

Almost all commercial alloys are affected by **microbiological in-**

**fluenced corrosion** (MIC). Most MIC involves localized corrosion. Biological organisms are present in virtually all natural aqueous environments (freshwater, brackish water, seawater, or industrial water) and in some soils. In these environments, the tendency is for the microorganisms to attach to and grow as a biofilm on the surface of structural materials. Environmental variables (pH, velocity, oxidizing power, temperature, electrode polarization, and concentration) under a biofilm can be vastly different from those in the bulk environment. MIC can occur under aerobic or anaerobic conditions. Biofilms may cause corrosion under conditions that otherwise would not cause dissolution in the environment, may change the mode of corrosion, may increase or decrease the corrosion rate, or may not influence corrosion at all. MIC may be active or passive. Active MIC directly accelerates or establishes new electrochemical corrosion reactions. In passive MIC, the biomass acts as any dirt or deposition accumulation where concentration cells can initiate and propagate. Several forms of bacteria are linked to accelerated corrosion by MIC: (1) SRB, (2) sulfur or sulfide-oxidizing bacteria, (3) acid-producing bacteria and fungi, (4) iron-oxidizing bacteria, (5) manganese-fixing bacteria, (6) acetate-oxidizing bacteria, (7) acetate-producing bacteria, and (8) slime formers [Dexter (ed.), "Biological Induced Corrosion," NACE-8, NACE International, Houston; Kobrin (ed.), "A Practical Manual on Microbiological Influenced Corrosion," NACE International Houston; Borenstein, "Microbiological Influenced Corrosion Handbook," Industrial Press, New York].

**High-temperature service** ( $\geq 100^\circ\text{C}$ ) is especially damaging to many metals and alloys because of the exponential increase in the reaction rate with temperature. Hot gases, steam, molten or fused salts, molten metals, or refractories, ceramics, and glasses can affect metals and alloys at high temperatures. The most common reactant is oxygen; therefore all gas-metal reactions are usually referred to as oxidations, regardless of whether the reaction involves oxygen, steam, hydrogen sulfide, or combustion gases. High-temperature oxidation reactions are generally not electrochemical; diffusion is a fundamental property involved in oxidation reactions. The corrosion rate can be influenced considerably by the presence of contaminants, particularly if they are adsorbed on the metal surface. Pressure generally has little effect on the corrosion rate unless the dissociation pressure of the oxide or scale constituent lies within the pressure range involved. Stress may be important when attack is intergranular. Differential mechanical properties between a metal and its scale may cause periodic scale cracking which leads to accelerated oxidation. **Thermal cycling** can lead to cracking and flaking of scale layers. A variety of molten salt baths are used in industrial processes. Salt mixtures of nitrates, carbonates, or halides of alkaline or alkaline-earth metals may adsorb on a metal surface and cause beneficial or deleterious effects.

There are three major types of cells that transpire in corrosion reactions. The first is the **dissimilar electrode cell**. This is derived from potential differences that exist between a metal containing separate electrically conductive impurity phases on the surface and the metal itself, different metals or alloys connected to one another, cold-worked metal in contact with the same metal annealed, a new iron pipe in contact with an old iron pipe, etc.

The second cell type, the **concentration cell**, involves having identical electrodes each in contact with an environment of differing composition. One kind of concentration cell involves solutions of differing salt levels. Anodic dissolution or corrosion will tend to occur in the more dilute salt or lower-pH solution, while the cathodic reaction will tend to occur in the more concentrated salt or higher-pH solution. Identical pipes may corrode in soils of one composition (clay) while little corrosion occurs in sandy soil. This is due, in part, to differences in soil composition and, in part, to differential aeration effects. Corrosion will be experienced in regions low in oxygen; cathodes will exist in high-oxygen areas.

The third type of cell, the **thermogalvanic cell**, involves electrodes of the same metal that are exposed, initially, in electrolytes of the same composition but at different temperatures. Electrode potentials change with temperature, but temperature also may affect the kinetics of dissolution. Depending on other aspects of the environment, thermogalvanic

cells may accelerate or slow the rate of corrosion. Denickelification of copper-nickel alloys may occur in hot areas of a heat exchanger in brackish water, but are unaffected in colder regions.

## FORMS OF CORROSION

It is convenient to classify corrosion by the various forms in which it exists, preferably by visual examination, although in many cases analysis may require more sophisticated methods. An arbitrary list of **corrosion types** includes (1) uniform corrosion, (2) galvanic corrosion, (3) crevice corrosion, (4) pitting, (5) intergranular corrosion, (6) dealloying or selective leaching, (7) erosion corrosion, (8) environmentally induced cracking, and (9) high-temperature corrosion.

**Uniform attack** is the most common form of corrosion. It is typified by an electrochemical or chemical attack that affects the entire exposed surface. The metal becomes thinner and eventually fails. Unlike many of the other forms of corrosion, uniform corrosion can be easily measured by weight-loss tests and by using equations such as (6.5.7a) and (6.5.7b). The life of structures and components suffering from uniform corrosion then can be accurately estimated.

**Stray-current corrosion** or **stray-current electrolysis** is caused by externally induced electric currents and is usually independent of environmental factors such as oxygen concentration or pH. Stray currents are escaped currents that follow paths other than their intended circuit via a low-resistance path through soil, water, or any suitable electrolyte. Direct currents from electric mass-transit systems, welding machines, and implied cathodic protection systems (discussed later) are major sources of stray-current corrosion. At the point where stray currents enter the unintended structure, the sites will become cathodic because of changes in potential. Areas where the stray currents leave the metal structure become anodic and become sites where serious corrosion can occur. Alternating currents generally cause less severe damage than direct currents. Stray-current corrosion may vary over short periods, and it sometimes looks similar to galvanic corrosion.

**Galvanic corrosion** occurs when a metal or an alloy is electrically coupled to another metal, alloy, or conductive nonmetal in a common, conductive medium. A potential difference usually exists between dissimilar metals, which causes a flow of electrons between them. The corrosion rate of the less corrosion-resistant (active) anodic metal is increased, while that of the more corrosion-resistant (noble) cathodic metal or alloy is decreased. Galvanic corrosion may be affected by many factors, including (1) electrode potential, (2) reaction kinetics, (3) alloy composition, (4) protective-film characteristics, (5) mass transport (migration, diffusion, and/or convection), (6) bulk solution properties and environment, (7) cathode/anode ratio and total geometry, (8) polarization, (9) pH, (10) oxygen content and temperature, and (11) type of joint [Hack (ed.), "Galvanic Corrosion," STP 978, ASTM, Philadelphia].

The driving force for corrosion or current flow is the potential difference formed between dissimilar metals. The extent of accelerated corrosion resulting from galvanic corrosion is related to potential differences between dissimilar metals or alloys, the nature of the environment, the polarization behavior of metals involved in the galvanic couple, and the geometric relationship of the component metals. A **galvanic series of metals and alloys** is useful for predicting the possibility of galvanic corrosion (see Fig. 6.5.4) (Baboian, "Galvanic and Pitting Corrosion—Field and Laboratory Studies," STP 576, ASTM, Philadelphia). A galvanic series must be arranged according to the potentials of the metals or alloys in a specific electrolyte at a given temperature and conditions. Separation of two metals in the galvanic series may indicate the possible magnitude of the galvanic corrosion. Since corrosion-product films and other changes in the surface composition may occur in different environments, no singular value may be assigned for a particular metal or alloy. This is important since polarity reversal may occur. For example, at ambient temperatures, zinc is more active than steel and is used to cathodically protect steel; however, above 60°C (e.g., in hot-water heaters), corrosion products formed on zinc may cause the steel to become anodic and corrode preferentially to zinc.

Corrosion from galvanic effects is usually worse near the couple junction and decreases with distance from the junction. The distance influenced by galvanic corrosion will be affected by solution conductivity. In low-conductivity solutions, galvanic attack may be a sharp, localized groove at the junction, while in high-conductivity solutions, galvanic corrosion may be shallow and may spread over a relatively long distance. Another important factor in galvanic corrosion is the cathodic-to-anodic area ratio. Since anodic and cathodic currents ( $\mu\text{A}$ ) must be equal in a corrosion reaction, an unfavorable area ratio is composed of a large cathode and a small anode. The current density ( $\mu\text{A}/\text{cm}^2$ ) and corrosion rate are greater for the small anode than for the large cathode. Corrosion rates depending on the area ratio may be 100 to 1,000 times greater than if the cathode and anode areas were equal. The method by which dissimilar metals or alloys are joined may affect the degree of galvanic corrosion. Welding, where a gradual transition from one material to another often exists, could react differently in a system where two materials are insulated by a gasket but electrically connected elsewhere through the solution, or differently still in a system connected by fasteners.

Galvanic corrosion may be minimized by (1) selecting combinations of metals or alloys near each other in the galvanic series; (2) avoiding unfavorably large cathode/anode area ratios; (3) completely insulating dissimilar metals whenever possible to disrupt the electric circuit; (4) adding inhibitors to decrease the aggressiveness of the environment; (5) avoiding the use of threaded joints to connect materials far apart in the galvanic series; (6) designing for readily replaceable anodic parts; and (7) adding a third metal that is anodic to both metals or alloys in the galvanic couple.

**Crevice corrosion** is the intensive localized corrosion that may occur because of the presence of narrow openings or gaps between metal-to-metal (under bolts, lap joints, or rivet heads) or nonmetal-to-metal (under gaskets, surface deposits, or dirt) components and small volumes of stagnant solution. Crevice corrosion sometimes is referred to as **underdeposit corrosion** or **gasket corrosion**. Resistance to crevice corrosion can vary from one alloy/environmental system to another. Crevice corrosion may range from near uniform attack to severe localized dissolution at the metal surface within the crevice and may occur in a variety of metals and alloys ranging from relatively noble metals such as silver and copper to active metals such as aluminum and titanium. Stainless steels are susceptible to crevice corrosion. Fibrous gasket materials that draw solution into a crevice by capillary action are particularly effective in promoting crevice corrosion. The environment can be any neutral or acidic aggressive solution, but solutions containing chlorides are particularly conducive to crevice corrosion. In cases where the bulk environment is particularly aggressive, general corrosion may deter localized corrosion at a crevice site.

A condition for crevice corrosion is a crevice or gap that is wide enough to permit solution entry but is sufficiently narrow to maintain a stagnant zone within the crevice to restrict entry of cathodic reactants and removal of corrosion products through diffusion and migration. Crevice gaps are usually 0.025 to 0.1 mm (0.001 to 0.004 in) wide. The critical depth for crevice corrosion is dependent on the gap width and may be only 15 to 40  $\mu\text{m}$  deep. Most cases of crevice corrosion occur in near-neutral solutions in which dissolved oxygen is the cathodic reactant. In seawater, localized corrosion of copper and its alloys (due to differences in  $\text{Cu}^{2+}$  concentration) is different from that of the stainless steel group because the attack occurs outside the crevice rather than within it. In acidic solutions where hydrogen ions are the cathodic reactant, crevice corrosion actually occurs at the exposed surface near the crevice. Decreasing crevice width or increasing crevice depth, bulk chloride concentration, and/or acidity will increase the potential for crevice corrosion. In some cases, deep crevices may restrict propagation because of the voltage drop through the crevice solution (Lee et al., Corrosion/83, paper 69, NACE International, Houston).

A condition common to crevice corrosion is the development of an occluded, localized environment that differs considerably from the bulk solution. The basic overall mechanism of crevice corrosion is the dissolution of a metal [Eq. (6.5.1)] and the reduction of oxygen to hydroxide

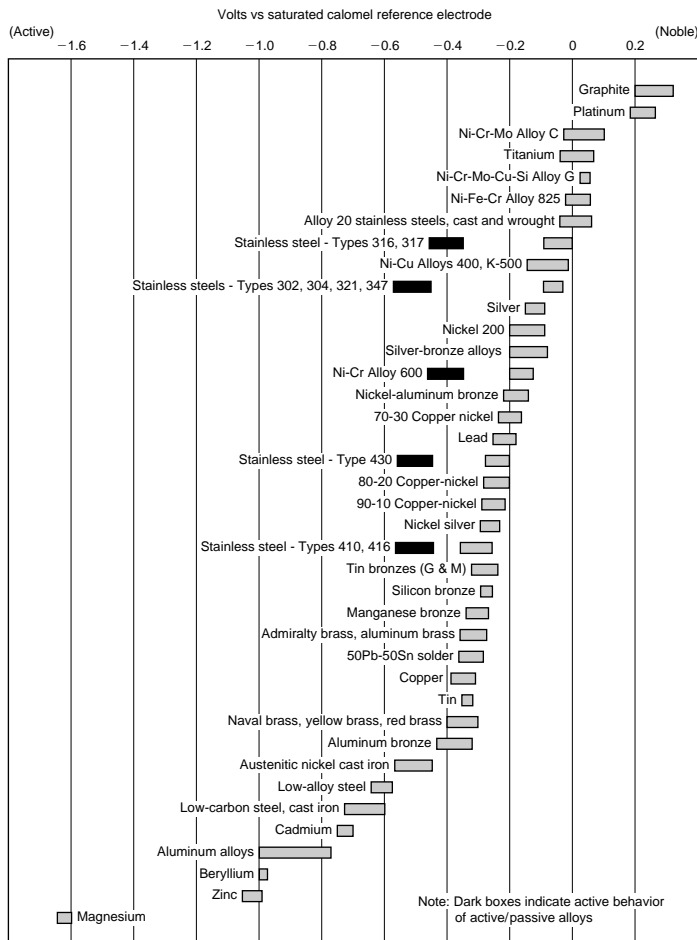

Fig. 6.5.4 Galvanic series for metals and alloys in seawater. Flowing seawater at 2.4 to 4.0 m/s; immersion for 5 to 15 days at 5 to 30°C. (Source: ASTM.)

ions [Eq. (6.5.4)]. Initially, these reactions take place uniformly, both inside and outside the crevice. However, after a short time, oxygen within the crevice is depleted because of restricted convection and oxygen reduction ceases in this area. Because the area within the crevice is much smaller than the external area, oxygen reduction remains virtually unchanged. Once oxygen reduction ceases within the crevice, the continuation of metal dissolution tends to produce an excess of positive charge within the crevice. To maintain charge neutrality, chloride or possibly hydroxide ions migrate into the crevice. This results in an increased concentration of metal chlorides within the crevice, which hydrolyzes in water according to Eq. (6.5.8) to form an insoluble hydroxide and a free acid.



The increased acidity boosts the dissolution rates of most metals and alloys, which increases migration and results in a rapidly accelerating and autocatalytic process. The chloride concentration within crevices exposed to neutral chloride solutions is typically 3 to 10 times higher than that in the bulk solution. The pH within the crevice is 2 to 3. The pH drop with time and critical crevice solution that will cause breakdown in stainless steels can be calculated (Oldfield and Sutton, *Brit. Corrosion J.*, **13**, 1978, p. 13).

Optimum crevice corrosion resistance can be achieved with an active/passive metal that possesses (1) a narrow active-passive transition, (2) a small critical current density, and (3) an extended passive region. Crevice corrosion may be minimized by avoiding riveted, lap, or bolted

joints in favor of properly welded joints, designing vessels for complete drainage and removal of sharp corners and stagnant areas, removing deposits frequently, and using solid, **nonabsorbent gaskets** (such as Teflon) wherever possible.

**Pitting** is a form of extremely localized attack forming a cavity or hole in the metal or alloy. Deterioration by pitting is one of the most dangerous types of localized corrosion, but its unanticipated occurrences and propagation rates are difficult to consider in practical engineering designs. Pits are often covered by corrosion products. Depth of pitting is sometimes expressed by the **pitting factor**, which is the ratio of deepest metal penetration to average metal penetration, as determined by weight-loss measurements. A pitting factor of 1 denotes uniform corrosion.

Pitting is usually associated with the breakdown of a passive metal. Breakdown involves the existence of a critical potential  $E_b$ , induction time at a potential  $>E_b$ , presence of aggressive species ( $Cl^-$ ,  $Br^-$ ,  $ClO_4^-$ , etc.), and discrete sites of attack. Pitting is associated with local imperfections in the passive layer. Nonmetallic inclusions, second-phase precipitates, grain boundaries, scratch lines, dislocations, and other surface inhomogeneities can become initiation sites for pitting (Szkłarska-Smialowska, "Pitting of Metals," NACE International, Houston). The induction time before pits initiate may range from days to years. The induction time depends on the metal, the aggressiveness of the environment, and the potential. The induction time tends to decrease if either the potential or the concentration of aggressive species increases.

Once pits are initiated, they continue to grow through an autocatalytic

process (i.e., the corrosion conditions within the pit are both stimulating and necessary for continuing pit growth). Pit growth is controlled by the rate of depolarization at the cathodic areas. Oxygen in aqueous environments and ferric chloride in various industrial environments are effective depolarizers. The propagation of pits is virtually identical to crevice corrosion. Factors contributing to localized corrosion such as crevice corrosion and pitting of various materials are found in other publications [“Localized Corrosion—Cause of Metal Failure,” STP 516, ASTM, Philadelphia; Brown et al. (eds.), “Localized Corrosion,” NACE-3, NACE International, Houston; Isaacs et al. (eds.), “Advances in Localized Corrosion,” NACE-9, NACE International, Houston; Frankel and Newman (eds.), “Critical Factors in Localized Corrosion,” vol. 92-9, The Electrochemical Society, Pennington, NJ].

Copper and its alloys suffer localized corrosion by nodular pitting in which the attacked areas are covered with small mounds or nodules composed of corrosion product and  $\text{CaCO}_3$  precipitated from water. The pit interior is covered with  $\text{CuCl}$  which prevents formation of a protective  $\text{Cu}_2\text{O}$  layer. Pitting occurs most often in cold, moderately hard to hard waters, but it also happens in soft waters above 60°C. Pitting is associated with the presence of very thin carbon (cathodic) films from lubricants used during tube manufacture. Copper pitting is favored by a high sulfate/chloride ratio. Copper-nickel tubing suffers from accelerated corrosion in seawater due to the presence of both sulfides and oxygen. Sulfides prevent the formation of a protective oxide layer, which allows the anodic reaction to proceed unabated and supported by the oxygen reduction reaction.

**Cautic corrosion**, frequently referred to as **caustic gouging** or **ductile gouging**, is a form of localized corrosion that occurs as a result of fouled heat-transfer surfaces of water-cooled tubes and the presence of an active corrodent in the water of high-pressure boilers. Porous deposits that form and grow in these high-heat-input areas produce conditions that allow sodium hydroxide to permeate the deposits by a process called **wick boiling** and that concentrate to extremely high levels (for example, 100 ppm bulk water concentrated to 220,000 ppm NaOH in water film under these deposits) which dissolves the protective magnetite and then reacts directly with the steel to cause rapid corrosion. A smooth, irregular thinning occurs, usually downstream of flow disruptions or in horizontal or inclined tubing.

**Intergranular corrosion** is localized attack that follows a narrow path along the grain boundaries of a metal or an alloy. Intergranular corrosion is caused by the presence of impurities, precipitation of one of the alloying elements, or depletion of one of these elements at or along the grain boundaries. The driving force of intergranular corrosion is the difference in corrosion potential that exists between a thin grain boundary zone and the bulk of immediately adjacent grains. Intergranular corrosion most commonly occurs in aluminum or copper alloys and austenitic stainless steels.

When austenitic stainless steels such as 304 are heated or placed in service at temperatures of 950 to 1450°C, they become sensitized and susceptible to intergranular corrosion, because chromium carbide ( $\text{Cr}_{23}\text{C}_6$ ) is formed. This effectively removes chromium from the vicinity of the grain boundaries, thereby approaching the corrosion resistance of carbon steel in these chromium-depleted areas. Methods to avoid sensitization and to control intergranular corrosion of austenitic stainless steels (1) employ high-temperature heat treatment (solution quenching) at 1,950 to 2,050°C; (2) add elements that are stronger carbide formers (stabilizers such as columbium, columbium plus tantalum, or titanium) than chromium; and (3) lower the carbon content below 0.03 percent. Stabilized austenitic stainless steels can experience intergranular corrosion if heated above 2,250°C, where columbium carbides dissolve, as may occur during welding. Intergranular corrosion of stabilized stainless steels is called **knife-line attack**. This attack transpires in a narrow band in the parent metal adjacent to a weld. Reheating the steel to around 1,950 to 2,250°C reforms the stabilized carbides.

Surface carburization also can cause intergranular corrosion in cast austenitic stainless steels. Overaging of aluminum alloys can form precipitates such as  $\text{CuAl}_2$ ,  $\text{FeAl}_3$ ,  $\text{MgAl}_3$ ,  $\text{MgZn}_2$ , and  $\text{MnAl}_6$  along grain boundaries and can promote intergranular corrosion. Some nickel alloys can form intergranular precipitates of carbides and intermetallic

phases during heat treatment or welding. Alloys with these intergranular precipitates are subject to intergranular corrosion.

**Dealloying** involves the selective removal of the most electrochemically active component metal in the alloy. Selective removal of one metal can result in either localized attack, leading to possible perforation (plug dealloying), or a more uniform attack (layer dealloying), resulting in loss of component strength. Although selective removal of metals such as Al, Fe, Si, Co, Ni, and Cr from their alloys has occurred, the most common dealloying is the selective removal of zinc from brasses, called **dezincification**. Dezincification of brasses (containing 15 percent or more zinc) takes place in soft waters, especially if the carbon dioxide content is high. Other factors that increase the susceptibility of brasses to dealloying are high temperatures, waters with high chloride content, low water velocity, crevices, and deposits on the metal surface. Dezincification is experienced over a wide pH range. Layer dezincification is favored when the environment is acidic and the brass has a high zinc content. Plug dezincification tends to develop when the environment is slightly acidic, neutral, or alkaline and the zinc content is relatively low. It has been proposed that either zinc is selectively dissolved from the alloy, leaving a porous structure of metallic copper in situ within the brass lattice, or both copper and zinc are dissolved initially, but copper immediately redeposits at sites close to where the zinc was dissolved.

Dezincification can be minimized by reducing oxygen in the environment or by cathodic protection. Dezincification of  $\alpha$ -brass (70 percent Cu, 30 percent Zn) can be minimized by alloy additions of 1 percent tin. Small amounts (~0.05 percent) of arsenic, antimony, or phosphorus promote effective inhibition of dezincification for 70/30  $\alpha$ -brass (inhibited admiralty brass). Brasses containing less than 15 percent zinc have not been reported to suffer dezincification.

Gray cast iron selectively leaches iron in mild environments, particularly in underground piping systems. Graphite is cathodic to iron, which sets up a galvanic cell. The dealloying of iron from gray cast iron leaves a porous network of rust, voids, and graphite termed **graphitization** or **graphite corrosion**. The cast iron loses both its strength and its metallic properties, but it experiences no apparent dimensional changes. Graphitization does not occur in nodular or malleable cast irons because a continuous graphite network is not present. White cast iron also is immune to graphitization since it has essentially no available free carbon.

Dealloying also can occur at high temperatures. Exposure of stainless steels to low-oxygen atmospheres at 1,800°F (980°C) results in the selective oxidation of chromium, the creation of a more protective scale, and the depletion of chromium under the scale in the substrate metal. Decarburization can occur in carbon steel tubing if it is heated above 1,600°F (870°C). Denickelification of austenitic stainless steels occurs in liquid sodium.

**Erosion corrosion** is the acceleration or increase of attack due to the relative movement between a corrosive fluid and the metal surface. Mechanically, the conjoint action of erosion and corrosion damages not only the protective film but also the metal or alloy surface itself by the abrasive action of a fluid (gas or liquid) at high velocity. The inability to maintain a protective passive film on the metal or alloy surface raises the corrosion rate. Erosion corrosion is characterized by grooves, gullies, waves, rounded holes, and valleys—usually exhibited in a directional manner. Components exposed to moving fluids and subject to erosion corrosion include bends, elbows, tees, valves, pumps, blowers, propellers, impellers, agitators, condenser tubes, orifices, turbine blades, nozzles, wear plates, baffles, boiler tubes, and ducts.

The hardness of the alloy or metal and/or the mechanical or protective nature of the passive film will affect the resistance to erosion corrosion in a particular environment. Copper and brasses are particularly susceptible to erosion corrosion. Often, an escalation in the fluid velocity increases the attack by erosion corrosion. The effect may be nil until a critical velocity is reached, above which attack may increase very rapidly. The critical velocity is dependent on the alloy, passive layer, temperature, and nature of the fluid environment. The increased attack may be attributed, in part, to increasing cathodic reactant concentration to the metal surface. Increased velocity may decrease attack by increas-

ing the effectiveness of inhibitors or by preventing silt or dirt from depositing and causing crevice corrosion.

Erosion corrosion includes impingement, cavitation, and fretting corrosion. **Impingement attack** occurs when a fluid strikes the metal surface at high velocity at directional-change sections such as bends, tees, turbine blades, and inlets of pipes or tubes. In the majority of cases involving impingement attack, a geometric feature of the system results in turbulence. Air bubbles or solids present in turbulent flow will accentuate attack. **Cavitation damage** is caused by the formation and collapse of vapor bubbles in a liquid near a metal surface. Cavitation occurs where high-velocity water and hydrodynamic pressure changes are encountered, such as with ship propellers or pump impellers. If pressure on a liquid is lowered drastically by flow divergence, water vaporizes and forms bubbles. These bubbles generally collapse rapidly, producing shock waves with pressures as high as 60,000 lb/in<sup>2</sup> (410 MPa), which destroys the passive film. The newly exposed metal surface corrodes, re-forms a passive film which is destroyed again by another cavitation bubble, and so forth. As many as 2 million bubbles may collapse over a small area in 1 s. Cavitation damage causes both corrosion and mechanical effects. **Fretting corrosion** is a form of damage caused at the interface of two closely fitting surfaces under load when subjected to vibration and slip. Fretting is explained as (1) the surface oxide is ruptured at localized sites prompting reoxidation or (2) material wear and friction cause local oxidation. The degree of plastic deformation is greater for softer materials than for hard; seizing and galling may often occur. Lubrication, increased hardness, increased friction, and the use of gaskets can reduce fretting corrosion.

**Environmentally induced cracking** is a brittle fracture of an otherwise ductile material due to the conjoint action of tensile stresses in a specific environment over a period of time. Environmentally induced cracking includes (1) stress corrosion cracking, (2) hydrogen damage, (3) corrosion fatigue, (4) liquid-metal embrittlement, and (5) solid-metal-induced embrittlement.

**Stress corrosion cracking (SCC)** refers to service failures due to the joint interaction of tensile stress with a specific corrodent and a susceptible, normally ductile material. The observed crack propagation is the result of mechanical stress and corrosion reactions. Stress can be externally applied, but most often it is the result of residual tensile stresses. SCC can initiate and propagate with little outside evidence of corrosion or macroscopic deformation and usually provides no warning of impending failure. Cracks often initiate at surface flaws that were preexisting or were formed during service. Branching is frequently associated with SCC; the cracks tend to be very fine and tight and are visible only with special techniques or microscopic instrumentation. Cracking can be intergranular or transgranular. Intergranular SCC is often associated with grain boundary precipitation or grain boundary segregation of alloy constituents such as found in sensitized austenitic stainless steels. Transgranular SCC is related to crystal structure, anisotropy, grain size and shape, dislocation density and geometry, phase composition, yield strength, ordering, and stacking fault energies. The specific corrodents of SCC include (1) carbon steels, such as sodium hydroxide; (2) stainless steels, such as NaOH or chlorides; (3)  $\alpha$ -brass, such as ammoniacal solutions; (4) aluminum alloys, such as aqueous Cl<sup>-</sup>, Br<sup>-</sup>, I<sup>-</sup> solutions; (5) titanium alloys, such as aqueous Cl<sup>-</sup>, Br<sup>-</sup>, I<sup>-</sup> solutions and organic liquids; and (6) high-nickel alloys, high-purity steam [Gangloff and Ives (eds.), "Environment-Induced Cracking of Metals," NACE-10, NACE International, Houston; Bruemmer et al. (eds.), "Parkins Symposium on Fundamental Aspects of Stress Corrosion Cracking," The Minerals, Metals, and Materials Society, Warrendale, PA].

**Hydrogen interactions** can affect most engineering metals and alloys. Terms to describe these interactions have not been universally agreed upon. Hydrogen damage or hydrogen attack is caused by the diffusion of hydrogen through carbon and low-alloy steels. Hydrogen reacts with carbon, either in elemental form or as carbides, to form methane gas. Methane accumulates at grain boundaries and can cause local pressures to exceed the yield strength of the material. Hydrogen damage causes intergranular, discontinuous cracks and decarburization of the steel. Once cracking occurs, the damage is irreversible. In utility boilers, hydrogen damage has been associated with fouled heat-transfer surfaces.

Hydrogen damage is temperature dependent with a threshold temperature of about 400°F (204°C). Hydrogen damage has been observed in boilers operating at pressures of 450 to 2,700 lb/in<sup>2</sup> (3.1 to 18.6 MPa) and tube metal temperatures of 600 to 950°F (316 to 510°C). Hydrogen damage may occur in either acidic or alkaline conditions, although this contention is not universally accepted.

**Hydrogen embrittlement** results from penetration and adsorption of atomic hydrogen into an alloy matrix. This process results in a decrease of toughness and ductility of alloys due to hydrogen ingress. Hydrogen may be removed by baking at 200 to 300°F (93 to 149°C), which returns the alloy mechanical properties very nearly to those existing before hydrogen entry. Hydrogen embrittlement can affect most metals and alloys. Hydrogen blistering results from atomic hydrogen penetration at internal defects near the surface such as laminations or nonmetallic inclusions where molecular hydrogen forms. Pressure from H<sub>2</sub> can cause local plastic deformation or surface exfoliation [Moody and Thompson (eds.), "Hydrogen Effects on Material Behavior," The Minerals, Metals, and Materials Society, Warrendale, PA].

When a metal or an alloy is subjected to cyclic, changing stresses, then cracking and fracture can occur at stresses lower than the yield stress through fatigue. A clear relationship exists between stress amplitude and number of cyclic loads; an endurance limit is the stress level below which fatigue will not occur indefinitely. Fracture solely by fatigue is not viewed as an example of environmental cracking. However, the conjoint action of a corrosive medium and cyclic stresses on a material is termed **corrosion fatigue**. Corrosion fatigue failures are usually "thick-walled," brittle ruptures showing little local deformation. An endurance limit often does not exist in corrosion fatigue failures. Cracking often begins at pits, notches, surface irregularities, welding defects, or sites of intergranular corrosion. Surface features of corrosion fatigue cracking vary with alloys and specific environmental conditions. Crack paths can be transgranular (carbon steels, aluminum alloys, etc.) or intergranular (copper, copper alloys, etc.); exceptions to the norm are found in each alloy system. "Oyster shell" markings may denote corrosion fatigue failures, but corrosion products and corrosion often cover and obscure this feature. Cracks usually propagate in the direction perpendicular to the principal tensile stress; multiple, parallel cracks are usually present near the principal crack which led to failure. Applied cyclic stresses are caused by mechanical restraints or thermal fluctuations; susceptible areas may also include structures that possess residual stresses from fabrication or heat treatment. Low pH and high stresses, stress cycles, and oxygen content or corrosive species concentrations will increase the probability of corrosion fatigue cracking [Crooker and Leis (eds.), "Corrosion Fatigue-Mechanics, Metallurgy, Electrochemistry, and Engineering," STP-801, ASTM, Philadelphia; McEvily and Staehle (eds.), "Corrosion Fatigue-Chemistry, Mechanics, and Microstructure," NACE International, Houston].

**Liquid-metal embrittlement (LME)** or liquid-metal-induced embrittlement is the catastrophic brittle fracture of a normally ductile metal when coated by a thin film of liquid metal and subsequently stressed in tension. Cracking may be either intergranular or transgranular. Usually, a solid that has little or no solubility in the liquid and forms no intermetallic compounds with the liquid constitutes a couple with the liquid. Fracture can occur well below the yield stress of the metal or alloy (Jones, "Engineering Failure Analysis," **1**, 1994, p. 51). A partial list of examples of LME includes (1) aluminum (by mercury, gallium, indium, tin-zinc, lead-tin, sodium, lithium, and inclusions of lead, cadmium, or bismuth in aluminum alloys); (2) copper and select copper alloys (mercury, antimony, cadmium, lead, sodium, lithium, and bismuth); (3) zinc (mercury, gallium, indium, Pb-Sn solder); (4) titanium or titanium alloys (mercury, zinc, and cadmium); (5) iron and carbon steels (aluminum, antimony, cadmium, copper, gallium, indium, lead, lithium, zinc, and mercury); and (6) austenitic and nickel-chromium steels (tin and zinc).

**Solid-metal-induced embrittlement (SMIE)** occurs below the melting temperature  $T_m$  of the solid in various LME couples. Many instances of loss of ductility or strength and brittle fracture have taken place with electroplated metals or coatings and inclusions of low-melting-point alloys below  $T_m$ . Cadmium-plated steel, leaded steels, and titanium

embrittled by cadmium, silver, or gold are materials affected by SMIE. The prerequisites for SMIE and LME are similar, although multiple cracks are formed in SMIE and SMIE crack propagation is 100 to 1,000 times slower than LME cracking. More detailed descriptions of LME and SMIE are given elsewhere [Kambar (ed.), "Embrittlement of Metals," American Institute of Mining, Metallurgical and Petroleum Engineers, St. Louis].

**High-temperature corrosion** reactions are generally not electrochemical; diffusion is a fundamental property involved in the reactions. Oxide growth advances with time at parabolic, linear, cubic, or logarithmic rates. The corrosion rate can be influenced considerably by the presence of contaminants, particularly if they are adsorbed on the metal surface. Each alloy has an upper temperature limit where the oxide scale, based on its chemical composition and mechanical properties, cannot protect the underlying alloy. Catastrophic oxidation refers to metal-oxygen reactions that occur at continuously increasing rates or break away from protective behavior very rapidly. Molybdenum, tungsten, vanadium, osmium, rhenium, and alloys containing Mo or V may oxidize catastrophically. Internal oxidation may take place in copper- or silver-based alloys containing small levels of Al, Zn, Cd, or Be when more stable oxides are possible below the surface of the metal-scale interface. Sulfidation forms sulfide phases with less stable base metals, rather than oxide phases, when  $H_2S$ ,  $S_2$ ,  $SO_2$ , and other gaseous sulfur species have a sufficiently high concentration. In corrosion-resistant alloys, sulfidation usually occurs when Al or Cr is tied up with sulfides, which interferes with the process of developing a protective oxide. Carburization of high-temperature alloys is possible in reducing carbon-containing environments. Hot corrosion involves the high-temperature, liquid-phase attack of alloys by eutectic alkali-metal sulfates that solubilize a protective alloy oxide, and exposes the bare metal, usually iron, to oxygen which forms more oxide and promotes subsequent metal loss at temperatures of 1,000 to 1,300°F (538 to 704°C). Vanadium pentoxide and sodium oxide can also form low-melting-point [ $\sim 1,000^\circ\text{F}$  (538°C)] liquids capable of causing alloy corrosion. These are usually contaminants in fuels, either coal or oil.

Alloy strength decreases rapidly when metal temperatures approach 900 to 1,000°F and above. Creep entails a time-dependent deformation involving grain boundary sliding and atom movements at high temperatures. When sufficient strain has developed at the grain boundaries, voids and microcracks develop, grow, and coalesce to form larger cracks until failure occurs. The creep rate will increase and the projected time to failure decrease when stress and/or the tube metal temperature is increased [Rapp (ed.), "High Temperature Corrosion," NACE-10, NACE International, Houston; Lai, "High Temperature Corrosion of Engineering Alloys," ASM International, Materials Park, OH].

## CORROSION TESTING

**Corrosion testing** can reduce cost, improve safety, and conserve resources in industrial, commercial, and personal components, processes, and applications. Corrosion evaluation includes laboratory, pilot-plant, and field monitoring and testing. The selection of materials for corrosion resistance in specific industrial services is best made by field testing and actual service performance. However, uncontrollable environmental factors may skew precise comparison of potential alloys or metals, and test times may be unrealistically long. Accelerated corrosion tests in the laboratory can provide practical information to assess potential material candidates in a given environment, predict the service life of a product or component, evaluate new alloys and processes, assess the effects of environmental variations or conditions on corrosion and corrosion control methods, provide quality control, and study corrosion mechanisms.

Careful planning is essential to obtain meaningful, representative, and reliable test results. Metallurgical factors, environmental variables, statistical treatment, and proper interpretation and correlation of accelerated test results to actual field conditions are considerations in the planning and conducting of corrosion tests. The chemical composition, fabrication and metallurgical history, identification, and consistency of materials should be known. Even though, ideally, the surface condition

of the test specimen should mirror the plant conditions, a standard test condition should be selected and maintained. This often requires prescribed procedures for cutting, surface-finishing, polishing, cleaning, chemical treatment or passivation, measuring and weighing, and handling. The exposure technique should provide easy access of the environment to the sample and should not directly cause conditions for test corrosion (e.g., crevice corrosion) unrelated to field conditions.

The type, interval, and duration of the tests should be seriously considered. Corrosion rates of the material may decrease with time because of the formation of protective films or the removal of a less resistant surface metal. Corrosion rates may increase with time if corrosion-inducing salts or scales are produced or if a more resistant metal is removed. The environment may change during testing because of the decrease or increase in concentration of a corrosive species or inhibitor, or the formation of autocatalytic products or other metal-catalyzed variations in the solution. These test solution variations should be recognized and related to field-condition changes over time, if possible. Testing conditions should prescribe the presence or absence of oxygen in the system. Aeration, or the presence of oxygen, can influence the corrosion rate of an alloy in solution. Aeration may increase or decrease the corrosion rate according to the influence of oxygen in the corrosion reaction or the nature of the passive films which develop on different metals and alloys. Temperature is an extremely important parameter in corrosion reactions. The temperature at the specimen surface should be known; a rough rule of thumb is that the corrosion rate doubles for each 10°C rise in temperature.

Laboratory accelerated corrosion tests are used to predict corrosion behavior when service history is unavailable and cost and time prohibit simulated field testing. Laboratory tests also can provide screening evaluations prior to field testing. Such tests include nonelectrochemical and sophisticated electrochemical tests. Nonelectrochemical laboratory techniques include immersion and various salt spray tests that are used to evaluate the corrosion of ferrous and nonferrous metals and alloys, as well as the degree of protection afforded by both organic and inorganic coatings. Since these are accelerated tests by design, the results must be interpreted cautiously. **Standardized test methods** are very effective for both specifications and routine tests used to evaluate experimental or candidate alloys, inhibitors, coatings, and other materials. Many such tests are described in the *Annual Book of ASTM Standards* (vol. 3.02, "Metal Corrosion, Erosion, and Wear") and in standard test methods from the NACE International Book of Standards.

**Electrochemical techniques** are attractive because (1) they allow a direct method of accelerating corrosion processes without changing the environment, (2) they can be used as a nondestructive tool to evaluate corrosion rates, and (3) they offer in situ (field) or ex situ (laboratory) investigations. Most typical forms of corrosion can be investigated by electrochemical techniques. Electrochemical tests may include linear polarization resistance, ac electrochemical impedance, electrochemical noise, cyclic voltammetry, cyclic potentiodynamic polarization, potentiodynamic and potentiostatic polarization, and scratch repassivation. AC impedance has been used to monitor coating integrity and to evaluate the effectiveness of cathodic protection and coating systems in underground piping. There are complications involved in various electrochemical test methods which must be resolved or eliminated before interpretation is possible. The methods used above employ a potentiostat, an instrument that regulates the electrode potential and measures current as a function of potential. A galvanostat varies potential as a function of current.

Corrosion coupons are generally easy to install, reflect actual environmental conditions, and can be used for long-exposure tests. Coupons can evaluate inhibitor programs and are designed to measure specific forms of corrosion. A simple embrittlement detector covered by ASTM D807 permits concentration of boiler water on a stressed steel specimen to detect caustic cracking. Field coupon testing has several limitations: (1) It cannot detect brief process upsets. (2) It cannot guarantee initiation of localized corrosion rates before the coupons are removed. (3) It cannot directly correlate the calculated coupon corrosion rate to equipment or component corrosion. (4) It cannot detect certain forms of corrosion. Corrosion rate sensors created to monitor the corrosion of

large infrastructural components in real time have been developed for aqueous, soil, and concrete environments using linear polarization resistance (Ansuini et al., *Corrosion/95*, paper 14, NACE International, Houston). Ultrasonic thickness, radiography, or eddy current measurements can evaluate corrosion rates in situ. The component surfaces must be clean (free of dirt, paint, and corrosion products) to make measurements. Ultrasonic attenuation techniques have been applied to evaluate the extent of hydrogen damage. A noncontact, nondestructive inspection technique for pitting, SCC, and crevice corrosion has been developed using digital speckle correlation (Jin and Chiang, *Corrosion/95*, paper 535, NACE International, Houston). An ASTM publication [Baboian (ed.), "Manual 20—Corrosion Tests and Standards: Application and Interpretation," ASTM, Philadelphia] provides a detailed, comprehensive reference for field and laboratory testing in different environments for metals and alloys, coatings, and composites. It includes testing for different corrosion forms and for different industrial applications.

### CORROSION PREVENTION OR REDUCTION METHODS

The basis of **corrosion prevention** or reduction methods involves restricting or controlling anodic and/or cathodic portions of corrosion reactions, changing the environmental variables, or breaking the electrical contact between anodes and cathodes. Corrosion prevention or reduction methods include (1) proper materials selection, (2) design, (3) coatings, (4) use of inhibitors, (5) anodic protection, and (6) cathodic protection [Treseder et al. (eds.), "NACE Corrosion Engineer's Reference Book," 2d ed., NACE International, Houston].

The most common method to reduce corrosion is *selecting the right material* for the environmental conditions and applications. Ferrous and nonferrous metals and alloys, thermoplastics, nonmetallic linings, resin coatings, composites, glass, concrete, and nonmetal elements are a few of the materials available for selection. Experience and data, either in-house or from outside vendors and fabricators, may assist in the materials selection process. Many materials can be eliminated by service conditions (temperature, pressure, strength, chemical compatibility). Corrosion data for a particular chemical or environment may be obtained through a literature survey ("Corrosion Abstracts," NACE International; "Corrosion Data Survey—Metals Section," 6th ed., "Corrosion Data Survey—Nonmetals Section," NACE International, Houston) or from expert systems or databases. Different organizations (ASTM, ASM International, ASME, NACE International) may offer references to help solve problems and make predictions about the corrosion behavior of candidate materials. The material should be cost-effective and resistant to the various forms of corrosion (discussed earlier) that may be encountered in its application. General rules may be applied to determine the resistance of metals and alloys. For reducing or nonoxidizing environments (such as air-free acids and aqueous solutions), nickel, copper, and their alloys are usually satisfactory. For oxidizing conditions, chromium alloys are used, while in extremely powerful oxidizing environments, titanium and its alloys have shown superior resistance. The corrosion resistance of chromium and titanium can be enhanced in hot, concentrated oxidizer-free acid by small additions of platinum, palladium, or rhodium.

Many costs related to corrosion could be eliminated by **proper design**. The designer should have a credible knowledge of corrosion or should work in cooperation with a materials and corrosion engineer. The design should avoid gaps or structures where dirt or deposits could easily form crevices; horizontal faces should slope for easy drainage. Tanks should be properly supported and should employ the use of drip skirts and dished, fatigue-resistant bottoms ("Guidelines for the Welded Fabrication of Nickel Alloys for Corrosion-Resistant Service," part 3, Nickel Development Institute, Toronto, Canada). Connections should not be made of dissimilar metals or alloys widely separated in the galvanic series for lap joints or fasteners, if possible. Welded joints should avoid crevices, microstructural segregation, and high residual or applied stresses. Positioning of parts should take into account prevailing envi-

ronmental conditions. The design should avoid local differences in concentration, temperature, and velocity or turbulence. All parts requiring maintenance or replacement must be easily accessible. All parts to be coated must be accessible for the coating application.

**Protective coatings** are used to provide an effective barrier to corrosion and include metallic, chemical conversion, inorganic nonmetallic, and organic coatings. Before the application of an effective coating on metals and alloys, it is necessary to clean the surface carefully to remove, dirt, grease, salts, and oxides such as mill scale and rust. Metallic coatings may be applied by cladding, electrodeposition (copper, cadmium, nickel, tin, chromium, silver, zinc, gold), hot dipping (tin, zinc-galvanizing, lead, and aluminum), diffusion (chromium-chromizing, zinc-sherardizing, boron, silicon, aluminum-calorizing or aluminizing, tin, titanium, molybdenum), metallizing or flame spraying (zinc, aluminum, lead, tin, stainless steels), vacuum evaporation (aluminum), ion implantation, and other methods. All commercially prepared coatings are porous to some degree. Corrosion or galvanic action may influence the performance of the metal coating. Noble (determined by the galvanic series) coatings must be thicker and have a minimum number of pores and small pore size to delay entry of any deleterious fluid. Some pores of noble metal coatings are filled with an organic lacquer or a second lower-melting-point metal is diffused into the initial coating. Sacrificial or cathodic coatings such as cadmium zinc, and in some environments, tin and aluminum, cathodically protect the base metal. Porosity of sacrificial coatings is not critical as long as cathodic protection of the base metal continues. Higher solution conductivity allows larger defects in the sacrificial coating; thicker coatings provide longer times of effective cathodic protection.

Conversion coatings are produced by electrochemical reaction of the metal surface to form adherent, protective corrosion products. Anodizing aluminum forms a protective film of  $Al_2O_3$ . Phosphate and chromate treatments provide temporary corrosion resistance and usually a basis for painting. Inorganic nonmetallic coatings include vitreous enamels, glass linings, cement, or porcelain enamels bonded on metals. Susceptibility to mechanical damage and cracking by thermal shock are major disadvantages of these coatings. An inorganic coating must be perfect and defect-free unless cathodic protection is applied.

Paints, lacquers, coal-tar or asphalt enamels, waxes, and varnishes are typical organic coatings. Converted epoxy, epoxy polyester, moisture-cured polyurethane, vinyl, chlorinated rubber, epoxy ester, oil-modified phenolics, and zinc-rich organic coatings are other barriers used to control corrosion. Paints, which are a mixture of insoluble particles of pigments (for example,  $TiO_2$ ,  $Pb_3O_4$ ,  $Fe_2O_3$ , and  $ZnCrO_4$ ) in a continuous organic or aqueous vehicle such as linseed or tung oil, are the most common organic coatings. All paints are permeable to water and oxygen to some degree and are subject to mechanical damage and eventual breakdown. Inhibitor and antifouling agents are added to improve protection against corrosion. Underground pipelines and tanks should be covered with thicker coatings of asphalt or bituminous paints, in conjunction with cloth or plastic wrapping. Polyester and polyethylene have been used for tank linings and as coatings for tank bottoms (Munger, "Corrosion Prevention by Protective Coatings," NACE International, Houston).

**Inhibitors**, when added above a threshold concentration, decrease the corrosion rate of a material in an environment. If the level of an inhibitor is below the threshold concentration, corrosion could occur more quickly than if the inhibitor were completely absent. Inhibitors may be organic or inorganic and fall into several different classes: (1) passivators or oxidizers, (2) precipitators, (3) cathodic or anodic, (4) organic adsorbents, (5) vapor phase, and (6) slushing compounds. Any one inhibitor may be found in one or more classifications. Factors such as temperature, fluid velocity, pH, salinity, cost, solubility, interfering species, and metal or alloy may determine both the effectiveness and the choice of inhibitor. Federal EPA regulations may limit inhibitor choices (such as chromate use) based on its toxicity and disposal requirements.

**Passivators** in contact with the metal surface act as depolarizers, initiating high anodic current densities and shifting the potential into the passivation range of active/passive metal and alloys. However, if



present in concentrations below  $10^{-3}$  to  $10^{-4}$  M, these inhibitors can cause pitting. Passivating inhibitors are anodic inhibitors and may include oxidizing anions such as chromate, nitrite, and nitrate. Phosphate, molybdate, and tungstate require oxygen to passivate steel and are considered nonoxidizing. Nonoxidizing sodium benzoate, cinnamate, and polyphosphate compounds effectively passivate iron in the near-neutral range by facilitating oxygen adsorption. Alkaline compounds (NaOH,  $\text{Na}_3\text{PO}_4$ ,  $\text{Na}_2\text{B}_4\text{O}_7$ , and  $\text{Na}_2\text{O} \cdot n\text{SiO}_4$ ) indirectly assist iron passivation by enhancing oxygen adsorption.

**Precipitators** are film-forming compounds which create a general action over the metal surface and subsequently indirectly interfere with both anodes and cathodes. Silicates and phosphates in conjunction with oxygen provide effective inhibition by forming deposits. Calcium and magnesium interfere with inhibition by silicates; 2 to 3 ppm of polyphosphates is added to overcome this. The levels of calcium and phosphate must be balanced for effective calcium phosphate inhibition. Addition of a zinc salt often improves polyphosphate inhibition.

**Cathodic inhibitors** (cathodic poisons, cathodic precipitates, oxygen scavengers) are generally cations which migrate toward cathode surfaces where they are selectively precipitated either chemically or electrochemically to increase circuit resistance and restrict diffusion of reducible species to the cathodes. Cathodic poisons interfere with and slow the HER, thereby slowing the corrosion process. Depending on the pH level, arsenic, bismuth, antimony, sulfides, and selenides are useful cathodic poisons. Sulfides and arsenic can cause hydrogen blistering and hydrogen embrittlement. Cathodic precipitation-type inhibitors such as calcium and magnesium carbonates and zinc sulfate in natural waters require adjustment of the pH to be effective. Oxygen scavengers help inhibit corrosion, either alone or with another inhibitor, to prevent cathodic depolarization. Sodium sulfite, hydrazine, carbohydrazide, hydroquinone, methylethylketoxime, and diethylhydroxylamine are oxygen scavengers.

**Organic inhibitors**, in general, affect the entire surface of a corroding metal and affect both the cathode and anode to differing degrees, depending on the potential and the structure or size of the molecule. Cationic, positively charged inhibitors such as amines and anionic, negatively charged inhibitors such as sulfonates will be adsorbed preferentially depending on whether the metal surface is negatively or positively charged. Soluble organic inhibitors form a protective layer only a few molecules thick; if an insoluble organic inhibitor is added, the film may become about 0.003 in (76  $\mu\text{m}$ ) thick. Thick films show good persistence by continuing to inhibit even when the inhibitor is no longer being injected into the system.

Vapor-phase inhibitors consist of volatile aliphatic and cyclic amines and nitrites that possess high vapor pressures. Such inhibitors are placed in the vicinity of the metal to be protected (e.g., inhibitor-impregnated paper), which transfers the inhibiting species to the metal by sublimation or condensation where they adsorb on the surface and retard the cathodic, anodic, or both corrosion processes. This inhibitor protects against water and/or oxygen. Vapor-phase inhibitors are usually effective only if used in closed spaces and are used primarily to retard atmospheric corrosion. Slushing compounds are polar inorganic or organic additives in oil, grease, or wax that adsorb on the metal surface to form a continuous protective film. Suitable additives include organic amines, alkali and alkaline-earth metal salts of sulfonated oils, sodium nitrite, and organic chromates [Nathan (ed.), "Corrosion Inhibitors," NACE International, Houston].

**Anodic protection** is based on the formation of a protective film on metals by externally applied anodic currents. Figure 6.5.5 illustrates the effect. The applied anodic current density is equal to the difference between the total oxidation and reduction rates of the system, or  $i_{\text{app}} = i_{\text{oxid}} - i_{\text{red}}$ . The potential range in which anodic protection is achieved is the protection range or passive region. At the optimum potential  $E_A$ , the applied current is approximately  $1 \mu\text{A}/\text{cm}^2$ . Anodic protection is limited to active/passive metals and alloys and can be utilized in environments ranging from weak to very aggressive. The applied current is usually equal to the corrosion of the protected system which can be used to monitor the instantaneous corrosion rate. Operating conditions in the

field usually can be accurately and quickly determined by electrochemical laboratory tests (Riggs and Locke, "Anodic Protection—Theory and Practice in the Prevention of Corrosion," Plenum Press, New York).

**Cathodic protection** (CP) controls corrosion by supplying electrons to a metal structure, thereby suppressing metal dissolution and increasing hydrogen evolution. Figure 6.5.5 shows that when an applied cathodic current density ( $i_{\text{app}} = i_{\text{red}} - i_{\text{oxid}}$ ) of  $10,000 \mu\text{A}/\text{cm}^2$  on a bare metal surface shifts the potential in the negative or active direction to  $E_c$ , the corrosion rate has been reduced to  $1 \mu\text{A}/\text{cm}^2$ . CP is applicable to all

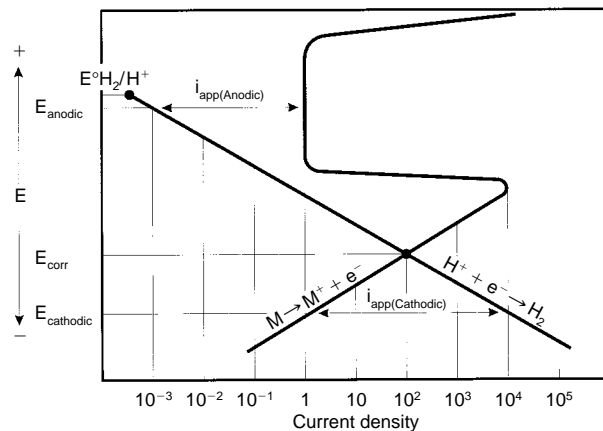

Fig. 6.5.5 Effect of applied anodic and cathodic currents on behavior of an active/passive alloy necessary for anodic and cathodic protection, respectively. (Adapted from "Fontana's Book on Corrosive Engineering," McGraw-Hill.)

metals and alloys and is common for use in aqueous and soil environments. CP can be accomplished by (1) impressed current from an external power source through an inert anode or (2) the use of galvanic couplings by sacrificial anodes. Sacrificial anodes include zinc, aluminum, magnesium, and alloys containing these metals. The total protective current is directly proportional to the surface area of the metal being protected; hence, CP is combined with surface coatings where only the coating pores or holidays and damaged spots need be cathodically protected [e.g., for 10 miles of bare pipe, a current of 500 A would be required, while for 10 miles of a superior coated pipe ( $5 \times 10^6 \Omega/\text{ft}^2$ ) 0.03 A would be required]. The polarization potential can be measured versus a reference, commonly saturated Cu/CuSO<sub>4</sub>. The criterion for proper CP is  $-0.85$  V versus this reference electrode. Overprotection by CP (denoted by potentials less than  $-0.85$  V) can lead to blistering and debonding of pipe coatings and hydrogen embrittlement of steel from hydrogen gas evolution. Another problem with CP involves stray currents to unintended structures. The proper CP for a system is determined empirically and must resolve a number of factors to be effective (Peabody, "Control of Pipeline Corrosion," NACE International, Houston; Morgan, "Cathodic Protection," 2d ed., NACE International, Houston).

## CORROSION IN INDUSTRIAL AND UTILITY STEAM-GENERATING SYSTEMS

### Boiler Corrosion

Corrosion can be initiated from the fireside or the waterside of the surfaces in the boiler. In addition to corrosion, there are a number of other types of failure mechanisms for boiler components, including fatigue, erosion, overheating, manufacturing defects, and maintenance problems. Some of the actual failure mechanisms are combinations of mechanical and chemical mechanisms, such as corrosion fatigue and stress corrosion cracking (SCC). The identification, cause(s), and corrective action(s) for each type of failure mechanism are presented in

“The Boiler Tube Failure Metallurgical Guide,” vol. 1, Tech. Rep. TR-102433-V1, EPRI, Palo Alto, CA.

### Corrosion in Other Steam/Water Cycle Components

Corrosion in turbines, condensers, heat exchangers, tanks, and piping in the steam/water cycle can occur by general corrosion, pitting, crevice corrosion, intergranular corrosion, SCC, corrosion fatigue, erosion corrosion, dealloying (e.g., dezincification), or galvanic corrosion. A detailed (370-page) discussion of corrosion of steam/water cycle materials is presented in the ASME “Handbook on Water Technology for Thermal Power Systems,” chap. 9, ASME, New York.

### Control of Waterside Corrosion

To minimize corrosion associated with the watersides of the boiler and steam/water cycle components, a comprehensive chemistry program should be instituted. A wide variety of chemical treatment programs are utilized for these systems depending on the materials of construction, operating temperatures, pressures, heat fluxes, contaminant levels, and purity criteria for components using the steam.

General chemistry guidelines for feedwater, boiler water, and steam for industrial boilers are presented in “Consensus on Operating Practices for the Control of Feedwater and Boiler Water Chemistry in Modern Industrial Boilers,” ASME, New York. The limits in this reference are somewhat generic and do not indicate the details of a complete chemistry program. For electric utility boilers and fluidized-bed combustion boilers, more stringent and detailed chemistry guidelines are provided in “Interim Consensus Guidelines on Fossil Plant Cycle Chemistry,” CS-4629, EPRI, Palo Alto, CA, and “Guidelines on Cycle Chemistry for Fluidized-Bed Combustion Plants,” TR-102976, EPRI, Palo Alto. As indicated later in this section, subsequent publications detail updated versions of the treatment programs.

A good chemistry control program requires a high-purity makeup water to the steam/water cycle. For high-pressure electric utility boilers, two-stage demineralization (e.g., cation/anion/mixed-bed ion exchange) is generally utilized. Consult “Guidelines for Makeup Water Treatment,” GS-6699, EPRI, Palo Alto, for information on the design of makeup treatment systems. For industrial boilers, one- or two-stage demineralization or softening (sometimes with dealkalization) are utilized for makeup water treatment, depending on the boiler pressure. Unsoftened makeup water has been utilized in small, low-pressure [e.g., 15 lb/in<sup>2</sup> (gage) (100 kPa)] boiler systems which receive large amounts of condensate return, but this practice is not optimal.

In addition to providing a high-purity makeup water, condensate returns often require **purification** or **polishing**. Condensate polishing can be achieved with specially designed filters, softeners, or mixed-bed ion exchangers. Industrial boilers typically use softeners and/or filters (e.g., electromagnetic). Once-through boilers, full-flow mixed-bed polishers (preferred), or precoat (with crushed ion-exchange resin) filters are standard practice. Also, for high-pressure, drum-type boilers, mixed-bed condensate polishers are often used.

Minimizing the transport of corrosion products to the boiler is essential for corrosion control in the boiler. Corrosion products from the feedwater deposit on boiler tubes, inhibit cooling of tube surfaces, and can provide an evaporative-type concentration mechanism of dissolved salts under boiler tube deposits.

Except for oxygenated treatment (discussed later), feedwater treatment relies on raising the feedwater pH to 8.5 to 10 and eliminating dissolved oxygen. In this environment, the predominant oxide formed on steel is a mixed metal oxide composed primarily of magnetite (Fe<sub>3</sub>O<sub>4</sub>). The mixed oxide layer formed in deoxygenated solutions resists dissolution or erosion and thus minimizes iron transport to the boiler and corrosion of the underlying metal.

Oxygen removal is normally achieved through thermal deaeration followed by the addition of chemical oxygen scavengers. **Thermal deaerators** are direct-contact steam heaters which spray feedwater in fine droplets and strip the dissolved oxygen from the water with steam. Deaerators normally operate at pressures of 5 to 150 lb/in<sup>2</sup> (gage) (35 to 1.035 kPa), although a few deaerator designs maintain a vacuum.

A wide variety of **oxygen scavengers** are utilized. For boilers below 700 to 900 lb/in<sup>2</sup> (4.8 to 6.2 MPa), sodium sulfite (often catalyzed with cobalt) is commonly used although other nonvolatile (e.g., erythorbate) or volatile oxygen scavengers can be effective. A slight excess of sodium sulfite is applied to the feedwater, resulting in a residual of sulfite in the boiler water. The exact level of sulfite maintained depends primarily on the boiler pressure and oxygen concentrations in the feedwater, although other factors such as boiler water pH, steam and condensate purity, and feedwater temperatures are involved. Sodium sulfite should not be used in boilers operating above 900 lb/in<sup>2</sup> (gage) (6.2 MPa), because a significant amount of the sulfite decomposes to volatile sulfur species at elevated temperatures. These species are acidic and lower steam and condensate pH values, contributing to increased corrosion in steam/water cycle components. Sulfur species in steam may also contribute to SCC.

Commonly used volatile oxygen scavengers include hydrazine, carbonylhydrazide, hydroquinone, diethylhydroxylamine, and methylethylketoxime. These are normally applied to obtain a free residual of the scavenger in the feedwater at the economizer inlet to the boiler. Due to the slower reaction rates, routine dissolved-oxygen monitoring is more crucial for boilers using volatile oxygen scavengers than for boilers using sulfite. One benefit of some of the volatile oxygen scavengers listed is their ability to enhance metal passivation. Sulfite is an effective oxygen scavenger, but has little effect on passivation beyond the effect of oxygen removal.

Aqueous solutions of ammonia or volatile amines are usually applied to the feedwater to control feedwater, steam, and condensate pH. In all steel cycles, these pH levels are typically controlled at 9.2 to 9.6. In boiler systems containing both steel and copper alloys, pH levels in the feedwater, steam, and condensate are typically controlled from 8.5 to 9.2.

Amines utilized in steam/water cycles include cyclohexylamine, morpholine, ethanolamine, diethanolamine, diethylaminoethanol, dimethyl isopropanolamine, and methoxypropylamine, and the list is expanding. For large steam distribution systems, a blend of two to four amines with different distribution coefficients (ratio of amine in steam to condensate) is often applied to provide pH control throughout the steam and condensate system.

In addition to the **feedwater treatment** program, chemistry must be controlled in the boiler to minimize corrosion. Currently, the basic types of boiler treatment programs used in the United States are coordinated phosphate treatment, congruent phosphate treatment (CPT), equilibrium phosphate treatment (EPT), phosphate treatment with low-level caustic, caustic treatment, all-volatile treatment (AVT), and oxygenated treatment (OT). With the exception of oxygenated treatment, all these treatment programs are based on oxygen-free feedwater and the formation of a mixed metal oxide of predominantly magnetite (Fe<sub>3</sub>O<sub>4</sub>).

A wide variety of phosphate and caustic treatments are currently utilized in industrial and electric utility boilers. The treatments are designed to provide a reserve of alkalinity to minimize pH fluctuations. Caustic and acid concentrating underneath deposits in boiler tubing contributes to most types of waterside corrosion. It is generally desired to control the pH in a range which keeps the level of free caustic alkalinity and acidic constituents within acceptable values.

Research studies indicate the optimal boiler water treatment program varies considerably with boiler pressure (Tremaine et al., Phosphate Interactions with Metal Oxides under High-Performance Boiler Hideout Conditions, paper 35, International Water Conference, Pittsburgh, PA, 1993). Currently, there is not a consensus regarding optimal treatment programs. Phosphate treatment programs used by electric utility boilers are presented in the literature “Cycle Chemistry Guidelines for Fossil Plants: Phosphate Treatment for Drum Units,” TR-103665, EPRI, Palo Alto; “Sodium Hydroxide for Conditioning the Boiler Water of Drum-Type Boilers,” TR-104007, EPRI, Palo Alto).

AVT is an extension of the feedwater treatment program. Boiler water pH control is maintained by the portion of amines or ammonia from the feedwater which remains in the boiler water. Due to the low concentrations and poor buffering capacity of ammonia or amines in boiler water, strict purity limits are maintained on the feedwater and

boiler water. AVT is generally only utilized in high-pressure boilers (> 1,800 lb/in<sup>2</sup> (gauge) (12.4 kPa)) with condensate polishers, although some lower-pressure boilers [850 lb/in<sup>2</sup> (gauge) (5.9 kPa)] also utilize this treatment.

Although it was used for many years in Germany and Russia, OT was not utilized in the United States until the 1990s. It involves a completely different approach from the other treatment programs since it relies on the formation of a gamma ferric oxide (Fe<sub>2</sub>O<sub>3</sub>) or gamma ferric oxide hydrate (FeOOH) layer on the steel surfaces in the preboiler cycle.

Originally, oxygenated treatment was based on neutral pH values (7 to 8) and oxygen levels of 50 to 250 ppb in pure feedwater (cation conductivities < 0.15 μS/cm). Later, a program based on slightly alkaline pH values (8.0 to 8.5) and 30 to 150 ppb of dissolved oxygen was developed. This treatment program was originally referred to as **combined water treatment**, but it is now commonly referred to as **oxygenated treatment (OT)** in the United States. Its application is primarily limited to once-through boilers with all-steel steam/water cycles (if full-flow condensate polishing is provided, as recommended, copper alloys are permitted in the condensers). The primary benefit of OT appears to be minimization of deposit-induced pressure drop through the boiler during service. The reduction in iron oxide transport into and deposition in the boiler can also significantly reduce the frequency of chemical cleanings. The details of oxygenated treatment programs for once-through boilers are presented in "Cycle Chemistry Guidelines for Fossil Plants: Oxygenated Treatment," TR-102285, EPRI, Palo Alto. Although this document also presents guidance for utilizing OT for drum-type boilers, currently there is insufficient information to indicate whether this is an appropriate application of this treatment philosophy.

#### Control of Fireside Corrosion

Corrosive fuel constituents in coal or oil at appropriate metal temperatures may promote fireside corrosion in boiler tube steel. The corrosive ingredients can form liquids that solubilize the oxide film on tubing and react with the underlying metal to reduce the tube wall thickness. Coal ash or oil ash corrosion and waterwall fireside corrosion occur at different areas of the boiler and at different temperatures. Dew point corrosion may occur on the fireside surfaces of the economizer or on other low-temperature surfaces when condensation can form acidic products (Reid, "External Corrosion and Deposits—Boiler and Gas Turbine," American Elsevier, New York; Barna et al., "Fireside Corrosion Inspections of Black Liquor Recovery Boilers," 1993 Kraft Recovery Short Course Notes, TAPPI, Atlanta).

Fireside corrosion often can be mitigated by (1) material selection, (2) purchase of fuels with low impurity levels (limit levels of sulfur, chloride, sodium, vanadium, etc.), (3) purification of fuels (e.g., coal washing), (4) application of fuel additives (e.g., magnesium oxide), (5) adjustment of operating conditions (e.g., percent excess air, percent solids in recovery boilers), and (6) modification of lay-up practices (e.g., dehumidification systems).

#### CORROSION IN HEATING AND COOLING WATER SYSTEMS AND COOLING TOWERS

Control of corrosion in the waterside of cooling and heating water systems begins with proper preconditioning of the system, as covered in "Standard Recommended Practice: Initial Conditioning of Cooling Water Equipment," RP0182-85, NACE, Houston, 1985, and "Guidelines for Treatment of Galvanized Cooling Towers to Prevent White Rust," Cooling Tower Institute, Houston, 1994. Objectives of the subsequent cooling water treatment program are as follows:

- Prevent corrosion of metals in the system.
- Prevent the formation of scale (e.g., calcium carbonate, calcium sulfate, calcium phosphate).
- Minimize the amount and deposition of suspended solids.
- Minimize biological growths.

Substantial emphasis in a cooling tower treatment program is placed on preventing deposits of scale, suspended solids, or biological matter

from forming on system components ("Design and Operating Guidelines Manual for Cooling-Water Treatment," CS-2276, EPRI, Palo Alto, 1982; "Special Report: Cooling-Water Treatment for Control of Scaling, Fouling, Corrosion," Power, McGraw-Hill, New York, June 1984). The primary reason for this emphasis is to maintain the performance of the cooling system. However, minimizing deposition is integral to corrosion control to avoid problems with underdeposit corrosion or MIC attack. Also, suspended particles can lead to erosion of piping, particularly copper tubing.

Depending on the inherent corrosivity of the cooling water, corrosion control in open recirculating cooling water systems may consist merely of controlling the pH, conductivity, and alkalinity levels. However, in systems with extensive piping networks, applications of corrosion inhibitors are often utilized to protect materials in the system. These inhibitors can include the following compounds: zinc salts, molybdate salts, triazoles, orthophosphates, polyphosphates, phosphonates, and polysilicates. Often, two or more of these inhibitors are used together. Oxidizing or nonoxidizing biocides also are required in cooling tower systems to inhibit biological activity.

For closed cooling and heating water systems, corrosion inhibitors are usually applied and pH levels are controlled at 8 to 11. Corrosion inhibitors utilized in closed cooling and heating water systems include the inhibitors listed for open recirculating cooling water systems except for zinc salts. Also, nitrite salts are often used in closed water systems.

Corrosion control in closed cooling systems is greatly facilitated by minimizing water loss from the system. Makeup water introduced to replace leakage introduces oxygen, organic matter to support biological activity, and scale constituents. Utilization of pumps with mechanical seals (with filtered seal water) rather than packing seals can greatly reduce water losses from closed systems. Control of water leakage is probably the single most important operational factor in reducing corrosion in these systems.

In heating and cooling water systems, concerns regarding corrosion control generally focus on the waterside or interior of piping and components. However, substantial corrosion can occur on the exterior of these piping systems underneath insulation. External corrosion of piping generally requires a source of external moisture. In chill water and secondary water systems, moisture can be introduced through exposure to the air and subsequent condensation of moisture on the pipe surface.

While chill water piping systems generally are installed with vapor barriers, breaks in the vapor barrier can exist due to inadequate installation or subsequent maintenance activities. Secondary water system piping is sometimes not installed with vapor barriers because the cooling water temperature is designed to be above the expected dew point. However, humidity levels in the building can sometimes be elevated and can lead to condensation at higher temperatures than initially expected.

Leaks from piping at fittings or joints can saturate the insulation with moisture and can lead to corrosion. This type of moisture source can be particularly troublesome in hot water piping because the moisture can be evaporated to dryness and wet/dry corrosion can result. Corrosion rates during this transition from wetness to dryness can be many times higher than that of a fully wetted surface [Pollock and Steely (eds.), "Corrosion under Wet Thermal Insulation," NACE International, Houston]. If the moisture can be eliminated, corrosion underneath insulation should be negligible. However, if the moisture cannot be eliminated, coatings may need to be applied to the metal surface. Inhibitors are also available to mitigate corrosion underneath insulation.

#### CORROSION IN THE CHEMICAL PROCESS INDUSTRY

Corrosion control in the chemical process industry is important to provide continuous operation in order to meet production schedules and to maintain purity of manufactured products. Also, protection of personnel and the environment is of primary importance to the chemical process industry. Many of the chemicals utilized have high toxicity, and their release due to unexpected corrosion failures of piping and vessels is not permitted. Corrosion prevention and control in the chemical process

industry are largely focused on material selection. Nondestructive evaluation methods are routinely used to evaluate material integrity. (See Sec. 5.4.)

Due to the wide range of chemicals and operating conditions in the chemical process industry, the types of corrosion cannot be adequately addressed here. The following references address the corrosivity of the various environments and appropriate material selection and opera-

tional and maintenance practices: Moniz and Pollock, "Process Industries Corrosion," NACE, Houston. Degnan, "Corrosion in the Chemical Processing Industry," "Metals Handbook." Aller et al., "First International Symposium on Process Industry Piping," Materials Technology Institute, Houston. Dillon, "Corrosion Control in the Chemical Process Industries," McGraw-Hill, New York.

## 6.6 PAINTS AND PROTECTIVE COATINGS

by Harold M. Werner and Expanded by Staff

REFERENCES: Keane (ed.). "Good Painting Practice," Steel Structures Painting Council. Levinson and Spindel, "Recent Developments in Architectural and Maintenance Painting." Levinson, "Electrocoat, Powder Coat, Radiate." Reprints, *Journal of Coatings Technology*, 1315 Walnut St., Philadelphia. Roberts, "Organic Coatings—Their Properties, Selection and Use," Government Printing Office. "Paint/Coatings Dictionary," Federation of Societies for Coatings Technology. Weismantel (ed.), "Paint Handbook," McGraw-Hill. Publications of the National Paint and Coatings Association.

**Paint** is a mixture of filmogen (film-forming material, binder) and pigment. The pigment imparts color, and the filmogen, continuity; together, they create opacity. Most paints require volatile thinner to reduce their consistencies to a level suitable for application. An important exception is the powder paints made with fusible resin and pigment.

In **conventional oil-base paint**, the filmogen is a vegetable oil. Driers are added to shorten drying time. The thinner is usually petroleum spirits.

In **water-thinned paints**, the filmogen may be a material dispersible in water, such as solubilized linseed oil or casein, an emulsified polymer, such as butadiene-styrene or acrylate, a cementitious material, such as portland cement, or a soluble silicate.

**Varnish** is a blend of resin and drying oil, or other combination of filmogens, in volatile thinner. A solution of resin alone is a **spirit varnish**, e.g., shellac varnish. A blend of resin and drying oil is an **oleoresinous varnish**, e.g., spar varnish. A blend of nonresinous, nonoleaginous filmogens requiring a catalyst to promote the chemical reaction necessary to produce a solid film is a **catalytic coating**.

**Enamel** is paint that dries relatively harder, smoother, and glossier than the ordinary type. These changes come from the use of varnish or synthetic resins instead of oil as the liquid portion. The varnish may be oleoresinous, spirit, or catalytic.

**Lacquer** is a term that has been used to designate several types of painting materials; it now generally means a spirit varnish or enamel, based usually on cellulose nitrate or cellulose acetate butyrate, acrylate or vinyl.

### PAINT INGREDIENTS

The ingredients of paints are drying and semidrying vegetable oils, resins, plasticizers, thinners (solvents), driers or other catalysts, and pigments.

**Drying oils** dry (become solid) when exposed in thin films to air. The drying starts with a chemical reaction of the oil with oxygen. Subsequent or simultaneous polymerization completes the change. The most important drying oil is linseed oil. Addition of small percentages of driers shortens the drying time.

**Soybean oil**, with poorer drying properties than linseed oil, is classed as a **semidrying oil**. **Tung oil** dries much faster than linseed oil, but the film wrinkles so much that it is reminiscent of frost; heat treatment eliminates this tendency. Tung oil gels after a few minutes cooking at high temperatures. It is more resistant to alkali than linseed oil. Its chief

use is in oleoresinous varnishes. **Oiticica oil** resembles tung oil in many of its properties. **Castor oil** is nondrying, but heating chemically "dehydrates" it and converts it to a drying oil. The dehydrated oil resembles tung oil but is slower drying and less alkali-resistant. **Nondrying oils**, like coconut oil, are used in some baking enamels. An oxidizing hydrocarbon oil, made from petroleum, contains no esters or fatty acids.

The drying properties of oils are linked to the amount and nature of unsaturated compounds. By molecular distillation or solvent extraction the better drying portions of an oil can be separated. Drying is also improved by changing the structure of the unsaturated compounds (isomerization) and by modifying the oils with small amounts of such compounds as phthalic acid and maleic acid.

**Driers** are oil-soluble compounds of certain metals, mainly lead, manganese, and cobalt. They accelerate the drying of coatings made with oil. The metals are introduced into the coatings by addition of separately prepared compounds. Certain types of synthetic nonoil coatings (catalytic coatings) dry by baking or by the action of a **catalyst** other than conventional drier. Drier action begins only after the coating has been applied. Catalyst action usually begins immediately upon its addition to the coating; hence addition is delayed until the coating is about to be used.

**Resins** Both natural and synthetic resins are used. **Natural resins** include fossil types from trees now extinct, recent types (rosin, Manila, and dammar), lac (secretion of an insect), and asphalts (gilsonite). **Synthetic resins** include ester gum, phenolic, alkyd, urea, melamine, amide, epoxy, urethane, vinyl, styrene, rubber, petroleum, terpene, cellulose nitrate, cellulose acetate, and ethyl cellulose.

**Latex** filmogens contain a stable aqueous dispersion of synthetic resin produced by emulsion polymerization as the principal constituent.

**Plasticizers** In an oleoresinous varnish the oil acts as a softening agent or plasticizer for the resin. There are other natural compounds and substances, and many synthetic ones, for plasticizing film formers such as the cellulotics. Plasticizers include dibutyl phthalate, tricresyl phosphate, dibutyl sebacate, dibutyltartrate, tributyl citrate, methyl abietate, and chlorinated biphenyl.

**Thinners** As the consistency of the film-forming portion of most paints and varnishes is too high for easy application, thinners (**solvents**) are needed to reduce it. If the nonvolatile portion is already liquid, the term thinner is used; if solid, the term solvent is used. **Petroleum** or **mineral spirits** has replaced turpentine for thinning paints in the factory. The coal-tar products—**toluene**, **xylylene**, and **solvent naphtha**—are used where solvency better than that given by petroleum spirits is needed. Esters, alcohols, and ketones are standard for cellulosic or vinyl lacquers. Finally, water is used to thin latex paints, to be thinned at point of use.

**Pigments** may be natural or synthetic, organic or inorganic, opaque or nonopaque, white or colored, chemically active or inert. Factors entering into the selection of a pigment are color, opacity, particle size, compatibility with other ingredients, resistance to light, heat, alkali, and acid, and cost. The most important pigments are: **white**—zinc oxide,

leaded zinc oxide, titanium dioxide; **red**—iron oxides, red lead\* (for rust prevention rather than color), chrome orange, molybdate orange, toluidine red, para red; **yellow**—iron oxide, chrome yellow, zinc yellow (for rust prevention rather than color), Hansa; **green**—chrome green, chrome oxide; **blue**—iron, ultramarine, phthalocyanine; **extenders** (non-opaque), i.e., magnesium silicate, calcium silicate, calcium carbonate, barium sulfate, aluminum silicate.

**Miscellany** Paint contains many other ingredients, minor in amount but important in function, such as emulsifiers, antifoamers, leveling agents, and thickeners.

**Ecological Considerations** Many jurisdictions restrict the amounts of volatile organic compounds that may be discharged into the atmosphere during coating operations. Users should examine container labels for applicable conditions.

## PAINTS

**Aluminum paint** is a mixture of aluminum pigment and varnish, from 1 to 2 lb of pigment per gal of varnish. The aluminum is in the form of thin flakes. In the paint film, the flakes “leaf”; i.e., they overlap like leaves fallen from trees. Leafing gives aluminum paint its metallic appearance and its impermeability to moisture. Aluminum paint ranks high as a reflector of the sun’s radiation and as a retainer of heat in hot-air or hot-water pipes or tanks.

**Bituminous Paint** Hard asphalts, like gilsonite, cooked with drying oils, and soft asphalts and coal tar, cut back with thinner, may be used to protect metal and masonry wherever their black color is not objectionable.

**Chemical-Resistant Paint** Chemical resistance is obtained by use of resins such as vinyls, epoxies and urethanes. Vinyls are air-drying types. Epoxies are catalytically cured with acids or amino resins. The latter are two-component paints to be mixed just prior to use. Urethanes can be two-component also, or single-component paints that react with moisture in the air to cure.

**Emulsion paints** are emulsions in water of oil or resin base mixed with pigment. The **latex paints** (acrylic, butadiene-styrene, polyvinylacetate, etc.) belong to this class. Emulsion or latex paints are designed for both exterior and interior use.

**Strippable coatings** are intended to give temporary protection to articles during storage or shipment.

**Powder coatings** are 100 percent solids coatings applied as a dry powder mix of resin and pigment and subsequently formed into a film with heat. The solid resin binder melts upon heating, binds the pigment, and results in a pigment coating upon cooling. The powder is applied either by a electrostatic spray or by passing the heated object over a fluidized bed of powder with subsequent oven heating to provide a smooth continuous film.

**Marine Paint** Ocean-going steel ships require antifouling paint over the anticorrosive primer. Red lead or zinc yellow is used in the primer. **Antifouling** paints contain ingredients, such as cuprous oxide and mercuric oxide, that are toxic to barnacles and other marine organisms. During World War II, the U.S. Navy developed **hot plastic** ship-bottom paint. It is applied by spray gun in a relatively thick film and dries or sets as it cools. **Copper powder paint** is suitable for small wooden craft.

**Fire-Retardant Paint** Most paint films contain less combustible matter than does wood. To this extent, they are fire-retardant. In addition they cover splinters and fill in cracks. However, flames and intense heat will eventually ignite the wood, painted or not. The most that ordinary paint can do is to delay ignition. Special compositions fuse and give off flame-smothering fumes, or convert to spongy heat-insulating masses, when heated. The relatively thick film and low resistance to abrasion and cleaning make these coatings unsuited for general use as paint, unless conventional decorative paints are applied over them. However, steady improvement in paint properties is being made.

**Traffic paint** is quick-drying, so that traffic is inconvenienced as little as possible. Rough texture and absence of gloss increase visibility. Tiny

\* The use of lead pigment (red lead) is prohibited by law. (See discussion below under Painting Steel.)

glass beads may be added for greater night visibility. Catalytically cured resinous coating are also a recent development for fast-drying traffic paints.

**Heat-Reflecting Paint** Light colors reflect more of the sun’s radiation than do dark colors. White is somewhat better than aluminum, but under some conditions, aluminum may retain its reflecting power longer.

**Heat-Resistant Paint** **Silicone** paint is the most heat-resistant paint yet developed. Its first use was as an insulation varnish for electric motors, but types for other uses, such as on stoves and heaters, have been developed. Since it must be cured by baking, it is primarily a product finish.

**Fungicides** should be added to paint that is to be used in bakeries, breweries, sugar refineries, dairies, and other places where fungi flourish. Until ecological considerations forbade their use, mercury compounds were important fungicides. Their place has been filled by chlorinated phenols and other effective chemical compounds. Fungi-infected surfaces should be sterilized before they are painted. Scrub them with mild alkali; if infection is severe, add a disinfectant.

**Wood preservatives** of the paintable type are used extensively to treat wood windows, doors, and cabinets. They reduce rotting that may be promoted by water that enters at joints. They comprise solutions of compounds, such as chlorinated phenols, and copper and zinc naphthenates in petroleum thinner. Water repellants, such as paraffin wax, are sometimes added but may interfere with satisfactory painting.

Clear **water repellents** are treatments for masonry to prevent wetting by water. Older types are solutions of waxes, drying oils, or metallic soaps. Silicone solutions, recently developed, are superior, both in repelling water and in effect on appearance.

**Zinc-Rich Primer** Anticorrosive primers for iron and steel, incorporating zinc dust in a concentration sufficient to give electrical conductivity in the dried film, enable the zinc metal to corrode preferentially to the substrate, i.e., to give cathodic protection. The binders can be organic resins or inorganic silicates.

## Painting

**Exterior Architectural Painting** Surfaces must be clean and dry, except that wood to be painted with emulsion paint will tolerate a small amount of moisture and masonry to be painted with portland cement-base paint should be damp. Scrape or melt the resin from the knots in wood, or scrub it off with paint thinner or alcohol. As an extra precaution, seal the knots with shellac varnish, aluminum paint, or proprietary knot sealer. When painting wood for the first time, fill nail holes and cracks with putty, after the priming coat has dried. If the wood has been painted before, remove loose paint with a scraper, wire brush, or sandpaper. Prime all bare wood. In bad cases of cracking and scaling, remove all the paint by dry scraping or with paint and varnish remover or with a torch.

Paint on new wood should be from 4 to 5 mils (0.10 to 0.13 mm) thick. This usually requires three coats. A system consisting of nonpenetrating primer and special finish coat may permit the minimum to be reached with two coats. Repainting should be frequent enough to preserve a satisfactory thickness of the finish coat. Nonpenetrating primers stick on some types of wood better than regular house paint does.

**Interior Architectural Painting** Interior paints are used primarily for decoration, illumination, and sanitation. Enamels usually are used for kitchen and bathroom walls, where water resistance and easy cleaning are needed; semiglossy and flat types are used on walls and ceilings where it is desired to avoid glare. Wet plaster will eventually destroy oil-base paints. Fresh plaster must be allowed to dry out. Water from leaks and condensation must be kept away from aged plaster. Several coats of paint with low permeability to water vapor make an effective vapor barrier.

**Painting Concrete and Masonry** Moisture in concrete and masonry brings alkali to the surface where it can destroy oil paint. Allow 2 to 6 months for these materials to dry out before painting; a year or more, if they are massive. Emulsion or latex paints may be used on damp concrete or masonry if there is reason to expect the drying to continue.

Portland-cement paint, sometimes preferred for masonry, is especially suitable for first painting of porous surfaces such as cinder block. Before applying this paint, wet the surface so that capillarity will not extract the water from the paint. Scrubbing the paint into the surface with a stiff brush of vegetable fiber gives the best job, but good jobs are also obtained with usual brushes or by spraying. Keep the paint damp for 2 or 3 days so that it will set properly. Latex and vinyl paints are much used on concrete, because of their high resistance to alkali.

**Painting Steel** Preparation of steel for painting, type of paint, and condition of exposure are closely related. Methods of preparation, arranged in order of increasing thoroughness, include (1) removal of oil with solvent; (2) removal of dirt, loose rust, and loose mill scale with scraper or wire brush; (3) flame cleaning; (4) sandblasting; (5) pickling; (6) phosphating. Exposure environments, arranged in order of increasing severity, include (a) dry interiors, or arid regions; (b) rural or light industrial areas, normally dry; (c) frequently wet; (d) continuously wet; (e) corrosive chemical. Paint systems for condition (a) often consist of a single coat of low-cost paint. For other conditions, the systems comprise one or two coats of rust-inhibitive primer, such as a zinc-rich primer, and one or more finish coats, selected according to severity of conditions.

The primer contains one or more rust-inhibitive pigments, selected mainly from red lead (found mostly in existing painted surfaces), zinc yellow, and zinc dust. It may also contain zinc oxide, iron oxide, and extender pigments. Of equal importance is the binder, especially for the top coats. For above-water surfaces, linseed oil and alkyd varnish give good service; for underwater surfaces, other binders, like phenolic and vinyl resin, are better. Chemical-resistant binders include epoxy, synthetic rubber, chlorinated rubber, vinyl, urethanes, and neoprene.

Paint for structural steel is normally air-drying. Large percentages for factory-finished steel products are catalytic-cured, or are baked.

By virtue of the health problems associated with lead-based paint, this product has effectively been proscribed by law from further use. A problem arises in the matter of removal and repainting areas which have previously been coated with lead-based paints; this is particularly true in the case of steel structures such as bridges, towers, and the like.

Removal of leaded paints from such structures requires that extreme care be exercised in the removal of the paint, due diligence being paid to the protection of not only the personnel involved therein but also the general public and that, further, the collection and disposal of the hazardous waste be effectuated in accordance with prescribed practice. Reference to current applicable OSHA documents will provide guidance in this regard.

The removal of leaded paints can be accomplished by chipping, sand blasting, use of solvents (strippers), and so forth. In all cases, stringent precautions must be employed to collect all the residue of old paint as well as the removal medium. Alternatively, recourse may be had to topcoating the existing leaded paint, effectively sealing the surface of the old paint and relying on the topcoating medium to keep the leaded undercoat from flaking away. In this type of application, urethane coatings, among others, have proved suitable. While the topcoating procedure will alleviate current problems in containment of existing lead-painted surfaces, it is not likely that this procedure will prove to be the final solution. Ultimately, as with any painted surface, there will come a time when the leaded-paint subcoat can no longer be contained in situ and must be removed. It is expected that better and more economical procedures will evolve in the near future, so that the extant problems associated with removal of leaded paint will become more tractable. The AISI and AASHTO have collaborated in this regard and have issued a guide addressing these problems.

**Galvanized Iron** Allow new galvanized iron to weather for 6 months before painting. If there is not enough time, treat it with a proprietary etching solution. For the priming coat, without pretreatment, a paint containing a substantial amount of zinc dust or portland cement should be used. If the galvanizing has weathered, the usual primers for steel are also good.

**Painting Copper** The only preparation needed is washing off any grease and roughening the surface, if it is a polished one. Special

primers are not needed. Paint or varnish all copper to prevent corrosion products from staining the adjoining paint.

**Painting Aluminum** The surface must be clean and free from grease. Highly polished sheet should be etched with phosphoric acid or chromic acid. Zinc-yellow primers give the best protection against corrosion. The only preparation needed for interior aluminum is to have the surface clean; anticorrosive primers are not needed.

**Magnesium** and its alloys corrode readily, especially in marine atmospheres. Red-lead primers must not be used. For factory finishing, it is customary to chromate the metal and then apply a zinc-yellow primer.

**Water-Tank Interiors** Among the best paints for these are asphaltic compositions. For drinking-water tanks, select one that imparts no taste. Zinc-dust paints made with phenolic varnish are also good.

**Wood Products** Finishes may be lacquer or varnish, or their corresponding enamels. High-quality clear finishes may require many operations, such as sanding, staining, filling, sealing, and finishing. Furniture finishing is done mostly by spray. Small articles are often finished by tumbling; shapes like broom handles, by squeegeeing.

**Plastics** Carefully balanced formulations are necessary for satisfactory adhesion, to avoid crazing and to prevent migration of plasticizer.

**Paint Deterioration** Heavy dew, hot sun, and marine atmospheres shorten the life of paint. Industrial zones where the atmosphere is contaminated with hygroscopic and acidic substances make special attention to painting programs necessary. Dampness within masonry and plaster walls brings alkali to the surface where it can destroy oil-base paints. Interior paints on dry surfaces endure indefinitely; they need renewal to give new color schemes or when it becomes impractical to wash them. Dry temperate climates are favorable to long life of exterior paints.

**Application** Most industrial finishing is done with spray guns. In electrostatic spraying, the spray is charged and attracted to the grounded target. Overspray is largely eliminated. Other methods of application include dipping, electrocoating, flowing, tumbling, doctor blading, rolling, fluid bed, and screen stenciling.

An increasing proportion of maintenance painting is being done with spray and hand roller. The spray requires up to 25 percent more paint than the brush, but the advantage of speed is offsetting. The roller requires about the same amount of paint as the brush.

**Dry finishing** is done by flame-spraying powdered pigment-filmogen compositions or by immersing heated articles in a **fluid bed** of the powdered composition.

**Spreading Rates** When applied by brush, approximate spreading rates for paints on various surfaces are as shown in Table 6.6.1.

## OTHER PROTECTIVE AND DECORATIVE COATINGS

**Porcelain enamel** as applied to metal or clay products is a vitreous, inorganic coating which is set by firing. Enameling is done in several different ways, but the resulting surface qualities and properties are largely similar. The coating finds utility in imparting to the product a surface which is hard and scratch-resistant, possesses a remarkable resistance to general corrosion, and perhaps even has the constituents of the coating material tailored for the enamel to be resistant to specific working environments.

Frit is the basic unfired raw coating material, composed of silica, suitable fluxes, and admixtures to impart either opacity or color.

The surface to be enameled must be rendered extremely clean, after which a tightly adhering undercoat is applied. The surface is covered with powdered frit, and the product finally is fired and subsequently cooled. Despite its demonstrated advantageous properties, porcelain enamel has effectively zero tolerance for deformation, and it will craze or spall easily when mechanically distressed.

**Fused dry resin coatings** employing polymers as the active agent can be bonded to most metals, with the resin applied in a fluidized bed or by means of electrostatic deposition. The surface to be treated must be extremely clean. Resinous powders based on vinyl, epoxy, nylon, poly-

Table 6.6.1 Spreading Rates for Brushed Paints

Surface	Type	First coat		Second and third coats	
		ft <sup>2</sup> /gal	m <sup>2</sup> /L	ft <sup>2</sup> /gal	m <sup>2</sup> /L
Wood	Oil emulsion	400–500	10–12	500–600	12–15
Wood, primed	Emulsion	500–600	12–15	500–600	12–15
Structural steel	Oil	450–600	11–15	650–900	16–22
Sheet metal	Oil	500–600	12–15	550–650	13–16
Brick, concrete	Oil	200–300	5–7	400–500	10–12
Brick, concrete	Cement	100–125	2.5–3	125–175	3–4.5
Brick, concrete	Emulsion	200–300	5–7	400–500	10–12
Smooth plaster	Oil	550–650	13–16	550–650	13–16
Smooth plaster	Emulsion	400–500	10–12	500–600	12–15
Concrete floor	Enamel	400–500	10–12	550–650	13–16
Wood floor	Varnish	550–650	13–16	550–650	13–16

ethylene, and the like are used. Intermediate bonding agents may be required to foster a secure bond between the metal surface and the resin. After the resin is applied, the metal piece is heated to fuse the resin into a continuous coating. The tightly bonded coating imparts corrosion resistance and may serve decorative functions.

**Bonded phosphates** provide a corrosion-resistant surface coat to metals, principally steel. Usually, the phosphated surface layer exhibits a reduced coefficient of friction and for this reason can be applied to sheet steel to be deep-drawn, resulting in deeper draws per die pass. Passing the raw sheet metal through an acid phosphate bath results in the deposition of an insoluble crystalline phosphate on the surface.

**Hot dipping** permits the deposition of metal on a compatible substrate and serves a number of purposes, the primary ones being to impart corrosion resistance and to provide a base for further surface treatment, e.g., paint. In **hot dip galvanizing**, a ferrous base metal, usually in the form of sheet, casting, or fabricated assembly, is carefully cleaned and then passed through a bath of molten zinc. The surface coating is metallographically very complex, but the presence of zinc in the uppermost surface layer provides excellent corrosion resistance. In the event that the zinc coating is damaged, leaving the base metal exposed to corrosive media, galvanic action ensues and zinc will corrode preferentially to the base metal. This sacrificial behavior thereby protects the base metal. (See Secs. 6.4 and 6.5.)

Automotive requirements in recent years have fostered the use of galvanized sheet steel in the fabrication of many body components, often with the metal being galvanized on one side only.

Hardware and fittings exposed to salt water historically have been hot dip galvanized to attain maximum service life.

**Terne**, a lead coating applied to steel (hence, **terne sheet**), is applied by hot dipping. The sheet is cleaned and then passed through a bath of molten lead alloyed with a small percentage of tin. The product is widely applied for a variety of fabricated pieces and is employed architecturally when its dull, though lasting, finish is desired. It exhibits excellent corrosion resistance, is readily formed, and lends itself easily to being soldered.

**Lead-coated copper** is used largely as a substitute for pure copper when applied as an architectural specialty for roof flashing, valleys, and the like, especially when the design requires the suppression of green copper corrosion product (verdigris). Its corrosion resistance is effectively equivalent to that of pure lead. It is produced by dipping copper sheet into a bath of molten lead.

**Electroplating**, or **electrodeposition**, employs an electric current to coat one metal with another. The method can be extended to plastics, but requires that the plastic surface be rendered electrically conductive by some means. In the basic electroplating circuit, the workpiece is made the cathode (negative), the metal to be plated out is made the anode (positive), and both are immersed in an electrolytic bath containing salts of the metal to be plated out. The circuit is completed with the passage of a direct current, whence ions migrate from anode to cathode, where they lose their charge and deposit as metal on the cathode. (In essence,

the anode becomes sacrificial to the benefit of the cathode, which accretes the metal to be plated out.) Most commercial metals and some of the more exotic ones can be electroplated; they include, among others, cadmium, zinc, nickel, chromium, copper, gold, silver, tin, lead, rhodium, osmium, selenium, platinum, and germanium. This list is not exclusive; other metals may be pressed into use as design requirements arise from time to time.

Plating most often is used to render the workpiece more corrosion-resistant, but decorative features also are provided or enhanced thereby. On occasion, a soft base metal is plated with a harder metal to impart wear resistance; likewise, the resultant composite material may be designed to exhibit different and/or superior mechanical or other physical properties.

Electroplating implies the addition of metal to a substrate. Accordingly, the process lends itself naturally to buildup of worn surfaces on cutting and forming tools and the like. This buildup must be controlled because of its implications for the finished dimensions of the plated part.

The most familiar example we observe is the universal use of chromium plating on consumer goods and pieces of machinery. Gold plating and silver plating abound. Germanium is electroplated in the production of many solid-state electronic components. Brass, while not a pure metal, can be electroplated by means of a special-composition electrolyte.

Of particular concern in the current working environment is the proper handling and disposition of spent plating solutions. There are restrictions in this regard, and those people engaged in plating operations must exercise stringent precautions in the matter of their ultimate disposal.

Aluminum normally develops a natural thin surface film of aluminum oxide which acts to inhibit corrosion. In **anodizing**, this surface film is thickened by immersion in an electrolytic solution. The protection provided by the thicker layer of oxide is increased, and for many products, the oxide layer permits embellishment with the addition of a dye to impart a desired color. (See Sec. 6.4.)

**Vacuum deposition** of metal onto metallic or nonmetallic substrates provides special functional or decorative properties. Both the workpiece to be coated and the metal to be deposited are placed in an evacuated chamber, wherein the deposition metal is heated sufficiently to enable atom-size particles to depart from its surface and impinge upon the surface to be coated. The atomic scale of the operation permits deposition of layers less than 1  $\mu\text{m}$  thick; accordingly, it becomes economical to deposit expensive jewelry metals, e.g., gold and silver, on inexpensive substrates. Some major applications include production of highly reflective surfaces, extremely thin conductive surface layers for electronic components, and controlled buildup of deposited material on a workpiece.

A companion process, **sputtering**, operates in a slightly different fashion, but also finds major application in deposition of 1- $\mu\text{m}$  thicknesses on substrates. Other than for deposition of 1- $\mu\text{m}$  thicknesses on solid-

state components and circuitry, it enables deposition of hard metals on edges of cutting tools.

**Chemical vapor deposition (CVD)** is employed widely, but is noted here for its use to produce diamond vapors at ambient temperatures, which are deposited as continuous films from 1 to 1,000  $\mu\text{m}$  thick. The CVD diamond has a dense polycrystalline structure with discrete diamond grains, and in this form it is used to substitute for natural and artificial diamonds in abrasive tools.

## VARNISH

Oleoresinous varnishes are classed according to oil length, i.e., the number of gallons of oil per 100 lb of resin. Short oil varnishes contain up to 10 gal of oil per 100 lb of resin; medium, from 15 to 25 gal; long, over 30 gal.

**Floor varnish** is of medium length and is often made with modified phenolic resins, tung, and linseed oils. It should dry overnight to a tough hard film. Some floor varnishes are rather thin and penetrating so that they leave no surface film. They show scratches less than the orthodox type. Moisture-cured urethane or epoxy ester varnishes are more durable types.

**Spar varnish** is of long oil length, made usually with phenolic or modified-phenolic resins, tung or dehydrated castor oil, and linseed oil. Other spar varnishes are of the alkyl and urethane types. Spar varnishes dry to a medium-hard glossy film that is resistant to water, actinic rays of the sun, and moderate concentrations of chemicals.

**Chemical-resistant varnishes** are designed to withstand acid, alkali, and other chemicals. They are usually made of synthetic resins, such as chlorinated rubber, cyclized rubber, phenolic resin, melamine, urea-aldehyde, vinyl, urethane, and epoxy resin. Some of these must be dried by baking. Coal-tar epoxy and coal-tar urethane combinations are also used. **Catalytic varnish** is made with a nonoxidizing film former, and is cured with a catalyst, such as hydrochloric acid or certain amines.

**Flat varnish** is made by adding materials, such as finely divided silica or metallic soap, to glossy varnish. Synthetic latex or other emulsion, or aqueous dispersion, such as glue, is sometimes called **water varnish**.

## LACQUER

The word *lacquer* has been used for (1) spirit varnishes used especially for coating brass and other metals, (2) Japanese or Chinese lacquer, (3) coatings in which cellulose nitrate (**pyroxylin**), cellulose acetate, or cellulose acetate butyrate is the dominant ingredient, (4) oleoresinous baking varnishes for interior of food cans.

Present-day lacquer primarily refers to cellulosic coatings, clear or pigmented. These lacquers dry by evaporation. By proper choice of solvents, they are made to dry rapidly. Besides cellulosic compounds, they contain resins, plasticizers, and solvent. Cellulose acetate, cellulose acetate butyrate, and cellulose acetate propionate lacquers are non-flammable, and the clear forms have better exterior durability than the cellulose nitrate type. Although cellulosic and acrylic derivatives dominate the lacquer field, compositions containing vinyls, chlorinated hydrocarbons, or other synthetic thermoplastic polymers are of growing importance.

**Lac** is a resinous material secreted by an insect that lives on the sap of certain trees. Most of it comes from India. After removal of dirt, it is marketed in the form of grains, called seed-lac; cakes, called button lac; or flakes, called shellac. Lac contains up to 7 percent of wax, which is removed to make the refined grade. A bleached, or white, grade is also available.

**Shellac varnish** is made by "cutting" the resin in alcohol; the cut is designated by the pounds of lac per gallon of alcohol, generally 4 lb. Shellac varnish should always be used within 6 to 12 months of manufacture, as some of the lac combines with the alcohol to form a soft, sticky material.

## 6.7 WOOD

by Staff, Forest Products Laboratory, USDA Forest Service. Prepared under the direction of David W. Green.

(Note: This section was written and compiled by U.S. government employees on official time. It is, therefore, in the public domain and not subject to copyright.)

REFERENCES Freas and Selbo, Fabrication and Design of Glued Laminated Wood Structural Members, *U.S. Dept. Agr. Tech. Bull.* no. 1069, 1954. Hunt and Garratt, "Wood Preservation," McGraw-Hill. "Wood Handbook," *U.S. Dept. Agr. Handbook*. "Design Properties of Round, Sawn and Laminated Preservatively Treated Construction Poles as Posts," ASAE Eng. Practice EP 388.2, American Society of Agricultural Engineering Standards. AF&PA 1994, "National Design Specification for Wood Construction," American Forest & Paper Association, Washington, 1994. AITC, "Recommended Practice for Protection of Structural Glued Laminated Timber during Transit, Storage and Erection," AITC III, American Institute of Timber Construction, Englewood, CO, 1994. AITC, "Laminated Timber Design Guide," American Institute of Timber Construction, Englewood, CO, 1994. AITC, "Timber Construction Manual," Wiley, New York, 1994. ANSI, "American National Standards for Wood Products—Structural Glued Laminated Timber," ANSI/AITC A190.1-1992, American National Standards Institute, New York, 1992. ASTM, "Annual Book of Standards," vol. 04.09, "Wood," American Society for Testing and Materials, Philadelphia, PA, 1993: "Standard Terminology Relating to Wood," ASTM D9; "Standard Practice for Establishing Structural Grades and Related Allowable Properties for Visually Graded Dimension Lumber," ASTM D245; "Standard Definitions of Terms Relating to Veneer and Plywood," ASTM D1038; "Standard Nomenclature of Domestic Hardwoods and Softwoods," ASTM D1165; "Standard Practice for Establishing Allowable Properties for Visually Graded Dimension Lumber from In-Grade Tests of Full Size Specimens," ASTM D1990; "Standard Methods for Establishing Clear Wood Strength Values," ASTM D2555; "Standard Practice for Evaluating Allowable Properties of Grades of Structural Lumber," ASTM D2915; "Standard Test Methods for Mechanical Properties of Lumber and Wood Based Structural Material," ASTM D4761; "Standard Test Method for Surface

Burning Characteristics of Building Materials," ASTM E84; "Standard Test Methods for Fire Tests of Building Construction and Materials," ASTM E119. ASTM, "Annual Book of Standards," vol. 04.10, American Society for Testing and Materials, Philadelphia, PA, 1995: "Standard Method for Establishing Design Stresses for Round Timber Piles," ASTM D2899; "Standard Practice for Establishing Stress Grades for Structural Members Used in Log Buildings," ASTM D3957; "Standard Practice for Establishing Stresses for Structural Glued Laminated Timber," ASTM D3737; "Standard Specification for Evaluation of Structural Composite Lumber Products," ASTM D5456. AWP, "Book of Standards," American Wood Preserver's Association, Stubenville, MD, 1994. American Wood Systems, "Span tables for glulam timber." APA-EWS, Tacoma, WA, 1994. Cassens and Feist, Exterior Wood in the South—Selection, Applications, and Finishes, *Gen. Tech. Rep. FPL-GTR-69*, USDA Forest Service, Forest Products Laboratory, Madison, WI, 1991. Chudnoff, Tropical Timbers of the World, *Agric. Handb.* no. 607, 1984. Forest Products Laboratory, Wood Handbook: Wood as an Engineering Material, *Agric. Handb.*, no. 72, rev., 1987. Green, Moisture Content and the Shrinkage of Lumber, *Res. Pap. FPL-RP-489*, USDA Forest Service, Forest Products Laboratory, Madison, WI, 1989. Green and Kretschmann, Moisture Content and the Properties of Clear Southern Pine, *Res. Pap. FPL-RP-531*, USDA Forest Service, Forest Products Laboratory, Madison, WI, 1975. James, Dielectric Properties of Wood and Hardboard: Variation with Temperature, Frequency, Moisture Content, and Grain Orientation, *Res. Pap. FPL-RP-245*, USDA Forest Service, Forest Products Laboratory, Madison, WI, 1988. MacLean, Thermal Conductivity of Wood, *Heat. Piping Air Cond.*, **13**, no. 6, 1941, pp. 380–391. NFPA, "Design Values for Wood Construction: A Supplement to the



National Design Specifications.” National Forest Products Association, Washington, 1991. Ross and Pellerin, Nondestructive Testing for Assessing Wood Members in Structures: A Review, *Gen. Tech. Rep. FPL-GTR-70*, USDA Forest Service, Forest Products Laboratory, Madison, WI, 1994. TenWolde et al., “Thermal Properties of Wood and Wood Panel Products for Use in Buildings,” ORNL/Sub/87-21697/1, Oak Ridge National Laboratory, Oak Ridge, TN, 1988. Weatherwax and Stamm, The Coefficients of Thermal Expansion of Wood and Wood Products, *Trans. ASME*, **69**, no. 44, 1947, pp. 421–432. Wilkes, Thermo-Physical Properties Data Base Activities at Owens-Corning Fiberglas, in “Thermal Performance of the Exterior Envelopes of Buildings,” ASHRAE SP 28, American Society of Heating, Refrigerating, and Air-Conditioning Engineers, Atlanta, 1981.

**COMPOSITION, STRUCTURE, AND NOMENCLATURE**

by David W. Green

Wood is a naturally formed organic material consisting essentially of elongated tubular elements called **cells** arranged in a parallel manner for the most part. These cells vary in dimensions and wall thickness with position in the tree, age, conditions of growth, and kind of tree. The walls of the cells are formed principally of chain molecules of cellulose, polymerized from glucose residues and oriented as a partly crystalline material. These chains are aggregated in the cell wall at a variable angle, roughly parallel to the axis of the cell. The cells are cemented by an amorphous material called lignin. The complex structure of the gross wood approximates a rhombic system. The direction parallel to the grain and the axis of the stem is longitudinal (L), the two axes across the grain are radial (R) and tangential (T) with respect to the cylinder of the tree stem. This anisotropy and the molecular orientation account for the major differences in physical and mechanical properties with respect to direction which are present in wood.

**Natural variability** of any given physical measurement in wood approximates the normal probability curve. It is traceable to the differences in the growth of individual samples and at present cannot be controlled. For engineering purposes, statistical evaluation is employed for determination of safe working limits.

Lumber is classified as **hardwood**, which is produced by the broad-leaf trees (*angiosperms*), such as oak, maple, ash; and **softwood**, the product of coniferous trees (*gymnosperms*), such as pines, larch, spruce, hemlock. The terms “hard” and “soft” have no relation to actual hardness of the wood. **Sapwood** is the living wood of pale color on the outside of the stem. **Heartwood** is the inner core of physiologically inactive wood in a tree and is usually darker in color, somewhat heavier, due to infiltrated material, and more decay-resistant than the sapwood. Other terms relating to wood, veneer, and plywood are defined in ASTM D9, D1038 and the “Wood Handbook.”

**Standard nomenclature** of lumber is based on commercial practice which groups woods of similar technical qualities but separate botanical identities under a single name. For listings of domestic hardwoods and softwoods see ASTM D1165 and the “Wood Handbook.”

The **chemical composition** of woody cell walls is generally about 40 to 50 percent cellulose, 15 to 35 percent lignin, less than 1 percent mineral, 20 to 35 percent hemicellulose, and the remainder extractable matter of a variety of sorts. Softwoods and hardwoods have about the same cellulose content.

**PHYSICAL AND MECHANICAL PROPERTIES OF CLEAR WOOD**

by David Green, Robert White, Anton TenWolde, William Simpson, Joseph Murphy, and Robert Ross

**Moisture Relations**

Wood is a hygroscopic material which contains water in varying amounts, depending upon the relative humidity and temperature of the surrounding atmosphere. **Equilibrium conditions** are established as shown in Table 6.7.1. The standard reference condition for wood is **oven-dry weight**, which is determined by drying at 100 to 105°C until there is no significant change in weight.

**Moisture content** is the amount of water contained in the wood, usually expressed as a percentage of the mass of the oven-dry wood. Mois-

ture can exist in wood as **free water** in the cell cavities, as well as water **bound** chemically within the intermolecular regions of the cell wall. The moisture content at which cell walls are completely saturated but at which no water exists in the cell cavities is called the **fiber saturation point**. Below the fiber saturation point, the cell wall shrinks as moisture is removed, and the physical and mechanical properties begin to change as a function of moisture content. **Air-dry wood** has a moisture content of 12 to 15 percent. **Green wood** is wood with a moisture content above the fiber saturation point. The moisture content of green wood typically ranges from 40 to 250 percent.

**Dimensional Changes**

**Shrinkage** or **swelling** is a result of change in water content within the cell wall. Wood is dimensionally stable when the moisture content is above the fiber saturation point (about 28 percent for shrinkage estimates). Shrinkage is expressed as a percentage of the dimensional change based on the green wood size. Wood is an anisotropic material with respect to shrinkage. **Longitudinal shrinkage** (along the grain) ranges from 0.1 to 0.3 percent as the wood dries from green to oven-dry and is usually neglected. Wood shrinks most in the direction of the annual growth rings (**tangential shrinkage**) and about half as much across the rings (**radial shrinkage**). Average shrinkage values for a number of commercially important species are shown in Table 6.7.2. Shrinkage to any moisture condition can be estimated by assuming that the change is linear from green to oven-dry and that about half occurs in drying to 12 percent.

**Swelling in polar liquids other than water** is inversely related to the size of the molecule of the liquid. It has been shown that the tendency to hydrogen bonding on the dielectric constant is a close, direct indicator of the swelling power of water-free organic liquids. In general, the strength values for wood swollen in any polar liquid are similar when there is equal swelling of the wood.

**Swelling in aqueous solutions** of sulfuric and phosphoric acids, zinc chloride, and sodium hydroxide above pH 8 may be as much as 25 percent greater in the transverse direction than in water. The transverse swelling may be accompanied by longitudinal shrinkage up to 5 percent. The swelling reflects a chemical change in the cell walls, and the accompanying strength changes are related to the degradation of the cellulose.

**Dimensional stabilization of wood** cannot be completely attained. Two or three coats of varnish, enamel, or synthetic lacquer may be 50 to 85 percent efficient in preventing short-term dimensional changes. Metal foil embedded in multiple coats of varnish may be 90 to 95 percent efficient in short-term cycling. The best long-term stabilization results from internal bulking of the cell wall by the use of materials such as phenolic resins polymerized in situ or water solutions of polyethylene glycol (PEG) on green wood. The presence of the bulking agents alters the properties of the treated wood. Phenol increases electrical resistance, hardness, compression strength, weight, and decay resistance but lowers the impact strength. Polyethylene glycol maintains strength values at the green-wood level, reduces electric resistance, and can be finished only with polyurethane resins.

**Mechanical Properties**

Average **mechanical properties** determined from tests on clear, straight-grained wood at 12 percent moisture content are given in Table 6.7.2. Approximate standard deviation(s) can be estimated from the following equation:

$$s = CX$$

where *X* = average value for species

$$C = \begin{cases} 0.10 & \text{for specific gravity} \\ 0.22 & \text{for modulus of elasticity} \\ 0.16 & \text{for modulus of rupture} \\ 0.18 & \text{for maximum crushing strength parallel to grain} \\ 0.14 & \text{for compression strength perpendicular to grain} \\ 0.25 & \text{for tensile strength perpendicular to grain} \\ 0.25 & \text{for impact bending strength} \\ 0.10 & \text{for shear strength parallel to grain} \end{cases}$$

**Table 6.7.1 Moisture Content of Wood in Equilibrium with Stated Dry-Bulb Temperature and Relative Humidity**

Temperature (dry-bulb)		Moisture content, % at various relative-humidity levels																			
°F	(°C)	5	10	15	20	25	30	35	40	45	50	55	60	65	70	75	80	85	90	95	98
30	-1.3	1.4	2.6	3.7	4.6	5.5	6.3	7.1	7.9	8.7	9.5	10.4	11.3	12.4	13.5	14.9	16.5	18.5	21.0	24.3	26.9
40	4.2	1.4	2.6	3.7	4.6	5.5	6.3	7.1	7.9	8.7	9.5	10.4	11.3	12.3	13.5	14.9	16.5	18.5	21.0	24.3	26.9
50	9.8	1.4	2.6	3.6	4.6	5.5	6.3	7.1	7.9	8.7	9.5	10.3	11.2	12.3	13.4	14.8	16.4	18.4	20.9	24.3	26.9
60	15	1.3	2.5	3.6	4.6	5.4	6.2	7.0	7.8	8.6	9.4	10.2	11.1	12.1	13.3	14.6	16.2	18.2	20.7	24.1	26.8
70	21	1.3	2.5	3.5	4.5	5.4	6.2	6.9	7.7	8.5	9.2	10.1	11.0	12.0	13.1	14.4	16.0	17.9	20.5	23.9	26.6
80	26	1.3	2.4	3.5	4.4	5.3	6.1	6.8	7.6	8.3	9.1	9.9	10.8	11.7	12.9	14.2	15.7	17.7	20.2	23.6	26.3
90	32	1.2	2.3	3.4	4.3	5.1	5.9	6.7	7.4	8.1	8.9	9.7	10.5	11.5	12.6	13.9	15.4	17.3	19.8	23.3	26.0
100	38	1.2	2.3	3.3	4.2	5.0	5.8	6.5	7.2	7.9	8.7	9.5	10.3	11.2	12.3	13.6	15.1	17.0	19.5	22.9	25.6
110	43	1.1	2.2	3.2	4.0	4.9	5.6	6.3	7.0	7.7	8.4	9.2	10.0	11.0	12.0	13.2	14.7	16.6	19.1	22.4	25.2
120	49	1.1	2.1	3.0	3.9	4.7	5.4	6.1	6.8	7.5	8.2	8.9	9.7	10.6	11.7	12.9	14.4	16.2	18.6	22.0	24.7
130	54	1.0	2.0	2.9	3.7	4.5	5.2	5.9	6.6	7.2	7.9	8.7	9.4	10.3	11.3	12.5	14.0	15.8	18.2	21.5	24.2
140	60	0.9	1.9	2.8	3.6	4.3	5.0	5.7	6.3	7.0	7.7	8.4	9.1	10.0	11.0	12.1	13.6	15.3	17.7	21.0	23.7
150	65	0.9	1.8	2.6	3.4	4.1	4.8	5.5	6.1	6.7	7.4	8.1	8.8	9.7	10.6	11.8	13.1	14.9	17.2	20.4	23.1
160	71	0.8	1.6	2.4	3.2	3.9	4.6	5.2	5.8	6.4	7.1	7.8	8.5	9.3	10.3	11.4	12.7	14.4	16.7	19.9	22.5
170	76	0.7	1.5	2.3	3.0	3.7	4.3	4.9	5.6	6.2	6.8	7.4	8.2	9.0	9.9	11.0	12.3	14.0	16.2	19.3	21.9
180	81	0.7	1.4	2.1	2.8	3.5	4.1	4.7	5.3	5.9	6.5	7.1	7.8	8.6	9.5	10.5	11.8	13.5	15.7	18.7	21.3
190	88	0.6	1.3	1.9	2.6	3.2	3.8	4.4	5.0	5.5	6.1	6.8	7.5	8.2	9.1	10.1	11.4	13.0	15.1	18.1	20.7
200	93	0.5	1.1	1.7	2.4	3.0	3.5	4.1	4.6	5.2	5.8	6.4	7.1	7.8	8.7	9.7	10.9	12.5	14.6	17.5	20.0
210	99	0.5	1.0	1.6	2.1	2.7	3.2	3.8	4.3	4.9	5.4	6.0	6.7	7.4	8.3	9.2	10.4	12.0	14.0	16.9	19.3
220	104	0.4	0.9	1.4	1.9	2.4	2.9	3.4	3.9	4.5	5.0	5.6	6.3	7.0	7.8	8.8	9.9	*	*	*	*
230	110	0.3	0.8	1.2	1.6	2.1	2.6	3.1	3.6	4.2	4.7	5.3	6.0	6.7	*	*	*	*	*	*	*
240	115	0.3	0.6	0.9	1.3	1.7	2.1	2.6	3.1	3.5	4.1	4.6	*	*	*	*	*	*	*	*	*
250	121	0.2	0.4	0.7	1.0	1.3	1.7	2.1	2.5	2.9	*	*	*	*	*	*	*	*	*	*	*
260	126	0.2	0.3	0.5	0.7	0.9	1.1	1.4	*	*	*	*	*	*	*	*	*	*	*	*	*
270	132	0.1	0.1	0.2	0.3	0.4	0.4	*	*	*	*	*	*	*	*	*	*	*	*	*	*

\* Conditions not possible at atmospheric pressure.

SOURCE: "Wood Handbook," Forest Products Laboratory, 1987.

**Table 6.7.2 Strength and Related Properties of Wood at 12% Moisture Content (Average Values from Tests on Clear Pieces 2 × 2 inches in Cross Section per ASTM D143)**

Kind of wood	Specific gravity, oven-dry volume	Density at 12% m.c. lb./ft. <sup>3</sup>	Shrinkage, % from green to oven-dry condition based on dimension when green		Static bending		Max crushing strength parallel to grain, lb./in. <sup>2</sup>	Compression perpendicular to grain at proportional limit, lb./in. <sup>2</sup>	Tensile strength perpendicular to grain, lb./in. <sup>2</sup> <sup>†</sup>	Impact bending, height of drop in inches for failure with 50-lb hammer	Shear strength parallel to grain, lb./in. <sup>2</sup>	Hardness perpendicular to grain, avg of <i>R</i> and <i>T</i>
			Rad.	Tan.	Modulus of rupture, lb./in. <sup>2</sup>	Modulus of elasticity, ksi						
<b>Hardwoods</b>												
Ash, white	0.60	42	4.9	7.8	15,400	1,740	7,410	1,160	940	43	1,910	1,320
Basswood	0.37	26	6.6	9.3	8,700	1,460	4,730	370	350	16	990	410
Beech	0.64	45	5.5	11.9	14,900	1,720	7,300	1,010	1,010	41	2,010	1,300
Birch, yellow	0.62	43	7.3	9.5	16,600	2,010	8,170	970	920	55	1,880	1,260
Cherry, black	0.50	35	3.7	7.1	12,300	1,490	7,110	690	560	29	1,700	950
Cottonwood, eastern	0.40	28	3.9	9.2	8,500	1,370	4,910	380	580	20	930	430
Elm, American	0.50	35	4.2	9.5	11,800	1,340	5,520	690	660	39	1,510	830
Elm, rock	0.63	44	4.8	8.1	14,800	1,540	7,050	1,230		56	1,920	1,320
Sweetgum	0.52	36	5.4	10.2	12,500	1,640	6,320	620	760	32	1,600	850
Hickory, shagbark	0.72	50	7.0	10.5	20,200	2,160	9,210	1,760		67	2,430	
Maple, sugar	0.63	44	4.8	9.9	15,800	1,830	7,830	1,470		39	2,330	1,450
Oak, red, northern	0.63	44	4.0	8.6	14,300	1,820	6,760	1,010	800	43	1,780	1,290
Oak, white	0.60	48	5.6	10.5	15,200	1,780	7,440	1,070	800	37	2,000	1,360
Poplar, yellow	0.42	29	4.6	8.2	10,100	1,580	5,540	500	540	24	1,190	540
Tupelo, black	0.50	35	4.2	7.6	9,600	1,200	5,520	930	500	22	1,340	810
Walnut, black	0.35	38	5.5	7.8	14,600	1,680	7,580	1,010	690	34	1,370	1,010
<b>Softwoods</b>												
Cedar, western red	0.32	23	2.4	5.0	7,500	1,110	4,560	460	220	17	990	350
Cypress, bald	0.46	32	3.8	6.2	10,600	1,440	6,360	730	300	24	1,900	510
Douglas-fir, coast	0.48	34	4.8	7.6	12,400	1,950	7,230	800	340	31	1,130	710
Hemlock, eastern	0.40	28	3.0	6.8	8,900	1,200	5,410	650		21	1,060	500
Hemlock, western	0.45	29	4.2	7.8	11,300	1,630	7,200	550	340	26	1,290	540
Larch, western	0.52	38	4.5	9.1	13,000	1,870	7,620	930	430	35	1,360	830
Pine, red	0.46	31	3.8	7.2	11,000	1,630	6,070	600	460	26	1,210	560
Pine, ponderosa	0.40	28	3.9	6.2	9,400	1,290	5,320	580	420	19	1,130	460
Pine, eastern white	0.35	24	2.1	6.1	8,600	1,240	4,800	440	310	18	900	380
Pine, western white	0.38	27	4.1	7.4	9,700	1,460	5,040	470		23	1,040	420
Pine, shortleaf	0.51	36	4.6	7.7	13,100	1,750	7,270	820	470	33	1,390	690
Redwood	0.40	28	2.6	4.4	10,000	1,340	6,150	700	240	19	940	480
Spruce, sitka	0.40	28	4.3	7.5	10,200	1,570	5,610	580	370	25	1,150	510
Spruce, black	0.42	29	4.1	6.8	10,800	1,610	5,960	550		20	1,230	520

SOURCE: Tabulated from "Wood Handbook," *Tropical Woods* no. 95, and unpublished data from the USDA Forest Service, Forest Products Laboratory.

Relatively few data are available on tensile strength parallel to the grain. The modulus of rupture is considered to be a conservative estimate for tensile strength.

Mechanical properties remain constant as long as the moisture content is above the fiber saturation point. Below the fiber saturation point, properties generally increase with decreasing moisture content down to about 8 percent. Below about 8 percent moisture content, some properties, principally tensile strength parallel to the grain and shear strength, may decrease with further drying. An approximate adjustment for clear wood properties between about 8 percent moisture and green can be obtained by using an annual compound-interest type of formula:

$$P_2 = P_1 \left( 1 + \frac{C}{100} \right)^{-(M_2 - M_1)}$$

where  $P_1$  is the known property at moisture content  $M_1$ ,  $P_2$  is the property to be calculated at moisture content  $M_2$ , and  $C$  is the assumed percentage change in property per percentage change in moisture content. Values of  $P_1$  at 12 percent moisture content are given in Table 6.7.2, and values of  $C$  are given in Table 6.7.3. For the purposes of property adjustment, green is assumed to be 23 percent moisture content. The formula should not be used with redwood and cedars. A more accurate adjustment formula is given in "Wood Handbook." Additional data and tests on green wood can be found in the "Wood Handbook." Data on foreign species are given in "Tropical Timbers of the World."

### Specific Gravity and Density

**Specific gravity**  $G_m$  of wood at a given moisture condition,  $m$ , is the ratio of the weight of the oven-dry wood  $W_o$  to the weight of water displaced by the sample at the given moisture condition  $w_m$ .

$$G_m = W_o/w_m$$

This definition is required because volume and weight are constant only under special conditions. The **weight density of wood**  $D$  (unit weight) at any given moisture content is the weight of oven-dry wood and the contained water divided by the volume of the piece at that same moisture content. Average values for specific gravity oven-dry and weight density at 12 percent moisture content are given in Table 6.7.2. Specific gravity of solid, dry wood substance based on helium displacement is 1.46, or about 91 lb/ft<sup>3</sup>.

**Conversion of weight density** from one moisture condition to another can be accomplished by the following equation ("Standard Handbook for Mechanical Engineers," 9th ed., McGraw-Hill).

$$D_2 = D_1 \frac{100 + M_2}{100 + M_1 + 0.0135 D_1(M_2 - M_1)}$$

$D_1$  is the weight density, lb/ft<sup>3</sup>, which is known for some moisture condition  $M_1$ .  $D_2$  is desired weight density at a moisture content  $M_2$ . Moisture contents  $M_1$  and  $M_2$  are expressed in percent.

**Specific gravity and strength properties** vary directly in an exponential relationship  $S = KG^n$ . Table 6.7.3 gives values of  $K$  and the exponent  $n$  for various strength properties. The equation is based on more than 160 kinds of wood and yields estimated average values for wood in general. This relationship is the best general index to the quality of defect-free wood.

### Load Direction and Relation to Grain of Wood

All strength properties vary with the orthotropic axes of the wood in a manner which is approximated by the **Hankinson's formula** ("Wood Handbook"):

$$N = \frac{PQ}{P \sin^2 \theta + Q \cos^2 \theta}$$

where  $N$  = allowable stress induced by a load acting at an angle to the grain direction, lb/in<sup>2</sup>;  $P$  = allowable stress parallel to the grain, lb/in<sup>2</sup>;  $Q$  = allowable stress perpendicular to the grain, lb/in<sup>2</sup>; and  $\theta$  = angle between direction of load and direction of grain.

The deviation of the grain from the long axis of the member to which the load is applied is known as the **slope of grain** and is determined by measuring the length of run in inches along the axis for a 1-in deviation of the grain from the axis. The effect of grain slope on the important strength properties is shown by Table 6.7.4.

### Rheological Properties

Wood exhibits viscoelastic characteristics. When first loaded, a wood member deforms elastically. If the load is maintained, additional time-dependent deformation occurs. Because of this time-dependent relation, the rate of loading is an important factor to consider in the testing and use of wood. For example, the load required to produce failure in 1 s is approximately 10 percent higher than that obtained in a standard 5-min strength test. Impact and dynamic measures of elasticity of small specimens are about 10 percent higher than those for static measures. Impact strengths are also affected by this relationship. In the impact bending test, a 50-lb (23-kg) hammer is dropped upon a beam from increasing heights until complete rupture occurs. The maximum height, as shown in Table 6.7.2, is for comparative purposes only.

When solid material is strained, some mechanical energy is dissipated as heat. **Internal friction** is the term used to denote the mechanism that causes this energy dissipation. The internal friction of wood is a complex function of temperature and moisture content. The value of internal friction, expressed by logarithmic decrement, ranges from 0.1 for hot, moist wood to less than 0.02 for hot, dry wood. Cool wood, regardless of moisture content, has an intermediate value.

The term **fatigue** in engineering is defined as progressive damage that occurs in a material subjected to cyclic loading. **Fatigue life** is a term used to define the number of cycles sustained before failure. Researchers at the Forest Products Laboratory of the USDA Forest Service have found that small cantilever bending specimens subjected to fully reversed stresses, at 30 Hz with maximum stress equal to 30 percent of

**Table 6.7.3 Functions Relating Mechanical Properties to Specific Gravity and Moisture Content of Clear, Straight-Grained Wood**

Property	Specific gravity–strength relation*				Change for 1% change in moisture content, %
	Green wood		Wood at 12% moisture content		
	Softwood	Hardwood	Softwood	Hardwood	
Static bending					
Modulus of elasticity (10 <sup>6</sup> lb/in <sup>2</sup> )	2,331 $G^{0.76}$	2,02 $G^{0.72}$	2,966 $G^{0.84}$	2,39 $G^{0.70}$	2.0
Modulus of rupture (lb/in <sup>2</sup> )	15,889 $G^{1.01}$	17,209 $G^{1.16}$	24,763 $G^{1.01}$	24,850 $G^{1.13}$	5
Maximum crushing strength parallel to grain (lb/in <sup>2</sup> )	7,207 $G^{0.94}$	7,111 $G^{1.11}$	13,592 $G^{0.97}$	11,033 $G^{0.89}$	6.5
Shear parallel to grain (lb/in <sup>2</sup> )	1,585 $G^{0.73}$	2,576 $G^{1.24}$	2,414 $G^{0.85}$	3,174 $G^{1.13}$	4.0
Compression perpendicular to grain at proportional limit (lb/in <sup>2</sup> )	1,360 $G^{1.60}$	2,678 $G^{2.48}$	2,393 $G^{1.57}$	3,128 $G^{2.09}$	6.5
Hardness perpendicular to grain (lb)	1,399 $G^{1.41}$	3,721 $G^{2.31}$	1,931 $G^{1.50}$	3,438 $G^{2.10}$	3.0

\* The properties and values should be read as equations; e.g., modulus of rupture for green wood of softwoods = 15,889 $G^{1.01}$ , where  $G$  represents the specific gravity of wood, based on the oven-dry weight and the volume at the moisture condition indicated.

**Table 6.7.4 Strength of Wood Members with Various Grain Slopes as Percentages of Straight-Grained Members**

Maximum slope of grain in member	Static bending		Impact bending; drop height to failure (50-lb hammer), %	Maximum crushing strength parallel to grain, %
	Modulus of rupture, %	Modulus of elasticity, %		
Straight-grained	100	100	100	100
1 in 25	96	97	95	100
1 in 20	93	96	90	100
1 in 15	89	94	81	100
1 in 10	81	89	62	99
1 in 5	55	67	36	93

SOURCE: "Wood Handbook."

estimated static strength and at 12 percent moisture content and 75°F (24°C), have a fatigue life of approximately 30 million cycles.

### Thermal Properties

The coefficients of thermal expansion in wood vary with the structural axes. According to Weatherwax and Stamm (*Trans. ASME*, **69**, 1947, p. 421), the longitudinal coefficient for the temperature range + 50°C to - 50°C averages  $3.39 \times 10^{-6}/^{\circ}\text{C}$  and is independent of specific gravity. Across the grain, for an average specific gravity oven-dry of 0.46, the radial coefficient  $\alpha_r$  is  $25.7 \times 10^{-6}/^{\circ}\text{C}$  and the tangential  $\alpha_t$  is  $34.8 \times 10^{-6}/^{\circ}\text{C}$ . Both  $\alpha_r$  and  $\alpha_t$  vary with specific gravity approximately to the first power. Thermal expansions are usually overshadowed by the larger dimensional changes due to moisture.

**Thermal conductivity of wood** varies principally with the direction of heat with respect to the grain. **Approximate transverse conductivity** can be calculated with a linear equation of the form

$$k = G(B + CM) + A$$

where  $G$  is specific gravity, based on oven-dry weight and volume at a given moisture content  $M$  percent. For specific gravities above 0.3, temperatures around 75°F (24°C), and moisture contents below 25 percent, the values of constants,  $A$ ,  $B$ , and  $C$  are  $A = 0.129$ ,  $B = 1.34$ , and  $C = 0.028$  in English units, with  $k$  in  $\text{Btu} \cdot \text{in}/(\text{h} \cdot \text{ft}^2 \cdot ^{\circ}\text{F})$  (TenWolde et al., 1988). Conductivity in watts per meter per kelvin is obtained by multiplying the result by 0.144. The effect of temperature on thermal conductivity is relatively minor and increases about 1 to 2 percent per 10°F (2 to 3 percent per 10°C). **Longitudinal conductivity** is considerably greater than transverse conductivity, but reported values vary widely. It has been reported as 1.5 to 2.8 times larger than transverse conductivity, with an average of about 1.8.

**Specific heat of wood** is virtually independent of specific gravity and varies principally with temperature and moisture content. Wilkes found that the approximate specific heat of dry wood can be calculated with

$$c_{p0} = a_0 + a_1 T$$

where  $a_0 = 0.26$  and  $a_1 = 0.000513$  for English units (specific heat in Btu per pound per degree Fahrenheit and temperature in degrees Fahrenheit) or  $a_0 = 0.103$  and  $a_1 = 0.00387$  for SI units [specific heat in  $\text{kJ}/(\text{kg} \cdot \text{K})$  and temperature in kelvins]. The specific heat of moist wood can be derived from

$$c_p = \frac{c_{p0} + 0.01M c_{p,w}}{1 + 0.01M} + A$$

where  $c_{p,w}$  is the specific heat of water [1 Btu/lb · °F), or 4.186 kJ/(kg · K),  $M$  is the moisture content (percent), and  $A$  is a correction factor, given by

$$A = M(b_1 + b_2 T + b_3 M)$$

with  $b_1 = -4.23 \times 10^{-4}$ ,  $b_2 = 3.12 \times 10^{-5}$ , and  $b_3 = -3.17 \times 10^{-5}$  in English units, and  $b_1 = -0.06191$ ,  $b_2 = 2.36 \times 10^{-4}$ , and  $b_3 =$

$-1.33 \times 10^{-4}$  in SI units. These formulas are valid for wood below fiber saturation at temperatures between 45°F (7°C) and 297°F (147°C).  $T$  is the temperature at which  $c_{p0}$  is desired.

The **fuel value** of wood depends primarily upon its dry density, moisture content, and chemical composition. Moisture in wood decreases the fuel value as a result of latent heat absorption of water vaporization. An approximate relation for the fuel value of moist wood (Btu per pound on wet weight basis)(2,326 Btu/lb = 1 J/kg) is

$$H_w = H_D \left( \frac{100 - u/7}{100 + u} \right)$$

where  $H_D$  is higher fuel value of dry wood, averaging 8,500 Btu/lb for hardwoods and 9,000 Btu/lb for conifers, and  $u$  is the moisture content in percent. The actual fuel value of moist wood in a furnace will be less since water vapor interferes with the combustion process and prevents the combustion of pyrolytic gases. (See Sec. 7 for fuel values and Sec. 4 for combustion.)

Wood undergoes thermal degradation to volatile gases and char when it is exposed to elevated temperature. When wood is directly exposed to the standard fire exposure of ASTM E 199, the **char rate** is generally considered to be 1½ in/h (38 mm/h). The temperature at the base of the char layer is approximately 550°F (300°C). Among other factors, the ignition of wood depends on the intensity and duration of exposure to elevated temperatures. Typical values for rapid ignition are 570 to 750°F (300 to 400°C). In terms of heat flux, a surface exposure to 1.1 Btu/ft² (13 kW/m²) per second is considered sufficient to obtain piloted ignition. Recommended "maximum safe working temperatures" for wood exposed for prolonged periods range from 150 to 212°F (65 to 100°C). **Flame spread** values as determined by ASTM E 84 generally range from 65 to 200 for nominal 1-in- (25-mm-) thick lumber. Flame spread can be reduced by impregnating the wood with fire-retardant chemicals or applying a fire-retardant coating.

The **reversible effect of temperature on the properties of wood** is a function of the change in temperature, moisture content of the wood, duration of heating, and property being considered. In general, the mechanical properties of wood decrease when the wood is heated above normal temperatures and increase when it is cooled. The magnitude of the change is greater for green wood than for dry. When wood is frozen, the change in property is reversible; i.e., the property will return to the value at the initial temperature. At a constant moisture content and below about 150°F (65°C), mechanical properties are approximately linearly related to temperature. The change in property is also reversible if the wood is heated for a short time at temperatures below about 150°F. Table 6.7.5 lists the changes in properties at - 58°F (- 50°C) and 122°F (50°C) relative to those at 68°F (20°C).

**Permanent loss** in properties occurs when wood is exposed to higher temperatures for prolonged periods and then is cooled and tested at normal temperatures. If the wood is tested at a higher temperature after prolonged exposure, the actual strength loss is the sum of the reversible and permanent losses in properties. Permanent losses are higher for

**Table 6.7.5 Approximate Middle-Trend Effects of Temperature on Mechanical Properties of Clear Wood at Various Moisture Conditions**

Property	Moisture condition	Relative change in mechanical property from 68°F, %	
		At - 58°F	At + 122°F
Modulus of elasticity parallel to grain	0	+ 11	- 6
	12	+ 17	- 7
	> FSP*	+ 50	—
Modulus of rupture	≤ 4	+ 18	- 10
	11-15	+ 35	- 20
	18-20	+ 60	- 25
	> FSP*	+ 110	- 25
Tensile strength parallel to grain	0-12	—	- 4
Compressive strength parallel to grain	0	+ 20	- 10
	12-45	+ 50	- 25
Shear strength parallel to grain	> FSP*	—	- 25
Compressive strength perpendicular to grain at proportional limit	0-6	—	- 20
	≥ 10	—	- 35

\* Moisture content higher than the fiber saturation point (FSP).  
 $T_c = (T_F - 32) 0.55$ .

heating in steam than in water, and higher when heated in water than when heated in air. Repeated exposure to elevated temperatures is assumed to have a cumulative effect on wood properties. For example, at a given temperature the property loss will be about the same after six exposures of 1-year duration as it would be after a single exposure of 6 years. Figure 6.7.1 illustrates the effect of heating at 150°F (65°C) at 12 percent moisture content on the modulus of rupture relative to the strength at normal temperatures for two grades of spruce-pine-fir and clear southern pine. Over the 3-year period, there was little or no change in the modulus of elasticity.

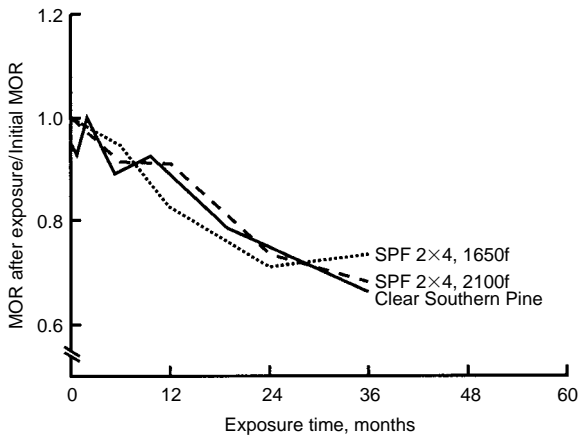

**Fig. 6.7.1** Permanent loss in bending strength at 12 percent moisture content. Specimens exposed at 150°F (65°C) and tested at 68°F (20°C). SPF = spruce/pine/fir.

#### Electrical Properties

The important electrical properties of wood are **conductivity** (or **resistivity**), **dielectric constant**, and **dielectric power factor** (see James, 1988).

**Resistivity** approximately doubles for each 10°C decrease in temperature. As moisture content increases from zero to the fiber saturation point (FSP), the resistivity decreases by  $10^{10}$  to  $10^{13}$  times in an approximately linear relationship between the logarithm of each. The resistivity is about  $10^{14}$  to  $10^{16} \Omega \cdot \text{m}$  for oven-dry wood and  $10^3$  to  $10^4 \Omega \cdot \text{m}$  for wood at FSP. As the moisture content increases up to complete saturation, the decrease in resistivity is a factor of only about 50. Wood species also affect resistivity (see James), and the resistivity perpendicular to the grain is about twice that parallel to the grain. Water-soluble

salts (some preservatives and fire-retardants) reduce resistivity by only a minor amount when the wood has 8 percent moisture content or less, but they have a much larger effect when moisture content exceeds 10 to 12 percent.

The **dielectric constant** of oven-dry wood ranges from about 2 to 5 at room temperature, and it decreases slowly with increasing frequency. The dielectric constant increases as either temperature or moisture content increases. There is a negative interaction between moisture and frequency: At 20 Hz, the dielectric constant may range from about 4 for dry wood to  $10^6$  for wet wood; at 1 kHz, from 4 dry to 5,000 wet; and at 1 MHz, from about 3 dry to 100 wet. The dielectric constant is about 30 percent greater parallel to the grain than perpendicular to it.

The **power factor** of wood varies from about 0.01 for dry, low-density woods to as great as 0.95 for wet, high-density woods. It is usually greater parallel to the grain than perpendicular. The power factor is affected by complex interactions of frequency, moisture content, and temperature (James, 1975).

The change in electrical properties of wood with moisture content has led to the development of moisture meters for nondestructive estimation of moisture content. Resistance-type meters measure resistance between two pins driven into the wood. Dielectric-type meters depend on the correlation between moisture content and either dielectric constant or power factor, and they require only contact with the wood surface, not penetration.

#### Wood in Relation to Sound

The **transmission of sound** and vibrational properties in wood are functions of the grain angle. The speed of sound transmission is described by the expression  $v = E/\rho$ , in which  $v$  is the speed of sound in wood, in/s,  $E$  is the dynamic Young's modulus, lb/in<sup>2</sup>, and  $\rho$  is the density of the wood, slugs/in<sup>3</sup> (Ross and Pellerin, 1994). Various factors influence the speed of sound transmission; two of the most important factors are grain angle and the presence of degradation from decay. Hankinson's formula, cited previously, adequately describes the relationship between speed of sound transmission and grain angle. The dynamic modulus is about 10 percent higher than the static value and varies inversely with moisture changes by approximately 1.3 percent for each percentage change in moisture content.

Degradation from biological agents can significantly alter the speed at which sound travels in wood. Speed of sound transmission values are greatly reduced in severely degraded wood members. Sound transmission characteristics of wood products are used in one form of **nondestructive testing** to assess the performance characteristics of wood products. Because speed of sound transmission is a function of the extent of degradation from decay, this technique is used to estimate the extent of severe degradation in large timbers.

**PROPERTIES OF LUMBER PRODUCTS**  
by Russell Moody and David Green

**Visually Graded Structural Lumber**

**Stress-graded structural lumber** is produced under two systems: visual grading and machine grading. **Visual structural grading** is the oldest stress grading system. It is based on the premise that the mechanical properties of lumber differ from those of clear wood because many growth characteristics of lumber affect its properties; these characteristics can be seen and judged by eye (ASTM D245). The principal growth features affecting lumber properties are the size and location of knots, sloping grain, and density.

Grading rules for lumber nominally 2 × 4 in (standard 38 × 89 mm) thick (**dimension lumber**) are published by grading agencies (listing and addresses are given in "National Design Specification," American Forest & Paper Association, 1992 and later). For most species, allowable properties are based on test results from full-size specimens graded by agency rules, sampled according to ASTM D2915, and tested according to ASTM D4761. Procedures for deriving allowable properties from these tests are given in ASTM D1990. Allowable properties for visually graded hardwoods and a few softwoods are derived from clear-wood data following principles given in ASTM D2555. Derivation of the allowable strength properties accounts for within-species variability by starting with a nonparametric estimate of the 5th percentile of the data. Thus, 95 of 100 pieces would be expected to be stronger than the

assigned property. The allowable strength properties are based on an assumed normal duration of load of 10 years. Tables 6.7.6 and 6.7.7 show the grades and allowable properties for the four most commonly used species groupings sold in the United States. The allowable strength values in bending, tension, shear, and compression parallel to the grain can be multiplied by factors for other load durations. Some commonly used factors are 0.90 for permanent (50-year) loading, 1.15 for snow loads (2 months), and 1.6 for wind/earthquake loading (10 min). The most recent edition of "National Design Specification" should be consulted for updated property values and for property values for other species and size classifications.

Allowable properties are assigned to visually graded dimension lumber at two moisture content levels: green and 19 percent maximum moisture content (assumed 15 percent average moisture content). Because of the influence of knots and other growth characteristics on lumber properties, the effect of moisture content on lumber properties is generally less than its effect on clear wood. The  $C_M$  factors of Table 6.7.8 are for adjusting the properties in Tables 6.7.6 and 6.7.7 from 15 percent moisture content to green. The Annex of ASTM D1990 provides formulas that can be used to adjust lumber properties to any moisture content between green and 10 percent. Below about 8 percent moisture content, some properties may decrease with decreasing values, and care should be exercised in these situations (Green and Kretschmann, 1995).

**Shrinkage** in commercial lumber differs from that in clear wood pri-

**Table 6.7.6 Base Design Values for Visually Graded Dimension Lumber\***  
(Tabulated design values are for normal load duration and dry service conditions.)

Species and commercial grade	Size classification, in	Design values, (lb/in <sup>2</sup> )					Modulus of elasticity $E$	Grading rules agency
		Bending $F_b$	Tension parallel to grain $F_t$	Shear parallel to grain $F_v$	Compression perpendicular to grain $F_{c\perp}$	Compression parallel to grain $F_c$		
Douglas-Fir-Larch								
Select structural No. 1 and better	2-4 thick	1,000	1,000	95	625	1,700	1,900,000	WCLIB WWPA
No. 1	2 and wider	1,150	775	95	625	1,500	1,800,000	
No. 2		1,000	675	95	625	1,450	1,700,000	
No. 3		875	575	95	625	1,300	1,600,000	
Stud	2-4 thick	500	325	95	625	750	1,400,000	
Construction Standard		675	450	95	625	825	1,400,000	
Utility		2-4 wide	1,000	650	95	625	1,600	
		550	375	95	625	1,350	1,400,000	
		275	175	95	625	875	1,300,000	
Hem-Fir								
Select structural No. 1 and better	2-4 thick	1,400	900	75	405	1,500	1,600,000	WCLIB WWPA
No. 1	2 and wider	1,050	700	75	405	1,350	1,500,000	
No. 2		950	600	75	405	1,300	1,500,000	
No. 3		850	500	75	405	1,250	1,300,000	
Stud	2-4 thick	500	300	75	405	725	1,200,000	
Construction Standard		675	400	75	405	800	1,200,000	
Utility		2-4 wide	975	575	75	405	1,500	
		550	325	75	405	1,300	1,200,000	
		250	150	75	405	850	1,100,000	
Spruce-Pine-Fir								
Select structural No. 1-No. 2	2-4 thick	1,250	675	70	425	1,400	1,500,000	NLGA
No. 3	2 and wider	875	425	70	425	110	1,400,000	
Stud		500	250	70	425	625	1,200,000	
Construction Standard		675	325	70	425	675	1,200,000	
Utility	2-4 thick	975	475	70	425	1,350	1,300,000	
		550	275	70	425	1,100	1,200,000	
	2-4 wide	250	125	70	425	725	1,100,000	

\* Lumber dimensions—Tabulated design values are applicable to lumber that will be used under dry conditions such as in most covered structures. For 2- to 4-in-thick lumber, the DRY dressed sizes shall be used regardless of the moisture content at the time of manufacture or use. In calculating design values, the natural gain in strength and stiffness that occurs as lumber dries has been taken into consideration as well as the reduction in size that occurs when unseasoned lumber shrinks. The gain in load-carrying capacity due to increased strength and stiffness resulting from drying more than offsets the design effect of size reductions due to shrinkage. Size factor  $C_F$ , repetitive-member factor  $C_R$ , flat-use factor  $C_{fu}$ , and wet-use factor  $C_M$  are given in Table 6.7.8.

SOURCE: Table used by permission of the American Forest & Paper Association.

Table 6.7.7 Design Values for Visually Graded Southern Pine Dimension Lumber\*

(Tabulated design values are for normal load duration and dry service conditions.)

Species and commercial grade	Size classification, in	Design values, lb/in <sup>2</sup>						Grading rules agency	
		Bending $F_b$	Tension parallel to grain $F_t$	Shear parallel to grain $F_v$	Compression perpendicular to grain $F_{c\perp}$	Compression parallel to grain $F_c$	Modulus of elasticity $E$		
Dense select structural	2-4 thick	3,050	1,650	100	660	2,250	1,900,000	SPIB	
Select structural		2,850	1,600	100	565	2,100	1,800,000		
Nondense select structural	2-4 wide	2,650	1,350	100	480	1,950	1,700,000		
No. 1 dense		2,000	1,100	100	660	2,000	1,800,000		
No. 1		1,850	1,050	100	565	1,850	1,700,000		
No. 1 nondense		1,700	900	100	480	1,700	1,600,000		
No. 2 dense		1,700	875	90	660	1,850	1,700,000		
No. 2		1,500	825	90	656	1,650	1,600,000		
No. 2 nondense		1,350	775	90	480	1,600	1,400,000		
No. 3		850	475	90	565	975	1,400,000		
Stud		875	500	90	565	975	1,400,000		
Construction	2-4 thick	1,100	625	100	565	1,800	1,500,000		
Standard		625	350	90	565	1,500	1,300,000		
Utility	4 wide	300	175	90	565	975	1,300,000		
Dense select structural	2-4 thick	2,700	1,500	90	660	2,150	1,900,000		
Select structural		2,550	1,400	90	565	2,000	1,800,000		
Nondense select structural	5-6 wide	2,350	1,200	90	480	1,850	1,700,000		
No. 1 dense		1,750	950	90	660	1,900	1,800,000		
No. 1		1,650	900	90	565	1,750	1,700,000		
No. 1 nondense		1,500	800	90	480	1,600	1,600,000		
No. 2 dense		1,450	775	90	660	1,750	1,700,000		
No. 2		1,250	725	90	565	1,600	1,600,000		
No. 2 nondense		1,150	675	90	480	1,500	1,400,000		
No. 3		750	425	90	565	925	1,400,000		
Stud		775	425	90	565	925	1,400,000		
Dense select structural	2-4 thick	2,450	1,350	90	660	2,050	1,900,000		
Select structural		2,300	1,300	90	565	1,900	1,800,000		
Nondense select structural	8 wide	2,100	1,100	90	480	1,750	1,700,000		
No. 1 dense		1,650	875	90	660	1,800	1,800,000		
No. 1		1,500	825	90	565	1,650	1,700,000		
No. 1 nondense		1,350	725	90	480	1,550	1,600,000		
No. 2 dense		1,400	675	90	660	1,700	1,700,000		
No. 2		1,200	650	90	565	1,550	1,600,000		
No. 2 nondense		1,100	600	90	480	1,450	1,400,000		
No. 3		700	400	90	565	875	1,400,000		
Dense select structural	2-4 thick	2,150	1,200	90	660	2,000	1,900,000		
Select structural		2,050	1,100	90	565	1,850	1,800,000		
Nondense select structural	10 wide	1,850	950	90	480	1,750	1,700,000		
No. 1 dense		1,450	775	90	660	1,750	1,800,000		
No. 1		1,300	725	90	565	1,600	1,700,000		
No. 1 nondense		1,200	650	90	480	1,500	1,600,000		
No. 2 dense		1,200	625	90	660	1,650	1,700,000		
No. 2		1,050	575	90	565	1,500	1,600,000		
No. 2 nondense		950	550	90	480	1,400	1,400,000		
No. 3		600	325	90	565	850	1,400,000		
Dense select structural	2-4 thick	2,050	1,100	90	660	1,950	1,900,000		
Select structural		1,900	1,050	90	565	1,800	1,800,000		
Nondense select structural	12 wide	1,750	900	90	480	1,700	1,700,000		
No. 1 dense		1,350	725	90	660	1,700	1,800,000		
No. 1		1,250	675	90	565	1,600	1,700,000		
No. 1 nondense		1,150	600	90	480	1,500	1,600,000		
No. 2 dense		1,150	575	90	660	1,600	1,700,000		
No. 2		975	550	90	565	1,450	1,600,000		
No. 2 nondense		900	525	90	480	1,350	1,400,000		
No. 3		575	325	90	565	825	1,400,000		

\* For size factor  $C_F$ , appropriate size adjustment factors have already been incorporated in the tabulated design values for most thicknesses of southern pine dimension lumber. For dimension lumber 4 in thick, 8 in and wider, tabulated bending design values  $F_b$  shall be permitted to be multiplied by the size factor  $C_F = 1.1$ . For dimension lumber wider than 12 in, tabulated bending, tension, and compression parallel-to-grain design values for 12-in-wide lumber shall be multiplied by the size factor  $C_F = 0.9$ . Repetitive-member factor  $C_R$ , flat-use factor  $C_{fu}$ , and wet-service factor  $C_M$  are given in Table 6.7.8.

SOURCE: Table used by permission of the American Forest & Paper Association.



**Table 6.7.8 Adjustment Factors**

**Size factor  $C_F$  for Table 6.7.6 (Douglas–Fir–Larch, Hem–Fir, Spruce–Pine–Fir)**

---

Tabulated bending, tension, and compression parallel to grain design values for dimension lumber 2 to 4 inches thick shall be multiplied by the following size factors:

---

Grades	Width, in	$F_b$ Thickness, in		$F_t$	$F_c$
		2 & 3	4		
Select structural no. 1 and better no. 1, no. 2, no. 3	2, 3, and 4	1.5	1.5	1.5	1.15
	5	1.4	1.4	1.4	1.1
	6	1.3	1.3	1.3	1.1
	8	1.2	1.3	1.2	1.05
	10	1.1	1.2	1.1	1.0
	12	1.0	1.1	1.0	1.0
	14 and wider	0.9	1.0	0.9	0.9
Stud	2, 3, and 4	1.1	1.1	1.1	1.05
	5 and 6	1.0	1.0	1.0	1.0
Construction and standard	2, 3, and 4	1.0	1.0	1.0	1.0
Utility	4	1.0	1.0	1.0	1.0
	2 and 3	0.4	—	0.4	0.6

**Repetitive-member factor  $C_r$  for Tables 6.7.6 and 6.7.7**

Bending design values  $F_b$  for dimension lumber 2 to 4 in thick shall be multiplied by the repetitive factor  $C_r = 1.15$ , when such members are used as joists, truss chords, rafters, studs, planks, decking, or similar members which are in contact or spaced not more than 24 in on centers, are not less than 3 in number and are joined by floor, roof, or other load-distributing elements adequate to support the design load.

**Flat-use factor  $C_{fu}$  for Tables 6.7.6 and 6.7.7**

Bending design values adjusted by size factors are based on edgewise use (load applied to narrow face). When dimension lumber is used flatwise (load applied to wide face), the bending design value  $F_b$  shall also be multiplied by the following flat-use factors:

Width, in	Thickness, in	
	2 and 3	4
2 and 3	1.0	—
4	1.1	1.0
5	1.1	1.05
6	1.15	1.05
8	1.15	1.05
10 and wider	1.2	1.1

**Wet-use factor  $C_M$  for Tables 6.7.6 and 6.7.7**

When dimension lumber is used where moisture content will exceed 19 percent for an extended period, design values shall be multiplied by the appropriate wet service factors from the following table:

$F_b$	$F_t$	$F_v$	$F_{c\perp}$	$F_c$	$E$
0.85*	1.0	0.97	0.67	0.8†	0.9

\* When  $F_b C_F \leq 1150 \text{ lb/in}^2$ ,  $C_M = 1.0$ .

† When  $F_t C_F \leq 750 \text{ lb/in}^2$ ,  $C_M = 1.0$ .

SOURCE: Used by permission of the American Forest & Paper Association.

marily because the grain in lumber is seldom oriented in purely radial and tangential directions. Approximate formulas used to estimate shrinkage of lumber for most species are

$$S_w = 6.031 - 0.215M$$

$$S_t = 5.062 - 0.181M$$

where  $S_w$  is the shrinkage across the wide [8-in (203-mm)] face of the lumber in a 2 × 8 (standard 38 × 184 mm),  $S_t$  is the shrinkage across the narrow [2-in (51-mm)] face of the lumber, and  $M$  = moisture con-

tent (percent). As with clear wood, shrinkage is assumed to occur below a moisture content of 28 percent. Because extractives make wood less hygroscopic, less shrinkage is expected in redwood, western redcedar, and northern white cedar (Green, 1989).

The effect of **temperature** on lumber properties appears to be similar to that on clear wood. For simplicity, “National Design Specification” uses conservative factors to account for reversible reductions in properties as a result of heating to 150°F (65°C) or less (Table 6.7.9). No increase in properties is taken for temperatures colder than normal be-

**Table 6.7.9 Temperature Factors  $C_t$  for Short-Term Exposure**

Design values	In-service moisture conditions	$C_t$		
		$T \leq 100^\circ\text{F}$	$100^\circ\text{F} < T \leq 125^\circ\text{F}$	$125^\circ\text{F} < T \leq 150^\circ\text{F}$
$F_t, E$	Green or dry	1.0	0.9	0.9
$F_b, F_v, F_{c\perp}$ , and $F_c$	$\leq 19\%$ green	1.0	0.8	0.7
		1.0	0.7	0.5

SOURCE: Table used by permission of the American Forest & Paper Association.

**Table 6.7.10 Design Values for Mechanically Graded Dimension Lumber**  
(Tabulated design values are for normal load duration and dry service conditions.)

Species and commercial grade	Size classification, in	Design values, lb/in <sup>2</sup>				Grading rules agency	
		Bending	Tension parallel	Compression parallel	MOE		
Machine-stress-rated lumber							
900F-1.0E	2 and less in thickness	900	350	1,050	1,000,000	WCLIB	
1200F-1.2E		1,200	600	1,400	1,200,000	NLGA, SPIB, WCLIB, WWPA	
1250F-1.4E		1,250	800	1,450	1,400,000	WCLIB	
1350F-1.3E		1,350	750	1,600	1,300,000	SPIB, WCLIB, WWPA	
1400F-1.2E		1,400	800	1,600	1,200,000	SPIB	
1450F-1.3E		1,450	800	1,625	1,300,000	NLGA, WCLIB, WWPA	
1500F-1.3E		1,500	900	1,650	1,300,000	SPIB	
1500F-1.4E		1,500	900	1,650	1,400,000	NLGA, SPIB, WCLIB, WWPA	
1600F-1.4E		1,600	950	1,675	1,400,000	SPIB	
1650F-1.4E		1,650	1,020	1,700	1,400,000	SPIB	
1650F-1.5E		1,650	1,020	1,700	1,500,000	NLGA, SPIB, WCLIB, WWPA	
1650F-1.6E		1,650	1,075	1,700	1,600,000	WCLIB	
1800F-1.5E		1,800	1,300	1,750	1,500,000	SPIB	
1800F-1.6E		1,800	1,175	1,750	1,600,000	NLGA, SPIB, WCLIB, WWPA	
1950F-1.5E		1,950	1,375	1,800	1,500,000	SPIB	
1950F-1.7E		1,950	1,375	1,800	1,700,000	NLGA, SPIB, WCLIB, WWPA	
2000F-1.6E	2 and wider	2,000	1,300	1,825	1,600,000	SPIB	
2100F-1.8E		2,100	1,575	1,875	1,800,000	NLGA, SPIB, WCLIB, WWPA	
2250F-1.6E		2,250	1,750	1,925	1,600,000	SPIB	
2250F-1.9E		2,250	1,750	1,925	1,900,000	NLGA, SPIB, WCLIB, WWPA	
2400F-1.7E		2,400	1,925	1,975	1,700,000	SPIB	
2400F-1.8E		2,400	1,925	1,975	1,800,000	SPIB	
2400F-2.0E		2,400	1,925	1,975	2,000,000	NLGA, SPIB, WCLIB, WWPA	
2500F-2.2E		2,500	1,750	2,000	2,200,000	WCLIB	
2550F-2.1E		2,550	2,050	2,025	2,100,000	NLGA, SPIB, WWPA	
2700F-2.0E		2,700	1,800	2,100	2,000,000	WCLIB	
2700F-2.2E		2,700	2,150	2,100	2,200,000	NLGA, SPIB, WCLIB, WWPA	
2850F-2.3E		2,850	2,300	2,150	2,300,000	SPIB, WWPA	
3000F-2.4E		3,000	2,400	2,200	2,400,000	NLGA, SPIB	
3150F-2.5E		3,150	2,500	2,250	2,500,000	SPIB	
3300F-2.6E		3,300	2,650	2,325	2,600,000	SPIB	
900F-1.2E		2 and less in thickness	900	350	1,050	1,200,000	NLGA, WCLIB
1200F-1.5E	1,200		600	1,400	1,500,000	NLGA, WCLIB	
1350F-1.8E	1,350		750	1,600	1,800,000	NLGA	
1500F-1.8E	1,500		900	1,650	1,800,000	WCLIB	
1800F-2.1E	1,800	1,175	1,750	2,100,000	NLGA, WCLIB		
Machine-evaluated lumber							
M-10	2 and less in thickness	1,400	800	1,600	1,200,000	SPIB	
M-11		1,550	850	1,650	1,500,000		
M-12		1,600	850	1,700	1,600,000		
M-13		1,600	950	1,700	1,400,000		
M-14		1,800	1,000	1,750	1,700,000		
M-15		1,800	1,100	1,750	1,500,000		
M-16		1,800	1,300	1,750	1,500,000		
M-17		1,950	1,300	2,050	1,700,000		
M-18		2,000	1,200	1,850	1,800,000		
M-19		2 and wider	2,000	1,300	1,850		1,600,000
M-20			2,000	1,600	2,100		1,900,000
M-21			2,300	1,400	1,950		1,900,000
M-22			2,350	1,500	1,950		1,700,000
M-23			2,400	1,900	2,000		1,800,000
M-24			2,700	1,800	2,100		1,900,000
M-25			2,750	2,000	2,100		2,200,000
M-26	2,800		1,800	2,150	2,000,000		
M-27	3,000	2,000	2,400	2,100,000			

**Lumber dimensions:** Tabulated design values are applicable to lumber that will be used under dry conditions such as in most covered structures. For 2- to 4-in-thick lumber, the *dry* dressed sizes shall be used regardless of the moisture content at the time of manufacture or use. In calculating design values, natural gain in strength and stiffness that occurs as lumber dries had been taken into consideration as well as reduction in size that occurs when unseasoned lumber shrinks. The gain in load-carrying capacity due to increased strength and stiffness resulting from drying more than offsets the design effect of size reductions due to shrinkage. **Shear parallel to grain  $F_v$  and compression perpendicular to grain  $F_{c\perp}$ :** Design values for shear parallel to grain  $F_v$  and compression perpendicular to grain  $F_{c\perp}$  are identical to the design values given in Tables 6.7.6 and 6.7.7 for No. 2 visually graded lumber of the appropriate species. When the  $F_v$  or  $F_{c\perp}$  values shown on the grade stamp differ from the values shown in the tables, the values shown on the grade stamp shall be used for design. **Modulus of elasticity  $E$  and tension parallel to grain  $F_t$ :** For any given bending design value  $F_b$ , the average modulus of elasticity  $E$  and tension parallel to grain  $F_t$  design value may vary depending upon species, timber source, or other variables. The  $E$  and  $F_t$  values included in the  $F_b$  and  $E$  grade designations are those usually associated with each  $F_b$  level. Grade stamps may show higher or lower values if machine rating indicates the assignment is appropriate. When the  $E$  or  $F_t$  values shown on a grade stamp differ from the values in Table 6.7.10 the values shown on the grade stamp shall be used for design. The tabulated  $F_b$  and  $F_c$  values associated with the designated  $F_b$  value shall be used for design.

SOURCE: Table used by permission of the American Forest & Paper Association.

cause in practice it is difficult to ensure that the wood temperature remains consistently low.

**Mechanically Graded Structural Lumber**

**Machine-stress-rated (MSR) lumber and machine-evaluated lumber (MEL)** are two types of mechanically graded lumber. The three basic components of both mechanical grading systems are (1) sorting and prediction of strength through machine-measured nondestructive determination of properties coupled with visual assessment of growth characteristics, (2) assignment of allowable properties based upon strength prediction, and (3) quality control to ensure that assigned properties are being obtained. Grade names for MEL lumber start with an M designation. Grade “names” for MSR lumber are a combination of the allowable bending stress and the average modulus of elasticity [e.g., 1650F-1.4E means an allowable bending stress of 1,650 lb/in<sup>2</sup> (11.4 MPa) and modulus of elasticity of 1.4 × 10<sup>6</sup> lb/in<sup>2</sup> (9.7 GPa)]. Grades of mechanically graded lumber and their allowable properties are given in Table 6.7.10.

**Structural Composite Lumber**

**Types of Structural Composite Lumber** Structural composite lumber refers to several types of reconstituted products that have been developed to meet the demand for high-quality material for the manufacture of engineered wood products and structures. Two distinct types are commercially available: laminated veneer lumber (LVL) and parallel-strand lumber (PSL).

**Laminated veneer lumber** is manufactured from layers of veneer with the grain of all the layers parallel. This contrasts with plywood, which consists of adjacent layers with the grain perpendicular. Most manufacturers use sheets of 1/10- to 1/8-in- (2.5- to 4.2-mm-) thick veneer. These veneers are stacked up to the required thickness and may be laid end to end to the desired length with staggered end joints in the veneer. Waterproof adhesives are generally used to bond the veneer under pressure. The resulting product is a billet of lumber that may be up to 1 3/4 in (44 mm) thick, 4 ft (1.2 m) wide, and 80 ft (24.4 m) long. The billets are then ripped to the desired width and cut to the desired length. The common sizes of LVL closely resemble those of sawn dimension lumber.

**Parallel-strand lumber** is manufactured from strands or elongated flakes of wood. One North American product is made from veneer clipped to 1/2 in (13 mm) wide and up to 8 ft (2.4 m) long. Another product is made from elongated flakes and technology similar to that used to produce oriented strandboard. A third product is made from mats of interconnected strands crushed from small logs that are assembled into the desired configuration. All the products use waterproof adhesive that is cured under pressure. The size of the product is controlled during manufacture through adjustments in the amount of material and pressure applied. Parallel-strand lumber is commonly available in the same sizes as structural timbers or lumber.

**Properties of Structural Composite Lumber** Standard design values have not been established for either LVL or PSL. Rather, standard procedures are available for developing these design values (ASTM D5456). Commonly, each manufacturer follows these procedures and submits supporting data to the appropriate regulatory authority to establish design properties for the product. Thus, design information for LVL and PSL varies among manufacturers and is given in their product literature. Generally, the engineering design properties compare favorably with or exceed those of high-quality solid dimension lumber. Example design values accepted by U.S. building codes are given in Table 6.7.11.

**Glulam Timber**

Structural **glued-laminated (glulam)** timber is an engineered, stress-rated product of a timber laminating plant, consisting of two or more layers of wood glued together with the grain of all layers (or laminations) approximately parallel. Laminations are typically made of specially selected and prepared sawn lumber. Nominal 2-in (standard 38-mm) lumber is used for straight or slightly curved members, and nominal 1-in (standard 19-mm) lumber is used for other curved mem-

**Table 6.7.11 Example Design Values for Structural Composite Lumber**

Product	Bending stress		Modulus of elasticity		Horizontal shear	
	lb/in <sup>2</sup>	MPa	× 10 <sup>3</sup> lb/in <sup>2</sup>	GPa	lb/in <sup>2</sup>	MPa
LVL	2,800	19.2	2,000	13.8	190	1.31
PSL, type A	2,900	20.0	2,000	13.8	210	1.45
PSL, type B	1,500	10.3	1,200	8.3	150	1.03

bers. A national standard, ANSI A190.1, contains requirements for production, testing, and certification of the product in the United States.

**Manufacture** Straight members up to 140 ft (42 m) long and more than 7 ft (2.1 m) deep have been manufactured with size limitations generally resulting from transportation constraints. Curved members have been used in domed structures spanning over 500 ft (152 m), such as the Tacoma Dome. Manufacturing and design standards cover many softwoods and hardwoods; Douglas-fir and southern pine are the most commonly used softwood species.

Design standards for glulam timber are based on either dry or wet use. Manufacturing standards for dry use, which is defined as use conditions resulting in a moisture content of 16 percent or less, permits manufacturing with nonwaterproof adhesives; however, nearly all manufacturers in North America use waterproof adhesives exclusively. For wet-use conditions, these waterproof adhesives are required. For wet-use conditions in which the moisture content is expected to exceed 20 percent, pressure preservative treatment is recommended (AWPA C28). Lumber can be pressure-treated with water-based preservatives prior to gluing, provided that special procedures are followed in the manufacture. For treatment after gluing, oil-based preservatives are generally recommended. Additional information on manufacture is provided in the “Wood Handbook.”

Glulam timber is generally manufactured at a moisture content below 16 percent. For most dry-use applications, it is important to protect the glulam timber from increases in moisture content. End sealers, surface sealers, primer coats, and wrappings may be applied at the manufacturing plant to provide protection from changes in moisture content. Protection will depend upon the final use and finish of the timber.

Special precautions are necessary during handling, storage, and erection to prevent structural damage to glulam members. Padded or non-marring slings are recommended; cable slings or chokers should be avoided unless proper blocking protects the members. AITC 111 provides additional details on protection during transit, storage, and erection.

**Design** Glulam timber beams are available in standard sizes with standardized design properties. The following standard widths are established to match the width of standard sizes of lumber, less an allowable amount for finishing the edges of the manufactured beams:

- 3 or 3 1/8 in (76 or 79 mm)
- 5 or 5 1/8 in (127 or 130 mm)
- 6 3/4 in (171 mm)
- 8 1/2 or 8 3/4 in (216 or 222 mm)
- 10 1/2 or 10 3/4 in (267 or 273 mm)

Standard beam depths are common multiples of lamination thickness of either 1 3/8 or 1 1/2 in (35 or 38 mm). There are no standard beam lengths, although most uses will be on spans where the length is from 10 to 20 times the depth. Allowable spans for various loadings of the standard sizes of beams are available from either the American Institute of Timber Construction or American Wood Systems.

The design stresses for beams in bending for dry-use applications are standardized in multiples of 200 lb/in<sup>2</sup> (1.4 MPa) within the range of 2,000 to 3,000 lb/in<sup>2</sup> (13.8 to 20.7 MPa). Modulus of elasticity values associated with these design stresses in bending vary from 1.6 to 2.0 × 10<sup>6</sup> lb/in<sup>2</sup>. A bending stress of 2,400 lb/in<sup>2</sup> (16.5 MPa) and a modulus of elasticity of 1.8 × 10<sup>6</sup> lb/in<sup>2</sup> (12.4 GPa) are most commonly specified, and the designer needs to verify the availability of beams with higher

**Table 6.7.12 Design Stresses for Selected Species of Round Timbers for Building Construction**

Type of timber and species	Design stress				Modulus of elasticity	
	Bending		Compression		× 10 <sup>6</sup> lb/in <sup>2</sup>	GPa
	lb/in <sup>2</sup>	MPa	lb/in <sup>2</sup>	MPa		
Poles*						
Southern pine and Douglas-fir	2,100	14.5	1,000	6.9	1.5	10.3
Western redcedar	1,400	9.6	800	5.5	0.9	6.2
Piles†						
Southern pine	2,400	16.5	1,200	8.3	1.5	10.3
Douglas-fir	2,450	16.9	1,250	8.6	1.5	10.3
Red pine	1,900	13.1	900	6.2	1.3	8.8

\* From "Timber Construction Manual" (AITC, 1994).

† From "National Design Specification" (AF&PA, 1991).

values. Design properties must be adjusted for wet-use applications. Detailed information on other design properties for beams as well as design properties and procedures for arches and other uses are given in "National Design Specification" (AF&PA).

### Round Timbers

Round timbers in the form of poles, piles, or construction logs represent some of the most efficient uses of forest products because of the minimum of processing required. Poles and piles are generally debarked or peeled, seasoned, graded, and treated with a preservative prior to use. Construction logs are often shaped to facilitate their use. See Table 6.7.12.

**Poles** The primary use of wood poles is to support utility and transmission lines. An additional use is for building construction. Each of these uses requires that the poles be pressure-treated with preservatives following the applicable AWP standard (C1). For utility structures, pole length may vary from 30 to 125 ft (9.1 to 38.1 m). Poles for building construction rarely exceed 30 ft (9.1 m). Southern pines account for the highest percentage of poles used in the United States because of their favorable strength properties, excellent form, ease of treatment, and availability. Douglas-fir and western redcedar are used for longer lengths; other species are also included in the ANSI O5.1 standard (ANSI 1992) that forms the basis for most pole purchases in the United States.

Design procedures for the use of ANSI O5.1 poles in utility structures are described in the "National Electric Safety Code" (NESC). For building construction, design properties developed based on ASTM D2899 (see ASTM, 1995) are provided in "Timber Construction Manual" (AITC, 1994) or ASAE EP 388.

**Piles** Most piles used for foundations in the United States utilize either southern pine or Douglas-fir. Material requirements for timber piles are given in ASTM D25, and preservative treatment should follow the applicable AWP standard (C1 or C3). Design stress and procedures are provided in "National Design Specifications."

**Construction Logs** Log buildings continue to be a popular form of construction because nearly any available species of wood can be used. Logs are commonly peeled prior to fabrication into a variety of shapes. There are no standardized design properties for construction logs, and when they are required, log home suppliers may develop design properties by following an ASTM standard (ASTM D3957).

### PROPERTIES OF STRUCTURAL PANEL PRODUCTS

by Roland Hernandez

**Structural panel products** are a family of wood products made by bonding veneer, strands, particles, or fibers of wood into flat sheets. The members of this family are (1) plywood, which consists of products made completely or in part from wood veneer; (2) flakeboard, made from

strands, wafers, or flakes; (3) particleboard, made from particles; and (4) fiberboard and hardboard, made from wood fibers. Plywood and flakeboard make up a large percentage of the panels used in structural applications such as roof, wall, and floor sheathing; thus, only those two types will be described here.

### Plywood

**Plywood** is the name given to a wood panel composed of relatively thin layers or **plies** of **veneer** with the wood grain of adjacent layers at right angles. The outside plies are called **faces** or **face and back plies**, the inner plies with grain parallel to that of the face and back are called **cores** or **centers**, and the plies with grain perpendicular to that of the face and back are called **crossbands**. In four-ply plywood, the two center plies are glued with the grain direction parallel to each ply, making one center layer. Total panel thickness is typically not less than 1/16 in (1.6 mm) nor more than 3 in (76 mm). Veneer plies may vary as to number, thickness, species, and grade. Stock plywood sheets usually measure 4 by 8 ft (1.2 by 2.4 m), with the 8-ft (2.4-m) dimension parallel to the grain of the face veneers.

The alternation of grain direction in adjacent plies provides plywood panels with dimensional stability across their width. It also results in fairly similar axial strength and stiffness properties in perpendicular directions within the panel plane. The laminated construction results in a distribution of defects and markedly reduces splitting (compared to solid wood) when the plywood is penetrated by fasteners.

Two general classes of plywood, covered by separate standards, are available: **construction and industrial plywood** and **hardwood and decorative plywood**. Construction and industrial plywood are covered by Product Standard PS 1-83, and hardwood and decorative plywood are covered by ANSI/HPVA HP-1-1994. Each standard recognizes different exposure durability classifications, which are primarily based on the moisture resistance of the glue used, but sometimes also address the grade of veneer used.

The exposure durability classifications for construction and industrial plywood specified in PS-1 are **exterior, exposure 1, intermediate glue (exposure 2), and interior**. Exterior plywood is bonded with exterior (waterproof) glue and is composed of C-grade or better veneers throughout. Exposure 1 plywood is bonded with exterior glue, but it may include D-grade veneers. Exposure 2 plywood is made with glue of intermediate resistance to moisture. Interior-type plywood may be bonded with interior, intermediate, or exterior (waterproof) glue. D-grade veneer is allowed on inner and back plies of certain interior-type grades.

The exposure durability classifications for hardwood and decorative plywood specified in ANSI/HPVA HP-1-1994 are, in decreasing order of moisture resistance, as follows: **technical (exterior), type I (exterior), type II (interior), and type III (interior)**. Hardwood and decorative plywood are not typically used in applications where structural performance is a prominent concern. Therefore, most of the remaining discus-

sion of plywood performance will concern construction and industrial plywood.

A very significant portion of the market for construction and industrial plywood is in residential construction. This market reality has resulted in the development of performance standards for sheathing and single-layer subfloor or underlayment for residential construction by the American Plywood Association (APA). Plywood panels conforming to these performance standards for sheathing are marked with grade stamps such as those shown in Fig. 6.7.2 (example grade stamps are shown for different agencies). As seen in this figure, the grade stamps must show (1) conformance to the plywood product standards; (2) recognition as a quality assurance agency by the National Evaluation Service (NES), which is affiliated with the Council of American Building Officials; (3) exposure durability classification; (4) thickness of panel; (5) span rating, 32/16, which refers to the maximum allowable roof support spacing of 32 in (813 mm) and maximum floor joist spacing of 16 in (406 mm); (6) conformance to the performance-rated standard of the agency; (7) manufacturer's name or mill number; and (8) grades of face and core veneers.

ber, (4) plywood bond-line type, (5) flame spread index class, (6) description of layup, (7) formaldehyde emission characteristics, (8) face species, and (9) veneer grade of face.

The span-rating system for plywood was established to simplify specification of plywood without resorting to specific structural engineering design. This system indicates performance without the need to refer to species group or panel thickness. It gives the allowable span when the face grain is placed across supports.

If design calculations are desired, a design guide is provided by APA-EWS in "Plywood Design Specifications" (PDS). The design guide contains tables of grade stamp references, section properties, and allowable stresses for plywood used in construction of buildings and

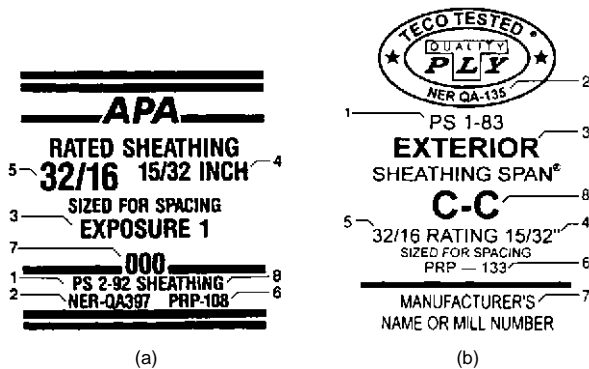

Fig. 6.7.2 Typical grade marks for (a) sheathing-grade plywood conforming to Product Standard PS 1-83 and (b) sheathing-grade structural-use panel conforming to Product Standard PS 2-92. (1) Conformance to indicated product standard, (2) recognition as a quality assurance agency, (3) exposure durability classification, (4) thickness, (5) span rating, (6) conformance to performance-rated product, (7) manufacturer's name or mill number, and (8) grade of face and core veneers.

All hardwood plywood represented as conforming to American National Standard ANSI/HPVA-HP-1-1994 is identified by one of two methods—either marking each panel with the HPVA plywood grade stamp (Fig. 6.7.3) or including a written statement with this information with the order or shipment. The HPVA grade stamp shows (1) HPVA trademark, (2) standard that governs manufacture, (3) HPVA mill num-

HARDWOOD PLYWOOD & VENEER ASSOCIATION		
FORMALDEHYDE EMISSION 0.2 PPM CONFORMS TO HUD REQUIREMENTS <sup>7</sup>	RED OAK <sup>8</sup> PLYWOOD   1	FLAME SPREAD 200 OR LESS ASTM E 84 <sup>5</sup>
LAY UP 6 1/4 INCH THICK HP-SG-86 <sup>6</sup>	MILL 000 <sup>3</sup> SPECIALTY GRADE <sup>9</sup>	BOND LINE TYPE II <sup>4</sup> ANSI/HPVA HP-1-1994 <sup>2</sup>

Fig. 6.7.3 Grade stamp for hardwood plywood conforming to ANSI/HPVA HP-1-1994. (1) Trademark of Hardwood Plywood and Veneer Association, (2) standard that governs manufacture, (3) HPVA mill number, (4) plywood bond-line type, (5) flame spread index class, (6) layup description, (7) formaldehyde emission characteristics, (8) face species, and (9) veneer grade of face.

similar related structures. For example, given the grade stamp shown in Fig. 6.7.2, the grade stamp reference table in the PDS specifies that this particular plywood is made with veneer from species group 1, has section property information based on unsanded panels (Table 6.7.13), and is assigned allowable design stresses from the S-3 grade level (Table 6.7.14). Design information for grade stamps other than that shown in Fig. 6.7.2 is available in the PDS.

If calculations for the actual physical and mechanical properties of plywood are desired, formulas relating the properties of the particular wood species in the component plies to the laminated panel are provided in "Wood Handbook" (Forest Products Laboratory, 1987). These formulas could be applied to plywood of any species, provided the basic mechanical properties of the species were known. Note, however, that the formulas yield predicted actual properties (not design values) of plywood made of defect-free veneers.

Table 6.7.13 Effective Section Properties for Plywood—Unsanded Panels\*

Nominal thickness, in	Approximate weight, lb/ft <sup>2</sup>	$t_s$ Effective thickness for shear, in	Stress applied parallel to face grain				Stress applied perpendicular to face grain			
			A Area, in <sup>2</sup> /ft	I Moment of inertia, in <sup>4</sup> /ft	KS Effective section modulus, in <sup>3</sup> /ft	Ib/Q Rolling shear constant, in <sup>2</sup> /ft	A Area, in <sup>2</sup> /ft	I Moment of inertia, in <sup>4</sup> /ft	KS Effective section modulus, in <sup>3</sup> /ft	Ib/Q Rolling shear constant, in <sup>2</sup> /ft
5/16-U	1.0	0.268	1.491	0.022	0.112	2.569	0.660	0.001	0.023	4.497
3/8-U	1.1	0.278	1.868	0.039	0.152	3.110	0.799	0.002	0.033	5.444
15/32 & 1/2-U	1.5	0.298	2.292	0.067	0.213	3.921	1.007	0.004	0.056	2.450
19/32 & 5/8-U	1.8	0.319	2.330	0.121	0.379	5.004	1.285	0.010	0.091	3.106
23/32 & 3/4-U	2.2	0.445	3.247	0.234	0.496	6.455	1.563	0.036	0.232	3.613
7/8-U	2.6	0.607	3.509	0.340	0.678	7.175	1.950	0.112	0.397	4.791
1-U	3.0	0.842	3.916	0.493	0.859	9.244	3.145	0.210	0.660	6.533
1 1/8-U	3.3	0.859	4.725	0.676	1.047	9.960	3.079	0.288	0.768	7.931

\* 1 in = 25.4 mm; 1 ft = 0.3048 m; 1 lb/ft<sup>2</sup> = 4.882 kg/m<sup>2</sup>.

**Table 6.7.14 Allowable Stresses for Construction and Industrial Plywood (Species Group 1)\***

Type of stress, lb/in <sup>2</sup>	Grade stress level				
	S-1		S-2		S-3
	Wet	Dry	Wet	Dry	Dry only
$F_b$ and $F_t$	1,430	2,000	1,190	1,650	1,650
$F_c$		970	1,640	900	1,540
$F_v$	155	190	155	190	160
$F_s$	63	75	63	75	—
$G$	70,000	90,000	70,000	90,000	82,000
$F_c$	210	340	210	340	340
$E$	1,500,000	1,800,000	1,500,000	1,800,000	1,800,000

\* Stresses are based on normal duration of load and on common structural applications where panels are 24 in (610 mm) or greater in width. For other use conditions, see PDS for modifications.  $F_b$  is extreme fiber stress in bending;  $F_t$ , tension in plane of plies;  $F_c$ , compression in plane of plies;  $F_v$ , shear through the thickness;  $F_s$ , rolling shear in plane of plies;  $G$ , modulus of rigidity;  $F_c$ , bearing on face; and  $E$ , modulus of elasticity in plane of plies. 1 lb/in<sup>2</sup> = 6.894 kPa.

### Structural Flakeboards

**Structural flakeboards** are wood panels made from specially produced flakes—typically from relatively low-density species, such as aspen or pine—and bonded with an exterior-type water-resistant adhesive. Two major types of flakeboards are recognized, **oriented strandboard (OSB)** and **waferboard**. OSB is a flakeboard product made from wood strands (long and narrow flakes) that are formed into a mat of three to five layers. The outer layers are aligned in the long panel direction, while the inner layers may be aligned at right angles to the outer layers or may be randomly aligned. In waferboard, a product made almost exclusively from aspen wafers (wide flakes), the flakes are not usually oriented in any direction, and they are bonded with an exterior-type resin. Because flakes are aligned in OSB, the bending properties (in the aligned direction) of this type of flakeboard are generally superior to those of waferboard. For this reason, OSB is the predominant form of structural flakeboard. Panels commonly range from 0.25 to 0.75 in (6 to 19 mm) thick and 4 by 8 ft (1 by 2 m) in surface dimension. However, thicknesses up to 1.125 in (28.58 mm) and surface dimensions up to 8 by 24 ft (2 by 7 m) are available by special order.

A substantial portion of the market for structural flakeboard is in residential construction. For this reason, structural flakeboards are usually marketed as conforming to a product standard for sheathing or single-layer subfloor or underlayment and are graded as a performance-rated product (PRP-108) similar to that for construction plywood. The Voluntary Product Standard PS 2-92 is the performance standard for wood-based structural-use panels, which includes such products as plywood, composites, OSB, and waferboard. The PS 2-92 is not a replacement for PS 1-83, which contains necessary veneer grade and glue bond requirements as well as prescriptive layup provisions and includes many plywood grades not covered under PS 2-92.

Design capacities of the APA performance-rated products, which include OSB and waferboard, can be determined by using procedures outlined in the APA-EWS *Technical Note* N375A. In this reference, allowable design strength and stiffness properties, as well as nominal thicknesses and section properties, are specified based on the span rating of the panel. Additional adjustment factors based on panel grade and construction are also provided.

Because of the complex nature of structural flakeboards, formulas for determining actual strength and stiffness properties, as a function of the component material, are not available.

### DURABILITY OF WOOD IN CONSTRUCTION

by Rodney De Groot and Robert White

#### Biological Challenge

In the natural ecosystem, wood residues are recycled into the nutrient web through the action of wood-degrading fungi, insects, and other

organisms. These same natural recyclers may pose a practical biological challenge to wood used in construction under conditions where one or more of these microorganisms or insects can thrive. Under those conditions, wood that has natural durability or that has been treated with preservatives should be employed to ensure the integrity of the structure.

Termites are a recognized threat to wood in construction, but decay fungi are equally important. Wood-boring beetles can also be important in some regions of the United States and in certain species of wood products. Several types of marine organisms can attack wood used in brackish and salt waters. Because suppression of established infestations of any of the wood-destroying organisms in existing structures probably would require services of professional pest control specialists, methodologies for remedial treatments to existing structures will not be discussed further.

#### Role of Moisture

Three environmental components govern the development of wood-degrading organisms within terrestrial wood construction: moisture, oxygen supply, and temperature. Of these, moisture content of wood seems most directly influenced by design and construction practices. The oxygen supply is usually adequate except for materials submerged below water or deep within the soil. Temperature is largely a climatic function; within the global ecosystem, a variety of wood-degrading organisms have evolved to survive within the range of climates where trees grow. For these reasons, most of the following discussion will focus on relationships between wood moisture and potential for wood deterioration.

Soil provides a continuing source of moisture. Nondurable wood in contact with the ground will decay most rapidly at the groundline where the moisture from soil and the supply of oxygen within the wood support growth of decay fungi. Deep within the soil, as well as in wood submerged under water, a limited supply of oxygen prevents growth of decay fungi. As the distance from groundline increases above ground, wood dries out and the moisture content becomes limiting for fungal growth, unless wood is wetted through exposure to rain or from water entrapped as a consequence of design and/or construction practices that expose wood to condensate from air conditioners, plumbing failures, etc. Wood absorbs water through exposed, cut ends about 11 times faster than through lateral surfaces. Consequently decay fungi, which require free water within the wood cells (above 20 to 25 percent moisture content) to survive, develop first at the joints in aboveground construction.

#### Naturally Durable Woods

The heartwood of old-growth trees of certain species, such as bald cypress, redwood, cedars, and several white oaks, is naturally resistant or very resistant to decay fungi. Heartwood of several other species,

such as Douglas-fir, longleaf pine, eastern white pine, and western larch, is moderately resistant to wood decay fungi. Similarly, these species are not a wood of choice for subterranean termites. A more complete listing of naturally durable woods is given in "Wood Handbook." These woods historically have been used to construct durable buildings, but some of these species are becoming less available as building materials. Consequently, other forms of protection are more frequently used in current construction. (See section on protection from decay).

#### Methods for Protecting Wood

**Protection with Good Design** The most important aspect to consider when one is protecting structural wood products is their **design**. Many wood structures are several hundred years old, and we can learn from the principles used in their design and construction. For example, in nearly all those old buildings, the wood has been kept dry by a barrier over the structure (roof plus overhang), by maintaining a separation between the ground and the wood elements (foundation), and by preventing accumulation of moisture in the structure (ventilation). Today's engineered wood products will last for centuries if good design practices are used.

**Protection from Weathering** The combination of sunlight and other **weathering agents** will slowly remove the surface fibers of wood products. This removal of fibers can be greatly reduced by providing a wood finish; if the finish is properly maintained, the removal of fibers can be nearly eliminated. Information on wood finishes is available in Cassens and Feist, "Exterior Wood in the South."

**Protection from Decay** As naturally durable woods become less available in the marketplace, greater reliance is being placed on preservative-treated wood. Wood that is treated with a pressure-impregnated chemical is used for most load-bearing applications. In non-load-bearing applications such as exterior millwork around windows and doors, wood is usually protected with water-repellent preservative treatments that are applied by nonpressure processes. Standards for preservative treatment are published by the American Wood-Preservers' Association, and detailed information on wood preservation is given in "Wood Handbook."

An extremely low oxygen content in wood submerged below water will prevent growth of decay fungi, but other microorganisms can slowly colonize submerged wood over decades or centuries of exposure. Thus, properties of such woods need to be reconfirmed when old, submerged structures are retrofitted.

**Protection from Insects** Subterranean **termites**, native to the U.S. mainland, establish a continuous connection with soil to maintain adequate moisture in wood that is being attacked above ground. One fundamental approach most often utilized in the protection of buildings from subterranean termites is to establish a physical or chemical barrier between soil and building. The function of that barrier is to bar access of termites to the building. The use of preservative-treated wood is relied upon to protect wood products such as poles, piling, and bridges that cannot be protected from exposure to termites via other mechanisms.

Formosan termites have the capacity to use sources of aboveground moisture without establishing a direct connection with the soil. Thus, where these termites occur, good designs and construction practices that eliminate sources of aboveground moisture are particularly important.

Dry-wood termites survive only in tropical or neotropical areas with sufficiently high relative humidity to elevate the wood moisture content to levels high enough to provide moisture for insect metabolism. Where these termites occur, use of naturally durable wood or preservative-treated wood warrants consideration.

Wood-destroying beetles may occur in wood members where the ambient moisture content is high enough for them to complete certain phases of their life cycle. Many beetles attack only certain species or groups of woods that may be used in specialty items such as joinery. Consequently, the first step in good construction practice is to use wood that is not preinfested at the time of construction. The next step is to

utilize designs and construction practices that will keep wood at low moisture content in use. Finally, chemical treatments may be needed for certain specific applications.

**Protection from Fire** In general, proper design for fire safety allows the use of untreated wood. When there is a need to reduce the potential for heat contribution or flame spread, **fire-retardant treatments** are available. Although fire-retardant coatings or dip treatments are available, effective treatment often requires that the wood be pressure-impregnated with the fire-retardant chemicals. These chemicals include inorganic salts such as monoammonium and diammonium phosphate, ammonium sulfate, zinc chloride, sodium tetraborate, and boric acid. Resin polymerized after impregnation into wood is used to obtain a leach-resistant treatment. Such amino resin systems are based on urea, melamine, dicyandiamide, and related compounds. An effective treatment can reduce the ASTM E84 flame spread to less than 25. When the external source of heat is removed, the flames from fire-retardant-treated wood will generally self-extinguish. Many fire-retardant treatments reduce the generation of combustible gases by lowering the thermal degradation temperature. Fire-retardant treatments may increase the hygroscopic properties of wood.

**Protection from Marine Organisms** **Pressure treatment** of native wood species with wood preservatives is required to protect wood used in marine or brackish waters from attack by marine borers.

#### Effect of Long-Term Exposure

**Long exposure of wood to the atmosphere** also causes changes in the cellulose. A study by Kohara and Okamoto of sound old timbers of a softwood and hardwood of known ages from temple roof beams shows that the percentage of cellulose decreases steadily over a period up to 1,400 years while the lignin remains almost constant. These changes are reflected in strength losses (Fig. 6.7.4). Impact properties approximate a loss that is nearly linear with the logarithm of time. Allowable working stresses for preservative-treated lumber usually need not be reduced to account for the effect of the treating process. Tests made by the USDA Forest Service, Forest Products Laboratory, of preservative-treated

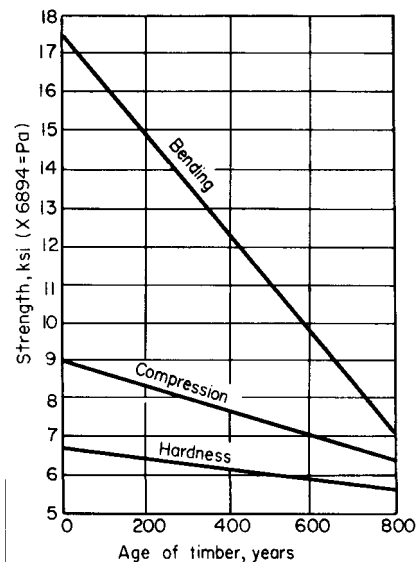

Fig. 6.7.4 Strength loss with age in a hardwood (*Zelkova serrata*). (From Sci. Rpts. Saikyo Univ., no. 7, 1955.)

lumber when undergoing bending, tension, and compression perpendicular to grain show reductions in mean extreme fiber stress from a few percent up to 25 percent, but few reductions in working stresses. Compression parallel to grain is affected less and modulus of elasticity very

little. The effect on horizontal shear can be estimated by inspection for an increase in shakes and checks after treatment. AWP Standards keep temperatures, heating periods, and pressures to a minimum for required penetration and retention, which precludes the need for adjustment in working stresses.

#### COMMERCIAL LUMBER STANDARDS

**Standard abbreviations** for lumber description and **size standards** for yard lumber are given in "Wood Handbook."

Cross-sectional **dimensions** and **section properties** for beams, stringers, joists, and planks are given in the National Design Specification.

**Standard patterns** for finish lumber are shown in publications of the grading rules for the various lumber associations.

Information and **specifications for construction and industrial plywood** are given in Product Standard PS 1-83 and in ANSI/HPVA HP-1-1994 for hardwood and decorative plywood. Information and specifications for structural flakeboard are given in PS 2-92.

## 6.8 NONMETALLIC MATERIALS

by Antonio F. Baldo

### ABRASIVES

REFERENCES: "Abrasives: Their History and Development," The Norton Co. Searle, "Manufacture and Use of Abrasive Materials," Pitman. Heywood, "Grinding Wheels and Their Uses," Penton. "Boron Carbide," The Norton Co. "Abrasive Materials," annual review in "Minerals Yearbook," U.S. Bureau of Mines. "Abrasive Engineering," Hitchcock Publishing Co. Coated Abrasives Manufacturer's Institute, "Coated Abrasives—Modern Tool of Industry," McGraw-Hill. Wick, Abrasives; Where They Stand Today, *Manufacturing Engineering and Management*, 69, no. 4, Oct. 1972. Burls, "Diamond Grinding; Recent Research and Development," Mills and Boon, Ltd., London. Coes, Jr., "Abrasives," Springer-Verlag, New York. *Proceedings of the American Society for Abrasives Methods*, 1971, ANSI B74.1 to B74.3 1977 to 1993. Washington Mills Abrasive Co., Technical Data, *Mechanical Engineering*, Mar. 1984. "Modern Abrasive Recipes," *Cutting Tool Engineering*, April 1994. "Diamond Wheels Fashion Carbide Tools," *Cutting Tool Engineering*, August 1994. Synthetic Gemstones, *Compressed Air Magazine*, June 1993. Krar and Ratterman, "Superabrasives," McGraw-Hill.

#### Manufactured (Artificial) Abrasives

Manufactured abrasives dominate the scene for commercial and industrial use, because of the greater control over their chemical composition and crystal structure, and their greater uniformity in size, hardness, and cutting qualities, as compared with natural abrasives. Technical advances have resulted in abrasive "machining tools" that are economically competitive with many traditional machining methods, and in some cases replace and surpass them in terms of productivity. Fused electrominerals such as silicon carbide, aluminum oxide, alumina zirconia, alumina chromium oxide, and alumina titania zirconia are the most popular conventional **manufactured abrasives**.

#### Grains

Manufactured (industrial or synthetic) **diamonds** are produced from graphite at pressures 29.5 to  $66.5 \times 10^6$  N/m<sup>2</sup> (8 to  $18 \times 10^5$  lb/in<sup>2</sup>) and temperatures from 1,090 to 2,420°C (2,000 to 4,400°F), with the aid of metal catalysts. The shape of the crystal is temperature-controllable, with cubes (black) predominating at lower temperatures and octahedra (yellow to white) at higher. General Electric Co. produces synthetics reaching 0.01 carat sizes and of quality comparable to natural diamond powders. Grade MBG-11 (a blocky powder) is harder and tougher and is used for cutting wheels. Diamond hardness (placed at 10 on the Mohs scale) ranges from 5,500 to 7,000 on the Knoop scale. Specific gravity is 3.521.

Recently, chemical vapor deposition (CVD) has produced diamond vapors at ambient temperatures, which are then deposited on a substrate as a continuous film which may be from 1 to as much as 1,000  $\mu$ m thick. Microscopically, CVD diamond is a dense polycrystalline struc-

ture with discrete diamond grains. Deposition can be directly on tools such as wheels or other surfaces. CVD diamond can be polished to any required surface texture and smoothness.

**Crystalline alumina**, as chemically purified Al<sub>2</sub>O<sub>3</sub>, is very adaptable in operations such as precision grinding of sensitive steels. However, a tougher grain is produced by the addition of TiO<sub>2</sub>, Fe<sub>2</sub>O<sub>3</sub>, SiO<sub>2</sub>, ZrO<sub>2</sub>. The percentage of such additions and the method of cooling the pig greatly influence grain properties. Advantage is taken of this phenomenon to "custom" make the most desirable grain for particular machining needs. Alumina crystals have conchoidal fracture, and the grains when crushed or broken reveal sharp cutting edges and points. Average properties are: density  $\sim 3.8$ , coefficient of expansion  $\sim 0.81 \times 10^{-5}/^\circ\text{C}$  ( $0.45 \times 10^{-5}/^\circ\text{F}$ ), hardness  $\sim 9$  (Mohs scale), and melting temperature  $\sim 2,040^\circ\text{C}$  (3,700°F). Applications cover the grinding of high-tensile-strength materials such as soft and hard steels, and annealed malleable iron.

**Silicon carbide (SiC)** corresponds to the mineral moissanite, and has a hardness of about 9.5 (Mohs scale) or 2,500 (Knoop), and specific gravity 3.2. It is insoluble in acid and is infusible but decomposes above 2,230°C (4,060°F). It is manufactured by fusing together coke and sand in an electric furnace of the resistance type. Sawdust is used also in the batch and burns away, leaving passages for the carbon monoxide to escape. The grains are characterized by great brittleness. Abrasives of silicon carbide are best adapted to the grinding of low-tensile-strength materials such as cast iron, brass, bronze, marble, concrete, stone, and glass. It is available under several trade names such as **Carborundum**, **Carbolon**, **Crystolon**.

**Boron carbide (B<sub>4</sub>C)**, a black crystal, has a hardness of about 9.32 (Mohs scale) or about 2,800 (Knoop), melts at about 2,460°C (4,478°F) but reacts with oxygen above 983°C (1,800°F), and is not resistant to fused alkalis. Boron carbide powder for grinding and lapping is obtainable in standard mesh sizes to 240, and to 800 in special finer sizes. It is being used in loose grain form for the lapping of cemented-carbide tools. In the form of molded shapes, it is used for pressure blast nozzles, wire-drawing dies, bearing surfaces for gages, etc.

**Boron nitride (BN)** when produced at extremely high pressures and temperatures forms tiny reddish to black grains of cubic crystal structure having hardness equal to diamond, and moreover is stable to 1,930°C (3,500°F). Abrasive powders, such as Borazon, are used extensively for coated-abrasive applications as for grinding tool and die steels and high-alloy steels, particularly where chemical reactivity of diamonds is a problem. Ease of penetration and free-cutting action minimize heat generation, producing superior surface integrity.

**Crushed steel** is made by heating high-grade crucible steel to white heat and quenching in a bath of cold water. The fragments are then



crushed to sizes ranging from fine powder to 1/16 in diam. They are classified as diamond crushed steel, diamond steel, emery, and steelite, used chiefly in the stone, brick, glass, and metal trades.

**Rouge and crocus** are finely powdered oxide of iron used for buffing and polishing. Rouge is the red oxide; crocus is purple.

**Natural Abrasives**

**Diamond** of the **bort** variety, crushed and graded into usable sizes and bonded with synthetic resin, metal powder, or vitrified-type bond, is used extensively for grinding tungsten- and tantalum-carbide cutting tools, and glass, stone, and ceramics.

**Corundum** is a mineral composed chiefly of crystallized alumina (93 to 97 percent Al<sub>2</sub>O<sub>3</sub>). It has been largely replaced by the manufactured variety.

**Emery**, a cheap and impure form of natural corundum which has been used for centuries as an abrasive, has been largely superseded by manufactured aluminum oxide for grinding. It is still used to some extent in the metal- and glass-polishing trades.

**Garnet** Certain deposits of garnet having a hardness between quartz and corundum are used in the manufacture of abrasive paper. **Quartz** is also used for this purpose. Garnet costs about twice as much as quartz and generally lasts proportionately longer.

**Buhrstones and millstones** are generally made from cellular quartz. Chasers (or stones running on edge) are also made from the same mineral.

**Natural oilstones**, the majority being those quarried in Arkansas, are of either the hard or the soft variety. The hard variety is used for tools requiring an extremely fine edge like those of surgeons, engravers, and dentists. The soft variety, more porous and coarser, is used for less exacting applications.

**Pumice**, of volcanic origin, is extensively used in leather, felt, and woollen industries and in the manufacture of polish for wood, metal, and stone. An artificial pumice is made from sand and clay in five grades of hardness, grain, and fineness.

**Infusorial earth or tripoli** resembles chalk or clay in physical properties. It can be distinguished by absence of effervescence with acid, is generally white or gray in color, but may be brown or even black. Owing to its porosity, it is very absorptive. It is used extensively in polishing powders, scouring soaps, etc., and, on account of its porous structure, in the manufacture of dynamite as a holder of nitroglycerin, also as a nonconductor for steam pipes and as a filtering medium. It is also known as **diatomaceous silica**.

**Grinding Wheels** For complete coverage and details see current ANSI/ASTM Standards D896 to D3808.

**Vitrified Process** In wheels, segments, and other abrasive shapes of this type, the abrasive grains are bonded with a glass or porcelain obtained by mixing the grains with such materials as clays and feldspars in various proportions, molding the wheel, drying, and firing at a temperature of 1,370°C (2,500°F) approx. It is possible to manufacture wheels as large as 60 in diam by this process, and even larger wheels may be obtained by building up with segments. Most of the grinding wheels and shapes (segments, cylinders, bricks, etc.) now manufactured are of the vitrified type and are very satisfactory for general grinding operations.

**Silicate Process** Wheels and shapes of the silicate type are manufactured by mixing the abrasive grain with sodium silicate (water glass) and fillers that are more or less inert, molding the wheel by tamping, and baking at a moderate temperature. Silicate bonded wheels are considered relatively "mild acting" and, in the form of large wheels, are still used to some extent for grinding-edge tools in place of the old-fashioned sandstone wheels.

**Organic Bonded Wheels** Organic bonds are used for high-speed wheels, and are equally well adapted to the manufacture of very thin wheels because of their flexibility compared with vitrified wheels. There are three distinct types in the group. The **shellac process** consists of mixing abrasive grains with shellac, heating the mass until the shellac is viscous, stirring, cooling, crushing, forming in molds, and reheating sufficiently to permit the shellac to set firmly upon cooling. Wheels made by this process are used for saw gumming, roll grinding, ball-race

and cam grinding, and in the cutlery trade. In the **rubber process** the bond is either natural or synthetic rubber. The initial mixture of grain, rubber, and sulfur (and such special ingredients as accelerators, fillers, and softeners) may be obtained by rolling or other methods. Having formed the wheel, the desired hardness is then developed by vulcanization. Wheels can be made in a wide variety of grain combinations and grades and have a high factor of safety as regards resistance to breakage in service. Wheels made by the rubber process are used for cutoff service on wet-style machines, ball-race punchings, feed wheels and centerless grinders, and for grinding stainless-steel billets and welds, which usually require a high-quality finish. With the **resinoid process**, the practice is to form the wheel by the cold-press process using a synthetic resin. After heating, the resultant bond is an insoluble, infusible product of notable strength and resiliency. Resinoid bond is used for the majority of high-speed wheels in foundries, welding shops, and billet shops, and also for cutoff wheels. The rate of stock removal is generally in direct proportion to the peripheral speed. Resinoid-bonded wheels are capable of being operated at speeds as high as 2,900 m/min (9,500 surface ft/min), as contrasted with 1,980 m/min (6,500 surface ft/min) for most vitrified bonds.

Silicone-coated abrasives, such as Silkote are reported to resist deleterious coolant effects on the bond between resin and grain, because of the silicone's ability to repel entry of coolant.

The **grain size or grit** of a wheel is determined by the size or combination of sizes of abrasive grain used. The Grinding Wheel Institute has standardized sizes 8, 10, 12, 14, 16, 20, 24, 30, 36, 46, 54, 60, 70, 80, 90, 100, 120, 150, 180, 200, 220, and 240. The finer sizes, known as flours, are designated as 280, 320, 400, 500, 600, 800, 900, or as F, FF, FFF, and XF.

The **grade** is the hardness or relative strength of bonding of a grinding wheel. The wheel from which grain particles are easily broken away, causing it to wear rapidly, is called soft, and one that is able to retain its particles longer is called hard. The complete range of grade letters used for the order of increasing hardness is

Soft	Hard
A, B, C, D, E, F, G, H, I, J, K, L, M, N, O, P, Q, R, S, T, U, V, W, X, Y, Z	

Table 6.8.1 provides a guide to surface finishes attainable with diamond grit.

**Table 6.8.1 Guide to Surface Finish Attainable with Diamond Grit**

Grit size	Surface finish		Recommended max DOC* per pass	
	μ in (AA)	μm R <sub>a</sub>	in	μm
80	26-36			
100	24-32			
105	18-30			
100S	16-26	0.4-0.8	0.001-0.002	25-50
110				
120	16-18			
150	14-16			
180	12-14	0.25-0.50	0.0007-0.0010	17-25
220	10-12			
240	8-10			
320	8	0.12-0.25	0.0004-0.0006	10-15
400	7-8	0.08-0.15	0.0003-0.0005	8-12
30-40 μm	7			
20-30	6-7	0.05-0.10	0.0002-0.0004	5-10
	6			
10-20	5-6			
8-16				
6-12	3-5			
4-8	2-4	0.013-0.025	0.00005-0.00007	1-2
3-6	2			
0-2	1			

\* DOC = depth of cut.  
SOURCE: *Cutting Tool Engineering*, Aug. 1994.

### Coated Abrasives

Coated abrasives are “tools” consisting of an abrasive grit, a backing, and an adhesive bond. Grits are generally one of the manufactured variety listed above, and are available in mesh sizes ranging from the coarsest at 12 to the finest at 600. Backings can be cloth, paper, fiber, or combinations and are made in the form of belts and disks for power-operated tools and in cut sheets for both manual and power usage. Adhesive bonds consist of two layers, a “make coat” and a “size coat.” Both natural and synthetic adhesives serve for bond materials. Abrasive coatings can be closed-coat, in which the abrasive grains are adjacent to one another without voids, or open-coat, in which the grains are set at a predetermined distance from one another. The flex of the backing is obtained by a controlled, directional, spaced backing of the adhesive bond.

### Abrasive Waterjets

Such tough-to-cut materials as titanium, ceramics, metallic honeycomb structures, glass, graphite, and bonding compounds can be successfully cut with abrasive waterjets. Abrasive waterjets use pressurized water, up to 60 lb/in<sup>2</sup>, to capture solid abrasives by flow momentum, after which the mixture is expelled through a sapphire nozzle to form a highly focused, high-velocity cutting “tool.” Advantages of this cutting method include: minimal dust, high cutting rates, multidirectional cutting capability, no tool dulling, no deformation or thermal stresses, no fire hazards, ability to cut any material, small power requirements, avoidance of delamination, and reduction of striation. (See also Sec. 13.)

Abrasive waterjet cutting, however, has some limitations including high noise level (80 to 100 dB), safety problems, low material removal rates, inability to machine blind holes or pockets, damage to accidentally exposed machine elements by the particles and/or high-pressure water, and the size of the overall system.

### Industrial Sharpening Stones

Sharpening stones come in several forms such as bench stones, files, rubbing bricks, slip stones, and specialties, and are made chiefly from

aluminum oxide, such as Alundum, or silicon carbide, such as Crystolon. Grit sizes of fine, medium, and coarse are available.

## ADHESIVES

REFERENCES: Cagle (ed.), “Handbook of Adhesive Bonding,” McGraw-Hill. Bikerman, “The Science of Adhesive Joints,” Academic. Shields, “Adhesives Handbook,” CRC Press (Division of The Chemical Rubber Co.). Cook, “Construction Sealants and Adhesives,” Wiley. Patrick, “Treatise on Adhesives,” Marcel Dekker. NASA SP-5961 (01) Technology Utilization, “Chemistry Technology: Adhesives and Plastics,” National Technical Information Services, Virginia. Simonds and Church, “A Concise Guide to Plastics,” Reinhold. Lerner, Kotsher, and Sheckman, “Adhesives Red Book,” Palmerton Publishing Co., New York. *Machine Design*, June 1976. ISO 6354-1982. “1994 Annual Book of ASTM Standards,” vol. 15.06 (Adhesives). ANSI/ASTM Standards D896–D3808.

Adhesives are substances capable of holding materials together in a useful manner by surface attachment. Some of the advantages and disadvantages of adhesive bonding are as follows:

**Advantages** Ability to bond similar or dissimilar materials of different thicknesses; fabrication of complex shapes not feasible by other fastening means; smooth external joint surface; economic and rapid assembly; uniform distribution of stresses; weight reduction; vibration damping; prevention or reduction of galvanic corrosion; insulating properties.

**Disadvantages** Surface preparation; long cure times; optimum bond strength not realized instantaneously, service-temperature limitations; service deterioration; assembly fire or toxicity; tendency to creep under sustained load.

A broad scheme of classification is given in Table 6.8.2a.

For the vocabulary of adhesives the reader should refer to ISO 6354-1982, and for standard definitions refer to ASTM D907-82. Procedures for the testing of adhesive strength viscosity, storage life, fatigue properties, etc. can be found in ANSI/ASTM D950–D3808.

**Thermoplastic adhesives** are a general class of adhesives based upon

Table 6.8.2a Classification of Adhesives

Origin and basic type		Adhesive material
Natural	Animal	Albumen, animal glue (including fish), casein, shellac, beeswax
	Vegetable	Natural resins (gum arabic, tragacanth, colophony, Canada balsam, etc.); oils and waxes (carnauba wax, linseed oils); proteins (soybean); carbohydrates (starch, dextrans)
	Mineral	Inorganic materials (silicates, magnesia, phosphates, litharge, sulfur, etc.); mineral waxes (paraffin); mineral resins (copal, amber); bitumen (including asphalt)
Synthetic	Elastomers	Natural rubber (and derivatives, chlorinated rubber, cyclized rubber, rubber hydrochloride) Synthetic rubbers and derivatives (butyl, polyisobutylene, polybutadiene blends (including styrene and acrylonitrile), polyisoprenes, polychloroprene, polyurethane, silicone, polysulfide, polyolefins (ethylene vinyl chloride, ethylene polypropylene) Reclaim rubbers
	Thermoplastic	Cellulose derivatives (acetate, acetate-butyrate, caprate, nitrate, methyl cellulose, hydroxy ethyl cellulose, ethyl cellulose, carboxy methyl cellulose) Vinyl polymers and copolymers (polyvinyl acetate, alcohol, acetal, chloride, polyvinylidene chloride, polyvinyl alkyl ethers) Polyesters (saturated) [polystyrene, polyamides (nylons and modifications)] Polyacrylates (methacrylate and acrylate polymers, cyanoacrylates, acrylamide) Polyethers (polyhydroxy ether, polyphenolic ethers) Polysulfones
	Thermosetting	Amino plastics (urea and melamine formaldehydes and modifications) Epoxides and modifications (epoxy polyamide, epoxy bitumen, epoxy polysulfide, epoxy nylon) Phenolic resins and modifications (phenol and resorcinol formaldehydes, phenolic-nitrile, phenolic-neoprene, phenolic-epoxy) Polyesters (unsaturated)
		Polyaromatics (polyimide, polybenzimidazole, polybenzothiazole, polyphenylene) Furanes (phenol furfural)

long-chained polymeric structure, and are capable of being softened by the application of heat.

**Thermosetting adhesives** are a general class of adhesives based upon *cross-linked* polymeric structure, and are incapable of being softened once solidified. A recent development (1994) in cross-linked aromatic polyesters has yielded a very durable adhesive capable of withstanding temperatures of 700°F before failing. It retains full strength through 400°F. It is likely that widespread applications for it will be found first in the automotive and aircraft industries.

Thermoplastic and thermosetting adhesives are cured (set, polymerized, solidified) by heat, catalysis, chemical reaction, free-radical activity, radiation, loss of solvent, etc., as governed by the particular adhesive's chemical nature.

**Elastomers** are a special class of thermoplastic adhesive possessing the common quality of substantial flexibility or elasticity.

**Anaerobic adhesives** are a special class of thermoplastic adhesive (polyacrylates) that set *only* in the *absence* of air (oxygen). The two basic types are: (1) *machinery*—possessing shear strength only, and (2) *structural*—possessing both tensile and shear strength.

**Pressure-sensitive adhesives** are permanently (and aggressively) tacky (sticky) solids which form immediate bonds when two parts are brought together under pressure. They are available as films and tapes as well as hot-melt solids.

The relative performance of a number of adhesives is given in Table 6.8.2b.

For high-performance adhesive applications (engineering or machine parts) the following grouping is convenient.

Thread locking	Anaerobic acrylic
Hub mounting	Anaerobic acrylic—compatible materials or flow migration unimportant.
	Modified acrylic—large gaps or migration must be avoided.
	Epoxy—maximum strength at high temperatures

Bearing mounting	Anaerobic acrylic—compatible materials necessary and flow into bearing area to be prevented.
Structural joining	Modified acrylic—for lowest cost Epoxy and modified epoxies—for maximum strength (highest cost)
Gasketing	Acrylics—anaerobic or modified cyanacrylates Silicones—primarily anaerobic

Table 6.8.3 presents a sample of a number of adhesives (with practical information) that are available from various sources. The table is adapted from the rather extensive one found in J. Shields, "Adhesives Handbook," CRC Press (Division of The Chemical Rubber Co.), 1970, by permission of the publisher. Domestic and foreign trade sources are listed there (pages 332–340) and appear coded (in parentheses) in the second column. For other extensive lists of trade sources, the reader is referred to Charles V. Cagle (ed.), "Handbook of Adhesive Bonding," McGraw-Hill, and "Adhesives Red Book," Palmerton Publishing Co., New York.

### BRICK, BLOCK, AND TILE

REFERENCES: Plummer and Reardon, "Principles of Brick Engineering, Handbook of Design," Structural Clay Products Institute. Stang, Parsons, and McBurney, Compressive Strength of Clay Brick Walls, *B. of S. Research Paper* 108. Hunting, "Building Construction," Wiley. Amrhein, "Reinforced Masonry Engineering Handbook," Masonry Institute of America. Simpson and Horbin (eds.), "The Weathering and Performance of Building Materials," Wiley. SVCE and Jeffers (eds.), "Modern Masonry Panel Construction Systems," Cahners Books (Division of Cahners Publishing Co.). ASTM Standards C67-C902. ANSI/ASTM Standards C62-C455.

### Brick

In the case of structural and road building material, a small unit, solid or practically so, commonly in the form of a rectangular prism, formed

**Table 6.8.2b Performance of Adhesive Resins**  
(Rating 1 = poorest or lowest, 10 = best or highest)

Adhesive resin	Adherence to					Resistance			
	Paper	Wood	Metal	Ceramics	Rubbers	Water	Solvents	Alkali	Acids
Alkyd	6	7	5	6	7	7	2	2	5
Cellulose acetate	4	3	1	3	5	2	3	1	3
Cellulose acetate butyrate	3	3	1	4	5	2	3	1	3
Cellulose nitrate	5	5	1	5	5	3	2	2	4
Ethyl cellulose	3	3	1	3	5	2	3	3	3
Methyl cellulose	5	1	1	3	3	1	6	3	3
Carboxy methyl cellulose	6	1	2	3	2	1	6	1	4
Epoxy resin	10	10	8	8	8	8	9	9	8
Furane resin	8	7	1	8	7	8	9	10	8
Melamine resin	10	10	2	2	2	7	9	5	5
Phenolic resins	9	8	2	6	7	8	10	7	8
Polyester, unsaturated	6	8	2	5	7	7	6	1	6
Polyethylacrylate	3	4	3	5	6	8	2	6	7
Polymethylmethacrylate	2	3	2	3	6	8	3	8	7
Polystyrene	1	3	2	2	5	8	1	10	8
Polyvinylacetate	8	7	7	7	3	3	3	4	6
Polyvinyl alcohol	6	2	2	4	6	1	7	1	3
Polyvinyl acetal	5	7	8	7	7	8	5	3	5
Polyvinyl chloride	5	7	6	7	6	8	6	10	9
Polyvinyl acetate chloride	6	8	6	7	5	8	5	9	9
Polyvinylidene copolymer	4	7	6	7	7	8	7	10	9
Silicone T.S.	4	6	7	7	8	10	7	6	6
Urethane T.S.	8	10	10	9	10	7	8	4	4
Acrylonitrile rubber	3	6	8	6	9	7	5	8	8
Polybutene rubber	3	3	6	2	8	8	3	10	9
Chlorinated rubber	3	5	7	4	7	6	3	10	9
Styrene rubber	5	7	6	5	8	7	3	10	9

Table 6.8.3 Properties and Uses of Various Adhesives

Basic type	Curing cycle, time at temp	Service temp range, °C	Adherends	Main uses	Remarks
Animal					
Animal (hide)	Melted at 70–75°C. Sets on cooling		Paper, wood, textiles	Woodworking, carpet materials, paper, bookbinding	May be thinned with water
Animal (hide) + plasticizers	Applied as a melt at 60°C	<60	Paper, cellulosic materials	Bookbinding, stationery applications	Cures to permanent flexible film
Fish glue	1 h at 20°C	60	Wood, chipboard, paper	General-purpose for porous materials	Rapid setting. Good flexibility Moderate resistance to water. High tack.
Casein	Cold setting after 20-min standing period on mixing		Timber with moisture content	Laminated timber arches and beams, plybox beams, and engineering timber work	Full bond strength developed after seasoning period of 48 h
Casein + 60% latex	Cold setting after 20-min standing period on mixing		Aluminum, wood, phenolic formaldehyde (rigid), leather, rubber	Bonding of dissimilar materials to give flexible, water-resistant bond	Flexible
Vegetable					
Dextrine	Air drying		Paper, cardboard, leather, wood, pottery	General-purpose glue for absorbent materials	Medium drying period of 2–3 h
Dextrine-starch blend	Applied above 15°C air drying	48	Cellulosic materials, cardboard, paper	Labeling, carton sealing, spiral-tube winding	Fast setting. May be diluted with water
Gum arabic	Cold setting		Paper, cardboard	Stationery uses	Fast drying
Mineral					
Silicate	8 h at 20°C	10–430	Asbestos, magnesia	Lagging asbestos cloth on high-temperature insulation	Unsuitable where moisture: not recommended for glass or painted surfaces
Silicate with china-clay filler	Dried at 80°C before exposure to heat	–180–1,500	Asbestos, ceramics, brickwork, glass, silver, aluminum, steel (mild)-steel	General-purpose cement for bonding refractory materials and metals. Furnace repairs and gastight jointing of pipe work. Heat-insulating materials	Resistant to oil, gasoline, and weak acids
Sodium silicate	Dried at 20–80°C before exposure to heat	0–850	Aluminum (foil), paper, wood-wood	Fabrication of corrugated fiberboard. Wood bonding, metal foil to paper lamination	Suitable for glass-to-stone bonding
Aluminum phosphate + silica filler	Dried ½ h at 20°C, then ½ h at 70°C + ½ h at 100°C + 1 h at 200°C + 1 h at 250°C. Repeat for 2 overcoatings and finally cure 1 h at 350°C	750	Steels (low-alloy), iron, brass, titanium, copper, aluminum	Strain-gage attachment to heat-resistant metals. Heater-element bonding	Particularly suited to heat-resistant steels where surface oxidation of metal at high temperatures is less detrimental to adhesion
Bitumen/latex emulsion	Dried in air to a tacky state	0–66	Cork, polystyrene (foam), polyvinyl chloride, concrete, asbestos	Lightweight thermal-insulation boards, and preformed sections to porous and nonporous surfaces. Building applications	Not recommended for constructions operated below 0°C
Elastomers					
Natural rubber	Air-dried 20 min at 20°C and heat-cured 5 min at 140°C		Rubber (styrene butadiene), rubber (latex), aluminum, cardboard, leather, cotton	Vulcanizing cement for rubber bonding to textiles and rubbers	May be thinned with toluene
Natural rubber in hydrocarbon solvent	Air-dried 10 min at 20°C and heat-cured for 20 min at 150°C	100	Hair (keratin), bristle, polyamide fiber	Brush-setting cement for natural- and synthetic-fiber materials	Resistant to solvents employed in oil, paint and varnish industries. Can be nailed without splitting
Rubber latex	Air drying within 15 min		Canvas, paper, fabrics, cellulosic materials	Bonding textiles, papers, packaging materials. Carpet bonding	Resistant to heat. Should be protected from frosts, oils
Chlorinated rubber in hydrocarbon solvents	Air-dried 10 min at 20°C and contact bonded	–20–60	Polyvinyl chloride acrylonitrile butadiene styrene, polystyrene, rubber, wood	General-purpose contact adhesive	Resistant to aging, water, oils, petroleum

Table 6.8.3 Properties and Uses of Various Adhesives (Continued)

Basic type	Curing cycle, time at temp	Service temp range, °C	Adherends	Main uses	Remarks
Elastomers (Continued)					
Styrene-butadiene rubber lattices	Air drying		Polystyrene (foam), wood, hardboard, asbestos, brickwork	Bonding polystyrene foams to porous surface	
Neoprene/nitrile rubbers in	Dried 30 min in air and bonded under pressure while tacky		Wood, linoleum, leather, paper, metals, nitrile rubbers, glass, fabrics	Cement for bonding synthetic rubbers to metals, woods, fabrics	May be thinned with ketones
Acrylonitrile rubber + phenolic resin	Primer air-dried 60 min at 20°C film cured 60 min at 175°C under pressure. Pressure released on cooling at 50°C	- 10-130	Aluminum (alloy)-aluminum to DTD 746	Metal bonding for structural applications at elevated temperatures	Subject to creep at 150°C for sustained loading
Polysulfide rubber in ketone solvent and catalyst	3 days at 25°C	- 50-130, withstands higher temps. for short periods	Metals	Sealant for fuel tanks and pressurized cabins in aircraft, where good weatherproof and waterproof properties are required	Resistant to gasoline, oil, hydraulic fluids, ester lubricants. Moderate resistance to acids and alkalies
Silicone rubber	24 h at 20°C (20% R.H.). Full cure in 5 days	- 65-260	Aluminum, titanium, steel (stainless), glass, cork, silicone rubber, cured rubber-aluminum, cured rubber-titanium, cured rubber-steel (stainless), aluminum-aluminum (2024 Alclad), cork-cork (phenolic bonded)	General-purpose bonding and sealing applications. Adhesive/sealant for situations where material is expected to support considerable suspended weight. High pressure exposure conditions	Resistant to weathering and moisture
Reclaim rubber	Contact bonded when tacky		Fabric, leather, wood, glass, metals (primed)	General industrial adhesive for rubber, fabric, leather, porous materials	May be thinned with toluene
Polychloroprene	Air-dried 10-20 min at 20°C		Rubber, steel, wood, concrete	Bonding all types of rubber flooring to metals, woods, and masonry	Good heat resistance
Modified polyurethane	3 h at 18°C to 16 h at - 15°C	- 80-110	Concrete, plaster, ceramics, glass, hardboards, wood, polyurethane (foam), phenol formaldehyde (foam), polystyrene (foam), copper, lead, steel, aluminum	Bonding rigid and semirigid panels to irregular wall surfaces, wall cladding and floor laying. Building industry applications	Foam remains flexible on aging even at elevated temperatures. Will withstand a 12% movement
Thermoplastic					
Nitrocellulose in ester solvent	Heat set 1 h at 60°C after wet bonding	60	Paper, leather, textiles, silicon carbide, metals	Labeling, general bonding of inorganic materials including metals	Good resistance to mineral oils
Modified methyl cellulose	Dries in air		Vinyl-coated paper, polystyrene foam	Heavy-duty adhesive. Decorating paper and plastics	Contains fungicide to prevent biodeterioration
Ethylene vinyl acetate copolymer + resins	Film transfer at 70-80°C followed by bonding at 150-160°C	60 or 1 h at 90	Cotton (duck)-cotton, resin rubber-leather, melamine laminate—plywood, steel (mild)-steel, acrylic (sheet)-acrylic	Metals, laminated plastics, and textiles. Fabrication of leather goods. Lamination work	Good electrical insulation
Polyvinyl acetate	Rapid setting		Paper, cardboard	Carton sealing in packaging industry	Resistant to water
Synthetic polymer blend	Applied as a melt at 177°C	71	Paper, cardboard, polythene (coated materials)	Carton and paper-bag sealing. Packaging	Resistant to water
Polychloroprene/resin blend in solvent	Air-dried 10 min at 20°C and cured 4 days at 20°C to 7 h at 75°C		Chlorosulfonated polythene, polychloroprene fabrics, polyamide fabrics, leather, wood, textiles	Bonding synthetic rubbers and porous materials. Primer for polyamide-coated fabrics such as nylon, terylene	
Polychloroprene	Air-dried 10-20 min at 20°C		Rubber, steel, wood, concrete	Bonding all types of rubber flooring to metals, woods, and masonry	Good heat resistance
Saturated polyester + isocyanate catalyst in ethyl acetate	Solvent evaporation and press cured at 40-80°C when tacky		Cellulose, cellulose acetate, polyolefins (treated film), polyvinyl chloride (rigid), paper, aluminum (foil), copper (foil)	Lamination of plastic films to themselves and metal foils for packaging industry, printed circuits	Resistant to heat, moisture, and many solvents

Table 6.8.3 Properties and Uses of Various Adhesives (Continued)

Basic type	Curing cycle, time at temp	Service temp range, °C	Adherends	Main uses	Remarks
Thermoplastic (Continued)					
Cyanoacrylate (anaerobic)	15 s to 10 min at 20°C substrate-dependent	Melts at 165	Steel-steel, steel-aluminum, aluminum-aluminum, butyl rubber-phenolic	Rapid assembly of metal, glass, plastics, rubber components	Anaerobic adhesive. Curing action is based on the rapid polymerization of the monomer under the influence of basic catalysts. Absorbed water layer on most surfaces suffices to initiate polymerization and brings about bonding
Polyacrylate resin (anaerobic)	3 min at 120°C to 45 min at 65°C or 7 days at 20°C	-55-95	Aluminum-aluminum	Assembly requirements requiring high resistance to impact or shock loading. Metals, glass, and thermosetting plastics	Anaerobic adhesive
Thermosetting					
Urea formaldehyde	9 h at 10°C to 1 h at 21°C after mixing powder with water (22%)		Wood, phenolic laminate	Wood gluing and bonding on plastic laminates to wood. Plywood, chipboard manufacture. Boat building and timber engineering	Excess glue may be removed with soapy water
Phenolic formaldehyde + catalyst PX-2Z	Cold setting		Wood	Timber and similar porous materials for outdoor-exposure conditions. Shop fascia panels	Good resistance to weathering and biodeterioration
Resorcinol formaldehyde + catalyst RXS-8	Cured at 16°C to 80°C under pressure		Wood, asbestos, aluminum, phenolic laminate, polystyrene (foam), polyvinyl chloride, polyamide (rigid)	Constructional laminates for marine craft. Building and timber applications. Aluminum-plywood bonding. Laminated plastics	Recommended for severe outdoor-exposure conditions
Epoxy resin + catalyst	24-48 h at 20°C to 20 min at 120°C	100	Steel, glass, polyester-glass fiber composite, aluminum-aluminum	General-purpose structural adhesive	
Epoxy resin + catalyst	8 h at 24°C to 2 h at 66°C to 45 min at 121°C	65	Steel, copper, zinc, silicon carbide, wood, masonry, polyester-glass fiber composite, aluminum-aluminum	Bonding of metals, glass, ceramics, and plastic composites	Cures to strong, durable bond
Epoxy + steel filler (80% w/w)	1-2 h at 21°C	120	Iron, steel, aluminum, wood, concrete, ceramics, aluminum-aluminum	Industrial maintenance repairs. Metallic tanks, pipes, valves, engine casings, castings	Good resistance to chemicals, oils, water
Epoxy + amine catalyst (ancamine LT)	2-7 days at 20°C for 33% w/w catalyst content	-5-60	Concrete, stonework	Repair of concrete roads and stone surfaces	Excellent pigment-wetting properties. Effective under water and suited to applications under adverse wet or cold conditions
Epoxy resin (modified)	4-5 h at 149°C to 20 min at 230°C to 7 min at 280°C	150	Aluminum, steel, ceramics	One-part structural adhesive for high-temperature applications	Good gap-filling properties for poorly fitting joints. Resistant to weather, galvanic action
Epoxy	45 s at 20°C		Gem stones, glass, steel, aluminum-aluminum	Rapid assembly of electronic components, instrument parts, printed circuits. Stone setting in jewelry, and as an alternative to soldering	
Epoxy resin in solvent + catalyst	8 h at 52°C to ½ h at 121°C	-270-371	Aluminum and magnesium alloys for elevated-temperature service	Strain gages for cryogenic and elevated-temperature use. Micro measurement strain gages	Cured material resists outgassing in high vacuum
Epoxy polyamide	8 h at 20°C to 15 min at 100°C	100	Copper, lead, concrete, glass, wood, fiberglass, steel-steel, aluminum-aluminum	Metals, ceramics, and plastics bonding. Building and civil engineering applications	Resists water, acids, oils, greases

Table 6.8.3 Properties and Uses of Various Adhesives (Continued)

Basic type	Curing cycle, time at temp	Service temp range, °C	Adherends	Main uses	Remarks
Thermosetting (Continued)					
Epoxy/polysulfide	24 h at 20°C to 3 h at 60°C to 20 min at 100°C		Asbestos (rigid), ceramics, glass-fiber composites, carbon, polytetrafluoroethylene (treated), polyester (film), polystyrene (treated), rubber (treated), copper (treated), tungsten carbide, magnesium alloys, aluminum-aluminum, steel (stainless)-steel	Cold-setting adhesive especially suitable for bonding materials with differing expansion properties	Cures to flexible material. Resistant to water, petroleum, alkalis, and mild acids
Phenol furfural + acid catalyst	2 days at 21°C		Alumina, carbon (graphite)	Formulation of chemically resistant cements. Bedding and joining chemically resistant ceramic tiles	Extremely resistant to abrasion and heat
Pressure-sensitive					
	Heated by air drying for several hours or 15–30 min at 210°F		Teflon-Teflon, Teflon-metal		Good resistance to acids and alkalis. Excellent electrical properties
Miscellaneous					
Ceramic-based	Dried for ½ h at 77°C and cured ½ h at 100°C + 1 h at 200°C + 1 h at 250°C. Postcured, 1 h at 350°C	816	Metals	Strain gages, temperature sensors for elevated-temperature work	

SOURCE: Adapted from J. Shields, "Adhesives Handbook," CRC Press (Division of The Chemical Rubber Co., 1970), with the permission of the publisher.

from inorganic, nonmetallic substances and hardened in its finished shape by heat or chemical action. Note that the term is also used collectively for a number of such units, as "a carload of brick." In the present state of the art, the term brick, when used without a qualifying adjective, should be understood to mean such a unit, or a collection of such units, made from clay or shale hardened by heat. When other substances are used, the term brick should be suitably qualified unless specifically indicated by the context.

It is recognized that unless suitably qualified, a brick is a unit of burned clay or shale.

**Brick (Common)** Any brick made primarily for building purposes and not especially treated for texture or color, but including clinker and oven-burn brick.

**Brick (Facing)** A brick made especially for facing purposes, usually treated to produce surface texture or made of selected clays or otherwise treated to produce the desired color.

Brick are manufactured by the dry-press, the stiff-mud, or the soft-mud process. The **dry-press brick** are made in molds under high pressure and from relatively dry clay mixes. Usually all six surfaces are smooth and even, with geometrical uniformity. The **stiff-mud brick** are made from mixes of clay or shale with more moisture than in the dry-press process, but less moisture than used in the soft-mud process. The clay is extruded from an auger machine in a ribbon and cut by wires into the required lengths. These brick may be side-cut or end-cut, depending on the cross section of the ribbon and the length of the section cut off. The two faces cut by wires are rough in texture; the other faces may be smooth or artificially textured. The **soft-mud process** uses a wet mix of clay which is placed in molds under slight pressure.

Brick are highly resistant to freezing and thawing, to attacks of acids and alkalis, and to fire. They furnish good thermal insulation and good insulation against sound transference.

**Paving brick** are made of clay or shale, usually by the stiff-mud or dry-press process. Brick for use as paving brick are burned to vitrification. The common requirements are as follows: size,  $8\frac{1}{2} \times 2\frac{1}{2} \times 4$ ,  $8\frac{1}{2} \times 3 \times 3\frac{1}{2}$ ,  $8\frac{1}{2} \times 3 \times 4$ , with permissible variations of  $\frac{1}{8}$  in in either transverse dimension, and  $\frac{1}{4}$  in in length.

Although brick have always been used in construction, their use has been limited, until recently, to resisting compressive-type loadings. By adding steel in the mortar joints to take care of tensile stresses, **reinforced brick masonry** extends the use of brick masonry to additional types of building construction such as floor slabs.

**Sand-lime brick** are made from a mixture of sand and lime, molded under pressure and cured under steam at 200°F. They are usually a light gray in color and are used primarily for backing brick and for interior facing.

**Cement brick** are made from a mixture of cement and sand, manufactured in the same manner as sand-lime brick. In addition to their use as backing brick, they are used where there is no danger of attack from acid or alkaline conditions.

**Firebrick** (see this section, Refractories).

**Specialty Brick** A number of types of specialty brick are available for important uses, particularly where refractory characteristics are needed. These include **alumina brick**, **silicon carbide brick**, and **boron carbide brick**.

**Other Structural Blocks** Important structural units which fall outside the classic definition of brick are as follows: **Concrete blocks** are made with portland cement as the basic binder. Often, these are referred to as **concrete masonry units** (CMUs). The choice of aggregate ranges from relatively dense aggregate such as small crushed stone, small gravel, or coal cinders (the latter, if available) to light aggregate such as sand, limestone tailings, or the like. **Gypsum blocks** are generally used for fire protection in non-load-bearing situations. **Glass blocks** are available where transparency is desired. **Structural clay tile** is widely used in both load-bearing and non-load-bearing situations; a variety of complex shapes are available for hollow-wall construction. For classification of all these products with respect to dimensions and specifications for usage, the references should be consulted.

Brick and block can come with porcelain glazed finish for appearance, ease of cleaning, resistance to weathering, corrosion, etc.

**Brick panels** (prefabricated brick walls) are economic and find extensive use in modern high-rise construction. Such panels can be constructed on site or in factories.

New tile units requiring no mortar joint, only a thin epoxy line, form walls which resemble brick and can be installed three times as fast as conventional masonry.

For further definitions relating to structural clay products, the reader is referred to ANSI/ASTM C43-70(75).

See Table 6.8.4 for brick properties.

## CERAMICS

REFERENCES: Kingery, "Introduction to Ceramics," Wiley. Norton, "Elements of Ceramics," Addison-Wesley. "Carbon Encyclopedia of Chemical Technology," Interscience. Humenik, "High-Temperature Inorganic Coatings," Reinhold. Kingery, "Ceramic Fabrication Processes," MIT. McCreight, Rauch, Sr., Sutton, "Ceramic and Graphite Fibers and Whiskers: A Survey of the Technology," Academic. Rauch, Sr., Sutton, McCreight, "Ceramic Fibers and Fibrous Composite Materials," Academic. Hague, Lynch, Rudnick, Holden, Duckworth (compilers and editors), "Refractory Ceramics for Aerospace; A Material Selection Handbook," The American Ceramic Society. Waye, "Introduction to Technical Ceramics," MacLaren and Sons, Ltd., London. Hove and Riley, "Ceramics for Advanced Technologies," Wiley. McMillan, "Glass-Ceramics," Academic. *Machine Design*, May 1983. "1986 Annual Book of ASTM Standards," vols. 15.02, 15.04 (Ceramics).

Ceramic materials are a diverse group of nonmetallic, inorganic solids with a wide range of compositions and properties. Their structure may be either crystalline or glassy. The desired properties are often achieved by high-temperature treatment (firing or burning).

**Traditional ceramics** are products based on the silicate industries, where the chief raw materials are naturally occurring minerals such as the clays, silica, feldspar, and talc. While silicate ceramics dominate the industry, newer ceramics, sometimes referred to as **electronic** or **technical** ceramics, are playing a major role in many applications. **Glass ceramics** are important for electrical, electronic, and laboratory-ware uses. Glass ceramics are melted and formed as glasses, then converted, by controlled nucleation and crystal growth, to polycrystalline ceramic materials.

**Manufacture** Typically, the manufacture of traditional-ceramic products involves blending of the finely divided starting materials with water to form a plastic mass which can be formed into the desired shape. The plasticity of clay constituents in water leads to excellent forming properties. Formation processes include extrusion, pressing, and ramming. Unsymmetrical articles can be formed by "slip-casting" techniques, where much of the water is taken up by a porous mold. After the water content of formed articles has been reduced by drying, the ware is **fired** at high temperature for fusion and/or reaction of the components and for attainment of the desired properties. Firing temperatures can usually be considerably below the fusion point of the pure components through the use of a **flux**, often the mineral feldspar. Following burning, a vitreous ceramic coating, or **glaze**, may be applied to render the surface smooth and impermeable.

Quite different is the **fusion casting** of some refractories and refractory

blocks and most glasses, where formation of the shaped article is carried out after fusion of the starting materials.

**Properties** The physical properties of ceramic materials are strongly dependent on composition, microstructure (phases present and their distribution), and the history of manufacture. Volume pore concentration can vary widely (0 to 30 percent) and can influence shock resistance, strength, and permeability. Most traditional ceramics have a glassy phase, a crystalline phase, and some porosity. The last can be eliminated at the surface by **glazing**. Most ceramic materials are resistant to large compressive stresses but fail readily in tension. Resistance to abrasion, heat, and stains, chemical stability, rigidity, good weatherability, and brittleness characterize many common ceramic materials.

**Products** Many traditional-ceramic products are referred to as **whiteware** and include pottery, semivitreous wares, electrical porcelains, sanitary ware, and dental porcelains. Building products which are ceramic include brick and structural tile and conduit, while refractory blocks, as well as many abrasives, are also ceramic in nature. Porcelain **enamels** for metals are opacified, complex glasses which are designed to match the thermal-expansion properties of the substrate. Important **technical ceramics** include magnetic ceramics, with magnetic properties but relatively high electrical resistance; nuclear ceramics, including uranium dioxide fuel elements; barium titanate as a material with very high dielectric constant. Several of the pure oxide ceramics with superior physical properties are being used in electrical and missile applications where high melting and deformation temperatures and stability in oxygen are important. Fibrous ceramic composed of zirconium oxide fibers, such as Zircar, provide optimum combination of strength, low thermal conductivity, and high temperature resistance to about 2,490°C (4,500°F). Partially stabilized zirconia, because of its steel-strong and crack-resisting properties, is finding high-temperature applications, for example, in diesel engines.

Various forms of ceramics are available from manufacturers such as paper, "board," blankets, tapes, and gaskets.

A fair amount of development is under way dealing with **reinforcing ceramics** to yield **ceramic matrix composite** materials. The driving interest here is potential applications in high-temperature, high-stress environments, such as those encountered in aircraft and aerospace structural components. None of the end products are available yet "off the shelf," and applications are likely to be quite circumscribed and relegated to solution of very specialized design problems.

**Ceramic inserts** suitably shaped and mechanically clamped in tool holders are applied as cutting tools, and they find favor especially for cutting abrasive materials of the type encountered in sand castings or forgings with abrasive oxide crusts. They offer the advantage of resisting abrasion at high tool/chip interface temperatures, and consequently they exhibit relatively long tool life between sharpenings. They tend to be somewhat brittle and see limited service in operations requiring interrupted cuts; when they are so applied, tool life between sharpenings is very short.

**Table 6.8.4 Building Brick Made from Clay or Shale**  
(Standard specifications, ANSI/ASTM C62-81)

Designation*	Min compressive strength (brick flatwise), lb/in <sup>2</sup> gross area		Max water absorption by 5-h boil, %		Max saturation coefficient†	
	Avg of 5	Indiv.	Avg of 5	Indiv.	Avg of 5	Indiv.
Grade SW	3,000	2,500	17.0	20.0	0.78	0.80
Grade MW	2,500	2,200	22.0	25.0	0.88	0.90
Grade NW	1,500	1,250	No limit		No limit	

\* Grade SW includes brick intended for use where a high degree of resistance to frost action is desired and the exposure is such that the brick may be frozen when permeated with water.

Grade MW includes brick intended for use where exposed to temperatures below freezing but unlikely to be permeated with water or where a moderate and somewhat nonuniform degree of resistance to frost action is permissible.

Grade NW includes brick intended for use as backup or interior masonry, or if exposed, for use where no frost action occurs; or if frost action occurs, where the average annual precipitation is less than 20 in.

† The saturation coefficient is the ratio of absorption by 24 h submersion in cold water to that after 5 h submersion in boiling water.



## CLEANSING MATERIALS

REFERENCES: McCutcheon, "Detergents and Emulsifiers," McCutcheon, Inc. Schwartz, Perry, and Berch, "Surface Active Agents and Detergents," Interscience. *ASTM Special Tech. Pub.* 197. Niven, "Industrial Detergency," Reinhold. McLaughlin, "The Cleaning, Hygiene, and Maintenance Handbook," Prentice-Hall. Hackett, "Maintenance Chemical Specialties," Chemical Publishing Co. Bennett (ed.), "Cold Cleaning with Halogenated Solvents," *ASTM Special Technical Publication* 403, 1966. ANSI/ASTM D459, D534-1979 (definitions and specifications).

Cleansing is the removal of dirt, soil, and impurities from surfaces of all kinds. Means of soil attachment to the surface include simple entrapment in interstices, electrostatically held dirt, wetting of the surface with liquid soils, and soil-surface chemical reaction. A variety of cleansing systems has been developed which are difficult to classify since several soil-removal mechanisms are often involved. A liquid suspending medium, an active cleansing agent, and mechanical action are usually combined. The last may involve mechanical scrubbing, bath agitation, spray impingement, or ultrasonic energy. Cleansing involves detachment from the surface, suspension of solids or emulsification of liquids, or dissolution, either physical or by chemical reaction.

### Organic Solvents

Both **petroleum solvents** (mineral spirits or naphtha) and **chlorinated hydrocarbons** (trichloroethylene and perchloroethylene) are used to remove solvent-soluble oils, fats, waxes, and greases as well as to flush away insoluble particles. Petroleum solvents are used in both soak-tank and spray equipment. Chlorinated hydrocarbons are widely used in vapor degreasing (where the metal stock or part is bathed in the condensing vapor), their high vapor density and nonflammability being advantageous. Solvent recovery by distillation can be used if the operation is of sufficient size. Both solvent types are used in garment **dry cleaning** with solvent-soluble detergents.

**Fluorocarbons** such as UCON solvent 113-LRI (trichlorotrifluoroethane) are nonflammable and are ideal for critical cleaning of mechanical electrical and electronic equipment, especially for white-room conditions.

Fluorocarbon solvents are highly proscribed and regulated and are to be used only with utmost care, under close supervision and accountable control. The reader should become familiar with the several references pertaining to health hazards of industrial materials listed under Chlorinated Solvents in this section.

**Emulsifiable solvent** cleaners contain a penetrating solvent and dissolved emulsifying agent. Following soaking, the surface is flushed with hot water, the resulting emulsion carrying away both soil and solvent. These cleaners are usually extended with kerosinelike solvents.

### Alkali Cleansers

Alkali cleansers are water-soluble inorganic compounds, often strong cleansers. Carbonates, phosphates, pyrophosphates, and caustic soda are common, with numerous applications in plant maintenance, material processing, and process-water treatment. Cleansing mechanisms vary from beneficial water softening and suspension of solids to chemical reaction in the solubilization of fats and oils. Certain of these compounds are combined with **detergents** to improve efficiency; these are referred to as **builders**. Boiler and process equipment scales can sometimes be controlled or removed with selected alkali cleansers.

### Synthetic Detergents

Detergents concentrate strongly at a solid-liquid or liquid-liquid interface and are thus characterized as **surface active**. In contrast to soaps, they can be tailored to perform over a wide range of conditions of temperature, acidity, and presence of dissolved impurities with little or no foaming. Detergents promote **wetting** of the surface by the suspending medium (usually water), **emulsification** of oils and greases, and **suspension** of solids without redeposition, the last function being the prime criterion of a good detergent. Detergents are classified as **anionic** (nega-

tively charged in solution), **cationic** (positively charged), and **nonionic**. Germicidal properties may influence detergent choice.

For specific applications, the supplier should be consulted since there is a large variety of available formulations and since many detergent systems contain auxiliary compounds which may be diluents, foam promoters, or alkali chemicals. Additives are designed for pH control, water softening, and enhanced suspending power. Formulations have been developed for cleaning food and dairy process equipment, metals processing, metal cleaning prior to electroplating, textile fiber and fabric processing, and industrial building maintenance. Strong, improperly selected detergent systems can cause deterioration of masonry or marble floors, aluminum window frames, water-based paints, and floor tiles, whereas detergents matched to the job at hand can result in increased plant efficiency.

**Soaps**, the oldest surface-active cleansers, lack the versatility of synthetic detergents but are widely used in the home and in the laundry industry. Properties depend on the fat or oil and alkali used in their preparation and include solvent-soluble soaps for dry cleaning.

**Chemical cleaners** which attack specific soils include dilute acid for metal oxide removal, for the cleaning of soldered or brazed joints, and for the removal of carbonate scale in process equipment. Oxalic acid (usually with a detergent) is effective on rust.

**Chelating agents** are organic compounds which complex with several metal ions and can aid in removal of common boiler scales and metal oxides from metal surfaces.

**Steam cleaning** in conjunction with a detergent is effective on grease-laden machinery.

There are numerous cleansers for the **hands**, including Boraxo, soap jelly and sawdust, lard for loosening oil grime, and linseed oil for paints; repeated use of solvents can be hazardous.

**Alcohol ethoxylates** are nonionic surfactants suitable for use in the formulation of maintenance and institutional cleaners. Products such as Tergitol and Neodol 23-6.5 serve in the formulation of liquid detergents for household and industrial uses.

**Alcohol ethoxysulfates** are anionic surfactants which are suited to the formulation of high-foaming liquid detergents, as for manual dishwashing. They offer the advantages of excellent solubility and biodegradability. Neodol 25-3S40 also exhibits low sensitivity to water hardness.

Enzyme cleaners containing a combination of bacteria culture, enzymes, and nutrients are used to dissolve grease, human waste, and protein stains.

## CORDAGE

REFERENCE: Himmelfarb, "The Technology of Cordage Fibers and Rope," Textile Book Publishers, Inc. (division of Interscience Publishers, Inc.).

The term **cordage** denotes any flexible string or line. Usage includes wrapping, baling, hauling, and power transmission in portable equipment. **Twine** and **cord** generally imply lines of  $\frac{3}{8}$  in diam or less, with larger sizes referred to as **rope**.

Natural fibers used in cordage are abaca, sisal, hemp, cotton, and jute. For heavy cordage abaca and manila predominate. Hemp is used for small, tarred lines, and henequen for agricultural binder twine.

**Rope** is made by twisting yarns into strands, with the strands (usually three) **twisted** (laid) into a line. The line twist may be S or Z (see Sec. 10), generally opposite to the twist of the strands, which, in turn, is opposite to the twist of the yarns. The term **lay** designates the number of turns of the strands per unit length of rope but may also characterize the rope properties, a function of the degree of twist of each component. Grades range from **soft lay** (high ultimate strength) to **hard lay** (high abrasion resistance). Cable-laid rope results from twisting together conventional, three-strand rope.

**Synthetic fibers** are used in cordage because of resistance to rot, high strength, and other special properties. These fibers include nylon for strength, polyester (Dacron) for strength and dimensional stability,

vinyls for chemical-plant use, fiberglass for electrical stability, vinyls for chemical-plant use, fiberglass for electrical and chemical properties, and polypropylene for strength and flotation (see Sec. 8).

**Braided cordage** has been used largely for small diameter lines such as sash cord and clothesline. However, braided lines are now available in larger diameters between 2 and 3 in. The strength of braided rope is slightly superior, and the line has less tendency to elongate in tension and cannot rotate or unlay under load. These properties are balanced against a somewhat higher cost than that of twisted rope.

A no. 1 common-lay rope will conform to the strength and weight table of the Federal Specification TR601A listed below.

For comparison, a **nylon rope** of a given diameter will have about 3 times the breaking strength given above and a **polyester rope** about 2½ times the strength of manila. Both have substantially greater flex and abrasion resistance.

See Table 6.8.5 for manila rope properties.

## ELECTRICAL INSULATING MATERIALS

REFERENCES: Plastics Compositions for Dielectrics, *Ind. Eng. Chem.*, **38**, 1946, p. 1090. High Dielectric Ceramics, *Ind. Eng. Chem.*, **38**, 1946, p. 1097. Polystyrene Plastics as High Frequency Dielectrics, *Ind. Eng. Chem.*, **38**, 1946, p. 1121. Paper Capacitors Containing Chlorinated Impregnants, *Ind. Eng. Chem.*, **38**, 1946, p. 1110. "Contributions of the Chemist to Dielectrics," National Research Council, 1947. National Research Council, Conference on Electrical Insulation, (1) Annual Report, (2) Annual Digest of Literature on Dielectrics. Von Hippel, "Dielectric Materials and Applications," Wiley. Birks (ed.), "Modern Dielectric Materials," Academic. Saums and Pendelton, "Materials for Electrical Insulating and Dielectric Functions," Hayden Book, Inc. Licari, "Plastic Coatings for Electronics," McGraw-Hill. Clark, "Insulating Materials for Design and Engineering Practice," Wiley. Mayofis, "Plastic Insulating Materials," Illiffe, Ltd., London. Bruins (ed.), "Plastic for Electrical Insulation," Interscience Publishers. Swiss Electrochemical Committee, "Encyclopedia of Electrical Insulating Materials," *Bulletin of the Swiss Association of Electrical Engineers*, vol. 48, 1958. ISO 455-3-1 1981. "1986 Annual Book of ASTM Standards," vols. 10.01-10.03 (Electrical Insulating Materials).

The insulating properties of any material are dependent upon **dielectric strength**, or the ability to withstand high voltages without breakdown; **ohmic resistance**, or the ability to prevent leakage of small currents; and **power loss**, or the absorption of electrical energy that is transformed into heat. Power loss depends upon a number of influences, particularly the molecular symmetry of the insulation and frequency of the voltage, and is the basis of power factor, an important consideration whenever efficient handling of alternating currents is concerned, and a dominating consideration when high frequencies are used, as in radio circuits. Materials may have one of these qualities to a far greater extent than the other; e.g., air has a very high specific resistance but very little dielectric

strength and no power loss at any frequency; glass has great dielectric strength yet much lower resistance than air. The **ideal insulator** is one having the maximum dielectric strength and resistance, minimum power loss, and also mechanical strength and chemical stability. Moisture is by far the greatest enemy of insulation; consequently the absence of hygroscopic quality is desirable.

The common insulating materials are described below. For their electrical properties, see Sec. 15.

**Rubber** See Rubber and Rubberlike Materials.

**Mica and Mica Compounds** Mica is a natural mineral varying widely in color and composition, and occurs in sheets that can be subdivided down to a thickness of 0.00025 in. White mica is best for electrical purposes. The green shades are the softest varieties, and the white amber from Canada is the most flexible. Mica has high insulating qualities, the best grades having a dielectric strength of 12,000 V per 0.1 mm. Its lack of flexibility, its nonuniformity, and its surface leakage are disadvantages. To offset these, several mica products have been developed, in which small pieces of mica are built up into finished shapes by means of binders such as shellac, gum, and phenolic resins.

**Micanite** consists of thin sheets of mica built into finished forms with insulating cement. It can be bent when hot and machined when cold, and is obtainable in thicknesses of 0.01 to 0.12 in. Flexible micanite plates, cloth, and paper are also obtainable in various thicknesses. **Megohmit** is similar to micanite except that it is claimed not to contain adhesive matter. It can be obtained in plates, paper, linen, and finished shapes. **Megotalc**, built up from mica and shellac, is similar to the above-named products and is obtainable in similar forms.

**Insulating Varnishes** Two general types of insulating varnish are used: (1) asphalt, bitumen, or wax, in petroleum solvent, and (2) drying-oil varnishes based on natural oils compounded with resins from natural or synthetic sources. Varnishes have changed greatly in the last few years, since new oils have become available, and particularly since phenolic and alkyd resins have been employed in their manufacture.

**Silicone varnishes** harden by baking and have electrical properties similar to those of the phenol-aldehyde resins. They are stable at temperatures up to 300°F (138°C). They can be used as wire coatings, and such wire is used in the manufacture of motors that can operate at high temperatures.

**Impregnating Compounds** Bitumens and waxes are used to impregnate motor and transformer coils, the melted mix being forced into the coil in a vacuum tank, forming a solid insulation when cooled. Brittle compounds, which gradually pulverize owing to vibration in service, and soft compounds, which melt and run out under service temperatures, should be avoided as far as possible.

**Oil** Refined grades of petroleum oils are extensively used for the insulation of transformers, switches, and lightning arresters. The following specification covers the essential points:

Table 6.8.5 Weight and Strength of Different Sizes of Manila Rope Specification Values

Approx diam, in*	Circumference, in*	Max net weight, lb/ft	Min breaking strength, lbf†	Approx diam, in*	Circumference, in*	Max net weight, lb/ft	Min breaking strength, lb	Approx diam, in	Circumference, in	Max net weight, lb/ft	Min breaking strength, lb
⅜	⅝	0.015	450	⅜	2½	0.195	6,500	1⅜	5½	0.895	26,500
¼	¾	0.020	600	½	2¾	0.225	7,700	2	6	1.08	31,000
⅜	1	0.029	1,000	⅝	3	0.270	9,000	2¼	7	1.46	41,000
½	1½	0.041	1,350	¾	3¼	0.313	10,500	2⅝	8	1.91	52,000
⅝	1¾	0.053	1,750	⅞	3½	0.360	12,000	3	9	2.42	64,000
¾	2	0.075	2,650	1	3¾	0.418	13,500	3¼	10	2.99	77,000
⅞	2¼	0.104	3,450	1¼	4	0.480	15,000	3⅝	11	3.67	91,000
1	2½	0.133	4,400	1½	4½	0.600	18,500	4	12	4.36	105,000
1¼	3	0.167	5,400	1¾	5	0.744	22,500				

The approximate length of coil is 1,200 ft for diam ⅜ in and larger. For smaller sizes it is longer, up to 3,000 ft for ⅜ in diam.

\* 1 in = 0.0254 m; 1 ft = 0.3048 m.

† 1 lbf = 4.448 N.

SOURCE: U.S. government specification TR601A, dated Nov. 26, 1935, formulated jointly by cordage manufacturers and government representatives.

Specific gravity, 0.860; flash test, not less than 335°F; cold test, not more than -10°C (14°F); viscosity (Saybolt) at 37.8°C (100°F), not more than 120 s; loss on evaporation (8 h at 200°F), not more than 0.5 percent; dielectric strength, not less than 35,000 V; freedom from water, acids, alkalis, saponifiable matter, mineral matter or free sulfur. Moisture is particularly dangerous in oil.

Petroleum oils are used for the impregnation of kraft or manila paper, after wrapping on copper conductors, to form high-voltage power cables for services up to 300,000 V. Oil-impregnated paper insulation is sensitive to moisture, and such cables must be lead-sheathed. The transmission of power at high voltages in underground systems is universally accomplished by such cables.

**Chlorinated Hydrocarbons** Chlorinated hydrocarbons have the advantage of being nonflammable and are used as filling compounds for transformers and condensers where this property is important. Chlorinated naphthalene and chlorinated diphenyl are typical of this class of material. They vary from viscous oils to solids, with a wide range of melting points. The reader is cautioned to investigate the use of such insulation carefully because of alleged carcinogenic propensities.

**Impregnated Fabrics** Fabrics serve as a framework to hold a film of insulating material and must therefore be of proper thickness, texture, and mechanical strength, and free from nap and acidity. A wide variety of drying varnishes is used for the impregnation, and the dipping is followed by baking in high-temperature towers. Varnished cambric is used for the wrapping of coils and for the insulation of conductors. These cables have high power factor and must be kept free of moisture, but they are desirable for resisting electrical surges.

**Thermosetting substances** of the phenol-aldehyde type and of the urea-formaldehyde type first soften and then undergo a chemical reaction which converts them quickly to a strong infusible product. Good properties are available in the phenolics, while numerous special types have been developed for high heat resistance, low-power-factor arc resistance, and other specialized properties. A wide variety of resins is available. The urea plastics are lacking in heat resistance but are suitable for general-purpose molding and have fair arc resistance.

**Thermoplastic resins** (see Plastics, below) are used for molding and extruding electrical insulations. They differ from the thermosetting resins in that they do not become infusible. **Polyethylene** softens between 99 and 116°C (210 and 240°F). Its dielectric strength and resistivity are high, its power factor is only 0.0003, and its dielectric constant is 2.28. It is used extensively in high-frequency and radar applications and as insulation on some power and communication cables. **Teflon** is a fluorocarbon resin which has electrical properties similar to those of polyethylene. Its softening point is 750°F approx, and it extrudes and molds with difficulty; however, more tractable grades of Teflon are now available. It is resistant to nearly all chemicals and solvents.

**Nylon** is a synthetic plastic with interesting mechanical and electrical properties. It has only fair water resistance. Its melting point is 198 to 249°C (390 to 480°F), and is used for the molding of coil forms. It can be extruded onto wire in thin layers. Such wires are used in place of the conventional varnish-coated magnet wires in coils and motors. Operation may be at temperatures up to 127°C (260°F).

**Paper** Except in lead-sheathed telephone cables, the present tendency is to use paper only as a backing or framework for an insulating film or compound, owing to its hygroscopic qualities. **Manila** and **kraft** papers possess the best dielectric and mechanical strength and, when coated with good insulating varnish, are excellent insulators. Various types of paraffined paper are used in condensers. (See also Paper, below.)

**Silicone rubber** (see Silicones) is a rubberlike material of good physical properties [tensile strength, 400 to 700 lb/in<sup>2</sup> (2.78 to 4.85 × 10<sup>6</sup> N/m<sup>2</sup>) elongation, 200 percent]. It can be operated for long periods of time at temperatures up to 138°C (300°F) or intermittently up to 249°C (480°F).

**Ceramics** and **glasses** find wide usage as insulating materials where brittleness and lack of flexibility can be tolerated.

**Polymeric (plastic) films**, particularly the polyester and fluorocarbon

types, are being used increasingly where fabrication of the electrical component permits either wrapping or insertion of film chips.

Heat-shrinkable tubing of polyvinylchloride, polyolefin, or polytetrafluoroethylene compositions allow for very tight-fitting insulation around a member, thus affording efficient protection of electrical wires or cables.

## FIBERS AND FABRICS

(See also Cordage.)

REFERENCES: Matthews-Mauersberger, "The Textile Fibers," Wiley. Von Bergen and Krauss, "Textile Fiber Atlas," Textile Book Publishers, Inc. Hess, "Textile Fibers and Their Use," Lippincott. Sherman and Sherman, "The New Fibers," Van Nostrand. Kaswell, "Textile Fibers, Yarns and Fabrics," Reinhold. "Harris' Handbook of Textile Fibers," Waverly House. Kaswell, "Wellington Sears Handbook of Industrial Textiles," Wellington Sears Co. Fiber Charts, *Textile World*, McGraw-Hill. ASTM Standards. C. Z. Carroll-Porcynski, "Advanced Materials; Refractory Fibers, Fibrous Metals, Composites," Chemical Publishing Co. Marks, Atlas, and Cernia. "Man-Made Fibers, Fibrous Metals, Composites," Chemical Publishing Co. Marks, Atlas, and Cernia, "Man-Made Fibers, Science and Technology," Interscience Publishers. Frazer, High Temperature Resistant Fibers, *Jour. Polymer Sci.*, Part C, Polymer Symposia, no. 19, 1966. Moncrieff, "Man-Made Fibers," Wiley. Preston and Economy, "High Temperature and Flame Resistant Fibers," Wiley. ANSI/ASTM Standards D1175-D 3940. ANSI/AATCC Standards 79, 128. "1986-1994 Annual Book of ASTM Standards," vols. 07.01, 07.02 (Textiles).

**Fibers** are threadlike structural materials, adaptable for spinning, weaving, felting, and similar applications. They may be of natural or synthetic origin and of inorganic or organic composition. **Fabrics** are defined by the ASTM as "planar structures produced by interlacing yarns, fibers, or filaments." A **bonded fabric** (or nonwoven fabric) consists of a web of fibers held together with a cementing medium which does not form a continuous sheet of adhesive material. A **braided fabric** is produced by interlacing several ends of yarns such that the paths of the yarns are not parallel to the fabric axis. A **knitted fabric** is produced by interlooping one or more ends of yarn. A **woven fabric** is produced by interlacing two or more sets of yarns, fibers or filaments such that the elements pass each other essentially at right angles and one set of elements is parallel to the fabric axis. A woven narrow fabric is 12 in or less in width and has a selvage on either side.

### Inorganic Fibers

**Asbestos** is the only mineral fiber of natural origin. Its demonstrated carcinogenic properties, when its particles lodge in the lung, have led to its removal from most consumer products. Formerly ubiquitously applied as a thermal insulator, e.g., it has now been proscribed from that use and has been supplanted largely by fiberglass. One of the few remaining products in which it is still used is a component in automotive and aircraft brake shoe material. In that service, its superior heat-resistant property is paramount in the design of the brake shoes, for which application there is no readily available peer, as to both performance and economy. The quest for an equivalent substitute continues; eventually, asbestos may well be relegated to history or to some limited experimental and/or laboratory use. In this environmental climate regarding asbestos, for further information see Natalis, "The Asbestos Product Guide," A&E Insul-Consult Inc., Box 276, Montvale, NJ.

Synthetic mineral fibers are **spun glass**, **rock wool**, and **slag wool**. These fibers can endure high temperatures without substantial loss of strength. Glass fibers possess a higher strength-to-weight ratio at the elastic limit than do other common engineering materials.

**Metal filaments** (wires) are used as textile fibers where their particular material properties are important.

**Carbon (graphite) fibers**, such as Thornel, are high-modulus, highly oriented structures characterized by the presence of carbon crystallites (polycrystalline graphite) preferentially aligned parallel to the fiber axis. Depending on the particular grade, tensile strengths can range from 10.3 to 241 × 10<sup>7</sup> N/m<sup>2</sup> (15,000 to 350,000 lb/in<sup>2</sup>). Hybrid composites of carbon and glass fibers find aerospace and industrial applications.

**Zirconia fibers** ( $ZrO_2 + HfO_2 +$  stabilizers), such as Zircar, have excellent temperature resistance to about 2,200°C (4,000°F), and fabrics woven from the fibers serve as thermal insulators.

#### Natural Organic Fibers

The **animal fibers** include **wool** from sheep, **mohair** from goats, **camel's hair**, and **silk**. Wool is the most important of these, and it may be processed to reduce its susceptibility to moth damage and shrinkage. Silk is no longer of particular economic importance, having been supplanted by one or another of the synthetic fibers for most applications.

The **vegetable fibers** of greatest utility consist mainly of cellulose and may be classified as follows: seed hairs, such as cotton; bast fibers, such as flax, hemp, jute, and ramie; and vascular fibers. Those containing the most cellulose are the most flexible and elastic and may be bleached white most easily. Those which are more lignified tend to be stiff, brittle, and hard to bleach. Vegetable fibers are much less hygroscopic than wool or silk.

**Mercerized cotton** is cotton fiber that has been treated with strong caustic soda while under tension. The fiber becomes more lustrous, stronger, and more readily dyeable.

#### Synthetic Organic Fibers

In recent years, a large and increasing portion of commercial fiber production has been of synthetic or semisynthetic origin. These fibers provide generally superior mechanical properties and greater resistance to degradation than do natural organic fibers and are available in a variety of forms and compositions for particular end-use applications. Generic categories of man-made fibers have been established by the Textile Fiber Products Identification Act, 15 USC 70, 72 Stat. 1717.

Among the important fibers are **rayons**, made from regenerated cellulose, plain or acetylated, which has been put into a viscous solution and extruded through the holes of a spinner into a setting bath. The types most common at present are **viscose** and **acetate**. Cuprammonium rayon, saponified acetate rayon, and high-wet-modulus rayon are also manufactured and have properties which make them suitable for particular applications. Rayon is generally less expensive than other synthetic fibers.

In contrast to these regenerated fibers are a variety of polymer fibers which are chemically synthesized. The most important is **nylon**, including nylon 6.6, a condensation polymer of hexamethylene diamine-adipic acid, and nylon 6, a polymer of caprolactam. Nylon possesses outstanding mechanical properties and is widely used in industrial fabrics. Nomex, a high-temperature-resistant nylon retains its most important properties at continuous operating temperatures up to 260°C (500°F). Other polymer fibers possess mechanical or chemical properties which make them a specific material of choice for specialized applications. These include **polyester** fibers, made from polyethylene terephthalate; **acrylic** and **modacrylic** fibers, made from copolymers of acrylonitrile and other chemicals; **Saran**, a polymer composed essentially of vinylidene chloride; and the **olefins**, including polyethylenes and polypropylene.

**Teflon**, a fluorocarbon resin, has excellent chemical resistance to acids, bases, or solvents. Its useful physical properties range from cryogenic temperatures to 260°C (500°F), high dielectric strength, low dissipation factor, and high resistivity, along with the lowest coefficient of friction of any solid. It is nonflammable and is inert to weather and sunlight.

As part of their manufacture, substantially all synthetic fibers are **drawn** (hot- or cold-stretched) after extrusion to achieve desirable changes in properties. Generally, increases in draw increase breaking strength and modulus and decrease ultimate elongation.

**Proximate Identification of Fibers** Fibers are most accurately distinguished under the microscope, with the aid of chemical reagents and stains. A useful rough test is burning, in which the odor of burned meat distinguishes animal fibers from vegetable and synthetic fibers. Animal fibers, cellulose acetate, and nylon melt before burning and fuse to hard rounded beads. Cellulose fibers burn off sharply. Cellulose acetate dissolves in either acetone or chloroform containing some alcohol.

**Heat Endurance** Fibers of organic origin lose strength when heated

over long periods of time above certain temperatures: cellulose, 149°C (300°F); cellulose acetate, 93.5°C (200°F); nylon, 224°C (435°F); casein, 100°C (212°F); and glass, 316°C (600°F).

**Creep** Textile fibers exhibit the phenomenon of creep at relatively low loads. When a textile fiber is subjected to load, it suffers three kinds of distortion: (1) an elastic deformation, closely proportioned to load and fully and instantly recoverable upon load removal; (2) a primary creep, which increases at a decreasing rate with time and which is fully, but not instantaneously, recoverable upon load removal; and (3) a secondary creep, which varies obscurely with time and load and is completely nonrecoverable upon load removal. The relative amounts of these three components, acting to produce the total deformation, vary with the different fibers. The two inelastic components give rise to mechanical hysteresis on loading and unloading.

#### Felts and Fabrics

A **felt** is a compacted formation of randomly entangled fibers. Wool felt is cohesive because the scaly structure of the wool fibers promotes mechanical interlocking of the tangled fibers. Felts can be made with blends of natural or synthetic fibers, and they may be impregnated with resins, waxes or lubricants for specific mechanical uses. Felts are available in sheets or cut into washers or shaped gaskets in a wide range of thicknesses and densities for packing, for vibration absorption, for heat insulation, or as holders of lubricant for bearings.

**Fabrics** are woven or knitted from **yarns**. Continuous-filament synthetic fibers can be made into monofilament or multifilament yarns with little or no twist. Natural fibers, of relatively short length, and synthetic **staple** fibers, which are purposely cut into short lengths, must be twisted together to form yarns. The amount of twist in yarns and the tension and arrangement of the weaving determine the appearance and mechanical properties of fabrics. Staple-fiber fabrics retain less than 50 percent of the intrinsic fiber strength, but values approaching 100 percent are retained with continuous-filament yarns. Industrial fabrics can be modified by mechanical and chemical treatments, as well as by coatings and impregnations, to meet special demands for strength and other mechanical, chemical, and electrical properties or to resist insect, fungus, and bacterial action and flammability.

**Nomenclature** There are literally dozens of different numbering systems for expressing the relationship between yarn weight and length, all differing and each used in connection with particular fiber types or in different countries. The most common currently used unit is the **denier**, which is the weight in grams of 9,000 m of yarn. A universal system, based on the **tex** (the weight in grams of 1,000 m of yarn), has been approved by the International Standards Organization and by the ASTM. Relative strengths of fibers and yarns are expressed as the **tenacity**, which reflects the specific gravity and the average cross section of the yarn. Units are grams per denier (gpd) or grams per tex (gpt).

Many textiles can sustain high-energy impact loads because of their considerable elongation before rupture. The total work done per unit length on a fiber or yarn which is extended to the point of rupture can be approximated by multiplying the specific strength by one-half the final extension of that length.

Yarn **twist** direction is expressed as **S** or **Z** twist, with the near-side helical paths of a twisted yarn held in a vertical position comparable in direction of slope to the center portion of one of these letters. Amount of twist is expressed in turns per inch (tpi).

Fabrics are characterized by the composition of the fiber material, the type of weave or construction, the count (the number of yarns per inch in the warp and the filling directions), and the weight of the fabric, usually expressed in ounces per running yard. **Cover factor** is the ratio of fabric surface covered by yarn to the total fabric surface. **Packing factor** is the ratio of fiber volume to total fabric volume.

Tables 6.8.6 to 6.8.8 give physical data and other information about commercial fibers and yarns. The tabulated quantities involving the denier should be regarded as approximate; they are not absolute values such as are used in engineering calculations.

With the continuing phasing out of asbestos products, one can substitute, under appropriate conditions, fiberglass woven fabrics. See **Fiberglass** in this section.

Table 6.8.6 Fiber Properties\*

Kind	Source	Length of fiber, in	Width or diam of cells, μm	Specific gravity	Moisture regain, ‡ %	Chemical description	Principal uses
Cotton	Plant seed hair	5/8-2	8-27	1.52	8.5	Cellulose	Industrial, household, apparel
Jute†	Plant bast	50-80	15-20	1.48	13.7	Lignocellulose	Bagging, twine, carpet backing
Wool	Animal	2-16	10-50	1.32	17	Protein	Apparel, household, industrial
Viscose	Manufactured	Any	8-43	1.52	11	Regenerated cellulose	Apparel, industrial, household
Cellulose acetate	Manufactured	Any	12-46	1.33	6	Cellulose ester	Apparel, industrial, household
Nylon	Manufactured	Any	8	1.14	4.2	Polyamide	Apparel, industrial, household
Casein	Manufactured	Any	11-28	1.3	4.1	Protein	Apparel
Flax†	Plant bast	12-36	15-17	1.5	12	Cellulose	Household, apparel, industrial
Hemp†	Plant bast	—	18-23	1.48	12	Cellulose	Twine, halyards, rigging
Sisal†	Plant leaf	30-48	10-30	—	—	Lignocellulose	Twine, cordage
Manila†	Plant leaf	60-140	10-30	—	—	Lignocellulose	Rope, twine, cordage
Ramie†	Plant bast	3-10	24-70	1.52	—	Cellulose	Household, apparel, seines
Silk	Silkworm	Any	5-23	1.35	11	Protein	Apparel, household, industrial
Glass	Manufactured	Any	3	2.5	0	Fused metal oxides	Industrial, household
Dacron	Manufactured	Any	8	1.38	0.4	Polyester	Apparel, industrial, household

1 in = 0.025 + m; 1 μ = 10<sup>-6</sup> m. The more up-to-date term for the micron (μ) is the micrometer (μm).  
 \* Adapted from Smith, Textile Fibers, *proc. ASTM*, 1944; Appel, A Survey of the Synthetic Fibers, *Am. Dyestuff Reporter*, 34, 1945, pp. 21-26; and other sources.  
 † These fibers are commercially used as bundles of cells. They vary greatly in width. Width figures given are for the individual cells.  
 ‡ In air at 70°F and 65 percent relative humidity.

Table 6.8.7 Tensile Properties of Single Fibers

Fiber	Breaking tenacity, gpd	Extension at break, %	Elastic recovery at corresponding strain, %	Elastic modulus,* gpd
Glass	6.0-7.3	3.0-4.0	100 at 2.9	200-300
Fortisan (rayon)	6.0-7.0	—	100 at 1.2	150-200
Flax	2.6-7.7	2.7-3.3	65 at 2	—
Nylon 6,6	4.6-9.2	16-32	100 at 8	25-50
Nylon 6	4.5-8.6	16-40	100 at 8	25-50
Silk	2.4-5.1	10-25	92 at 2	75-125
Saran	1.1-2.3	15-25	95 at 10	—
Cotton	3.0-4.9	3-7	74 at 2	50-100
Steel (90,000 lb/in <sup>2</sup> T.S.)	0.9	28	—	300
Steel (music wire)	3.5	8	—	300
Viscose rayon	1.5-5.0	15-30	82 at 2	50-150
Wool	1.0-1.7	25-35	99 at 2	25-40
Acetate rayon	1.3-1.5	23-34	100 at 1	25-40
Polyester	4.4-7.8	10-25	100 at 2	50-80
Polypropylene	4.0-7.0	15-25	95 at 7	15-50
Polytetrafluoroethylene	1.7	13	—	—

\* From Kaswell, "Textile Fibers, Yarns, and Fabrics," Reinhold.  
 SOURCE: Kaswell "Wellington Sears Handbook of Industrial Textiles," Wellington Sears Co., Inc.

FREEZING PREVENTIVES

**Common salt** is sometimes used to prevent the freezing of water; it does not, however, lower the freezing point sufficiently to be of use in very cold weather, and in concentrated solution tends to "creep" and to crystallize all over the receptacle. It also actively corrodes metals and has deleterious effects on many other materials, e.g., concrete. For freezing temperatures, see Sec. 18.

**Calcium chloride** (CaCl<sub>2</sub>) is a white solid substance widely used for preventing freezing of solutions and (owing to its great hygroscopic power) for keeping sizing materials and other similar substances moist. It does not "creep" as in the case of salt. It does not rust metal but attacks solder.

Calcium chloride solutions are much less corrosive on metal if made alkaline by the use of lime, and also if a trace of sodium chromate is present. They are not suitable for use in automobile radiators, because of corrosive action while hot, and because of tendency of any spray therefrom to ruin the insulation of spark plugs and high-tension cables. For freezing temperatures, see Sec. 18.

**Glycerol** is a colorless, viscid liquid without odor and miscible with water in all proportions. It should have a specific gravity of approximately 1.25. It has no effect on metals but disintegrates rubber and loosens up iron rust.

**Denatured alcohol** is free from the disadvantages of calcium chloride, salt, and glycerin solutions, but is volatile from water mixtures which

Table 6.8.8 Temperature and Chemical Effects on Textiles

Fiber	Temperature limit, °F	Resistance to chemicals	Resistance to mildew
Cotton	Yellows 250; decomposes 300	Poor resistance to acids	Attacked
Flax	275	Poor resistance to acids	Attacked
Silk	Decomposes 300	Attacked	Attacked
Glass	Softens 1,350	Resists	Resists
Nylon 6	Sticky 400; melts 420-430	Generally good	Resists
Nylon 6,6	Sticky 455; melts 482	Generally good	Resists
Viscose rayon	Decomposes 350-400	Poor resistance to acids	Attacked
Acetate	Sticky 350-400; melts 500	Poor resistance to acids	Resists
Wool	Decomposes 275	Poor resistance to alkalis	Attacked
Asbestos	1,490	Resists	Resists
Polyester	Sticky 455; melts 480	Generally good	Resists
Polypropylene	Softens 300-310; melts 325-335	Generally good	Resists
Polyethylene	Softens 225-235; melts 230-250	Generally good	Resists
Jute	275	Poor resistance to acids	Attacked

Temperature conversion:  $t_c = (9/5)(t_f - 32)$ .  
 SOURCE: Fiber Chart, *Textile World*, McGraw-Hill, 1962

Table 6.8.9 Nonfreezing Percentages by Volume in Solution

	Temperature, °C (°F)			
	- 6.7 (20)	- 12.2 (10)	- 17.8 (0)	- 23.4 (- 10)
Methyl alcohol	13	20	25	30
Prestone	17	25	32	38
Denatured alcohol	17	26	34	42
Glycerol	22	33	40	47

run hot. A solution containing 50 percent alcohol becomes flammable, but it is rarely necessary to use more than 30 percent.

**Methyl alcohol** solutions were sold widely in the past for use as automotive antifreeze. It is an effective antifreeze, but its fumes are poisonous and it must be used with extreme care. It has been largely supplanted for this use by ethylene glycol solutions, which are applied in automotive practice and for stationary applications where, e.g., it is circulated in subgrade embedded pipes and thus inhibits formation of ice on walking surfaces.

**Ethylene glycol (Prestone)** is used as a freezing preventive and also permits the use of high jacket temperatures in aircraft and other engines. Sp gr 1.125 (1.098) at 32 (77)°F; boiling point, 387°F; specific heat, 0.575 (0.675) at 68 (212)°F. Miscible with water in all proportions.

See Table 6.8.9 for nonfreezing percentages by volume.

Winter-summer concentrates, such as Prestone 11, an ethylene glycol base combined with patented inhibitor ingredients, give maximum freezing protection to about -92°F (-62°C) at 68 percent mixture, and to about -34°F (-37°C) at 50 percent mixture.

Anti-icing of fuels for aircraft is accomplished by adding ethylene glycol monomethyl ether mixtures as Prist.

## GLASS

REFERENCES: *Journal of American Ceramic Society*, Columbus, Ohio. *Journal of the Society of Glass Technology*, Sheffield, England. Morey, "Properties of Glass," Reinhold. Scholes, "Handbook of the Glass Industry," Ogdon-Watney. "Non-Silica Glasses," *Chem. & Met. Eng.*, Mar. 1946. Phillips, "Glass the Miracle-Maker," Pitman. Long, "Propriétés physiques et fusion du verre," Dunod. Eitel-Pirani-Scheel, "Glastechnische Tabellen," Springer. Jebsen-Marwedel, "Glastechnische Fabrikationsfehler," Springer. Shand, "Glass Engineering Handbook," McGraw-Hill. Phillips, "Glass: Its Industrial Applications," Reinhold. Persson, "Flat Glass Technology," Plenum Press, 1969. McMillan, "Glass-Ceramics," Academic. Pye, Stevens, and La Course (eds.), "Introduction to Glass Science," Plenum Press. Jones, "Glass," Chapman & Hall. Doremus, "Glass Science," Wiley. Technical Staffs Division, "Glass," Corning Glass Works. ANSI/ASTM C "1986 Annual Book of ASTM Standards," vol. 15.02 (Glass).

**Glass** is an inorganic product of fusion which has cooled to a rigid condition without crystallizing. It is obtained by melting together silica, alkali, and stabilizing ingredients, such as lime, alumina, lead, and barium. Bottle, plate, and window glass usually contain SiO<sub>2</sub>, Al<sub>2</sub>O<sub>3</sub>, CaO, and Na<sub>2</sub>O. Small amounts of the oxides of manganese and selenium are added to obtain colorless glass.

Special glasses, such as fiberglass, laboratory ware, thermometer glass, and optical glass, require different manufacturing methods and different compositions. The following oxides are either substituted for or added to the above base glass: B<sub>2</sub>O<sub>3</sub>, ZnO, K<sub>2</sub>O, As<sub>2</sub>O<sub>3</sub>, PbO, etc., to secure the requisite properties. Colored glasses are obtained by adding the oxides of iron, manganese, copper, selenium, cobalt, chromium, etc., or colloidal gold.

Molten glass possesses the ability to be fabricated in a variety of ways and to be cooled down to room temperature rapidly enough to prevent crystallization of the constituents. It is a rigid material at ordinary temperatures but may be remelted and molded any number of times by the application of heat. Ordinary glass is melted at about 1,430°C (2,600°F) and will soften enough to lose its shape at about 594°C (1,100°F).

**Window glass** is a soda-lime-silica glass, fabricated in continuous sheets up to a width of 6 ft. The sheets are made in two thicknesses, SS

and DS, which are, respectively, 1/16 and 1/8 in. Both thicknesses are made in A, B, C, and D grades.

**Reflective-coated glass**, such as Vari-Tran, insulates by reflecting hot sun in summer. Various colors are available, with heat transmissions ranging from 8 to 50 percent.

**Borosilicate glass** is the oldest type of glass to have significant heat resistance. It withstands higher operating temperatures than either limed or lead glasses and is also more resistant to chemical attack. It is used for piping, sight glasses, boiler-gage glasses, sealed-beam lamps, laboratory beakers, and oven cooking ware. This type of glass was the first to carry the Pyrex trademark.

**Aluminosilicate glass** is similar to borosilicate glass in behavior but is able to withstand higher operating temperatures. It is used for top-of-stove cooking ware, lamp parts, and when coated, as resistors for electronic circuitry.

**Plate glass** and float glass are similar in composition to window glass. They are fabricated in continuous sheets up to a width of 15 ft and are polished on both sides. They may be obtained in various thicknesses and grades, under names like Parallel-O-Plate and Parallel-O-Float.

Before the introduction of float glass, plate glass sheets were polished mechanically on both sides, which turned out to be the most expensive part of the entire production process. Pilkington, in England, invented the concept of pouring molten glass onto a bed of molten tin and to float it thereon—hence the name *float glass*. In that process, the underside of the glass conforms to the smooth surface of the molten tin surface, and the top surface flows out to a smooth surface. The entire grinding and polishing operations are eliminated, with attendant impact on reducing the cost of the final product. With rare exceptions, all plate glass is currently produced as float glass.

**Safety glass** consists of two layers of plate glass firmly held together by an intermediate layer of organic material, such as polyvinyl butyral. Safety glass is ordinarily 1/4 in thick but can be obtained in various thicknesses. This plate is shatter proof and is used for windshields, bank cashier's windows, etc.

**Tempered glass** is made from sheet glass in thicknesses up to 1 in. It possesses great mechanical strength, which is obtained by rapidly chilling the surfaces while the glass is still hot. This process sets up a high compression on the glass surfaces, which have the capacity of withstanding very high tensile forces.

**Wire glass** is a glass having an iron wire screen thoroughly embedded in it. It offers about 1 1/2 times the resistance to bending that plain glass does; even thin sheets may be walked on. If properly made, it does not fall apart when cracked by shocks or heat, and is consequently fire-resistant. It is used for flooring, skylights, fireproof doors, fire walls, etc.

**Pressed glass** is made by forming heat-softened glass in molds under pressure. Such articles as tableware, lenses, insulators, and glass blocks are made by this process.

**Glass blocks** find wide application for building purposes, where they form easy-to-clean, attractive, airtight, light-transmitting panels. Glass blocks, such as Vistabrik, are solid throughout, and exceptionally rugged and virtually indestructible. Glass blocks manufactured to have an internal, partially depressurized air gap have energy-conserving, insulating qualities, with "thermal resistance" or R values ranging from 1.1 to almost 2.3 (h · ft<sup>2</sup> · °F)/Btu. Solar heat transmission can be varied within wide limits by using different colored glasses and by changing the reflection characteristics by means of surface sculpting. Standard blocks are 3 3/8 in thick, and can be had in 6 by 6, 8 by 8, 12 by 12, 3 by 6, 4 by 8, and 4 by 12-in sizes. Thinner blocks are also available.

**Fiberglass** is a term used to designate articles that consist of a multitude of tiny glass filaments ranging in size from 0.0001 to 0.01 in in diam. The larger fibers are used in air filters; those 0.0005 in in diam, for thermal insulation; and the 0.0001- to 0.0002-in-diam fibers, for glass fabrics, which are stronger than ordinary textiles of the same size. Insulating tapes made from glass fabric have found wide application in electrical equipment, such as motors and generators and for mechanical uses. Woven fiberglass has supplanted woven asbestos, which is no longer produced.

**Glass** is used for many structural purposes, such as store fronts and

tabletops, and is available in thicknesses upward of  $\frac{5}{16}$  in and in plates up to  $72 \times 130$  in. Plates with customized dimensions to suit specific architectural requirements are available on special order.

**Cellular glass** is a puffed variety with about 14–15 million cells per cubic foot. It is a good heat insulator and makes a durable marine float. See also Sec. 4.

**Vycor** is a 96 percent silica glass having extreme heat-shock resistance to temperatures up to  $900^{\circ}\text{C}$  ( $1,652^{\circ}\text{F}$ ), and is used as furnace sight glasses, drying trays, and space-vehicle outer windows.

**Fused silica** (silicon dioxide) in the noncrystalline or amorphous state shows the maximum resistance to heat shock and the highest permissible operating temperature,  $900^{\circ}\text{C}$  ( $1,652^{\circ}\text{F}$ ) for extended periods, or  $1,200^{\circ}\text{C}$  ( $2,192^{\circ}\text{F}$ ) for short periods. It has maximum ultraviolet transmission and the highest chemical-attack resistance. It is used for astronomical telescopes, ultrasonic delay lines, and crucibles for growing single metal crystals.

**Vitreous silica**, also called **fused quartz** is made by melting rock crystal or purest quartz sand in the electric furnace. It is unaffected by changes of temperature, is fireproof and acid-resistant, does not conduct electricity, and has practically no expansion under heat. It is used considerably for high-temperature laboratory apparatus. See Plastics, below, for glass substitutes.

**Glass ceramics**, such as Pyroceram, are melted and formed as glasses, then converted by controlled nucleation and crystal growth to polycrystalline ceramic materials. Most are opaque and stronger than glass, and may also be chemically strengthened.

**Leaded glass** used to fabricate fine crystal (glasses, decanters, vases, etc.) has a lead content which has been shown to leach out into the liquid contents if the two are in contact for a long time, certainly in the range of months or longer. Often the optical properties of this glass are enhanced by elaborate and delicate designs cut into the surface. The addition of lead to the base glass results in a softer product which lends itself more readily to such detailed artistry.

**Glass beads** are used extensively for reflective paints.

**Properties of Glass** Glass is a brittle material and can be considered perfectly elastic to the fracture point. The range of Young's modulus is  $4$  to  $14 \times 10^3$   $\text{kg/mm}^2$  ( $6$  to  $20 \times 10^6$   $\text{lb/in}^2$ ), with most commercial glasses falling between  $5.5$  and  $9.0 \times 10^3$   $\text{kg/mm}^2$  ( $8$  and  $13 \times 10^6$   $\text{lb/in}^2$ ). Theory predicts glass strength as high as  $3,500$   $\text{kg/mm}^2$  ( $5 \times 10^6$   $\text{lb/in}^2$ ); fine glass fibers have shown strengths around  $700$   $\text{kg/mm}^2$  ( $10^6$   $\text{lb/in}^2$ ); however, glass products realize but a fraction of such properties owing to surface-imperfection stress-concentration effects. Often design strengths run from  $500$  to  $1,000$  times lower than theoretical. Glass strength also deteriorates when held under stress in atmospheric air (static fatigue), an apparent result of reaction of water with glass; high-strength glasses suffer the greater penalty. Glass also exhibits a time-load effect, or creep, and may even break when subjected to sustained loads, albeit the stresses induced may be extremely low. There exist samples of very old glass (centuries old) which, while not broken, show evidence of plastic flow albeit at ambient temperature all the while. A cylindrical shape, e.g., will slowly degenerate into a teardrop shape, with the thickening at the bottom having been caused by the deadweight alone of the piece of glass. At room temperatures the thermal conductivity of glasses ranges from  $1.6 \times 10^{-3}$  to  $2.9 \times 10^{-3}$   $\text{cal}/(\text{s} \cdot \text{cm}^2 \cdot ^{\circ}\text{C}/\text{cm})$  [ $4.65$  to  $8.43$   $\text{Btu}/(\text{h} \cdot \text{ft}^2 \cdot ^{\circ}\text{F}/\text{in})$ ].

## NATURAL STONES

REFERENCES: Kessler, Insley, and Sligh, *Jour. Res. NBS*, **25**, pp. 161–206. Birch, Schairer, and Spicer, *Handbook of Physical Constants, Geol. Soc. Am. Special Paper* 36. Currier, *Geological Appraisal of Dimension Stone Deposits, USGS Bull.* 1109. ANSI/ASTM Standards C99–C880. "1986 Annual Book of ASTM Standards," vol. 04.08 (Building Stones).

A **stone** or a **rock** is a naturally occurring composite of minerals. Stone has been used for thousands of years as a major construction material because it possesses qualities of strength, durability, architectural adaptability, and aesthetic satisfaction. There are two principal branches

of the natural-stone industry—**dimension** stone and **crushed** or broken stone. The uses of the latter vary from aggregate to riprap, in which stones in a broad range of sizes are used as structural support in a matrix or to provide weathering resistance. Dimension stones are blocks or slabs of stone processed to specifications of size, shape, and surface finish. The largest volume today lies in the use of slabs varying from 1 to 4 in in thickness that are mounted on a structure as a protective and aesthetic veneer.

There are two major types of natural stone: **igneous** and **metamorphic** stones, composed of tightly interlocking crystals of one or more minerals, and **sedimentary** rocks, composed of cemented mineral grains in which the cement may or may not be of the same composition as the grains. The major groups of natural stone used commercially are:

**Granite**, a visibly crystalline rock made of silicate minerals, primarily feldspar and quartz. Commercially, "granite" refers to all stones geologically defined as plutonic, igneous, and gneissic.

**Marble**, generally a visibly carbonate rock; however, microcrystalline rocks, such as onyx, travertine, and serpentine, are usually included by the trade as long as they can take a polish.

**Limestone**, a sedimentary rock composed of calcium or magnesium carbonate grains in a carbonate matrix.

**Sandstone**, a sedimentary rock composed chiefly of cemented, sand-sized quartz grains. In the trade, quartzites are usually grouped with sandstones, although these rocks tend to fracture through, rather than around, the grains. **Conglomerate** is a term used for a sandstone containing aggregate in sizes from the gravel range up.

The above stones can be used almost interchangeably as dimension stone for architectural or structural purposes.

**Slate**, a fine-grained rock, is characterized by marked cleavages by which the rock can be split easily into relatively thin slabs. Because of this characteristic, slate was at one time widely used for roofing tiles. See Roofing Materials, later in this section.

It is still widely applied for other building uses, such as steps, risers, spandrels, flagstones, and in some outdoor sculptured work.

Formerly, it was used almost universally for blackboards and electrical instrument panels, but it has been supplanted in these applications by plastic materials. Plastic sheets used as a writing surface for chalk are properly called **chalkboards**; the surface on which writing is done with crayons or fluid tip markers is termed **marker board**.

Miscellaneous stones, such as traprock (fine-grained black volcanic rock), greenstone, or argillite, are commonly used as crushed or broken stone but rarely as dimension stone.

Table 6.8.10 lists physical properties and contains the range of values that can be obtained from stones in various orientations relative to their textural and structural anisotropy. For a particular application, where one property must be exactly determined, the value must be obtained along a specified axis.

### Selected Terms Applying to the Use of Dimension Stone

**Anchor**, a metal tie or rod used to fasten stone to backup units.

**Arris**, the meeting of two surfaces producing an angle, corner, or edge.

**Ashlar**, a facing of square or rectangular stones having sawed, dressed, or squared beds.

**Bond stones**, stones projecting a minimum of 4 in laterally into the backup wall; used to tie the wall together.

**Cut stone**, finished dimension stone—ready to set in place. The finish may be polished, honed, grooved (for foot traffic), or broken face.

**Bearing wall**, a wall supporting a vertical load in addition to its own weight.

**Cavity wall**, a wall in which the inner and outer parts are separated by an air space but are tied together with cross members.

**Composite wall**, a wall in which the facing and backing are of different materials and are united with bond stones to exert a common reaction under load. It is considered preferable, however, not to require the facing to support a load; thus the bond stones merely tie the facing to the supporting wall, as in the case of a veneer.

Table 6.8.10 Physical and Thermal Properties of Common Stones

Type of stone	Density, lb/ft <sup>3</sup>	Compressive strength × 10 <sup>-3</sup> , lb/in <sup>2</sup>	Rupture modulus × 10 <sup>-3</sup> , lb/in <sup>2</sup> (ASTM C99-52)	Shearing strength × 10 <sup>-3</sup> , lb/in <sup>2</sup>	Young's modulus × 10 <sup>-6</sup> , lb/in <sup>2</sup>	Modulus of rigidity × 10 <sup>-6</sup> , lb/in <sup>2</sup>	Poisson's ratio	Abrasion-hardness index (ASTM C241-51)	Porosity, vol %	48-h water absorption (ASTM C97-47)	Thermal conductivity, Btu/(ft · h · °F)	Coefficient of thermal expansion × 10 <sup>-6</sup> , per °F
Granite	160–190	13–55	1.4–5.5	3.5–6.5	4–16	2–6	0.05–0.2	37–88	0.6–3.8	0.02–0.58	20–35	3.6–4.6
Marble	165–179	8–27	0.6–4.0	1.3–6.5	5–11.5	2–4.5	0.1–0.2	8–42	0.4–2.1	0.02–0.45	8–36	3.0–8.5
Slate	168–180	9–10	6–15	2.0–3.6	6–16	2.5–6	0.1–0.3	6–12	0.1–1.7	0.01–0.6	12–26	3.3–5.6
Sandstone	119–168	5–20	0.7–2.3	0.3–3.0	0.7–10	0.3–4	0.1–0.3	2–26	1.9–27.3	2.0–12.0	4–40	3.9–6.7
Limestone	117–175	2.5–28	0.5–2.0	0.8–3.6	3–9	1–4	0.1–0.3	1–24	1.1–31.0	1.0–10.0	20–32	2.8–4.5

Conversion factors: 1 lbm/ft<sup>3</sup> = 16,018 kg/m<sup>3</sup>. 1 lb/in<sup>2</sup> = 6,894.8 N/m<sup>2</sup>. 1 Btu/(ft · h · °F) = 623 W/(m · °C).

**Veneer or faced wall**, a wall in which a thin facing and the backing are of different materials but are not so bonded as to exert a common reaction under load.

Definitions may be found in ANSI/ASTM, C119-74 (1980).

## PAPER

REFERENCES: Calkin, "Modern Pulp and Papermaking," Reinhold. Griffin and Little, "Manufacture of Pulp and Paper," McGraw-Hill. Guthrie, "The Economics of Pulp and Paper," State College of Washington Press. "Dictionary of Paper," American Pulp and Paper Assoc. Sutermeister, "Chemistry of Pulp and Papermaking," Wiley. Casey, "Pulp and Paper—Chemistry and Technology," Interscience, TAPPI Technical Information Sheets. TAPPI Monograph Series. "Index of Federal Specifications, Standards and Handbooks," GSA. Lockwoods Directory of the Paper and Allied Trades. Casey, "Pulp and Paper; Chemistry and Chemical Technology," 3 vols., Interscience. Libby (ed.), "Pulp and Paper Science and Technology," 2 vols., McGraw-Hill. ASTM Committee D6 on Paper and Paper Products, "Paper and Paperboard Characteristics, Nomenclature, and Significance of Tests," ASTM Special Technical Publication 60-B, 3d ed., 1963. Britt, "Handbook of Pulp and Paper Technology," Van Nostrand Reinhold. Johnson, "Synthetic Paper from Synthetic Fibers," Noyes Data Corp., New Jersey. "1986 Annual Book of ASTM Standards," vol. 15.09 (Paper).

### Paper Grades

Specific paper **qualities** are achieved in a number of ways: (1) By selecting the composition of the furnish for the paper machine. Usually more than one pulp (prepared by different pulping conditions or processes) is required. The ratio of long-fibered pulp (softwood) to short-fibered pulp (hardwood or mechanical type), the reused-fiber content, and the use of nonfibrous fillers and chemical additives are important factors. (2) By varying the paper-machine operation. Fourdrinier wire machines are most common, although multicylinder machines and high-speed tissue machines with Yankee driers are also used. (3) By using various finishing operations (e.g., calendering, supercalendering, coating, and laminating).

There is a tremendous number of paper grades, which are, in turn, used in a wide variety of converted products. The following broad classifications are included as a useful guide:

**Sanitary papers** are tissue products characterized by bulk, opacity, softness, and water absorbency.

**Glassine, greaseproof, and waxing papers**—in glassine, high transparency and density, low grease penetration, and uniformity of formation are important requirements.

**Food-board** products require a good brightness and should be odorless and have good tear, tensile, and fold-endurance properties, opacity, and printability. More stringent sanitary requirements in current practice have caused this product to be supplanted largely by foamed plastics (polyethylene and the like).

**Boxboard, misnomered cardboard,** and a variety of other board prod-

ucts are made on multicylinder machines, where layers of fiber are built up to the desired thickness. Interior plies are often made from waste-paper furnishes, while surface plies are from bleached, virgin fiber. Boards are often coated for high brightness and good printing qualities.

**Printing papers** include publication papers (magazines), book papers, bond and ledger papers, newsprint, and catalog papers. In all cases, printability, opacity, and dimensional stability are important.

**Linerboard and bag paper** are principally unbleached, long-fiber, kraft products of various weights. Their principal property requirements are high tensile and bursting strengths.

**Corrugating medium**, in combined fiberboard, serves to hold the two linerboards apart in rigid, parallel separation. Stiffness is the most important property, together with good water absorbency for ease of corrugation.

**Corrugated paper**, often misnomered **corrugated cardboard**, is an end product of kraft paper, in which a corrugated layer is sandwiched and glued between two layers of cover paper. The whole assembly, when the glue has set, results in a material having a high flexural strength (although it may be directional, depending on whether the material is flexed parallel or crosswise to the corrugations), and high penetration strength. For heavier-duty applications, several sandwiches are themselves glued together and result in a truly superior load-carrying material.

### Pulps

The most important source of fiber for paper pulps is wood, although numerous other vegetable substances are used. Reused fiber (wastepaper) constitutes about 30 percent of the total furnish used in paper, principally in boxboard and other packaging or printing papers.

There are three basic processes used to convert wood to papermaking fibers: mechanical, chemical, and "chemimechanical."

**Mechanical Pulping (Groundwood)** Here, the entire log is reduced to fibers by grinding against a stone cylinder, the simplest route to papermaking fiber. Wood fibers are mingled with extraneous materials which can cause weakening and discoloration in the finished paper. Nonetheless, the resulting pulp imparts good bulk and opacity to a printing sheet. Some long-fibered chemical pulp is usually added. Groundwood is used extensively in low-cost, short-service, and throw-away papers, e.g., newsprint and catalog paper.

**Chemical Pulping** Fiber separation can also be accomplished by chemical treatment of wood chips to dissolve the lignin that cements the fibers together. From 40 to 50 percent of the log is extracted, resulting in relatively pure cellulosic fiber. There are two major chemical-pulping processes, which differ both in chemical treatment and in the nature of the pulp produced. In **sulfate pulping**, also referred to as the **kraft** or **alkaline** process, the pulping chemicals must be recovered and reused for economic reasons. Sulfate pulps result in papers of high physical



strength, bulk, and opacity; low unbleached brightness; slow beating rates; and relatively poor sheet-formation properties. Both bleached and unbleached sulfate pulps are used in packaging papers, container board, and a variety of printing and bond papers. In **sulfite pulping**, the delignifying agents are sulfurous acid and an alkali, with several variations of the exact chemical conditions in commercial use. In general, sulfate pulps have lower physical strength properties and lower bulk and opacity than kraft pulps, with higher unbleached brightness and better sheet-formation properties. The pulps are blended with groundwood for **newsprint** and are used in printing and bond papers, tissues, and glassine.

“**Chemimechanical**” processes combine both chemical and mechanical methods of defibration, the most important commercial process being the NSSC (Neutral Sulfite Semi Chemical). A wide range of yields and properties can be obtained.

#### Bleaching

Chemical pulps may be bleached to varying degrees of brightness, depending on the end use. During some bleaching operations, the remaining lignin is removed and residual coloring matter destroyed. Alternatively, a nondelignifying bleach lightens the color of high-lignin pulps.

#### Refining

The final character of the pulp is developed in the **refining** (beating) operation. Pulp fibers are fibrillated, hydrated, and cut. The fibers are roughened and frayed, and a gelatinous substance is produced. This results in greater fiber coherence in the finished paper.

#### Sizing, Loading, and Coating

**Sizing** is used, principally in book papers, to make the paper water-repellant and to enhance interfiber bonding and surface characteristics. Sizing materials may be premixed with the pulp or applied after sheet formation.

**Loading materials**, or fillers, are used by the papermaker to smooth the surface, to provide ink affinity, to brighten color, and to increase opacity. The most widely used fillers are clay and kaolin.

**Coatings** consisting of pigment and binder are often applied to the base stock to create better printing surfaces. A variety of particulate, inorganic materials are combined with binders such as starch or casein in paper coatings. Coating is generally followed by calendering.

#### Converting and Packaging

A host of products are made from paper; the converting industry represents a substantial portion of the total paper industry. Principal products are in the fine-paper and book-paper fields. Slush pulps are used to make molded pulp products such as egg cartons and paper plates.

Combinations of paper laminated with other materials such as plastic film and metal foil have found wide use in the packaging market.

#### Plastic-Fiber Paper

A tough, durable product, such as Tyvek, can be made from 100 percent high-density polyethylene fibers by spinning very fine fibers and then bonding them together with heat and pressure. Binders, sizes, or fillers are not required. Such sheets combine some of the best properties of the fabrics, films, and papers with excellent puncture resistance. They can readily be printed by conventional processes, dyed to pastel colors, embossed for decorative effects, coated with a range of materials, and can be folded, sheeted, die-cut, sewn, hot-melt-sealed, glued, and pasted. Nylon paper, such as Nomex type 410, is produced from short fibers (floc) and smaller binder particles (fibrils) of a high-temperature-resistant polyamide polymer, formed into a sheet product without additional binders, fillers, or sizes, and calendered with heat and pressure to form a nonporous structure. It possesses excellent electrical, thermal, and mechanical properties, and finds use in the electrical industry. Fiber impregnation of ordinary paper, using glass or plastic fibers, produces a highly tear-resistant product.

#### Recycling

In the current environmentally conscious climate, almost 50 percent of newsprint itself contains a portion of recycled old newsprint. The re-

mainder, together with almost all other paper products, finds a ready market for recycling into other end products. The small portion that ends up discarded is increasingly used as feedstock for incineration plants which produce power and/or process steam by converting “scrap paper” and other refuse to refuse-derived fuel (RDF). See Sec. 7.4. Only in those geographic areas where it is impractical to collect and recycle paper does the residue finally find its way to landfill dumps.

#### ROOFING MATERIALS

REFERENCES: Abraham, “Asphalts and Allied Substances,” Van Nostrand. Grondal, “Certigrade Handbook of Red Cedar Shingles,” Red Cedar Shingle Bureau, Seattle, Wash. ASTM *Special Technical Publication* 409, “Engineering Properties of Roofing Systems,” ASTM. Griffin, Jr., “Manual of Built-up Roof Systems,” McGraw-Hill. “1986 Annual Book of ASTM Standards,” vol. 04.04 (Roofing, Waterproofing and Bituminous Materials).

**Asphalt** Asphalts are bitumens, and the one most commonly seen in roofing and paving is obtained from petroleum residuals. These are obtained by the refining of petroleum. The qualities of asphalt are affected by the nature of the crude and the process of refining. When the flux asphalts obtained from the oil refineries are treated by blowing air through them while the asphalt is maintained at a high temperature, a material is produced which is very suitable and has good weathering properties.

**Coal Tar** Coal tar is more susceptible to temperature change than asphalt; therefore, for roofing purposes its use is usually confined to flat decks.

**Asphalt prepared roofing** is manufactured by impregnating a dry roofing felt with a hot asphaltic saturant. A coating consisting of a harder asphalt compounded with a fine mineral filler is applied to the weather side of the saturated felt. Into this coating is embedded mineral surfacing such as mineral granules, powdered talc, mica, or soapstone. The reverse side of the roofing has a very thin coating of the same asphalt which is usually covered with powdered talc or mica to prevent the roofing from sticking in the package. The surfacing used on **smooth-surfaced roll roofing** is usually powdered talc or mica. The surfacing used on **mineral- or slate-surfaced roll roofing** is roofing granules either in natural colors prepared from slate or artificial colors usually made by applying a coating to a rock granule base. **Asphalt shingles** usually have a granular surfacing. They are made in strips and as individual shingles. The different shapes and sizes of these shingles provide single, double, and triple coverage of the roof deck.

**Materials Used in Asphalt Prepared Roofing** The felt is usually composed of a continuous sheet of felted fibers of selected rag, specially prepared wood, and high-quality waste papers. The constituents may be varied to give a felt with the desired qualities of strength, absorbency, and flexibility. (See above, Fibers and Fabrics.)

The most satisfactory roofing **asphalts** are obtained by air-blowing a steam- or vacuum-refined petroleum residual. Saturating asphalts must possess a low viscosity in order for the felt to become thoroughly impregnated. Coating asphalts must have good weather-resisting qualities and possess a high fusion temperature in order that there will be no flowing of the asphalt after the application to the roof.

**Asphalt built-up roof coverings** usually consist of several layers of asphalt-saturated felt with a continuous layer of hot-mopped asphalt between the layers of felt. The top layer of such a roof covering may consist of a hot mopping of asphalt only, a top pouring of hot asphalt with slag or gravel embedded therein, or a mineral-surfaced cap sheet embedded in a hot mopping of asphalt.

**Wood shingles** are usually manufactured in three different lengths: 16, 18, and 24 in. There are three grades in each length: no. 1 is the best, and no. 3 is intended for purposes where the presence of defects is not objectionable. Red-cedar shingles of good quality are obtainable from the Pacific Coast; in the South, red cypress from the Gulf states is preferable. Redwood shingles come 5½ butts to 2 in; lesser thicknesses are more likely to crack and have shorter life. Shingles 8 in wide or over should be split before laving. Dimension shingles of uniform width are

obtainable. Various stains are available for improved weathering resistance and altered appearance.

**Asbestos shingles** and (siding) are no longer made, but will be found from applications made in the past. The following is presented for information in the event the reader has occasion to deal with this product. They are composed of portland cement reinforced with asbestos fiber and are formed under pressure. They resist the destructive effects of time, weather, and fire. Asbestos shingles (American method) weigh about 500 lb per square (roofing to cover 100 ft<sup>2</sup>) and carry Underwriter's class A label. Asbestos shingles are made in a variety of colors and shapes. Asbestos roofing shingles have either a smooth surface or a textured surface which represents wood graining.

**Slate** should be hard and tough and should have a well-defined vein that is not too coarse. Roofing slates in place will weigh from 650 to over 1,000 lb per square, depending on the thickness and the degree of overlap. Prudent roofing practice in installing slate roofs requires use of copper (or stainless steel) nails and, as appropriate, the installation of snow guards to prevent snow slides. When applied thus, slate proved long-lasting and able to maintain weathertight integrity in all climates. The quarrying is labor-intensive, however, as is the splitting required to render it into suitably thin pieces; installation labor is extremely expensive, and the substructure must be of heavier than usual construction to withstand the higher dead load of the roofing slates. For these reasons, among others, slate is used rarely for roofing in the current market. Slate roofing is available in a variety of sizes and colors and has good fire resistance. (See above, Natural Stones.)

**Metallic roofings** are usually laid in large panels, often strengthened by corrugating, but they are sometimes cut into small sizes bent into interlocking shapes and laid to interlock with adjacent sheets or shingles. Metallic roofing panels of both aluminum and steel are available with a variety of prefinished surface treatments to enhance weatherability. Metal tile and metal shingles are usually made of copper, copper-bearing galvanized steel, tinplate, zinc, or aluminum. The lightest metal shingle is the one made from aluminum, which weighs approximately 40 lb per square. The metal radiates solar heat, resulting in lower temperatures beneath than with most other types of uninsulated roofs. Terne-coated stainless steel is unusually resistant to weathering and corrosion.

**Roofing cements and coatings** are usually made from asphalt, a fibrous filler, and solvents to make the cement workable. Asbestos fibers traditionally were used as filler, but asbestos is no longer used; instead, fiberglass largely has replaced it. The cements are used for flashings and repairs and contain slow-drying oils so that they will remain plastic on long exposure. Roof coatings are used to renew old asphalt roofings.

Asphalt-base aluminum roof coatings are used to renew old asphalt roofs, and to prolong the service life of smooth-surfaced roofs, new or old.

**Tile** Hard-burned clay tiles with overlapping or interlocking edges cost about the same as slate. They should have a durable glaze and be well made. Unvitrified tiles with slip glaze are satisfactory in warm climates, but only vitrified tiles should be used in the colder regions. Tile roofs weigh from 750 to 1,200 lb per square. Properly made, tile does not deteriorate, is a poor conductor of heat and cold, and is not as brittle as slate. Fiberglass, saturated with asphalt and embedded with ceramic granules, is made into roof shingles having an exceptionally long life. Such shingles possess class A fire-resistant qualities, and tend also to be dimensionally very stable. Glass-fiber mats coated with weathering-grade asphalt can be had in rolls.

#### Elastomers

The trend toward irregular roof surfaces—folded plates, hyperbolic paraboloids, domes, barrel shells—has brought the increased use of plastics or synthetic rubber elastomers (applied as fluid or sheets) as roofing membranes. Such membranes offer light weight, adaptability to any roof slope, good heat reflectivity, and high elasticity at moderate temperatures. Negatively, elastomeric membranes have a more limited range of satisfactory substrate materials than conventional ones. Table 6.8.11 presents several such membranes, and the method of use.

#### RUBBER AND RUBBERLIKE MATERIALS (ELASTOMERS)

REFERENCES: Dawson and Porritt, "Rubber: Physical and Chemical Properties," Research Association of British Rubber Manufacturers. Davis and Blake, "The Chemistry and Technology of Rubber," Reinhold. ASTM Standards on Rubber Products. "Rubber Red Book Directory of the Rubber Industry," *The Rubber Age*. Flint, "The Chemistry and Technology of Rubber Latex," Van Nostrand. "The Vanderbilt Handbook," R. T. Vanderbilt Co. Whitby, Davis, and Dunbrook, "Synthetic Rubber," Wiley. "Rubber Bibliography," Rubber Division, American Chemical Society. Noble, "Latex in Industry," *The Rubber Age*. "Annual Report on the Progress of Rubber Technology," Institution of the Rubber Industry. Morton (ed.), "Rubber Technology," Van Nostrand Reinhold. ISO 188-1982. "1986 Annual Book of ASTM Standards," vols. 09.01, 09.02 (Rubber).

To avoid confusion by the use of the word **rubber** for a variety of natural and synthetic products, the term **elastomer** has come into use, particularly in scientific and technical literature, as a name for both natural and

Table 6.8.11 Elastomeric Membranes

	Material	Method of application	Number of coats or sheets
Fluid-applied	Neoprene-Hypalon*	Roller, brush, or spray	2 + 2
	Silicone	Roller, brush, or spray	2
	Polyurethane foam, Hypalon* coating	Spray	2
	Clay-type asphalt emulsion reinforced with chopped glass fibers†	Spray	1
	Sheet-applied	Chlorinated polyethylene on foam	Adhesive
Sheet-applied	Hypalon* on asbestos felt	Adhesive	1
	Neoprene-Hypalon*	Adhesive	1 + surface paint
	Tedlar‡ on asbestos felt	Adhesive	1
	Butyl rubber	Adhesive	1
Traffic decks	Silicone plus sand	Trowel	1 + surface coat
	Neoprene with aggregate§	Trowel	1 + surface coat

\* Registered trademark of E. I. du Pont de Nemours & Co., for chlorosulfonated polyethylene.

† Frequently used with coated base sheet.

‡ Registered trademark of E. I. du Pont de Nemours & Co. for polyvinyl fluoride.

§ Aggregate may be flint, sand, or crushed walnut shells.

SOURCE: C. W. Griffin, Jr., "Manual of Built-up Roof Systems," McGraw-Hill, 1970, with permission of the publisher.

synthetic materials which are elastic or resilient and in general resemble natural rubber in feeling and appearance.

The utility of rubber and synthetic elastomers is increased by compounding. In the raw state, elastomers are soft and sticky when hot, and hard or brittle when cold. **Vulcanization** extends the temperature range within which they are flexible and elastic. In addition to vulcanizing agents, ingredients are added to make elastomers stronger, tougher, and harder, to make them age better, to color them, and in general to modify them to meet the needs of service conditions. Few rubber products today are made from rubber or other elastomers alone.

The elastomers of greatest commercial and technical importance today are natural rubber, GR-S, Neoprene, nitrile rubbers, and butyl.

**Natural rubber** of the best quality is prepared by coagulating the latex of the *Hevea brasiliensis* tree, cultivated chiefly in the Far East. This represents nearly all of the natural rubber on the market today.

Unloaded vulcanized rubber will stretch to approximately 10 times its length and at this point will bear a load of  $13.8 \times 10^6 \text{ N/m}^2$  (10 tons/in<sup>2</sup>). It can be compressed to one-third its thickness thousands of times without injury. When most types of vulcanized rubber are stretched, their resistance increases in greater proportion than the extension. Even when stretched almost to the point of rupture, they recover very nearly their original dimensions on being released, and then gradually recover a part of the residual distortion.

Freshly cut or torn raw rubber possesses the power of **self-adhesion** which is practically absent in vulcanized rubber. Cold water preserves rubber, but if exposed to the air, particularly to the sun, rubber goods tend to become hard and brittle. Dry heat up to 49°C (120°F) has little deteriorating effect; at temperatures of 181 to 204°C (360 to 400°F) rubber begins to melt and becomes sticky; at higher temperatures, it becomes entirely carbonized. Unvulcanized rubber is **soluble** in gasoline, naphtha, carbon bisulfide, benzene, petroleum ether, turpentine, and other liquids.

Most rubber is **vulcanized**, i.e., made to combine with sulfur or sulfur-bearing organic compounds or with other chemical cross-linking agents. Vulcanization, if properly carried out, improves mechanical properties, eliminates tackiness, renders the rubber less susceptible to temperature changes, and makes it insoluble in all known solvents. It is impossible to dissolve vulcanized rubber unless it is first decomposed. Other ingredients are added for general effects as follows:

To increase tensile strength and resistance to abrasion: carbon black, precipitated pigments, as well as organic vulcanization accelerators.

To cheapen and stiffen: whiting, barytes, talc, silica, silicates, clays, fibrous materials.

To soften (for purposes of processing or for final properties): bituminous substances, coal tar and its products, vegetable and mineral oils, paraffin, petrolatum, petroleum oils, asphalt.

Vulcanization accessories, dispersion and wetting mediums, etc.: magnesium oxide, zinc oxide, litharge, lime, stearic and other organic acids, degreas, pine tar.

Protective agents (natural aging, sunlight, heat, flexing): condensation amines, waxes.

Coloring pigments: iron oxides, especially the red grades, lithopone, titanium oxide, chromium oxide, ultramarine blue, carbon and lampblacks, and organic pigments of various shades.

Specifications should state suitable physical tests. Tensile strength and extensibility tests are of importance and differ widely with different compounds.

**GR-S** is an outgrowth and improvement of German Buna S. The quantity now produced far exceeds all other synthetic elastomers. It is made from butadiene and styrene, which are produced from petroleum. These two materials are copolymerized directly to GR-S, which is known as a butadiene-styrene copolymer. GR-S has *recently* been improved, and now gives excellent results in tires.

**Neoprene** is made from acetylene, which is converted to vinylacetylene, which in turn combines with hydrogen chloride to form chloroprene. The latter is then polymerized to Neoprene.

**Nitrile rubbers**, an outgrowth of German Buna N or Perbunan, are made by a process similar to that for GR-S, except that acrylonitrile is

used instead of styrene. This type of elastomer is a butadiene-acrylonitrile copolymer.

**Butyl**, one of the most important of the synthetic elastomers, is made from petroleum raw materials, the final process being the copolymerization of isobutylene with a very small proportion of butadiene or isoprene.

**Polysulfide rubbers** having unique resistance to oxidation and to softening by solvents are commercially available and are sold under the trademark Thiokol.

**Ethylene-propylene** rubbers are notable in their oxidation resistance. **Polyurethane** elastomers can have a tensile strength up to twice that of conventional rubber, and solid articles as well as foamed shapes can be cast into the desired form using prepolymer shapes as starting materials. **Silicone** rubbers have the advantages of a wide range of service temperatures and room-temperature curing. **Fluorocarbon** elastomers are available for high-temperature service. Polyester elastomers have excellent impact and abrasion resistance.

No one of these elastomers is satisfactory for all kinds of service conditions, but rubber products can be made to meet a large variety of service conditions.

The following examples show some of the important properties required of rubber products and some typical services where these properties are of major importance:

*Resistance to abrasive wear:* auto-tire treads, conveyor-belt covers, soles and heels, cables, hose covers, V belts.

*Resistance to tearing:* auto inner tubes, tire treads, footwear, hot-water bags, hose covers, belt covers, V belts.

*Resistance to flexing:* auto tires, transmission belts, V belts, (see Sec. 8.2 for information concerning types, sizes, strengths, etc., of V belts), mountings, footwear.

*Resistance to high temperatures:* auto tires, auto inner tubes, belts conveying hot materials, steam hose, steam packing.

*Resistance to cold:* airplane parts, automotive parts, auto tires, refrigeration hose.

*Minimum heat buildup:* auto tires, transmission belts, V belts, mountings.

*High resilience:* auto inner tubes, sponge rubber, mountings, elastic bands, thread, sandblast hose, jar rings, V belts.

*High rigidity:* packing, soles and heels, valve cups, suction hose, battery boxes.

*Long life:* fire hose, transmission belts, tubing, V belts.

*Electrical resistivity:* electricians' tape, switchboard mats, electricians' gloves.

*Electrical conductivity:* hospital flooring, nonstatic hose, matting.

*Impermeability to gases:* balloons, life rafts, gasoline hose, special diaphragms.

*Resistance to ozone:* ignition distributor gaskets, ignition cables, windshield wipers.

*Resistance to sunlight:* wearing apparel, hose covers, bathing caps.

*Resistance to chemicals:* tank linings, hose for chemicals.

*Resistance to oils:* gasoline hose, oil-suction hose, paint hose, creamery hose, packinghouse hose, special belts, tank linings, special footwear.

*Stickiness:* cements, electricians' tapes, adhesive tapes, pressure-sensitive tapes.

*Low specific gravity:* airplane parts, forestry hose, balloons.

*No odor or taste:* milk tubing, brewery and wine hose, nipples, jar rings.

*Special colors:* ponchos, life rafts, welding hose.

Table 6.8.12 gives a comparison of some important characteristics of the most important elastomers when vulcanized. The lower part of the table indicates, for a few representative rubber products, preferences in the use of different elastomers for different service conditions without consideration of cost.

Specifications for rubber goods may cover the chemical, physical, and mechanical properties, such as elongation, tensile strength, permanent set, and oven tests, minimum rubber content, exclusion of reclaimed rubber, maximum free and combined sulfur contents, maxi-

Table 6.8.12 Comparative Properties of Elastomers

	Natural rubber	GR-S	Neoprene	Nitrile rubbers	Butyl	Thiokol
Tensile properties	Excellent	Good	Very good	Good	Good	Fair
Resistance to abrasive wear	Excellent	Good	Very good	Good	Good	Poor
Resistance to tearing	Very good	Poor	Good	Fair	Very good	Poor
Resilience	Excellent	Good	Good	Fair	Poor	Poor
Resistance to heat	Good	Fair	Good	Excellent	Good	Poor
Resistance to cold	Excellent	Good	Good	Good	Excellent	Poor
Resistance to flexing	Excellent	Good	Very good	Good	Excellent	Poor
Aging properties	Excellent	Excellent	Good	Good	Excellent	Good
Cold flow (creep)	Very low	Low	Low	Very low	Fairly low	High
Resistance to sunlight	Fair	Fair	Excellent	Good	Excellent	Excellent
Resistance to oils and solvents	Poor	Poor	Good	Excellent	Fair	Excellent
Permeability to gases	Fairly low	Fairly low	Low	Fairly low	Very low	Very low
Electrical insulation	Fair	Excellent	Fair	Poor	Excellent	Good
Flame resistance	Poor	Poor	Good	Poor	Poor	Poor
Auto tire tread	Preferred	Alternate				
Inner tube	Alternate				Preferred	
Conveyor-belt cover	Preferred		Alternate			
Tire sidewall	Alternate	Preferred				
Transmission belting	Preferred		Alternate			
Druggist sundries	Preferred					
Gasoline and oil hose				Preferred		
Lacquer and paint hose						Preferred
Oil-resistant footwear			Preferred			
Balloons	Alternate		Preferred			
Jar rings	Alternate	Preferred				
Wire and cable insulation	Alternate	Preferred				

mum acetone and chloroform extracts, ash content, and many construction requirements. It is preferable, however, to specify properties such as resilience, hysteresis, static or dynamic shear and compression modulus, flex fatigue and cracking, creep, electrical properties, stiffening, heat generation, compression set, resistance to oils and chemicals, permeability, brittle point, etc., in the temperature range prevailing in service, and to leave the selection of the elastomer to a competent manufacturer.

**Latex**, imported in stable form from the Far East, is used for various rubber products. In the manufacture of such products, the latex must be compounded for vulcanizing and otherwise modifying properties of the rubber itself. Important products made directly from compounded latex include surgeons' and household gloves, thread, bathing caps, rubberized textiles, balloons, and sponge. A recent important use of latex is for "foam sponge," which may be several inches thick and used for cushions, mattresses, etc.

**Gutta-percha** and **balata**, also natural products, are akin to rubber chemically but more leathery and thermoplastic, and are used for some special purposes, principally for submarine cables, golf balls, and various minor products.

#### Rubber Derivatives

Rubber derivatives are chemical compounds and modifications of rubber, some of which have become of commercial importance.

**Chlorinated rubber**, produced by the action of chlorine on rubber in solution, is nonrubbery, incombustible, and extremely resistant to many chemicals. As commercial **Parlon**, it finds use in corrosion-resistant paints and varnishes, in inks, and in adhesives.

**Rubber hydrochloride**, produced by the action of hydrogen chloride on rubber in solution, is a strong, extensible, tear-resistant, moisture-resistant, oil-resistant material, marketed as **Pliofilm** in the form of tough transparent films for wrappers, packaging material, etc.

**Cyclized rubber** is formed by the action of certain agents, e.g., sulfonic acids and chlorostannic acid, on rubber, and is a thermoplastic, nonrubbery, tough or hard product. One form, **Thermoprene**, is used in the **Vulcalock process** for adhering rubber to metal, wood, and concrete, and in chemical-resistant paints. **Pliolite**, which has high resistance to many chemicals and has low permeability, is used in special paints, paper, and fabric coatings. **Marbon-B** has exceptional electrical properties and is

valuable for insulation. **Hypalon** (chlorosulphonated polyethylene) is highly resistant to many important chemicals, notably ozone and concentrated sulfuric acid, for which other rubbers are unsuitable.

#### SOLVENTS

REFERENCES: Sax, "Dangerous Properties of Industrial Materials," Reinhold. Perry, "Chemical Engineers' Handbook," McGraw-Hill. Doolittle, "The Technology of Solvents and Plasticizers," Wiley. Riddick and Bunger, "Organic Solvents," Wiley. Mellan, "Industrial Solvents Handbook," Nages Data Corp., New Jersey. "1986 Annual Book of ASTM Standards," vol: 15.05 (Halogenated Organic Solvents).

The use of solvents has become widespread throughout industry. The health of personnel and the fire hazards involved should always be considered. Generally, solvents are **organic liquids** which vary greatly in solvent power, flammability, volatility, and toxicity.

#### Solvents for Polymeric Materials

A wide choice of solvents and solvent combinations is available for use with organic polymers in the manufacture of polymer-coated products and unsupported films. For a given polymer, the choice of solvent system is often critical in terms of solvent power, cost, safety, and evaporation rate. In such instances, the supplier of the base polymer should be consulted.

#### Alcohols

**Methyl alcohol (methanol)** is now made synthetically. It is completely miscible with water and most organic liquids. It evaporates rapidly and is a good solvent for dyes, gums, shellac, nitrocellulose, and some vegetable waxes. It is widely used as an antifreeze for automobiles, in shellac solutions, spirit varnishes, stain and paint removers. It is toxic; imbibition or prolonged breathing of the vapors can cause blindness. It should be used only in well-ventilated spaces. Flash point 11°C (52°F).

**Ethyl alcohol (ethanol)** is produced by fermentation and synthetically. For industrial use it is generally denatured and sold under various trade names. There are numerous formulations of specially denatured alcohols which can legally be used for specified purposes.

This compound is miscible with water and most organic solvents. It

evaporates rapidly and, because of its solvent power, low cost, and agreeable odor, finds a wide range of uses. The common uses are anti-freeze (see Freezing Preventives, above), shellac solvent, in mixed solvents, spirit varnishes, and solvent for dyes, oils, and animal greases.

Denatured alcohols are toxic when taken orally. Ethyl alcohol vapors when breathed in high concentration can produce the physiological effects of alcoholic liquors. It should be used in well-ventilated areas. Flash point 15.3 to 16.7°C (96 to 62°F).

**Isopropyl alcohol (isopropanol)** is derived mainly from petroleum gases. It is not as good a solvent as denatured alcohol, although it can be used as a substitute for ethyl alcohol in some instances. It is used as a rubbing alcohol and in lacquer thinners. Flash point is 11°C (52°F).

**Butyl alcohol (normal butanol)** is used extensively in lacquer and synthetic resin compositions and also in penetrating oils, metal cleaners, insect sprays, and paints for application over asphalt. It is an excellent blending agent for otherwise incompatible materials. Flash point is 29°C (84°F).

### Esters

**Ethyl acetate** dissolves a large variety of materials, such as nitrocellulose oils, fats, gums, and resins. It is used extensively in nitrocellulose lacquers, candy coatings, food flavorings, and in chemical synthesis. On account of its high rate of evaporation, it finds a use in paper, leather, and cloth coatings and cements. Flash point -4.5°C (24°F).

**Butyl acetate** is the acetic-acid ester of normal butanol. This ester is used extensively for dissolving various cellulose esters, mineral and vegetable oils, and many synthetic resins, such as the vinylites, polystyrene, methyl methacrylate, and chlorinated rubber. It is also a good solvent for natural resins. It is the most important solvent used in lacquer manufacture. It is useful in the preparation of perfumes and synthetic flavors. Flash point 22.3°C (72°F).

**Amyl acetate**, sometimes known as banana oil, is used mainly in lacquers. Its properties are somewhat like those of butyl acetate. Flash point 21.1°C (70°F).

### Hydrocarbons

Some industrial materials can be dangerous, toxic, and carcinogenic. The reader should become familiar with the references listed under Chlorinated Solvents in this section, which discuss the health hazards of industrial materials.

The **aromatic hydrocarbons** are derived from coal-tar distillates, the most common of which are benzene, toluene, xylene (also known as benzol, toluol, and xylol), and high-flash solvent naphtha.

**Benzene** is an excellent solvent for fats, vegetable and mineral oils, rubber, chlorinated rubber; it is also used as a solvent in paints, lacquers, inks, paint removers, asphalt, coal tar. This substance should be used with caution. Flash point 12°F.

**Toluene** General uses are about the same as benzol, in paints, lacquers, rubber solutions, and solvent extractions. Flash point 40°F.

**Xylene** is used in the manufacture of dyestuffs and other synthetic chemicals and as a solvent for paints, rubber, lacquer, and varnishes. Flash point 63°F.

**Hi-flash naphtha or coal-tar naphtha** is used mainly as a diluent in lacquers, synthetic enamels, paints, and asphaltic coatings. Flash point 100°F.

### Petroleum

These hydrocarbons, derived from petroleum, are, next to water, the cheapest and most universally used solvents.

**V. M. & P. naphtha**, sometimes called **benzine**, is used by paint and varnish makers as a solvent or diluent. It finds wide use as a solvent for fats, oils, greases and is used as a diluent in paints and lacquers. It is also used as an extractive agent as well as in some specialized fields of cleansing (fat removal). It is used to compound rubber cement, inks, varnish removers. It is relatively nontoxic. Flash point 20 to 45°F.

**Mineral spirits**, also called **Stoddard solvent**, is extensively used in dry cleaning because of its high flash point and clean evaporation. It is also

widely used in turpentine substitutes for oil paints. Flash point 100 to 110°F.

**Kerosine**, a No. 1 fuel oil, is a good solvent for petroleum greases, oils, and fats. Flash point 100 to 165°F.

### Chlorinated Solvents

Solvents can pose serious health and environmental problems, therefore the reader's attention is called to the following publications: (1) "Industrial Health and Safety; Mutagens and Carcinogens; Solution; Toxicology," vols. 1 to 3, Wiley. (2) "Patty's Industrial Hygiene and Toxicology," vol. 1 (General Principles), vol. 2 (Toxicology), vol. 3 (Industrial Hygiene Practices). (3) Peterson, "Industrial," Prentice-Hall. (4) Sax and Lewis, "Dangerous Properties of Industrial Materials," 7th ed., Van Nostrand Reinhold. Section 18 of this handbook.

The chlorinated hydrocarbons and fluorocarbon solvents are highly proscribed for use in industry and in society in general because of the inherent health and/or environmental problems ascribed to them. These materials are highly regulated and when used should be handled with utmost care and under close supervision and accountable control.

**Carbon tetrachloride** is a colorless nonflammable liquid with a chloroformlike odor. It is an excellent solvent for fats, oils, greases, waxes, and resins and was used in dry cleaning and in degreasing of wool, cotton waste, and glue. It is also used in rubber cements and adhesives, as an extracting agent, and in fire extinguishers. It should be used only in well-ventilated spaces; prolonged inhalation is extremely dangerous.

**Trichlorethylene** is somewhat similar to carbon tetrachloride but is slower in evaporation rate. It is the solvent most commonly used for vapor degreasing of metal parts. It is also used in the manufacture of dyestuffs and other chemicals. It is an excellent solvent and is used in some types of paints, varnishes, and leather coatings.

**Tetrachlorethylene**, also called **perchlorethylene**, is nonflammable and has uses similar to those of carbon tetrachloride and trichlorethylene. Its chief use is in dry cleaning; it is also used in metal degreasing.

### Ketones

**Acetone** is an exceptionally active solvent for a wide variety of organic materials, gases, liquids, and solids. It is completely miscible with water and also with most of the organic liquids. It can also be used as a blending agent for otherwise immiscible liquids. It is used in the manufacture of pharmaceuticals, dyestuffs, lubricating compounds, and pyroxylin compositions. It is a good solvent for cellulose acetate, ethyl cellulose, vinyl and methacrylate resins, chlorinated rubber, asphalt, camphor, and various esters of cellulose, including smokeless powder, cordite, etc. Some of its more common uses are in paint and varnish removers, the storing of acetylene, and the dewaxing of lubricating oils. It is the basic material for the manufacture of iodoform and chloroform. It is also used as a denature for ethyl alcohol. Flash point 0°F.

**Methylethylketone (MEK)** can be used in many cases where acetone is used as a general solvent, e.g., in the formulation of pyroxylin cements and in compositions containing the various esters of cellulose. Flash point 30°F.

**Glycol ethers** are useful as solvents for cellulose esters, lacquers, varnishes, enamels, wood stains, dyestuffs, and pharmaceuticals.

### THERMAL INSULATION

REFERENCES: "Guide and Data Book," ASHRAE. Glaser, "Aerodynamically Heated Structures," Prentice-Hall. Timmerhaus, "Advances in Cryogenic Engineering," Plenum. Wilkes, "Heat Insulation," Wiley. Wilson, "Industrial Thermal Insulation," McGraw-Hill. Technical Documentary Report ML-TDR-64-5, "Thermophysical Properties of Thermal Insulating Materials," Air Force Materials Laboratory, Research and Technology Division, Air Force Systems Command; Prepared by Midwest Research Institute, Kansas City, MO. Probert and Hub (eds.), "Thermal Insulation," Elsevier. Malloy, "Thermal Insulation," Van Nostrand Reinhold. "1986 Annual Book of ASTM Standards," vol. 04.06 (Thermal Insulation). ANSI/ASTM Standards.

Thermal insulation consisting of a single material, a mixture of materials, or a composite structure is chosen to reduce heat flow. **Insulating effectiveness** is judged on the basis of thermal conductivity and depends on the physical and chemical structure of the material. The heat transferred through an insulation results from **solid conduction, gas conduction, and radiation**. Solid conduction is reduced by small particles or fibers in loose-fill insulation and by thin cell walls in foams. Gas conduction is reduced by providing large numbers of small pores (either interconnected or closed off from each other) of the order of the mean free paths of the gas molecules, by substituting gases of low thermal conductivity, or by evacuating the pores to a low pressure. Radiation is reduced by adding materials which absorb, reflect, or scatter radiant energy. (See also Sec. 4, Transmission of Heat by Conduction and Convection.)

The **performance** of insulations depends on the temperature of the bounding surfaces and their emittance, the insulation density, the type and pressure of gas within the pores, the moisture content, the thermal shock resistance, and the action of mechanical loads and vibrations. In **transient** applications, the heat capacity of the insulation (affecting the rate of heating or cooling) has to be considered.

The **form** of the **insulations** can be loose fill (bubbles, fibers, flakes, granules, powders), flexible (batting, blanket, felt, multilayer sheets, and tubular), rigid (block, board, brick, custom-molded, sheet and pipe covering), cemented, foamed-in-place, or sprayed.

The choice of **insulations** is dictated by the service-temperature range as well as by design criteria and economic considerations.

#### Cryogenic Temperatures [below $-102^{\circ}\text{C}$ ( $-150^{\circ}\text{F}$ )]

(See also Sec. 19.)

At the low temperatures experienced with cryogenic liquids, **evacuated multilayer insulations**, consisting of a series of radiation shields of high reflectivity separated by low-conductivity spacers, are effective materials. Radiation shield materials are aluminum foils or aluminized polyester films used in combination with spacers of thin polyester fiber or glass-fiber papers; radiation shields of crinkled, aluminized polyester film without spacers are also used. To be effective, multilayer insulations require a vacuum of at least  $10^{-4}$  mmHg. **Evacuated powder and fiber insulations** can be effective at gas pressures up to 0.1 mmHg over a wide temperature range. **Powders** include colloidal silica ( $8 \times 10^{-7}$  in particle diam), silica aerogel ( $1 \times 10^{-6}$  in), synthetic calcium silicate (0.001 in), and perlite (an expanded form of glassy volcanic lava particles, 0.05 in diam). Powder insulations can be **opacified** with copper, aluminum, or carbon particles to reduce radiant energy transmission. **Fiber insulations** consist of mats of fibers arranged in ordered parallel layers either without binders or with a minimum of binders. Glass fibers ( $10^{-5}$  in diam) are used most frequently. For large process installations and cold boxes, unevacuated perlite powder or mineral fibers are useful.

Cellular glass (see Glass, this section) can be used for temperatures as low as  $-450^{\circ}\text{F}$  ( $-268^{\circ}\text{C}$ ) and has found use on liquefied natural gas tank bases.

**Foamed organic plastics**, using either fluorinated hydrocarbons or other gases as expanding agents, are partially evacuated when gases within the closed cells condense when exposed to low temperatures. Polystyrene and polyurethane foams are used frequently. **Gastight barriers** are required to prevent a rise in thermal conductivity with aging due to diffusion of air and moisture into the foam insulation. Gas barriers are made of aluminum foil, polyester film, and polyester film laminated with aluminum foil.

#### Refrigeration, Heating, and Air Conditioning up to $120^{\circ}\text{C}$ ( $250^{\circ}\text{F}$ )

At temperatures associated with commercial refrigeration practice and building insulation, **vapor barriers** resistant to the diffusion of water vapor should be installed on the warm side of most types of insulations if the temperature within the insulation is expected to fall below the dew point (this condition would lead to condensation of water vapor within the insulation and result in a substantial decrease in insulating effectiveness). Vapor barriers include oil- or tar-impregnated paper, paper lami-

nated with aluminum foil, and polyester films. Insulations which have an impervious outer skin or structure require a **vaportight sealant** at exposed joints to prevent collection of moisture or ice underneath the insulation. (See also Secs. 12 and 19.)

**Loose-fill insulations** include powders and granules such as perlite, vermiculite (an expanded form of mica), silica aerogel, calcium silicate, expanded organic plastic beads, granulated cork (bark of the cork tree), granulated charcoal, redwood wool (fiberized bark of the redwood tree), and synthetic fibers. The most widely used fibers are those made of glass, rock, or slag produced by centrifugal attenuation or attenuation by hot gases.

**Flexible or blanket insulations** include those made from organically bonded glass fibers; rock wool, slag wool, macerated paper, or hair felt placed between or bonded to paper laminate (including vapor-barrier material) or burlap; foamed organic plastics in sheet and pad form (polyurethane, polyethylene); and elastomeric closed-cell foam in sheet, pad, or tube form.

**Rigid or board insulations** (obtainable in a wide range of densities and structural properties) include foamed organic plastics such as polystyrene (extended or molded beads); polyurethane, polyvinyl chloride, phenolics, and ureas; balsa wood, cellular glass, and corkboard (compressed mass of baked-cork particles).

#### Moderate Temperatures [up to $650^{\circ}\text{C}$ ( $1200^{\circ}\text{F}$ )]

The widest use of a large variety of insulations is in the temperature range associated with power plants and industrial equipment. Inorganic insulations are available for this temperature range, with several capable of operating over a wider temperature range.

**Loose-fill insulations** include diatomaceous silica (fossilized skeletons of microscopic organisms), perlite, vermiculite, and fibers of glass, rock, or slag. Board and blanket insulations of various shapes and degrees of flexibility and density include glass and mineral fibers, asbestos paper, and millboard [asbestos is a heat-resistant fibrous mineral obtained from Canadian (chrysotile) or South African (amosite) deposits]; asbestos fibers bonded with sodium silicate, 85 percent basic magnesium carbonate, expanded perlite bonded with calcium silicate, calcium silicate reinforced with asbestos fibers, expanded perlite bonded with cellulose fiber and asphalt, organic bonded mineral fibers, and cellulose fiberboard.

**Sprayed insulation** (macerated paper or fibers and adhesive or frothed plastic foam), **insulating concrete** (concrete mixed with expanded perlite or vermiculite), and **foamed-in-place plastic insulation** (prepared by mixing polyurethane components, pouring the liquid mix into the void, and relying on action of generated gas or vaporization of a low boiling fluorocarbon to foam the liquid and fill the space to be insulated) are useful in special applications.

**Reflective insulations** form air spaces bounded by surfaces of high reflectivity to reduce the flow of radiant energy. Surfaces need not be mirror bright to reflect long-wavelength radiation emitted by objects below  $500^{\circ}\text{F}$ . Materials for reflective insulation include aluminum foil cemented to one or both sides of kraft paper and aluminum particles applied to the paper with adhesive. Where several reflective surfaces are used, they have to be separated during the installation to form airspaces.

Cellular glass can be used up to  $900^{\circ}\text{F}$  ( $482^{\circ}\text{C}$ ) alone and to  $1,200^{\circ}\text{F}$  ( $649^{\circ}\text{C}$ ) or higher when combined with other insulating materials and jackets.

#### High Temperatures [above $820^{\circ}\text{C}$ ( $1,500^{\circ}\text{F}$ )]

At the high temperatures associated with furnaces and process applications, physical and chemical stability of the insulation in an oxidizing, reducing, or neutral atmosphere or vacuum may be required. **Loose-fill insulations** include glass fibers  $538^{\circ}\text{C}$  ( $1,000^{\circ}\text{F}$ ) useful temperature limit, asbestos fibers  $650^{\circ}\text{C}$  ( $1,200^{\circ}\text{F}$ ), fibrous potassium titanate  $1,040^{\circ}\text{C}$  ( $1,900^{\circ}\text{F}$ ), alumina-silica fibers  $1,260^{\circ}\text{C}$  ( $2,300^{\circ}\text{F}$ ), micro-quartz fibers,  $1,370^{\circ}\text{C}$  ( $2,500^{\circ}\text{F}$ ), opacified colloidal alumina  $1,310^{\circ}\text{C}$  ( $2,400^{\circ}\text{F}$  in vacuum), zirconia fibers  $1,640^{\circ}\text{C}$  ( $3,000^{\circ}\text{F}$ ), alumina bubbles  $1,810^{\circ}\text{C}$  ( $3,300^{\circ}\text{F}$ ), zirconia bubbles  $2,360^{\circ}\text{C}$  ( $4,300^{\circ}\text{F}$ ), and carbon and graphite fibers  $2,480^{\circ}\text{C}$  ( $4,500^{\circ}\text{F}$ ) in vacuum or an inert atmosphere.

**Rigid insulations** include reinforced and bonded colloidal silica 1,090°C (2,000°F), bonded diatomaceous earth brick 1,370°C (2,500°F), insulating firebrick (see Refractories, below), and anisotropic pyrolytic graphite (100:1 ratio of thermal conductivity parallel to surface and across thickness).

**Reflective insulations**, forming either an airspace or an evacuated chamber between spaced surfaces, include stainless steel, molybdenum, tantalum, or tungsten foils and sheets.

**Insulating cements** are based on asbestos, mineral, or refractory fibers bonded with mixtures of clay or sodium silicate. Lightweight, castable insulating materials consisting of mineral or refractory fibers in a calcium aluminate cement are useful up to 2,500°F.

**Ablators** are composite materials capable of withstanding high temperatures and high gas velocities for limited periods with minimum erosion by subliming and charring at controlled rates. Materials include asbestos, carbon, graphite, silica, nylon or glass fibers in a high-temperature resin matrix (epoxy or phenolic resin), and cork compositions.

## SILICONES

(See also discussion in Sealants later.)

Silicones are organosilicon oxide polymers characterized by remarkable temperature stability, chemical inertness, waterproofness, and excellent dielectric properties. The investigations of Prof. Kipping in England for over forty years established a basis for the development of the numerous industrially important products now being made by the Dow-Corning Corp. of Medland, Mich., the General Electric Co., and by others. Among these products are the following:

**Water repellents** in the form of extremely thin films which can be formed on paper, cloth, ceramics, glass, plastics, leather, powders, or other surfaces. These have great value for the protection of delicate electrical equipment in moist atmospheres.

**Oils** with high flash points [above 315°C (600°F)], low pour points, -84.3°C (-120°F), and with a constancy of viscosity notably superior to petroleum products in the range from 260 to -73.3°C (500 to -100°F). These oil products are practically incombustible. They are in use for hydraulic servomotor fluids, damping fluids, dielectric liquids for transformers, heat-transfer mediums, etc., and are of special value in aircraft because of the rapid and extreme temperature variations to which aircraft are exposed. At present they are not available as lubricants except under light loads.

**Greases and compounds** for plug cocks, spark plugs, and ball bearings which must operate at extreme temperatures and speeds.

**Varnishes and resins** for use in electrical insulation where temperatures are high. Layers of glass cloth impregnated with or bounded by silicone resins withstand prolonged exposure to temperatures up to 260°C (500°F). They form paint finishes of great resistance to chemical agents and to moisture. They have many other industrial uses.

**Silicone rubbers** which retain their resiliency for -45 to 270°C (-50 to 520°F) but with much lower strength than some of the synthetic rubbers. They are used for shaft seals, oven gaskets, refrigerator gaskets, and vacuum gaskets.

Dimethyl silicone fluids and emulsions; organomodified silicone fluids and emulsions; organomodified reactive silicone fluids and emulsions; and silicone antifoam fluids, compounds, and emulsions find applications in coatings, paints, inks, construction, electrical and electronic industries, the foundry industry, etc.

## REFRACTORIES

REFERENCES: Buell, "The Open-Hearth Furnace," 3 vols., Penton. *Bull.* R-2-E, The Babcock & Wilcox Co. "Refractories," General Refractories Co. Chesters, "Steel Plant Refractories," United Steel Companies, Ltd. "Modern Refractory Practice," Harbison Walker Refractories Co. Green and Stewart, "Ceramics: A Symposium," British Ceramic Soc. ASTM Standards on Refractory Materials (Committee C-8). Trinks, "Industrial Furnaces," vol. I, Wiley. Campbell, "High Temperature Technology," Wiley. Budnikov, "The Technology of Ceramics and Refractories," MIT Press. Campbell and Sherwood (eds.). "High-Temperature

Materials and Technology," Wiley. Norton, "Refractories," 4th ed., McGraw-Hill. Clauss, "Engineer's Guide to High-Temperature Materials," Addison-Wesley. Shaw, "Refractories and Their Uses," Wiley. Chesters, "Refractories: Production and Properties," The Iron and Steel Institute, London. "1986 Annual Book of ASTM Standards," vol. 15.01 (Refractories). ANSI Standards B74.10-B74.8.

## Types of Refractories

**Fire-Clay Refractories** Fire-clay brick is made from fire clays, which comprise all refractory clays that are not white burning. Fire clays can be divided into plastic clays and hard flint clays; they may also be classified as to alumina content.

Firebricks are usually made of a blended mixture of flint clays and plastic clays which is then formed, after mixing with water, to the required shape. Some or all of the flint clay may be replaced by highly burned or calcined clay, called **grog**. A large proportion of modern bricks are molded by the dry press or power press process where the forming is carried out under high pressure and with a low water content. Some extruded and hand-molded bricks are still made.

The dried bricks are burned in either periodic or tunnel kilns at temperatures varying between 1,200 and 1,480°C (2,200 and 2,700°F). Tunnel kilns give continuous production and a uniform temperature of burning.

Fire-clay bricks are used for boiler settings, kilns, malleable-iron furnaces, incinerators, and many portions of steel and nonferrous metal furnaces. They are resistant to spalling and stand up well under many slag conditions, but are not generally suitable for use with high lime slags, fluid-coal ash slags, or under severe load conditions.

**High-alumina bricks** are manufactured from raw materials rich in alumina, such as diaspore and bauxite. They are graded into groups with 50, 60, 70, 80, and 90 percent alumina content. When well fired, these bricks contain a large amount of mullite and less of the glassy phase than is present in firebricks. Corundum is also present in many of these bricks. High-alumina bricks are generally used for unusually severe temperature or load conditions. They are employed extensively in lime kilns and rotary cement kilns, the ports and regenerators of glass tanks, and for slag resistance in some metallurgical furnaces; their price is higher than that for firebrick.

**Silica bricks** are manufactured from crushed ganister rock containing about 97 to 98 percent silica. A bond consisting of 2 percent lime is used, and the bricks are fired in periodic kilns at temperatures of 1,480 to 1,540°C (2,700 to 2,800°F) for several days until a stable volume is obtained. They are especially valuable where good strength is required at high temperatures. Recently, superduty silica bricks are finding some use in the steel industry. They have a lowered alumina content and often a lowered porosity.

Silica brick are used extensively in coke ovens, the roofs and walls of open-hearth furnaces, in the roofs and sidewalls of glass tanks, and as linings of acid electric steel furnaces. Although silica brick is readily spalled (cracked by a temperature change) below red heat, it is very stable if the temperature is kept above this range, and for this reason stands up well in regenerative furnaces. Any structure of silica brick should be heated up slowly to the working temperature; a large structure often requires 2 weeks or more to bring up.

**Magnesite bricks** are made from crushed magnesite oxide which is produced by calcining raw magnesite rock to high temperatures. A rock containing several percent of iron oxide is preferable, as this permits the rock to be fired at a lower temperature than if pure materials were used. Magnesite bricks are generally fired at a comparatively high temperature in periodic or tunnel kilns, though large tonnages of unburned bricks are now produced. The latter are made with special grain sizing and a bond such as an oxychloride. A large proportion of magnesite brick made in this country uses raw material extracted from seawater.

Magnesite bricks are basic and are used whenever it is necessary to resist high lime slags, e.g., formerly in the basic open-hearth furnace. They also find use in furnaces for the lead and copper refining industry. The highly pressed unburned bricks find extensive use as linings for cement kilns. Magnesite bricks are not so resistant to spalling as fire-clay bricks.

**Dolomite** This rock contains a mixture of  $Mg(OH)_2$  and  $Ca(OH)_2$ , is calcined, and is used in granulated form for furnace bottoms.

**Chrome bricks** are manufactured in much the same way as magnesite bricks but are made from natural chromite ore. Commercial ores always contain magnesia and alumina. Unburned hydraulically pressed chrome bricks are also made.

Chrome bricks are very resistant to all types of slag. They are used as separators between acid and basic refractories, also in soaking pits and floors of forging furnaces. The unburned hydraulically pressed bricks now find extensive use in the walls of the open-hearth furnace and are often enclosed in a metal case. Chrome bricks are used in sulfite recovery furnaces and to some extent in the refining of nonferrous metals. Basic bricks combining various proportions of magnesite and chromite are now made in large quantities and have advantages over either material alone for some purposes.

The **insulating firebrick** is a class of brick which consists of a highly porous fire clay or kaolin. They are lightweight (about one-half to one-sixth that of fireclay), low in thermal conductivity, and yet sufficiently resistant to temperature to be used successfully on the hot side of the furnace wall, thus permitting thin walls of low thermal conductivity and low heat content. The low heat content is particularly valuable in saving fuel and time on heating up, allows rapid changes in temperature to be made, and permits rapid cooling. These bricks are made in a variety of ways, such as mixing organic matter with the clay and later burning it out to form pores; or a bubble structure can be incorporated in the clay-water mixture which is later preserved in the fired brick. The insulating firebricks are classified into several groups according to the maximum use limit; the ranges are up to 872, 1,090, 1,260, 1,420, and above 1,540°C (1,600, 2,000, 2,300, 2,600, and above 2,800°F).

Insulating refractories are used mainly in the heat-treating industry for furnaces of the periodic type; the low heat content permits noteworthy fuel savings as compared with firebrick. They are also extensively in stress-relieving furnaces, chemical-process furnaces, oil stills or heaters, and in the combustion chambers of domestic-oilburner furnaces. They usually have a life equal to the heavy bricks that they replace.

They are particularly suitable for constructing experimental or laboratory furnaces because they can be cut or machined readily to any shape. However, they are not resistant to fluid slag.

There are a number of types of **special brick**, obtainable from individual manufactories. High burned kaolin refractories are particularly valuable under conditions of severe temperature and heavy load, or severe spalling conditions, as in the case of high temperature oil-fired boiler settings, or piers under enameling furnaces. Another brick for the same uses is a high-fired brick of Missouri aluminous clay.

There are a number of bricks on the market made from electrically fused materials, such as fused mullite, fused alumina, and fused zircon. These bricks, although high in cost, are particularly suitable for certain severe conditions, such as bottoms and walls of glass-melting furnaces.

Bricks of **silicon carbon**, either nitride or clay bonded, have a high thermal conductivity and find use in muffle walls and as a slag-resisting material.

Other types of refractory that find certain limited use are **forsterite** and **zirconia**. Acid-resisting bricks consisting of a dense body like stoneware are used for lining tanks and conduits in the chemical industry. Carbon blocks are used as linings for the crucibles of blast furnaces.

The **chemical composition** of some of the refractories is given in Table 6.8.13. The **physical properties** are given in Table 6.8.14. Reference should be made to ASTM Standards for details of standard tests, and to ANSI Standards for further specifications and properties.

#### Standard and Special Shapes

There are a large number of **standard refractory shapes** carried in stock by most manufacturers. Their catalogs should be consulted in selecting these shapes, but the common ones are shown in Table 6.8.15. These shapes have been standardized by the American Refractories Institute and by the Bureau of Simplification of the U.S. Department of Commerce.

**Regenerator tile** sizes  $a \times b \times c$  are:  $18 \times 6$  or  $9 \times 3$ ;  $18 \times 9$  or  $12 \times 4$ ;  $22\frac{1}{2} \times 6$  or  $9 \times 3$ ;  $22\frac{1}{2} \times 9$  or  $12 \times 4$ ;  $27 \times 9 \times 3$ ;  $27 \times 9$  or  $12 \times 4$ ;  $31\frac{1}{2} \times 12 \times 4$ ;  $36 \times 12 \times 4$ .

Table 6.8.13 Chemical Composition of Typical Refractories\*

No.	Refractory type	SiO <sub>2</sub>	Al <sub>2</sub> O <sub>3</sub>	Fe <sub>2</sub> O <sub>3</sub>	TiO <sub>2</sub>	CaO	MgO	Cr <sub>2</sub> O <sub>3</sub>	SiC	Alkalies	Resistance to:			
											Silicious steel-slag	High-lime steel-slag	Fused mill-scale	Coal-ash slag
1	Alumina (fused)	8-10	85-90	1-1.5	1.5-2.2	...	...	..	.....	0.8-1.3 <sup>‡</sup>	E	G	F	G
2	Chrome	6	23	15 <sup>†</sup>	.....	...	17	38	.....	.....	G	E	E	G
3	Chrome (unburned)	5	18	12 <sup>†</sup>	.....	...	32	30	.....	.....	G	E	E	G
4	Fireclay (high-heat duty)	50-57	36-42	1.5-2.5	1.5-2.5	...	.....	..	.....	1-3.5 <sup>‡</sup>	F	P	P	F
5	Fireclay (super-duty)	52	43	1	2	...	.....	..	.....	2 <sup>‡</sup>	F	P	F	F
6	Forsterite	34.6	0.9	7.0	.....	1.3	55.4	..	.....	.....	.....	.....	.....	.....
7	High-alumina	22-26	68-72	1-1.5	3.5	...	.....	..	.....	1-1.5 <sup>‡</sup>	G	F	F	F
8	Kaolin	52	45.4	0.6	1.7	0.1	0.2	..	.....	.....	F	P	G <sup>§</sup>	F
9	Magnesite	3	2	6	.....	3	86	..	.....	.....	P	E	E	E
10	Magnesite (unburned)	5	7.5	8.5	.....	2	64	10	.....	.....	P	E	E	E
11	Magnesite (fused)	.....	.....	.....	.....	...	.....	..	.....	.....	F	E	E	E
12	Refractory porcelain	25-70	25-60	.....	.....	...	.....	..	.....	1-5	G	F	F	F
13	Silica	96	1	1	.....	2	.....	..	.....	.....	E	P	F	P
14	Silicon carbide (clay-bonded)	7-9	2-4	0.3-1	1	...	.....	..	85-90	.....	E	G	F	E
15	Sillimanite (mulite)	35	62	0.5	1.5	...	.....	..	.....	0.5 <sup>§</sup>	G	F	F	F
16	Insulating firebrick (2,600°F)	57.7	36.8	2.4	1.5	0.6	0.5	..	.....	.....	P	P	G <sup>¶</sup>	F

E = excellent. G = good. F = fair. P = poor.

\* Many of these data have been taken from a table prepared by Trostel, *Chem. Met. Eng.*, Nov. 1938.

† As FeO.

‡ Includes lime and magnesia.

§ Excellent if left above 1200°F.

¶ Oxidizing atmosphere.



**Table 6.8.14 Physical Properties of Typical Refractories\***  
(Refractory numbers refer to Table 6.8.13)

Refractory no.	Fusion point		Pyrometric cone	Deformation under load, % at °F and lb/in <sup>2</sup>	Spalling resistance	Reheat shrinkage after 5 h, % at (°F)	Wt. of straight 9-in brick, lb
	°F						
1	3,390+		39 +	1 at 2,730 and 50	Good	+ 0.5 (2,910)	9-10.6
2	3,580 +		41 +	Shears 2,740 and 28	Poor	- 0.5 to 1.0 (3,000)	11.0
3	3,580 +		41 +	Shears 2,955 and 28	Fair	- 0.5 to 1.0 (3,000)	11.3
4	3,060-3,170		31-33	2.5-10 at 2,460 and 25	Good	± 0 to 1.5 (2,550)	7.5
5	3,170-3,200		33-34	2-4 at 2,640 and 25	Excellent	± 0 to 1.5 (2,910)	8.5
6	3,430		40	10 at 2,950	Fair	.....	9.0
7	3,290		36	1-4 at 2,640 and 25	Excellent	- 2 to 4 (2,910)	7.5
8	3,200		34	0.5 at 2,640 and 25	Excellent	- 0.7 to 1.0 (2,910)	7.7
9	3,580 +		41 +	Shears 2,765 and 28	Poor	- 1 to 2 (3,000)	10.0
10	3,580 +		41 +	Shears 2,940 and 28	Fair	- 0.5 to 1.5 (3,000)	10.7
11	3,580 +		41 +		Fair	.....	10.5
12	2,640-3,000		16-30		Good		
13	3,060-3,090		31-32	Shears 2,900 and 25	Poor†	+ 0.5 to 0.8 (2,640)	6.5
14	3,390		39	0-1 at 2,730 and 50	Excellent	+ 2‡ (2,910)	8-9.3
15	3,310-3,340		37-38	0-0.5 at 2,640 and 25	Excellent	- 0 to 0.8 (2,910)	8.5
16	2,980-3,000		29-30	0.3 at 2,200 and 10	Good	- 0.2 (2,600)	2.25

Refractory no.	Porosity	Specific heat at 60-1,200°F	Mean coefficient of thermal expansion from 60°F shrinkage point × 10 <sup>5</sup>	Mean thermal conductivity, Btu/(ft <sup>2</sup> ·h·°F·in)						
				Mean temperatures between hot and cold face, °F						
				200	400	800	1,200	1,600	2,000	2,400
1	20-26	0.20	0.43	...	20	22	24	27	30	32
2	20-26	0.20	0.56	...	8	9	10	11	12	12
3	10-12	0.21								
4	15-25	0.23	0.25-0.30	5	6	7	8	10	11	12
5	12-15	0.23	0.25-0.30	6	7	8	9	10	12	13
6	23-26	0.25								
7	28-36	0.23	0.24	6	7	8	9	10	12	13
8	18	0.22	0.23	...	...	11	12	13	13	14
9	20-26	0.27	0.56-0.83	...	40	35	30	27	26	25
10	10-12	0.26								
11	20-30	0.27	0.56-0.80							
12	.....	0.23	0.30	...	14	15	17	18	19	20
13	20-30	0.23	0.46§	...	8	10	12	13	14	15
14	13-28	0.20	0.24	...	...	100	80	65	55	50
15	20-25	0.23	0.30	...	10	11	12	13	14	15
16	75	0.22	0.25	...	1.6	2.0	2.6	3.2	3.8	

\* Many of these data have been taken from a table prepared by Trostel, *Chem. Met. Eng.*, Nov. 1938.  
 † Excellent if left above 1,200°F  
 ‡ Oxidizing atmosphere.  
 § Up to 0.56 at red heat.

The following **arch, wedge, and key bricks** have maximum dimensions,  $a \times b \times c$  of  $9 \times 4\frac{1}{2} \times 2\frac{1}{2}$  in. The minimum dimensions  $a', b', c'$ , are as noted: no. 1 arch,  $c' = 2\frac{1}{8}$ ; no. 2 arch,  $c' = 1\frac{3}{4}$ ; no. 3 arch,  $c' = 1$ ; no. 1 wedge,  $c' = 1\frac{7}{8}$ ; no. 2 wedge,  $c' = 1\frac{1}{2}$ ; no. 3 wedge,  $c' = 2$ ; no. 1 key,  $b' = 4$ ; no. 2 key,  $b' = 3\frac{1}{2}$ ; no. 3 key,  $b' = 3$ ; no. 4 key,  $b' = 2\frac{1}{4}$ ; edge skew,  $b' = 1\frac{1}{2}$ ; feather edge,  $c' = \frac{1}{8}$ ; no. 1 neck,  $a' = 3\frac{1}{2}$ ,  $c' = \frac{5}{8}$ ;

no. 2 neck,  $a' = 12\frac{1}{2}$ ;  $c' = \frac{5}{8}$ ; no. 3 neck,  $a' = 0$ ,  $c' = \frac{5}{8}$ ; end skew,  $a' = 6\frac{3}{4}$ ; side skew,  $b' = 2\frac{1}{4}$ ; jamb brick,  $9 \times 2\frac{1}{2}$ ; bung arch,  $c' = 2\frac{3}{8}$ .

**Special shapes** are more expensive than the standard refractories, and, as they are usually hand-molded, will not be so dense or uniform in structure as the regular brick. When special shapes are necessary, they should be laid out as simply as possible and the maximum size should be kept down below 30 in if possible. It is also desirable to make all special shapes with the vertical dimension as an even multiple of  $\frac{1}{2}$  in plus one joint so that they will bond in with the rest of the brickwork.

**Table 6.8.15 Shapes of Firebricks**

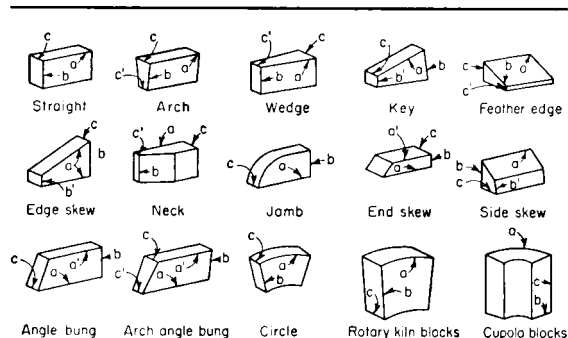

**Refractory Mortars, Coatings, Plastics, Castables, and Ramming Mixtures**

Practically all brickwork is laid up with some type of jointing material to give a more stable structure and to seal the joints. This material may be ground fire clay or a specially prepared mortar containing grog to reduce the shrinkage. The bonding mortars may be divided into three general classes. The first are **air-setting mortars** which often contain chemical or organic binder to give a strong bond when dried or fired at comparatively low temperatures. Many of the air-setting mortars should not be used at extremely high temperatures because the fluxing action of the air-setting ingredient reduces the fusion point. The second class is called **heat-setting mortar** and requires temperatures of over 1,090°C (2,000°F) to produce a good bond. These mortars vary in vitrifying point, some producing a strong bond in the lower temperature ranges.

and the others requiring very high temperatures to give good strength. The third classification comprises **special base mortars** such as silica, magnesite, silicon carbide, or chrome, which are specially blended for use with their respective bricks. The chrome-base mortar may be satisfactorily used with fire-clay bricks in many cases.

The refractory bonding mortars should preferably be selected on the advice of the manufacturer of the refractory to obtain good service, although there are a considerable number of independent manufacturers of mortars who supply an excellent product. From 1,330 to 1,778 N (300 to 400 lb) of dry mortar per 1,000 bricks is required for thin joints, which are desirable in most furnace construction. For thicker trowel joints, up to 2,220 N (500 lb) per 1,000 bricks is required. In the case of chrome base mortars, 2,660 N (600 lb) per 1,000 bricks should be allowed, and for magnesite cement 3,550 N (800 lb) per 1,000 bricks.

The working properties of the bonding mortar are important. Mortars for insulating refractories should be carefully selected, as many of the commercial products do not retain water sufficiently long to enable a good joint to be made. There are special mortars for this purpose which are entirely satisfactory.

**Coatings** are used to protect the hot surface of the refractories, especially when they are exposed to dust-laden gases or slags. These coatings usually consist of ground grog and fireclay of a somewhat coarser texture than the mortar. There are also chrome-base coatings which are quite resistant to slags, and in a few cases natural clays containing silica and feldspar are satisfactory.

The coatings can be applied to the surface of the brickwork with a brush in thin layers about  $\frac{1}{16}$  in thick, or they may be sprayed on with a cement gun, the latter method generally giving the best results. Some types of coating can be put on in much thicker layers, but care should be taken to assure that the coating selected will fit the particular brick used; otherwise it is apt to peel off in service. The coating seals the pores and openings in the brickwork and presents a more continuous and impervious service to the action of the furnace gases and slag. It is not a cure-all for refractory troubles.

**Plastics and ramming mixtures** are generally a mixture of fire clay and coarse grog of somewhat the same composition as the original fire-clay brick. They are used in repairing furnace walls which have been damaged by spalling or slag erosion, and also for making complete furnace walls in certain installations such as small boiler furnaces. They are also used to form special or irregular shapes, in temporary wooden forms, in the actual furnace construction.

Some of the plastics and ramming mixtures contain silicate of soda and are air-setting, so that a strong structure is produced as soon as the material is dry. Others have as a base chrome ore or silicon carbide, which make a mixture having a high thermal conductivity and a good resistance to slag erosion. These mixtures are often used in the water walls of large boiler furnaces; they are rammed around the tubes and held in place by small studs welded to the tube walls. The chrome plastic has been used with good success for heating-furnace floors and subhearths of open-hearth furnaces.

**Castable mixes** are a refractory concrete usually containing high-alumina cement to give the setting properties. These find considerable use in forming intricate furnace parts in wooden molds; large structures have been satisfactorily cast by this method. This type of mixture is much used for baffles in boilers where it can be cast in place around the tubes. Lightweight castables with good insulating properties are used to line furnace doors.

### Furnace Walls

The modern tendency in furnace construction is to make a comparatively thin wall, anchored and supported at frequent intervals by castings or heat-resisting alloys which, in turn, are held by a structural framework and does not rest on the base. The wall may be made of heavy refractories backed up with insulating material, or of insulating refractory. Table 6.8.16 gives heat losses and heat contents of a number of wall combinations and may enable designers to pick out a wall section to suit their purpose. Solid walls built with standard 9-in brick are made up in various ways, but the hot face has usually four header courses and one stretcher course alternating.

Many modern furnaces are constructed with air-cooled walls, with refractory blocks held in place against a casing by alloy steel holders. Sectional walls made up with steel panels having lightweight insulating refractories attached to the inner surface are also used and are especially valuable for use in the upper parts of large boiler furnaces, oil stills, and similar types of construction. The sections can be made up at the plant and shipped as a unit. They have the advantage of low cost because of the light ironwork required to support them.

Many failures in furnace construction result from improper expansion joints. **Expansion joints** should usually be installed at least every 10 ft, although in some low-temperature structures the spacing may be greater. For high-temperature construction, the expansion joint allowance per foot in inches should be as follows: fire clay,  $\frac{1}{16}$  to  $\frac{3}{32}$ ; high alumina,  $\frac{3}{32}$  to  $\frac{1}{8}$ ; silica,  $\frac{1}{8}$  to  $\frac{3}{16}$ ; magnesite,  $\frac{1}{4}$ ; chrome,  $\frac{3}{32}$ ; forsterite,  $\frac{1}{4}$ . Corrugated cardboard is often used in the joints.

The **roof** of the furnace is usually either a sprung arch or a suspended arch. A **sprung arch** is generally made of standard shapes using an inside radius equal to the total span. In most cases, it is necessary to build a form on which the arch is sprung.

In the case of arches with a considerable rise, it has been found that an inverted catenary shape is better than a circular shape for stability, and it is possible to run the sidewalls of the furnace right down to the floor in one continuous arch with almost complete elimination of the ironwork. The catenary can be readily laid out by hanging a flexible chain from two points of a vertical wall.

The **suspended arch** is used when it is desirable to have a flat roof (curved suspended arches are also made); it presents certain advantages in construction and repair but is more difficult to insulate than the sprung arch. Special suspended arch shapes are commercially available. The insulating refractory is suited to this type of construction because the steel supports are light and the heat loss is low.

### Selection of Refractories

The selection of the most suitable refractory for a given purpose demands experience in furnace construction. A brick that costs twice as much as another brand and gives twice the life is preferable since the total cost includes the laying cost. Furthermore, a brick that gives longer service reduces the shutdown period of the furnace. Where slag or abrasion is severe, brick with a dense structure is desirable. If spalling conditions are important, a brick with a more flexible structure is better, although there are cases where a very dense structure gives better spalling resistance than a more open one.

High-lime slag can be taken care of with magnesite, chrome, or high-alumina brick, but if severe temperature fluctuations are encountered also, no brick will give long life. For coal-ash slag, dense fire-clay bricks give fairly good service if the temperature is not high. At the higher temperatures, a chrome-plastic or silicon carbide refractory often proves successful. When the conditions are unusually severe, air- or water-cooled walls must be resorted to; the water-cooled stud-tube wall has been very successful in boiler furnaces.

With a general freedom from slag, it is often most economical to use an insulating refractory. Although this brick may cost more per unit, it allows thinner walls, so that the total construction cost may be no greater than the regular brick. The substitution of insulating refractory for heavy brick in periodic furnaces has sometimes halved the fuel consumption.

The stability of a refractory installation depends largely on the brick-laying. The total cost, in addition to the bricks, of laying brick varies with the type of construction, locality, and refractory.

### Recent Developments in Refractories

**Pure-oxide refractories** have been developed to permit fabrication of parts such as tubes, crucibles, and special shapes. Alumina ( $\text{Al}_2\text{O}_3$ ) is the most readily formed into nonporous pieces and, up to its softening point of 2,040°C (3,690°F), is most useful. Mullite ( $2\text{SiO}_2 \cdot 3\text{Al}_2\text{O}_3$ ), softening at 1,820°C (3,290°F), is used for thermocouple protection tubes, crucibles, and other small pieces. Magnesium oxide ( $\text{MgO}$ ), fusing at 2,800°C (5,070°F), is resistant to metals and slags. Zirconia ( $\text{ZrO}_2$ ), softening at 4,600°F, is very sensitive to temperature changes

**Table 6.8.16 Transmitted Heat Losses and Heat-Storage Capacities of Wall Structures under Equilibrium Conditions**

(Based on still air at 80°F)

Wall	Thickness, in Of insulating refractory and firebrick	Hot face temperature, °F									
		1,200		1,600		2,000		2,400		2,800	
		HL	HS	HL	HS	HL	HS	HL	HS	HL	HS
4½	4½ 20	355	1,600	537	2,300	755	2,900				
	4½ 28	441	2,200	658	3,100	932	4,000	1,241	4,900	1,589	5,900
	4½ FB	1,180	8,400	1,870	11,700	2,660	14,800	3,600	18,100	4,640	21,600
7	4½ 28 + 2½ 20	265	3,500	408	4,900	567	6,500	751	8,100	970	9,800
	4½ FB	423	12,500	660	17,700	917	23,000	1,248	28,200		
9	4½ 28 + 4½ 20	203	4,100	311	5,900	432	7,900	573	9,900	738	12,200
	4½ FB + 4½ 20	285	13,700	437	19,200	615	24,800				
	9 20	181	3,100	280	4,300	395	5,500				
	9 28	233	4,100	349	5,800	480	7,500	642	9,300	818	11,100
	9 FB	658	15,800	1,015	21,600	1,430	27,600	1,900	34,000	2,480	40,300
11½	9 28 + 2½ 20	169	5,700	260	8,000	364	10,500	484	13,100	623	15,800
	9 FB + 2½ 20	335	22,300	514	31,400	718	40,600	962	50,400	1,233	60,300
	9 28 + 4½ 20	143	6,500	217	9,300	305	12,300	404	15,300	514	18,700
	9 FB + 4½ 20	241	24,100	367	34,500	516	44,800	690	55,100		
13½	9 20 + 4½ FB	165	5,300	255	7,300	348	9,900				
	9 28 + 4½ FB	200	6,900	302	9,700	415	12,600	556	15,700	710	19,100
	13½ FB	452	22,300	700	31,000	980	39,900	1,310	49,100	1,683	58,300
16	13½ FB + 2½ 20	275	31,200	423	43,300	588	56,300	780	70,000	994	84,200
18	9 20 + 9 FB	147	8,500	225	11,900	319	15,700				
	9 28 + 9 FB	175	10,700	266	15,100	375	19,700	493	24,600	635	29,800
	13½ FB + 4½ 20	210	34,100	318	48,400	440	62,600	587	77,500	753	92,600
	18 FB	355	28,800	532	40,300	745	52,200	1,000	64,200	1,283	76,500
20½	18 FB + 2½ 20	234	39,000	356	55,400	500	72,000	665	89,200	847	107,000
22½	18 FB + 4½ 20	182	43,200	281	61,000	392	79,200	519	97,700	667	117,600
	22½ FB	287	36,000	435	49,500	612	64,100	814	78,800	1,040	93,400

Conversion factors:  $t_c = \frac{5}{9}(t_F - 32)$ ; 1 in = 0.0254 m.HL = heat loss in Btu/(ft<sup>2</sup>)(h). HS = heat storage capacity in Btu/ft<sup>2</sup>. 20 = 2,000°F insulating refractory. 28 = 2,800°F insulating refractory. FB = fireclay brick.

SOURCE: Condensed from "B &amp; W Insulating Firebrick" Bulletin of The Babcock &amp; Wilcox Co.

but can be stabilized with a few percent of lime. Beryllium oxide (BeO), softening at 2,570°C (4,660°F), has a very high thermal conductivity but must be fabricated with great care because of health hazards. Thoria (ThO<sub>2</sub>) softens at 3,040°C (5,520°F) and has been used in crucibles for melting active metals and as a potential nuclear fuel.

**Refractory carbides, sulfides, borides, silicides, and nitrides** have been developed for special uses. Many have high softening points, but all have limited stability in an oxidizing atmosphere. Silicon carbide (SiC) is the most used because of its high thermal and electrical conductivity, its resistance against certain slags, and its relatively good stability in air. Molybdenum silicide (MoSi<sub>2</sub>) also has considerable resistance to oxidation and, like SiC, can be used for metal-melting crucibles. Cerium sulfide (CeS<sub>2</sub>) is a metallic-appearing material of high softening point but no resistance to oxidation. Zirconium nitride (ZrN) and titanium nitride (TiN) are also metalliclike but are not stable when heated in air. Graphite has valuable and well-known refractory properties but is not resistant to oxidation.

**Refractory fibers** are coming into use quite extensively. Fibers of silica-alumina glass have a use limit of about 1,090°C (2,000°F). They are used for insulating blankets, expansion joints, and other high temperature insulation. Development of higher-temperature fibers is being carried out on a small scale for use as high temperature insulation or mechanical reinforcement.

**Nuclear fuels** of uranium, thorium, and plutonium oxides or carbides are now extensively used in high temperature reactors.

**Space vehicles** are using nozzles of refractories of various kinds to withstand the high temperatures and erosion. Nose cones of sintered alumina are now used extensively because of their excellent refractory and electrical properties. Heat shields to protect space vehicles upon reentry are an important use of special refractories.

### Physical Properties of High-Purity Refractories

In Table 6.8.17 are shown the properties of some of the more important pure refractory materials. It should be realized that, as purer materials become available and testing methods become more refined, some of these values will be changed.

### SEALANTS

REFERENCES: Damusis (ed.), "Sealants," Reinhold, Flick, "Adhesives and Sealant Compound Formulations," 2d ed., Noyes Publ. *Mech. Eng.*, April 1991. *Engr. News Record*, Nov. 12, 1987; 1972-1993 "Annual Book of ASTM Standards." Baldwin, Selecting High Performance Building Sealants, *Plant Eng.*, Jan. 1976, pp. 58-62. Panek and Cook, "Construction Sealants and Adhesives," 2d ed, Wiley-Interscience. Panek (ed.), Building Seals and Sealants, *ASTM Spec. Tech. Publ.* 606, American Society for Testing Materials, Philadelphia. Klosowski, "Sealants in Construction," Marcel Dekker.

Klosowski's book is an excellent source of information on sealants and serves as an excellent reference. The reader should treat the following material as a guide and should consult the references and manufacturers' catalogs for expanded coverage.

Classifying sealants is somewhat arbitrary, depending as such on a multitude of properties. One of these properties tends to be more important than the rest, and that is *the ability to take cyclic movement*. Low movement ability together with short useful lifetimes tends to be found for the lower-cost sealants, and ability to take cyclic movement along with long useful lifetimes is found for the higher-cost sealants. The remaining key properties are adhesion/cohesion, hardness, modulus, stress relaxation, compression set, and weather resistance. Table 6.8.18 provides a rough comparison of sealant classes.

Table 6.8.17 Physical Properties of Some Dense,\* Pure Refractories

Material	Modulus of rupture, 10 <sup>3</sup> lb/in <sup>2</sup> at 70°F	Modulus of rupture, 10 <sup>3</sup> lb/in <sup>2</sup> at 1,800°F	Modulus of elasticity, 10 <sup>6</sup> lb/in <sup>2</sup> at 70°F	Fusion point, °F	Linear coef of expansion, 10 <sup>-6</sup> in/(in·°F) between 65 and 1,800°F	Thermal conductivity, Btu/(ft <sup>2</sup> ·h·°F·in), at 212°F	Thermal conductivity, Btu/(ft <sup>2</sup> ·h·°F·in), at 1,800°F	Thermal stress resistance
Al <sub>2</sub> O <sub>3</sub>	100	60	53	3,690	5.0	210	55	Good
BeO	20	10	45	4,660	4.9	1,450	130	Very good
MgO	14	12	31	5,070	7.5	240	47	Poor
ThO <sub>2</sub>	12	7	21	5,520	5.0	62	20	Fair
ZrO <sub>2</sub>	20	15	22	4,600	5.5	15	15	Fair
UO <sub>2</sub>	12		25	5,070	5.6	58	20	Fair
SiC	24	24	68	5,000†	2.2	390	145	Excel.
BC	50	40	42	4,440	2.5	200	145	Good
BN	7	1	12	5,000	2.6	150	130	Good
MoSi <sub>2</sub>	100	40	50	3,890	5.1	220	100	Good
C	3	4	2	7,000	2.2	870	290	Good

Conversion factors: 1 lb/in<sup>2</sup> = 6,894.8 N/m<sup>2</sup>;  $t_c = \%(t_F - 32)$ ; 1 Btu/(ft<sup>2</sup>·h·°F·in) = 225 W/(m<sup>2</sup>·°C·m); 1 Btu/(lbm·°F) = 4,190 kg·°C.

\* Porosity, 0 to 5 percent.

† Stabilized.

SOURCES: Norton, "Refractories," 3d ed.; Green and Stewart, "Ceramics: A Symposium"; Ryschkeiwisch, "Oxydekeramik, der Finstoffsysteme," Springer; Campbell, "High Temperature Technology"; Kingery, "Property Measurements at High Temperatures," Wiley.

## Key Properties

**Adhesion/Cohesion** A sealant must stick or adhere to the joint materials to prevent fluid penetration. The sealant must also stick or cohere to itself internally so that it does not split apart and thus allow leakage to occur. The ASTM C-719 test method is recommended for crucial designs and applications.

**Hardness** The resistance of a sealant to a blunt probe penetration on a durometer is a measure of its hardness. Any change in this hardness over time will alert the user to check the sealant's useful performance span.

**Modulus** The springiness or elastic quality of a sealant is defined by the ratio of force (stress) needed to unit elongation (strain). A high-modulus sealant can exert a rather high force on a joint, so that for weak or

marginal substrates it becomes a decided disadvantage. For instance, concrete joints, having rather low tensile strength, will perform poorly with high-modulus sealants.

**Stress-Relaxation** Under stress some sealants relax internally over time and stretch; an extreme example is bubble gum. Certain sealants have internal polymer chains that exhibit stress relaxation over time; mastics behave likewise, and low modulus sealants are more likely to do so than are high-modulus sealants.

A small amount of relaxation is useful in continuously tensed joints since it lowers the bond line force. In moving joints, however, a high degree of stress relaxation is problematic because the sealant tends to recover its original shape slowly and incompletely. Such joints tend to pump out their sealants.

Table 6.8.18 Sealant Classes by Movement Capabilities\*

Range or movement capability	Sealant types	Comments
Low—near or at 0% of joint movement	<ol style="list-style-type: none"> <li>Oil-based</li> <li>Resin-based</li> <li>Resinous caulks</li> <li>Bituminous-based mastics</li> <li>Polybutene-based</li> <li>PVA (vinyl) latex</li> </ol>	<p>Short service life</p> <p>Low cost</p> <p>Major component usually low-cost mineral fillers.</p> <p>For example, putty is mostly finely ground chalk mixed with oil to form a doughlike entity.</p> <p>Some recent ones may contain about 0.2–2% silicone</p>
Medium—0–12½% of joint width	<ol style="list-style-type: none"> <li>Butyls</li> <li>Latex acrylics</li> <li>Neoprenes</li> <li>Solvent-release acrylics</li> </ol>	<p>Longer service life</p> <p>Medium cost</p> <p>For protected environments and low movement, service life is perhaps 10–15 years. Typical is 3–10 years</p> <p>Common disadvantage is shrinkage, which may be near 30% in some products. Plasticized types tend to discolor walls</p>
High—greater than 12½% of joint width	<ol style="list-style-type: none"> <li>Polysulfides</li> <li>Urethanes</li> <li>Silicones</li> <li>Proprietary modifications of above</li> </ol>	<p>Long service life</p> <p>Higher cost</p> <p>Some advertised as allowing movements of ± 25 to ± 50%, or + 100 to – 50%</p> <p>Generally used in commercial jobs</p> <p>Expanding market into do-it-yourself and over-the-counter trade</p>

SOURCE: Adapted from Klosowski, "Sealants in Construction," Dekker.

**Compression Set** If a sealant is unable to reexpand to its original shape after it is compressed, it has experienced **compression set**; i.e., the compressed shape becomes permanent. When the joint reopens, the sealant must sustain high internal and bonding stresses which can cause the sealant to tear off the joint and/or cause internal tearing in the sealant itself as well as possible surface failure of the joint substrate. Polysulfide sealants are prone to such failure. Urethane sealants under combined conditions of joint movement and weathering will exhibit such failure.

**Resistance to Weathering** Construction sealants are designed to resist weathering. The nature of the polymer system in silicones provides that resistance, while urethane and polysulfides achieve equivalent resistance only by the use of heavy filler loads. Screening from the sun is important. Heavy filler loads or chemical sunscreens help stop radiation penetration to the internal polymer. Deep joints and opaque joint materials help sealants weather successfully.

### Sealant Types

**Oil-Based Caulks** Combining a drying oil (such as linseed) with mineral fillers will result in a doughlike material (putty) that can be tooled into a joint. The oils dry and/or oxidize and in about 24 h develop sufficient skin to receive paint. Movement ability is about  $\pm 2\frac{1}{2}$  percent of the joint. To prevent porous substrates from wicking in the caulk's oil, a primer should be applied.

**Butyl Sealants (Almost Totally Cured Systems Dispersed in a Solvent)** Chemically combining isobutylene and isoprene results in a butyl rubber. End-product variations are gotten by varying both the proportion of starting ingredients and the polymer chain length. Carbon black serves as a reinforcer and stabilizer in the final product. Chlorbutyl rubber is a similar sealant.

Butyl sealants are available as solvent-release caulks, soft deformable types, more rigid gaskets, and hot melts. The better butyls have movement capabilities of  $\pm 12\frac{1}{2}$  percent. For applications needing 20 to 30 percent compression, butyl tapes serve well and are used extensively in glazing applications.

Advantages of butyl sealants include moderate cost, good water resistance (not for immersion), and good adhesion without primers.

Disadvantages include poor extension recovery, limited joint movement capability, and odor plus stickiness during application. They also pick up dirt and cause staining. They tend to soften under hot sun conditions such as found in cars with closed windows.

**Acrylic Latex (Almost Fully Reacted in a Cartridge)** Acrylic polymers are made by using a surfactant, water, and a catalyst plus appropriate monomers, which results in a high molecular weight polymer, coated with surfactant and dispersed in water. The addition of fillers, plasticizers, and other additives such as silanes for adhesion and ethyl glycol for freeze/thaw stability completes the product. Once extruded, it dries rapidly and can be painted in 30 to 50 min. Movement capability lies between  $\pm 7\frac{1}{2}$  and  $\pm 12\frac{1}{2}$  percent of joint width.

Advantages include excellent weathering, ease of application, ease of cleanup, low odor, low toxicity, no flammability during cure, and ability to be applied to damp substrates.

Disadvantages include the need for a primer for concrete, most wood, and plastics where joints will move and cause sealant stress. Since they harden when cold and soften when hot, they are not recommended for extremes of temperature cycling. They are not recommended for below-grade, underwater, or chronically damp applications.

**Solvent Acrylic Sealants (Solvent Release Sealants) (Almost Totally Cured Systems Dispersed in a Solvent)** This sealant is an acrylic polymer of short chain length, and it is based on an alkyl ester of acrylic and methacrylic acids with various modifications. The system does not quite cure to be a true elastomer, winding up somewhat more like a dry-feeling mastic, and so it exhibits stress relaxation. The best can tolerate  $\pm 12\frac{1}{2}$  percent of joint movement, with the more typical between  $\pm 8$  percent and  $\pm 10$  percent.

Advantages include excellent adhesion without priming to most substrates (and, by some claims, through dirt and light oils and perhaps even damp surfaces), good weathering, and moderate cost.

Disadvantages include the need to heat the cartridge or dispensing container for easy application in cool weather, offensive odor during cure (thus requiring ventilation in restricted quarters), and slow recovery from either extension or contraction. The cured seal gets very hard in cold weather and loses flexibility, thus compromising movement capability.

**Two-Part Polysulfide Sealants** These sealants are the pioneers of high-range products with life expectancies (in certain environments) of up to 20 years and movement capability of up to  $\pm 25$  percent of joint width. It is widely used in curtain wall construction and in concrete/masonry applications. In glazing applications shielded from direct sunlight, polysulfide sealant is suitable. Since polysulfides also can be produced with excellent solvent resistance, they are used as fuel tank sealants and in other fuel contact applications. Fillers are generally carbon blacks, clays, and mineral materials. Curing agents may be lead peroxide, cyclic amides, diisocyanates, etc. Silanes act as adhesion promoters and stabilizers. Most polysulfides are mixed and dispensed on the job at the time of use.

Advantages include good extensibility, recovery, cure with two-package systems (tack-free in about 36 to 48 h and about 1 week for full cure), adhesion, and resistance to weathering and aging.

Disadvantages include the need for site mixing, requirements for primers on porous surfaces, sun exposure cracking, and compression set effects which emerge in about 5 to 10 years.

**One-Part Polysulfide Sealants** These sealants are almost on a par in cured performance to two-part polysulfide sealants. They need no mixing at the time of use and are thus ready to apply. Curing depends upon moisture or oxygen from the air and is relatively slow, requiring days, weeks, or more, after which they become tack-free. Dry and cold weather can lengthen the curing process.

**Two-Part Polyurethane Sealants** These sealants are second-generation premium products, and they outperform the polysulfides. They weather well, perform well in expansion joints by tolerating large movement ( $\pm 25$  percent of joint movement), and are tough and resilient. The top of the product line can achieve 85 to 90 percent recovery from compression set. Adhesion is very good. They stay clean for almost the life of the sealant, or about 10 to 20 years. Urethanes tend to be water-sensitive and to bubble if they contact water at the curing surface, and they tend to stiffen with age. Urethane sealants are widely used in construction and for nonglazing joints in walkways and pedestrian traffic areas.

**One-Part Urethane Sealants** These sealants are comparable to two-part urethanes, but come in a single package ready to use. Package stability is problematical because of moisture sensitivity. One-part systems take a long time to cure, especially at low temperatures and low humidities.

**Silicone Sealants** In some aspects of performance, these sealants represent third-generation products, and others are at least second-generation in quality. Only silicone polymers comprise a true silicone sealant. They generally contain mineral or other inorganic fillers along with functional silane or siloxane cross-crosslinker, with special additives included for specific purposes.

In terms of temperature exposure, silicone polymers are about one-tenth as sensitive as typical hydrocarbons or polyether chains. Thus they extrude easily at both low and high temperatures. Temperature stability ranges from about  $-40$  to  $250^{\circ}\text{F}$  and for some to more than  $400^{\circ}\text{F}$ . Once cured, they maintain elasticity very well at both temperature extremes and weather quite well (lasting 12 to 20 times longer than typical organic sealants, as indicated by weatherometer tests). Warranties often extend from 20 to 50 years. Joint movement performance embraces a wide range from  $\pm 12$  to  $+100/-50$  percent of joint width. Adhesion qualities are excellent, allowing some common silicones unprimed application to most substrates (including concrete), and some are applicable for service under conditions of total submersion in water.

These performance levels have made silicone sealants the industry standard to which others are compared. Competitive products marketed using terms such as *siliconized*, *siliconelike*, *modified with silicone*, *modified silicone*, and so forth contain a minimal amount of true sili-

**Table 6.8.19 Summary of Sealant Properties\***

Type of sealant	Medium performance		Acrylic Solvent- release	Polysulfide		Urethane		Silicone		
	Low performance	Latex (acrylic), one-part		Butyl skinning, one-part	One-part	Two-part	One-part	Two-part	One-part	Two-part
	Oil-based, one-part									
Movement ability in percent of joint width (recommended maximum joint movement)	± 3	± 5, ± 12½	± 7.5	± 10–12½	± 25	± 25	± 25	± 25	± 25 – + 100/ – 50	± 12½ – ± 50
Life expectancy, years†	2–10	2–10	5–15	5–20	10–20	10–20	10–20	10–20	10–50	10–50
Service temperature range, °F (°C)	– 20 to + 150 (– 29 to + 66)	– 20 to + 180 (– 20 to + 82)	– 40 to + 80 (– 40 to + 82)	– 20 to + 180 (– 29 to + 82)	– 40 to + 180 (– 40 to + 82)	– 60 to + 180 (– 51 to + 82)	– 40 to + 180 (– 40 to + 82)	– 25 to + 180 (– 32 to + 82)	– 65 to + 400 (– 54 to + 200)	– 65 to + 400¶ (– 54 to + 200)
Recommended application temperature range, °F‡	40–120	40–120	40–120	40–180	40–120	40–120	40–120	40–180	– 20 to + 160	– 20 to + 160
Cure time§ to a tack-free condition, h	6	½–1	24	36	24§	36–48§	12–36	24	1–3	½–2
Cure time§ to specified performance, days	Continues	5	Continues	14	30–45	7	8–21	3–5	5–14	¼–3
Shrinkage, %	5	20	20	10–15	8–12	0–10	0–5	0–5	0–5	0–5
Hardness, new (1–6 mo), A scale at 75°F		15–40	10–30	10–25	20–40	20–45	20–45	10–45	15–40	15–40
Hardness, old (5 yr), A scale at 75°F		30–45	30–50	30–55	30–55	20–55	30–55	20–60	15–40	15–50
Resistance to extension at low temperature	Low to moderate	Moderate to high	Moderate to high	High	Low to high	Low to moderate	Low to high	Low to high	Low	Low
Primer required for sealant bond to:										
Masonry	No	Yes	No	No	Yes	Yes	Yes	Yes	No	No
Metal	No	Sometimes	No	No	Yes	Yes	No	No	?	?
Glass	No	No	No	No	No	No	No	No	No	No
Applicable specifications:										
United States	TT-C-00593b	ASTM TTS-00230	ASTM TT-S-001657	ASTM C-920 ITS-00230	ASTM C-920 TT-C-00230C	ASTM C-920 TTS-00227E	ASTM C-920 TTS-00230C	ASTM C-920 TTS-00227C	ASTM C-920 TTS-00230C	ASTM C-920 TTS-001543A TTS-00230C
Canada	CAN 2-19.2M		CGSB 19-GP-14M	CGSB 19-GP-SM	CAN 2-19.13M		CAN 2-19.13M		CAN 2-19.18M	

\* Data from manufacturer's data sheets; U.S.-made sealants are generally considered.

† Affected by conditions of exposure.

‡ Some sealants may require heating in low temperatures.

§ Affected by temperature and humidity.

¶ The wide range in performance of the various types of silicone sealants is discussed briefly in the text preceding this table.

SOURCE: Adapted from J. M. Klosowski, "Sealants in Construction," Marcel Dekker, 1989. By permission.

cone, usually from 0.1 to 10 percent. Most silicones are fully elastic and exhibit the smallest compression or tension set, ranging from 85 to 99 percent recovery.

Some silicones pick up dirt to varying degrees, but owing to their relatively fast curing times (tack-free in 15 min to 3 h), they are less prone to do so when compared with polyurethane and polysulfides, which have longer cure times. After curing, however, because of their relatively soft surface, silicones tend to accumulate dirt faster. Unfortunately, the dirt cannot be completely washed off. To obtain the advantage of silicone's durability and to avoid dirt pickup, one resorts to overcoating the silicone sealant with a hard silicone resin. Alternately, one can dust the surface of the uncured, tacky silicone with powdered chalk or some similar material; this can be used as a base upon which to apply paint. Some silicone sealants are formulated to be paintable, but, in general, silicones simply will not accept paint. Silicones abrade easily and are not used in heavily trafficked areas. Silicones which release acetic acid should not be used on marble, galvanized metal, copper, cementaceous substances, or other corrodable materials. Silicones which release amines and the like must not be used on copper and for electrical applications. Neutral-cure systems are available which can be safely used on almost all substrates. The reader is directed to consult the supplier when in doubt about compatibility.

**Water-Based Silicones** Water-based silicones combine the durability and longevity of silicones with ease of cleanup, ease of application, and paintability. They are true silicone systems, being dispersions of polymers, crosslinkers, and catalysts in water.

Table 6.8.19 gives a summary of sealant properties.

#### Miscellaneous

**Hot Pours** Several categories of materials are softened by heating and so can be injected or poured into joints (almost exclusively horizontal). The majority of these materials are filled out with bituminous substances such as asphalt tars, coal tars, etc. Such bituminous bases can be blended with urethanes, polysulfides, polyvinyl chlorides, etc. High-way joint sealing constitutes the largest use of hot-pour sealants. They

are inexpensive and easy to use, but deteriorate rapidly in typical U.S. climate and suffer surface crazing and lose elasticity (stiffen) in cold weather.

**Forever Tacky** Nonhardening sealants, such as Hylomar, remain tacky for years and retain their original sealing qualities very well. They were originally developed for jet-engine joints in the 1950s, but have been applied to resist extreme vibrations and to make emergency repairs. Continued improvements in this product are directed toward broadening its compatibility with a wider range of chemicals and oils. Its stable, tacky condition for long periods enables easy disassembly of parts it has bonded.

**Formed-in-Place Gasket** Replacing die-cut gaskets can reduce costs, and for this reason, formed-in-place gaskets have been developed. One such product, Dynafoam, a curable thermoplastic elastomer, forms in-place gaskets by pouring the sealant into the desired shape. Automotive applications include taillight assemblies and sunroof gaskets to seal out moisture, wind, and dust. This type of sealant is designed to fill the niche between traditional hot-melt adhesives and gaskets, such as butyl rubbers or ethyl vinyl acetates, and curable silicone and urethane sealants. Curing time is within a few minutes, and they resist softening up to about 280°F (continuous exposure) and up to 400°F (for periods of 1 h or less).

**Foamed-in-Place Sealants** In commercial operations, a sealant such as Dynafoam is heated to 180°F, pumped through a heated hose into a pressurized, dry gas chamber (usually nitrogen), and pumped further through a heated hose and dispensing nozzle. Upon exiting the nozzle, the sealant expands to bead size as the entrained nitrogen expands. The wormlike bead is then applied directly to a part and forms a gasket. The sealant begins curing upon contact with air.

Similar materials in small pressurized canisters contain a room-temperature curing sealant. Upon release, the sealant expands into a foam, fills the joint, and cures in place. It is applied easily to provide local insulation, to fill crevices (e.g., to block wind), and so forth. For extensive operations of this kind, this material is supplied in much larger, yet portable, containers.

## 6.9 CEMENT, MORTAR, AND CONCRETE

by William L. Gamble

REFERENCES: Neville, "Properties of Concrete," Wiley. Sahlin, "Structural Masonry," Prentice-Hall. Mindess and Young, "Concrete," Prentice-Hall. "BOCA Basic Building Code," Building Officials and Code Administrators International. "Concrete Manual," U.S. Bureau of Reclamation. ACI 318, "Building Code Requirements for Reinforced Concrete"; ACI 211.1, "Standard Practice for Selecting Proportions for Normal, Heavyweight, and Mass Concrete"; ACI 304, "Recommended Practice for Measuring, Mixing, Transporting, and Placing Concrete"; American Concrete Institute, Detroit. "Building Code Requirements for Masonry Structures (ACI 530/TMS 402/ASCE 5)," American Concrete Institute, The Masonry Society, and American Society of Civil Engineers.

### CEMENT

**Normal portland cement** is used for concrete, for reinforced concrete, and either with or without lime, for mortar and stucco. It is made from a mixture of about 80 percent carbonate of lime (limestone, chalk, or marl) and about 20 percent clay (in the form of clay, shale, or slag). After being intimately mixed, the materials are finely ground by a wet or dry process and then calcined in kilns to a clinker. When cool, this clinker is ground to a fine powder. During the grinding, a small amount of gypsum is usually added to regulate the setting of the cement. The chemical analysis of 32 American type I cements gives the following average percentage composition: silica ( $\text{SiO}_2$ ), 21.92; alumina ( $\text{Al}_2\text{O}_3$ ),

6.91; iron oxide ( $\text{Fe}_2\text{O}_3$ ), 2.91; calcium oxide (CaO), 62.92; magnesium oxide ( $\text{MgO}$ ), 2.54; sulfuric oxide ( $\text{SO}_3$ ), 1.72; alkalis ( $\text{R}_2\text{O}_3$ ), 0.82; loss on ignition, 1.50, insoluble residue 0.20.

**Types and Kinds of Cements** Five types of portland cements are covered by ASTM specification C150.

**Normal portland cement**, type I, is used for purposes for which another type having special properties is not required. Most structures, pavements, and reservoirs are built with type I cement.

**Modified portland cement**, type II, generates less heat from its hydration and is more resistant to sulfate attacks than type I. This cement is used in structures having large cross sections, such as large abutments and heavy retaining walls. It may also be used in drainage where a moderate sulfate concentration exists.

**High-early-strength portland cement**, type III, is used when high strengths are required in a few days. Use of high-early-strengths will allow earlier removal of forms and shorter periods of curing.

**Low-heat portland cement**, type IV, generates less heat during hydration than type II and is used for mass concrete construction such as large dams where large temperature increases would create special problems. Type IV cement gains strength more slowly than type I. The tricalcium aluminate content is limited to 7 percent.

**Sulfate-resisting portland cement**, type V, is a special cement, not read-

ily available, to be used when concrete is exposed to severe sulfate attack. Type V cements gain strength more slowly than type I cement. The tricalcium aluminate content is limited to a maximum of 5 percent.

**Air-entraining portland cements** purposely cause air, in minute, closely spaced bubbles, to occur in concrete. Entrained air makes the concrete more resistant to the effects of repeated freezing and thawing and of the deicing agents used on pavements. To obtain such cements, air-entraining agents are interground with the cement clinker during manufacture. Types I to III can be obtained as air-entraining cements and are then designated as types IA, IIA, and IIIA, under ASTM C150.

**Portland blast-furnace slag cements** are made by grinding granulated high-quality slag with portland-cement clinker. Portland blast-furnace slag cement type IS and air-entraining portland blast-furnace slag cement type IS-A are covered by ASTM specification C595. Provisions are also made for moderate-heat-of-hydration cements (MH) and moderate-sulfate-resistance cements (MS), or both (MH-MS). Type IS cements initially gain strength more slowly but have about the same 28-day strength as type I cements.

**White portland cement** is used for architectural and ornamental work because of its white color. It is high in alumina and contains less than 0.5 percent iron. The best brands are true portlands in composition.

**Portland-pozzolan cement** is a blended cement made by intergrinding portland cement and pozzolanic materials. Two types, type IP (portland-pozzolan cement) and type IP-A (air-entraining portland-pozzolan cement), are covered in ASTM specification C595.

**Masonry cement**, ASTM specification C91, is a blended cement used in place of job cement-lime mixtures to reduce the number of materials handled and to improve the uniformity of the mortar. These cements are made by combining either natural or portland cements with fattening materials such as hydrated lime and, sometimes, with air-entraining admixtures.

**Waterproofed cement** is sometimes used where a waterproof or water-repellent concrete or mortar is particularly desirable. It is cement ground with certain soaps and oils. The effectiveness is limited to 3 or 4 ft of water pressure.

**Shrinkage-compensated cements** are special portland cements which expand slightly during the moist curing period, compensating for the shrinkage accompanying later drying. They are used primarily to aid in producing crack-free concrete floor slabs and other members. ASTM C845 covers these cements.

**Regulated-set cements** are special portland cements formulated to set in very short times, producing usable concrete strengths in regulated times of as little as 1 h or less. Such concretes are obviously well suited to repair work done when it is important to minimize downtime.

**Portland Cement Tests** Cement should be tested for all but unimportant work. Tests should be made in accordance with the standard specifications of the ASTM or with the federal specifications where they apply. Samples should be taken at the mill, and tests completed before shipments are made. When this is not possible, samples should be taken at random from sound packages, one from every 10 bbl or 40 bags, and mixed. The total sample should weigh about 6 lb. ASTM requirements for standard portland cements are given in ASTM specification C150.

The **autoclave soundness test** consists of determining the expansion of

a 1 in sq neat cement bar 10 in long which, after 24-h storage in 90 percent or greater humidity, is placed in an autoclave, where the pressure is raised to 295 lb/in<sup>2</sup> in about 1 h, maintained for 3 h, and then brought back to normal in 1½ h. Cements that show over 1 percent expansion may show unsoundness after some years of service; the ASTM allows a maximum of 0.80 percent.

**Time of Setting** Initial set should not be less than 45 min when Vicat needle is used or 60 min when Gilmore needle is used. Final set should be within 10 h. Cement paste must remain plastic long enough to be properly placed and yet submit to finishing operations in a reasonable time.

**Compressive Strength** Minimum requirements for average compressive strength of not less than three 2-in cubes composed of 1 part (by weight) cement and 2.75 parts standard graded mortar sand tested in accordance with ASTM method C109, are shown in Table 6.9.1.

## LIME

**Common lime**, or **quicklime**, when slaked or hydrated, is used for interior plastering and for lime mortar. Mixed with cement, it is used for lime and cement mortar and for stucco. Mortars made with lime alone are not satisfactory for thick walls because of slow-setting qualities. They must never be used under water. Quicklime slakes rapidly with water with much heat evolution, forming calcium hydrate (CaH<sub>2</sub>O<sub>2</sub>). With proper addition of water, it becomes plastic, and the volume of putty obtained is 2 or 3 times the loose volume of the lime before slaking, and its weight is about 2½ times the weight of the lime. Plastic lime sets by drying, by crystallization of calcic hydrate, and by absorbing carbonic acid from the air. The process of hardening is very slow. Popping is likely to occur in plaster unless the lime is sound, as indicated by an autoclave test at 120 lb/in<sup>2</sup> pressure for 2 h.

**Magnesium lime**, used for the same purposes as common or high-calcium lime, contains more than 20 percent magnesium oxide. It slakes more slowly, evolves less heat, expands less, sets more rapidly, and produces higher-strength mortars than does high-calcium quicklime.

**Pulverized and granulated limes** slake completely much more quickly than ordinary lump lime. They are sometimes waterproofed by the addition of stearates and other compounds similar to those used in cement for the same purpose. The waterproofing treatment retards the slaking.

**Hydrated lime** is a finely divided white powder manufactured by slaking quicklime with the requisite amount of water. It has the advantage over lime slaked on the job of giving a more uniform product, free from unslaked lime. It does not have plasticity or water retention equal to freshly slaked quicklime.

**Hydraulic hydrated lime** is used for blending with portland cement and as a masonry cement. It is the hydrated product of calcined impure limestone which contains enough silica and alumina to permit the formation of calcium silicates.

Quicklime is covered by ASTM C5 and hydrated limes by ASTM C6, C206, and C821. The testing methods are covered by other ASTM specifications referenced in the above specifications. ASTM C5 contains instructions and cautions for slaking quicklime, as the chemical reactions following the addition of water to quicklime are exothermic and potentially dangerous.

Table 6.9.1 Minimum Requirements for Average Compressive Strength

Age of test, days	Storage of test pieces	Compressive strength, lb/in <sup>2</sup>				
		Normal	Moderate heat	High early strength	Low heat	Sulfate-resistant
1	1 day moist air	....	....	1,800	....	....
3	1 day moist air, 2 days water	1,800	1,500	3,500	....	1,200
7	1 day moist air, 6 days water	2,800	2,500	....	1,000	2,200
28	1 day moist air, 27 days water	....	....	....	2,500	3,000

1,000 lb/in<sup>2</sup> = 6.895 MPa.

SOURCE: Reprinted from ASTM C150, with permission from ASTM.



Table 6.9.2

Sieve no.	100	50	30	16	8	4
Sieve opening, in	0.0059	0.0117	0.0234	0.0469	0.0937	0.187
Wire diam, in	0.0043	0.0085	0.0154	0.0256	0.0394	0.0606
Sieve size, in	$\frac{3}{8}$	$\frac{3}{4}$	1	1½	2	3
Sieve opening, in	0.375	0.750	1.00	1.50	2.00	3.00
Wire diam, in	0.0894	0.1299	0.1496	0.1807	0.1988	0.2283

## AGGREGATES

### Sand

Sand to be used for mortar, plaster, and concrete should consist of clean, hard, uncoated grains free from organic matter, vegetable loam, alkali, or other deleterious substances. Vegetable or organic impurities are particularly harmful. A quantity of vegetable matter so small that it cannot be detected by the eye may render a sand absolutely unfit for use with cement. Stone screenings, slag, or other hard inert material may be substituted for or mixed with sand. Sand for concrete should range in size from fine to coarse, with not less than 95 percent passing a no. 4 sieve, not less than 10 percent retained on a no. 50 sieve, and not more than 5 percent (or 8 percent, if screenings) passing a no. 100 sieve. A straight-line gradation on a graph, with percentages passing plotted as ordinates to normal scale and sieve openings as abscissas to logarithmic scale, gives excellent results.

The grading of sand for mortar depends upon the width of joint, but normally not less than 95 percent should pass a no. 8 sieve, and it should grade uniformly from coarse to fine without more than 8 percent passing a no. 100 sieve.

Sand for plaster should have at least 90 percent passing a no. 8 sieve and not more than 5 percent passing the no. 100 sieve.

Silt or clayey material passing a no. 200 sieve in excess of 2 percent is objectionable.

**Test of Sand** Sand for use in important concrete structures should always be tested. The strength of concrete and mortar depends to a large degree upon the quality of the sand and the coarseness and relative coarseness of the grains. Sand or other fine aggregate when made into a mortar of 1 part portland cement to 3 parts fine aggregate by weight should show a tensile strength at least equal to the strength of 1:3 mortar of the same consistency made with the same cement and standard sand. If the aggregate is of poor quality, the proportion of cement in the mortar or concrete should be increased to secure the desired strength. If the strength is less than 90 percent that of Ottawa sand mortar, the aggregate should be rejected unless compression tests of concrete made with selected aggregates pass the requirements. The standard Ottawa sand gradation is described in ASTM specification C109. This sand is supplied by the Ottawa Silica Co., Ottawa, Ill. The compressive strength of 2-in cubes made from a cement and sand mixture with a 0.9 water-cement ratio and a flow of 100 percent should equal 90 percent of the strength of similar cubes made with graded Ottawa sand.

The ASTM standard test (C40) for the presence of injurious organic compounds in natural sands for cement mortar or concrete is as follows: A 12-oz graduated glass prescription bottle is filled to the 4½-oz mark with the sand to be tested. A 3 percent solution of sodium hydroxide (NaOH) in water is then added until the volume of sand and liquid, after shaking, gives a total volume of 7 liquid oz. The bottle is stoppered, shaken thoroughly, and then allowed to stand for 24 h. A standard-reference-color solution of potassium dichromate in sulfuric acid is prepared as directed in ASTM D154. The color of the clear liquid above the sand is then compared with the standard-color solution; if the liquid is darker than the standard color, further tests of the sand should be made before it is used in mortar or concrete. The standard color is similar to light amber.

### Coarse Aggregate

**Broken Stone and Gravel** Coarse aggregate for concrete may consist of broken stone, gravel, slag, or other hard inert material with similar characteristics. The particles should be clean, hard, durable, and free from vegetable or organic matter, alkali, or other deleterious matter and should range in size from material retained on the no. 4 sieve to the coarsest size permissible for the structure. For reinforced concrete and small masses of unreinforced concrete, the maximum size should be that which will readily pass around the reinforcement and fill all parts of the forms. Either 1- or 1½-in diam is apt to be the maximum. For heavy mass work, the maximum size may run up to 3 in or larger.

The coarse aggregate selected should have a good performance record, and especially should not have a record of alkali-aggregate reaction which may affect opaline and chert rocks.

**Lightweight aggregates** are usually pumice, lava, slag, burned clay or shale, or cinders from coal and coke. It is recommended that lightweight fine aggregate not be used in conjunction with lightweight coarse aggregate unless it can be demonstrated, from either previous performance or suitable tests, that the particular combination of aggregates results in concrete that is free from soundness and durability problems. In case of doubt, the concrete mix should be designed using sand fine aggregate, and lightweight coarse aggregate. Their application is largely for concrete units and floor slabs where saving in weight is important and where special thermal insulation or acoustical properties are desired.

**Heavyweight aggregates** are generally iron or other metal punchings, ferrophosphate, hematite, magnetite, barite, limenite, and similar heavy stones and rocks. They are used in concrete for counterweights, dry docks, and shielding against rays from nuclear reactions.

**Fineness Modulus** The fineness modulus, which is used in the Abrams method as an index of the characteristics of the aggregates, is the sum of the cumulative percentages (divided by 100) which would be retained by all the sieves in a special sieve analysis. The sieves used in this method are nos. 100, 50, 30, 16, 8, and 4 for fine aggregates and these plus the  $\frac{3}{8}$ -,  $\frac{3}{4}$ -, 1½-, and 3-in sizes for coarse aggregates. A high fineness modulus indicates a relatively low surface area because the particles are relatively large, which means less water required and, therefore, a higher concrete strength. Aggregates of widely different gradation may have the same fineness modulus.

ASTM standard sieves for analysis of aggregates for concrete have the sizes of opening and wire shown in Table 6.9.2.

### WATER

Water for concrete or mortar should be clean and free from oil, acid, alkali, organic matter, or other deleterious substance. Cubes or briquettes made with it should show strength equal to those made with distilled water. Water fit for drinking is normally satisfactory for use with cement. However, many waters not suitable for drinking may be suitable for concrete. Water with less than 2,000 ppm of total dissolved solids can usually be used safely for making concrete. (See Sec. 6.10, Water.)

**Seawater** can be used as mixing water for plain concrete, although 28-day strength may be lower than for normal concrete. If seawater is used in reinforced concrete, care must be taken to provide adequate

cover with a dense air-entrained concrete to minimize risks of corrosion. Seawater should not be used with prestressed concrete.

## ADMIXTURES

Admixtures are substances, other than the normal ingredients, added to mortars or concrete for altering the normal properties so as to improve them for a particular purpose. Admixtures are frequently used to entrain air, increase workability, accelerate or retard setting, provide a pozzolanic reaction with lime, reduce shrinkage, and reduce bleeding. However, before using an admixture, consideration must be given to its effect on properties other than the one which is being improved. Most important is consideration of possible changes in the basic mix which might make the admixture unnecessary. Particular care must be used when using two or more admixtures in the same concrete, such as a retarding agent plus an air-entraining agent, to ensure that the materials are compatible with each other when mixed in concrete. The properties of chemical admixtures should meet ASTM C494 and air-entraining agents should meet ASTM C260.

**Air-entraining agents** constitute one of the most important groups of admixtures. They entrain air in small, closely spaced, separated bubbles in the concrete, greatly improving resistance to freezing and thawing and to deicing agents.

**Accelerators** are used to decrease the setting time and increase early strength. They permit shorter curing periods, earlier form removal, and placing at lower temperatures. Calcium chloride is the most frequently used accelerator and can be used in amounts up to 2 percent of the weight of the cement, but must never be used with prestressed concrete.

**Retarders** increase the setting time. They are particularly useful in hot weather and in grouting operations.

**Water reducers** are used to increase the workability of concrete without an accompanying increase in the water content. The most recent development is the use of high-range water reducers, or superplasticizers, which are polymer liquid materials added to the concrete in the mixer. These materials lead to spectacular temporary increases in slump for a given water content, and may be used to obtain several different results. A normal mix can be transformed into a "flowing" concrete which will practically level itself. Or the addition of the superplasticizer can allow the mix to be redesigned for the same consistency at the time of mixing, but considerably less water will be required and consequently a higher concrete strength can be reached without adding cement, or the same strength can be reached with a lower cement content.

**Fly ash** from coal-burning power plants can be added to concrete mixes to achieve several effects. The very fine material tends to act as a lubricant to the wet concrete, and thus may be added primarily to increase the workability. Fly ash also enters the chemical reactions involved in the setting of concrete and leads to higher strengths. Fly ash is often used in mass concrete such as dams as a replacement for part of the cement, in order to save some material costs, to reduce the rate at which the hydration produces heat, and to increase the long-term strength gain potential of the concrete. Fly ash is a pozzolan, and should meet requirements of ASTM C618. Free carbon from incomplete combustion must be strictly limited.

**Silica Fume** Silica fume, also called **condensed silica fume** or **microsilica**, is another pozzolan which may be added to concrete as a supplement or partial replacement to the cement. This material reacts with the lime in the cement and helps lead to very high-strength, low-permeability concrete. The silica-lime reaction can occur very quickly, and retarders are often necessary in concretes containing silica fume. Concretes containing silica fume tend to be quite dark gray compared with ordinary concrete mixes, and concretes containing fly ash tend to be lighter than the usual concrete gray.

**Ground Granulated Blast-Furnace Slag** Ground granulated blast-furnace slag has been used in Europe as a supplement to or partial replacement for portland cement for several decades but has become available in North America relatively recently. Concretes made with this material tend to develop very low permeabilities, which improves durability by retarding oxygen and chloride penetration, which in turn

protects the reinforcement from corrosion for longer periods. Chloride sources include both deicing chemicals and seawater, and these concretes have been successfully used to resist both these severe environments. They are also sulfate-resistant, which is important in those geographic areas which have sulfate-bearing groundwater.

Other admixtures may be classed as gas-forming agents, pozzolanic materials, curing aids, water-repelling agents, and coloring agents.

## MORTARS

Properties desirable in a mortar include (1) good plasticity or workability, (2) low volume change or volume change of the same character as the units bonded, (3) low absorption, (4) low solubility and thus freedom from efflorescence, (5) good strength in bond and ample strength to withstand applied loads, (6) high resistance to weathering.

**Mortar Types** There are several different types of mortar which are suitable for masonry construction of different kinds, uses, and exposure conditions. The BOCA Basic Building Code lists several mortar types, and their permitted uses are given in Table 6.9.3. The makeup of these mortars is specified in terms of volumes of materials, as listed in Table 6.9.4, also from BOCA. There is considerable leeway given for the proportions, and the materials are mixed with water to the consistency desired by the mason. The portland cement, masonry cement, and lime may be purchased separately or blended, and for small jobs a dry mix mortar containing everything except the water may be purchased in bags. The hydrated lime tends to give the fresh mortar plasticity, or stickiness, which is necessary for the proper bedding of the masonry or concrete units being laid.

Additional mortar types may be used for reinforced masonry, in which steel bars are used to increase the strength in the same way that concrete is reinforced. Other mortars may be used for filling the cavities in concrete block construction, or concrete masonry unit construction, and this mortar may be referred to as grout.

Design procedures and requirements for concrete and clay masonry are contained in ACI 530/TMS 402/ASCE 5. **Unreinforced masonry** cannot be relied on to resist tension stresses. Compressive stresses permitted under the empirical design rules vary widely, depending on the strength and type of masonry unit. The highest stress permitted is 350 lb/in<sup>2</sup> for high-strength solid bricks, while the lowest is 60 lb/in<sup>2</sup> for the lowest-strength hollow-concrete blocks, where the stresses are computed on the gross area and the units are laid with type M or S mortar. Type N mortar leads to stresses which are 10 to 15 percent lower.

**Mortars for Plastering and Stucco** Interior plastering is much less common than it was in the past because of the use of gypsum board products for walls, but is done in various instances. Common lime plaster consists of hydrated lime (usually purchased in prepared, bagged

Table 6.9.3 Masonry and Mortar Types

Type of masonry	Type of mortar permitted
Masonry in contact with earth	M or S
Grouted and filled cell masonry	M or S
Masonry above grade or interior masonry	
Piers of solid units	M, S, or N
Piers of hollow units	M or S
Walls of solid units	M, S, N, or O
Walls of hollow units	M, S, or N
Cavity walls and masonry bonded hollow walls	
Design wind pressure exceeds 20 lb/ft <sup>2</sup>	M or S
Design wind pressure 20 lb/ft <sup>2</sup> or less	M, S, or N
Glass block masonry	S or N
Non-load-bearing partitions and fireproofing	M, S, N, O, or gypsum
Firebrick	Refractory air-setting mortar
Linings of existing masonry, above or below grade	M or S
Masonry other than above	M, S, or N

1 lb/ft<sup>2</sup> = 47.9 Pa.

SOURCE: BOCA Basic Building Code, 1984.

Table 6.9.4 Mortar Proportions Specification Requirements (Parts by Volume)

Mortar type	Portland cement	Masonry cement	Hydrated lime or lime putty		Damp loose aggregate
			Min	Max	
M	1 1	1		¼	
S	1 ½	1	¼	½	Not less than 2¼ and not more than 3 times the sum of the volumes of the cements and lime used
N	1	1	½	1¼	
O	1	1	1¼	2½	

SOURCE: BOCA Basic Building Code, 1984.

form), clean coarse sand, and hair or fiber. The plastering is normally done in two or three layers, with the base coats containing about equal volumes of lime and sand, plus hair or fiber, and the final layer containing less sand. In three-layer work, the first layer is the scratch coat, the second the brown coat, and the last the white or skim coat. The scratch coat is applied directly to either a masonry wall or the lath in a frame wall.

**Skim coat** is a finish coat composed of lime putty and fine white sand. It is placed in two layers and troweled to a hard finish. **Gaged skim coat** is skimming mixed with a certain amount of plaster of paris, which makes it a hard finish. **Hard finish** consists of 1 part lime putty to 1 or 2 parts plaster of paris.

**Keene's cement**, which is an anhydrous calcined gypsum with an accelerator, is much used as a hard-finish plaster.

**Gypsum plaster** (ASTM C28) lacks the plasticity and sand-carrying capacity of lime plaster but is widely used because of its more rapid hardening and drying and because of the uniformity obtainable as the result of its being put up in bags ready-mixed for use.

Gypsum ready-mixed plaster should contain not more than 3 ft<sup>3</sup> of mineral aggregate per 100 lb of calcined gypsum plaster, to which may be added fiber and material to control setting time and workability. Gypsum neat plaster used in place of sanded plaster for second coat should contain at least 66 percent CaSO<sub>4</sub> · ½H<sub>2</sub>O; the remainder may be fiber and retarders. Calcined gypsum for finishing coat may be white or gray. If it contains no retarder, it should set between 20 and 40 min; if retarded, it should set between 40 min and 6 h.

**Cement plaster** is used where a very hard or strong plaster is required, e.g., for thin metal-lath partitions or as a fire protection. It should contain not more than 2 parts sand, by dry and loose volume, to 1 part portland cement. Lime putty or hydrated lime is added up to 15 percent by volume of the cement.

Under moisture conditions where the plaster will not dry rapidly, **curing** at temperatures above 60 and below 90°F is absolutely necessary if cracking is to be avoided.

**Stucco** Stucco is used for exterior plastering and is applied to brick or stone or is plastered onto wood or metal lath. For covering wooden buildings, the stucco is plastered either on wood lath or on metal lath in three coats, using mortar similar to that for brick or stone. Concrete in northern climates exposed to frost should never be plastered but should be finished by rubbing down with carborundum brick or similar tool when the surface is comparatively green. It may also be tooled in various ways. Whenever stucco is used, extreme care must be taken to get a good bond to the supporting surface. While stucco has traditionally been applied with a trowel, it can also be applied pneumatically. Similar material used for lining metal pipes can be applied with a centrifugal device which "slings" the material onto the pipe wall.

For three-coat work on masonry or wood lath, the first or scratch coat should average ¼ in thick outside the lath or surface of the brick. The thickness of the second coat should be ⅜ to ½ in, while the finish coat

should be thin, i.e., ⅛ in or not more than ¼ in. The second coat should generally be applied 24 h after the first or scratch coat. The finish coat should not be applied in less than 1 week after the second coat. Proportions of mix for all coats may be ½ part hydrated lime, 1 part portland cement, 3 parts fairly coarse sand, measured by volume. Stucco work should not be put on in freezing weather and must be kept moist for at least 7 days after application of the mortar.

**Mineral colors for stucco**, if used, should be of such composition that they will not be affected by cement, lime, or the weather. The best method is to use colored sands when possible. The most satisfactory results with colored mortar are obtained by using white portland cement. Prepared patented stuccos which are combinations of cement, sand, plasticizers, waterproofing agents, and pigment are widely used.

## CONCRETE

Concrete is made by mixing cement and an aggregate composed of hard inert particles of varying size, such as a combination of sand or broken-stone screenings, with gravel, broken stone, lightweight aggregate, or other material. Portland cement should always be used for reinforced concrete, for mass concrete subjected to stress, and for all concrete laid under water.

**Proportioning Concrete** Compressive strength is generally accepted as the principal measure of the quality of concrete, and although this is not entirely true, there is an approximate relation between compressive strength and the other mechanical properties. Methods of proportioning generally aim to give concrete of a predetermined compressive strength.

The concrete mixture is proportioned or designed for a particular condition in various ways: (1) arbitrary selection based on experience and common practice, such as 1 part cement, 2 parts sand, 4 parts stone (written **1:2:4**); (2) proportioning on the basis of the water/cement ratio, either assumed from experience or determined by trial mixtures with the given materials and conditions; (3) combining materials on the basis of either the voids in the aggregates or mechanical-analysis curves so as to obtain the least voids and thus concrete of the maximum density for a given cement content.

**Concrete mixes for small jobs** can generally be determined by consultation with a ready-mixed concrete supplier, on the basis of the supplier's experience. If this information is not available, the mixes recommended by ACI Committee 211 and reproduced in Table 6.9.5 can be used as long as the required compressive strength is not higher than perhaps 3,500 lb/in<sup>2</sup>. It is important that the mix be kept as dry as can be satisfactorily compacted, by vibration, into the form work since excess water reduces the eventual compressive strength. And the air entrainment is important for concretes which will be exposed to freeze-thaw cycles after curing.

**For larger jobs** and in all cases where high compressive strength is necessary, the mix must be designed on a more thorough basis. Again,

**Table 6.9.5 Concrete Mixes for Small Jobs**

Procedure: Select the proper maximum size of aggregate. Use mix B, adding just enough water to produce a workable consistency. If the concrete appears to be undersanded, change to mix A, and, if it appears oversanded, change to mix C.

Maximum size of aggregate, in	Mix designation	Approximate weights of solid ingredients per ft <sup>3</sup> of concrete, lb				
		Cement	Sand*		Coarse aggregate	
			Air-entrained concrete†	Concrete without air	Gravel or crushed stone	Iron blast-furnace slag
1/8	A	25	48	51	54	47
	B	25	46	49	56	49
	C	25	44	47	58	51
3/4	A	23	45	49	62	54
	B	23	43	47	64	56
	C	23	41	45	66	58
1	A	22	41	45	70	61
	B	22	39	43	72	63
	C	22	37	41	74	65
1 1/2	A	20	41	45	75	65
	B	20	39	43	77	67
	C	20	37	41	79	69
2	A	19	40	45	79	69
	B	19	38	43	81	71
	C	19	36	41	83	72

\* Weights are for dry sand. If damp sand is used, increase tabulated weight of sand 2 lb and, if very wet sand is used, 4 lb.

† Air-entrained concrete should be used in all structures which will be exposed to alternate cycles of freezing and thawing. Air-entrainment can be obtained by the use of an air-entraining cement or by adding an air-entraining admixture. If an admixture is used, the amount recommended by the manufacturer will, in most cases, produce the desired air content.

SOURCE: ACI 211.

local suppliers of ready-mixed concrete may have records which will be of considerable help. The concrete mix has several contradictory requirements placed on it, so the final product represents a compromise. The hardened concrete must be strong enough for its intended use, it must be durable enough for its expected exposure conditions, and the freshly mixed concrete must be workable enough to be placed and compacted in the forms.

For a given aggregate type and size, the strength is controlled primarily by the water/cement ratio, with a decrease in water content, relative to cement, leading to an increase in strength, as long as the concrete remains workable enough to be placed. The durability is controlled by the water/cement ratio and the air content, assuming a suitable aggregate for the exposure condition. Table 6.9.6, from ACI Committee 211, gives the maximum water/cement ratios which should be used in severe exposure conditions, and Table 6.9.7 gives the water/cement ratios required for various concrete strengths.

For the severe-exposure cases, the air content should be between 4.5 and 7.5 percent, with the smaller value being for larger maximum sized aggregate. These tables establish two of the constraints on the mix design. A third constraint is the consistency of the concrete, as determined by the slump test which is described later. Table 6.9.8 gives the same committee's recommendations about the maximum and minimum slump values for various kinds of members. Stiffer mixes, with slumps less than 1 in, can be placed only with very heavy vibration and with great care to achieve the necessary compaction, but the dry mixes can produce very high concrete strengths with only moderate cement contents. Greater slumps are sometimes necessary when the reinforcement is very congested or the members small, such as thin walls or cast-in-place piling. The higher slumps may be produced with the high-range water reducers, or superplasticizers, without the penalty of requiring excessive water content.

The next constraint on the mix is the maximum size of aggregate. Larger aggregate sizes tend to lead to lower cement contents, but the maximum size used is limited by what is available, and in addition usually should be limited to not more than one-fifth the narrowest width between forms, one-third the thickness of slabs, three-fourths the mini-

**Table 6.9.6 Maximum Permissible Water/Cement Ratios for Concrete in Severe Exposures**

Type of structure	Structure wet continuously or frequently and exposed to freezing and thawing*	Structure exposed to seawater or sulfates
Thin sections (railings, curbs, sills, ledges, ornamental work) and sections with less than 1-in cover over steel	0.45	0.40†
All other structures	0.50	0.45†

\* Concrete should also be air-entrained.

† If sulfate-resisting cement (type II or type V of ASTM C150) is used, permissible water/cement ratio may be increased by 0.05.

SOURCE: ACI 211.

**Table 6.9.7 Relationships between Water/Cement Ratio and Compressive Strength of Concrete**

Compressive strength at 28 days, lb/in <sup>2</sup> *	Water/cement ratio, by weight	
	Non-air-entrained concrete	Air-entrained concrete
6,000	0.41	—
5,000	0.48	0.40
4,000	0.57	0.48
3,000	0.68	0.59
2,000	0.82	0.74

\* Values are estimated average strengths for concrete containing not more than the percentage of air shown in Table 6.9.9. For a constant water/cement ratio, the strength of concrete is reduced as the air content is increased.

Strength is based on 6 × 12 in cylinders moist-cured 28 days at 73.4 ± 3°F (23 ± 1.7°C) in accordance with Section 9(b) of ASTM C31 for Making and Curing Concrete Compression and Flexure Test Specimens in the Field.

Relationship assumes maximum size of aggregate about 3/4 to 1 in; for a given source, strength produced for a given water/cement ratio will increase as maximum size of aggregate decreases. SOURCE: ACI 211.

**Table 6.9.8 Recommended Slumps for Various Types of Construction**

Types of construction	Slump, in	
	Maximum*	Minimum
Reinforced foundation walls and footings	3	1
Plain footings, caissons, and substructure walls	3	1
Beams and reinforced walls	4	1
Building columns	4	1
Pavements and slabs	3	1
Mass concrete	2	1

\* May be increased 1 in for methods of consolidation other than vibration.  
SOURCE: ACI 211.

imum clear spacing between reinforcing steel. Extremely strong concretes will require smaller rather than larger maximum aggregate sizes. Once the maximum-size stone has been selected, the water content to produce the desired slump can be estimated from Table 6.9.9, and once the water content has been determined, the cement content is determined from the required water/cement ratio determined earlier. The volume of coarse aggregate is then determined from Table 6.9.10, and when the fraction is multiplied by the dry rodded unit weight, the weight of coarse aggregate per unit volume of concrete can be found.

The weight of sand needed to make a cubic yard of concrete can then be estimated by adding up the weights of materials determined so far,

**Table 6.9.10 Volume of Coarse Aggregate per Unit Volume of Concrete**

Maximum size of aggregate, in	Volume of dry-rodded coarse aggregate* per unit volume of concrete for different fineness moduli of sand			
	2.40	2.60	2.80	3.00
3/8	0.50	0.48	0.46	0.44
1/2	0.59	0.57	0.55	0.53
3/4	0.66	0.64	0.62	0.60
1	0.71	0.69	0.67	0.65
1 1/2	0.75	0.73	0.71	0.69
2	0.78	0.76	0.74	0.72
3	0.82	0.80	0.78	0.76
6	0.87	0.85	0.83	0.81

\* Volumes are based on aggregates in dry-rodded condition as described in ASTM C 29 for Unit Weight of Aggregate.

These volumes are selected from empirical relationships to produce concrete with a degree of workability suitable for usual reinforced construction. For less workable concrete such as required for concrete pavement construction they may be increased about 10 percent.

SOURCE: ACI 211.

and subtracting from the expected weight of a cubic yard of concrete, which might be estimated at 3,900 lb for an air-entrained concrete and 4,000 lb for a mix without air. This weight should be the surface-dry saturated weight, with a correction made for the moisture content of the sand by increasing the weight of sand and decreasing the amount of mix

**Table 6.9.9 Approximate Mixing Water and Air Content Requirements for Different Slumps and Nominal Maximum Sizes of Aggregates**

Slump, in	Water, lb/yd <sup>3</sup> of concrete for indicated nominal maximum sizes of aggregate							
	3/8 in <sup>a</sup>	1/2 in <sup>a</sup>	3/4 in <sup>a</sup>	1 in <sup>a</sup>	1 1/2 in <sup>a</sup>	2 in <sup>a,b</sup>	3 in <sup>b,c</sup>	6 in <sup>b,c</sup>
Non-air-entrained concrete								
1-2	350	335	315	300	275	260	220	190
3-4	385	365	340	325	300	285	245	210
6-7	410	385	360	340	315	300	270	—
Approximate amount of entrapped air in non-air-entrained concrete, %	3	2.5	2	1.5	1	0.5	0.3	0.2
Air-entrained concrete								
1-2	305	295	280	270	250	240	205	180
3-4	340	325	305	295	275	265	225	200
6-7	365	345	325	310	290	280	260	—
Recommended average <sup>d</sup> total air content, percent for level of exposure:								
Mild exposure	4.5	4.0	3.5	3.0	2.5	2.0	1.5 <sup>e,g</sup>	1.0 <sup>e,g</sup>
Moderate exposure	6.0	5.5	5.0	4.5	4.5	4.0	3.5 <sup>e,g</sup>	3.0 <sup>e,g</sup>
Extreme exposure <sup>g</sup>	7.5	7.0	6.0	6.0	5.5	5.0	4.5 <sup>e,g</sup>	4.0 <sup>e,g</sup>

<sup>a</sup> These quantities of mixing water are for use in computing cement factors for trial batches. They are maxima for reasonably well-shaped angular coarse aggregates graded within limits of accepted specifications.

<sup>b</sup> The slump values for concrete containing aggregate larger than 1 1/2 in are based on slump tests made after removal of particles larger than 1 1/2 in by wet-screening.

<sup>c</sup> These quantities of mixing water are for use in computing cement factors for trial batches when 3 in or 6 in nominal maximum size aggregate is used. They are average for reasonably well-shaped coarse aggregates, well-graded from coarse to fine.

<sup>d</sup> Additional recommendations for air content and necessary tolerances on air content for control in the field are given in a number of ACI documents, including ACI 201, 345, 318, 301, and 302. ASTM C 94 for ready-mixed concrete also gives air-content limits. The requirements in other documents may not always agree exactly so in proportioning concrete consideration must be given to selecting an air content that will meet the needs of the job and also meet the applicable specifications.

<sup>e</sup> For concrete containing large aggregates which will be wet-screened over the 1 1/2 in sieve prior to testing for air content, the percentage of air expected in the 1 1/2 in minus material should be as tabulated in the 1 1/2 in column. However, initial proportioning calculations should include the air content as a percent of the whole.

<sup>f</sup> When using large aggregate in low cement factor concrete, air entrainment need not be detrimental to strength. In most cases mixing water requirement is reduced sufficiently to improve the water/cement ratio and to thus compensate for the strength reducing effect of entrained air concrete. Generally, therefore, for these large maximum sizes of aggregate, air contents recommended for extreme exposure should be considered even though there may be little or no exposure to moisture and freezing.

<sup>g</sup> These values are based on the criteria that 9 percent air is needed in the mortar phase of the concrete. If the mortar volume will be substantially different from that determined in this recommended practice, it may be desirable to calculate the needed air content by taking 9 percent of the actual mortar volume.

SOURCE: ACI 211.

water. Table 6.9.11 gives the expected ranges of water content of fine and coarse aggregates. Concretes with small-maximum-size aggregates will be lighter than the values just cited, and concretes with aggregates larger than 1 in will probably be heavier, and the kind of stone making up the coarse aggregate will also make some difference.

**Table 6.9.11 Free Moisture Content**

	Dry	Damp	Wet
Gravel	0.2	1.0	2.0
Sand	2.0	4.0	7.0

The mix properties just determined represent a starting point, and the final mix will usually be adjusted somewhat after trials have been conducted. Ideally, the trials should be done in a laboratory before the job-site concrete work starts, and the trial mixes should be evaluated for slump, tendency for segregation, ease with which the surface can be finished (especially important for slabs), air content, actual unit weight, actual water requirements for the desired slump, and the compressive strength of the concrete. It must be recognized that the various tables are based on average conditions, and that a particular combination of cement and aggregate may produce a concrete considerably stronger or weaker than expected from these values, and this can be true even when all of the materials meet the appropriate limitations in the ASTM specifications. Admixtures will also change the required mix proportions, and water reducers have the potential of allowing significant reductions in cement content. The tables include values for very large aggregate, up to 6-in maximum size, but aggregate larger than 1½ in will seldom be used in ordinary structures, and such concretes should be left to specialists.

It must also be recognized that consistent quality will be achieved only when care is taken to ensure that the various materials are of consistently good quality. Variations in the size of the sand and coarse aggregate, dirty aggregate, improperly stored cement, very high or low temperatures, and carelessness in any of the batching and mixing operations can reduce the uniformity and quality of the resulting concrete. The addition of extra water "to make it easier to place" is a too-common field error leading to poor concrete, since the extra water increases the water/cement ratio, which reduces the strength and durability. Some of the tests used are described in the following paragraphs.

The **dry rodded weight** is determined by filling a container, of a diameter approximately equal to the depth, with the aggregate in three equal layers, each layer being rodded 25 times using a bullet-pointed rod 5/8 in diam and 24 in long.

**Measurement of materials** is usually done by weight. The bulking effect of moisture, particularly on the fine aggregate, makes it difficult to keep proportions uniform when volume measurement is used. Water is batched by volume or weight.

**Mixing** In order to get good concrete, the cement and aggregates must be thoroughly mixed so as to obtain a homogeneous mass and coat all particles with the cement paste. Mixing may be done either by hand or by machine, although hand mixing is rare today.

**Quality Control of Concrete** Control methods include measuring materials by weight, allowing for the water content of the aggregates; careful limitation of the total water quantity to that designed; frequent tests of the aggregates and changing the proportions as found necessary to maintain yield and workability; constant checks on the consistency by the slump test, careful attention to the placing of steel and the filling of forms; layout of the concrete distribution system so as to eliminate segregation; check on the quality of the concrete as placed by means of specimens made from it as it is placed in the forms; and careful attention to proper curing of the concrete. The field specimens of concrete are usually 6 in diam by 12 in high for aggregates up to 1½ in max size and 8 by 16 in for 3-in aggregate. They are made by rodding the concrete in three layers, each layer being rodded 25 times using a 5/8-in diam bullet-pointed rod 24 in long.

**Machine-mixed concrete** is employed almost universally. The mixing time for the usual batch mixer of 1 yd<sup>3</sup> or less capacity should not be less than 1 min from the time all materials are in the mixer until the time of discharge. Larger mixers require 25 percent increase in mixing time per ½-yd<sup>3</sup> increase in capacity. Increased mixing times up to 5 min increase the workability and the strength of the concrete. Mixing should always continue until the mass is homogeneous.

**Concrete mixers** of the batch type give more uniform results; few continuous mixers are used. Batch mixers are either (1) rotating mixers, consisting of a revolving drum or a square box revolving about its diagonal axis and usually provided with deflectors and blades to improve the mixing; or (2) paddle mixers, consisting of a stationary box with movable paddles which perform the mixing. Paddle mixers work better with relatively dry, high-sand, small-size aggregate mixtures and mortars and are less widely used than rotating mixers.

**Ready-mixed concrete** is (1) proportioned and mixed at a central plant (central-mixed concrete) and transported to the job in plain trucks or agitator trucks, or (2) proportioned at a central plant and mixed in a mixer truck (truck-mixed concrete) equipped with water tanks, during transportation. Ready-mixed concrete is largely displacing job-mixed concrete in metropolitan areas. The truck agitators and mixers are essentially rotary mixers mounted on trucks. There is no deleterious effect on the concrete if it is used within 1 h after the cement has been added to the aggregates. Specifications often state the minimum number of revolutions of the mixer drum following the last addition of materials.

Materials for concrete are also **centrally batched**, particularly for road construction, and transported to the site in batcher trucks with compartments to keep aggregates separated from the cement. The truck discharges into the charging hopper of the job mixer. Road mixers sometimes are arranged in series—the first mixer partly mixes the materials and discharges into a second mixer, which completes the mixing.

**Consistency of Concrete** The consistency to be used depends upon the character of the structure. The proportion of water in the mix is of vital importance. A very wet mixture of the same cement content is much weaker than a dry or mushy mixture. Dry concrete can be employed in dry locations for mass foundations provided that it is carefully spread in layers not over 6 in thick and is thoroughly rammed. Medium, or quaking, concrete is adapted for ordinary mass-concrete uses, such as foundations, heavy walls, large arches, piers, and abutments. Mushy concrete is suitable as rubble concrete and reinforced concrete, for such applications as thin building walls, columns, floors, conduits, and tanks. A medium, or quaking, mixture has a tenacious, jellylike consistency which shakes on ramming; a mushy mixture will settle to a level surface when dumped in a pile and will flow very sluggishly into the forms or around the reinforcing bars; a dry mixture has the consistency of damp earth.

The two methods in common use for measuring the consistency or workability of concrete are the slump test and the flow test. In the **slump test**, which is the more widely used of the two, a form shaped as a frustum of a cone is filled with the concrete and immediately removed. The slump is the subsidence of the mass below its height when in the cone. The form has a base of 8-in diam, a top of 4-in diam, and a height of 12 in. It is filled in three 4-in layers of concrete, each layer being rodded by 25 strokes of a 5/8-in rod, 24 in long and bullet-pointed at the lower end.

A test using the penetration of a half sphere, called the **Kelly ball test**, is sometimes used for field control purposes. A 1-in penetration by the Kelly ball corresponds to about 2 in of slump.

Usual limitations on the consistency of concrete as measured by the slump test are given in Table 6.9.8.

The **consistency** of concrete has some relation to its **workability**, but a lean mix may be unworkable with a given slump and a rich mix may be very workable. Certain admixtures tend to lubricate the mix and, therefore, increase the workability at certain slumps. The slump at all times should be as small as possible consistent with the requirements of handling and placing. A slump over 7 in is usually accompanied by segregation and low strength of concrete, unless the high slump was produced with the aid of a superplasticizer.

**Forms** for concrete should maintain the lines required and prevent leakage of mortar. The pressure on forms is equivalent to that of a liquid with the same density as the concrete, and of the depth placed within 2 h. Dressed lumber or plywood is used for exposed surfaces, and rough lumber for unexposed areas. Wood or steel forms should be oiled before placing concrete.

**Placement** of concrete for most structures is by chutes or buggies. Chutes should have a slope not less than one vertical to two horizontal; the use of flatter slopes encourages the use of excess water, leading to segregation and low strengths. Buggies are preferable to chutes because they handle drier concrete and allow better placement control. Drop-bottom buckets are desirable for large projects and dry concrete. Concrete pumped through pipelines by mechanically applied pressure is sometimes economical for construction spread over large areas. When concrete is to be pumped, it should be a fairly rich mix, with slump of 4 in or more and aggregate not over about 3/4 in, unless it has been determined that the pump can handle harsher concretes. Concrete for tunnels is placed by pneumatic pumps. Underwater concrete is deposited by drop-bottom bucket or by a tremie or pipe. Such concrete should have a cement-content increase of 15 percent to allow for loss of cement in placement.

**Compaction** of concrete (working it into place) is accomplished by tampers or vibrators. Vibrators are applied to the outside of the forms and to the surface or interior of the concrete; they should be used with care to avoid producing segregation. The frequency of vibrators is usually between 3,000 and 10,000 pulsations per minute.

**Curing** of concrete is necessary to ensure proper hydration. Concrete should be kept moist for a period of at least 7 days, and the temperature should not be allowed to fall below 50°F for at least 3 days. Sprayed-on membrane curing compounds may be used to retain moisture. Special precautions must be taken in cold weather and in hot weather.

**Weight of Concrete** The following are average weights, lb/ft<sup>3</sup>, of portland cement concrete:

Sand-cinder concrete	112	Limestone concrete	148
Burned-clay or shale concrete	105	Sandstone concrete	143
Gravel concrete	148	Traprock concrete	155

**Watertightness** Concrete can be made practically impervious to water by proper proportioning, mixing, and placing. Leakage through concrete walls is usually due to poor workmanship or occurs at the joints between 2 days' work or through cracks formed by contraction. New concrete can be bonded to old by wetting the old surface, plastering it with neat cement, and then placing the concrete before the neat cement has set. It is almost impossible to prevent contraction cracks entirely, although a sufficient amount of reinforcement may reduce their width so as to permit only seepage of water. For best results, a low-volume-change cement should be used with a concrete of a quaking consistency; the concrete should be placed carefully so as to leave no visible stone pockets, and the entire structure should be made without joints and preferably in one continuous operation. The best waterproofing agent is an additional proportion of cement in the mix. The concrete should contain not less than 6 bags of cement per yd<sup>3</sup>.

For maximum watertightness, mortar and concrete may require more fine material than would be used for maximum strength. Gravel produces a more watertight concrete than broken stone under similar conditions. Patented compounds are on the market for producing watertight concrete, but under most conditions, equally good results can be obtained for less cost by increasing the percentage of cement in the mix. Membrane waterproofing, consisting of asphalt or tar with layers of felt or tarred paper, or plastic or rubber sheeting in extreme cases, is advisable where it is expected that cracks will occur. Mortar troweled on very hard may produce watertight work.

Concrete to be placed through water should contain at least 7 bags of cement per yd<sup>3</sup> and should be of a quaking consistency.

According to Fuller and Thompson (*Trans. ASCE*, 59, p. 67), watertightness increases (1) as the percentage of cement is increased and in a very much larger ratio; (2) as the maximum size of stone is increased,

provided the mixture is homogeneous; (3) materially with age; and (4) with thickness of the concrete, but in a much larger ratio. It decreases uniformly with increase in pressure and rapidly with increase in the water/cement ratio.

**Air-Entrained Concrete** The entrainment of from 3 to 6 percent by volume of air in concrete by means of vinsol resin or other air-bubble-forming compounds has, under certain conditions, improved the resistance of concrete in roads to frost and salt attack. The air entrainment increases the workability and reduces the compressive strength and the weight of the concrete. As the amount of air entrainment produced by a given percentage of vinsol resin varies with the cement, mixture, aggregates, slump, and mixing time, good results are dependent on very careful control.

**Concrete for Masonry Units** Mixtures for concrete masonry units, which are widely used for walls and partitions, employ aggregates of a maximum size of 1/2 in and are proportioned either for casting or for machine manufacture. Cast units are made in steel or wooden forms and employ concrete slumps of from 2 to 4 in. The proportions used are 1 part cement and 3 to 6 parts aggregate by dry and loose volumes. The forms are stripped after 24 h, and the blocks piled for curing. Most blocks are made by machine, using very dry mixtures with only enough water present to enable the concrete to hold together when formed into a ball. The proportions used are 1 part cement and 4 to 8 parts aggregate by dry and loose volumes. The utilization of such a lean and dry mixture is possible because the blocks are automatically tamped and vibrated in steel molds. The blocks are stripped from the molds at once, placed on racks on trucks, and cured either in air or in steam. High-pressure-steam (50 to 125 lb/in<sup>2</sup>) curing develops the needed strength of the blocks in less than 24 h. Most concrete blocks are made with lightweight aggregates such as cinders and burned clay or shale in order to reduce the weight and improve their acoustical and thermal insulating properties. These aggregates not only must satisfy the usual requirements for gradation and soundness but must be limited in the amount of coal, iron, sulfur, and phosphorus present because of their effect on durability, discoloration and staining, fire resistance, and the formation of "pops." Pops form on the surface of concrete blocks using cinders or burned clay and shale as a result of the increase in volume of particles of iron, sulfur, and phosphorus when acted on by water, oxygen, and the alkalis of the cement.

**Strength of Concrete**

The strength of concrete increases (1) with the quantity of cement in a unit volume, (2) with the decrease in the quantity of mixing water relative to the cement content, and (3) with the density of the concrete. Strength is decreased by an excess of sand over that required to fill the voids in the stone and give sufficient workability. The volume of fine aggregate should not exceed 60 percent of that of coarse aggregate 1 1/2-in max size or larger.

**Compressive Strength** Table 6.9.7 gives the results obtainable with first-class materials and under first-class conditions. Growth in strength with age depends in a large measure upon the consistency characteristics of the cement and upon the curing conditions. Table 6.9.12 gives the change in relative strength with age for several water/cement ratios and a wide range of consistencies for a cement with a good age-strength gain relation. Many normal portland cements today show very little gain in strength after 28 days.

**Tensile Strength** The tensile strength of concrete is of less importance than the crushing strength, as it is seldom relied upon. The true

**Table 6.9.12 Variation of Compressive Strength with Age**  
(Strength at 28 days taken as 100)

Water-cement ratio by weight	3 days	7 days	28 days	3 months	1 year
0.44	40	75	100	125	145
0.62	30	65	100	135	155
0.80	25	50	100	145	165

tensile strength is about 8 percent of the compression strength and must not be confused with the tensile fiber stress in a concrete beam, which is greater.

The tensile strength is not easily measured, and an "indirect tension" test is used, in which a cylinder is loaded along a diametral line. Details of the test are given in ASTM C496. Nearly all the concrete in the plane of the two load strips is in tension. The tensile strength may be computed as  $T = 2P/(\pi ld)$ , where  $T$  = splitting tensile strength, lb/in<sup>2</sup>;  $P$  = maximum load, lb;  $l$  = length of cylinder, in;  $d$  = diameter of cylinder, in.

**Transverse Strength** There is an approximate relationship between the tensile fiber stress of plain concrete beams and their compressive strength. The modulus of rupture is greatly affected by the size of the coarse aggregate and its bond and transverse strength. Quartzite generally gives low-modulus-of-rupture concrete.

The transverse or beam test is generally used for checking the quality of concrete used for roads. The standard beam is 6 by 6 by 20 in, tested on an 18-in span and loaded at the one-third points.

The tensile strength of the concrete as determined by the split cylinder (indirect tension) test is likely to be in the range of 4 to 5 times  $\sqrt{f'_c}$ , where both  $f'_c$  and  $\sqrt{f'_c}$  have units of lb/in<sup>2</sup>. The modulus of rupture values are likely to be somewhat higher, in the range of 6 to 7.5 times  $\sqrt{f'_c}$ .

The strength of concrete in direct shear is about 20 percent of the compressive strength.

**Deformation Properties** Young's modulus for concrete varies with the aggregates used and the concrete strength but will usually be  $3$  to  $5 \times 10^6$  lb/in<sup>2</sup> in short-term tests. According to the ACI Code, the modulus may be expressed as

$$E_c = 33w^{3/2} \sqrt{f'_c}$$

where  $w$  = unit weight of concrete in lb/ft<sup>3</sup> and both  $f'_c$  and  $\sqrt{f'_c}$  have lb/in<sup>2</sup> units. For normal-weight concretes,  $E_c = 57,000 \sqrt{f'_c}$  lb/in<sup>2</sup>.

In addition to the instantaneous deformations, concrete shrinks with drying and is subjected to creep deformations developing with time. Shrinkage strains, which are independent of external stress, may reach 0.05 percent at 50 percent RH, and when restrained may lead to cracking. Creep strains typically reach twice the elastic strains. Both creep and shrinkage depend strongly on the particular aggregates used in the concrete, with limestone usually resulting in the lowest values and river gravel or sandstone in the largest. In all cases, the longer the period of wet curing of the concrete, the lower the final creep and shrinkage values.

## Deleterious Actions and Materials

**Freezing** retards the setting and hardening of portland-cement concrete and is likely to lower its strength permanently. On exposed surfaces such as walls and sidewalks placed in freezing weather, a thin scale may crack from the surface. Natural cement is completely ruined by freezing.

Concrete laid in freezing weather or when the temperature is likely to drop to freezing should have the materials heated and should be protected from the frost, after laying, by suitable covering or artificial heat. The use of calcium chloride, salt, or other ingredients in sufficient quantities to lower the temperature of freezing significantly is not permitted, since the concrete would be adversely affected.

**Mica and Clay in Sand** Mica in sand, if over 2 percent, reduces the density of mortar and consequently its strength, sometimes to a very large extent. In crushed-stone screenings, the effect of the same percentage of mica in the natural state is less marked. Black mica, which has a different crystalline form, is not injurious to mortar. Clay in sand may be injurious because it may introduce too much fine material or form balls in the concrete. When not excessive in quantity, it may increase the strength and watertightness of a mortar of proportions 1 : 3 or leaner.

**Mineral oils** which have not been disintegrated by use do not injure concrete when applied externally. Animal fats and vegetable oils tend to disintegrate concrete unless it has thoroughly hardened. Concrete after it has thoroughly hardened resists the attack of diluted organic acids but is disintegrated by even dilute inorganic acids; protective treatments are magnesium fluorosilicate, sodium silicate, or linseed oil. Green concrete is injured by manure but is not affected after it has thoroughly hardened.

**Electrolysis** injures concrete under certain conditions, and electric current should be prevented from passing through it. (See also Sec. 6.5, Corrosion.)

**Seawater** attacks cement and may disintegrate concrete. Deleterious action is greatly accelerated by frost. To prevent serious damage, the concrete must be made with a sulfate-resisting cement, a rich mix (not leaner than 1 : 2 : 4), and exceptionally good aggregates, including a coarse sand, and must be allowed to harden thoroughly, at least 7 days, before it is touched by the seawater. Although tests indicate that there is no essential difference in the strengths of mortars gaged with fresh water and with seawater, the latter tends to retard the setting and may increase the tendency of the reinforcement to rust.

## 6.10 WATER

by Arnold S. Vernick

(See also Secs. 4.1, 4.2, and 6.1.)

REFERENCES: "Statistical Abstract of the United States, 1994," 114th ed., U.S. Dept. of Commerce, Economics and Statistics Administration, Bureau of the Census, Berman Press, Lanham, MD. van der Leeden, Troise, and Todd, "The Water Encyclopedia," Lewis Publishers, Inc., Chelsea, MI. "Hold the Salt," *Compressed Air Magazine*, March 1995. "Water Treatment Plant Design," 2d ed., ASCE and AWWA, McGraw-Hill. Corbitt, "Standard Handbook of Environmental Engineering," McGraw-Hill. AID Desalination Manual, Aug. 1980, U.S. Department of State. Saline Water Conversion Report, *OSW Annual Reports*, U.S. Department of the Interior. "Water Quality and Treatment," AWWA, 1971. "Safe Drinking Water Act," PL-93-523, Dec. 1974 as amended through 1993. "National Primary and Secondary Drinking Water Regulations," Title 40 CFR Parts 141-143, U.S. Environmental Protection Agency. "The A-B-C of Desalting," OSW, U.S. Department of the Interior, 1977. "New Water for You," OSW, U.S. Department of the Interior, 1970. Howe, "Fundamentals of Water Desalination," Marcel Dekker, New York. Ammerlaan, "Seawater Desalting Energy Requirements," *Desalination*, **40**, pp. 317-326, 1982. "National Water Summary 1985," U.S. Geological Survey. "Second National Water Assessment, The Nation's Water Resources 1975-2000," U.S. Water Resources Council, December 1978. Vernick and Walker, "Handbook of Wastewater Treatment Processes,"

## WATER RESOURCES

Oceans cover 70 percent of the earth's surface and are the basic source of all water. Ocean waters contain about 3½ percent by weight of dissolved materials, generally varying from 32,000 to 36,000 ppm and as high as 42,000 ppm in the Persian Gulf.

About 50 percent of the sun's energy falling on the ocean causes evaporation. The vapors form clouds which precipitate pure water as rain. While most rain falls on the sea, land rainfall returns to the sea in rivers or percolates into the ground and back to the sea or is reevaporated. This is known as the **hydrological cycle**. It is a closed distillation cycle, without additions or losses from outer space or from the interior of the earth.

Water supply to the United States depends on an annual rainfall averaging 30 in (76 cm) and equal to 1,664,800 billion gal (6,301 Gm<sup>3</sup>) per year, or 4,560 billion gal (17.3 Gm<sup>3</sup>) per day. About 72 percent returns to the atmosphere by direct evaporation and transpiration from trees and plants. The remaining 28 percent, or 1.277 billion gal (4.8 Gm<sup>3</sup>) daily, is



properly includes both surface and underground flows. Between 33 and 40 percent of runoff appears as groundwater.

Two-thirds of the runoff passes into the ocean as flood flow in one-third of the year. By increased capture, it would be possible to retain about one-half of the 1,277 billion gal (4.8 Gm<sup>3</sup>), or 638 billion gal (2.4 Gm<sup>3</sup>), per day as **maximum usable water**.

**Withdrawal use** is the quantity of water removed from the ground or diverted from a body of surface water. **Consumptive use** is the portion of such water that is discharged to the atmosphere or incorporated in growing vegetation or in industrial or food products.

The estimated withdrawal use of water in the United States in 1990 was 408 billion gal per day, including some saline waters (see Table 6.10.1). This figure increased historically from 140 billion gal per day to a maximum of 440 billion gal per day in 1980. The reduction of 7.3 percent in the decade since then reflects an increased emphasis on water conservation and reuse.

Fresh-water withdrawal is about 30 percent of runoff, and consumptive use is about 8 percent of runoff. The consumptive use of water for irrigation is about 55 percent, but another 15 percent is allowed for transmission and distribution losses.

Dividing total water withdrawal by the population of the United States shows a 1990 water use, the **water index**, of 1,620 gal (6,132 L) per capita day (gpcd). It reflects the great industrial and agricultural uses of water, because the withdrawal and consumption of water for domestic purposes is relatively small. The average domestic consumption of water in urban areas of the United States in 1980 was 38 gpcd (144 Lpcd). However, since public water utilities also supply industrial and commercial customers, the average withdrawal by U.S. municipal water systems in 1990 was 195 gpcd (738 Lpcd). The reduction in water withdrawal since 1980 cited above is also reflected in water consumption. Consumption per capita per day peaked at 451 gpcd (1,707 Lpcd) in 1975 and was 370 gpcd (1,400 Lpcd) in 1990, a reduction of 18 percent.

**Additions to water resources** for the future can be made by (1) increase in storage reservoirs, (2) injection of used water or flood water into underground strata called **aquifers**, (3) covering reservoirs with films to reduce evaporation, (4) rainmaking, (5) saline-water conversion, or (6) wastewater renovation and reuse.

It is equally important to improve the efficient use of water supplies by (1) multiple use of cooling water, (2) use of air cooling instead of water cooling, (3) use of cooling towers, (4) reclamation of waste waters, both industrial and domestic, (5) abatement of pollution by treatment rather than by dilution, which requires additional fresh water.

**MEASUREMENTS AND DEFINITIONS**

Water **quantities** in this country are measured by U.S. gallons, the larger unit being 1,000 U.S. gal. For agriculture and irrigation, water use is measured in acre-feet, i.e., the amount of water covering 1 acre of surface to a depth of 1 ft. In the British-standard area, the imperial gallon is used. In SI or metric-system areas, water is measured in litres

(L) and the larger unit is the cubic metre, expressed as m<sup>3</sup>, which equals a metric ton of water.

**Conversion Table**

1 acre · ft =	325,850 U.S. gal or 326,000 approx
1 acre · ft =	1,233 t or m <sup>3</sup>
1 acre · ft =	43,560 ft <sup>3</sup>
1 imperial gal =	1.20 U.S. gal
1 m <sup>3</sup> =	1000 L
1 L =	0.2642 gal
1 metric ton (t) =	1,000 kg
	= 2,204 lb
	= (264.2 U.S. gal)
	= 220 imperial gal
1 U.S. ton =	240 U.S. gal
1,000,000 U.S. gal =	3.07 acre · ft

For stream flow and hydraulic purposes, water is measured in cubic feet per second.

$$1,000,000 \text{ U.S. gal per day} = 1.55 \text{ ft}^3/\text{s} \text{ (} 0.044 \text{ m}^3/\text{s}) \\ = 1,120 \text{ acre} \cdot \text{ft (} 1,380,000 \text{ m}^3) \\ \text{per year}$$

Water **costs** are expressed in terms of price per 1,000 gal, per acre · foot, per cubic foot, or per cubic metre.

$$10\text{¢ per 1,000 gal} = \$32.59 \text{ per acre} \cdot \text{ft} \\ = 0.075\text{¢ per ft}^3 \\ = 2.64\text{¢ per m}^3$$

Water **quality** is measured in terms of solids, of any character, which are suspended or dissolved in water. The concentration of solids is usually expressed in parts per million or in grains per gallon. One grain equals 1/7,000 lb (64.8 mg). Therefore, 17.1 ppm = 1 grain per U.S. gal. In the metric system, 1 ppm = 1 g/m<sup>3</sup> = 1 mg/L.

Standards for drinking water, or **potable water**, have been established by the U.S. Environmental Protection Agency. The recommended limit for a specific containment is shown in Table 6.10.2. The limitations indicated in the table apply to public water systems, with the primary regulations being established to protect public health, while the secondary regulations control aesthetic qualities relating to the public acceptance of drinking water.

For **agricultural water**, mineral content of up to 700 mg/L is considered excellent to good. However, certain elements are undesirable, particularly sodium and boron. The California State Water Resources Board limits class I irrigation water to:

	Max mg/L
Sodium, as % of total sodium, potassium, magnesium, and calcium equivalents	60
Boron	0.5
Chloride	177
Sulfate	960

Class II irrigation water may run as high as 2,100 mg/L total dissolved solids, with higher limits on the specific elements, but whether

**Table 6.10.1 U.S. Water Withdrawals and Consumption per Day by End Use, 1990**

	Total, 10 <sup>9</sup> gal <sup>a</sup>	Per capita, <sup>b</sup> gal	Irrigation, 10 <sup>9</sup> gal	Public water utilities <sup>c</sup>				Steam electric utilities, 10 <sup>9</sup> gal
				Total, 10 <sup>9</sup> gal	Per capita, <sup>b</sup> gal	Rural domestic, <sup>d</sup> 10 <sup>9</sup> gal	Industrial and misc., <sup>e</sup> 10 <sup>9</sup> gal	
Withdrawal	408	1,620	137	41	195	7.9	30	195
Consumption	96	370	76	7.1 <sup>f</sup>	38 <sup>f</sup>	8.9	6.7	4.0

<sup>a</sup> Conversion factor: gal × 3.785 = L.

<sup>b</sup> Based on Bureau of the Census resident population as of July 1.

<sup>c</sup> Includes domestic and commercial water withdrawals.

<sup>d</sup> Rural farm and nonfarm household and garden use, and water for farm stock and dairies.

<sup>e</sup> Includes manufacturing, mining, and mineral processing, ordnance, construction, and miscellaneous.

<sup>f</sup> 1980 data—latest available.

SOURCE: "Statistical Abstract of the United States, 1994." U.S. Dept. of Commerce, Economics and Statistics Administration, Bureau of the Census, 114th ed., Bernal Press, Lanham, MD.

Table 6.10.2 Potable Water Contaminant Limitations

Primary standards			
Organic contaminants		Inorganic contaminants	
Contaminant	MCL, mg/L	Contaminant	MCL, mg/L
Vinyl chloride	0.002	Fluoride	4.0
Benzene	0.005	Asbestos	7 million fibers/L (longer than 10 µm)
Carbon tetrachloride	0.005	Barium	2
1,2-Dichloroethane	0.005	Cadmium	0.005
Trichloroethylene	0.005	Chromium	0.1
para-Dichlorobenzene	0.075	Mercury	0.002
1,1-Dichloroethylene	0.007	Nitrate	10 (as nitrogen)
1,1,1-Trichloroethane	0.2	Nitrite	1 (as nitrogen)
cis-1,2-Dichloroethylene	0.07	Total nitrate and nitrite	10 (as nitrogen)
1,2-Dichloropropane	0.005	Selenium	0.05
Ethylbenzene	0.7	Antimony	0.006
Monochlorobenzene	0.1	Beryllium	0.004
o-Dichlorobenzene	0.6	Cyanide (as free cyanide)	0.2
Styrene	0.1	Nickel	0.1
Tetrachloroethylene	0.005	Thallium	0.002
Toluene	1	Arsenic	0.05
trans-1,2-Dichloroethylene	0.1	Lead	0.015
Xylenes (total)	10	Copper	1.3
Dichloromethane	0.005	Radionuclides	
1,2,4-Trichlorobenzene	0.07	Contaminant	MCL, pCi/L*
1,1,2-Trichloroethane	0.005	Gross alpha emitters	15
Alachlor	0.002	Radium 226 plus 228	5
Aldicarb	0.003	Radon	300
Aldicarb sulfoxide	0.004	Gross beta particle and photon Emitters	4m Rem
Aldicarb sulfone	0.003	Uranium	20 µL (equivalent to 30 pCi/L)
Atrazine	0.003	Bacteria, Viruses, Turbidity, Disinfectants and By-products— Refer to 40CFR141	
Carbofuran	0.04	Secondary standards†	
Chlordane	0.002	Contaminant	Level
Dibromochloropropane	0.0002	Aluminum	0.05 to 0.2 mg/L
2,4-D	0.07	Chloride	250 mg/L
Ethylene dibromide	0.00005	Color	15 color units
Heptachlor	0.0004	Copper	1.0 mg/L
Heptachlor epoxide	0.0002	Corrosivity	Noncorrosive
Lindane	0.0002	Fluoride	2.0 mg/L
Methoxychlor	0.04	Foaming agents	0.5 mg/L
Polychlorinated biphenyls	0.0005	Iron	0.3 mg/L
Pentachlorophenol	0.001	Manganese	0.05 mg/L
Toxaphene	0.003	Odor	3 threshold odor number
2,4,5-TP	0.05	pH	6.5–8.5
Benzo(a)pyrene	0.0002	Silver	0.1 mg/L
Dalapon	0.2	Sulfate	250 mg/L
Di(2-ethylhexyl)adipate	0.4	Total dissolved solids (TDS)	500 mg/L
Di(2-ethylhexyl)phthalate	0.006	Zinc	5 mg/L
Dinoseb	0.007		
Diquat	0.02		
Endothall	0.1		
Endrin	0.002		
Glyphosate	0.7		
Hexachlorobenzene	0.001		
Hexachlorocyclopentadiene	0.05		
Oxamyl (Vydate)	0.2		
Picloram	0.5		
Simazine	0.004		
2,3,7,8-TCDD (Dioxin)	$3 \times 10^{-8}$		

\* Except as noted.

† Not federally enforceable; intended as guidelines for the states.

SOURCE: EPA Primary Drinking Water Regulations (40CFR141). EPA Secondary Drinking Water Regulations (40CFR143).

such water is satisfactory or injurious depends on the character of soil, climate, agricultural practice, and type of crop.

Waters containing dissolved salts are called **saline waters**, and the lower concentrations are commonly called **brackish**; these waters are defined, in mg/L, as follows:

Saline	All concentrations up to 42,000
Slightly brackish	1,000–3,000
Brackish	3,000–10,000
Seawaters, average	32,000–36,000
Brine	Over 42,000

**Hardness** of water refers to the content of calcium and magnesium salts, which may be bicarbonates, carbonates, sulfates, chlorides, or nitrates. Bicarbonate content is called **temporary hardness**, as it may be removed by boiling. The salts in ‘hard water’ increase the amount of soap needed to form a lather and also form deposits or ‘scale’ as water is heated or evaporated.

Hardness is a measure of calcium and magnesium salts expressed as equivalent calcium carbonate content and is usually stated in mg/L (or in grains per gal) as follows: very soft water, less than 15 mg/L; soft water, 15 to 50 mg/L, slightly hard water, 50 to 100 mg/L; hard water, 100 to 200 mg/L; very hard water, over 220 mg/L.

Table 6.10.3 Water Use in U.S. Manufacturing by Industry Group, 1983

Industry	Establishments reporting*	Gross water used				Water discharged	
		Total			Water recycled, † 10 <sup>9</sup> gal	Quantity 10 <sup>9</sup> gal	Percent untreated
		Quantity, 10 <sup>9</sup> gal	Average per establishment, 10 <sup>6</sup> gal	Water intake, 10 <sup>9</sup> gal			
Food and kindred products	2,656	1,406	529	648	759	552	64.5
Tobacco products	20	34	1,700	5	29	4	N/A
Textile mill products	761	333	438	133	200	116	52.6
Lumber and wood products	223	218	978	86	132	71	63.4
Furniture and fixtures	66	7	106	3	3	3	100.0
Paper and allied products	600	7,436	12,393	1,899	5,537	1,768	27.1
Chemicals and allied products	1,315	9,630	7,323	3,401	6,229	2,980	67.0
Petroleum and coal products	260	6,177	23,758	818	5,359	699	46.2
Rubber, miscellaneous plastic products	375	328	875	76	252	63	63.5
Leather and leather products	69	7	101	6	1	6	N/A
Stone, clay, and glass products	602	337	560	155	182	133	75.2
Primary metal products	776	5,885	7,584	2,363	3,523	2,112	58.1
Fabricated metal products	724	258	356	65	193	61	49.2
Machinery, excluding electrical	523	307	587	120	186	105	67.6
Electrical and electronic equipment	678	335	494	74	261	70	61.4
Transportation equipment	380	1,011	2,661	153	859	139	67.6
Instruments and related products	154	112	727	30	82	28	50.0
Miscellaneous manufacturing	80	15	188	4	11	4	N/A
Total	10,262	33,835	3,297	10,039	23,796	8,914	54.9

\* Establishments reporting water intake of 20 million gal or more, representing 96 percent of the total water use in manufacturing industries.

† Refers to water recirculated and water reused.

N/A = not available.

SOURCE: "The Water Encyclopedia," 1990.

## INDUSTRIAL WATER

The use of water within a given industry varies widely because of conditions of price, availability, and process technology (see Table 6.10.3).

When a sufficient water supply of suitable quality is available at low cost, plants tend to use maximum volumes. When water is scarce and costly at an otherwise desirable plant site, improved processes and careful water management can reduce water usage to the minimum. Industrial water may be purchased from local public utilities or self-supplied. Approximately 79 percent of the water used by the chemical industry in the United States comes from company systems, and 66 percent of those self-supplied plants utilize surface water as their source of supply as shown in Table 6.10.4.

The cost of usable water is highly sensitive to a variety of factors including geographic location, proximity to an abundant water source, quality of the water, regulatory limitations, and quantity of water used. Raw surface water not requiring much treatment prior to use can cost as little as 7¢ to 15¢ per 1,000 gal (1.8¢ to 4¢ per m<sup>3</sup>) in areas of the United States where water is plentiful, or as much as \$1.75 to \$2.00 per 1,000 gal (46¢ to 53¢ per m<sup>3</sup>) in water-scarce areas. These costs include collection, pumping, storage tanks, distribution and fire-protection facilities, but treatment, if needed, would add materially to these figures.

The cost of water obtained from public supply systems for industrial use also varies considerably depending upon geographic location and water usage. An EPA survey of over 58,000 public water systems in 1984 indicated water costs as high as \$2.30 per 1,000 gal (61¢ per m<sup>3</sup>) in New England for water use of 3,750 gal, to a low of 88¢ per 1,000 gal (23¢ per m<sup>3</sup>) in the northwest for water use of 750,000 gal. Water cost in 1983 in Houston, Texas, for the highest volume users, which includes refineries and chemical plants, was \$1.14 per 1,000 gal (30¢ per m<sup>3</sup>).

The use of water by the chemical industry is reflected in Table 6.10.5.

About 80 percent of industrial water is used for cooling, mostly on a once-through system. An open recirculation system with cooling tower or spray pond (Fig. 6.10.1) reduces withdrawal use of water by over 90 percent but increases consumptive use by 3 to 8 percent because of evaporation loss. Even more effective reduction in water demand can be achieved by multiple reuse. An example is shown in Fig. 6.10.2.

**Quality requirements** for general plant use (nonprocess) are that the water be low in suspended solids to prevent clogging, low in total dis-

Table 6.10.4 Sources of Water for Chemical Plants

	Quantity, billion gal/year ( $\times 3.785 \times 10^{-3}$ = billion m <sup>3</sup> /year)
By source	
Public water systems	727
Company systems	3,399
Surface water	2,251
Groundwater	366
Tidewater	782
Other	200
By type	
Fresh	3,425
Brackish	182
Salt	719

Table 6.10.5 How Water Is Used in Chemical Plants

Use	Quantity, billion gal/year ( $\times 3.785 \times 10^{-3}$ = billion m <sup>3</sup> /year)
Process	754
Cooling and condensing	
Electric power generation	480
Air conditioning	71
Other	2,760
Sanitary service	38
Boiler feed	112
Other	81

solved solids to prevent depositions, free of organic growth and color, and free of iron and manganese salts. Where the water is also used for drinking, quality must meet the Environmental Protection Agency regulations.

**Cooling service** requires that water be nonclogging. Reduction in suspended solids is made by settling or by using a coagulating agent such as alum and then settling. For recirculating-type cooling systems, corro-

sion inhibitors such as polyphosphates and chromates are added; algaecides and biocides may be needed to control microorganism growth; for cooling jackets on equipment, hardness may cause scaling and should be reduced by softening.

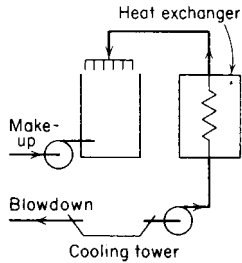

Fig. 6.10.1 Open recirculating system.

**Process-water quality requirements** are often more exacting than potable-water standards; e.g., boiler feedwater must have less than 1 mg/L of dissolved solids (see Sec. 6, Corrosion, and Sec. 9, Steam Boilers). The required quality may be met by the general plant water as available or must be provided by treatment.

Table 6.10.6 shows methods and objectives for industrial-water treatment.

#### WATER POLLUTION CONTROL

A pollutant is defined in the Federal Clean Water Act as "dredge spoil, solid waste, incinerator residue, sewage, garbage, sewage sludge, munitions, chemical wastes, biological materials, heat, wrecked or discarded equipment, rock, sand, cellar dirt, and industrial, municipal, and agricultural waste discharged into water."

Control of water pollution in the United States is a joint responsibility of the U.S. Environmental Protection Agency and the state environmental protection departments. Promulgation of regulations controlling both industrial and municipal wastewater discharges has been accomplished by the EPA as mandated by the Clean Water Act. Enforcement has been largely delegated to the States, with the EPA serving in an oversight role. Water quality standards for specific streams and lakes have been established by the States, or interstate agencies where appropriate, which frequently mandate tighter control of discharges where local conditions warrant such action.

For the support of fish and aquatic life, water must contain a supply of **dissolved oxygen (DO)**. Organic wastes consume oxygen by microbiological action, and this effect is measured by the **biochemical oxygen-demand (BOD)** test.

The discharge of industrial wastewater in the United States is controlled by permits issued by the States and/or the EPA to each facility. The permits set specific limits for applicable pollutant parameters such as suspended solids, BOD, COD, color, pH, oil and grease, metals, ammonia, and phenol. In order to achieve these limitations, most industrial facilities must treat their wastewater effluent by either physical, chemical or biological methods.

The investment by industry in water pollution abatement facilities and the annual cost of operating these facilities have increased dramatically over the last two decades. In 1992, manufacturing industries in the United States spent a total of \$2.5 billion in capital expenditures and \$6.6 billion in operating costs on water pollution abatement facilities (see Table 6.10.7). These amounts represented 32 and 38 percent, respectively, of the total amount spent by industry for all pollution abatement and environmental protection activities. The chemical industry was the major contributor to these totals, spending approximately 40 percent of its capital expenditures and 30 percent of its operating costs for water pollution abatement.

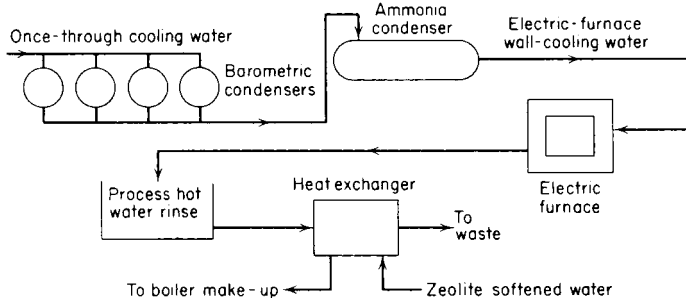

Fig. 6.10.2 Stepwise or cascade cooling system.

Table 6.10.6 Water Treatment

Treatment	Method	Objective
Clarification	Presedimentation Coagulation Settling Filtering	Remove suspended solids and reduce turbidity, color, organic matter
Disinfection	Add chlorine, 5 to 6 ppm, or continuous-feed to maintain 0.2 to 0.3 ppm residual-free $\text{Cl}_2$	Prevent algae and slime growth
Softening	Cold-lime process	Reduce temporary hardness to 85 ppm; also reduce iron and manganese
Membrane processes	Hot-lime-soda process	Reduce total hardness to 25 ppm
	Zeolite	Reduce total hardness to 5 ppm
	Reverse osmosis	Partial removal of ions; can reduce seawater and brackish water to 550 ppm or less
Dem mineralization	Electrodialysis	Partial removal of ions; can reduce 10,000 ppm brackish water to 500 ppm or less
	Ion exchange: two-stage or mixed-bed	Remove both positive and negative ions (cations and anions) to provide very pure water
Distillation	Evaporation using steam heat	Produce very pure water—10 ppm or less total solids

**Table 6.10.7 Water Pollution Abatement Capital Expenditures and Operating Costs of Manufacturing Industry Groups, 1992**

Industry group	Pollution abatement capital expenditures, million \$		Pollution abatement gross operating costs, million \$*	
	Total†	Water	Total‡	Water
Food and kindred products	316.8	202.6	1,312.0	835.7
Lumber and wood products	94.5	18.9	243.0	49.5
Paper and allied products	1,004.6	373.4	1,860.7	822.7
Chemicals and allied products	2,120.9	1,017.3	4,425.1	1,946.8
Petroleum and coal products	2,685.0	492.6	2,585.4	742.8
Stone, clay, and glass products	138.8	20.2	491.2	94.6
Primary metal industries	525.7	123.5	1,993.4	575.0
Fabricated metal products	103.3	42.4	761.2	284.3
Machinery, excluding electrical	150.3	31.7	463.7	160.5
Electrical, electronic equipment	126.6	45.6	657.1	288.8
Transportation equipment	281.0	69.2	1,171.7	347.0
Instruments, related products	89.1	18.8	331.9	89.4
All industries‡	7,866.9	2,509.8	17,466.4	6,576.9

\* Includes payments to governmental units.

† Includes air, water, hazardous waste, and solid waste.

‡ Includes industries not shown separately; excludes apparel and other textile products, and establishments with less than 20 employees.

SOURCE: "Statistical Abstract of the United States," 1994.

**Physical treatment** includes screening, settling, flotation, equalization, centrifuging, filtration, and carbon adsorption. **Chemical treatment** includes coagulation or neutralization of acids with soda ash, caustic soda, or lime. Alkali wastes are treated with sulfuric acid or inexpensive waste acids for neutralization. Chemical oxidation is effective for certain wastes. **Biological treatment** is accomplished by the action of two types of microorganisms: aerobic, which act in the presence of oxygen, and anaerobic, which act in the absence of oxygen. Most organic wastes can be treated by biological processes.

The principal wastewater treatment techniques include the activated sludge process, trickling filters and aerated lagoons, which all employ aerobic microorganisms to degrade the organic waste material. Anaerobic processes are mainly employed for digestion of the sludge produced by biological wastewater treatment.

## WATER DESALINATION

An *average seawater* contains 35,000 ppm of dissolved solids, equal to 3½ percent by weight of such solids, or 3.5 lb per 100 lb; in 1,000 gal, there are 300 lb of dissolved chemicals in 8,271 lb of pure water. The principal ingredient is sodium chloride (common salt), which accounts for about 80 percent of the total. Other salts are calcium sulfate (gypsum), calcium bicarbonate, magnesium sulfate, magnesium chloride, potassium chloride, and more complex salts. Because these dissolved chemicals are dissociated in solution, the composition of seawater is best expressed by the concentration of the major ions (see Table 6.10.8). Even when the content of total solids in seawater varies because of dilution or concentration, for instance Arabian Gulf water with total dissolved solids concentrations of 45,000 to 50,000 ppm, the proportion of the ions remains almost constant.

The **composition of brackish waters** varies so widely that no average analysis can be given. In addition to sodium chloride and sulfate, brackish well waters often contain substantial amounts of calcium, magnesium, bicarbonate, iron, and silica.

**Desalination** is the process by which seawater and brackish water are purified. It has been practiced for centuries, primarily aboard sailing vessels, but recently its application has grown significantly in the form of land-based facilities. The International Desalination Association reports that there are more than 9,000 commercial desalination plants in operation worldwide in 1995, whose total capacity exceeds approximately 4 billion gal per day.

**Purification of seawater** normally requires reduction of 35,000 ppm of total dissolved solids to less than 500 ppm, or a reduction of 70 to 1.

For potable water, it is desirable to have a chloride content below 250 mg/L. The oldest method of purification of seawater is **distillation**. This technique has been practiced for over a century on oceangoing steamships. Distillation is used in over 95 percent of all seawater conversion plants and is principally accomplished by multiple-effect distillation, flash distillation, and vapor-compression distillation.

**Purification of brackish water** requires dissolved solids reductions ranging from a low of 3 to 1, to a high of 30 to 1. In this range, **membrane** desalting processes are more economical. Over 95 percent of all brackish water plants use either the reverse-osmosis process or the electrodialysis process.

In **flash distillation**, the salt water is heated in a tubular brine heater and then passed to a separate chamber where a pressure lower than that in the heating tubes prevails. This causes some of the hot salt water to vaporize, or "flash," such vapor then being condensed by cooler incoming salt water to produce pure distilled water. Flash distillation can be carried on in a number of successive stages (Fig. 6.10.3) wherein the heated salt water flashes to vapor in a series of chambers, each at a lower pressure than the preceding one. The higher the number of stages in such a **multistage flash (MSF)** system, the better the overall yield per heat unit. Today's large-scale MSF plants are designed with 15 to 30 stages and operate at performance ratios of 6 to 10, which means that for every 1 lb (kg) of steam, 6 to 10 lb (kg) of product water is produced.

An advantageous feature of flash distillation is that the separate heating of salt water without boiling causes fewer scale deposits. No scale occurs in the flash chambers as they contain no heated surfaces, the increased concentration of salts remaining in the seawater. Designs of MSF evaporators provide a great number of horizontal stages in one

**Table 6.10.8 Ions in Seawater**

Ions	ppm	lb/1,000 gal	mg/L
Chloride	19,350	165.6	19,830
Sodium	10,600	91.2	10,863
Sulfate	2,710	23.2	2,777
Magnesium	1,300	11.1	1,332
Calcium	405	3.48	415
Potassium	385	3.30	395
Carbonate and bicarbonate	122	1.05	125
Total principal ingredients	34,872	298.9	35,737
Others	128	1.1	131
Total dissolved solids	35,000	300.0	35,868

SOURCE: Compiled from Spiegler, "Salt Water Purification," and Ellis, "Fresh Water from the Ocean."

vessel by putting vertical partition walls inside the vessel (Fig. 6.10.3). All large MSF plants are designed this way.

If a saline water is made to boil, by heating it with steam through a heat-transfer surface, and the vapors from the saline water are subsequently condensed, a distillate of practically pure water (< 10 ppm salt) is obtained. This is known as **single-effect** distillation.

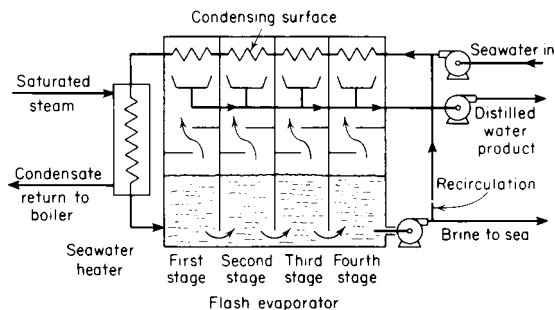

Fig. 6.10.3 Multiple-stage (four-stage) flash distillation process.

**Multiple-effect** distillation is achieved by using the condensation heat of the saline water vapor for boiling additional seawater in a following vessel or **effect** and repeating this step several more times. Each subsequent effect is operating at a somewhat lower temperature and vapor pressure than the previous one. In a single effect, 1 lb (kg) of steam will produce nearly 0.9 lb (kg) of distilled water, a double effect will yield 1.75 lb (kg) of product, and so on. In commercial seawater desalting plants, up to 17 effects have been employed.

Older multieffect plants used tubes submerged in seawater (**submerged-tube evaporators**), but scaling was always a serious problem and this type of design has been phased out in favor of thin-film designs. Only for small, low-temperature waste heat evaporators is a submerged-tube design sometimes applied. In a **thin-film** evaporator, saline water flows as a thin film of water through the inside of a vertical tube (VTE), or over the outside of a bundle of horizontal tubes (HT) after being sprayed on the bundle. Heating of the thin film of seawater is accomplished by condensing steam on the opposite side of the tube wall. See Figs. 6.10.4 and 6.10.5. Horizontal tube designs with vertically stacked effects have been developed.

In **vapor-compression distillation** (Fig. 6.10.6), the energy is supplied by a compressor which takes the vapor from boiling salt water and compresses it to a higher pressure and temperature to furnish the heat for vaporization of more seawater. In so doing, the vapor is condensed to yield distilled water. Vapor compression is theoretically a more efficient method of desalination than other distillation methods. The principle was widely applied during World War II in the form of small, portable units, and still is often used for relatively small plants of up to 200,000 gpd (32 m<sup>3</sup>/h). The disadvantages of this process lie in the cost, mechanical operation, and maintenance of the compressors.

**Reverse osmosis** (Figs. 6.10.7 and 6.10.8), in which a membrane permits fresh water to be forced through it but holds back dissolved solids, has now emerged as the most commonly used process for desalting brackish waters containing up to 10,000 ppm of total dissolved solids.

Two commercially available membrane configurations exist: (1) hollow thin-fiber membrane cartridges and (2) spiral-wound sheet membrane modules. Brackish water plants operate at pressures ranging from 250 to 400 lb/in<sup>2</sup> (17 to 27 bar), which is sufficient to reverse the osmotic flow between brackish water and fresh water.

In the last few years, high-pressure membranes capable of operating at 800 to 1,000 lb/in<sup>2</sup> (55 to 70 bar) have been commercialized for one-stage desalting of seawater. Several reverse-osmosis seawater plants exceeding 1 mgd (160 m<sup>3</sup>/h) are presently in operation in Saudi Arabia, Malta, Bahrain, and Florida. Recovery of power from the high-pressure brine discharged from the reverse-osmosis plant is economically attractive for seawater plants because of the high operating pres-

sure and the relatively large quantities of brine (65 to 80 percent of feed) discharged.

**Electrodialysis** (Fig. 6.10.9) is a proven method of desalination, but where used on ocean water, it is not competitive. The purification of brackish or low-saline waters lends itself most advantageously to the process. The ions of dissolved salts are pulled out of saline water by electric forces and pass from the salt-water compartment into adjacent compartments through membranes which are alternately permeable to positively charged ions or to negatively charged ions.

Electrodialysis equipment typically contains 100 or more compartments between one set of electrodes. The number of cells and the amount of electric current required increase with the amount of purification to be done. A brackish water of 5,000 ppm max dissolved salts can be reduced to potable water with less than 500 ppm. Over 600 electro dialysis plants have been installed since the commercialization of the process 40 years ago. Most of these plants are relatively small: 50,000 gpd (8 m<sup>3</sup>/h) or less.

Other methods of purifying seawater include freezing and solar evaporation. The freezing process yields ice crystals of pure water, but a certain amount of salt water is trapped in the crystals which then has to be removed by washing, centrifugation, or other means. This process is promising because theoretically it takes less energy to freeze water than to distill it; but it is not yet in major commercial application because in several pilot plants the energy consumption was much higher, and the yield of ice much lower, than anticipated.

Solar evaporation produces about 0.1 gpd of water per ft<sup>2</sup> of area [0.17 L/(m<sup>2</sup>·h)], depending on climatic conditions. Capital and maintenance costs for the large areas of glass that are required so far have not made solar evaporation competitive.

A major problem in desalting processes, especially distillation, is the concentration of dissolved salts. Heating seawater above 150°F (65°C) causes **scale**, a deposition of insoluble salts on the heating surfaces, which rapidly reduces the heat transfer. For initial temperatures of 160 to 195°F (71 to 90°C), the addition of polyphosphates results in the formation of a sludge rather than a hard scale. This practice is widely used in ships and present land-based plants but is limited to 195°F (90°C). Some plants use acid treatment that permits boiling of seawater at 240 to 250°F (115 to 121°C). This improves the performance of the process and reduces costs.

In recent years, polymer additives have become available that allow operating temperatures of 230 to 250°F (110 to 121°C) and eliminate the hazardous handling of strong acids and the possibility of severe corrosion of equipment. In reverse osmosis and electro dialysis, scale formation on the membranes is also controlled by adding acid and other additives or by the prior removal of the hardness from the feed by lime softening. Reversing the polarity of the applied dc power can greatly minimize or entirely eliminate the need for pretreatment and additives for the electro dialysis process.

**Energy requirements** for the various commercial desalting processes are shown in Fig. 6.10.10 in terms of primary energy sources, such as oil, coal, or gas. The method and arrangement by which primary energy is converted to usable energy, e.g., mechanical shaft power, steam, or electricity, has a profound impact on the energy requirements and cost of every desalting process.

**Cost of desalting equipment** at the 1-mgd level (160 m<sup>3</sup>/h), complete and installed, generally ranges from \$6 to \$8 per gpd (\$37,500 to \$50,000 per m<sup>3</sup>/h) installed capacity for both distillation and reverse-osmosis seawater plants.

Electrodialysis and reverse-osmosis brackish water plants of similar capacity usually range from \$1.50 to \$2.00 per gpd (\$9,400 to \$12,500 per m<sup>3</sup>/h). **Total operating costs**, including capital depreciation, power and chemical consumption, maintenance and operating personnel, for a 1-mgd (160-m<sup>3</sup>/h) facility fall into three categories: (1) seawater single-purpose distillation and reverse osmosis without power recovery = \$6 to \$8 per 1,000 gal (\$1.60 to \$2.10 per m<sup>3</sup>), (2) seawater dual-purpose distillation and reverse osmosis with power recovery = \$4 to \$6 per 1,000 gal (\$1.00 to \$1.50 per m<sup>3</sup>), and (3) brackish water electro dialysis and reverse osmosis = \$1 to \$2 per 1,000 gal (\$0.25 to \$0.50 per m<sup>3</sup>).

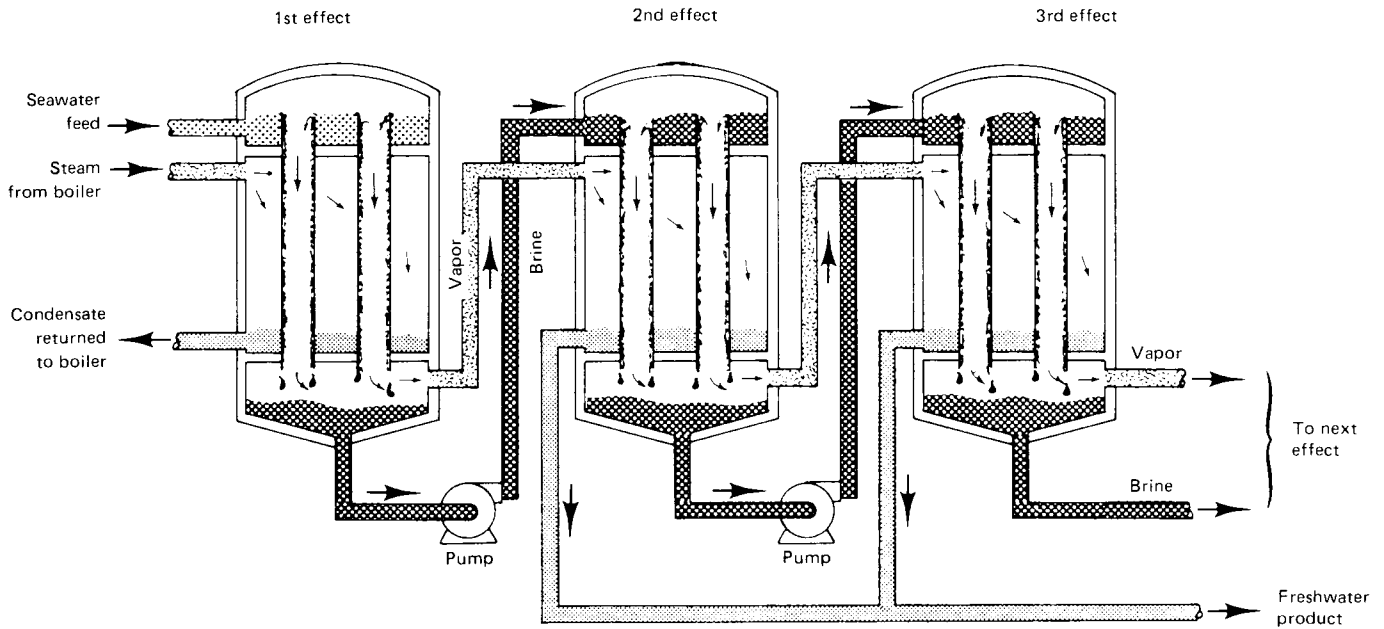

Fig. 6.10.4 Vertical tube evaporator (VTE). Multi-effect distillation process.

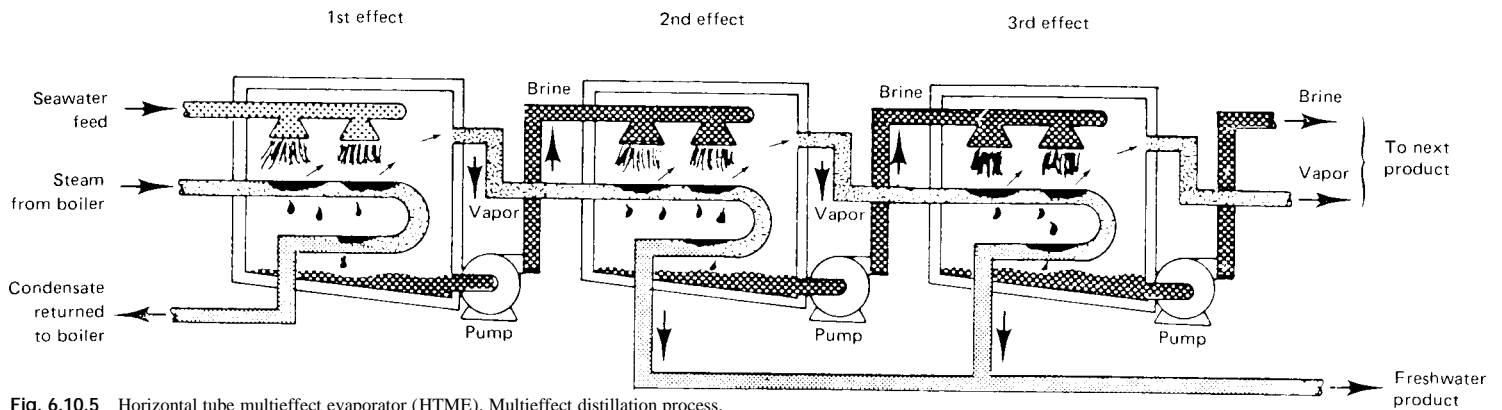

Fig. 6.10.5 Horizontal tube multi-effect evaporator (HTME). Multi-effect distillation process.

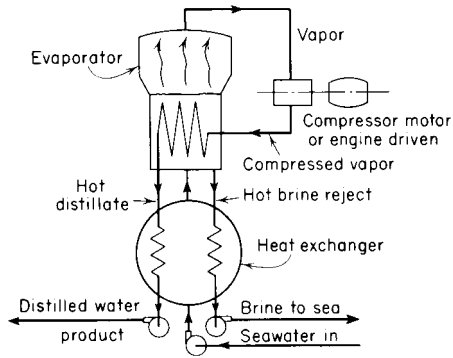

Fig. 6.10.6 Vapor compression distillation process.

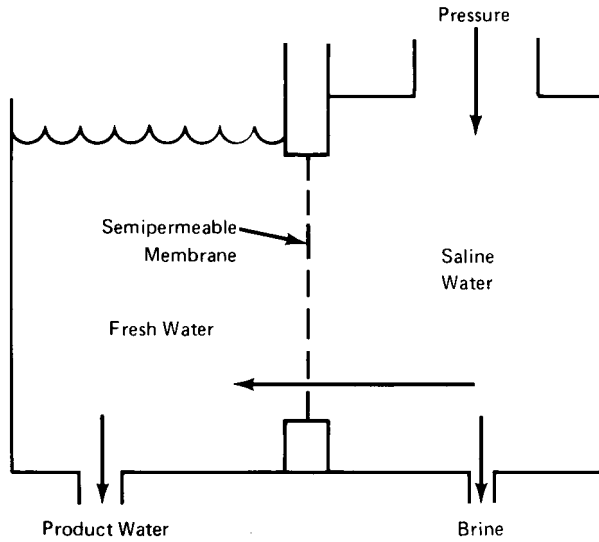

Fig. 6.10.7 Reverse-osmosis cell.

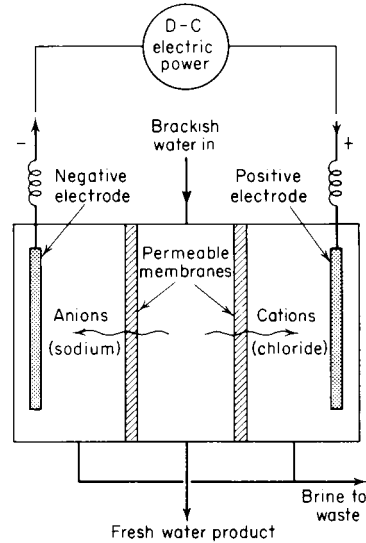

Fig. 6.10.9 Electrodesis single-compartment process.

Desalting process	Brackish water		Energy requirements
	Seawater	Brackish water	
Flash and multi-effect evaporation			
Single-purpose steam generator	X	X	[Energy requirement bar]
Dual-purpose SG small power plant	X	X	
Dual-purpose SG large utility	X	X	
Vapor compression			
All electric	X	X	[Energy requirement bar]
Diesel-electric	X	X	
Diesel and exhaust heat boiler	X	X	
Reverse osmosis			
Without power recovery	X	X	[Energy requirement bar]
With power recovery	X	X	
Without power recovery	X	X	
Electrodesis			
	X	X	[Energy requirement bar]
	X	X	
		MJ/m <sup>3</sup>	100 200 300 400 500
		MM Btu/1000 gal	0.5 1.0 1.5

Fig. 6.10.10 Desalting primary energy requirements (Ammerlaan, *Desalination*, 40, 1982, pp. 317-326.) Note: 1 metric ton (t) of oil = 43,800 MJ; 1 barrel (bbl) of oil = 6.2 TBtu; 1 kWh = 10.9 MJ = 10,220 Btu (large utility).

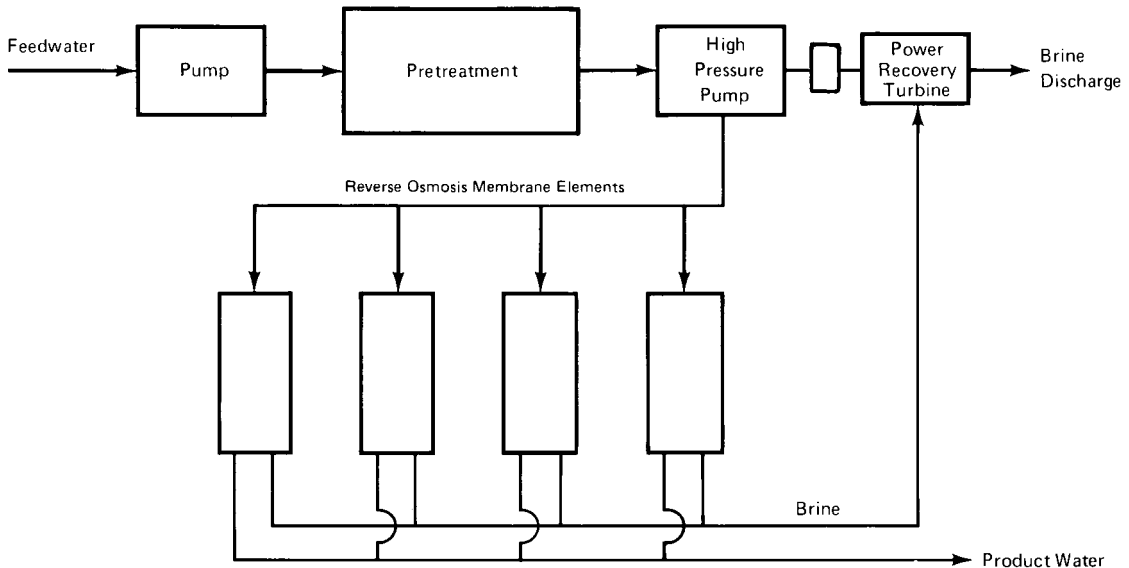

Fig. 6.10.8 Reverse-osmosis plant block flow diagram.



## 6.11 LUBRICANTS AND LUBRICATION

by Julian H. Dancy

(For general discussion of friction, viscosity, bearings, and coefficients of friction, see Secs. 3 and 8.)

REFERENCES: STLE, "Handbook of Lubrication," 3 vols., CRC Press. ASME, "Wear Control Handbook." ASM, "ASM Handbook," vol. 18, "Friction, Lubrication, and Wear Technology." ASTM, "Annual Book of ASTM Standards," 3 vols., "Petroleum Products and Lubricants." NLGI, "Lubricating Grease Guide." Fuller, "Theory and Practice of Lubrication for Engineers," Wiley. Shigley and Mischke, "Bearings and Lubrication: A Mechanical Designers' Workbook," McGraw-Hill. Stipina and Vesely, "Lubricants and Special Fluids," Elsevier. Miller, "Lubricants and Their Applications," McGraw-Hill. Shubkin (ed.), "Synthetic Lubricants and High Performance Functional Fluids," Marcel Dekker. Bartz (ed.), "Engine Oils and Automotive Lubrication," Dekker. Hamrock, "Fundamentals of Fluid Film Lubrication," McGraw-Hill. Neale, "Lubrication: A Tribology Handbook," Butterworth-Heinemann. Ramsey, "Elastohydrodynamics," Wiley. Arnell, "Tribology, Principles and Design Applications," Springer-Verlag. Czichos, "Tribology, A Systems Approach to . . . Friction, Lubrication and Wear," Elsevier. Bhushan and Gupta, "Handbook of Tribology: Materials, Coatings, and Surface Treatments," McGraw-Hill. Yamaguchi, "Tribology of Plastic Materials," Elsevier.

**Tribology**, a term introduced in the 1960s, is the science of rubbing surfaces and their interactions, including friction, wear, and lubrication phenomena. **Lubrication** primarily concerns modifying friction and reducing wear and damage at the surface contacts of solids rubbing against one another. Anything introduced between the surfaces to accomplish this is a **lubricant**.

### LUBRICANTS

Lubricants can be liquids, solids, or even gases, and they are most often oils or greases. Liquid lubricants often provide many functions in addition to controlling friction and wear, such as scavenging heat, dirt, and wear debris; preventing rust and corrosion; transferring force; and acting as a sealing medium.

Engineers are called upon to select and evaluate lubricants, to follow their performance in service, and to use them to best advantage in the design of equipment. Lubricant manufacturers and distributors may have hundreds of lubricants in their product line, each described separately in the product literature as to intended applications, properties, and benefits, as well as performance in selected standard tests. Lubricants are selected according to the needs of the particular application. Careful lubricant selection helps obtain improved performance, lower operating cost, and longer service life, for both the lubricant and the equipment involved. Industry's demands for efficient, competitive equipment and operations, which meet the latest environmental regulations, create continued demand for new and improved lubricants. Equipment manufacturers and suppliers specify lubricants that suit their particular equipment and its intended operating conditions, and their recommendations should be followed.

### LIQUID LUBRICANTS

A liquid lubricant consists of (1) a mixture of selected base oils and additives, (2) blended to a specific viscosity, with (3) the blend designed to meet the performance needs of a particular type of service. A lubricant may contain several base oils of different viscosities and types, blended to meet viscosity requirements and to help meet performance requirements, or to minimize cost. Additives may be used to help meet viscosity as well as various performance needs.

**Petroleum Oils** Lubricants made with petroleum base oils are widely used because of their general suitability to much of existing equipment and availability at moderate cost. Most petroleum base oils, often called **mineral oils**, are prepared by conventional refining processes

from naturally occurring hydrocarbons in crude oils. The main crude oil types are paraffinic- and naphthenic-based, terms referring to the type of chemical structure of most molecules. Paraffinic oils are most often preferred as lubricants, although naphthenic oils are important in certain applications. A few new types of petroleum base oils have become available, produced by more severe processing. These oils (hydrocracked oils and hydroisomerized wax oils) cost more, and availability is rather limited, but they have many improved properties, approaching those of more expensive synthetic oils. The improvements include better oxidation and thermal stability, lower volatility, higher viscosity index, and lower levels of sulfur, aromatics, and nitrogen compounds. Use of these oils is destined to grow as the trend toward higher-performance lubricants continues.

**Synthetic oils** are artificially made, as opposed to naturally occurring petroleum fluids. Synthetic oil types include polyalphaolefins (PAOs), diesters, polyol esters, alkylbenzenes, polyalkylene glycols, phosphate esters, silicones, and halogenated hydrocarbons. Synthetic oils include diverse types of chemical compounds, so few generalities apply to all synthetic oils. Generally, synthetic oils are organic chemicals. Synthetic oils cost much more than petroleum oils, and usually they have some lubricant-related properties that are good or excellent, but they are not necessarily strong in all properties. Their stronger properties often include greater high-temperature stability and oxidation resistance, wider temperature operating range, and improved energy efficiency. As with petroleum base oils, some of their weaknesses are correctable by additives. Some synthetic esters, such as polyol esters, have good biodegradability, a property of increasing need for environmental protection.

**Synthetic lubricants**, because of their high cost, often are used only where some particular property is essential. There are instances where the higher cost of synthetics is justified, even though petroleum lubricants perform reasonably well. This may occur, e.g., where use of synthetics reduces the oxidation rate in high-temperature service and as a result extends the oil life substantially. Properties of some synthetic lubricants are shown in Table 6.11.1, the assessments based on formulated lubricants, not necessarily the base oils. Synthetic oil uses include lubricants for gears, bearings, engines, hydraulic systems, greases, compressors, and refrigeration systems, although petroleum oils tend to dominate these applications. Lubricants blended with both petroleum and synthetic base oils are called **semisynthetic lubricants**.

**Vegetable oils** have very limited use as base stocks for lubricants, but are used in special applications. Naturally occurring esters, such as from rapeseed or castor plants, are used as the base oils in some hydraulic fluids, and are used where there are environmental concerns of possibility of an accidental fluid spill or leakage. These oils have a shorter life and lower maximum service temperature, but have a high degree of biodegradability.

**Fatty oils**, extracted from vegetable, animal, and fish sources, have excellent lubricity because of their glyceride structure, but are seldom used as base oils because they oxidize rapidly. A few percent of fatty oils are sometimes added to petroleum oils to improve lubricity (as in worm-gear applications), or to repel moisture (as in steam engines), and this use is often referred to as **compounding**. They also are used widely in forming soaps which, in combination with other oils, set up grease structures.

**Additives** are chemical compounds added to base oils to modify or enhance certain lubricant performance characteristics. The amount of additives used varies with the type of lubricant, from a few parts per million in some types of lubricants to over 20 percent in some engine oils. The types of additives used include antioxidants, antiwear agents, extreme-pressure agents, viscosity index improvers, dispersants, detergents, pour point depressants, friction modifiers, corrosion inhibitors.

Table 6.11.1 Relative Properties of Synthetic Lubricants\*

	Viscosity index	High-temperature stability	Lubricity	Low-temperature properties	Hydrolytic stability	Fire resistance	Volatility
Polyalphaolefins	Good	Good	Good	Good	Excellent	Poor	Good
Diesters	Varies	Excellent	Good	Excellent	Fair	Fair	Average
Polyol esters	Good	Excellent	Good	Good	Good	Poor	Average
Alkylbenzenes	Poor	Fair	Good	Good	Excellent	Poor	Average
Polyalkylene glycols	Excellent	Good	Good	Good	Good	Poor	Good
Phosphate esters	Poor	Excellent	Good	Varies	Fair	Excellent	Average
Silicones	Excellent	Excellent	Poor	Excellent	Fair	—	Good
Fluorinated lubes	Excellent	Excellent	Varies	Fair	Excellent	Excellent	Average

\* Comparisons made for typical formulated products with additive packages, not for the base oils alone.

SOURCE: Courtesy of *Texaco's magazine Lubrication*, 78, no. 4, 1992.

rust inhibitors, metal deactivators, tackiness agents, antifoamants, air-release agents, demulsifiers, emulsifiers, odor control agents, and biocides.

### LUBRICATION REGIMES

The viscosity of a lubricant and its additive content are to a large extent related to the lubrication regimes expected in its intended application. It is desirable, but not always possible, to design mechanisms in which the rubbing surfaces are totally separated by lubricant films. **Hydrostatic** lubrication concerns equipment designed such that the lubricant is supplied under sufficient pressure to separate the rubbing surfaces. **Hydrodynamic** lubrication is a more often used regime, and it occurs when the motion of one surface over lubricant on the other surface causes sufficient film pressure and thickness to build up to separate the surfaces. Achieving this requires certain design details, as well as operation within a specific range of speed, load, and lubricant viscosity. Increasing speed or viscosity increases the film thickness, and increasing load reduces film thickness. Plain journal bearings, widely used in automotive engines, operate in this regime. For concentrated nonconforming contacts, such as rolling-element bearings, cams, and certain type of gears, the surface shape and high local load squeeze the oil film toward surface contact. Under such conditions, **elastohydrodynamic** lubrication (EHL) may occur, where the high pressures in the film cause it to become very viscous and to elastically deform and separate the surfaces.

**Boundary lubrication** occurs when the load is carried almost entirely by the rubbing surfaces, separated by films of only molecular dimensions. **Mixed-film lubrication** occurs when the load is carried partly by the oil film and partly by contact between the surfaces' roughness peaks (asperities) rubbing one another. In mixed-film and boundary lubrication, lubricant viscosity becomes less important and chemical composition of the lubricant film more important. The films, although very thin, are needed to prevent surface damage. At loads up to a certain level, antiwear additives, the most common one being zinc dithiophosphate (ZDTP), are used in the oil to form films to help support the load and reduce wear. ZDTP films can have thicknesses from molecular to much larger dimensions. In very highly loaded contacts, such as hypoid gears, **extreme-pressure** (EP) additives are used to minimize wear and prevent scuffing. EP additives may contain sulfur, phosphorus, or chlorine, and they react with the high-temperature contact surfaces to form molecular-dimension films. Antiwear, EP, and friction modifier additives function only in the mixed and boundary regimes.

### LUBRICANT TESTING

Lubricants are manufactured to have specific characteristics, defined by physical and chemical properties, and performance characteristics. Most of the tests used by the lubricants industry are described in ASTM (American Society for Testing and Materials) Standard Methods. **Physical tests** are frequently used to characterize petroleum oils, since lubricant performance often depends upon or is related to physical properties. Common physical tests include measurements of viscosity, density,

pour point, API gravity, flash point, fire point, odor, and color. **Chemical tests** measure such things as the amount of certain elements or compounds in the additives, or the acidity of the oil, or the carbon residue after heating the oil at high temperature. **Performance tests** evaluate particular aspects of in-service behavior, such as oxidation stability, rust protection, ease of separation from water, resistance to foaming, and antiwear and extreme-pressure properties. Many of the tests used are small-size or bench tests, for practical reasons. To more closely simulate service conditions, full-scale standardized performance tests are required for certain types of lubricants, such as oils for gasoline and diesel engines. Beyond these industry standard tests, many equipment builders require tests in specific machines or in the field. The full scope of lubricant testing is rather complex, as simple physical and chemical tests are incapable of fully defining in-service behavior.

### VISCOSITY TESTS

**Viscosity** is perhaps the single most important property of a lubricant. Viscosity needs to be sufficient to maintain oil films thick enough to minimize friction and wear, but not so viscous as to cause excessive efficiency losses. Viscosity reduces as oil temperature increases. It increases at high pressure and, for some fluids, reduces from shear, during movement in small clearances.

**Kinematic viscosity** is the most common and fundamental viscosity measurement, and it is obtained by oil flow by gravity through capillary-type instruments at low-shear-rate flow conditions. It is measured by ASTM Standard Method D445. A large number of commercially available capillary designs are acceptable. Automated multiple-capillary machines also are sold. Kinematic viscosity is typically measured at 40 and 100°C and is expressed in centistokes, cSt (mm<sup>2</sup>/s).

**Saybolt viscosity**, with units of Saybolt universal seconds (SUS), was once widely used. There is no longer a standard method for direct measurement of SUS. Some industrial consumers continue to use SUS, and it can be determined from kinematic viscosity using ASTM D2161.

**Dynamic viscosity** is measured for some lubricants at low temperatures (ASTM D4684, D5293, and D2983); it is expressed in centipoise cP (mPa · s). Kinematic and dynamic viscosities are related by the equation  $cSt = cP/\text{density}$ , where density is in g/cm<sup>3</sup>.

**Viscosity grades**, not specific viscosities, are used to identify viscosities of lubricants in the marketplace, each viscosity grade step in a viscosity grade system having minimum and maximum viscosity limits. There are different viscosity grade systems for automotive engine oils, gear oils, and industrial oils. Grade numbers in any one system are independent of grade numbers in other systems.

**ISO Viscosity Grades** The International Standards Organization (ISO) has a viscosity grade system (ASTM D2422) for industrial oils. Each grade is identified by ISO VG followed by a number representing the nominal 40°C (104°F) kinematic viscosity in centistokes for that grade. This system contains 18 viscosity grades, covering the range from 2 to 1,500 cSt at 40°C, each grade being about 50 percent higher in viscosity than the previous one. The other viscosity grade systems are described later.

The **variation of viscosity with temperature** for petroleum oils can be determined from the viscosities at any two temperatures, such as 40 and 100°C kinematic viscosity, using a graphical method or calculation (ASTM D341). The method is accurate only for temperatures above the wax point and below the initial boiling point, and for oils not containing certain polymeric additives.

The **viscosity index (VI)** is an empirical system expressing an oil's rate of change in viscosity with change in temperature. The system, developed some years ago, originally had a 0 to 100 VI scale, based on two oils thought to have the maximum and minimum limits of viscosity-temperature sensitivity. Subsequent experience identified oils far outside the VI scale in both directions. The VI system is still used, and the VI of an oil can be calculated from its 40 and 100°C kinematic viscosity using ASTM D2270, or by easy-to-use tables (ASTM Data Series, DS 39B). Lubricants with high VI have less change in viscosity with temperature change, desirable for a lubricant in service where temperatures vary widely.

Base oils with more than 100 VI can be made from a wide variety of crude oil distillates by solvent refining, by hydrogenation, by selective blending of paraffinic base oils, by adding a few percent of high-molecular-weight polymeric additives called **viscosity index improvers**, or by combinations of these methods. A few highly processed petroleum base oils and many synthetic oils have high VIs.

**Effect of Pressure on Viscosity** When lubricating oils are subjected to high pressures, thousands of lb/in<sup>2</sup>, their viscosity increases. When oil-film pressures are in this order of magnitude, their influence on viscosity becomes significant. Empirical equations are available to estimate the effect of pressure on viscosity. In rolling-contact bearings, gears, and other machine elements, the high film pressures will influence viscosity with an accompanying increase in frictional forces and load-carrying capacity.

**Effect of Shear on Viscosity** The viscosity of lubricating oils not containing polymeric additives is independent of **shear rate**, except at low temperatures where wax is present. Where polymeric additives are used, as in multigrade engine oils, high shear rates in lubricated machine elements cause **temporary viscosity loss**, as the large polymer molecules temporarily align in the direction of flow. Engine oils consider this effect by high-temperature/high-shear-rate measurements (ASTM D4683 or ASTM D4741). Such oils can suffer **permanent viscosity loss** in service, as polymer molecules are split by shear stresses into smaller molecules with less thickening power. The amount of the permanent viscosity loss depends on the type of polymeric additive used, and it is measurable by comparing the viscosity of the new oil to that of the used oil, although other factors need considering, such as any oxidative thickening of the oils.

## OTHER PHYSICAL AND CHEMICAL TESTS

**Cloud Point** Petroleum oils, when cooled, may become plastic solids, either from wax formation or from the fluid congealing. With some oils, the initial wax crystal formation becomes visible at temperatures slightly above the solidification point. When that temperature is reached at specific test conditions, it is known as the **cloud point** (ASTM D2500). The cloud point cannot be determined for those oils in which wax does not separate prior to solidification or in which the separation is invisible.

The cloud point indicates the temperature below which clogging of filters may be expected in service. Also, it identifies a temperature below which viscosity cannot be predicted by ASTM D2270, as the wax causes a higher viscosity than is predicted.

**Pour point** is the temperature at which cooled oil will just flow under specific test conditions (ASTM D97). The pour point indicates the lowest temperature at which a lubricant can readily flow from its container. It provides only a rough guide to its flow in machines. Pour point depressant additives are often used to reduce the pour point, but they do not affect the cloud point. Other tests, described later, are used to more accurately estimate oil flow properties at low temperatures in automotive service.

**Density and Gravity** ASTM D1298 may be used for determining density (mass), specific gravity, and the API (American Petroleum Institute) gravity of lubricating oils. Of these three, petroleum lubricants tend to be described by using API gravity. The specific gravity of an oil is the ratio of its weight to that of an equal volume of water, both measured at 60°F (16°C), and the API gravity of an oil can be calculated by

$$\text{API gravity, deg} = (141.5/\text{sp. gr. @ } 60^\circ/60^\circ\text{F}) - 131.5$$

The gravity of lubricating oils is of no value in predicting their performance. Low-viscosity oils have higher API gravities than higher-viscosity oils of the same crude-oil series. Paraffinic oils have the lowest densities or highest API gravities, naphthenic are intermediate, and animal and vegetable oils have the heaviest densities or lowest API gravities.

**Flash and Fire Points** The flash point of an oil is the temperature to which an oil has to be heated until sufficient flammable vapor is driven off to flash when brought into momentary contact with a flame. The fire point is the temperature at which the oil vapors will continue to burn when ignited. ASTM D92, which uses the Cleveland open-cup (COC) tester, is the flash and fire point method used for lubricating oils. In general, for petroleum lubricants, the open flash point is 30°F or (17°C) higher than the closed flash (ASTM D93), and the fire point is some 50 to 70°F or (28 to 39°C) above the open flash point.

Flash and fire points may vary with the nature of the original crude oil, the narrowness of the distillation cut, the viscosity, and the method of refining. For the same viscosities and degree of refinement, paraffinic oils have higher flash and fire points than naphthenic oils. While these values give some indication of fire hazard, they should be taken as only one element in fire risk assessment.

**Color** The color of a lubricating oil is obtained by reference to transmitted light; the color by reflected light is referred to as **blom**. The color of an oil is not a measure of oil quality, but indicates the uniformity of a particular grade or brand. The color of an oil normally will darken with use. ASTM D1500 is for visual determination of the color of lubricating oils, heating oils, diesel fuels, and petroleum waxes, using a standardized colorimeter. Results are reported in terms of the ASTM color scale and can be compared with the former ASTM union color. The color scale ranges from 0.5 to 8; oils darker than color 8 may be diluted with kerosene by a prescribed method and then observed. Very often oils are simply described by visual assessment of color: brown, black, etc. For determining the color of petroleum products lighter than 0.5, the ASTM D156 Test for Saybolt Color of Petroleum Products can be used.

**Carbon residue**, the material left after heating an oil under specified conditions at high temperature, is useful as a quality control tool in the refining of viscous oils, particularly residual oils. It does not correlate with carbon-forming tendencies of oils in internal-combustion engines. Determination is most often made by the Conradson procedure (ASTM D189). Values obtained by the more complex Ramsbottom procedure (ASTM D524) are sometimes quoted. The correlation of the two values is given in both methods.

**Ash** Although it is unlikely that well-refined oils that do not contain metallic additives will yield any appreciable ash from impurities or contaminants, measurement can be made by ASTM D482. A more useful determination is **sulfated ash** by ASTM D874, as applied to lubricants containing metallic additives.

**Neutralization number** and **total acid number** are interchangeable terms indicating a measure of acidic components in oils, as determined by ASTM D664 or D974. The original intent was to indicate the degree of refining in new oils, and to follow the development of oxidation in service, with its effects on deposit formation and corrosion. However, many modern oils contain additives which, in these tests, act similar to undesirable acids and are indistinguishable from them. Caution must be exercised in interpreting results without knowledge of additive behavior. Change in acid number is more significant than the absolute value in assessing the condition of an oil in service. Oxidation of an oil is usually accompanied by an increase in acid number.

**Total base number (TBN)** is a measure of alkaline components in oils, especially those additives used in engine oils to neutralize acids formed during fuel combustion. Some of these acids get in the crankcase with gases that blow by the rings. Today, TBN is generally measured by ASTM D2896 or D4739, as it provides a better indication of an oil's ability to protect engines from corrosive wear than ASTM D664, which was previously used for TBN measurement.

**Antifoam** The foaming characteristic of crankcase, turbine, or circulating oils is checked by a foaming test apparatus (ASTM D892), which blows air through a diffuser in the oil. The test measures the amount of foam generated and the rate of settling. Certain additive oils tend to foam excessively in service. Many types of lubricants contain a minute quantity of antifoam inhibitor to prevent excessive foaming in service. At this writing, a new high-temperature foam test is under development in ASTM for passenger-car engine oil use, and a Navistar engine test is used to test for diesel-engine-oil aeration.

**Oxidation Tests** Lubricating oils may operate at relatively high temperatures in the presence of air and catalytically active metals or metallic compounds. Oxidation becomes significant when oil is operated above 150°F (66°C). Some lubricating-oil sump temperatures may exceed 250°F (121°C). The oxidation rate doubles for about every 18°F (10°C) rise in oil temperature above 150°F (66°C). The resultant oil oxidation increases viscosity, acids, sludge, and lacquer.

To accelerate oxidation to obtain practical test length, oxidation tests generally use temperatures above normal service, large amounts of catalytic metals, and sufficient oxygen. Two standard oxidation tests, ASTM D943 and D2272, are often applied to steam turbine and similar industrial oils. There are many other standard oxidation tests for other specific lubricants. Because test conditions are somewhat removed from those encountered in service, care should be exercised in extrapolating results to expected performance in service.

**Rust Prevention** Lubricating oils are often expected to protect ferrous surfaces from rusting when modest amounts of water enter the lubricating system. Many oils contain additives specifically designed for that purpose. Steam turbine and similar industrial oils often are evaluated for rust prevention by ASTM D665 and D3603. Where more protection is required, as when a thin oil film must protect against a moisture-laden atmosphere, ASTM D1748 is a useful method.

**Water Separation** In many applications, it is desirable for the oil to have good water-separating properties, to enable water removal before excessive amounts accumulate and lead to rust and lubrication problems. The demulsibility of an oil can be measured by ASTM D1401 for light- to moderate-viscosity oils and by ASTM D2711 for heavier-viscosity oils.

**Wear and EP Tests** A variety of test equipment and methods have been developed for evaluating the wear protection and EP properties (**load-carrying capacity before scuffing**) of lubricant fluids and greases under different types of heavy-duty conditions. The tests are simplified, accelerated tests, and correlations to service conditions are seldom available, but they are important in comparing different manufacturers' products and are sometimes used in lubricant specifications. Each apparatus tends to emphasize a particular characteristic, and a given lubricant will not necessarily show the same EP properties when tested on different machines. ASTM methods D2783 (fluids) and D2509 (grease) use the **Timken EP tester** to characterize the EP properties of industrial-type gear lubricants, in tests with incremented load steps. ASTM D3233 (fluids) uses the **Falex pin and vee block tester** for evaluating the EP properties of oils and gear lubricants, using either continuous (method A) or incremented (method B) load increase during the test. Evaluation of wear-prevention properties also can be conducted using this apparatus, by maintaining constant load. ASTM methods D2783 (fluids) and D2596 (grease) use the **four-ball EP tester** for evaluating the EP properties of oils and greases. ASTM methods D4172 (fluids) and D2266 (grease) use the **four-ball wear tester** to evaluate the wear-prevention properties of oils and grease.

## GREASES

**Lubricating greases** consist of lubricating liquid dispersed in a thickening agent. The lubricating liquid is about 70 to 95 wt % of the finished

grease and provides the principal lubrication, while the thickener holds the oil in place. Additives are often added to the grease to impart special properties. Grease helps seal the lubricating fluid in and the contaminants out. Grease also can help reduce lubrication frequency, particularly in intermittent operation.

The lubricating liquid is usually a naphthenic or paraffinic petroleum oil or a mixture of the two. Synthetic oils are used also, but because of their higher cost, they tend to be used only for specialty greases, such as greases for very low or high temperature use. Synthetic oils used in greases include polyalphaolefins, dialkylbenzenes, dibasic acid esters, polyalkylene glycols, silicones, and fluorinated hydrocarbons. The viscosity of the lubricating liquid in the grease should be the same as would be selected if the lubricant were an oil.

**Soaps** are the most common thickeners used in greases. Complex soaps, pigments, modified clays, chemicals (such as polyurea), and polymers are also used, alone or in combination. Soaps are formed by reaction of fatty material with strong alkalis, such as calcium hydroxide. In this saponification reaction, water, alcohol, and/or glycerin may be formed as by-products. Soaps of weak alkalis, such as aluminum, are formed indirectly through further reactions. Metallic soaps, such as sodium, calcium, and lithium, are the most widely used thickeners today.

Additives may be incorporated in the grease to provide or enhance tackiness, to provide load-carrying capability, to improve resistance to oxidation and rusting, to provide antiwear or EP properties, and to lessen sensitivity to water. The additives sometimes are solid lubricants such as graphite, molybdenum disulfide, metallic powders, or polymers, which grease can suspend better than oil. Solid fillers may be used to improve grease performance under extremely high loads or shock loads.

The **consistency** or **firmness** is the characteristic which may cause grease to be chosen over oil in some applications. Consistency is determined by the depth to which a cone penetrates a grease sample under specific conditions of weight, time, and temperature. In ASTM D217, a standardized cone is allowed to drop into the grease for 5 s at 77°F (25°C). The resulting depth of fall, or **penetration**, is measured in tenths of millimeters. If the test is made on a sample simply transferred to a standard container, the results are called **unworked penetration**. To obtain a more uniform sample, before the penetration test, the grease is worked for 60 strokes in a mechanical worker, a churnlike device. Variations on unworked and worked penetrations, such as prolonged working, undisturbed penetration, or block penetration, also are described in ASTM D217. The worked 60-stroke penetration is the most widely used indication of grease consistency. The National Lubricating Grease Institute (NLGI) used this penetration method to establish a system of **consistency numbers** to classify differences in grease consistency or firmness. The consistency numbers range from 000 to 6, each representing a range of 30 penetration units, and with a 15 penetration unit gap between each grade, as shown in Table 6.11.2.

As grease is heated, it may change gradually from a semisolid to a liquid state, or its structure may weaken until a significant amount of oil is lost. Grease does not exhibit a true melting point, which implies a sharp change in state. The weakening or softening behavior of grease when heated to a specific temperature can be defined in a carefully controlled heating program with well-defined conditions. This test gives a temperature called the **dropping point**, described in ASTM D566 or

**Table 6.11.2 Grease Consistency Ranges**

Consistency no.	Appearance	Worked penetration
000	Semifluid	445–475
00	Semifluid	400–430
0	Semifluid	355–385
1	Soft	310–340
2	Medium	265–295
3	Medium hard	220–250
4	Hard	175–205
5	Very hard	130–160
6	Block type	85–115

D2265. Typical dropping points are given in Table 6.11.3. At its **dropping point**, a grease already has become fluid, so the maximum application temperature must be well below the dropping point shown in the table.

The oil constituent of a grease is loosely held. This is necessary for some lubrication requirements, such as those of ball bearings. As a result, on opening a container of grease, free oil is often seen. The tendency of a grease to **bleed** oil may be measured by ASTM D1742. Test results are related to bleeding in storage, not in service or at elevated temperatures.

**Texture** of a grease is determined by formulation and processing. Typical textures are shown in Table 6.11.3. They are useful in identification of some products, but are of only limited assistance for predicting behavior in service. In general, smooth, buttery, short-fiber greases are preferred for rolling-contact bearings and stringy, fibrous products for sliding service. Stringiness or tackiness imparted by polymeric additives helps control leakage, but this property may be diminished or eliminated by the shearing action encountered in service.

Grease **performance** depends only moderately on physical test characteristics, such as penetration and dropping point. The likelihood of suitable performance may be indicated by these and other tests. However, the final determination of how a lubricating grease will perform in service should be based on observations made in actual service.

## SOLID LUBRICANTS

**Solid lubricants** are materials with low coefficients of friction compared to metals, and they are used to reduce friction and wear in a variety of applications. There are a large number of such materials, and they include graphite, molybdenum disulfide, polytetrafluoroethylene, talc, graphite fluoride, polymers, and certain metal salts. The many diverse types have a variety of different properties, operating ranges, and methods of application. The need for lubricants to operate at extremes of temperature and environment beyond the range of organic fluids, such as in the space programs, helped foster development of solid lubricants.

One method of using solid lubricants is to apply them as thin films on the bearing materials. The film thicknesses used range from 0.0002 to 0.0005 in (0.005 to 0.013 mm). There are many ways to form the films. Surface preparation is very important in all of them. The simplest method is to apply them as **unbonded solid lubricants**, where granular or powdered lubricant is applied by brushing, dipping, or spraying, or in a liquid or gas carrier for ease of application. Burnishing the surfaces is beneficial. The solid lubricant adheres to the surface to some degree by mechanical or molecular action. More durable films can be made by using **bonded solid lubricants**, where the lubricant powders are mixed with binders before being applied to the surface. Organic binders, if used, can be either room-temperature air-cured type or those requiring thermal setting. The latter tend to be more durable. Air-cured films are generally limited to operating temperatures below 300°F (260°C), while some thermoset films may be satisfactory to 700°F (371°C). Inorganic ceramic adhesives combined with certain powdered metallic solid lubricants permit film use at temperatures in excess of 1,200°F (649°C). The performance of solid-lubricant films is influenced by the solid lu-

bricant used, the method of application, the bearing-surface-material finish and its hardness, the binder-solid lubricant mix, the film and surface pretreatment, and the application's operating conditions. Solid-lubricant films can be evaluated in certain standard tests, including ASTM D2510 (adhesion), D2511 (thermal shock sensitivity), D2625 (wear endurance and load capacity), D2649 (corrosion characteristics), and D2981 (wear life by oscillating motion).

Many plastics are also solid lubricants compared to the friction coefficients typical of metals. Plastics are used without lubrication in many applications. Strong plastics can be compounded with a variety of solid lubricants to make plastics having both strength and low friction. Solid-lubricant powders and plastics can be mixed, compacted, and sintered to form a lubricating solid, such as for a bearing. Such materials also can be made by combining solid-lubricant fibers with other stronger plastic fibers, either woven together or chopped, and used in compression-molded plastics. Bushings made of low-friction plastic materials may be press-fitted into metal sleeves. The varieties of low-friction plastic materials are too numerous to mention. Bearings made with solid low-friction plastic materials are commercially available.

Solid lubricants may also be embedded in metal matrices to form solid-lubricant composites of various desirable properties. Graphite is the most common solid lubricant used, and others include molybdenum disulfide and other metal-dichalcogenides. The base metals used include copper, aluminum, magnesium, cadmium, and others. These materials are made by a variety of processes, and their uses range from electrical contacts to bearings in heavy equipment.

## LUBRICATION SYSTEMS

There are many positive methods of applying lubricating oils and greases to ensure proper lubrication. Bath and circulating systems are common. There are constant-level lubricators, gravity-feed oilers, multiple-sight feeds, grease cups, forced-feed lubricators, centralized lubrication systems, and air-mist lubricators, to name a few. Selecting the method of lubricant application is as important as the lubricant itself. The choice of the device and the complexity of the system depend upon many factors, including the type and quantity of the lubricant, reliability and value of the machine elements, maintenance schedules, accessibility of the lubrication points, labor costs, and other economic considerations, as well as the operating conditions.

The importance of removing foreign particles from circulating oil has been increasingly recognized as a means to minimize wear and avoid formation of potentially harmful deposits. Adequate **filtration** must be provided to accomplish this. In critical systems involving closely fitting parts, monitoring of particles on a regular basis may be undertaken.

## LUBRICATION OF SPECIFIC EQUIPMENT

**Internal-combustion-engine oils** are required to carry out numerous functions to provide adequate lubrication. Crankcase oils, in addition to reducing friction and wear, must keep the engine clean and free from rust and corrosion, must act as a coolant and sealant, and must serve as a hydraulic oil in engines with hydraulic valve lifters. The lubricant may

Table 6.11.3 General Characteristics of Greases

Base	Texture	Typical dropping point, °F (°C)	Max usable temperature,* °F (°C)	Water resistance	Primary uses
Sodium	Fibrous	325–350 (163–177)	200 (93)	P–F	Older, slower bearings with no water
Calcium	Smooth	260–290 (127–143)	200 (93)	E	Moderate temperature, water present
Lithium	Smooth	380–395 (193–202)	250 (121)	G	General bearing lubrication
12-hydroxystearate					
Polyurea	Smooth	450+ (232+)	350 (177)	G–E	Sealed-for-life bearings Used at high temperatures, with frequent relubrication
Calcium complex	Smooth	500+ (260+)	350 (177)	F–E	
Lithium complex	Smooth	450+ (232+)	325 (163)	G–E	
Aluminum complex	Smooth	500+ (260+)	350 (177)	G–E	
Organoclay	Smooth	500+ (260+)	250 (121)	F–E	

\* Continuous operation with relatively infrequent lubrication.

function over a wide temperature range and in the presence of atmospheric dirt and water, as well as with combustion products that blow by the rings into the crankcase. It must be resistant to oxidation, sludge, and varnish formation in a wide range of service conditions.

Engine oils are heavily fortified with additives, such as **detergents**, to prevent or reduce deposits and corrosion by neutralizing combustion by-product acids; **dispersants**, to help keep the engine clean by solubilizing and dispersing sludge, soot, and deposit precursors; **oxidation inhibitors**, to minimize oil oxidation, particularly at high temperatures; **corrosion inhibitors**, to prevent attack on sensitive bearing metals; **rust inhibitors**, to prevent attack on iron and steel surfaces by condensed moisture and acidic corrosion products, aggravated by low-temperature stop-and-go operation; **pour point depressants**, to prevent wax gelation and improve low-temperature flow properties; **viscosity-index improvers**, to help enable adequate low-temperature flow, along with sufficient viscosity at high temperatures; **antiwear** additives, to minimize wear under boundary lubrication conditions, such as cam and lifter, and cylinder-wall and piston-ring surfaces; **defoamants**, to allow air to break away easily from the oil; and **friction modifiers**, to improve fuel efficiency by reducing friction at rubbing surfaces.

The SAE viscosity grade system for engine oils (SAE J300), shown in Table 6.11.4 provides W (winter) viscosity grade steps (for example, 5W) for oils meeting certain primarily low-temperature viscosity limits, and non-W grade steps (for example, 30) for oils meeting high-temperature viscosity limits. The system covers both single-grade oils (for example, SAE 30), not designed for winter use, and multigrade oils (for example, SAE 5W-30), formulated for year-round service. This system is subject to revision as improvements are made, and the table shows the December 1995 version. Each W grade step has maximum low-temperature viscosity limits for cranking (D5293) and pumping (D4684) bench tests, and a minimum 100°C kinematic viscosity limit. The lower the W grade, the colder the potential service use. Pumping viscosity limits are based on temperatures 10°C below those used for cranking limits, to provide a safety margin so that an oil that will allow engine starting at some low temperature also will pump adequately at that temperature. Each non-W grade step has a specific 100°C kinematic viscosity range and a minimum 150°C high-shear-rate viscosity limit. High-temperature high-shear-rate viscosity limits are a recent addition to J300, added in recognition that critical lubrication in an engine occurs largely at these conditions. Two 150°C high-shear-rate viscosity limits are shown for 40 grade oils, each for a specific set of W grades, the limit being higher for viscosity grades used in heavy-duty diesel engine service.

**Gasoline Engines** Two systems are used at this time to define gaso-

line-engine-oil performance levels, not counting systems outside the United States. The API service category system has been used for many years and is the result of joint efforts of many organizations. Since 1970, gasoline engine performance categories in this system have used the letter S (spark ignition) followed by a second letter indicating the specific performance level. Performance category requirements are based primarily on performance in various standard engine tests. The categories available change periodically as higher performance categories are needed for newer engines, and as older categories become obsolete when tests on which they are based are no longer available. At this writing, SH is the highest performance level in this system.

The newer ILSAC system is based primarily on the same tests, but has a few additional requirements. This system was developed by the International Lubricant Standardization and Approval Committee (ILSAC), a joint organization of primarily U.S. and Japanese automobile and engine manufacturers. The first category is in use, ILSAC GF-1.

There are similarities as well as distinct differences between the two systems. Both are displayed on oil containers using API licensed marks. The API service category system uses the API service symbol, and ILSAC system uses the API certification mark, both shown in Fig. 6.11.1. Either or both marks can be displayed on an oil container. In the API service symbol, the performance level (for example, SH), viscosity grade (for example, SAE 5W-30), and energy-conserving level (for example, energy-conserving II) are shown. None of these are shown in the API certification mark of the ILSAC system. The API certification mark remains unchanged as new performance levels are developed and regardless of the viscosity grade of the oil in the container. ILSAC categories require the highest energy-conserving level, and only allow a few viscosity grades, those recommended for newer engines. The vis-

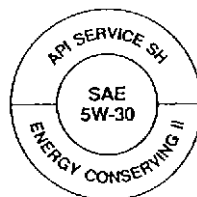

API Service Symbol



API Certification Mark

Fig. 6.11.1 API marks for engine oil containers. (From API Publication 1509, 12th ed., 1993. Reprinted by courtesy of the American Petroleum Institute.)

Table 6.11.4 SAE Viscosity Grades for Engine Oil<sup>a</sup> (SAE J300 DEC95)

SAE viscosity grade	Low temperature viscosity, cP, max, at temp, °C, max		Viscosity, <sup>d</sup> cSt, at 100°C		High-shear-rate viscosity, <sup>e</sup> cP, min, at 150°C and 10 <sup>6</sup> s <sup>-1</sup>
	Cranking <sup>b</sup>	Pumping <sup>c</sup>	Min	Max	
0W	3,250 at -30	60,000 at -40	3.8	—	—
5W	3,500 at -25	60,000 at -35	3.8	—	—
10W	3,500 at -20	60,000 at -30	4.1	—	—
15W	3,500 at -15	60,000 at -25	5.6	—	—
20W	4,500 at -10	60,000 at -20	5.6	—	—
25W	6,000 at -5	60,000 at -15	9.3	—	—
20	—	—	5.6	< 9.3	2.6
30	—	—	9.3	< 12.5	2.9
40	—	—	12.5	< 16.3	2.9 <sup>f</sup>
40	—	—	12.5	< 16.3	3.7 <sup>g</sup>
50	—	—	16.3	< 21.9	3.7
60	—	—	21.9	< 26.1	3.7

<sup>a</sup> All values are critical specifications as defined in ASTM D3244.

<sup>b</sup> ASTM D5293.

<sup>c</sup> ASTM D4684. Note that the presence of any yield stress detectable by this method constitutes a failure, regardless of viscosity.

<sup>d</sup> ASTM D445 Note: 1 cP = 1 mPa · s 1 cSt = 1 mm<sup>2</sup>/s

<sup>e</sup> ASTM D4683, CEC L-36-A-90 (ASTM D4741)

<sup>f</sup> 0W-40, 5W-40, and 10W-40 grade oils.

<sup>g</sup> 15W-40, 20W-40, 25W-40, and 40 grade oils.

cosity grades allowed are SAE 0W-20, 5W-20, 5W-30, and 10W-30. The viscosity grade may be displayed separately. In the ILSAC system, to ensure high-performance-level oils, the API certification mark is licensed annually and only for oils meeting the latest ILSAC performance level.

**Diesel Engines** API performance-level categories for commercial heavy-duty diesel engine oils, using the API service category system, begin with the letter C (compression ignition), followed by additional letters and numbers indicating the performance level and engine type, the performance letter changing as category improvements are needed. At this writing, CG-4 is the highest performance category for four-cycle low-sulfur-fueled turbocharged heavy-duty diesel engines, and CF-2 is the highest for two-cycle turbocharged heavy-duty diesel engines. ILSAC intends to develop a new performance category system for heavy-duty diesel engine oils and to use a different design API mark for this system. Viscosity grades used depend on engine manufacturer's recommendations for the ambient temperature range. SAE 15W-40 oils are very popular for most four-cycle diesel engines, and single-grade oils, such as SAE 40, are used primarily in hotter climates and for two-cycle diesel engines.

The engine oil is increasingly becoming a major part in the total design, affecting performance of critical components as well as engine life. Emission control restrictions are tightening up on diesel engines, and this is affecting the engine oils. Designs of pistons are changing, and rings are being located higher on the pistons and are more subject to carbon deposits. Deposits are being controlled partly by use of proper engine oils. One new engine design with reduced emissions uses the engine oil as hydraulic fluid to operate and improve control of the fuel injectors, and this has created a need for improved oil deaeration performance. Most engine manufacturers maintain lists of oils that perform well in their engines.

Larger diesel engines found in marine, railroad, and stationary service use crankcase oils that are not standardized as to performance levels, unlike the oils discussed above. They are products developed by reputable oil suppliers working with major engine builders. In general, they are formulated along the same lines as their automotive counterparts. However, particularly in marine service where fuels often contain relatively high levels of sulfur, the detergent additive may be formulated with a high degree of alkalinity to neutralize sulfuric acid resulting from combustion.

**Gas engines** pose somewhat different lubrication requirements. They burn a clean fuel which gives rise to little soot, but conditions of operation are such that nitrogen oxides formed during combustion can have a detrimental effect on the oil. Suitable lubricants may contain less additive than those which must operate in a sootier environment. However, the quality of the base oil itself assumes greater importance. Special selection of crude source and a high degree of refining must be observed to obtain good performance. The most common viscosity is SAE 40, although SAE 30 is also used. Where cold starting is a factor, SAE 15W-40 oils are available.

**Steam Turbines** Although they do not impose especially severe lubrication requirements, steam turbines are expected to run for very long periods, often measured in many years, on the same oil charge. Beyond that, the oil must be able to cope with ingress of substantial amounts of water. Satisfactory products consist of highly refined base oils with rust and oxidation (R&O) inhibitors, and they must show good water-separating properties (demulsifiability). There is demand for longer-life turbine oil in the power generation industry, such as 6,000 h or more of life in the ASTM D943 oxidation bench test. This demand is being met by using more severely processed base oils and with improved R&O inhibitors. Most large utility turbines operate with oil viscosity ISO VG 32. Where gearing is involved, ISO VG 100 is preferred. Smaller industrial turbines, which do not have circulating systems typical of large units, may operate with ISO VG 68. Circulating systems should be designed with removal of water in mind, whether by centrifuge, coalescer, settling tank, or a combination of these methods. Where the turbine governor hydraulic system is separate from the central lubrication system, fire-resistant phosphate ester fluids are often used in the governor hydraulic system.

**Gas turbines** in industrial service are lubricated with oils similar to the ISO VG 32 product recommended for steam turbines; but to obtain acceptable service life under higher-temperature conditions, they may be inhibited against oxidation to a greater extent. There is demand for longer-life oils for gas turbines, and, as for steam turbines, the demand is being met by using more severely processed base oils and improved R&O inhibitors. Gas turbines aboard aircraft operate at still higher bearing temperatures which are beyond the capability of petroleum oils. Synthetic organic esters are used, generally complying with military specifications.

**Gears** API System of Lubricant Service Designations for Automotive Manual Transmissions and Axles (SAE J308B) defines service levels for automotive gear oils. The service levels include API GL-1 to GL-6 and API PL-1 to PL-2, related to gear types and service conditions. Also, there are SAE Viscosity Grades for Axle and Transmission Lubricants (SAE J306C) for gear oils in automotive service. In this system, there are winter grades from SAE 70W to 85W, based on low-temperature viscosity (ASTM D2983) limits and 100°C kinematic viscosity (ASTM D445) limits, and grades from SAE 90 to 250, based on 100°C kinematic viscosity limits. Many multigrade oils are marketed based on it, capable of year-round operation.

The American Gear Manufacturers Association (AGMA) has classification systems for industrial gear lubricants, defined in AGMA 250.04 and 251.02. These systems specify lubricant performance grades by AGMA lubricant numbers, each grade linked to a specific ISO viscosity grade. There are three systems for enclosed gear drives, and they cover (1) rust- and oxidation-inhibited, (2) extreme pressure, and (3) compounded lubricants. Three systems for open gear drives cover (1) rust- and oxidation-inhibited, (2) extreme pressure, and (3) residual lubricants.

The various gear types in use differ in severity of lubrication requirements. For spur, bevel, helical, and herringbone gears, elastohydrodynamic lubrication occurs at rated speeds and loads. Oils used for these types of gears need not contain additives that contribute to oil film strength, but may contain antioxidants, rust inhibitors, defoamants, etc., depending on the application. Worm gears need oils with film strength additives, such as compounded lubricants (containing fatty oils in a petroleum base), and use oils of relatively high viscosity, such as ISO VG 460. Other gear types, such as spur, use oils of widely varying viscosities, from ISO VG 46 to 460 or higher. The choice relates to operating conditions, as well as any need to lubricate other mechanisms with the same oil. Hypoid gears, widely used in automobiles, need oils containing effective EP additives. There is increased use of synthetic gear oils where wide operating temperature ranges and need for long life are involved. For example, polyalkylene glycol gear oils, which have high viscosity indices and excellent load capacities, are being used in industrial applications involving heavily loaded or high-temperature worm gears. Synthetic gear oils based on PAO base stocks have performed well in closed gearbox applications. With open gears, the lubricant often is applied sporadically and must adhere to the gear for some time, resisting being scraped off by meshing teeth. Greases, and viscous asphaltic-base lubricants, often containing EP additives, are among the gear lubricants used in this service. Asphaltic products may be diluted with a solvent to ease application, the solvent evaporating relatively quickly from the gear teeth.

**Rolling-Contact Bearings** These include ball bearings of various configurations, as well as roller bearings of the cylindrical, spherical, and tapered varieties and needle bearings. They may range in size from a few millimetres to several metres. They are basically designed to carry load under EHL conditions, but considerable sliding motion may exist as well as rolling motion at points of contact between rolling elements and raceways. In addition, sliding occurs between rolling elements and separators and, in roller bearings, between the ends of rollers and raceway flanges. In many instances, it is desirable to incorporate antiwear additives to deal with these conditions.

A choice can frequently be made between oil and grease. Where the lubricant must carry heat away from the bearings, oil is the obvious selection, especially where large quantities can be readily circulated. Also, where contamination by water and solids is difficult to avoid, oil

is preferred, provided an adequate purification system is furnished. If circulation is not practical, then grease may be the better choice. Where access to bearings is limited, grease may be indicated. Grease is also preferred in instances where leakage of lubricant might be a problem.

Suitable oils generally contain rust and oxidation inhibitors, and antiwear additives. Viscosity is selected on the basis of EHL considerations or builder recommendations for the particular equipment, and it may range anywhere from ISO VG 32 to 460, typically perhaps ISO VG 68.

Where grease is employed, the selection of type will be governed by operating conditions including temperature, loading, possibility of water contamination, and frequency and method of application. Lithium 12-hydroxystearate grease, particularly of no. 2 consistency grade, is widely used. Where equipment is lubricated for life at the time of manufacture, such as electric motors in household appliances, polyurea greases are often selected.

**Air Compressors** **Reciprocating** compressors require lubrication of the cylinder walls, packing, and bearings. Temperatures at the cylinder wall are fairly high, and sufficient viscosity must be provided. Oils of ISO VG from about 68 to 460 may be specified. Since water condensation may be encountered, rust inhibitor is needed in addition to oxidation inhibitor. A principal operating problem concerning the lubricant is development of carbonaceous deposits on the valves and in the piping. This can seriously interfere with valve operation and can lead to disastrous fires and explosions. It is essential to choose an oil with a minimum tendency to form such deposits. Conradson and Ramsbottom carbon residue tests are of little value in predicting this behavior, and builders and reputable oil suppliers should be consulted. Maintenance procedures need to ensure that any deposits are cleaned on a regular basis and not be allowed to accumulate. In units which call for all-loss lubrication to the cylinders, feed rates should be reduced to the minimum recommended levels to minimize deposit-forming tendencies. Increasingly, certain synthetic oils, such as fully formulated diesters, polyalkylene glycols, and PAOs, are being recommended for longer, trouble-free operation.

**Screw compressors** present a unique lubrication problem in that large quantities of oil are sprayed into the air during compression. Exposure of large surfaces of oil droplets to hot air is an ideal environment for oxidation to occur. This can cause lacquer deposition to interfere with oil separator operation which is essential to good performance. Although general-purpose rust- and oxidation-inhibited oils, as well as crankcase oils, are often used, they are not the best choice. Specially formulated petroleum oils, in ISO VG 32 to 68, are available for these severe conditions. For enhanced service life, synthetic organic ester fluids of comparable viscosity are often used.

**Refrigeration compressors** vary in their lubricant requirements depending on the refrigerant gas involved, particularly as some lubricant may be carried downstream of the compressor into the refrigeration system. If any wax from the lubricant deposits on evaporator surfaces, performance is seriously impaired. Ammonia systems can function with petroleum oils, even though ammonia is only poorly miscible with such oils. Many lubricants of ISO VG 15 to 100 are suitable, provided that the pour point is somewhat below evaporator temperature and that it does not contain additives that react with ammonia. Miscibility of refrigerant and lubricant is important to lubrication of some other types of systems. Chlorinated refrigerants (CFCs and HCFCs) are miscible with oil, and highly refined, low-pour, wax-free naphthenic oils of ISO VG 32 to 68 are often used, or certain wax-free synthetic lubricants. CFC refrigerants, which deplete the ozone layer, will cease being produced after 1995. Chlorine-free hydrofluorocarbon (HFC) refrigerants are now widely used, as they are non-ozone-depleting. HFCs are largely immiscible in petroleum-based lubricants, but partial miscibility of refrigerant and lubricant is necessary for adequate lubrication in these systems. Synthetic lubricants based on polyol ester or polyalkylene glycol base oils have miscibility with HFCs and are being used in HFC air conditioning and refrigeration systems.

**Hydraulic Systems** Critical lubricated parts include pumps, motors, and valves. When operated at rated load, certain pumps and motors are very sensitive to the lubricating quality of the hydraulic fluid. When the

fluid is inadequate in this respect, premature wear occurs, leading to erratic operation of the hydraulic system. For indoor use, it is best to select specially formulated antiwear hydraulic oils. These contain rust and oxidation inhibitors as well as antiwear additives, and they provide good overall performance in ISO VG 32 to 68 for many applications. Newer hydraulic systems have higher operating temperatures and pressures and longer drain intervals. These systems require oils with improved oxidation stability and antiwear protection. Fluids with good filterability are being demanded to allow use of fine filters to protect the critical clearances of the system. Hydraulic fluids may contain VI improver and/or pour point depressant for use in low-temperature outside service, and antifoamants and demulsifiers for rapid release of entrained air and water. Hydraulic equipment on mobile systems has greater access to automotive crankcase oils and automatic transmission fluids and manufacturers may recommend use of these oils in their equipment. Where biodegradability is of concern, fluids made of vegetable oil (rapeseed) are available.

**Systems Needing Fire-Resistant Fluids** Where accidental rupture of an oil line may cause fluid to splash on a surface above about 600°F (310°C), a degree of fire resistance above that of petroleum oil is desirable. Four classes of fluids, generally used in hydraulic systems operating in such an environment, are available. **Phosphate esters** offer the advantages of a good lubricant requiring little attention in service, but they require special seals and paints and are quite expensive. **Water-glycol** fluids contain some 40 to 50 percent water, in a uniform solution of diethylene glycol, or glycol and polyglycol, to achieve acceptable fire resistance. They require monitoring in service to ensure proper content of water and rust inhibitor. **Invert emulsions** contain 40 to 50 percent water dispersed in petroleum oil. With oil as the outside phase of the emulsion, lubrication properties are fairly good, but the fluid must be monitored to maintain water content and to ensure that the water remains adequately dispersed. Finally, there are **conventional emulsions** which contain 5 to 10 percent petroleum oil dispersed in water. With the water as the outside phase, the fluid is a rather poor lubricant, and equipment requiring lubrication must be designed and selected to operate with these emulsions. Steps must also be taken to ensure that problems such as rusting, spoilage, and microbial growth are controlled.

Note that *fire-resistant* is a relative term, and it does not mean non-flammable. Approvals of the requisite degree of fire resistance are issued by Factory Mutual Insurance Company and by the U.S. Bureau of Mines where underground mining operations are involved.

**Metal Forming** The functions of fluids in machining operation are (1) to cool and (2) to lubricate. Fluids remove the heat generated by the chip/tool rubbing contact and/or the heat resulting from the plastic deformation of the work. Cooling aids tool life, preserves tool hardness, and helps to maintain the dimensions of the machined parts. Fluids lubricate the chip/tool interface to reduce tool wear, frictional heat, and power consumption. Lubricants aid in the reduction of metal welding and adhesion to improve surface finish. The fluids may also serve to carry away chips and debris from the work as well as to protect machined surfaces, tools, and equipment from rust and corrosion.

Many types of fluids are used. Most frequently they are (1) mineral oils, (2) soluble oil emulsions, or (3) chemicals or synthetics. These are often compounded with additives to impart specific properties. Some metalworking operations are conducted in a controlled gaseous atmosphere (air, nitrogen, carbon dioxide).

The choice of a **metalworking fluid** is very complicated. Factors to be considered are (1) the metal to be machined, (2) the tools, and (3) the type of operation. Tools are usually steel, carbide, or ceramic. In operations where chips are formed, the relative motion between the tool and chip is high-speed under high load and often at elevated temperature. In chipless metal forming—drawing, rolling, stamping, extruding, spinning—the function of the fluid is to (1) lubricate and cool the die and work material and (2) reduce adhesion and welding on dies. In addition to fluids, solids such as talc, clay, and soft metals may be used in drawing operations.

In addition to the primary function to lubricate and cool, the cutting fluids should not (1) corrode, discolor, or form deposits on the work;



(2) produce undesirable fumes, smoke, or odors; (3) have detrimental physical effects on operators. Fluids should also be stable, resist bacterial growth, and be foam-resistant.

In the machining operations, many combinations of tools, workpieces, and operating conditions may be encountered. In some instances, straight mineral oils or oils with small amounts of additives will suffice, while in more severe conditions, highly compounded oils are required. The effectiveness of the additives depends upon their chemical activity with newly formed, highly reactive surfaces; these combined with the high temperatures and pressures at the contact points are ideal for chemical reactions. Additives include fatty oils, sulfur, sulfurized fatty oils, and sulfurized, chlorinated, and phosphorus additives. These agents react with the metals to form compounds which have a lower shear strength and may possess EP properties. Oils containing additives, either dark or transparent, are most widely used in the industry.

Oils with sulfur- and chlorine-based additives raise some issues of increasing concern, as the more active sulfurized types stain copper and the chlorinated types have environmental concerns and are not suitable for titanium. New cutting oils have been developed which perform well and avoid these concerns.

Water is probably the most effective coolant available but can seldom be used as an effective cutting fluid. It has little value as a lubricant and will promote rusting. One way of combining the cooling properties of water with the lubricating properties of oil is through the use of soluble oils. These oils are compounded so they form a stable emulsion with water. The main component, water, provides effective cooling while the oil and compounds impart desirable lubricating, EP, and corrosion-resistance properties.

The ratio of water to oil will influence the relative lubrication and cooling properties of the emulsion. For these nonmiscible liquids to form a stable emulsion, an emulsifier must be added. Water hardness is an important consideration in the forming of an emulsion, and protection against bacterial growth should be provided. Care in preparing and handling the emulsion will ensure more satisfactory performance and longer life. Overheating, freezing, water evaporation, contamination, and excessive air mixing will adversely affect the emulsion. When one is discarding the used emulsion, it is often necessary to "break" the emulsion into its oil and water components for proper disposal.

Newer-technology soluble oils, using nonionic emulsifiers instead of anionic emulsifiers, have improved properties over earlier-technology oils, and have less tendency to form insoluble soaps with hard water, which results in fewer filter changes, less machine downtime, and lower maintenance costs. They also have longer emulsion life, from greater bacterial and fungal resistance.

Water-soluble chemicals, and synthetics, are essentially solutions or microdispersions of a number of ingredients in water. These materials are used for the same purposes described above for mineral and soluble oils. Water-soluble synthetic fluids are seeing increased use and have greater bioresistance than soluble oils and provide longer coolant life and lower maintenance.

**Health Considerations** Increased attention is being focused on hazards associated with manufacture, handling, and use of all types of industrial and consumer materials, and lubricants are no exception. Much progress has been made in removing substances suspected of creating adverse effects on health. Suppliers can provide information on general composition and potential hazards requiring special handling of their products, in the form of Material Safety Data Sheets (MSDSs). It is seldom necessary to go further to ascertain health risks. It is necessary that personnel working with lubricants observe basic hygienic practices. They should avoid wearing oil-soaked clothing, minimize unnecessary exposure of skin, and wash exposed skin frequently with approved soaps.

**Used-Lubricant Disposal** The nonpolluting disposal of used lubricants is becoming increasingly important and requires continual attention. More and more legislation and control are being enacted, at local, state, and national levels, to regulate the disposal of wastes. Alternative methods of handling specific used lubricants may be recommended, such as in situ purification and refortifying the oil and returning it to service, often in mobile units provided by the lubricant distributor. Also, waste lubricating oils may be reprocessed into base oils for re-refined lubricant manufacture. The use of waste lubricating oils as fuels is being increasingly regulated because of air pollution dangers. If wastes are dumped on the ground or directly into sewers, they may eventually be washed into streams and water supplies and become water pollutants. They may also interfere with proper operation of sewage plants. Improper burning may contribute to air pollution. Wastes must be handled in such a way as to ensure nonpolluting disposal. Reputable lubricant suppliers are helpful in suggesting general disposal methods, although they cannot be expected to be knowledgeable about all local regulations.

**Lubricant management programs** are being used increasingly by industry to minimize operating cost, including lubricant, labor, and waste disposal costs. These programs can be managed by lubricant user/supplier teams. Fluid management programs include the following activities: lubrication selection; lubricant monitoring during service; reclamation and refortification; and disposal. The supplier and/or lubricant service firms often have the major role in performing the last three activities. These programs can be beneficial to both lubricant user and supplier.

## 6.12 PLASTICS

(Staff Contribution)

REFERENCES: Billmyer, "Textbook of Polymer Science," 3d ed. Brydson, "Plastics Materials," 4th ed. Birley, Heath, and Scott, "Plastics Materials: Properties and Applications." Current publications of and sponsored by the Society of the Plastics Industry (SPI) and similar plastics industry organizations. Manufacturers' specifications, data, and testing reports. "Modern Plastics Encyclopedia," McGraw-Hill.

### GENERAL OVERVIEW OF PLASTICS

**Plastics** are ubiquitous engineering materials which are wholly or in part composed of long, chainlike molecules called **high polymers**. While carbon is the element common to all commercial high polymers, hydrogen, oxygen, nitrogen, sulfur, halogens, and silicon can be present in varying

proportions. High polymers may be divided into two classes: **thermoplastic** and **thermosetting**. The former reversibly melt to become highly viscous liquids and solidify upon cooling (Fig. 6.12.1). The resultant solids will be elastic, ductile, tough, or brittle, depending on the structure of the solid as evolved from the molten state. Thermosetting polymers are infusible without thermal or mechanical degradation. Thermosetting polymers (often termed **thermosets**) cure by a chain-linking chemical reaction usually initiated at elevated temperature and pressure, although there are types which cure at room temperature through the use of catalysts. The more highly cured the polymer, the higher its heat distortion temperature and the harder and more brittle it becomes.

As a class, plastics possess a combination of physical and mechanical properties which are attractive to the designer. There are certain proper-

Table 6.12.1 Properties of Plastic Resins and Compounds

Materials	Properties	ASTM test method	ABS <sup>a</sup>						
			Extrusion grade	ABS/Nylon	Injection molding grades (Continued)				
					Heat-resistant	Medium-impact	High-impact	Platable grade	20% glass fiber-reinforced
Processing	1a. Melt flow, g/10 min	D1238	0.85–1.0		1.1–1.8	1.1–1.8	1.1–1.8	1.1	
	1. Melting temperature, °C. <i>T<sub>m</sub></i> (crystalline)								
	<i>T<sub>g</sub></i> (amorphous)		88–120		110–125	102–115	91–110	100–110	100–110
	2. Processing temperature range, °F. (C = compression; T = transfer; I = injection; E = extrusion)		E: 350–500	I: 460–520	C: 325–500 I: 475–550	C: 325–350 I: 390–525	C: 325–350 I: 380–525	C: 325–400 I: 350–500	C: 350–500 I: 350–500
	3. Molding pressure range, 10 <sup>3</sup> lb/in <sup>2</sup>			8–25	8–25	8–25	8–25	8–25	15–30
4. Compression ratio		2.5–2.7	1.1–2.0	1.1–2.0	1.1–2.0	1.1–2.0	1.1–2.0		
5. Mold (linear) shrinkage, in/in	D955	0.004–0.007	0.003–0.010	0.004–0.009	0.004–0.009	0.004–0.009	0.005–0.008	0.001–0.002	
Mechanical	6. Tensile strength at break, lb/in <sup>2</sup>	D638 <sup>b</sup>	2,500–8,000	4,000–6,000	4,800–7,500	5,500–7,500	4,400–6,300	5,200–6,400	10,500–13,000
	7. Elongation at break, %	D638 <sup>b</sup>	20–100	40–300	3–45	5–60	5–75		2–3
	8. Tensile yield strength, lb/in <sup>2</sup>	D638 <sup>b</sup>	4,300–6,400	4,300–6,300	4,300–7,000	5,000–7,200	2,600–5,900	6,700	
	9. Compressive strength (rupture or yield), lb/in <sup>2</sup>	D695	5,200–10,000		7,200–10,000	1,800–12,500	4,500–8,000		13,000–14,000
	10. Flexural strength (rupture or yield), lb/in <sup>2</sup>	D790	4,000–14,000	8,800–10,900	9,000–13,000	7,100–13,000	5,400–11,000	10,500–11,500	14,000–17,500
	11. Tensile modulus, 10 <sup>3</sup> lb/in <sup>2</sup>	D638 <sup>b</sup>	130–420	260–320	285–360	300–400	150–350	320–380	740–880
	12. Compressive modulus, 10 <sup>3</sup> lb/in <sup>2</sup>	D695	150–390		190–440	200–450	140–300		800
	13. Flexural modulus, 10 <sup>3</sup> lb/in <sup>2</sup>	D790	130–440	250–310	300–400	310–400	179–375	340–390	650–800
		73°F	D790						
		200°F	D790						
		250°F	D790						
		300°F	D790						
	14. Izod impact, ft · lb/in of notch (1/8-in-thick specimen)	D256A	1.5–12	15–20	2.0–6.5	3.0–6.0	6.0–9.3	4.0–8.3	1.1–1.4
15. Hardness									
	Rockwell	D785	R75–115	R93–105	R100–115	R102–115	R85–106	R103–109	M85–98, R107
	Shore/Barcol	D2240/ D2583							
Thermal	16. Coef. of linear thermal expansion, 10 <sup>6</sup> in/(in · °C)	D696	60–130	90–110	60–93	80–100	95–110	47–53	20–21
	17. Deflection temperature under flexural load, °F								
		264 lb/in <sup>2</sup>	D648	170–220	130–150	220–240 annealed 181–193 <sup>c</sup>	200–220 annealed	205–215 annealed	190–222 annealed
	66 lb/in <sup>2</sup>	D648	170–235	180–195	230–245 annealed	215–225 annealed	210–225 annealed	215–222 annealed	220–230
18. Thermal conductivity, 10 <sup>-4</sup> cal · cm/(s · cm <sup>2</sup> · °C)	C177			4.5–8.0				4.8	
Physical	19. Specific gravity	D792	1.02–1.08	1.06–1.07	1.05–1.08	1.03–1.06	1.01–1.05	1.04–1.07	1.18–1.22
	20. Water absorption (1/8-in-thick specimen), %								
		24 h	D570	0.20–0.45		0.20–0.45	0.20–0.45	0.20–0.45	0.18–0.20
	Saturation	D570							
21. Dielectric strength (1/8-in-thick specimen), short time, V/mil	D149	350–500		350–500	350–500	350–500	420–550	450–460	

SOURCE: Abstracted from "Modern Plastics Encyclopedia," 1995.

NOTE: Footnotes <sup>a</sup> to <sup>f</sup> are at end of table.

Acetal						
Homopolymer	Copolymer	Extrusion and blow molding grade (terpolymer)	20% Glass-reinforced homopolymer	25% Glass-coupled copolymer	2-20% PTFE-filled copolymer	Chemically lubricated homopolymer
1-20	1-90	1.0	6.0			6
172-184	160-175	160-170	175-181	160-180	160-175	175
I: 380-470	C: 340-400 I: 360-450	E: 360-400	I: 350-480	I: 365-480	I: 350-445 I: 325-500 E: 360-500	I: 400-440
10-20	8-20		10-20	8-20	8-20	
3.0-4.5	3.0-4.5	3.0-4.0		3.0-4.5	3.0-4.5	
0.018-0.025	0.020 (Avg.)	0.02	0.009-0.012	0.004 (flow) 0.018 (trans.)	0.018-0.029	
9,700-10,000			8,500-9,000	16,000-18,500	8,300	9,500
10-75	15-75	67	6-12	2-3	30	40
9,500-12,000	8,300-10,400	8,700	7,500-8,250	16,000	8,300	9,500
15,600-18,000 @ 10%	16,000 @ 10%	16,000	18,000 @ 10%	17,000 @ 10%	11,000-12,600	
13,600-16,000	13,000	12,800	10,700-16,000	18,000-28,000	11,500	13,000
400-520	377-464		900-1,000	1,250-1,400	250-280	450
670	450					
380-490	370-450	350	600-730	1,100	310-360	400
120-135			300-360			130
75-90			250-270			80
1.1-2.3	0.8-1.5	1.7	0.5-1.0	1.0-1.8	0.5-1.0	1.4
M92-94, R120	M75-90	M84	M90	M79-90, R110	M79	M90
50-112	61-110		33-81	17-44	52-68	
253-277	185-250	205	315	320-325	198-225	257
324-342	311-330	318	345	327-331	280-325	329
5.5	5.5				4.7	
1.42	1.40	1.41	1.54-1.56	1.58-1.61	1.40	1.42
0.25-1	0.20-0.22	0.22	0.25	0.22-0.29	0.15-0.26	0.27
0.90-1	0.65-0.80	0.8	1.0	0.8-1.0	0.5	1.00
400-500 (90 mil)	500 (90 mil)		490 (125 mil)	480-580	400-410	400 (125 mils)

Table 6.12.1 Properties of Plastic Resins and Compounds (Continued)

Materials	Properties	ASTM test method	Acrylic				Acrylonitrile		
			Sheet	Molding and extrusion compounds			Molding and extrusion	Injection	
				Cast	PMMA	Impact-modified			Heat-resistant
Processing	1a. Melt flow, g/10 min	D1238		1.4–27	1–11	1.6–8.0		12	
	1. Melting temperature, °C. $T_m$ (crystalline)						135		
	$T_g$ (amorphous)		90–105	85–105	80–103	100–165	95		
	2. Processing temperature range, °F. (C = compression; T = transfer; I = injection; E = extrusion)			C: 300–425 I: 325–500 E: 360–500	C: 300–400 I: 400–500 E: 380–480	C: 350–500 I: 400–625 E: 360–550	C: 320–345 I: 410 E: 350–410	380–420	
	3. Molding pressure range, 10 <sup>3</sup> lb/in <sup>2</sup>			5–20	5–20	5–30	20	20	
	4. Compression ratio			1.6–3.0		1.2–2.0	2	2–2.5	
Mechanical	5. Mold (linear) shrinkage, in/in	D955	1.7	0.001–0.004 (flow) 0.002–0.008 (trans.)	0.002–0.008	0.002–0.008	0.002–0.005	0.002–0.005	
	6. Tensile strength at break, lb/in <sup>2</sup>	D638 <sup>b</sup>	66–11,000	7,000–10,500	5,000–9,000	9,300–11,500	9,000		
	7. Elongation at break, %	D638 <sup>b</sup>	2–7	2–5.5	4.6–70	2–10	3–4	3–4	
	8. Tensile yield strength, lb/in <sup>2</sup>	D638 <sup>b</sup>		7,800–10,600	5,500–8,470	10,000	7,500	9,500	
	9. Compressive strength (rupture or yield), lb/in <sup>2</sup>	D695	11,000–19,000	10,500–18,000	4,000–14,000	15,000–17,000	12,000	12,000	
	10. Flexural strength (rupture or yield), lb/in <sup>2</sup>	D790	12,000–17,000	10,500–19,000	7,000–14,000	12,000–18,000	14,000	14,000	
	11. Tensile modulus, 10 <sup>3</sup> lb/in <sup>2</sup>	D638 <sup>b</sup>	450–3,100	325–470	200–500	350–650	510–580	500–550	
	12. Compressive modulus, 10 <sup>3</sup> lb/in <sup>2</sup>	D695	390–475	370–460	240–370	450			
	13. Flexural modulus, 10 <sup>3</sup> lb/in <sup>2</sup>	D790	390–3,210	325–460	200–430	450–620	500–590	480	
	73°F								
	200°F								
	250°F								
	300°F	D790				150–440			
		D790				350–420			
		D790							
14. Izod impact, ft · lb/in of notch (½-in-thick specimen)	D256A	0.3–0.4	0.2–0.4	0.40–2.5	0.2–0.4	2.5–6.5	2.5		
15. Hardness Rockwell	D785	M80–102	M68–105	M35–78	M94–100	M72–78	M60		
Shore/Barcol	D2240/ D2583								
Thermal	16. Coef. of linear thermal expansion, 10 <sup>6</sup> in/(in · °C)	D696	50–90	50–90	48–80	40–71	66	66	
	17. Deflection temperature under flexural load, °F	D648	98–215	155–212	165–209	190–310	164	151	
	264 lb/in <sup>2</sup>								
	66 lb/in <sup>2</sup>	D648	165–235	165–225	180–205	200–315	172	166	
18. Thermal conductivity, 10 <sup>-4</sup> cal · cm/(s · cm <sup>2</sup> · °C)	C177	4.0–6.0	4.0–6.0	4.0–5.0	2.0–4.5	6.2	6.1		
Physical	19. Specific gravity	D792	1.17–1.20	1.17–1.20	1.11–1.18	1.16–1.22	1.15	1.15	
	20. Water absorption (½-in-thick specimen), %	D570	0.2–0.4	0.1–0.4	0.19–0.8	0.2–0.3	0.28		
	24 h								
Saturation	D570								
21. Dielectric strength (½-in-thick specimen), short time, V/mil	D149	450–550	400–500	380–500	400–500	220–240	220–240		

Cellulosic				Epoxy				
Ethyl cellulose molding compound and sheet	Cellulose acetate		Cellulose acetate butyrate	Bisphenol molding compounds		Casting resins and compounds		
	Sheet	Molding compound	Molding compound	Glass fiber-reinforced	Mineral-filled	Unfilled	Aluminum-filled	Flexibilized
135	230	230	140	Thermoset	Thermoset	Thermoset	Thermoset	Thermoset
C: 250–390 I: 350–500		C: 260–420 I: 335–490	C: 265–390 I: 335–480	C: 300–330 T: 280–380	C: 250–330 T: 250–380			
8–32		8–32	8–32	1–5	0.1–3			
1.8–2.4		1.8–2.6	1.8–2.4	3.0–7.0	2.0–3.0			
0.005–0.009		0.003–0.010	0.003–0.009	0.001–0.008	0.002–0.010	0.001–0.010	0.001–0.005	0.001–0.010
2,000–8,000	4,500–8,000	1,900–9,000	2,600–6,900	5,000–20,000	4,000–10,800	4,000–13,000	7,000–12,000	2,000–10,000
5–40	20–50	6–70	40–88	4		3–6	0.5–3	20–85
		2,500–6,300						
		3,000–8,000	2,100–7,500	18,000–40,000	18,000–40,000	15,000–25,000	15,000–33,000	1,000–14,000
4,000–12,000	6,000–10,000	2,000–16,000	1,800–9,300	8,000–30,000	6,000–18,000	13,000–21,000	8,500–24,000	1,000–13,000
			50–200	3,000	350	350		
					650			1–350
		1,200–4,000	90–300	2,000–4,500	1,400–2,000			
0.4	2.0–8.5	1.0–7.8	1.0–10.9	0.3–10.0	0.3–0.5	0.2–1.0	0.4–1.6	2.3–5.0
R50–115	R85–120	R17–125	R31–116	M100–112	M100–M112	M80–110	M55–85	
								Shore D65–89
100–200	100–150	80–180	110–170	11–50	20–60	45–65	5.5	20–100
115–190		111–195	113–202	225–500	225–500	115–550	190–600	73–250
		120–209	130–227					
3.8–7.0	4–8	4–8	4–8	4.0–10.0	4–35	4.5	15–25	
1.09–1.17	1.28–1.32	1.22–1.34	1.15–1.22	1.6–2.0	1.6–2.1	1.11–1.40	1.4–1.8	0.96–1.35
0.8–1.8	2.0–7.0	1.7–6.5	0.9–2.2	0.04–0.20	0.03–0.20	0.08–0.15	0.1–4.0	0.27–0.5
350–500	250–600	250–600	250–400	250–400	250–420	300–500		235–400

Table 6.12.1 Properties of Plastic Resins and Compounds (Continued)

Materials	Properties	ASTM test method	Fluoroplastics						
			Polychlorotrifluoroethylene	Polytetrafluoroethylene		Polyvinylidene fluoride		Modified PE-TFE	
				Granular	25% Glass fiber-reinforced	Molding and extrusion	EMI shielding (conductive); 30% PAN carbon fiber		25% Glass fiber-reinforced
Processing	1a. Melt flow, g/10 min	D1238							
	1. Melting temperature, °C. $T_m$ (crystalline)			327	327	141–178		270	
	$T_g$ (amorphous)		220			– 60 to – 20			
	2. Processing temperature range, °F. (C = compression; T = transfer; I = injection; E = extrusion)		C: 460–580 I: 500–600 E: 360–590			C: 360–550 I: 375–550 E: 375–550	I: 430–500	C: 575–625 I: 570–650	
	3. Molding pressure range, 10 <sup>3</sup> lb/in <sup>2</sup>		1–6	2–5	3–8	2–5		2–20	
4. Compression ratio		2.6	2.5–4.5		3				
5. Mold (linear) shrinkage, in/in	D955	0.010–0.015	0.030–0.060	0.018–0.020	0.020–0.035	0.001	0.002–0.030		
Mechanical	6. Tensile strength at break, lb/in <sup>2</sup>	D638 <sup>b</sup>	4,500–6,000	3,000–5,000	2,000–2,700	3,500–7,250	14,000	12,000	
	7. Elongation at break, %	D638 <sup>b</sup>	80–250	200–400	200–300	12–600	0.8	8	
	8. Tensile yield strength, lb/in <sup>2</sup>	D638 <sup>b</sup>	5,300			2,900–8,250			
	9. Compressive strength (rupture or yield), lb/in <sup>2</sup>	D695	4,600–7,400	1,700	1,000–1,400 @ 1% strain	8,000–16,000		10,000	
	10. Flexural strength (rupture or yield), lb/in <sup>2</sup>	D790	7,400–11,000		2,000	9,700–13,650	19,800	10,700	
	11. Tensile modulus, 10 <sup>3</sup> lb/in <sup>2</sup>	D638 <sup>b</sup>		58–80	200–240	200–80,000	2,800	1,200	
	12. Compressive modulus, 10 <sup>3</sup> lb/in <sup>2</sup>	D695	150–300	60		304–420			
	13. Flexural modulus, 10 <sup>3</sup> lb/in <sup>2</sup>	73°F	D790	170–200	80	190–235	170–120,000	2,100	950
		200°F	D790	180–260					450
		250°F	D790						310
		300°F	D790						200
	14. Izod impact, ft · lb/in of notch (½-in-thick specimen)	D256A	2.5–5	3	2.7	2.5–80	1.5	9.0	
	15. Hardness	Rockwell	D785	R75–112			R79–83, 85		R74
		Shore/Barcol	D2240/ D2583	Shore D75–80	Shore D50–65	Shore D60–70	Shore D80, 82 65–70		
	Thermal	16. Coef. of linear thermal expansion, 10 <sup>6</sup> in/(in · °C)	D696	36–70	70–120	77–100	70–142		10–32
17. Deflection temperature under flexural load, °F		264 lb/in <sup>2</sup>	D648		115		183–244	318	410
		66 lb/in <sup>2</sup>	D648	258	160–250		280–284		510
18. Thermal conductivity, 10 <sup>-4</sup> cal · cm/(s · cm <sup>2</sup> · °C)		C177	4.7–5.3	6.0	8–10	2.4–3.1			
Physical	19. Specific gravity	D792	2.08–2.2	2.14–2.20	2.2–2.3	1.77–1.78	1.74	1.8	
	20. Water absorption (½-in-thick specimen), %	24 h	D570	0	< 0.01		0.03–0.06	0.12	0.02
		Saturation	D570						
21. Dielectric strength (½-in-thick specimen), short time, V/mil	D149	500–600	480	320	260–280		425		

Furan	Phenolic				
	Molding compounds, phenol-formaldehyde				Casting resins
	Wood flour-filled	High-strength glass fiber-reinforced	Impact-modified		
Fabric- and rag-filled			Cellulose-filled	Unfilled	
Asbestos-filled			0.5-10		
Thermoset	Thermoset	Thermoset	Thermoset	Thermoset	Thermoset
C: 275-300	C: 290-380 I: 330-400	C: 300-380 I: 330-390 T: 300-350	C: 290-380 I: 330-400 T: 300-350	C: 290-380 I: 330-400	
0.1-0.5	2-20	1-20	2-20	2-20	
	1.0-1.5	2.0-10.0	1.0-1.5	1.0-1.5	
	0.004-0.009	0.001-0.004	0.003-0.009	0.004-0.009	
3,000-4,500	5,000-9,000	7,000-18,000	6,000-8,000	3,500-6,500	5,000-9,000
	0.4-0.8	0.2	1-4	1-2	1.5-2.0
10,000-13,000	25,000-31,000	16,000-70,000	20,000-28,000	22,000-31,000	12,000-15,000
600-9,000	7,000-14,000	12,000-60,000	10,000-14,000	5,500-11,000	11,000-17,000
1,580	800-1,700	1,900-3,300	900-1,100		400-700
		2,740-3,500			
	1,000-1,200	1,150-3,300	700-1,300	900-1,300	
	0.2-0.6	0.5-18.0	0.8-3.5	0.4-1.1	0.24-0.4
R110	M100-115	E54-101	M105-115	M95-115	M93-120
		Barcol 72			
	30-45	8-34	18-24	20-31	68
	300-370	350-600	325-400	300-350	165-175
	4-8	8-14	9-12	6-9	3.5
1.75	1.37-1.46	1.69-2.0	1.37-1.45	1.38-1.42	1.24-1.32
0.01-0.02	0.3-1.2	0.03-1.2	0.6-0.8	0.5-0.9	0.1-0.36
		0.12-1.5			
	260-400	140-400	200-370	300-380	250-400

Table 6.12.1 Properties of Plastic Resins and Compounds (Continued)

Materials	Properties	ASTM test method	Polyamide					
			Nylon, Type 6					
			Molding and extrusion compound	30–35% Glass fiber-reinforced	Toughened	High-impact copolymers and rubber-modified compounds	Impact-modified; 30% glass fiber-reinforced	Cast
33% Glass fiber-reinforced								
Processing	1a. Melt flow, g/10 min	D1238	0.5–10			1.5–5.0		
	1. Melting temperature, °C. $T_m$ (crystalline)		210–220	210–220	210–220	210–220	220	227–238
	$T_g$ (amorphous)							
	2. Processing temperature range, °F. (C = compression; T = transfer; I = injection; E = extrusion)		I: 440–550 E: 440–525	I: 460–550	I: 520–550	I: 450–580 E: 450–550	I: 480–550	
	3. Molding pressure range, $10^3$ lb/in <sup>2</sup>		1–20	2–20		1–20	3–20	
4. Compression ratio		3.0–4.0	3.0–4.0		3.0–4.0	3.0–4.0		
5. Mold (linear) shrinkage, in/in	D955	0.003–0.015	0.001–0.005	0.001–0.003	0.008–0.026	0.003–0.005		
Mechanical	6. Tensile strength at break, lb/in <sup>2</sup>	D638 <sup>b</sup>	6,000–24,000	24–27,600 <sup>c</sup> ; 18,900 <sup>d</sup>	17,800 <sup>c</sup>	6,300–11,000 <sup>c</sup>	21,000 <sup>c</sup> ; 14,500 <sup>d</sup>	12,500
	7. Elongation at break, %	D638 <sup>b</sup>	30–100 <sup>c</sup> ; 300 <sup>d</sup>	2.2–3.6 <sup>c</sup>	4.0 <sup>c</sup>	150–270 <sup>c</sup>	5 <sup>c</sup> –8 <sup>d</sup>	20–30
	8. Tensile yield strength, lb/in <sup>2</sup>	D638 <sup>b</sup>	13,100 <sup>c</sup> ; 7,400 <sup>d</sup>			9,000 <sup>c</sup> –9,500		
	9. Compressive strength (rupture or yield), lb/in <sup>2</sup>	D695	13,000–16,000 <sup>c</sup>	19,000–24,000 <sup>c</sup>		3,900 <sup>c</sup>		17,000
	10. Flexural strength (rupture or yield), lb/in <sup>2</sup>	D790	15,700 <sup>c</sup> ; 5,800 <sup>d</sup>	34–3,600 <sup>c</sup> ; 21,000 <sup>d</sup>	25,800 <sup>c</sup>	5,000–12,000 <sup>c</sup>		16,500
	11. Tensile modulus, $10^3$ lb/in <sup>2</sup>	D638 <sup>b</sup>	380–464 <sup>c</sup> ; 100–247 <sup>d</sup>	1,250–1,600 <sup>c</sup> ; 1,090 <sup>d</sup>			1,220 <sup>c</sup> –754 <sup>d</sup>	500
	12. Compressive modulus, $10^3$ lb/in <sup>2</sup>	D695	250 <sup>d</sup>					325
	13. Flexural modulus, $10^3$ lb/in <sup>2</sup>							
	73° F	D790	390–410 <sup>c</sup> ; 140 <sup>d</sup>	1,250–1,400 <sup>c</sup> ; 800–950 <sup>d</sup>	1,110 <sup>c</sup>	110–320 <sup>c</sup> ; 130 <sup>d</sup>	1,160 <sup>c</sup> –600 <sup>d</sup>	430
	200° F	D790				60–130 <sup>c</sup>		
	250° F	D790						
	300° F	D790						
	14. Izod impact, ft · lb/in of notch (1/8-in-thick specimen)	D256A	0.6–2.2 <sup>c</sup> ; 3.0 <sup>d</sup>	2.1–3.4 <sup>c</sup> ; 3.7–5.5 <sup>d</sup>	3.5 <sup>c</sup>	1.8–No break <sup>c</sup> 1.8–No break <sup>d</sup>	2.2 <sup>c</sup> –6 <sup>d</sup>	0.7–0.9
15. Hardness Rockwell	D785	R119 <sup>c</sup> ; M100–105 <sup>c</sup>	M93–96 <sup>c</sup> ; M78 <sup>d</sup>		R81–113 <sup>c</sup> ; M50		R115–125	
Shore/Barcol	D2240/ D2583						D78.83	
Thermal	16. Coef. of linear thermal expansion, $10^6$ in/(in · °C)	D696	80–83	16–80		72–120	20–25	50
	17. Deflection temperature under flexural load, °F							
	264 lb/in <sup>2</sup>	D648	155–185 <sup>c</sup>	392–420 <sup>c</sup>	400 <sup>c</sup>	113–140 <sup>c</sup>	410 <sup>c</sup>	330–400
66 lb/in <sup>2</sup>	D648	347–375 <sup>c</sup>	420–430 <sup>c</sup>	430 <sup>c</sup>	260–367 <sup>c</sup>	428 <sup>c</sup>	400–430	
18. Thermal conductivity, $10^{-4}$ cal · cm/(s · cm <sup>2</sup> · °C)	C177	5.8	5.8–11.4					
Physical	19. Specific gravity	D792	1.12–1.14	1.35–1.42	1.33	1.07–1.17	1.33	1.15–1.17
	20. Water absorption (1/8-in-thick specimen), %							
	24 h	D570	1.3–1.9	0.90–1.2	0.86	1.3–1.7	2.0	0.3–0.4
Saturation	D570	8.5–10.0	6.4–7.0		8.5	6.2	5–6	
21. Dielectric strength (1/8-in-thick specimen), short time, V/mil	D149	400 <sup>c</sup>	400–450 <sup>c</sup>		450–470 <sup>c</sup>		500–600	



Polyamide (Continued)

Nylon, Type 66						
Molding compound	30–33% Glass fiber- reinforced	Toughened	Antifriction molybdenum disulfide-filled	Lubricated		
		15–33% Glass fiber-reinforced		5% Silicone	30% PTFE	5% Molybdenum disulfide and 30% PTFE
255–265	260–265	256–265	249–265	260–265	260–265	260–265
1:500–620	1:510–580	1:530–575	1:500–600	1:530–570	1:530–570	1:530–570
1–25	5–20		5–25			
3.0–4.0	3.0–4.0					
0.007–0.018	0.002–0.006	0.0025–0.0045 <sup>c</sup>	0.007–0.018	0.015	0.007	0.01
13,700 <sup>c</sup> ; 11,000 <sup>d</sup>	27,600 <sup>c</sup> ; 20,300 <sup>d</sup>	10,900–20,300 <sup>c</sup> ; 14,500 <sup>d</sup>	10,500–13,700 <sup>c</sup>	8,500 <sup>c</sup>	5,500 <sup>c</sup>	7,500 <sup>c</sup>
15–80 <sup>c</sup> ; 150–300 <sup>d</sup>	2.0–3.4 <sup>c</sup> ; 3–7 <sup>d</sup>	4.7 <sup>c</sup> ; 8 <sup>d</sup>	4.4–40 <sup>c</sup>			
8,000–12,000 <sup>c</sup> ; 6,500–8,500 <sup>d</sup>	25,000 <sup>c</sup>					
12,500–15,000 <sup>c</sup> (yld.)	24,000–40,000 <sup>c</sup>	15,000 <sup>c</sup> –20,000	12,000–12,500 <sup>c</sup>			
17,900–1,700 <sup>c</sup> ; 6,100 <sup>d</sup>	40,000 <sup>c</sup> ; 29,000 <sup>d</sup>	17,400–29,900 <sup>c</sup>	15,000–20,300 <sup>c</sup>	15,000 <sup>c</sup>	8,000 <sup>c</sup>	1,200 <sup>c</sup>
230–550 <sup>c</sup> ; 230–500 <sup>d</sup>	1,380 <sup>c</sup> ; 1,090 <sup>d</sup>	1,230 <sup>c</sup> ; 943 <sup>d</sup>	350–550 <sup>c</sup>			
410–470 <sup>c</sup> ; 185 <sup>d</sup>	1,200–1,450 <sup>c</sup> ; 800 <sup>d</sup> ; 900	479–1,100 <sup>c</sup>	420–495 <sup>c</sup>	300 <sup>c</sup>	460 <sup>c</sup>	400 <sup>c</sup>
0.55–1.0 <sup>c</sup> ; 0.85–2.1 <sup>d</sup>	1.6–4.5 <sup>c</sup> ; 2.6–3.0 <sup>d</sup>	> 3.2–5.0	0.9–4.5 <sup>c</sup>	1.0 <sup>c</sup>	0.5 <sup>c</sup>	0.6 <sup>c</sup>
R120 <sup>c</sup> ; M83 <sup>c</sup> ; M95–105 <sup>d</sup>	R101–119 <sup>c</sup> ; M101–102 <sup>c</sup> ; M96 <sup>d</sup>	R107 <sup>c</sup> ; R115; R116; M86 <sup>c</sup> ; M70 <sup>d</sup>	R119 <sup>c</sup>			
80	15–54	43	54	63.0	45.0	
158–212 <sup>c</sup>	252–490 <sup>c</sup>	446–470	190–260 <sup>c</sup>	170	180	185
425–474 <sup>c</sup>	260–500 <sup>c</sup>	480–495	395–430			
5.8	5.1–11.7					
1.13–1.15	1.15–1.40	1.2–1.34	1.15–1.18	1.16	1.34	1.37
1.0–2.8	0.7–1.1	0.7–1.5	0.8–1.1	1.0	0.55	0.55
8.5	5.5–6.5	5	8.0			
600 <sup>c</sup>	360–500		360 <sup>c</sup>			

Table 6.12.1 Properties of Plastic Resins and Compounds (Continued)

Materials	Properties	ASTM test method	Polycarbonate				
			Unfilled molding and extrusion resins	Glass fiber-reinforced	Impact-modified polycarbonate/polyester blends	Lubricated	
							High viscosity
Processing	1a. Melt flow, g/10 min	D1238	3–10	7.0			
	1. Melting temperature, °C. $T_m$ (crystalline)						
	$T_g$ (amorphous)		150	150		150	
	2. Processing temperature range, °F. (C = compression; T = transfer; I = injection; E = extrusion)		I: 560	I: 520–650	I: 475–560	I: 590–650	
	3. Molding pressure range, $10^3$ lb/in <sup>2</sup>		10–20	10–20	15–20		
	4. Compression ratio		1.74–5.5		2–2.5		
Mechanical	5. Mold (linear) shrinkage, in/in	D955	0.005–0.007	0.002–0.005	0.006–0.009	0.002	
	6. Tensile strength at break, lb/in <sup>2</sup>	D638 <sup>b</sup>	9,100–10,500	7,000–10,000	7,600–8,500	12,000–15,000	
	7. Elongation at break, %	D638 <sup>b</sup>	110–120	4–10	120–165	2	
	8. Tensile yield strength, lb/in <sup>2</sup>		9,000	8,500–11,600	7,400–8,300		
	9. Compressive strength (rupture or yield), lb/in <sup>2</sup>	D695	10,000–12,500	12,000–14,000	7,000	11,000	
	10. Flexural strength (rupture or yield), lb/in <sup>2</sup>	D790	12,500–13,500	13,700–16,000	10,900–12,500	18,000–23,000	
	11. Tensile modulus, $10^3$ lb/in <sup>2</sup>	D638 <sup>b</sup>	345	450–600		1,200	
	12. Compressive modulus, $10^3$ lb/in <sup>2</sup>	D695	350	520			
	13. Flexural modulus, $10^3$ lb/in <sup>2</sup>	73°F	D790	330–340	460–580	280–325	850–900
		200°F	D790	275	440		
		250°F	D790	245	420		
		300°F	D790				
	14. Izod impact, ft · lb/in of notch (½-in-thick specimen)	D256A	12–18 @ ½ in 2.3 @ ¼ in	2–4	2–18	1.8–3.5	
	15. Hardness	Rockwell	D785	M70–M75	M62–75; R118–122	R114–122	
		Shore/Barcol	D2240/ D2583				
Thermal	16. Coef. of linear thermal expansion, $10^6$ in/(in · °C)	D696	68	32–38	80–95	21.6–23.4	
	17. Deflection temperature under flexural load, °F	264 lb/in <sup>2</sup>	D648	250–270	280–288	190–250	280–290
		66 lb/in <sup>2</sup>	D648	280–287	295	223–265	290
	18. Thermal conductivity, $10^{-4}$ cal · cm/(s · cm <sup>2</sup> · °C)	C177	4.7	4.6–5.2	4.3		
Physical	19. Specific gravity	D792	1.2	1.27–1.28	1.20–1.22	1.43–1.5	
	20. Water absorption (½-in-thick specimen), %	24 h	D570	0.15	0.12–0.15	0.12–0.16	0.11
		Saturation	D570	0.32–0.35	0.25–0.32	0.35–0.60	
21. Dielectric strength (½-in-thick specimen), short time, V/mil	D149	380–> 400	470–530	440–500			

Polyester, thermoplastic				Polyester, thermoset and alkyd		
Polybutylene terephthalate		Polyethylene terephthalate		Cast		Glass fiber-reinforced
Unfilled	30% Glass fiber-reinforced	Unfilled	30% Glass fiber-reinforced			Rigid
220–267	220–267	212–265	245–265	Thermoset	Thermoset	Thermoset
		68–80				
I: 435–525	I: 440–530	I: 440–660 E: 520–580	I: 510–590			C: 170–320
4–10	5–15	2–7	4–20			0.25–2
		3.1	2–3			1.0
0.009–0.022	0.002–0.008	0.002–0.030	0.002–0.009			0.0002–0.002
8,200–8,700	14,000–19,000	7,000–10,500	20,000–24,000	600–13,000	500–3,000	15,000–30,000
50–300	2–4	30–300	2–7	< 2.6	40–310	1–5
8,200–8,700		8,600	23,000			
8,600–14,500	18,000–23,500	11,000–15,000	25,000	13,000–30,000		15,000–30,000
12,000–16,700	22,000–29,000	12,000–18,000	30,000–36,000	8,500–23,000		10,000–40,000
280–435	1,300–1,450	400–600	1,300–1,440	300–640		800–2,000
375	700					
330–400	850–1,200	350–450	1,200–1,590	490–610		1,000–3,000
			520			
			390			
0.7–1.0	0.9–2.0	0.25–0.7	1.5–2.2	0.2–0.4	> 7	2–20
M68–78	M90	M94–101; R111	M90; M100			
				Barcol 35–75	Shore D84–94	Barcol 50–80
60–95	15–25	$65 \times 10^{-6}$	18–30	55–100		20–50
122–185	385–437	70–150	410–440	140–400		> 400
240–375	421–500	167	470–480			
4.2–6.9	7.0	3.3–3.6	6.0–7.6			
1.30–1.38	1.48–1.53	1.29–1.40	1.55–1.70	1.04–1.46	1.01–1.20	1.35–2.30
0.08–0.09	0.06–0.08	0.1–0.2	0.05	0.15–0.6	0.5–2.5	0.01–1.0
0.4–0.5	0.35	0.2–0.3				
420–550	460–560	420–550	430–650	380–500	250–400	350–500

Table 6.12.1 Properties of Plastic Resins and Compounds (Continued)

Materials	Properties	ASTM test method	Polyethylene and ethylene copolymers						
			Low and medium density		High density			Cross-linked	
			Linear copolymer	LDPE copolymers	Polyethylene homopolymer	Ultrahigh molecular weight	30% Glass fiber-reinforced		
				Ethylene-vinyl acetate				Molding grade	
Processing	1a. Melt flow, g/10 min	D1238		1.4–2.0	5–18				
	1. Melting temperature, °C. $T_m$ (crystalline)		122–124	103–110	130–137	125–138	120–140		
	$T_g$ (amorphous)								
	2. Processing temperature range, °F. (C = compression; T = transfer; I = injection; E = extrusion)		I: 350–500 E: 450–600	C: 200–300 I: 350–430 E: 300–380	I: 350–500 E: 350–525	C: 400–500	I: 350–600	C: 240–450 I: 250–300	
	3. Molding pressure range, 10 <sup>3</sup> lb/in <sup>2</sup>		5–15	1–20	12–15	1–2	10–20		
4. Compression ratio		3		2					
5. Mold (linear) shrinkage, in/in	D955	0.020–0.022	0.007–0.035	0.015–0.040	0.040	0.002–0.006	0.007–0.090		
Mechanical	6. Tensile strength at break, lb/in <sup>2</sup>	D638 <sup>b</sup>	1,900–4,000	2,200–4,000	3,200–4,500	5,600–7,000	7,500–9,000	1,600–4,600	
	7. Elongation at break, %	D638 <sup>b</sup>	100–965	200–750	10–1,200	420–525	1.5–2.5	10–440	
	8. Tensile yield strength, lb/in <sup>2</sup>	D638 <sup>b</sup>	1,400–2,800	1,200–6,000	3,800–4,800	3,100–4,000			
	9. Compressive strength (rupture or yield), lb/in <sup>2</sup>	D695			2,700–3,600		6,000–7,000	2,000–5,500	
	10. Flexural strength (rupture or yield), lb/in <sup>2</sup>	D790					11,000–12,000	2,000–6,500	
	11. Tensile modulus, 10 <sup>3</sup> lb/in <sup>2</sup>	D638 <sup>b</sup>	38–75	7–29	155–158		700–900	50–500	
	12. Compressive modulus, 10 <sup>3</sup> lb/in	D695						50–150	
	13. Flexural modulus, 10 <sup>3</sup> lb/in <sup>2</sup>	D790	40–105	7.7	145–225	130–140	700–800	70–350	
		200°F	D790						
		250°F	D790						
		300°F	D790						
14. Izod impact, ft · lb/in of notch (1/8-in-thick specimen)	D256A	1.0–No break	No break	0.4–4.0	No break	1.1–1.5	1–20		
15. Hardness Rockwell	D785				R50	R75–90			
	Shore/Barcol	D2240/ D2583	Shore D55–56	Shore D17–45	Shore D66–73	Shore D61–63		Shore D55–80	
Thermal	16. Coef. of linear thermal expansion, 10 <sup>6</sup> in/(in · °C)	D696		160–200	59–110	130–200	48	100	
	17. Deflection temperature under flexural load, °F	D648				110–120	250	105–145	
		264 lb/in <sup>2</sup>	D648			175–196	155–180	260–265	130–225
		66 lb/in <sup>2</sup>	D648						
18. Thermal conductivity, 10 <sup>-4</sup> cal · cm/(s · cm <sup>2</sup> · °C)	C177			11–12		8.6–11			
Physical	19. Specific gravity	D792	0.918–0.940	0.922–0.943	0.952–0.965	0.94	1.18–1.28	0.95–1.45	
	20. Water absorption (1/8-in-thick specimen), %								
		24 h	D570		0.005–0.13	< 0.01	< 0.01	0.02–0.06	0.01–0.06
	Saturation	D570							
21. Dielectric strength (1/8-in-thick specimen), short time, V/mil	D149		620–760	450–500	710	500–550	230–550		

Polyimide				Polypropylene				
Thermoplastic		Thermoset		Homopolymer			Copolymer	
Unfilled	30% Glass fiber-reinforced	Unfilled	50% Glass fiber-reinforced	Unfilled	10–30% Glass fiber-reinforced	Impact-modified, 40% mica-filled	Unfilled	10–20% Glass fiber-reinforced
4.5–7.5				0.4–38.0	1–20		0.6–44.0	0.1–20
388	388	Thermoset	Thermoset	160–175	168	168	150–175	160–168
250–365	250			– 20			– 20	
C: 625–690 I: 734–740 E: 734–740	I: 734–788	460–485	C: 460 I: 390 T: 390	I: 375–550 E: 400–500	I: 425–475	I: 350–470	I: 375–550 E: 400–500	I: 350–480
3–20	10–30	7–29	3–10	10–20			10–20	
1.7–4	1.7–2.3	1–1.2		2.0–2.4			2–2.4	
0.0083	0.0044	0.001–0.01	0.002	0.010–0.025	0.002–0.008	0.007–0.008	0.010–0.025	0.003–0.01
10,500–17,100	24,000	4,300–22,900	6,400	4,500–6,000	6,500–13,000	4,500	4,000–5,500	5,000–8,000
7.5–90	3	1		100–600	1.8–7	4	200–500	3.0–4.0
12,500–13,000		4,300–22,900		4,500–5,400	7,000–10,000		3,000–4,300	
17,500–40,000	27,500	19,300–32,900	34,000	5,500–8,000	6,500–8,400		3,500–8,000	5,500–5,600
10,000–28,800	35,200	6,500–50,000	21,300	6,000–8,000	7,000–20,000	7,000	5,000–7,000	7,000–11,000
300–400	1,720	460–4,650		165–225	700–1,000	700	130–180	
315–350	458	421		150–300				
360–500	1,390	422–3,000	1,980	170–250	310–780	600	130–200	355–510
				50			40	
				35			30	
210	1,175	1,030–2,690						
1.5–1.7	2.2	0.65–15	5.6	0.4–1.4	1.0–2.2	0.7	1.1–14.0	0.95–2.7
E52–99, R129, M95	R128, M104	110M–120M	M118	R80–102	R92–115		R65–96	R100–103
							Shore D70–73	
45–56	17–53	15–50	13	81–100	21–62		68–95	
460–680	469	572–> 575	660	120–140	253–288	205	130–140	260–280
				225–250	290–320		185–220	305
2.3–4.2	8.9	5.5–12	8.5	2.8	5.5–6.2		3.5–4.0	
1.33–1.43	1.56	1.41–1.9	1.6–1.7	0.900–0.910	0.97–1.14	1.23	0.890–0.905	0.98–1.04
0.24–0.34	0.23	0.45–1.25	0.7	0.01–0.03	0.01–0.05		0.03	0.01
1.2								
415–560	528	480–508	450	600			600	

Table 6.12.1 Properties of Plastic Resins and Compounds (Continued)

Materials	Properties	ASTM test method	Polystyrene and styrene copolymers						
			Polystyrene homopolymers			Rubber-modified	Styrene copolymers		
			High and medium flow	Heat-resistant	20% Long and short glass fiber-reinforced		Styrene-acrylonitrile (SAN)	High heat-resistant copolymers	
						High-impact		Molding and extrusion	20% glass fiber-reinforced
Processing	1a. Melt flow, g/10 min	D1238				5.8			
	1. Melting temperature range, °C. $T_m$ (crystalline) $T_g$ (amorphous)		74–105	100–110	115	9.3–105	100–200		
	2. Processing temperature range, °F. (C = compression; T = transfer; I = injection; E = extrusion)		C: 300–400 I: 350–500 E: 350–500	C: 300–400 I: 350–500 E: 350–500	I: 400–550	I: 350–525 E: 375–500	C: 300–400 I: 360–550 E: 360–450	I: 425–550	
	3. Molding pressure range, 10 <sup>3</sup> lb/in <sup>2</sup>		5–20	5–20	10–20	10–20	5–20		
	4. Compression ratio		3	3–5		4	3		
Mechanical	5. Mold (linear) shrinkage, in/in	D955	0.004–0.007	0.004–0.007	0.001–0.003	0.004–0.007	0.003–0.005	0.003–0.004	
	6. Tensile strength at break, lb/in <sup>2</sup>	D638 <sup>b</sup>	5,200–7,500	6,440–8,200	10,000–12,000	1,900–6,200	10,000–11,900	10,000–14,000	
	7. Elongation at break, %	D638 <sup>b</sup>	1.2–2.5	2.0–3.6	1.0–1.3	20–65	2–3	1.4–3.5	
	8. Tensile yield strength, lb/in <sup>2</sup>	D638 <sup>b</sup>		6,440–8,150		2,100–6,000	9,920–12,000		
	9. Compressive strength (rupture or yield), lb/in <sup>2</sup>	D695	12,000–13,000	13,000–14,000	16,000–17,000		14,000–15,000		
	10. Flexural strength (rupture or yield), lb/in <sup>2</sup>	D790	10,000–14,600	13,000–14,000	14,000–18,000	3,300–10,000	11,000–19,000	16,300–22,000	
	11. Tensile modulus, 10 <sup>3</sup> lb/in <sup>2</sup>	D638 <sup>b</sup>	330–475	450–485	900–1,200	160–370	475–560	850–900	
	12. Compressive modulus, 10 <sup>3</sup> lb/in <sup>2</sup>	D695	480–490	495–500			530–580		
	13. Flexural modulus, 10 <sup>3</sup> lb/in <sup>2</sup>	D790	380–490	450–500	950–1,100	160–390	500–610	800–1,050	
		73°F	D790						
		200°F	D790						
		250°F	D790						
		300°F	D790						
	14. Izod impact, ft · lb/in of notch (½-in-thick specimen)	D256A	0.35–0.45	0.4–0.45	0.9–2.5	0.95–7.0	0.4–0.6	2.1–2.6	
	15. Hardness								
	Rockwell	D785	M60–75	M75–84	M80–95, R119	R50–82; L–60	M80, R83		
	Shore/Barcol	D2240/ D2583							
Thermal	16. Coef. of linear thermal expansion, 10 <sup>6</sup> in/(in · °C)	D696	50–83	68–85	39.6–40	44.2	65–68	20	
	17. Deflection temperature under flexural load, °F								
		264 lb/in <sup>2</sup>	D648	169–202	194–217	200–220	170–205	214–220	231–247
		66 lb/in <sup>2</sup>	D648	155–204	200–224	220–230	165–200	220–224	
18. Thermal conductivity, 10 <sup>-4</sup> cal · cm/(s · cm <sup>2</sup> · °C)	C177	3.0	3.0	5.9		3.0			
Physical	19. Specific gravity	D792	1.04–1.05	1.04–1.05	1.20	1.03–1.06	1.06–1.08	1.20–1.22	
	20. Water absorption (½-in-thick specimen), %								
		24 h	D570	0.01–0.03	0.01	0.07–0.01	0.05–0.07	0.15–0.25	0.1
	Saturation	D570	0.01–0.03	0.01	0.3		0.5		
21. Dielectric strength (½-in-thick specimen), short time, V/mil	D149	500–575	500–525	425		425			

Polyurethane					Silicone		
Thermoset			Thermoplastic		Casting resins	Liquid injection molding	Molding and encapsulating compounds
Casting resins		55–65% Mineral-filled potting and casting compounds	Unreinforced molding	10–20% Glass fiber-reinforced molding compounds			
Liquid	Unsaturated						
Thermoset	Thermoset	Thermoset	75–137		Thermoset	Thermoset	Thermoset
				120–160			
C: 43–250		25 (casting)	I: 430–500 E: 430–510	I: 360–410		I: 360–420	C: 280–360 I: 330–370 T: 330–370
0.1–5				8–11		1–2	0.3–6
							2.0–8.0
0.020		0.001–0.002	0.004–0.006	0.004–0.010	0.0–0.006	0.0–0.005	0.0–0.005
175–10,000	10,000–11,000	1,000–7,000	7,200–9,000	4,800–7,500	350–1,000	725–1,305	500–1,500
100–1,000	3–6	5–55	60–180	3–70	20–700	300–1,000	80–800
			7,800–11,000				
20,000				5,000			
700–4,500	19,000		10,200–15,000	1,700–6,200			
10–100			190–300	0.6–1.40			
10–100							
10–100	610		235–310	40–90			
25 to flexible	0.4		1.5–1.8	10–14-No break			
			R > 100; M48	R45–55			
Shore A10–13, D90	Barcol 30–35	Shore A90, D52–85			Shore A10–70	Shore A20–70	Shore A10–80
100–200		71–100		34	10–19	10–20	20–50
Varies over wide range	190–200		158–260	115–130			> 500
			176–275	140–145			
5		6.8–10			3.5–7.5		7.18
1.03–1.5	1.05	1.37–2.1	1.2	1.22–1.36	0.97–2.5	1.08–1.14	1.80–2.05
0.2–1.5	0.1–0.2	0.06–0.52	0.17–0.19	0.4–0.55	0.1		0.15
			0.5–0.6	1.5			0.15–0.40
300–500		500–750 @ 1/16 in.	400	600	400–550		200–550

Table 6.12.1 Properties of Plastic Resins and Compounds (Continued)

Materials		ASTM test method	Vinyl polymers and copolymers				Molding and extrusion compounds
			PVC molding compound, 20% glass fiber-reinforced	PVC and PVC-acetate MC, sheets, rods, and tubes			
				Rigid	Flexible, unfilled	Flexible, filled	
Processing	1a. Melt flow, g/10 min	D1238					
	1. Melting temperature, °C. $T_m$ (crystalline)						
	$T_g$ (amorphous)		75–105	75–105	75–105	75–105	110
	2. Processing temperature range, °F. (C = compression; T = transfer; I = injection; E = extrusion)		I: 380–400 E: 390–400	C: 285–400 I: 300–415	C: 285–350 I: 320–385	C: 285–350 I: 320–385	C: 350–400 I: 395–440 E: 360–420
	3. Molding pressure range, 10 <sup>3</sup> lb/in <sup>2</sup>		5–15	10–40	8–25	1–2	15–40
4. Compression ratio		1.5–2.5	2.0–2.3	2.0–2.3	2.0–2.3	1.5–2.5	
5. Mold (linear) shrinkage, in/in	D955	0.001	0.002–0.006	0.010–0.050	0.008–0.035 0.002–0.008	0.003–0.007	
Mechanical	6. Tensile strength at break, lb/in <sup>2</sup>	D638 <sup>b</sup>	8,600–12,800	5,900–7,500	1,500–3,500	1,000–3,500	6,800–9,000
	7. Elongation at break, %	D638 <sup>b</sup>	2–5	40–80	200–450	200–400	4–100
	8. Tensile yield strength, lb/in <sup>2</sup>	D638 <sup>b</sup>		5,900–6,500			6,000–8,000
	9. Compressive strength (rupture or yield), lb/in <sup>2</sup>	D695		8,000–13,000	900–1,700	1,000–1,800	9,000–22,000
	10. Flexural strength (rupture or yield), lb/in <sup>2</sup>	D790	14,200–22,500	10,000–16,000			14,500–17,000
	11. Tensile modulus, 10 <sup>3</sup> lb/in <sup>2</sup>	D638 <sup>b</sup>	680–970	350–600			341–475
	12. Compressive modulus, 10 <sup>3</sup> lb/in <sup>2</sup>	D695					335–600
	13. Flexural modulus, 10 <sup>3</sup> lb/in <sup>2</sup>						
	73°F	D790	680–970	300–500			380–450
	200°F	D790					
	250°F	D790					
	300°F	D790					
	14. Izod impact, ft · lb/in of notch (½-in-thick specimen)	D256A	1.0–1.9	0.4–22	Varies over wide range	Varies over wide range	1.0–5.6
	15. Hardness Rockwell	D785	R108–119				R117–112
	Shore/Barcol	D2240/ D2583	Shore D85–89	Shore D65–85	Shore A50–100	Shore A50–100	
Thermal	16. Coef. of linear thermal expansion, 10 <sup>6</sup> in/(in · °C)	D696	24–36	50–100	70–250		62–78
	17. Deflection temperature under flexural load, °F						
	264 lb/in <sup>2</sup>	D648	165–174	140–170			202–234
	66 lb/in <sup>2</sup>	D648		135–180			215–247
18. Thermal conductivity, 10 <sup>-4</sup> cal · cm/(s · cm <sup>2</sup> · °C)	C177		3.5–5.0	3–4	3–4	3.3	
Physical	19. Specific gravity	D792	1.43–1.50	1.30–1.58	1.16–1.35	1.3–1.7	1.49–1.58
	20. Water absorption (½-in-thick specimen), %						
	24 h	D570	0.01	0.04–0.4	0.15–0.75	0.5–1.0	0.02–0.15
Saturation	D570						
21. Dielectric strength (½-in-thick specimen), short time, V/mil	D149		350–500	300–400	250–300	600–625	

<sup>a</sup> Acrylonitrile-butadiene-styrene. <sup>b</sup> Tensile test method varies with material; D638 is standard for thermoplastics; D651 for rigid thermoset plastics; D412 for elastomeric plastics; D882 for thin plastics sheeting. <sup>c</sup> Dry, as molded (approximately 0.2% moisture content). <sup>d</sup> As conditioned to equilibrium with 50% relative humidity. <sup>e</sup> Test method is ASTM D4092. <sup>f</sup> Pseudo indicates that the thermoset and thermoplastic components were mixed in the form of pellets or powder prior to fabrication.



ties of plastics which cannot be replicated in metals, including light weight and density (specific gravity rarely greater than 2, with the normal value in the range of 1.1 to 1.7—compare this with magnesium, the lightest structural metal of significance, whose specific gravity is 1.75); optical properties which may range from complete clarity to complete opacity, with the ability to be compounded with through colors in an

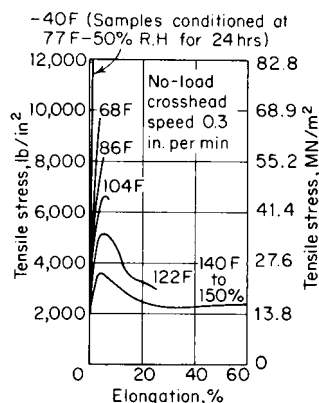

Fig. 6.12.1 Tensile stress-strain curve for thermoplastic Lucite. (The Du Pont Co.)

almost limitless range; low thermal conductivity and good electrical resistance; the ability to impart excellent surface finish to parts made by many of the primary production processes. Conversely, when compared to metals, plastics generally have lower elastic modulus—and thus, are inherently more flexible; have lower flexural and impact strength, and inferior toughness; and have lower dimensional stability generally than for most metals.

Some properties of plastics which are most desirable are high strength/weight ratios and the ability to process raw materials through to a finished size and shape in one of several basic operations; this last item has a large impact on the overall costs of finished products by virtue of eliminating secondary operations.

The seemingly endless variety of all types of plastics which are available in the marketplace is continually augmented by new compositions; if an end product basically lends itself to the use of plastics, there is most likely to be some existing composition available to satisfy the design requirements. See Table 6.12.1.

The properties of a given plastic can often be modified by the incorporation of additives into the basic plastic resin and include colorants, stabilizers, lubricants, and fibrous reinforcement. Likewise, where local strength requirements are beyond the capacity of the plastic, ingenious configurations of **metallic inserts** can be incorporated into the manufacture of the plastic part and become structurally integral with the part itself; female threaded inserts and male threaded studs are the most common type of inserts found in plastic part production.

Plastic resins may themselves be used as **adhesives** to join other plastics or other paired materials including wood/wood, wood/plastic, metal/plastic, metal/metal, and wood/metal. Structural **sandwich panels**, with the inner layer of sheet or foamed plastic, are an adaptation of composite construction.

**Foamed plastic** has found widespread use as thermal insulation, a volume filler, cushioning material, and many lightweight consumer items.

The ability to be recycled is an important attribute of thermoplastics; thermosets are deficient in this regard. In view of the massive amounts of plastic in the consumer stream, **recycling** has become more the norm than the exception; indeed, in some jurisdictions, recycling of spent plastic consumables is mandated by law, while in others, the incentive to recycle manifests itself as a built-in cost of the product—a tax, as it were, imposed at the manufacturing phase of production to spur recycling efforts. (See Recycling on next page.)

In those cases where secondary operations are required to be performed on plastic parts, the usual chip-producing material-removal processes are employed. In those regards, due diligence must be paid to the nature of the material being cut. Thermoplastics will soften from heat generated during cutting, and their low flexural modulus may require backing to prevent excessive deflection in response to cutting forces; thermosets may prove abrasive (even without fillers) and cause rapid wear of cutting edges. Cutting operations on some soft thermoplastics will experience elastic flow of the material beyond the cutting region, necessitating multiple cuts, each of smaller magnitude.

The raw-materials cost for plastics will vary. The economies of quantity production are self-evident from a study of applicable statistics of plastics production. Consider that in 1993, global production of plastic raw materials was in excess of 100 million metric tons (t). The final overall cost of a finished plastic part is impacted by the cost of raw materials, of course, but further, the use of plastic itself affects the design, manufacture, and shipping components of the final cost; these latter are not inconsequential in arriving at cost comparisons of production with plastics vis-à-vis metals. Suffice it to say that in general, when all costs are accounted for and when design requirements can be met with plastics, the end cost of a plastic item is often decidedly favorable.

## RAW MATERIALS

The source of virgin raw materials, or **feedstock**, is generally petroleum or natural gas. The feedstock is converted to monomers, which then become the basis for plastic resins. As recycling efforts increase, conversion of postconsumer plastic items (i.e., scrap) may result in increasing amounts of plastics converted back to feedstock by application of hydrolytic and pyrolytic processes.

The plastic is supplied to primary processors usually in the form of powder, solid pellets, or plastisols (liquid or semisolid dispersions of finely powdered polymer in a nonmigrating liquid).

Compounding, mixing, and blending prepare plastic materials to be fed into any of the various fabrication processes.

## PRIMARY FABRICATION PROCESSES

A number of processes are used to achieve finished plastic parts, including some conventional ones usually associated with metalworking and others synonymous with plastics processing. Casting, blow molding, extrusion, forming in metal molds (injection, compression, and transfer molding), expanded-bead molding to make foams, thermoforming of sheet plastic, filament winding over a form, press laminating, vacuum forming, and open molding (hand layup) are widespread plastics fabrication processes.

## ADDITIVES

The inherent properties of most plastics can be tailored to impart other desired properties or to enhance existing ones by the introduction of additives. A wide variety of additives allow compounding a specific type of plastic to meet some desired end result; a few additive types are listed below.

**Fillers** Wood flour, mica, silica, clay, and natural synthetic fibers reduce weight, reduce the volume of bulk resin used, impart some specific strength property (and often, directionality of strength properties), etc.

**Blowing or Foaming Agents** Compressed gas or a liquid which will evolve gas when heated is the agent which causes the network of interstices in expanded foam. A popular foaming agent, CFC (chlorinated fluorocarbon) is being displaced because of environmental concerns. Non-CFC foaming agents will increasingly replace CFCs.

**Mold-Release Compounds** These facilitate the removal of molded parts from mold cavities with retention of surface finish on the finished parts and elimination of pickup of molding material on mold surfaces.

**Lubricants** They ease fabrication and can serve to impart lubricant to plastic parts.

**Antistatic Compounds** The inherent good electrical insulation property of plastic often leads to buildup of static electric charges. The static charge enhances dust pickup and retention to the plastic surface. At the very least, this may inhibit the action of a mold-release agent; at worst, the leakage of static electric charge may be an explosion or fire hazard.

**Antibacterial Agents** These act to inhibit the growth of bacteria, especially when the type of filler used can be an attractive host to bacterial action (wood flour, for example).

**Colorants** Color is imparted to the resin by dyes or pigments. Dyes allow a wider range of color. Colorants enhance the utility of plastic products where cosmetic and/or aesthetic effects are required. Ultraviolet (uv) radiation from sunlight degrades the color unless a uv-inhibiting agent is incorporated into the plastic resin. (See below.)

**Flame Retardants** These are introduced primarily for safety, and they work by increasing the ignition temperature and lowering the rate of combustion.

**Heat Stabilizers** Plastics will degrade when subjected to high temperatures; thermoplastics will soften and eventually melt; thermosets will char and burn. Either type of plastic part is subjected to heat during processing and may see service above room temperature during its useful life. The judicious addition of an appropriate heat-stabilizing compound will prevent thermal degradation under those circumstances. Some of the more effective heat-stabilizing agents contain lead, antimony, or cadmium and are subject to increasingly stringent environmental limits.

**Impact Modifiers** When added to the basic resin, these materials increase impact strength or toughness.

**Plasticizers** These materials increase the softness and flexibility of the plastic resin, but often there is an accompanying loss of tensile strength, increased flammability, etc.

**Ultraviolet Stabilizers** These additives retard or prevent the degradation of some strength properties as well as color, which result from exposure to sunlight.

## ADHESIVES AND ASSEMBLY

Most adhesives operate to effect solvent-based **bonding**, and they are either one- or two-part materials. While these adhesives cure, the evaporation of volatile organic compounds (VOCs) constitutes an environmental hazard which is subject to increasing regulation. Water-based bonding agents, on the other hand, emit no VOCs and effectively are environmentally benign. Adhesives which are constituted of all solid material contain no solvents or water, hence no evaporants. A small

quantity of bonding is performed via **radiation-curable adhesives**. The source of energy is ultraviolet radiation or electron beam radiation.

The adhesives cited above, and others, display a range of properties which must be assessed as to suitability for the application intended.

**Welding of plastics** most often implies bonding or sealing of plastic sheet through the agent of ultrasonic energy, which, when applied locally, transforms high-frequency ultrasonic energy to heat, which, in turn, fuses the plastic locally to achieve the bond. The design of the joint is critical to the successful application of ultrasonic welding when the pieces are other than thin sheets. **Solvent welding** consists of localized softening of the pieces to be joined and the intimate mixture of the plastic surface material of both parts. The solvent is usually applied with the parts fixed or clamped in place, and sufficient time is allowed for the solvent to react locally with the plastic surfaces and then evaporate.

## RECYCLING

The feedstock for all plastics is either petroleum or natural gas. These materials constitute a valuable and irreplaceable natural resource. Plastic materials may degrade; plastic parts may break or no longer be of service; certainly, very little plastic per se "wears away." The basic idea behind plastic recycling takes a leaf from the metal industries, where recycling scrap metals has been the *modus operandi* from ancient times. The waste of a valuable resource implicit in discarding scrap plastic in landfills or the often environmentally hazardous incineration of plastics has led to very strong efforts toward recycling plastic scrap.

Separation of plastic by types, aided by unique identification symbols molded into consumer items, is mandated by law in many localities which operate an active recycling program. Different plastic types present a problem when comingled during recycling, but some postrecycling consumer goods have found their way to the market. Efforts will continue as recycling of plastics becomes universal; the costs associated with the overall recycling effort will become more attractive as economies of large-scale operations come into play.

Ideally, plastic recycling responds best to clean scrap segregated as to type. In reality, this is not the case, and for those reasons, a number of promising scrap processing directions are being investigated. Among those is depolymerization, whereby the stream of plastic scrap is subjected to pyrolytic or hydrolytic processing which results in reversion of the plastic to feedstock components. This regenerated feedstock can then be processed once more into the monomers, then to virgin polymeric resins. Other concepts will come under consideration in the near future.

## 6.13 FIBER COMPOSITE MATERIALS

by Stephen R. Swanson

REFERENCES: Jones, "Mechanics of Composite Materials," Hemisphere Publishing. Halpin, "Primer on Composite Materials Analysis," 2d ed., Technomic Pub. Co. "Engineered Materials Handbook," vol. 1, "Composites," ASM. Hull, "An Introduction to Composite Materials," Cambridge Univ. Press. Schwartz (ed.), "Composite Materials Handbook," 2d ed., McGraw-Hill.

### INTRODUCTION

**Composite materials** are composed of two or more discrete constituents. Examples of engineering use of composites date back to the use of straw in clay by the Egyptians. Modern composites using fiber-reinforced matrices of various types have created a revolution in high-performance structures in recent years. Advanced composite materials offer significant advantages in strength and stiffness coupled with light weight, relative to conventional metallic materials. Along with this structural

performance comes the freedom to select the orientation of the fibers for optimum performance. Modern composites have been described as being revolutionary in the sense that the material can be designed as well as the structure.

The **stiffness and strength-to-weight** properties make materials such as carbon fiber composites attractive for applications in aerospace and sporting goods. In addition, composites often have superior resistance to environmental attack, and glass fiber composites are used extensively in the chemical industries and in marine applications because of this advantage. Both glass and carbon fiber composites are being considered for infrastructure applications, such as for bridges and to reinforced concrete, because of this environmental resistance.

The cost competitiveness of composites depends on how important the weight reduction or environmental resistance provided by them is to

the overall function of the particular application. While glass fibers usually cost less than aluminum on a weight basis, carbon fibers are still considerably more expensive. Equally important or more important than the material cost is the cost of manufacturing. In some cases composite structures can achieve significant cost savings in manufacturing, often by reducing the number of parts involved in a complex assembly. There is a large variability in cost and labor content between the various methods of composite manufacture, and much attention is currently given to reduce manufacturing costs.

**TYPICAL ADVANCED COMPOSITES**

Modern composite materials usually, but not always, utilize a **reinforcement** phase and a **binder** phase, in many cases with more rigid and higher-strength fibers embedded and dispersed in a more compliant matrix. Modern applications started with **glass fibers**, although the word **advanced** fibers often means the more **high-performance fibers** that followed, such as carbon, aramid, boron, and silicon carbide. A typical example is carbon fiber that is being widely introduced into aerospace and sporting goods applications. The tensile strength of carbon fiber varies with the specific type of fiber being considered, but a typical range of values is 3.1 to 5.5 GPa (450 to 800 ksi) for fiber tensile strength and stiffness on the order of 240 GPa (35 Msi), combined with a specific gravity of 1.7. Thus the fiber itself is stronger than 7075 T6 aluminum by a factor of 5 to 10, is stiffer by a factor of 3.5, and weighs approximately 60 percent as much. The potential advantages of high-performance fiber structures in mechanical design are obvious. On the other hand, current costs for carbon fibers are on the order of several times to an order of magnitude or more higher than those for aluminum. The cost differential implies that composite materials will be utilized in demanding applications, where increases in performance justify the increased material cost. However, the material cost is only part of the story, for manufacturing costs must also be considered. In many instances it has been possible to form composite parts with significantly fewer individual components compared to metallic structures, thus leading to an overall lower-cost structure. On the other hand, composite components may involve a significant amount of hand labor, resulting in higher manufacturing costs.

**FIBERS**

**Glass Fiber** Glass fiber in a **polymeric matrix** has been widely used in commercial products such as boats, sporting goods, piping, and so forth. It has relatively low stiffness, high elongation, moderate strength and weight, and generally lower cost relative to other composites. It has been used extensively where corrosion resistance is important, for piping for the chemical industry, and in marine applications.

**Aramid Fiber** Aramid fibers (sold under the trade name **Kevlar**) offer higher strength and stiffness relative to glass, coupled with light weight, high tensile strength but lower compressive strength. Both glass fiber and aramid fiber composites exhibit good toughness in impact environments. Aramid fiber is used as a higher-performance replacement for glass fiber in industrial and sporting goods and in protective clothing.

**Carbon Fiber** Carbon fibers are used widely in aerospace and for some sporting goods, because of their relatively high stiffness and high strength/weight ratios. Carbon fibers vary in strength and stiffness with processing variables, so that different grades are available (high modulus or intermediate modulus), with the tradeoff being between high modulus and high strength. The intermediate-modulus and high-strength grades are almost universally made from a **PAN (polyacrylonitrile) precursor**, which is then heated and stretched to align the structure and remove noncarbon material. Higher-modulus but lower-cost fibers with much lower strength are made from a petroleum pitch precursor.

**Other Fibers** Boron fibers offer very high stiffness, but at very high cost. These fibers have been used in specialized applications in both aluminum and polymeric matrices. A new fiber being used in textile applications is oriented polyethylene, marketed under the trademark **Spectra**. This fiber combines high strength with extremely light weight. The fiber itself has a specific gravity of 0.97. It is limited to a very low range of temperature, and the difficulty of obtaining adhesion to matrix materials has limited its application in structural composites. A number of other fibers are under development for use with ceramic matrices, to enable use in very high-temperature applications such as engine components. An example is **silicon carbide fiber**, used in **whisker** form.

Table 6.13.1 lists data pertinent to fibers currently available.

**MATRICES**

Most current applications utilize polymeric matrices. **Thermosetting polymers** (such as **epoxies**) are widely utilized, and a large amount of characterization data are available for these materials. Epoxies provide superior performance but are more costly. Typical cure temperatures are in the range of 121 to 177°C (250 to 350°F). A recent development has been high-toughness epoxies, which offer significantly improved resistance to damage from accidental impact, but at higher cost. Polyester and vinyl ester are often used in less demanding applications, and polyurethane matrices are being considered because of short cure times in high-production-rate environments. **Thermoplastic matrices** are under development and have had limited applications to date. Wider use awaits accumulation of experience in their application and is inhibited in some instances by high material costs. Their use is likely to increase because of the increased toughness they may provide, as well as the potential for forming complex shapes. Composites using thermoplastics often are formed to final shape at temperatures of about 315°C (600°F), and they need no cure cycle.

Polymeric matrix materials have a limited temperature range for practical application, with epoxies usually limited to 150°C (300°F) or less, depending on the specific material. Higher-temperature polymers available, such as polyimides, usually display increased brittleness. They are used for cowlings and ducts for jet engines.

Metal matrix composites are utilized for higher-temperature applications than is possible with polymeric matrices. Aluminum matrix has been utilized with boron and carbon fibers. Ceramic matrix materials are being developed for service at still higher temperatures. In this case, the fiber is not necessarily higher in strength and stiffness than the matrix, but is used primarily to toughen the ceramic matrix.

**Table 6.13.1 Mechanical Properties of Typical Fibers**

Fiber	Fiber diameter, $\mu\text{m}$	Fiber density		Tensile strength		Tensile modulus	
		lb/in <sup>3</sup>	g/cm <sup>3</sup>	ksi	GPa	Msi	GPa
E-glass	8–14	0.092	2.54	500	3.45	10.5	72.4
S-glass	8–14	0.090	2.49	665	4.58	12.5	86.2
Polyethylene	10–12	0.035	0.97	392	2.70	12.6	87.0
Aramid (Kevlar 49)	12	0.052	1.44	525	3.62	19.0	130.0
HS carbon, T300	7	0.063	1.74	514	3.54	33.6	230
AS4 carbon	7	0.065	1.80	580	4.00	33.0	228
IM7 carbon	5	0.065	1.80	785	5.41	40.0	276
GY80 carbon	8.4	0.071	1.96	270	1.86	83.0	572
Boron	50–203	0.094	2.60	500	3.44	59.0	407

## MATERIAL FORMS AND MANUFACTURING

Composite materials come in a wide variety of material forms. The fiber itself may be used in continuous form or as a **chopped fiber**. Chopped glass fibers are used typically to reinforce various polymers, with concomitant lower strength and stiffness relative to continuous fiber composites. Chopped fibers in conjunction with automated fabrication techniques have been utilized to fabricate automotive body parts at high production rates.

**Continuous-fiber materials** are available in a number of different forms, with the specific form utilized depending on the manufacturing process. Thus it is useful to consider both the material and the manufacturing process at the same time. The fibers themselves have a small diameter, with sizes of 5 to 7  $\mu\text{m}$  (0.0002 to 0.0003 in) typical for carbon fibers. A large number of fibers, from 2,000 to 12,000, are gathered in the manufacturing process to form a **tow** (also called a **roving** or **yarn**). The filament winding process utilizes these tows directly. The tows may be further processed by **prepregging**, the process of coating the individual fibers with the matrix material. This process is widely used with thermosetting polymeric resins. The resin is partially cured, and the resulting “**ply**” is placed on a paper backing. The prepregged material is available in continuous rolls in widths of 75 to 1,000 mm (3 to 40 in). These rolls must be kept refrigerated until they are utilized and the assembled product is cured. Note that the ply consists of a number of fibers through its thickness, and that the fibers are aligned and continuous. Typical volume fractions of fiber are on the order of 60 percent. The material forms discussed here are used in a variety of specific manufacturing techniques. Some of the more popular techniques are described briefly below.

**Filament Winding** The process consists of winding the fiber around a mandrel to form the structure. Usually the mandrel rotates while fiber placement is synchronized to proceed in a longitudinal direction. The matrix may be added to the fiber by passing the fiber tow through a matrix bath at the time of placement, a process called **wet winding**; or the tows may be prepregged prior to winding. Filament winding is widely used to make glass fiber pipe, rocket motor cases, and similar products. Filament winding is a highly automated process, with typical low manufacturing costs. Obviously, it lends itself most readily to axisymmetric shapes, but a number of specialized techniques are being considered for nonaxisymmetric shapes.

**Prepreg Layup** This common procedure involves laying together individual plies of prepregged composite into the final laminated structure. A mold may be used to control the part geometry. The plies are laid down in the desired pattern, and then they are wrapped with several additional materials used in the curing process. The objective is to remove volatiles and excess air to facilitate consolidation of the laminate. To this end, the laminate is covered with a **peel ply**, for removal of the other curing materials, and a **breather ply**, which is often a fiberglass net. Optionally, a bleeder may be used to absorb excess resin, although the net resin process omits this step. Finally, the assembly is covered with a vacuum bag and is sealed at the edges. A vacuum is drawn, and after inspection heat is applied. If an autoclave is used, pressure on the order of 0.1 to 0.7 MPa (20 to 100 lb/in<sup>2</sup>) is applied to ensure final consolidation. Autoclave processing ensures good lamination but requires a somewhat expensive piece of machinery. Note that the individual plies are relatively thin [on the order of 0.13 mm (0.005 in)], so that a large number of plies will be required for thick parts. The lamination process is often performed by hand, although automated tape-laying machines are available. Although unidirectional plies have been described here, cloth layers can also be used. The bends in the individual fibers that occur while using cloth layers carry a performance penalty, but manufacturing considerations such as drapeability may make cloth layers desirable.

**Automated Tape and Tow Placement** Automated machinery is used for tape layup and fiber (tow) placement. These machines can be large enough to construct wing panels or other large structures. Thermosetting matrices have been used extensively, and developments using thermoplastic matrices are underway.

**Textile Forms** The individual tows may be combined in a variety of textile processes such as **braiding** and **weaving**. Preforms made in these ways then can be impregnated with resin, often called **resin transfer molding** (RTM). These textile processes can be designed to place fibers in the through-the-thickness direction, to impart higher strength in this direction and to eliminate the possibility of delamination. There is considerable development underway in using braided and/or stitched preforms with RTM because of the potential for automation and high production rates.

## DESIGN AND ANALYSIS

The fundamental way in which fiber composites, and in particular continuous-fiber composites, differ from conventional engineering materials such as metals is that their properties are **highly directional**. Stiffness and strength in the fiber direction may be higher than in the direction transverse to the fibers by factors of 20 and 50, respectively. Thus a basic principle is to align the fibers in directions where stiffness and strength are needed. A well-developed theoretical basis called **classical lamination theory** is available to predict stiffness and to calculate stresses within the layers of a laminate. This theory is often applied to filament-wound structures and to textile preform structures, if allowances are made for the undulations in the fiber path. The basic assumption is that fiber composites are orthotropic materials. Thin composite layers require four independent elasticity constants to characterize the stiffness; those are the fiber direction modulus, transverse direction modulus, in-plane shear modulus, and one of the two Poisson ratios, with the other related through symmetry of the orthotropic stress-strain matrix. The material constants are routinely provided by material suppliers. Lamination theory is then used to predict the overall stiffness of the laminate and to calculate stresses within the individual layers under mechanical and thermal loads.

Transverse properties are much lower than those in the fiber direction, so that fibers must usually be oriented in more than one direction, even if only to take care of secondary loads. For example, a laminate may consist of fibers in an axial direction combined with fibers oriented at  $\pm 60^\circ$  to this direction, commonly designated as an  $[0_m/\pm 60_n]_s$  laminate, where  $m$  and  $n$  refer to the number of plies in the axial and  $\pm 60^\circ$  directions and  $s$  stands for symmetry with respect to the midplane of the laminate. Although not all laminates are designed to be symmetric, residual stresses will cause flat panels to curve when cooled from elevated-temperature processing unless they are symmetric. Other popular laminates have fibers oriented at  $0^\circ$ ,  $\pm 45^\circ$ , and  $90^\circ$ . If the relative amounts of fibers are equal in the  $[0/\pm 60]$  or the  $[0/\pm 45/90]$  directions, the laminate has in-plane stiffness properties equal in all directions and is thus termed **quasi-isotropic**.

Note that the **stiffness of composite laminates** is less than that of the fibers themselves for two reasons. First, the individual plies contain fibers and often a much less stiff matrix. With high-stiffness fibers and polymeric matrices, the contribution of the matrix can be neglected, so that the stiffness in the fiber direction is essentially the **fiber volume fraction**  $V_f$  times the fiber stiffness. Fiber volume fractions are often on the order of 60 percent. Second, laminates contain fibers oriented in more than one direction, so that the stiffness in any one direction is less than it would be in the fiber direction of a unidirectional laminate. As an example, the in-plane stiffness of a quasi-isotropic carbon fiber/polymeric matrix laminate is about 45 percent of unidirectional plies, which in turn is approximately 60 percent of the fiber modulus for a 60 percent fiber volume fraction material.

**Strength Properties** Fiber composites typically have excellent strength-to-weight properties; see Table 6.13.1. Like stiffness properties, strength properties are reduced by dilution by the weaker matrix, and because not all the fibers can be oriented in one direction. The overall reduction in apparent strength because of these two factors is similar to that for stiffness, although this is a very rough guide. As an example, the strength of a quasi-isotropic carbon/epoxy laminate under uniaxial tensile load has been reported to be about 35 to 40 percent of that provided by the same material in a unidirectional form.

Fiber composite materials can fail in several different modes. The design goal is usually to have the failure mode be **in-plane failure** due to fiber failure, as this takes advantage of the strong fibers. Unanticipated loads, or poorly designed laminates, can lead to ultimate failure of the matrix, which is much weaker. For example, in-plane shear loads on a [0/90] layup would be resisted by the matrix, with the potential result of failure at low applied load. Adding [ $\pm 45$ ] fibers will resist this shear loading effectively.

Fiber composites respond differently to compressive loads than they do to tensile loads. Some fibers, such as aramid and the very high-modulus carbon fibers, are inherently weaker in compression than in tension. It is believed that this is not the case with intermediate-modulus carbon fibers, but even these fibers often display lower compressive strength. The mechanism is generally believed to involve bending or buckling of the very small-diameter fibers against the support provided by the matrix.

**Matrix cracking** usually occurs in the transverse plies of laminates with polymeric matrices, often at an applied load less than half that for

ultimate fiber failure. This is caused by the lower failure strain of the matrix and the stress concentration effect of the fibers, and it can also depend on residual thermal stresses caused by the differences in coefficients of thermal expansion in the fibers and matrix. In some cases these matrix cracks are tolerated, while in other cases they produce undesirable effects. An example of the latter is that matrix cracking increases the permeability in unlined pressure vessels, which can result in pipes weeping.

Another potential failure mode is **delamination**. Delamination is often caused by high interlaminar shear and through-the-thickness tensile stresses, perhaps combined with manufacturing deficiencies such as inadequate cure or matrix porosity. Delamination can start at the edges of laminates due to "edge stresses" which have no counterpart in isotropic materials such as metals.

Fiber composites usually have excellent fatigue properties. However, stress concentrations or accidental damage can result in localized damage areas that can lead to failure under fatigue loading.