

The Integral Passive Solar Water Heater Book

*Breadboxes, batchers, and other types
of simple solar water heaters*

by
David A. Bainbridge
The Passive Solar Institute

ISBN 0-933490-03-8

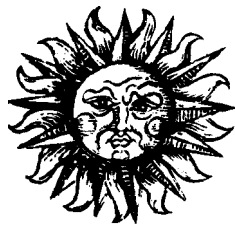

Copyright © 1981: David A. Bainbridge
All rights reserved.

Acknowledgments:

My thanks to the many people who contributed their time and energy to this project. With special thanks to:

John Burton
Ken Butti and John Perlin for permission to reprint
material from "Solar Water Heating in California"
Pliny Fisk
John Golder
Horace McCracken
Alan Wyatt
Peter Zweig
My wife for her encouragement and patient proofing.

Credits:

photo production, Black and White Custom Lab
typesetting, Aurora Type and Design
halftones, Design Enterprises

Olive Street in Los Angeles 1900 with three Climax Solar Water Heaters in view

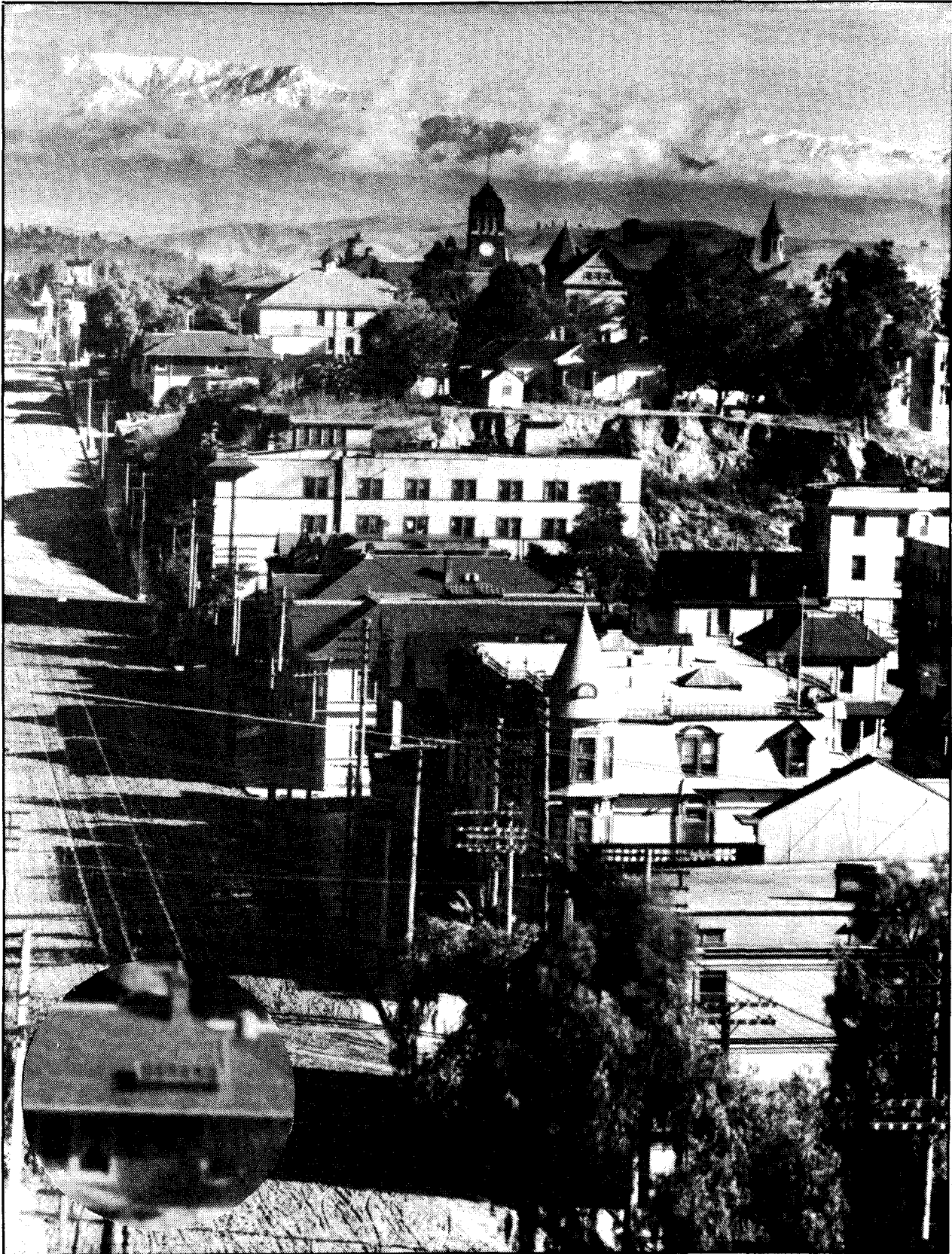

by permission Butti and Perlin

Progress is like a merry-go-round. We get up on a speckled horse an' th' mechanical pianny plays a chune an' away we go, hollerin'. We think we're travelling like th' divvle but th' man that doesn't care about merry-go-rounds knows that we will come back where we were.

Finley Peter Dunne 1902

Contents

Chapter 1: An Introduction

- 2: A History of IPSWH's
- 3: The Basics of Design: Principles
- 4: IPSWH Design
- 5: Operating An IPSWH
- 6: Backup Heating
- 7: IPSWH's In Action
- 8: Building Your Own
- 9: Commercial IPSWH's
- 10: Market Potential for IPSWH's
- 11: Starting an IPS WH Business
- 12: The Future is for IPSWH's

Appendices: 1 - Site Selector

- 2 - Resources
- 3 - Recycled Tanks
- 4 - Performance
- 5 - Response Form

Chapter 1: An Introduction

The increasing cost and scarcity of oil, gas, and electricity has focused attention on the need for a transition to renewable energy sources. Solar energy will play an essential role in this effort, particularly for domestic and commercial space heating (and cooling) and water heating. This book is about the simplest type of solar water heater—the integral passive solar water heater.

Solar systems for heating space or water can be divided into two classes—passive and active systems. The essential difference is that passive systems need no auxiliary power to operate while active systems are dependent on externally driven fans or pumps.

Passive solar systems typically are very simple, low in cost, built with readily available building materials, reliable, durable, and cost-effective. Many passive systems have only one moving part—the sun—which in large part accounts for their reliability.

Passive solar water heaters can be further subdivided into two classes: systems in which the functions of heat collection and storage are separate (the thermosiphon flat plate systems), and systems with combined collection and storage—the integral passive solar water heater (IPSWH), pronounced "ipswah"). IPSWH systems are much less widely known despite some inherent advantages, especially simplicity, economy, and resistance to freezing.

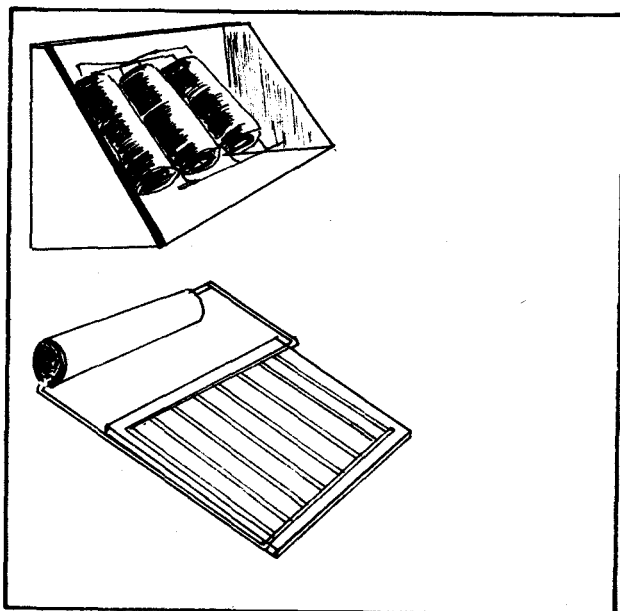

IPSWH's are particularly appealing to the home owner because they can be built at home with recycled materials for less than \$50 or with all new materials for less than \$500. For the manufacturer and/or installer they are attractive because the feature of combined storage and collection lowers the cost of both production and installation. And for the building contractor or subcontractor, IPSWH's are desirable because of their low cost, ease of installation, durability and reliability (and hence little potential for call-backs).

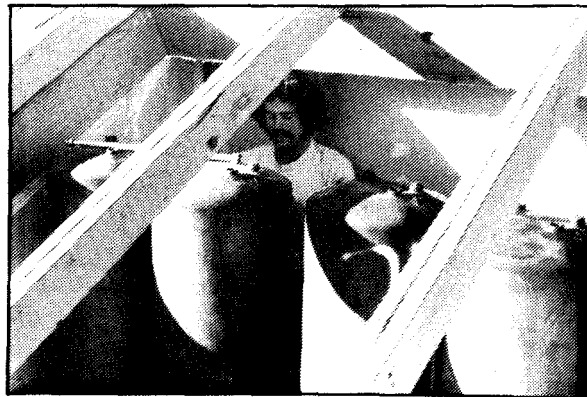

This book was written to bring this type of water heater the wider recognition it deserves. It begins with a history of the IPSWH—from the first commercial solar water heater produced in the U.S. to the latest developments both here and abroad. The scientific principles that enable these simple heaters to collect and store solar energy are then presented and explained along with details of the application of these concepts to the design of your own heater. Another chapter presents more "hands on" information you'll need to build your own solar water heater. Alternatively, you can purchase one of the commercial models now manufactured or available in the U.S.



The opportunities for starting a business based on solar water heating, including market potential, are surveyed in another chapter. The transition to renewable energy sources has few better business opportunities than IPSWH's. The final chapter examines the potential impact of IPSWH's on energy use in the U.S. and the probable course of their development over the next few years. Standard Oil of California's entry into the IPSWH market in 1981 is an indication of future trends and the level of activity that can be expected in the next few years.

So start now and join in the transition to renewable fuels with your own IPSWH. And let me know how yours performs for the next edition of this book.

Chapter 2: A History of IPSWHs

There is no doubt that IPSWH's were the first solar water heaters used in the U.S. In the 1800's they were apparently used on a few farms and ranches across the country. Butch Cassidy's roost in Utah reportedly still has remnants of the prototype solar heater-the black can of water in the sun. And this most basic model is still used in areas without piped water or indoor facilities. A notable example exists in California high in the Sierra Nevada at the Evolution Valley back country ranger station.

The first commercial solar water heater, patterned after the fundamental black can, was patented in 1891 by Clarence M. Kemp. As the president of C.M. Kemp Manufacturing Company in Baltimore, Maryland (est. 1877), he had seen the need for an alternative to the wood stove water heating pipe coils on hot summer Maryland days. These wet-back wood stoves work well and are still available today-but would be miserable to use on a hot and muggy summer day. The solution was a refinement of the black can heater-and the first fully developed model was probably built in 1890.

Kemp called his system the Climax water heater and he sold a number of them in the eastern U.S. His promotional literature still sounds appealing today: "With this heater on tap you can go home at night and find hot water for the bath ready for you, on tap the same as the cold water. You can do without the range in the summer ... You have simply to open a tap and instantly comes the hot water; there is no delay, no expense for fuel."

The Climax heater came in a variety of sizes, from 32 gallons (121 l) to 700 gallons (2,650 l). The basic model, Number One, has four cylindrical 8 gallon (30 l) tanks set inside a 3 x 4 1/2 foot (.9 m x 1.4 m) pine box lined with felt paper and covered with single pane glazing. The ratio between water and glazing was good on the smaller model, with only 2.3 gallons of water to be heated per square foot of glazing to collect the heat (93.7 l per sq m), well within the range recommended today. But this ratio increased to almost 13 gallons per square foot (530 l per sq m) in the larger 4A model which would have provided very sluggish performance suited only for very warm climates with warm nights.

The systems were typically installed on a roof with simple gravity feed forcing the hot water to the tap as the cold water from a reservoir entered the tank inlet. The sales material also showed a metal bracket designed to fasten the Climax heater to a south wall near the point of use.

Sunshine Like Salvation is Free
Buy a Climax Solar Heater and See

THE CLIMAX SOLAR-WATER HEATER—(Patented April 28th, 1891.)

Has been in use since the summer of 1890 and has more than fulfilled the inventor's expectations. It is made of the best galvanized metal, made for enduring service, and is thought will last for 10 or 15 years or the same as other fixtures in a house, such as Bath Tubs, Ranges, &c. With this heater in service you can go home at night and find hot water for bath ready for you, on tap the same as the cold water. You can do without the Range in Summer—this Heater will give the HOT WATER and a Gas Stove do the Cooking, &c.

You have simply to open a cock and **instantly comes the hot water**; there is no delay—no expense for fuel. No. 1 size will furnish hot water for several baths.

Can be connected with Iron Pipes or with Hose.
To connect—costs but a FEW DOLLARS.
USEFUL IN THE COUNTRY as well as IN THE CITY.
Pipe connections can be made through the roof, or through the side wall, or through the window frame, easily and cheaply without injury to the room.

This Heater absorbs an extremely large amount of heat from the sun and stores it for bathing, domestic and other purposes. It consists of a white pine box, made very close and tight, and lined with felt paper; this box is covered with glass sash. Inside the box is placed four cylindrical tanks made of heavy galvanized iron—each holding about eight gallons of water, or thirty-two gallons in all (for No. 1 size). These tanks are painted a dull black and quickly absorb the heat-rays of the sun which penetrates through the glass top. They are arranged in such manner as to secure the greatest results, and keep the incoming cold water from mixing with the hot water; the heat grasped by this apparatus is retained for a long time, even if a Storm or Cold Wind comes up.

The heaters are made with four cylindrical tanks; the water enters the lowest tank at the front end and forces the hot water ahead of it, causing it to leave at the top of this first tank at the far end, and pass into the rear end of the next tank through a tube which runs to the bottom, this compels a displacement in the second tank, the water leaving at the top of its front end and passing into the bottom of the front end of the third tank, thence from the rear end of this third tank into the bottom of the fourth tank, and finally the discharge takes place from the top of the front end of the fourth tank into the pipe that runs to bath-room. By this arrangement of pipes, all air is kept out of the tanks, the water fills them completely, hence the sun's heat striking the darkened surfaces of the tanks is directly absorbed by the water. By this arrangement, also, when it is desired to drain the tanks, the drain cock is opened in the bath-room, and the water is siphoned from one tank to the other, so that they are all emptied except some small quantity in each, which can do no harm.

There is no pressure on the tanks. If the sun has set and night has come, hence no more hot water can be made, and the entire contents of the tanks is desired—the drain cock can be used for drawing a same—this gives all the hot water in the tanks without any admixture of cold water, this manner of drawing the hot water absorbs it unnecessary, except where great demand is made on the heater at night. After use in this way the tanks should be filled again in the regular manner, so that the morrow's sun will find water in the tanks to act upon.

Fig. 1.—No. 1 Climax Solar-Water Heater, glazed and ready for connection.

Fig. 2.—Shows a swimming pool which can be supplied with hot water from "Our Heater."

Fig. 3.—Shows another service it is qualified for.

Fig. 4.—Shows a Climax Solar-Water Heater, mounted by a bracket on the wall, and the pipes connected to the tanks. The pipes are connected to the tanks in the following manner: A—The tank to be filled with cold water, and the water entering from the bottom of the tank. B—The air opening which is used to prevent the water from being drawn into the heater and replace water. C—The air opening which is used to prevent the water from being drawn into the heater and replace water.

Fig. 5.—Shows a Climax Solar-Water Heater, mounted by a bracket on the wall, and the pipes connected to the tanks. The pipes are connected to the tanks in the following manner: A—The tank to be filled with cold water, and the water entering from the bottom of the tank. B—The air opening which is used to prevent the water from being drawn into the heater and replace water. C—The air opening which is used to prevent the water from being drawn into the heater and replace water.

Fig. 6.—Shows a Climax Solar-Water Heater, mounted by a bracket on the wall, and the pipes connected to the tanks. The pipes are connected to the tanks in the following manner: A—The tank to be filled with cold water, and the water entering from the bottom of the tank. B—The air opening which is used to prevent the water from being drawn into the heater and replace water. C—The air opening which is used to prevent the water from being drawn into the heater and replace water.

Fig. 7.—Shows the box removed, and the four cylindrical tanks connected.

THE CLIMAX SOLAR-WATER HEATER

Can be used in some states throughout the entire year, in others from the 1st of April until the end of October; in the northernmost states from May 1st until October 1st.

During the early Spring and late Fall months, while the temperature during the day has been near the freezing point, the heater water has been over 100 degrees, the efficiency shown by the heater is from 60° to 100° degree greater than the temperature for the day.

The water at times almost boils.

No.	SIZE	CAPACITY.	WEIGHT.	PRICE.
1	3 x 4 1/2 ft. x 1 ft. deep	32 gals.	125 lbs.	\$25.00
1A	3 x 4 1/2 " x 1 1/2 "	80 "	225 "	48.00
2	3 1/2 x 5 1/2 " x 1 1/2 "	65 "	185 "	40.00
2A	3 1/2 x 5 1/2 " x 2 1/2 "	160 "	325 "	70.00
3	5 x 7 " x 3 "	170 "	450 "	125.00
3A	5 x 7 " x 2 1/2 "	330 "	700 "	200.00
4	6 x 9 " x 1 1/2 "	290 "	700 "	240.00
4A	6 x 9 " x 3 1/2 "	700 "	1200 "	580.00

Discount Per Cent.

We will make to Order any Size wanted.
On Cloudy Days the Climax Solar-Water Heater absorbs very considerable heat.

CLARENCE M. KEMP, BALTIMORE, MD.

On to California

In 1895 Kemp sold the exclusive manufacturing rights of the Climax heater systems to two Pasadena businessmen for \$250, which suggests it hadn't been one of the Kemp Manufacturing Company's best sellers. W.H. Congers and E.F. Brooks found the sunny climate of southern California more fruitful than Maryland and enjoyed good sales. At this time the Climax Number One sold for \$25. The price of alternative energy was high in Pasadena and a buyer could expect the solar heater to pay for itself in less than three years.

The manufacturing rights changed hands again in 1898. Mrs. Sarah Robbins paid Congers and Brooks \$2,500, an increase in value of ten times in three years and an auspicious sign. Sales increased rapidly and by 1900 over 1,600 Climax heaters had been installed.

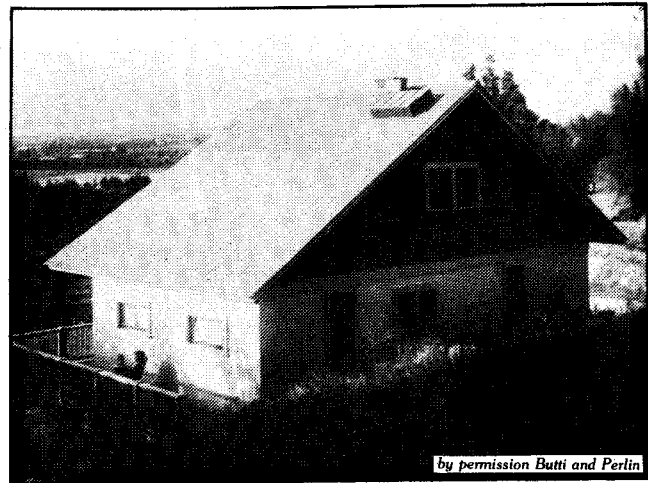

Climax Heater, Pasadena 1902

Climax Solar-Water Heater

UTILIZING ONE OF NATURE'S GENEROUS FORCES

THE SUN'S HEAT { Stored up in Hot Water for Baths, Domestic and other Purposes.

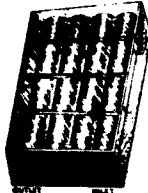

\$25

Competition for the profitable solar water heating market wasn't slow in developing. The success of the Climax in Pasadena led Frank Walker to conduct his own experiments in solar water heating. In 1898 he applied for a patent on the Walker Combined Solar and Artificial Heat Water Heater. Walker's heater was designed to sit flush in the roof, providing both aesthetic and functional advantages over the exposed Climax. It also included double rather than single glazing. His heater used fewer and larger tanks, typically 30 gallons (113 l) rather than the 8 gallon (30 l) Climax tanks; and the Walker tanks were oriented vertically and connected in series. By setting the tanks in the roof the nighttime heat loss would have been considerably reduced and warmer water would have been available in the morning. Recent experiments have suggested that the vertical orientation would also have improved performance by increasing thermal stratification in the tank.

With almost 4 gallons per square foot (163 l per sq m) the ratio of water to glazing was higher (and hence the performance was lower) than in the Climax. During daytime operation this probably reduced performance and offset most the increased efficiency afforded by the double glazing, vertical tank orientation, and roof protection; but the design would have offered warmer water in the morning because a low glazing to water ratio slowed the rate of nighttime cool down. The Walker solar system was patented with backup connections to a wet back wood stove. This "new" feature probably wasn't new at all but reflected existing practice with Climax installations as made by more experienced plumbers.

The Walker system sold for less than \$50. It offered some advantages over the Climax heaters and sold well in southern California.

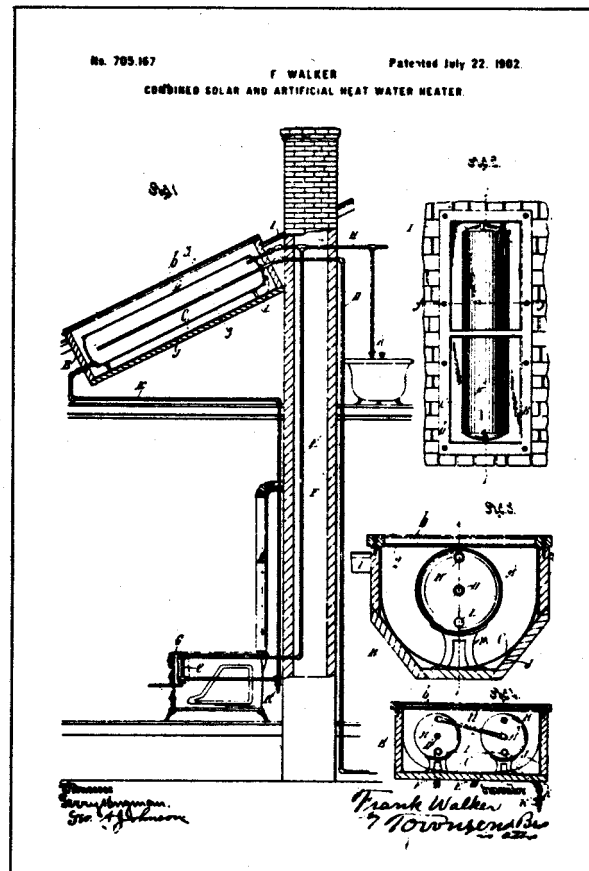

Walker Patent 1902

by permission Butti and Perlin

Further refinements

In 1904 Charles Haskell, by then the owner of rights to both the Walker and Climax patents, improved performance further by increasing the glazing area in relation to the water tank volume. This yielded a more rapid warm-up in the morning and hotter water on partly cloudy days. The "Improved Climax" featured a shallow rectangular tank rather than the traditional cylindrical tanks. This rectangular tank sat in the glass covered box on the roof. Support for the tank was provided by vertical metal "z's", which also impeded water flow through the system to insure more thorough heating. Cold feed water was released through a perforated pipe at the bottom of the tank and rose by steps to the perforated outlet pipe at the top of the tank.

Haskell Patent 1907

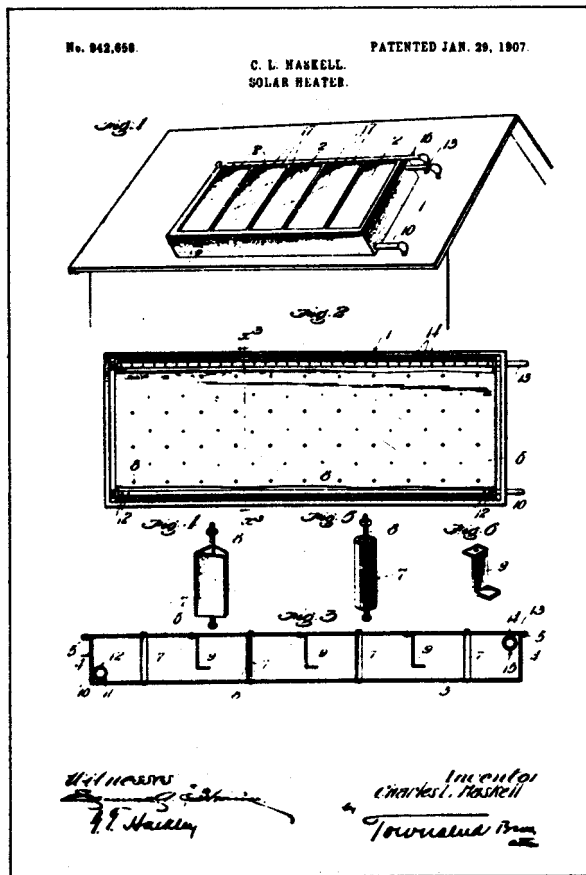

by permission Batti and Perlin

Like the Climax and Walker models the "Improved Climax" was probably linked to a backup wood, gas, or oil water heating system in most installations.

In 1909 Haskell's Improved Climax water heater met its match in the "Day and Night" solar water heater developed by William J. Bailey. This was a thermosiphon system, which reduced nighttime cool down by using separate collection and storage areas for solar energy. As events later showed, a thermosiphon system is not the only means for retarding night cool down; but the Climax heater manufacturers failed to develop this competitive feature in their integral passive heaters. They lost more and more sales to the new thermosiphon system until they were out of the market.

In 1936, F.A. Brooks conducted a series of tests at the University of California Agricultural Experiment Station in Berkeley on different types of solar water heaters including two types of integral passive solar water heaters. The most basic heater, an exposed bare tank, was found to work best if sloped vertically. As he reported, "Simple, bare water boilers mounted outdoors where they will not be shaded have long been used during the summer for furnishing late afternoon hot showers ... These exposed tanks cool nearly to air temperature at night and are useless before noon."

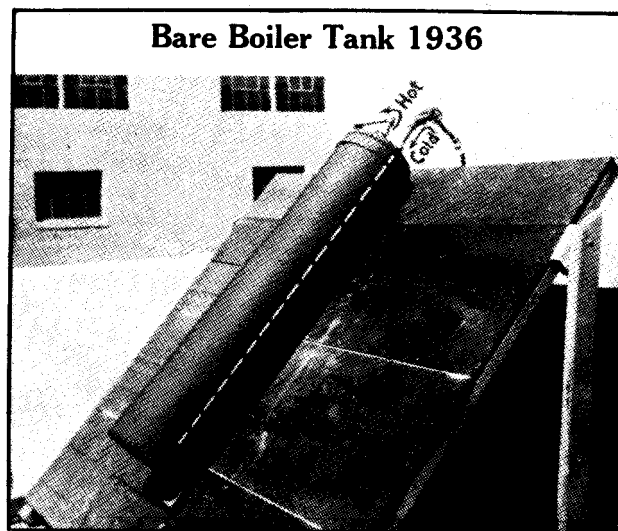

Much more satisfactory results were obtained in Brooks' experiments using several tanks enclosed in an insulated glass covered box. He found that "a large supply of water above 120°F (49°C) can be obtained in the afternoon. This system might be used for general domestic hot water if the clothes can be washed in the late afternoon when the water is hottest. During the night the water cools off so rapidly that morning temperatures are too low for clothes washing, though it yet might serve for all other needs."

The three tank IPSWH that Brooks tested is shown along with its performance for two days in September, 1935. He reported that temperatures of over 140°F (60C) were obtainable on summer afternoons with morning temperatures of around 100°F (38°C). His conclusion was that "This system has, however, the advantage of simplicity, high daytime efficiency, and self storage, and is non-freezing in most of the agricultural areas of California."

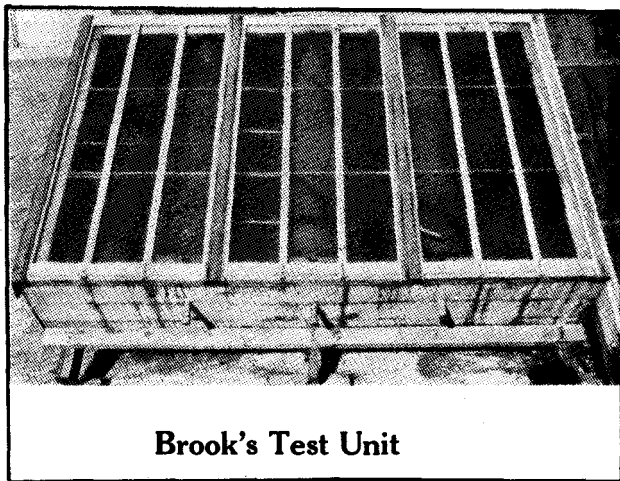
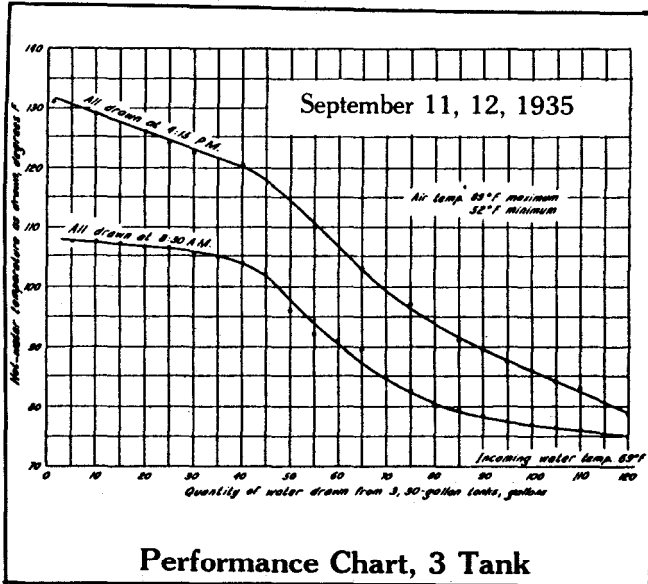

Brooks also did some comparisons of different configurations of plumbing the tanks. He found that if the cold water was routed into the outside tanks and drawn from the center tank, the center tank stayed warm even if 30 gallons (114 l) were drawn at night. He thought this configuration would be advantageous with frequent daytime use of hot water.

His tests also included an evaluation of the use of curved polished reflectors under the tanks to focus all the

incident radiation onto the tanks. He found that the reflectors offered no improvement over simply painting everything black, both methods collecting 724 BTU per sq ft (8 million joule per sq m) on the September days tested. This represents an efficiency of 70 to 75 percent according to his calculations.

Brooks also studied the cost of the various solar systems tested, including a flat plate, pipe absorber, three-tank IPSWH, and single tank exposed heater. He found the exposed IPSWH made with a second hand tank offered heating for a negligible cost. The three tank IPSWH was calculated to cost about 60 cents per gallon of storage and to deliver hot water at 1/25 cent per gallon (1936 prices).

This was a bargain compared to a homebuilt pipe coil system costing \$3 per gallon of capacity and delivering hot water at 1/9 cent per gallon. Assuming 1,000 BTU per gallon as consumed for heating, this translates to a fuel cost of about 11 cents per therm (100,000 BTU), about the price of natural gas at that time.

The final cost evaluation was done on a commercial solar system costing \$5 per gallon, installed. This was calculated to provide solar heat at a cost of about 1/6 cent per gallon, or an equivalent cost of 6 mills per kwh.

Brooks's work was apparently the last passive solar water heater study in the U.S. until the 1970's. Discoveries of natural gas and oil fields and intensive promotion and subsidies for these energy sources virtually eliminated the American solar market. The thriving California solar industry was virtually dead by 1930 and although it enjoyed considerable success when transplanted to Florida, with 60,000 systems installed by 1941, it was on its way out. A freeze on copper halted production during the war and although a brief resurgence was made in the postwar years it was doomed by cheap electricity available from the federally subsidized utilities.

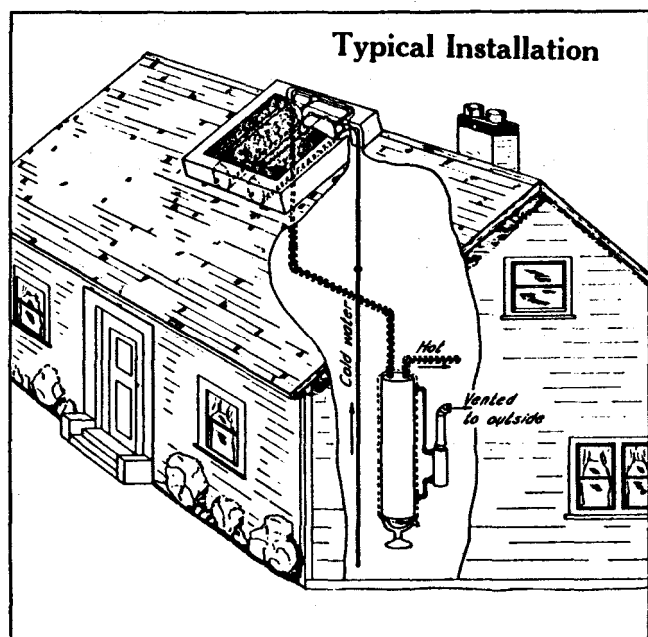

Renewed Interest Abroad

The IPSWH next emerged in Japan. High energy prices, reasonably good sun, and a very frugal society were factors which led to widespread use of simple non-pressurized, often unglazed IPSWH's. Still used today, these are typically rectangular plastic bags holding 40 to 50 gallons (150 to 190 l) which are filled in the morning and then provide hot water for evening use. Hundreds of thousands of these "solar pillows" have been successfully used for many years. A similar model, with a simple tray instead of bags, has also been used. With increased affluence and better utility networks, demand for these simplest solar heaters has dropped while demand for more expensive IPSWH's, thermosiphon, and active solar systems has increased.

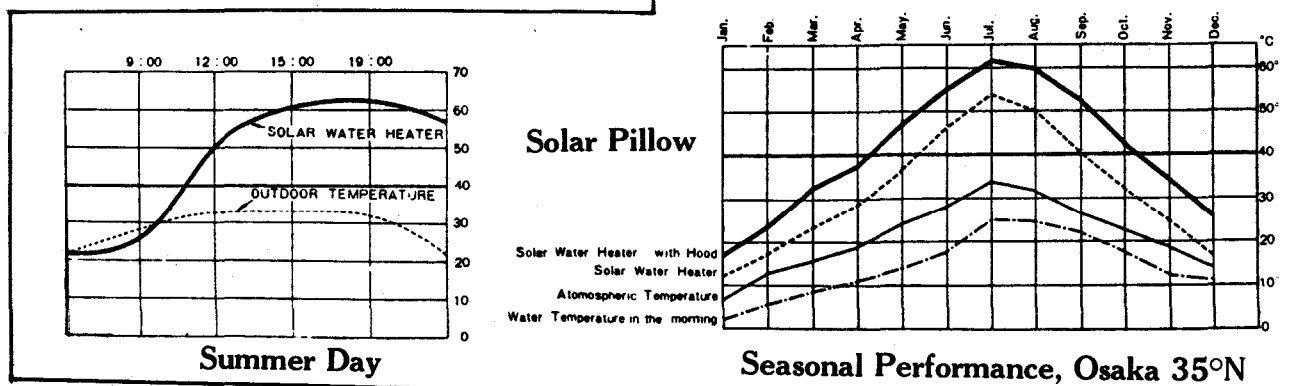
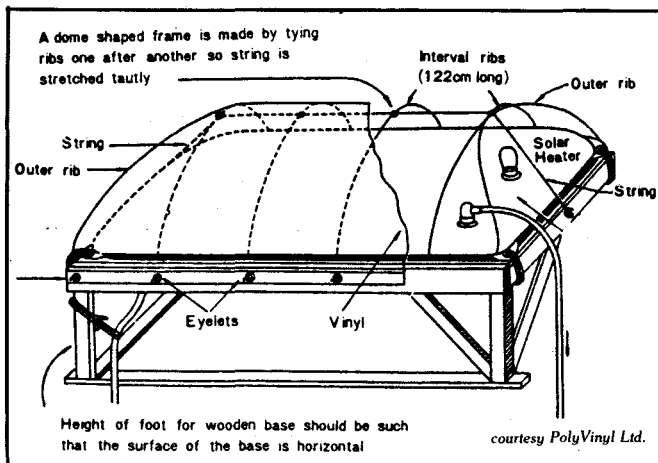

One of the common modern IPSWH's in Japan is the pipe type IPSWH. This type of heater has been in production for many years and tens. of thousands of them have been installed in Japan and other Asian countries. The Hitachi Hi Heater is a typical pipe heater. It uses six polyethylene pipes, holding 44 gallons (167 l) as the collector/storage in a 3.75 x 8 ft (114 x 224 cm) insulated steel box with polycarbonate glazing. The one third inch (.8 cm) Styrofoam insulation is covered with aluminum foil, which also helps direct the sun to the back of the cylinders. The heater cost about \$400 in 1976.

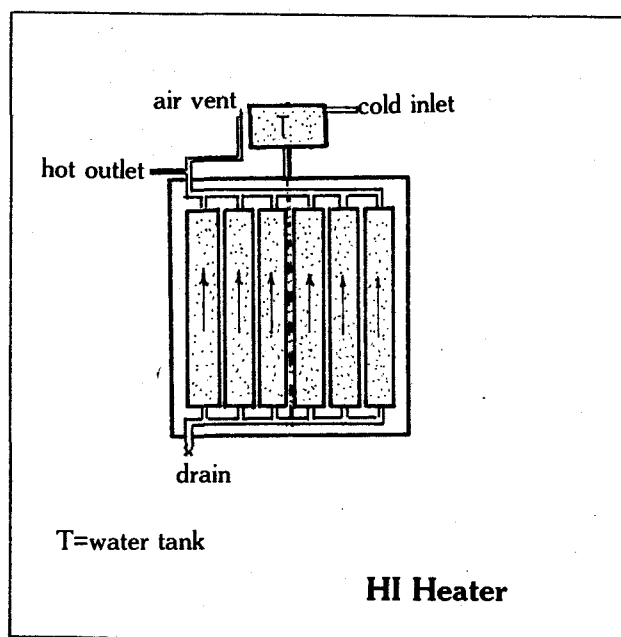
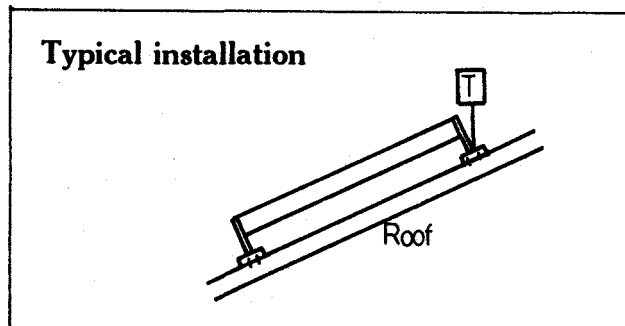

South Africa's high energy prices and favorable climate have stimulated considerable activity in IPSWH's. In addition to many home built systems there are several commercial manufacturers. The most common model is known as the "solar shell." It has a lens shaped 26 gallon (100 l) stainless steel tank with an 8.7 square foot (.81 sq m) Perspex cover. This cost about 260 rand (300 rand installed) in 1978, and provides hot water at a cost of .04 rand per kwh over its ten year life.

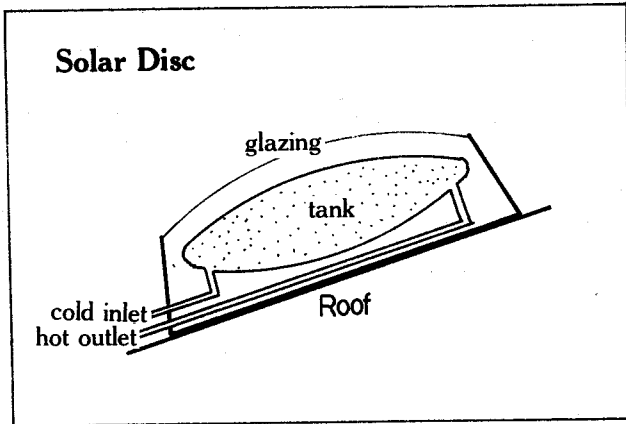

The small African country of Lesotho has also been the scene of IPSWH activity. The Lehco-op Production Systems group in Maseru introduced a simple IPSWH in 1976. It has worked very well and over a dozen had been installed in 1978. It uses a box shaped galvanized iron tank holding 17 gallons (63 l) set in a pine box with 9 sq ft (.84 sq m) of collection area, either glass or fiberglass. These units cost 60 rand (75 rand installed) in 1978. The energy cost equivalent over their life was calculated as .023 rand per kwh.

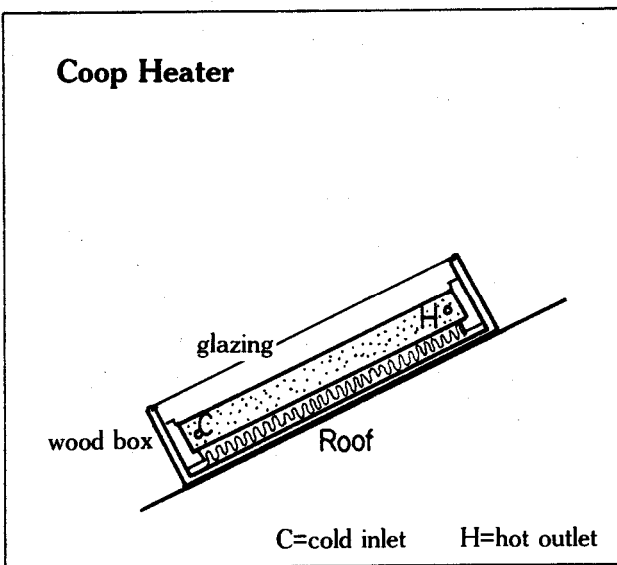

Australia also has been the scene of IPSWH activity. The long hot summer and isolated ranches without mains power make conditions ideal for IPSWH's. The "Suntrap" uses a 10 gallon (38 l) copper tank set in an aluminum box with single glazing. It was introduced to the U.S. market in 1978, but had to be re-engineered to meet the higher demand for hot water here. It is now sold as the "SunFlow" water heater.

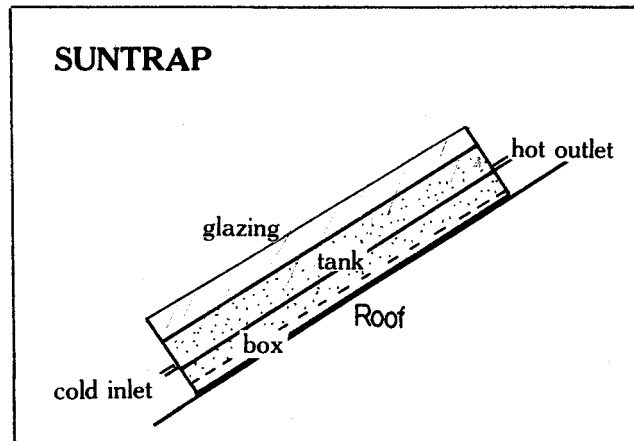

New Zealand is blessed with abundant and relatively inexpensive hydroelectric energy, but the low population density has left many outback areas without power. These isolated stations have provided much of the demand for the Sav Solar system. This IPSWH uses double glazing around the 10 gallon (38 l) tank with a large reflector behind.

In tests conducted during the winter of 1974 this cylindrical tank system was compared to a thermosiphon flat plate system. The Sav Solar was found to save 5.1 kwh per year per \$NZ invested versus only 3.5 kwh for the flat plate system. In 1979 the Sav Solar was introduced to the American market.

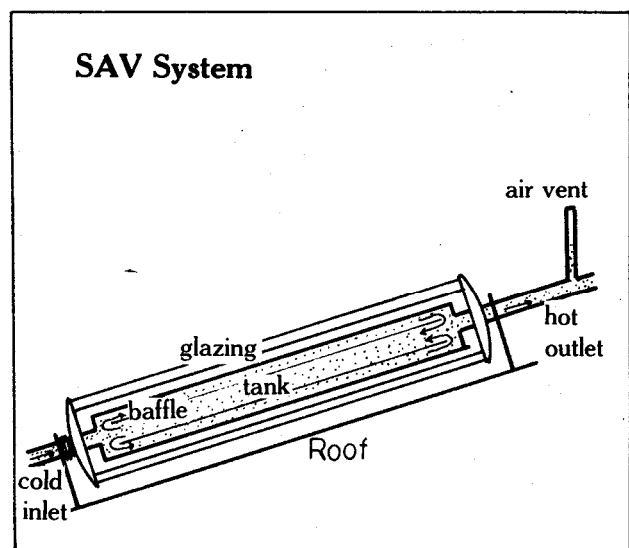

Rediscovered

American interest in IPSWH's was kindled by the Arab oil embargo of 1973. This "Energy Crisis" stimulated work on solar applications of all kinds. Steve Baer of Albuquerque, New Mexico has been one of the most influential innovators in passive solar design and has conducted a variety of experiments with simple IPSWH's. He developed what probably represents the most critical advance in IPSWH design—the addition of insulated, reflective shutters to reduce nighttime heat loss and maintain higher temperatures through the night. This not only eliminated the major drawback of the IPSWH but it also reduced freeze potential, thus greatly extending the range of climates where IPSWH's could be used year round.

On a visit to Albuquerque in 1974, Jon Hammond, a friend and fellow passive solar enthusiast, noticed the similarity between Baer's IPSWH and a breadbox and coined a new name. By 1975 Baer was offering plans for his Breadbox Water Heater and they began to be built around the U.S.

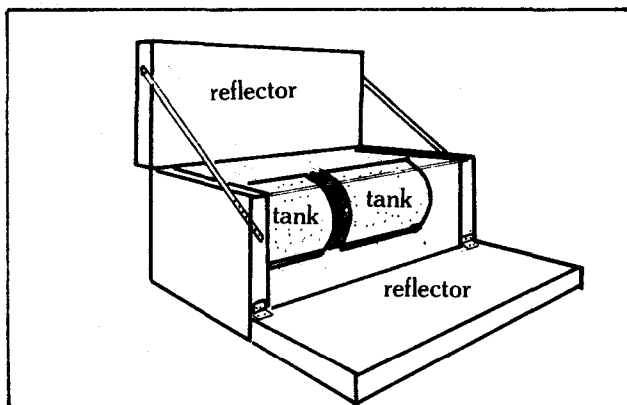

THE BREADBOX WATER HEATER CONSISTS OF 2 HORIZONTAL TANKS IN A DOUBLE-GLAZED BOX WHOSE LID & FRONT OPEN AS REFLECTORS DURING THE DAY & CLOSE AS INSULATION AT NIGHT. IT CAN SIT ON A ROOF; PLANS INCLUDE A REMOTE-CONTROL DEVICE.

ZOMEWORKS

P.O. BOX 712, ALBUQUERQUE, NM 87103 • (505)242-5354.

Jon Hammond carried word of Baer's work back to Davis, California and his Living Systems solar design group. The discussion of it with Professor Emeritus Dr. Loren Neubauer, another Living Systems associate, led to the rediscovery of Brooks' excellent work and generated considerable IPSWH activity in Davis.

The most widely known and photographed IPSWH from this time was built by Marshall Hunt in 1976. It included six mobile home water heater tanks set in two insulated boxes. It has been featured in Sunset magazine, Village Homes' Solar House Designs, the First Passive Solar Catalog, and many others. It has also been seen by the thousands of visitors to the innovative Village Homes solar subdivision in Davis.



Several other reports on IPSWH appeared in 1976 including work by: Horace McCracken, on a horizontal tank (unlidded) system; Ted Lucas, on a similar system; and a one tank vertical sloped system developed by Dihn Kanh. These all helped fuel the revived interest in IPSWH's.

In 1977 considerable work on IPSWH's was undertaken. These included two studies done in Davis, California by Bainbridge, Neubauer, Maeda, Melzer, Starr, et. al., which led to further refinements in design including revised plumbing, a better understanding of glazing to volume ratios, and improved seasonal estimates of performance. These results were reported in 1978 along with several other studies on IPSWH's. One of the most interesting reports was prepared by the Union Electric Company in Missouri; it marked the first utility interest in IPSWH's. By 1980 Union Electric has distributed 2,500 sets of IPSWH plans to forty states.

Activity has increased steadily every year with more plan sets, new research, and fresh ideas. Some of the more significant entries to the U.S. market in recent years are the Sav Solar in 1979, the Sun Wizard in 1980, and an IPSWH manufactured by Standard Oil of California in 1981. Other noteworthy events have been the development of an automated insulating system in 1980, and the preparation of "How to Get Started in the IPSWH Business" by the State of California Solar Business Office in 1981.

The future is very bright for this solar market and a great deal of activity can be expected in the years to come. The optimum design for mass marketing in different climates will undoubtedly evolve thanks to the very attractive economics of the IPSWH. It is the author's hope that this book will contribute to the advancement of this exciting field by stimulating greater activity, more research, and more innovation.

Chapter 3: The Basics of Design: Principles

While almost anyone can build a working IPSWH without an understanding of the scientific principles involved, a knowledge of the physics of the system will contribute to the final product. (You may wish to skip this chapter for now but return to it before beginning your heater design.)

The success of an IPSWH depends on its ability to collect and store solar energy. This chapter is therefore about the nature of energy transfer and how it relates to choice of materials and other aspects of IPSWH design in order to make collection and storage as efficient as possible.

Energy can travel by radiation, conduction or convection. Of these three, radiation, and in particular solar radiation and the nature of radiant heat transfer, is the dominant factor in IPSWH design.

Radiation

Any object at a temperature greater than absolute zero (-273°C) emits radiation with the wavelength and intensity dependent on temperature. Radiation flows from a warmer object to a cooler object. This would ultimately result in thermal equilibrium if no other energy were added to or taken away from the objects. Radiation is emitted by the sun, from the earth, and from your solar water heater. Shortwave radiation from the sun is collected by your IPSWH for heating. Longwave (thermal) radiation to space-emitted from your IPSWH to the cold night sky, for example-is responsible for much unwanted cooling. Both types of radiation are therefore important in IPSWH design. The graph below shows the ideal curves of radiation emitted from the sun and earth.

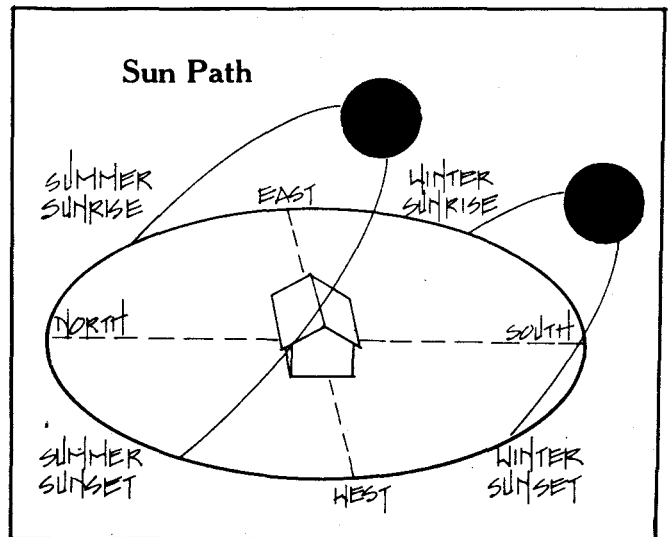
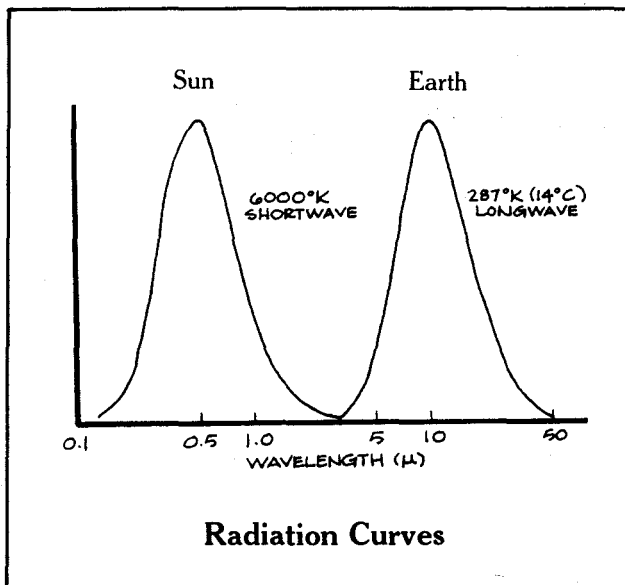

The sun's path across the sky determines the amount of solar radiation reaching the earth's atmosphere-and therefore varies with the seasons and with different locations on earth. The sun's position is described by its elevation above the horizon, altitude, and by its bearing from the true north, azimuth. The change in elevation and azimuth over the season is critically important in IPSWH design. At 40° north latitude the sun is at an altitude of 30° at noon on December 21 and almost 70° during the summer. In summer it traverses an arc of 240° from east to west while in winter it covers only 120° .

Not all of the radiation striking the edge of the earth's atmosphere reaches the surface of the earth. The reduction in energy is primarily due to reflection and absorptions by carbon dioxide and water vapor in the atmosphere. The actual amount of direct radiation received varies with the atmospheric content, cloudiness, and the solar angles (which determine path length). On the average, 31 percent of the solar radiation to the atmosphere reaches the earth's surface as direct radiation. The radiation that reaches the earth after reflection or refraction in the atmosphere is known as diffuse radiation. Again, the amount received will vary with the atmospheric content, cloudiness, and solar angles. On the average about 22 percent of the solar radiation to the atmosphere reaches the earth as diffuse radiation.

The total of the diffuse and direct components of solar radiation reaching the ground is known as the global radiation. (The remaining 47 percent of solar radiation is absorbed by particles in the atmosphere or reflected off them back into space.) On a cloudy day little direct radiation may be received and diffuse radiation may account for almost all of the energy reaching the earth's surface. Diffuse radiation is often assumed for simplicity to be uniformly distributed over the sky, but the intensity is in fact usually much stronger near the sun.

The available solar radiation for the U.S. and the world is shown in the accompanying maps. The actual amount received at your site may vary considerably because of local microclimatic effects and local obstructions. The determination of available sunshine is described in more detail in Chapter 4.

Available Solar Energy

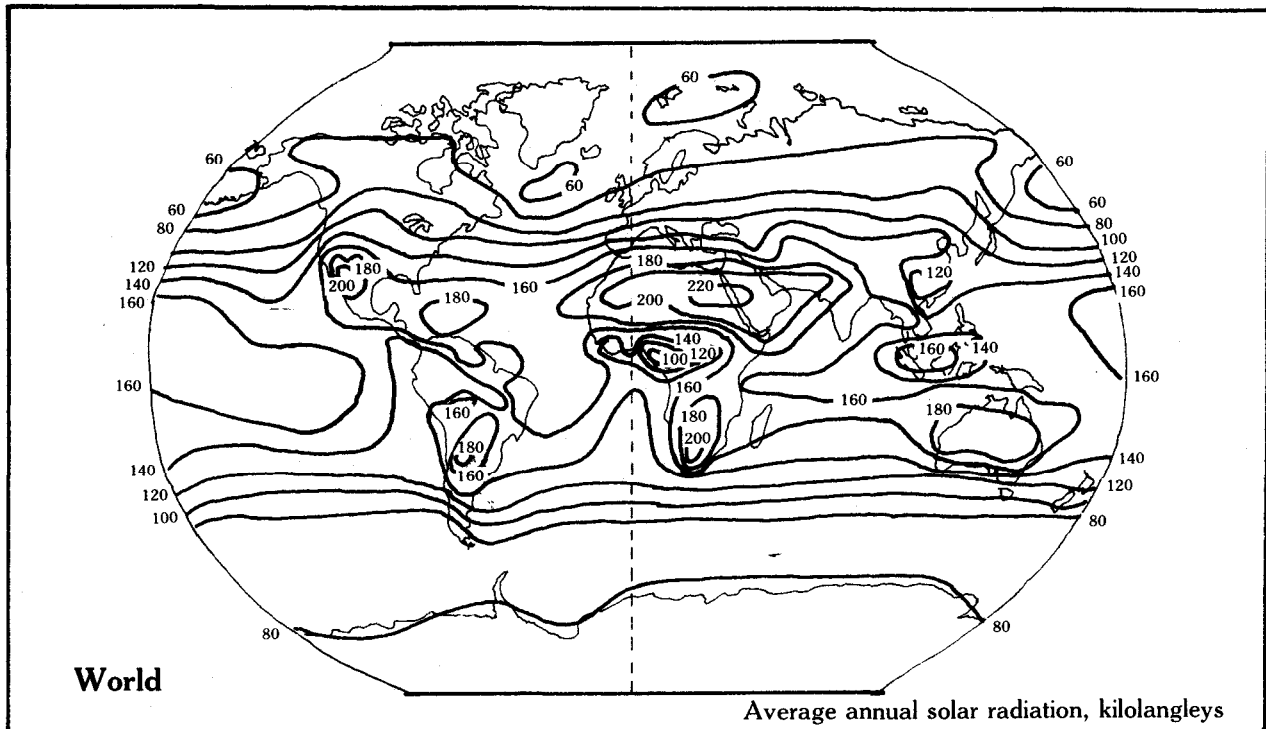
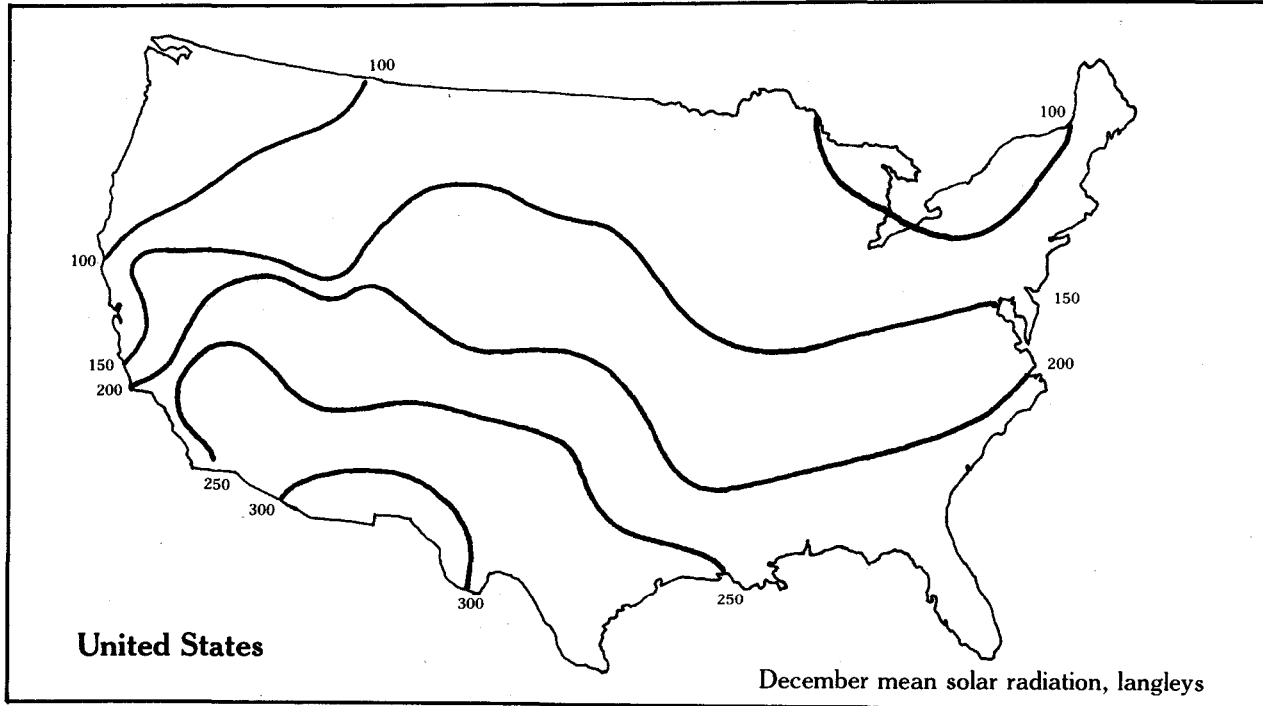

Radiation at wavelengths longer than 3 microns is referred to as thermal radiation. This is an important element of IPSWH design as it covers much of the energy exchange within a collector and unwanted radiant cooling of the collector. In addition to the shortwave radiation received directly or indirectly from the sun, the earth also receives thermal radiation from the water and gas molecules and dust particles in the atmosphere. The difference between the total radiation received, and that radiated back from the earth into space is referred to as the net outgoing radiation when more is radiated from the earth than to the earth. This net outgoing radiation is thermal radiation, primarily at wavelengths between 6 and 15 microns.

Maximum net outgoing radiation will occur to a cold, clear night sky. In Blue Hill, Massachusetts F.A. Brooks compiled a table of variation in net outgoing radiation to the cold night sky as a function of the zenith angle. He found that the greatest radiation loss occurs directly overhead (the zenith) and that the rate was high down to about 20 degrees above the horizon.

Clouds can greatly reduce net outgoing radiation to the night sky because they emit thermal radiation to the earth from the atmosphere and thus increase the total radiation received. The exact effect depends on the height of the clouds, their density, and temperature. This blocking of outgoing radiation by clouds can help reduce the night radiation loss from an uncontrolled IPSWH, i.e., one without some form of glazing control.

Trees, walls and other structures can also significantly decrease night sky cooling. The reduction in radiative loss depends on the configuration of the obstruction and on its placement. Unfortunately, most objects which will reduce radiative loss will also block incoming sunlight unless they are movable and operate only at night.

Materials vary in their ability to emit radiation. The emittance of materials is important in IPSWH design because outgoing radiation loss from the IPSWH can be reduced by choosing materials which emit little radiation. Materials that collect energy effectively yet emit little energy are known as selective surfaces. The table below presents the emittance (relative to a 100% "perfect" emitter) for various materials that may be used in an IPSWH.

Material	Emittance (%)
White paint	95
White enamel on galvanized iron	90
Black paint on aluminum	88
Black lacquer	82
Galvanized iron (oxidized)	28
Galvanized iron (new)	13
Nickel black on galvanized iron	12
Cupric oxide on sheet aluminum	11
Selective surface foil	10
Aluminum foil	8

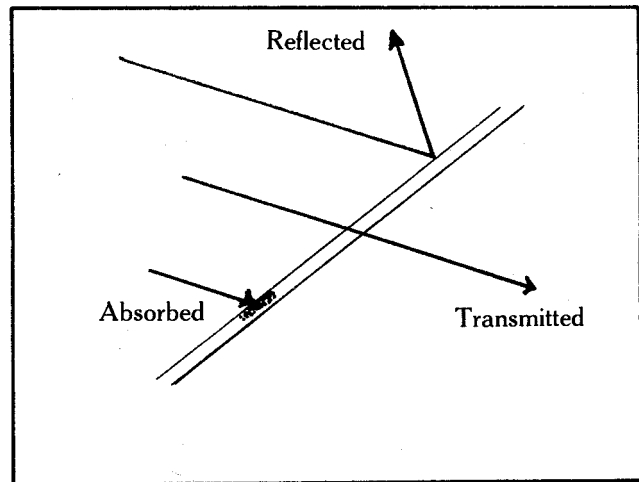

When radiation strikes a surface, it can be either absorbed, transmitted, or reflected. If it stays in the material it is absorbed; if it passes through the material it is transmitted, and if it bounces off the material it is reflected. The properties of various materials may be quite different and materials must be chosen to ensure that desired performance is achieved. For example, the collector should maximize absorption; the glazing should maximize transmission of incoming radiation yet minimize transmission of outgoing radiation; and the whole assembly should minimize unwanted reflection.

Radiation striking an object is absorbed if the energy is retained by the material. For example, a black hose left in the sun heats up as it absorbs energy from the sun. The percentage of incoming radiation that is absorbed by a material is referred to as its absorptance and is a measure of the ease with which a material or surface collects energy. The table below presents absorptance for various materials in sunlight:

Material	Absorptance (%)
Flat black paint	96
Selective Surface foil	95
Black tar paper	93
Very dirty galvanized iron	91
Galvanized steel	65
Shiny aluminum	26

The high absorptance and low cost of black paint makes it a good choice for IPSWH's. The selective surface foils are also good candidates for IPSWH use, particularly if no lids will be used. Ideally we would like a material with high absorptance and very low emittance. Some of the new selective surface foils look quite attractive in this regard, particularly for IPSWH's without movable insulation. Stickney and Nagy found use of a selective surface foil could reduce night heat loss 30 percent and increase daytime gain 25 percent.

Radiation passing through glazing material is said to be transmitted. Transmittance varies not only for different materials but also varies with the wavelength of the radiation. It is therefore desirable to know the spectral transmittance of glazing for passive solar water heating systems. Ideally, the glazing should be very transparent to incoming shortwave radiation but opaque to outgoing long wave (thermal) radiation, because radiant losses may account for over 70 percent of collector heat loss. Typical spectral transmission curves are shown below for common glazing materials. New materials such as "Heat Mirror™" are designed to allow shortwave radiation in, yet prevent thermal radiation from escaping. Some of these materials allow 90 percent of the radiation in (as good as glass) yet reflect 90 percent of the thermal radiation that is trying to escape. These materials are very attractive for IPSWH glazing.

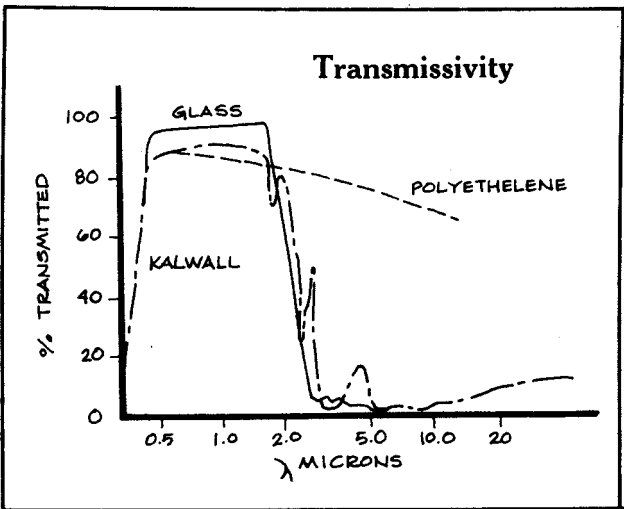

The index of refraction of the material will affect the manner in which the radiation is transmitted. The index of refraction determines how much incoming radiation entering the material at an acute angle will be transmitted directly through and how much of it will be refracted (i.e., deflected from a straight path). A prism provides a good example of refraction-it separates sunlight into the different wavelengths and gives the familiar rainbow. Glass has a lower index of refraction than plastic and hence is typically better at transmitting radiation entering at acute angles. However, the ease of molding and shaping plastic into complex shapes can offset this deficiency.

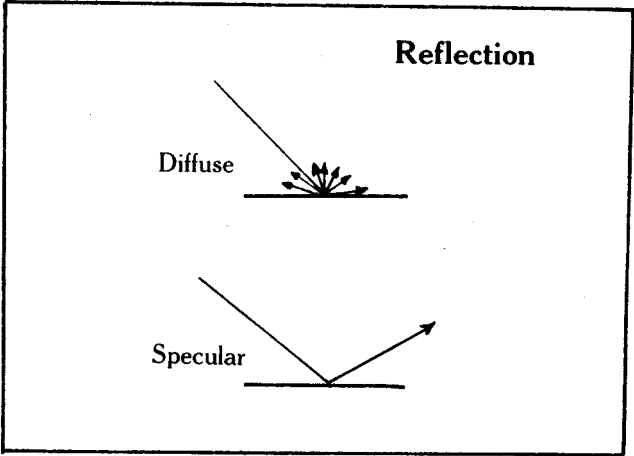
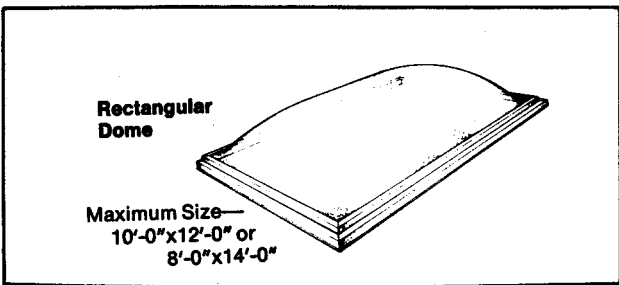

Reflection occurs when radiation bounces off a surface. Reflection can be specular or diffuse. A mirror exhibits specular reflection while white paint exhibits diffuse reflection. The term reflectance describes the ability of a given surface to reflect radiation. The reflectance of a surface is generally given as the percentage of incoming (incident) radiation which is reflected. Reflectance for a given surface also varies with the wavelength of the incident radiation. The reflectance of a material can also be described for both specular and diffuse radiation.

To ensure maximum collection of solar radiation, the design of an IPSWH should minimize unwanted reflection. However, a carefully designed reflector-or a natural reflector such as a snowfield-can be used to increase the solar radiation received.

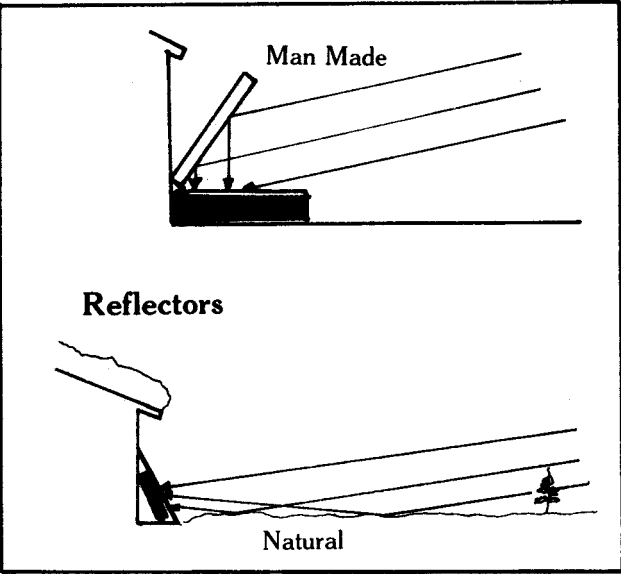

The following table gives the diffuse reflectance of various surfaces in visible wavelengths. These figures can help you determine how much solar energy will be received at the IPSWH. Reflectance can be especially important for an IPSWH built into a south wall or greenhouse in colder climates (receiving less direct radiation due to the short days and low angle of the winter sun) as the solar radiation received can be increased by using either natural or artificial reflectors.

Surface	Diffuse reflectance (as percent of incident radiation)
Fresh snow	75-95
White paint	57-90
Old snow	40-70
Concrete	40
Dark soil	7-10

Shiny surfaces such as aluminum foil demonstrate specular reflectance. The following table gives the reflectance for surfaces with high specular components, again for visible wavelengths. These can be used as exterior reflectors to increase the solar gain of an IPSWH. Use of interior reflectorized surfaces within the IPSWH collector may also be warranted with some designs. The key is whether more energy will be reflected out than gained by redirection. A well insulated box may do just as well if it is all black inside, as resulting thermal exchange will be primarily to the tanks.

Surface	Specular Reflectance (as percent of incident radiation)
Aluminum foil (new)	80-85
Mirror, silver backed	88
Mirror, mercury backed	80
Optical reflector, fresh	93

Adding the global and the reflected radiation gives us the total solar radiation received on the surface. This is particularly important for IPSWH's in the higher latitudes where a snowy surface south of a vertical, or near vertical, IPSWH may add 50 percent to the total solar radiation in the coldest month.

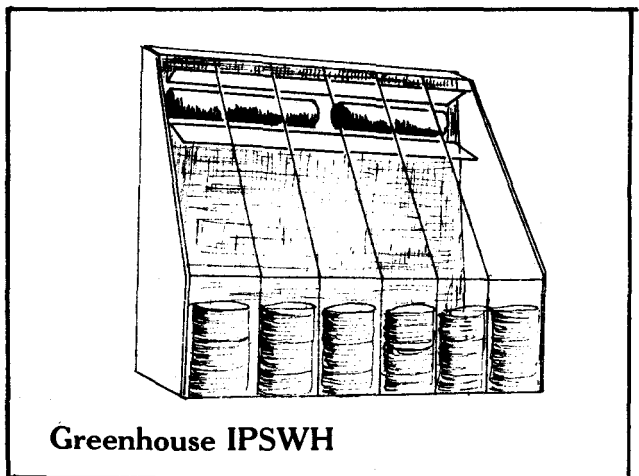
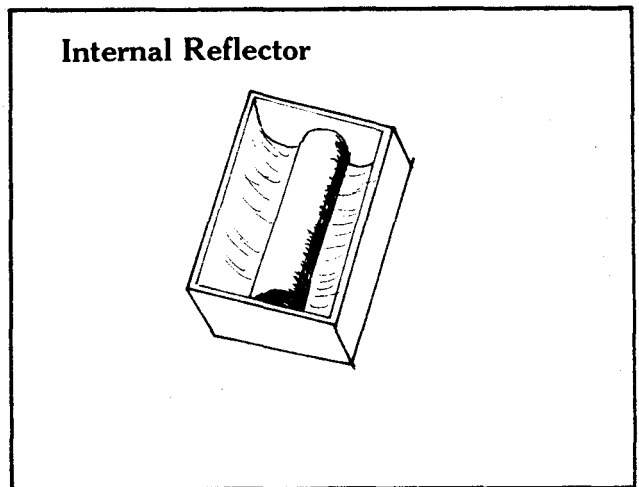
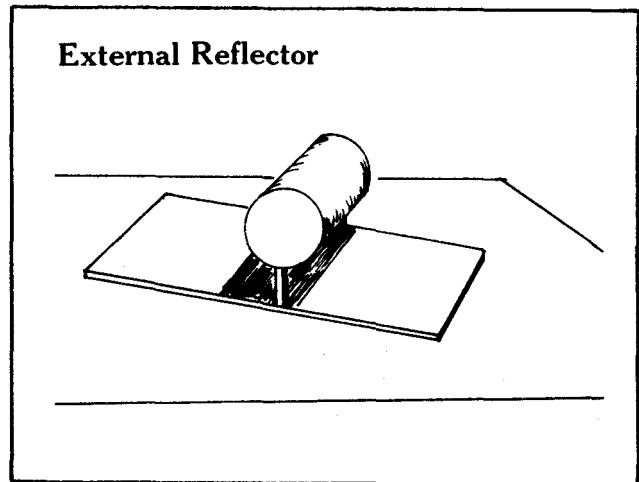

Conduction

Next in importance after radiation is conduction or the transfer of energy from molecule to molecule. Insulation reduces conductive heat transfer and is therefore an important consideration in the design and placement of the IPSWH. Insulation is described by its resistance to heat flow, or R value. Typical R values are shown below; the higher the R value the better the insulating value.

Material	R Value (BTU/hour/sq ft/°F)
Wood	1
Sawdust	2
Fiberglass batts	3
Polystyrene	4
Exp. Polyurethane	6

$R\ value = 5.7 \times RSI$

The insulating value of a material is also influenced by air films and the air flow across the material. A stable air film will increase resistance as much as 0.7 R on a vertical surface. If the air film is moving this increase may drop to 0.2 R.

Glazing can be a major source of heat loss for an IPSWH because even with double pane glass the R value may be only 1.8 including the air films. Some form of glazing control or insulated cover is desirable for an IPSWH in all but the warmest climates. These can be either automatic or manual and can operate either inside or outside the IPSWH.

Convection

Although less important than radiation and conduction, convection—the transfer of energy through air flow—can still be a factor in IPSWH design. This may be flow caused by local differences in density of air (cooler air is heavier) or weather patterns with characteristic winds. The convective flow of air in and out of an IPSWH is known as infiltration. It is affected by design of glazing, walls, framing joints, and movable insulation. Careful detailing, caulking, and sealing can minimize convective heat loss even in areas with consistently high winds.

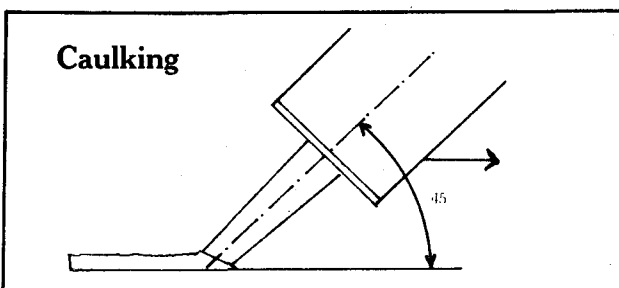

After the principles concerning energy collection, the next consideration in IPSWH design is energy storage the ability to store the absorbed energy in the form of heat. Fortunately, water is an excellent material for storing heat. It can store one BTU per pound per degree F of temperature rise ($4.18\ J\ per\ g\ per\ ^\circ K$). Thus the tanks of water provide thermal storage for the collected solar energy. There may also be some cases where a phase change material (pcm) could be incorporated in the IPSWH. These pcm's can store two to four times as much energy as water and might be used to keep operating temperatures at 120°F to 140°F ($49^\circ C\ to\ 60\ C$) during the day with extended high temperatures at night as the pcm gives up its stored energy. This would also increase collector efficiency by reducing daytime energy losses.

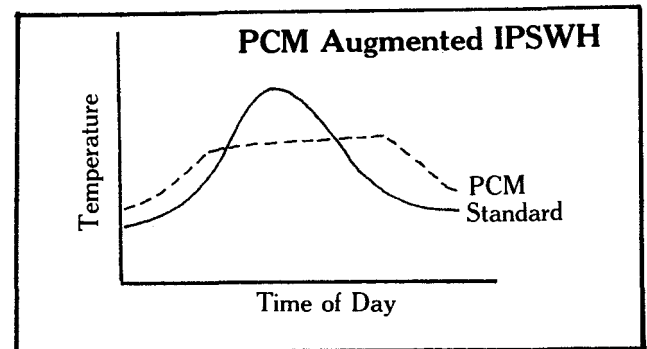

The understanding of these basic principles of radiation and radiative heat transfer, conduction and convection will help you design a better IPSWH. They should also help you make your home more energy efficient in general.

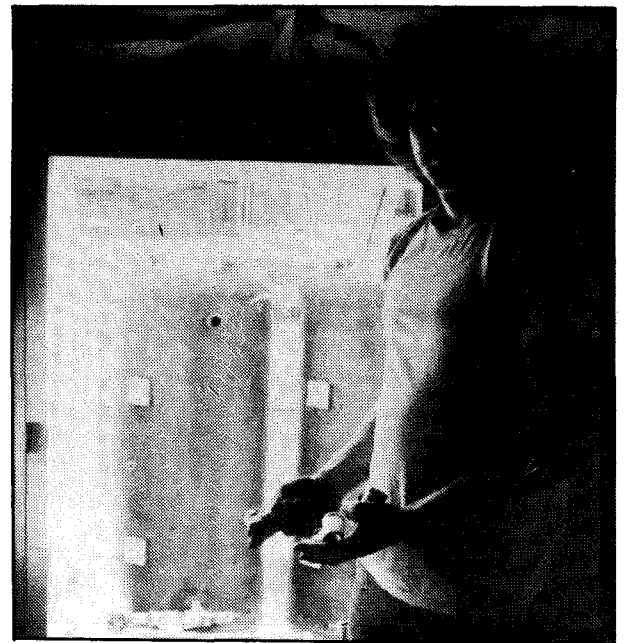

Chapter 4: IPSWH Design

The application of the principles described in Chapter 3 involves us in the practice of IPSWH design. The basic elements can be simply stated as six rules.

The Six Commandments of IPSWH Design

1. Place IPSWH in a sunny spot.
2. Make it an effective collector.
3. Ensure that it will retain heat.
4. Make it the right size.
5. Make efficient connection to the conserving backup system.
6. Build it to last.

If your design satisfies these six rules your IPSWH will work well and provide you with inexpensive solar heated water. The following pages explain more fully how these rules apply to the design of an IPSWH.

Rule 1: Place IPSWH in a Sunny Spot

Obviously a solar heater won't work very well unless it receives enough sun. Fortunately the sun's path is very predictable, and with only a modest investment of energy and time you can determine how sunny the possible locations for your IPSWH are. In addition to solar access you will have to consider the requirements for connection to your existing systems, so read the suggestions in Rule 5 before committing yourself to a particular IPSWH location.

There are two basic methods to determine how sunny a given location is—observation and calculation. Observation is the simpler method, but it requires much more time. Unless you are very patient, very familiar with your homestead, or a confirmed shutterbug with photos of the south side of your house during all seasons of the year, you may wish to use calculation. However, if you are planning to build your IPSWH only after you have completed other home improvements, you might find that observation is the easier and more accurate method.

The essence of the observation method is using photographs or sketches to chart shadow movement through the seasons. Pay particular attention on December 21, the winter solstice, when the shadows will be longest, and in the fall, when leaves are still on deciduous trees but the sun is lower in the sky. You should make note of shadows throughout the day as well. Probably the best approach would be to keep a record of sun and shadow patterns one weekend day every month for a year.

If you are unwilling to wait and wish to do your solar prospecting straight away, you can calculate your siting using a site evaluator, which indicates the sun's path throughout the year. You can either buy one or make your own. The two commercial models I am familiar

Solar Site Selector

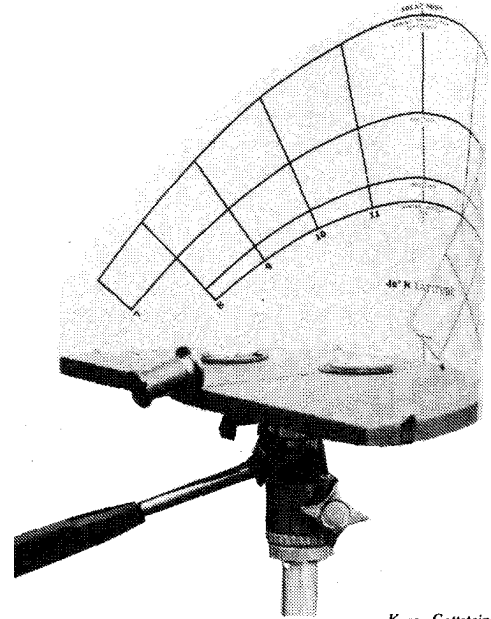

Karen Gottstein photo

with are both fairly easy to use, practical, and accurate. If you are a solar builder, or plan to become one, you might wish to purchase one.

The Solar Site Selector is available from:

Lewis and Associates 105
Rockwood Drive Grass
Valley, CA 95945 (916)
272-2077

The Solar Site Selector calculates solar exposure from sunpaths and hour segments superimposed on the panorama being studied. Shading patterns are also instantly determined. Correct siting and orientation can be rapidly determined. The site selector includes a base plate with bubble level, compensating compass, 180° distortion optic, and grids in 2° even latitudes. Threaded insert fits photographic tripods. Price in 1980, \$79.50.

The Solar Pathfinder is available from:

Solar Pathways, Inc.
3710 Highway 82
Glenwood Springs, CO
(303) 945-6503

The Solar Pathfinder is a patented manual recording site survey device which utilizes the reflected image off a transparent dome to display sunrise and sunset times, sunrise and sunset directions, interim shading patterns and half-hour energy values. Printed tracing sheets provide latitude-specific half-hour percentages of daily total radiation available at the site. Worksheets and data supplements are included. The work surface is small and requires careful plotting for best results. One quick tracing permanently records all data. Price in 1980, \$124.

If you are just planning to build one IPSWH or wish to be more self-reliant (or cheap) you can make your own site evaluator using the directions in Appendix 1.

In addition to determining how often the sun will shine on the IPSWH, you might like to estimate how much energy from this sun will reach your collector-accounting for local and area storms, clouds, and fog. The map of solar radiation shown in Chapter 3 will provide some idea of how much energy you can expect, but temper this with your own observations of local conditions-and the results of your site evaluation. For more detailed information you may wish to consult national, state, and local climate resource centers. The U.S. National Climate Center in the Federal Building, Asheville, NC 28801 and the National Solar Heating and Cooling Information Center, toll free 800-523-2929, are good places to start.

This climate information may modify your design. For example, if morning fog is common you might choose a more western exposure for your IPSWH. Alternatively, if your site is foggy or cloudy most of the winter, or shaded by a hill, you might decide to build a summer-only heater. And so on.

Once you have surveyed your homestead and selected the site and orientation for your IPSWH, you must make another decision that will affect how much sun reaches your IPSWH-the glazing orientation and slope. For a year round system the best glazing orientation is usually facing south and the most efficient glazing slope (angle from the horizontal) is equal to the latitude of the site. (The best slope puts the glazing at right angles to the sun's rays, and the angle of the sun varies with latitude.) For a heater used primarily during the summer, a shallower angle (i.e., closer to horizontal) is preferred and south orientation is not as important.

The effect of slightly varying these slope angles is not catastrophic, as shown in Table 4-1, and aesthetics may persuade you to accept a less than perfect orientation with slightly reduced performance. However, if you get too far off, it may not be a very worthwhile investment-and your money might be better spent doing something else to improve your home's energy efficiency.

Table 4-1: Performance Related to Slope (Tilt) and Orientation (from south = 0°)

Percent of Annual Maximum Performance, Boston, Massachusetts 42°2'N				
	Collector Orientation			
Collector Slope	0°	30°	60°	90°
Latitude -15°	99	97	91	83
Latitude	100	98	91	80
Latitude +15°	95	93	87	74
Vertical	61	60	55	46

Percent of Annual Maximum Performance, Miami, Florida 25°5'N							
	Collector Orientation						
Collector Slope	0°	30°	60°	90°	120°	150°	180°
Latitude -15°	98	98	96	94	92	90	89
Latitude	100	99	97	93	86	80	78
Latitude +15°	97	96	94	88	79	68	62
Vertical	53	53	51	45	29	--	--

Percent of Annual Maximum Performance, Los Angeles, California 34°N				
	Collector Orientation			
Collector Slope	0°	30°	60°	90°
Latitude -15°	97	96	92	87
Latitude	100	99	94	87
Latitude +15°	97	96	92	83
Vertical	58	58	55	47

Source: Winslow Fuller (1980) "No Taboos on East or West," *Solar Age*, December. Although these calculations were done for a flat plate system, they shouldn't be very far from what would be expected for a sophisticated IPSWH.

You can also use reflectors to increase solar gain. These can be either natural (bright south snow) or manmade (white, polished aluminum or mirrored panels, fixed or movable). You can probably double your gain with careful use of reflectors.

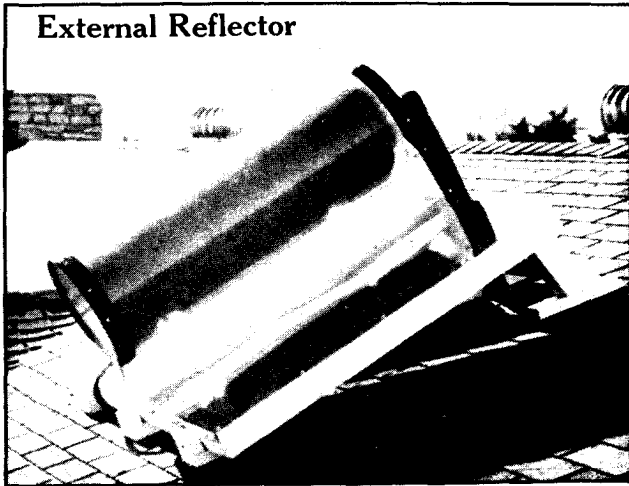

Keep in mind the weight of the completed heater when you choose a location for it. If you build a 90 gallon (341 l) heater it may weigh more than 600 lbs (272 kg) when full of water. A lightly built roof will require additional bracing to an interior bearing wall.

If no good location in the sun is available on your roof or backyard you may want to build a little platform in the sun for your IPSWH. Quite often this can be integrated with an air lock entrance or shelter for an entrance. Four 4 x 4 inch (10 x 10 cm) posts provide more than enough support for even a fairly large IPSWH.

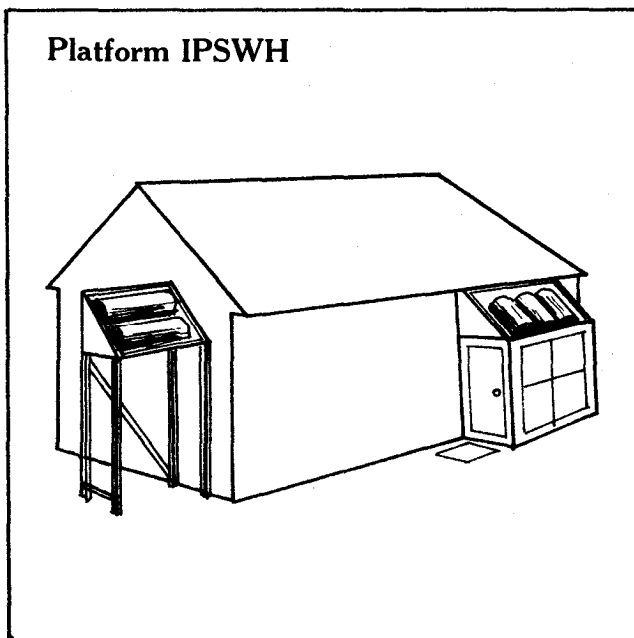

Rule 2: Make it an Efficient Collector

This might also be stated another way-"Paint it Black." As you will recall from Chapter 3 the absorptance of flat black paint is 96 percent, which is about all we can hope for. However, the emittance of black paint is unfortunately fairly high-which lowers the net gain. For those of you with a love of high technology or desire for better performance there is another option that can be considered-selective surfaces. The absorptance of the selective surface may be very close to that of black paint-but it will have much lower emittance.



Rule 3: Ensure That it Will Retain Heat

The most elemental IPSWH, a simple black can in the sun, will work well on a sunny warm day, and this simple design has been used effectively for many years. However, for convenience you may wish to have hot water on cooler days and at night. To do this you will have to ensure that your IPSWH will retain heat better.

The first step is to place your IPSWH in a tight, well insulated box with glazing on the south side to admit the sun's energy. Given this protection your IPSWH can provide hot water even on a very cool day. The level of insulation should be higher than for a house because the temperature difference between inside the heater and outside is much higher. An insulation value of R 25 is suggested for the box in colder climates-equivalent to a six inch wall with fiberglass and one inch of foam board.

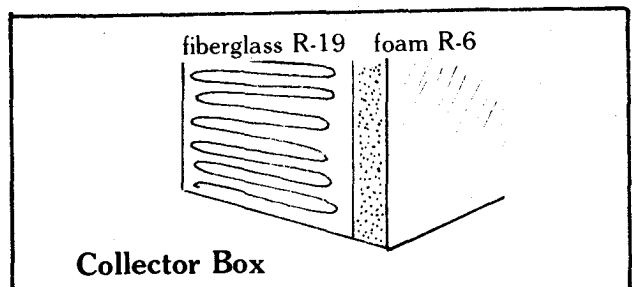

The loss back through the glazing can also become important when it is cool outside, and multiple glazing may be desirable. The accompanying map shows suggested layers of glazing for an IPSWH. In milder climates multiple glazings all around the tank may suffice, with no need for an insulated box; this would allow collection from more sun angles.

Horace McCracken has used another method to reduce these heat losses. He uses a thin layer of fiberglass insulation, with a transmittance of 85 percent, to improve the performance of the glazing assembly. He believes that savings outweigh the loss in transmission. This insulation might also be placed between glazing layers rather than right on the tank.



Angel Hair

A new glazing product will be available by the time you read this. "Heat Mirror™" is a specially developed plastic which is transparent to incoming short wave radiation but virtually opaque to thermal radiation. It can be used in the double glazing of an IPSWH. It will be extremely valuable in IPSWH design as it will make lids less important in marginally cool areas, and in cold areas it will make an IPSWH with lids perform better.

Glass is preferred for glazing in an IPSWH because it is very durable. Tempered glass is stronger and safer than regular glass, but more expensive. You may also wish to consider "solar" fiberglass, polycarbonate, or acrylic, because they are lighter, easier to cut and handle, and more resistant to damage. Their life times are generally shorter, however, and they are petroleum based products which can be expected to become more expensive in the future. Make sure the product you select can handle temperatures of 180° to 220°F (82°C to 93°C).

Seconds or used tempered glass can usually be found at reasonable prices, on the order of \$6 to \$15 for a single 46 x 76 inch (117 x 193 cm) pane and maybe \$40 to \$60 for the same in double pane. Patio doors are being upgraded by many people and the take outs are often cluttering up the retrofit shops.

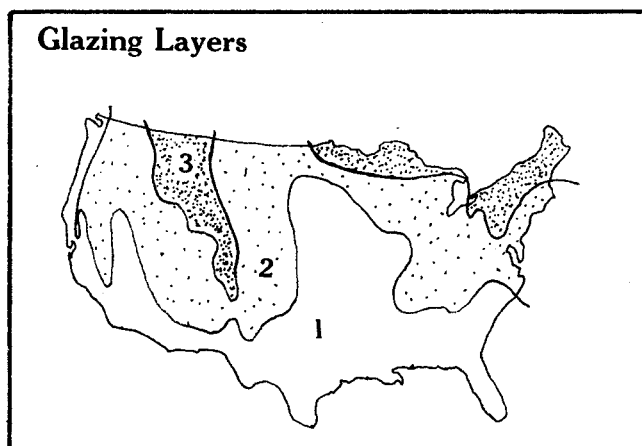

The well insulated box must be well sealed or all the hot air will leak out through the cracks. Caulk and seal all connections and joints with a high quality caulk. In areas that will get hot use a silicone caulk that won't break down under higher temperatures.

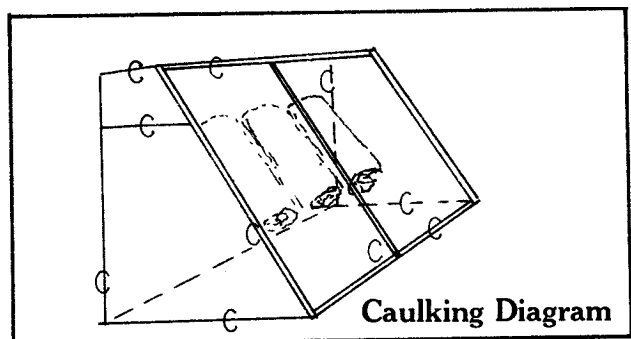

Your IPSWH with good insulation, tight seal, and multiple glazing will heat up well during the day but can still lose heat at night. This cooling off results primarily from radiation to space and conduction through the glazing. In mild climates or in summer these losses will be acceptable, but in cooler periods or where warmer water is desired in the morning the losses must be reduced.

Heat losses can best be reduced with some form of movable insulation—either inside the glazing, between the glazing, or outside. The easiest place to include this movable insulation is usually the inside—because there is no need to account for wind, rain, hail, ice or snow. This interior movable insulation can be either a drape of some kind, a series of slats or shutters, or a roll shade.

Some of the possible mechanisms for controlling shutters and shades include: heat motors; Freon transfer systems; automatic camper vent operators; electric trailer tongue jacks; air shock absorbers; bicycle pumps and bicycle tubes; hydraulic lifters; casement window operators; vent actuators; bicycle, car, and aircraft control cables; bicycle gears and hubs; rubber bands (rubber contracts as it warms up); photovoltaic motors; etc. Some of the possibilities are suggested in the accompanying diagrams.

Internal Shutter

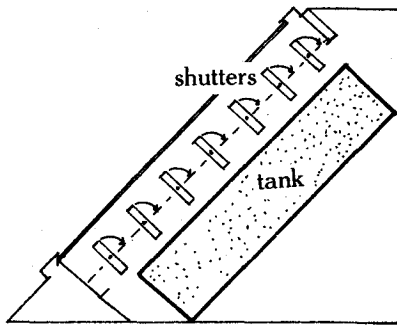

Internal Roll Shade

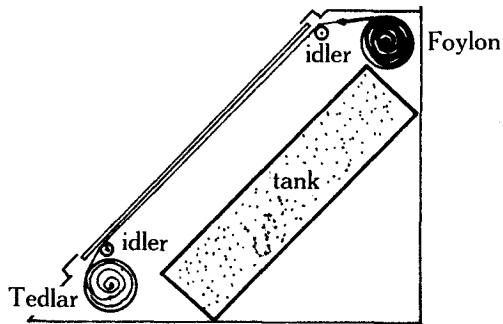

Internal Blanket

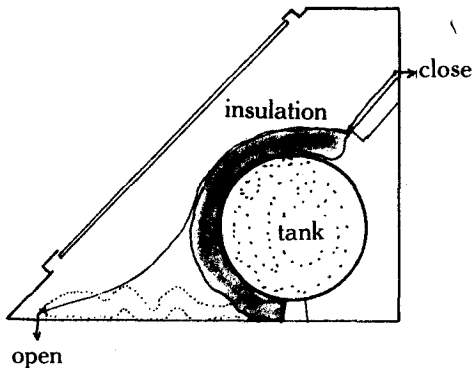

The two ends of the spectrum are a simple manual control, requiring little money or sophistication, but considerable force; and an automatic photovoltaic drive requiring very little energy but considerable expense and sophistication. The tradeoffs are always there, so consider the options before deciding. If you want to automate shutters and drapes throughout the house you might consider a home controller using signals in the **110v** lines to trigger operations.

Exterior movable insulation (insulated covers or shutters) can also be practical. They offer the advantage of increasing collector area if the inside of the lids are reflectorized. These covers will prove most practical where snow loads and high winds are less common. They can fold down, up, or to the side in a variety of ways. These exterior shutters can also be manual or automatic. Where access is difficult an automatic system might be preferred. For a readily accessible system a simple manual lid will prove workable.

The rigid forms are attractive insulation for these movable covers because of their strength and high thermal resistance. Build a strong wood or metal frame with aluminum or wood skins and provide plenty of hinge for strength. Use weatherstrip to get a tight seal when it's closed.

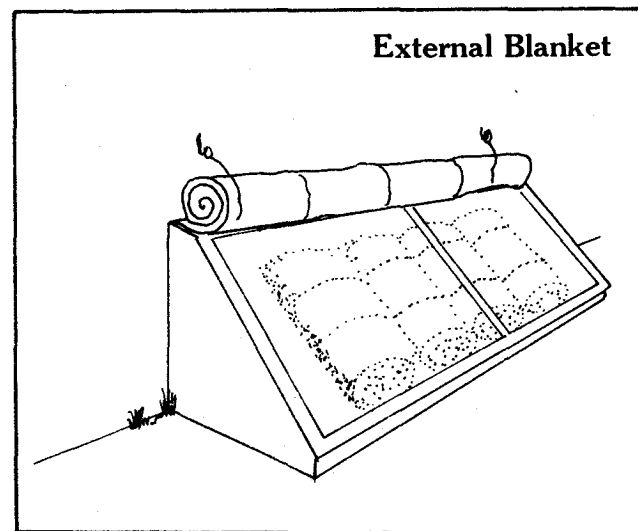
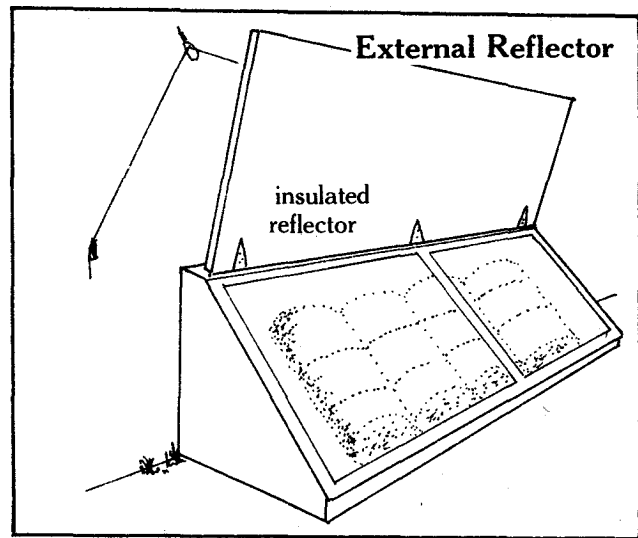

Insulation between the glazing may also become more common as commercial systems are developed. You might also build your own although this will be more challenging. Venetian type blinds and interlocking slats have been available for many years in Europe and Israel and might provide some good ideas on how to do this type of insulation.

The "Bead Wall™" developed by Steve Baer is another method of insulation between glazing layers. His system uses blowers to move Styrofoam beads between glazing for insulation at night and then blows them out to storage in the morning. Paul Shippee at Colorado Sunworks has used this system on IPSWH's. Contact Steve Baer at Zomeworks, P.O. Box 712, Albuquerque, NM 87103 for information on "Bead Wall."

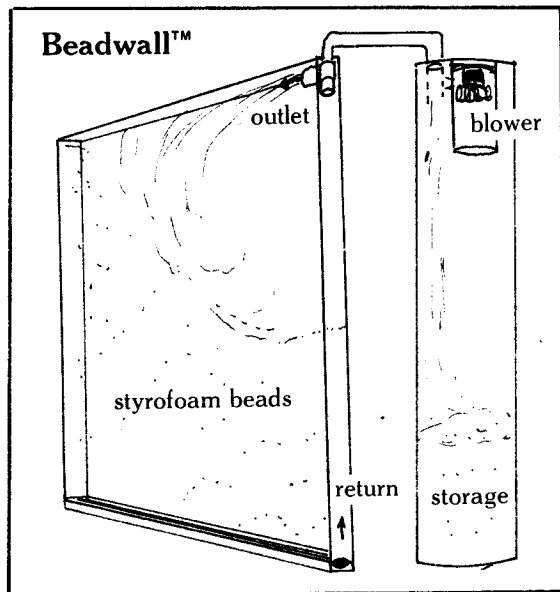

A second approach to reduce heat loss is to locate the IPSWH in a greenhouse or in the house itself. This not only reduces the heat loss during the day and at night, but at night would also benefit from the movable insulation system (e.g., insulated shutters) provided for the greenhouse or house glazing. Steve Baer has also designed IPSWH's with the tank in a skylight assembly for preheating only.

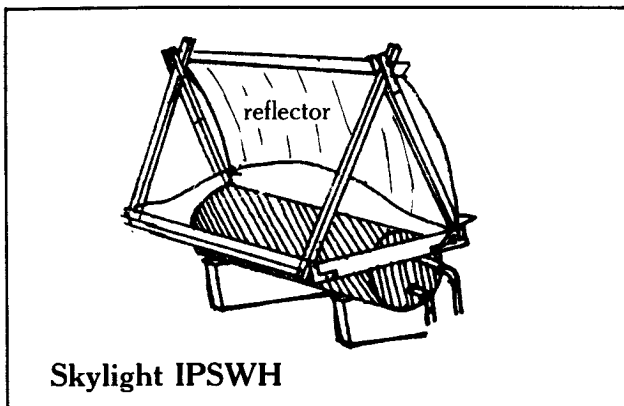

Another interesting way to reduce heat losses has been developed by Conrad Heesch and others. They turn the collector over so it faces down and use a reflector to guide solar radiation to it. This approach may be worth pursuing further, particularly if the building roof or other building element can be used as a reflector.

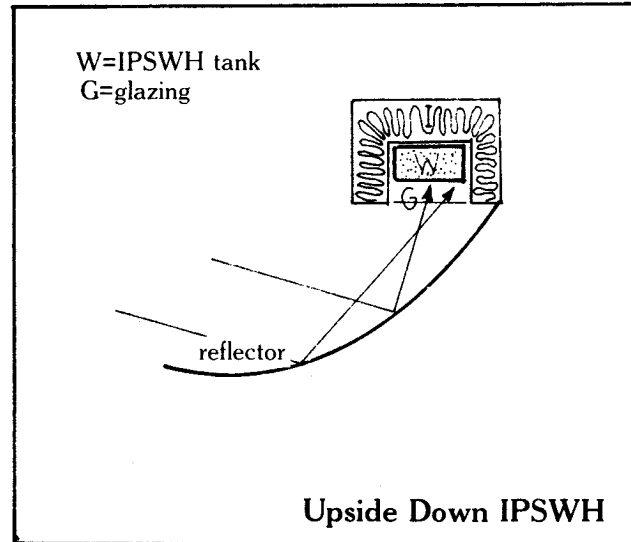

The use of a selective surface will also reduce heat losses-possibly with less cost and inconvenience than movable insulation. With a selective surface absorptance may be a little less but emissivity is much lower, 10 percent versus 88 percent for black paint, and the net gain over a day will be higher even if no glazing or movable insulation is used. For more information on selective surfaces see Appendix 2, Products.

The design of the heater can also help keep the water as warm as possible for the user. Vertical tanks allow greater stratification to occur-keeping temperatures as warm as possible. Reducing internal mixing with baffles and carefully designed cold water entry can also help. A controlled anti-mixing entry can be made by directing entry water in a manner that will affect only the colder water at the bottom or end of the tank.

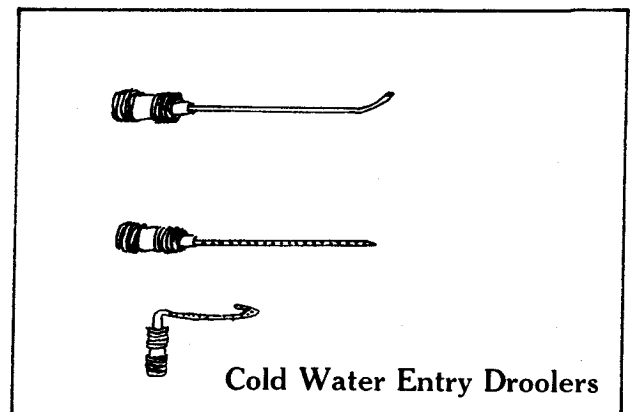

Rule 4: Make it the Right Size

The general rule of thumb for IPSWH design is to allow about 30 gallons (114 *l*) of storage per person per day. Thus, a family of three would require 90 gallons (341 *l*) in the IPSWH. This should be more than enough for a conserving household (see Rule 5) and would give carryover for a day or two of cloudy weather.

To provide adequate collection for this storage, figure that in a temperate climate no more than 2.5 gallons of water per sq ft of collector (100 *l* per sq m) should be included. The 90 gallon (341 *l*) water heater would then require at least 36 sq ft (3.3 *sq* m) of collector.

A more precise determination of the amount of storage required will depend on the expected water use, climate, type of IPSWH, and type of backup system (if any). Demand depends in large measure on the family profile of the users, the type of facilities in use, and the care with which they are used. A family with children (especially if still in diapers) would be expected to use more hot water than a family without children.

The time of demand also affects IPSWH storage and design requirements. The best performance can be achieved by using hot water primarily after midday. This allows the highest temperatures to develop. If hot water is wanted in the early morning then use should either be scheduled to allow recovery in the late afternoon or sufficient capacity should be left after evening use.

Typical hot water demand on a wash and bath day for a family of five was described by F.A. Brooks in 1936:

Typical Hot Water Use in 1936

Time	Activity	Temperature		Family Water Use		Use per person	
		°F	(°C)	Gallons	(liters)	Gallons	(liters)
7:00a.m.	Shaving and incidental	100°	38°	4	15	.9	3.4
8:00-8:30a.m.	Clothes washing, one machineful reused	128°	53°	14	53	2.8	10.6
8:30-9:15a.m.	Dishwashing	128°	53°	12	45.5	2.4	9.1
9:30a.m.	Clothes washing by hand	120°	49°	3.5	13	.7	2.6
9:15-10:00a.m.	Rinse water	100°	38°	22	83	4.4	16.7
10:00a.m.	Baby's bath	100°	38°	3	11.5	3.0	11.4
10:15-11:30a.m.	Incidental	--	--	3	11.5	.6	2.3
11:30a.m.-3:30p.m.	Washing lunch dishes and incidental	125°	52°	11.5	44	2.3	8.7
7:30-7:30p.m.	2 childrens baths	92°	33°	25	95	12.5	47.3
7:30-8:30p.m.	Wash dinner dishes	125°	52°	7	26.5	1.4	5.3
8:30p.m.-6:30a.m.	2 adults baths	95°	35°	17.5	66	8.8	33.3
	Total			122.5	464	39.8	150.7

If washing and bathing for adults is assumed every third day than average use is about 34 gallons (129 *l*) per person per day. This study in 1936 is surprisingly representative of current use. The following table shows current use estimates for the United States.

U.S. Average Daily Hot Water Use Per Person

Activity	Temperature		Water use per day	
	°F	°C	gallons	liters
Dishwashing	140°F	60°C	4	15
Laundry	140°F	60°C	10	38
Bathing and hygiene	105°F	41°C	20	76
Total	120°F	49°C	34	129
	avg.	avg.		

The use of water conserving fixtures can considerably reduce the waste of hot water. The key items are flow restrictors for showers and faucets, which are fortunately inexpensive. Water conserving appliances are often slightly more expensive but will save much more than they cost over their lifetimes. The following table suggests the savings possible using conservation devices.

Even if you do not have any solar access for an IPSWH you can still implement your own water conservation strategy-to do more with less.

Daily Hot Water Use Per Person With Conservation Devices In Use

Activity	Temperature		Water use	
	°F	°C	per day gallons	liters
Dishwashing	140°F	60°C	2	7.5
Laundry	140°F	60°C	5	19
Bathing and hygiene	105°F	41°C	10	38
Total	120°F	49°C	17	64.5
	avrg.	avrg.		

The careful use of hot water can add further savings. These additional steps include hand washing dishes and batching wash loads carefully so cold water can be used when it will suffice.

Daily Hot Water Use Per Person With Careful Use & Conservation Devices

Activity	Temperature		Water use	
	°F	°C	per day gallons	liters
Dishwashing	105°F	41°C	2	7.5
Laundry	140°F	60°C	2.5	9.5
Bathing and hygiene	105°F	41°C	5	19
Total	114°F	46°C	9.5	36
	avrg.	avrg.		

And if very careful use is combined with the best conservation minded fixtures and appliances, even more dramatic savings can be achieved. This level of saving will require "ecotopian" consciousness and custom built fixtures-but is worth careful consideration from anyone concerned about the future of our tattered spaceship Earth.

Daily Hot Water Use Per Person With Ecotopian Use and Design

Activity	Temperature		Water use	
	°F	°C	per day gallons	liters
Dishwashing	105°F	41°C	1	3.8
Laundry	105°F	41°C	1	3.8
Bathing and hygiene	105°F	41°C	1	3.8
Total	105°F	41°C	3	11.4
	avrg.	avrg.		

Source for previous four tables: The Integral Urban House, Sierra Club Books; and estimates by the author based in part on work by the Minimum Cost Housing Group at McGill University.

Rule 5: Make a Safe and Efficient Connection to a Conserving Backup System

One of the most important considerations in developing any successful solar system is diligently applying conservation measures to reduce load. IPSWH's are no exception-conservation measures include addition of flow restrictors, aerators, and water conserving appliances. A heat exchanger can also be applied to save the heat energy that is now lost when warm gray water leaves the house. In addition, the connection between IPSWH and the water system should be made as efficient as possible in order to reduce line losses. This involves reducing distances wherever possible and carefully insulating these lines.

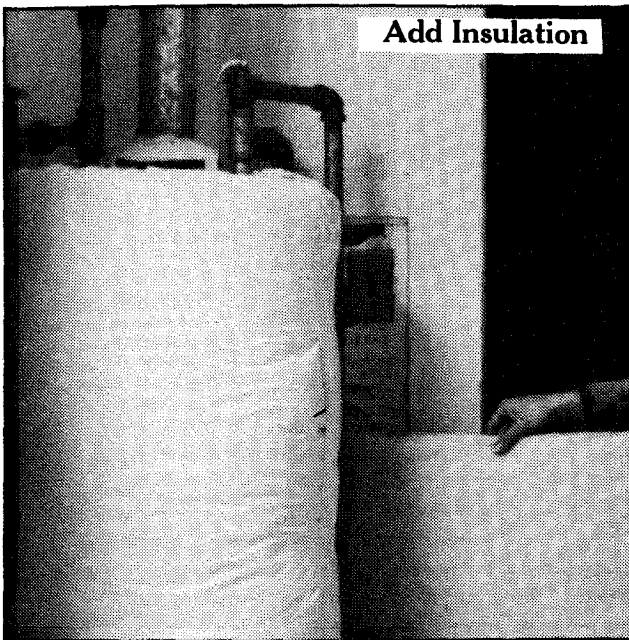

Add Insulation

The insulation should have a high resistance to heat flow and be very durable. The best system is one with one to two inches (5 cm) of urethane foam with a plastic or aluminum jacket. Less costly but also less effective is Armaflex™ pipe insulation, which must be painted where it is exposed to the sun and elements. Inside the building, fiberglass or foam can be used to insulate the pipes.

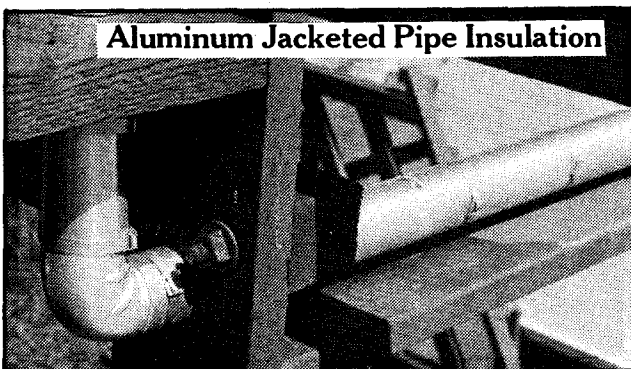

Aluminum Jacketed Pipe Insulation

Experience has shown that for best results the backup water heater tank should be bypassed when possible. Otherwise the backup water heater tank loses some of the solar heat. Obviously, bypassing the backup tank can only be done when the solar water temperature is high enough. When it is, the savings in energy is well worth the time required to switch the valves each year. Bypassing would be less important with a very well insulated backup heater tank, but you might wish to experiment even with this type of system to determine the most efficient mode of operation.

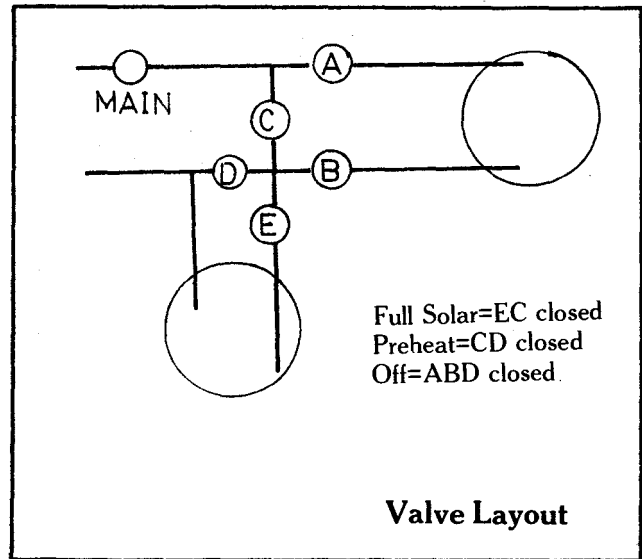

You can also improve the performance of the system by scheduling water use to fit supply. Shower, wash and launder when water is the hottest-during the afternoon or early evening.

Some IPSWH's will work so well that water temperature will be high enough to be scalding. This is a particular danger to children. For \$12 to \$15 a tempering valve between the heater and point of use can prevent any hazards from overly hot water.

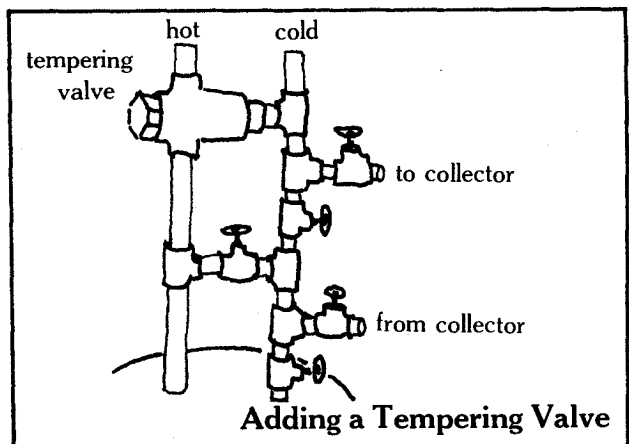

Rule 6: Build It To Last

Even an inexpensive IPSWH might not provide economical solar heating if it only lasts one season-or if it leaks into the house on top of your favorite antique. It will pay you to build it to last. This will require sound construction technique, protection from corrosion, freeze protection, and, just in case, protection if leaks occur. The importance of these various elements will vary by climate, water type, and location of the heater.

Good construction will not only help your heater last longer-but will generally make it look better as well. The most common errors are made in flashing, glazing, and painting. You can avoid these by careful study, asking for advice, and attention to detail.

Flashing joints properly will prevent most weather related leaks from occurring in the IPSWH. Every joint should offer mechanical barriers to water entry (simply slopping on caulk won't do). A variety of flashing extrusions are readily available at building and solar supply stores. Choose and apply them with care.

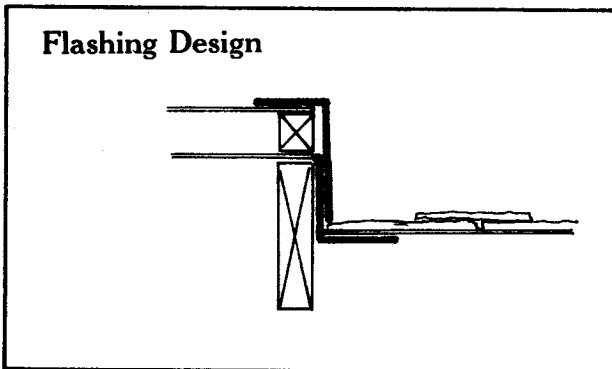

The most common problems with glazing involve the hold down system. With plastics the error is usually failure to accommodate expansion correctly-resulting in cracks in the plastic. These can be avoided by allowing the plastic to move with oversize screw holes or clamps. With glass the more common problem is failure of the hold down strips or battens and corrosion of screws and fasteners.

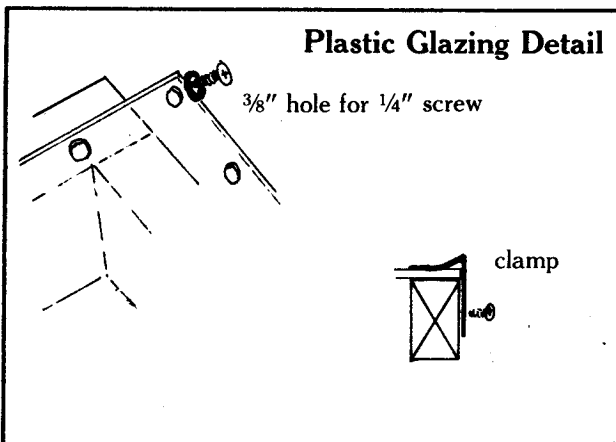

You can ensure a good appearance by carefully choosing paints and preparing surfaces for painting. Make sure you have cleaned surfaces well, use the appropriate primer (or primers), and apply finish coats that will withstand high temperatures. Proper painting will virtually eliminate exterior corrosion and weathering.

Internal corrosion must also be reduced or prevented. Be particularly careful if a variety of materials are used in the system-if dissimilar materials are used, make sure dielectric breaks are included to reduce corrosion. I prefer to use copper as much as possible to reduce corrosion; and where it is joined to galvanized pipe or tanks I use plastic dielectric unions to prevent accelerated corrosion.

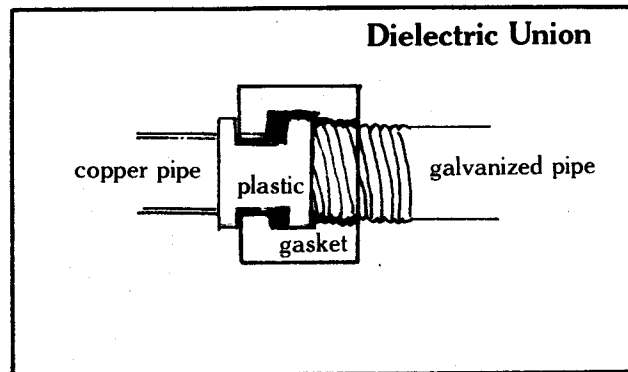

The tank or collector itself must also be protected to resist corrosion. Galvanizing alone is insufficient in most areas. With the high temperatures in the box most water is fairly corrosive and galvanized tanks may last less than two years. Glass lined or stone lined tanks are better but even they should be protected with a sacrificial anode. This anode is of a less corrosion resistant material and saves the tanks and pipes. A look at these anodes from IPSWH's in use 3 to 4 years in Davis, California revealed considerable loss of material and it might be very good practice to replace them every 3 to 5 years.



Freezing can also wreak havoc on IPSWH's although they are less sensitive than most other solar systems. Even very simple IPSWH's will survive, occasional drops to 20°F (-6.7°C) or less. Some are reputed to be safe as low as 0°F (-17.8°C) or lower but more experience is needed to really predict how they will do.

The tanks' high thermal mass and movable insulation (if used) will give the system some protection from freezing. However, in colder areas some form of freeze protection will be required.

The most common method is simply draining the heater during the coldest part of the winter. Make sure it will drain completely by installing an air vent or valve to let air in to replace the water when it drains. You might also have an automatic draindown valve installed so the system will drain itself only when it gets cold. Automatic draindown would not only be less trouble but it would also allow the system to provide heating for much of the winter.

The most sensitive part of most IPSWH installations is the piping to and from the heater-and this must be very well insulated and designed for complete drainage if drainage is to be used for freeze protection. Make sure the pipe runs consistently downhill to a drain-and drain it carefully. The connecting pipes in the heater box are also more susceptible than the tanks and should be insulated in areas where freezing may be a problem.

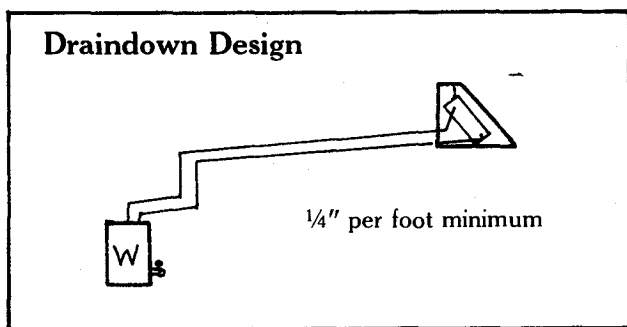

Other options for freeze protection have also been used and may be worth considering. In milder climates you can leave the electrical heater element in the IPSWH-and have it provide both backup heating and freeze protection. Another strategy would be a vent or door that can be opened to allow heated air from the house into the IPSWH. A gas furnace flue might also be used as a heat source.

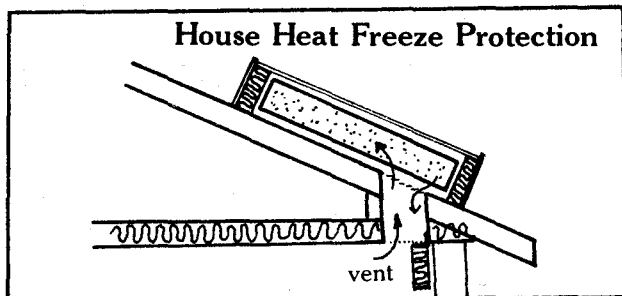

In much colder areas the heater may need more powerful freeze protection. First consider putting the heater right in the house or greenhouse. If that isn't possible you might have to use a heat exchanger set in a freeze proof liquid filled collector tank. If a single walled heat exchanger is used then the antifreeze must be nontoxic. Propylene glycol is acceptable, ethylene glycol (car antifreeze) is not as it is highly toxic.

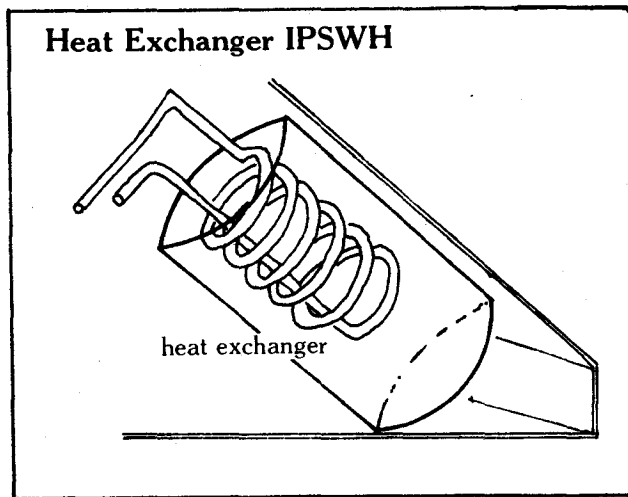

Phase change materials may also be used for freeze protection. These could change phase at 70°F or 80°F (21°C to 27°C) or lower and could be put in the collector box as a liner. As the heater cooled off these would give up their stored heat to keep it above freezing.

And finally, consider what can happen if something does leak (because of weather leaks, corrosion, or freezing). Put a drip pan with drain to protect the heater and the house beneath it. These are most commonly made of galvanized iron sheet with turned up edges but they could be fibreglassed wood or plastic. Bent Nail Construction used a gutter running across the bottom of the inclined tank bed in one heater to collect water from any possible leak and carry it outside. For a ground mounted heater this is not as important-but the drainpan can prevent damage to the wood box and probably should be included.

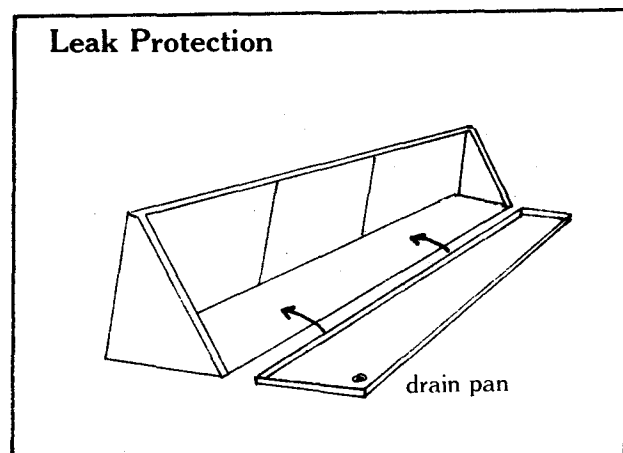

Review

To sum up the basics, then:

- Put your heater in the sun, and use proper slope, orientation, and reflectors to maximize the solar radiation received.
- Paint it black, or use selective surfaces.
- Put it in an insulated, weather sealed box with glazing (layers) and movable insulation.
- Use about 30 gallons of water per 15 sq ft of collector per person (114 l per 1.4 sq m)
- Make a short as possible run to a conserving water system with insulated pipes.
- Build it to last, with careful construction, corrosion resistance, freeze protection, and drainage.

The following sections examine some design considerations for both the very inexpensive and advanced IPSWH's. Design is still guided by these basic rules.

Some Concepts for Virtually Free IPSWH's

One of the most attractive attributes of IPSWH's is the phenomenally low cost of constructing the more basic models. This makes the IPSWH a good candidate in areas of the world where even the cost of conventional fuels, such as dung or wood, may be too high for many people.

The original model, the black can in the sun, would perhaps be the most widely applicable. Discarded cans or drums-5, 33 or 55 gallons (19, 125, or 208 l) would be logical choices for IPSWH use where they are available from oil, mining, or other industrial operations. Many of these drums will already be black and ready for service. Those that aren't can be blackened with soot or, if possible, flat black paint.

These simplest heaters can be improved by setting them in an insulated box, perhaps made from wood or adobe with sawdust insulation, with a glass or plastic cover.

Where cans are unavailable, the heater could be made with ceramics. If the potter is skilled, a large container can be constructed. This could be fired in a reducing atmosphere for a very good integral black. The Pueblo Indian technique would probably be suitable in many areas of the world.

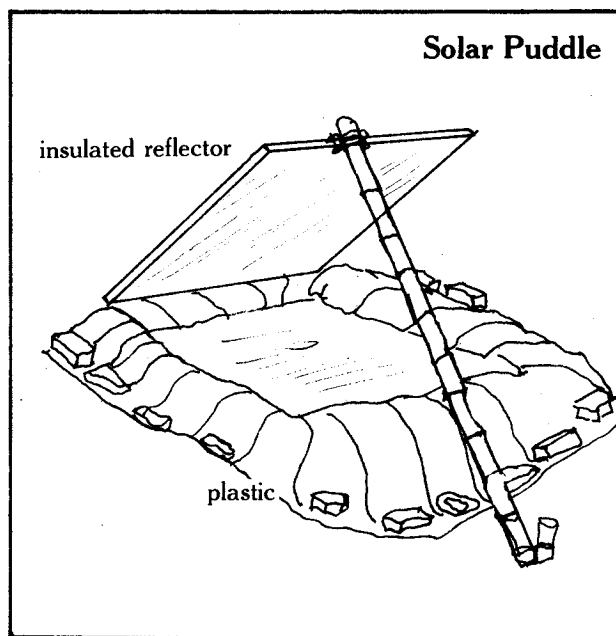
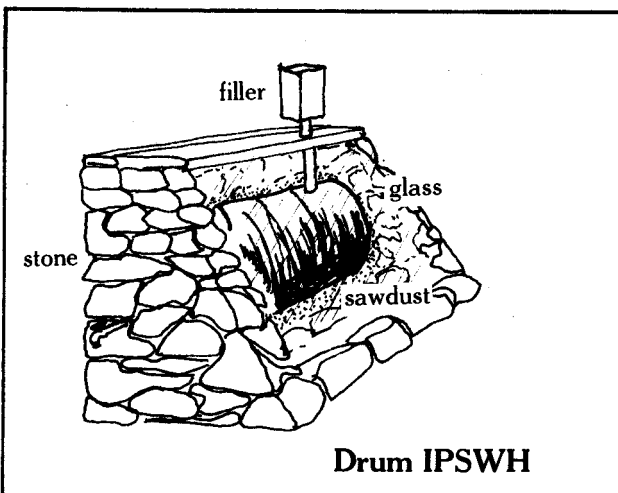
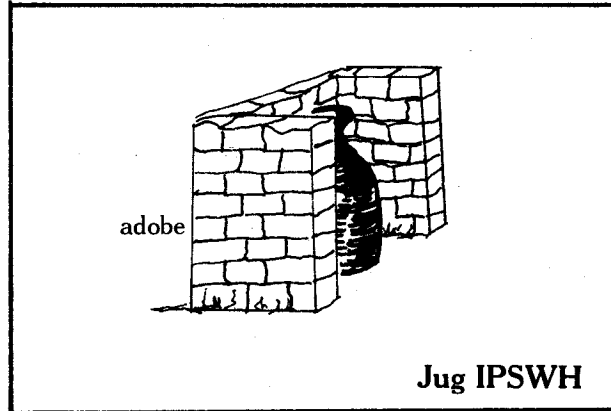

Plastic bags can also be used as solar heaters. Ideally one side will be black, the other clear. Insulated boxes, glazing, and insulated lids will help these heaters work better. Three examples of this type are described later in this book: "The \$2.50 Garbage Bag Heater" developed by McGill University, the commercially produced "Solar Pillow" from Japan, and the "Sun Shower" from the U.S.



IPSWH

Simple IPSWH's can be built using truck, bus, or auto inner tubes. For the simplest version the tube can be cut and tied off to form a black sausage of water. If materials are available for vulcanizing, gluing, or pipe fitting, then fittings can be installed on the tank for easier filling and use.

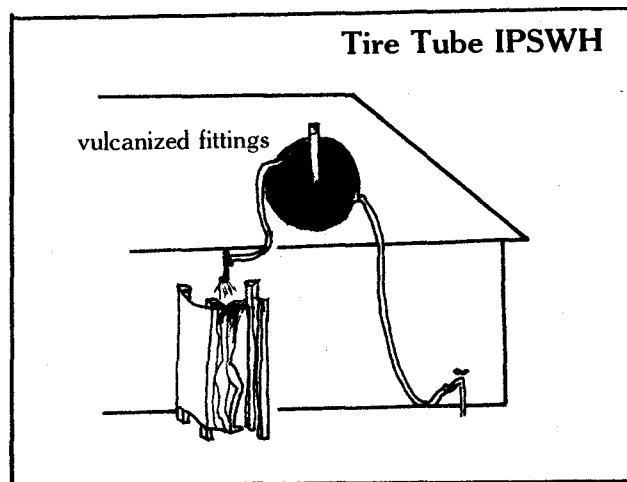

Tire Tube IPSWH

If pipe is available locally it could also be used for building IPSWH's. Two inch (5 cm) or larger diameter pipe is desirable. Galvanized, copper and some types of plastic pipe would all be suitable. Used well casing might prove usable if it is available.

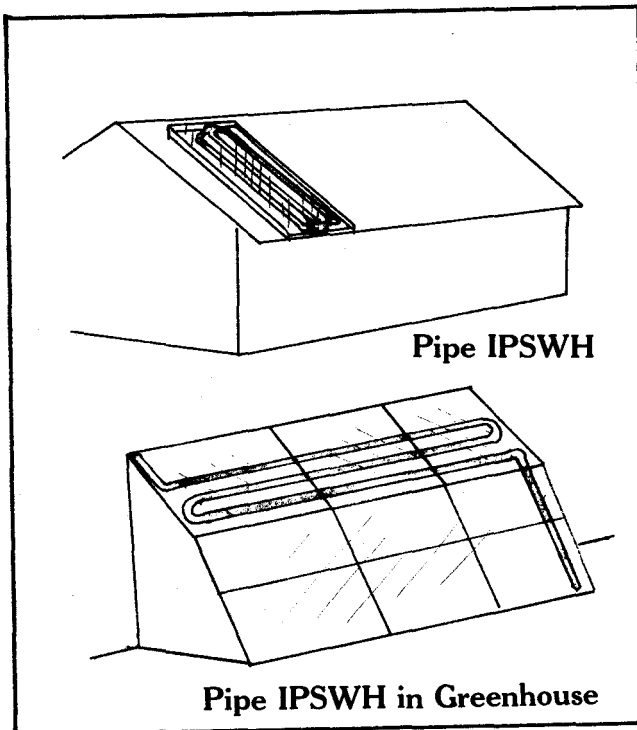

Pipe IPSWH

Pipe IPSWH in Greenhouse

In more affluent countries, a type of used prefabricated insulated box is available—old refrigerator cases. The refrigerator motor and shelves are removed and a black tank is placed in the box. The glazing can be set down in the box so the lid can still be closed in the winter.

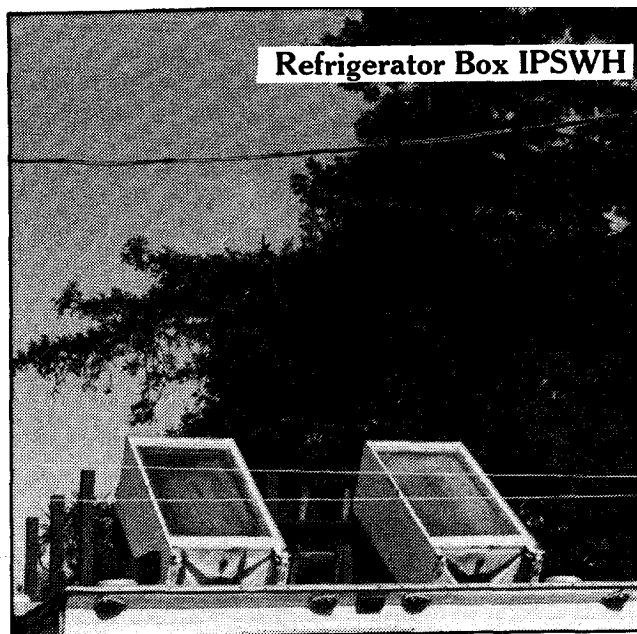

Refrigerator Box IPSWH

Some Concepts for Advanced IPSWH's

A number of options are worth investigating for advanced IPSWHs. These include: moving collectors, selective surfaces and films, special tank configurations, phase change materials, thermal diodes, anti-freeze measures, and complete cistern/IPSWH water systems. The following ideas are just that; and only time-and experimenters like you-will tell if these ideas prove practicable.

The concept of a moving IPSWH, a marriage of low tech and high tech, seems a little odd at first-but may make sense. The movement could be either daily or seasonal. The IPSWH itself might rotate to maintain better solar exposure, or its reflectors might move to do the same thing. The drive for this type of system could be either from Freon transfer, photovoltaic motors, clockwork of some kind, or manual. Steve Baer has built a tracking IPSWH and is apparently willing to sell them for about \$2,000. No performance data were available.

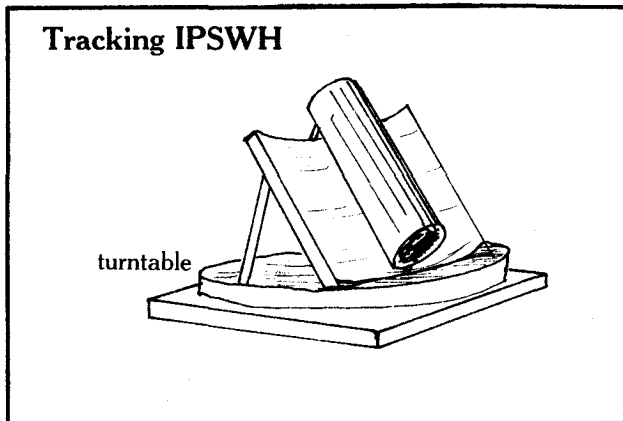

Selective surfaces and films almost certainly will be used for many more IPSWHs in the near future. A combination of a selective surface on the tank, to reduce emissivity, and selective film in the glazing to reduce radiative losses would considerably extend the performance and range of the simplest IPSWH-without adding much to the cost of mass production. For example, the tank might be coated with selective surface foil with "Heat Mirror" double glazing to effectively reduce heat loss 50 percent or more.

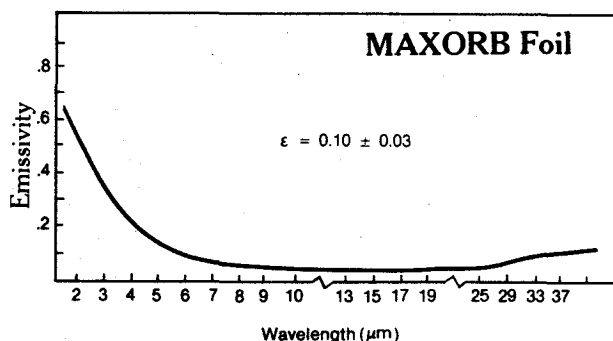

Special tank configurations may also prove helpful. The simple West Indies thermo siphon IPSWH suggests one of the possible areas for exploration. In a similar vein, I have thought that a tank with an insulated divider and insulated top section, as shown, could provide nighttime carryover with little loss in the protected section. Peter Zweig's test of a night cap on an IPSWH confirmed the need for a divider. Special glass lined rectangular tanks might also prove easier to work with in mass production.

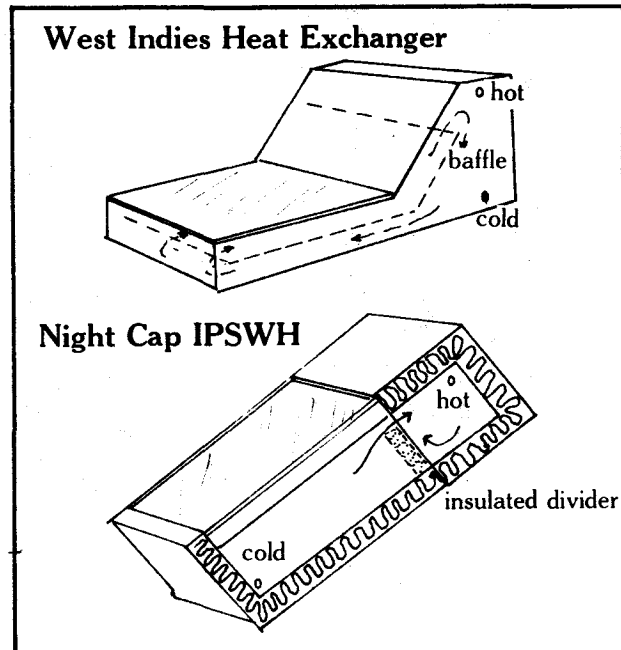

Phase change materials may also be used to improve IPSWH performance. Using a 120°F (49°C) phase change material in a core, for example, could maximize collector efficiency by keeping collector surface temperatures as low as possible. At night when the lids are closed, the phase change material would give up its heat to the water-keeping it hot much longer. Some of the paraffins are good candidates for this. I hope to conduct some experiments in the coming year with a recycled gas water heater with the core filled with paraffin. Other materials might prove even more useful.

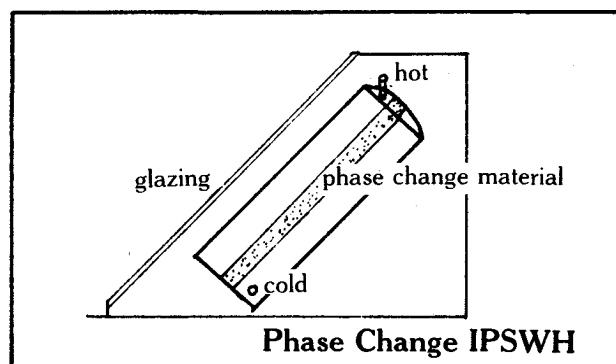

The thermal diode, developed by Shawn Buckley, may also prove desirable for IPSWHs. This thermal diode uses a special tank configuration with an oil layer on the water. This oil allows circulation to occur in only one direction-effectively stopping reverse circulation at night and greatly reducing losses from the back of the tank, as shown. Standard Oil of California is using this principle in their IPSWH.

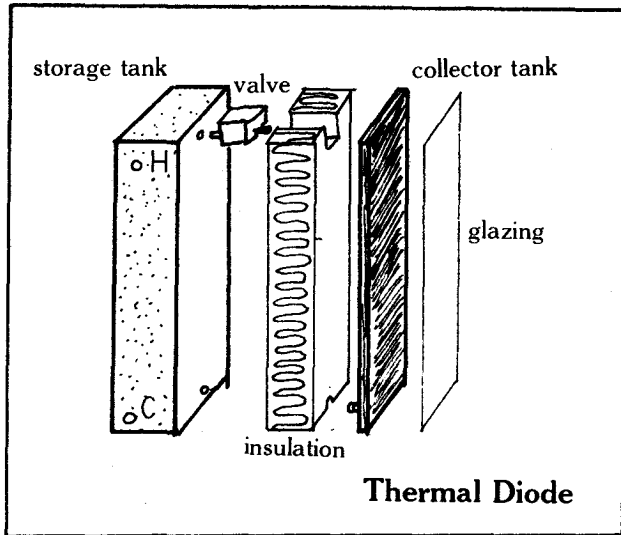

Another interesting and potentially very useful advanced technique uses heat pipes to collect the energy from the sun. The heat pipe then transfers this energy to a well insulated storage tank. The heat pipe only transfers heat efficiently in one direction so night heat losses are very low. Tom Feldman has been working with this concept for several years and is using it in his commercial IPSWH.

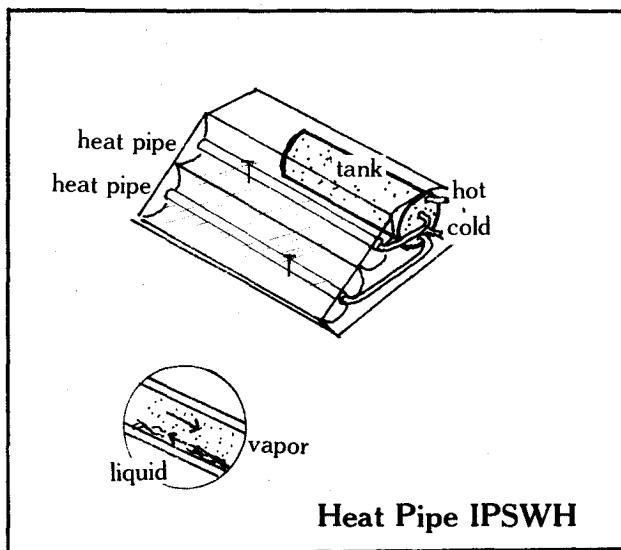

Special techniques for freeze protection may also prove desirable. An obvious option is the use of a tank within a tank heat exchanger IPSWH. The exterior tank would hold the non-toxic antifreeze solution, while the inner tank would hold the potable water. The inner tank might be ribbed or finned for better heat transfer.

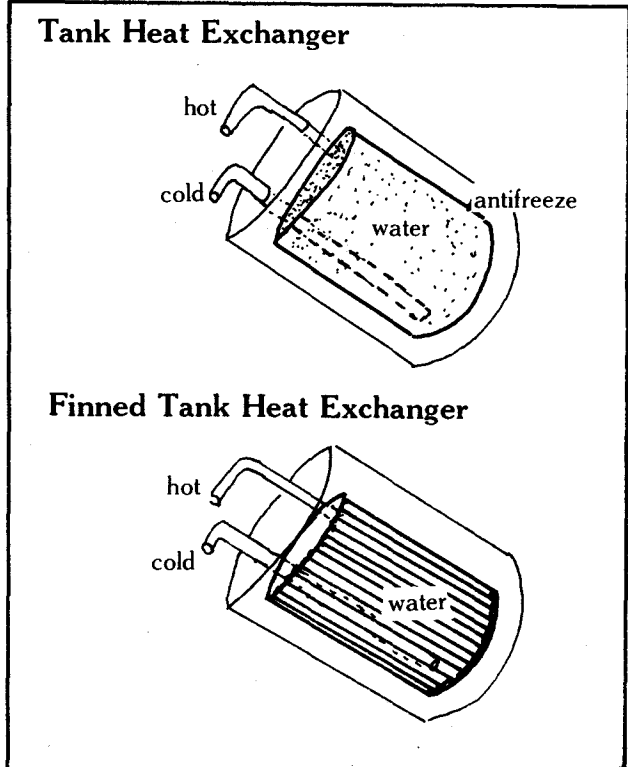

Another feasible freeze protection measure might be the inclusion of an air filled bladder in the tank allowing the ice room to expand without splitting the tank. I hope to conduct tests on this method later this year.

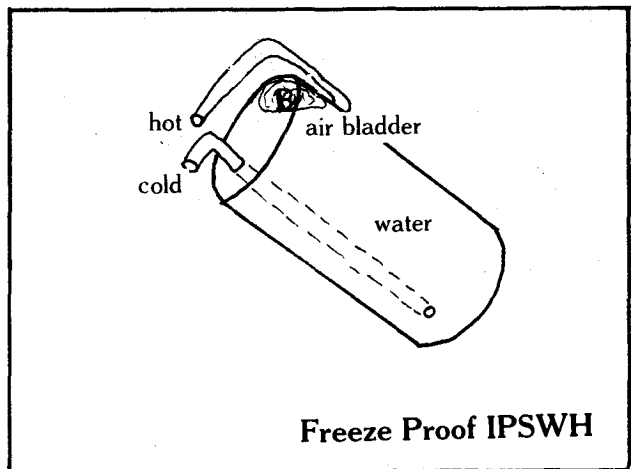

Another interest of mine is the integrated house water system with roof collection, cistern, IPSWH, filters, and possibly solar still. The application would be most attractive at first for remote sites, but could gradually be included in all new construction. A possible system is shown in the accompanying drawing. I am currently seeking funding or clients for this type of system.

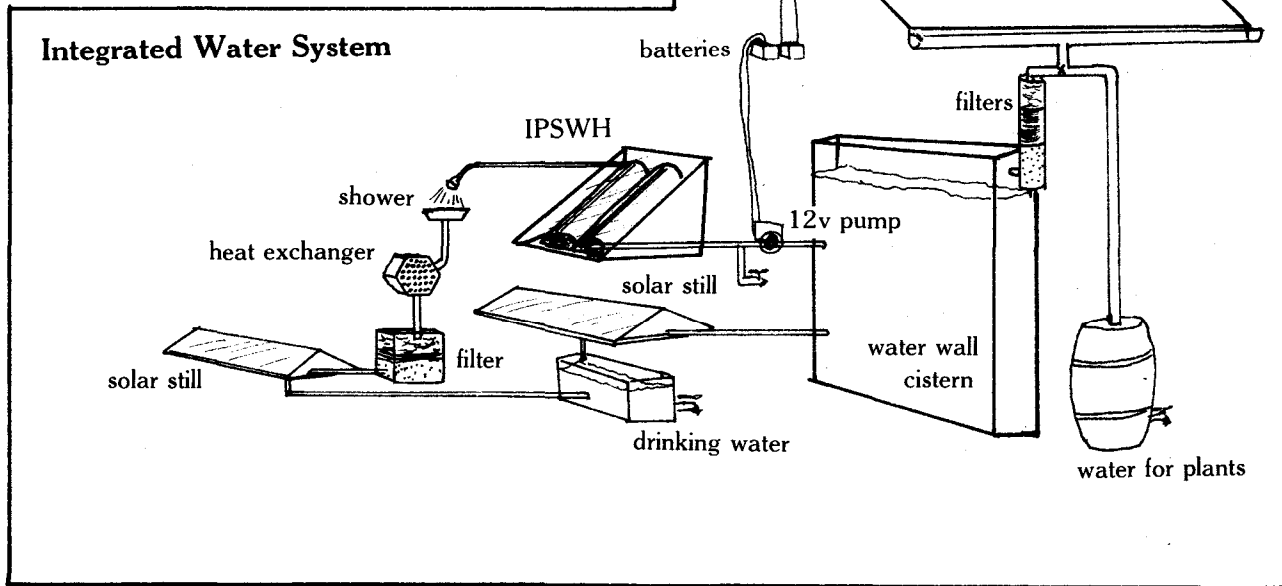

The integration of photovoltaic cells in an IPSWH is also worth evaluating. Their efficiency drops off at higher temperatures. An IPSWH at 120°F (49°C) would keep them cool enough for good efficiency-and would protect them from the elements.

And finally, the IPSWH might be a very good heat sink for your refrigerator or freezer coil. The air behind a refrigerator often reaches 120°F (49°C) and has much lower heat capacity than water at the same temperature. This type of interconnection would be particularly helpful in restaurants and other applications with high refrigeration and hot water demand.

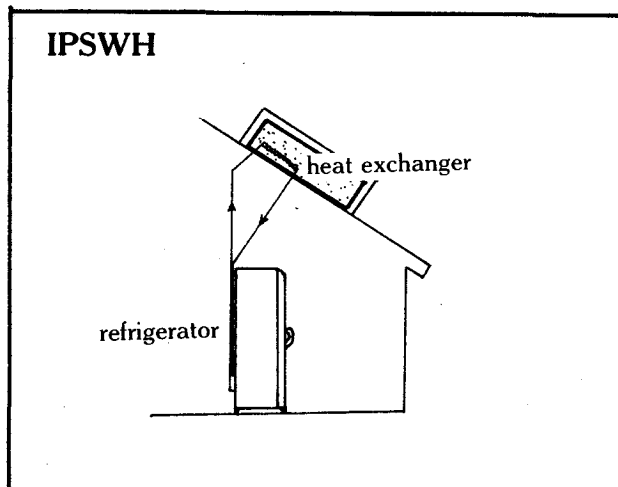
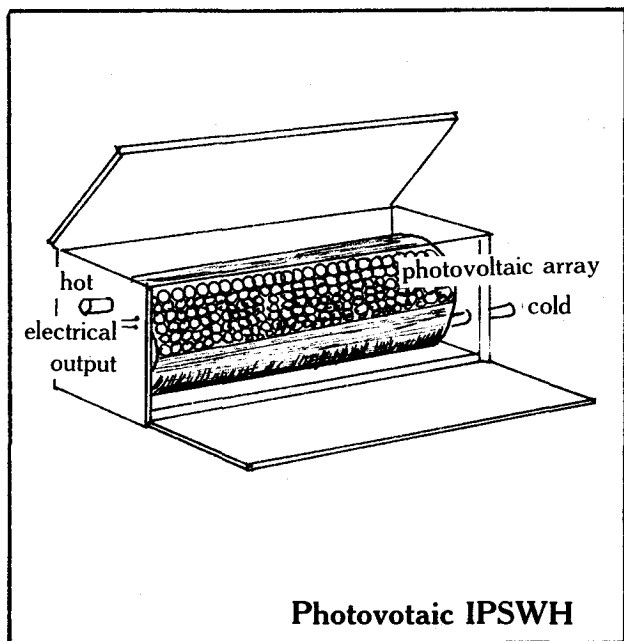

These are by no means all of the possibilities for advanced IPSWH's-although I hope I've picked at least a few of them. I hope this section will inspire you to propose other concepts and, more important, try them out. The cost of experimentation is low-and it may make a real difference for all of us.

Chapter 5: Operating An IPSWH

The operation of an IPSWH will depend on the type of heater, the climate, and of course your need for hot water. For the simplest IPSWH used in a warm climate, you don't need to do anything after the initial hookup is made. In cooler climates, this simple heater might need supplemental heat in the winter. This requires turning only two valves and turning on the backup heater. In cold climates this simple IPSWH may need backup during the fall and spring, and may need to be drained in the winter.

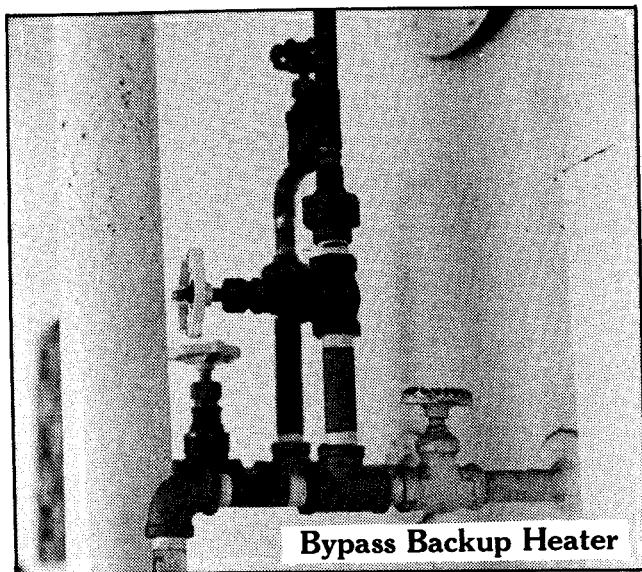

Bypass Backup Heater

The next level of IPSWH, with manually operated insulated cover, may require little attention during the summer, when nights are warm, but may need its lid opened in the morning on sunny days and closed at night and on very dark and cloudy days the rest of the year. In quite cold climates even this type of heater may need to be drained in the winter.

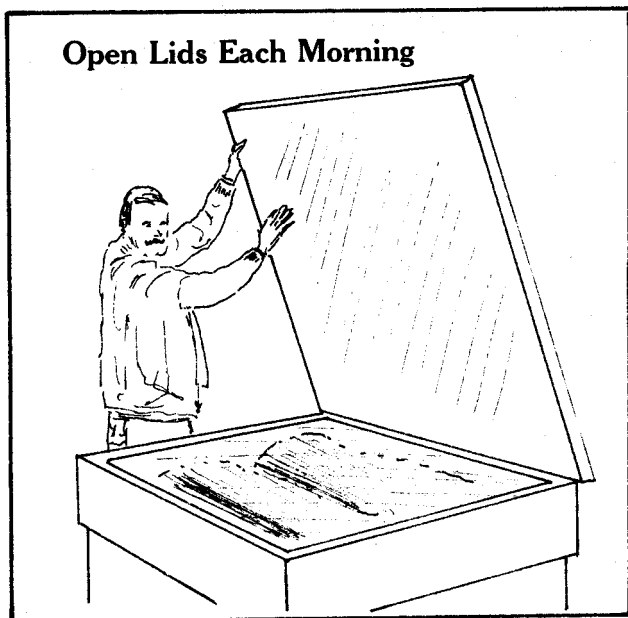

Open Lids Each Morning

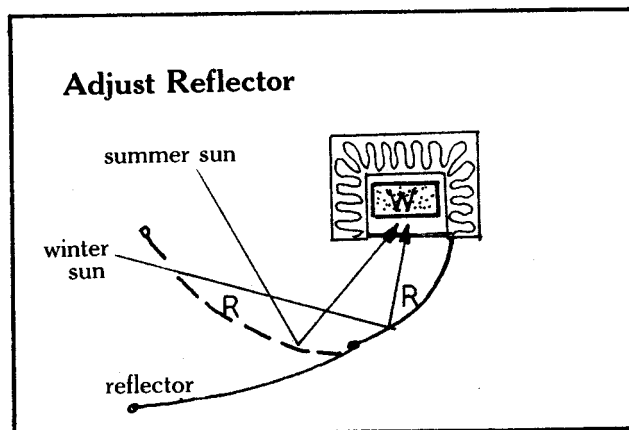

Adjust Reflector

And finally, at the more sophisticated end of the spectrum, the automated IPSWH, you may need to do very little except to occasionally check the controls and oil moving parts. The performance of some of these automated IPSWH's may be improved by changing the reflector angle several times a year to increase collection.

Of even greater importance in wringing the optimal performance out of your IPSWH is the scheduling of hot water use. Fortunately, the long hot summer days, when we need more showers and wash more clothes, are the best for IPSWH performance, and plenty of hot water will usually be available even in the morning. However, in the fall (or winter further south) less water will be heated, and adjustments in your use pattern can help your heater meet more or all of your hot water demands.

The most common adjustment you may want to make is changing your showers and baths to afternoon or evening. As the performance charts in Chapter 7 show, this may mean the difference between 90°F water (too cool) and 120°F water (32°C and 49°C).

Washing can be done with cool water and "all temperature" cleanser, and clothes can be hung out to dry on your solar clothes dryer. Of if you use a gas or electric dryer, they can be washed with hot water in the evening. Then the clothes dryer will in most cases be operating with off peak electricity-which is cheaper in some utility price structures.

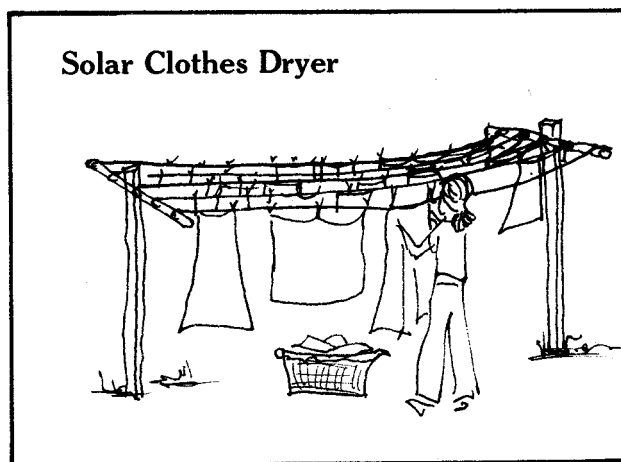

Solar Clothes Dryer

Chapter 6: Backup Heating

In the cooler areas of the U.S. even a fairly sophisticated IPSWH with insulated lids may not provide sufficient hot water in the winter, and you will have to install some form of backup heating. The best choice for you depends on a number of factors including: availability of other sources of energy, hot water demand, climate, and your existing hot water heater.

The availability of other energy sources may by itself determine your backup system. If, for example, you use wood for your space heating, it usually makes sense to add a heat exchanger to your stove or furnace to heat water. The IPSWH tank, if insulated lids are installed, may be an excellent storage tank for your wood heated hot water. The best source of information about wood water heating is *Handmade Hot Water Systems* by Art Sussman and Richard Frazier.

If you have sufficient solar space heating for your home and therefore don't really need a fire often, you might elect to install a wood fired water heater. You can buy these ready made (see Appendix 2) or make your own from a recycled gas water heater.

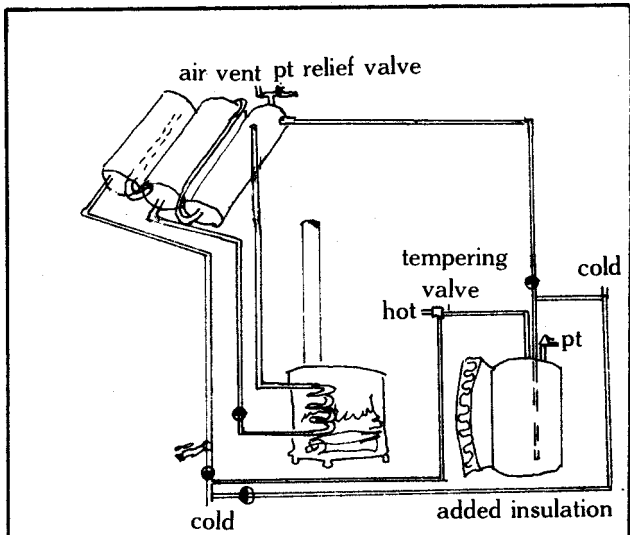
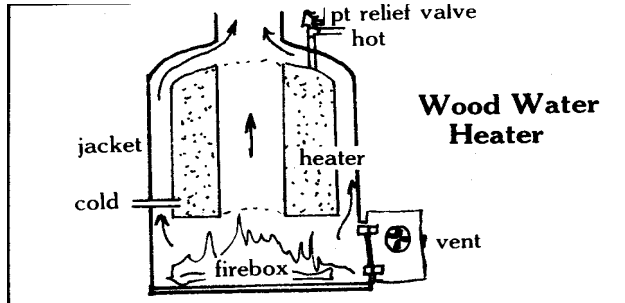

Solar Wood with Backup

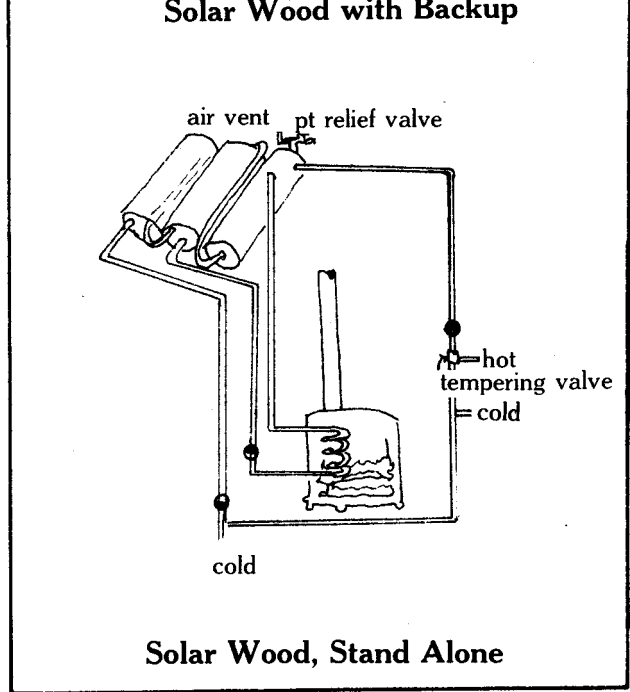

Solar Wood, Stand Alone

If wood is not readily available or you would prefer not to deal with it, you might choose to install more conventional electric or gas backup water heating. If heat loss is expected to be minimal—such as for mild climate IPSWH's, IPSWH's located in greenhouses or in the house, or IPSWH's with very well insulated boxes and lids—you might consider removing the existing conventional heater and adding the backup heating elements to the IPSWH itself. This will save money, free space in the house for other uses, and reduce indoor air pollution (if the conventional heater was gas).

John Golder is currently trying an electric immersion heater set in oil in the sealed off flue of an old gas water heater tank. This may prove to be one of the better approaches. You might also simply leave in the upper heating element of the tank and use that for the boost.

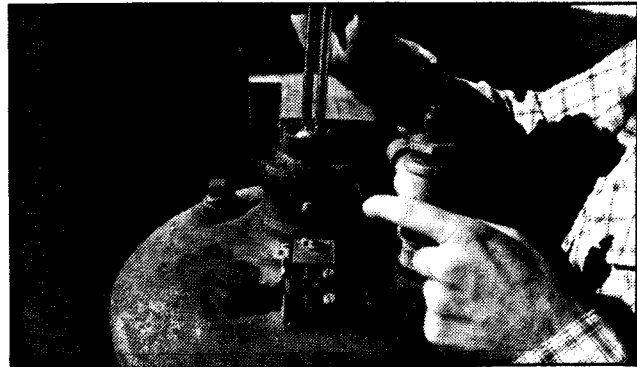

For better economy with this type of setup, you might want to use a clock timer on the backup heater so that it only heats water when you'll be using it. A cutoff switch linked to the lids might also be wise—so you're not electrically heating the water when the lids are open.

If gas is available and less costly than electricity then consider a gas backup heater. This might be located so that the exhaust heat is routed through a heat exchanger in the IPSWH box. Or, for certain types of IPSWH's, the gas burner can be left on the final tank, which should be mounted vertically and have an exterior air source. The exhaust stack should have an automatic damper to avoid heat losses when the burner is off.

In systems with a regular backup heater with tank, you should turn off the backup heater and bypass it when the IPSWH is providing enough heat. Experience has shown that leaving the remote storage tank full of hot water adds unnecessary losses to the system, and you are better off not doing it. Make the valving simple to understand, with color codes keyed to instructions marked on a nearby wall, or it won't be used properly when you leave or sell the house.

Another option which avoids these storage losses completely is the flash or line water heater. These are widely used in Europe and have only recently become more available in the U.S. These heaters use energy to heat the water as it goes through them and don't have a storage tank. Experience suggests that they may save forty percent of the energy used in a conventional heater.

Unfortunately, many of the flash heaters available today have a fixed temperature rise. That is, if the water comes in at 60°F (16°C) it goes out at 120°F (49°C). If it comes in at 140°F (60°C) it goes out at 200°F (93°C). This type of heater can be dangerous with a solar heater unless a point of use mixing valve is used. This valve automatically sets the temperature by mixing cold and hot water before it comes out the faucet.

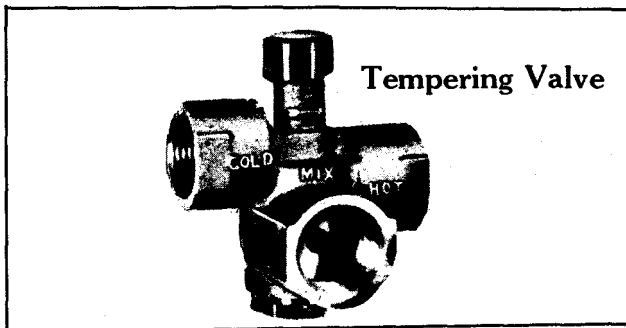

Flash heaters with thermostats should become more readily available in the future and would make a very good backup for an IPSWH. You can hasten this by writing the manufacturers in Appendix 2 and asking them for a thermostatted flash water heater for use with solar systems.

A final option worth considering is the very small, very hot water heater typified by Emerson's "Hot Tap." This one quart heater provides limited quantities of approximately 180°F (82°C) water at the sink. It makes a good booster for dishwater if the solar water is not hot enough. It is also excellent for making coffee, tea, or soup. It can be switched with a wall switch so it is on only when you will use it.

Chapter 7: IPSWH's in Action

1)

This chapter includes descriptions, diagrams and photos of working IPSWH's around the world. These are roughly ranked in order of increasing complexity and cost. The information on each was as complete as I could make it. Performance figures are often subjective and are not necessarily comparable, but do give some measure of the system's performance in a given climate.

In future editions of this book I hope to provide information and performance data on many other IPSWHs. If you have already built, or are planning to build, an IPSWH please send me details and photos at P.S.I. c/o IPSWH Book Update, P.O. Box 722, Davis, CA 95617, U.S.A. Thank you.

Climate Data

The climate data provided with each heater design will help you understand what its performance means in relation to your own climate. Some data was provided by the designers but the majority was taken from the *ASHRAE Handbook of Fundamentals*.

The Summer Design Dry Bulb Temperature represents the dry bulb high temperature equaled or exceeded during 5 percent of the hours between June and September in the U.S. and overseas. The Canadian data is for July alone.

The Daily Outdoor Range is the difference between the average maximum and average minimum during the warmest month at each station.

And the Winter Design Temperature represents the low temperature equaled or exceeded during one percent of the total hours between December and February for the U.S. and overseas. The Canadian data is for January alone.

These should provide for some comparison between sites and systems, but remember that microclimatic variations can be significant.

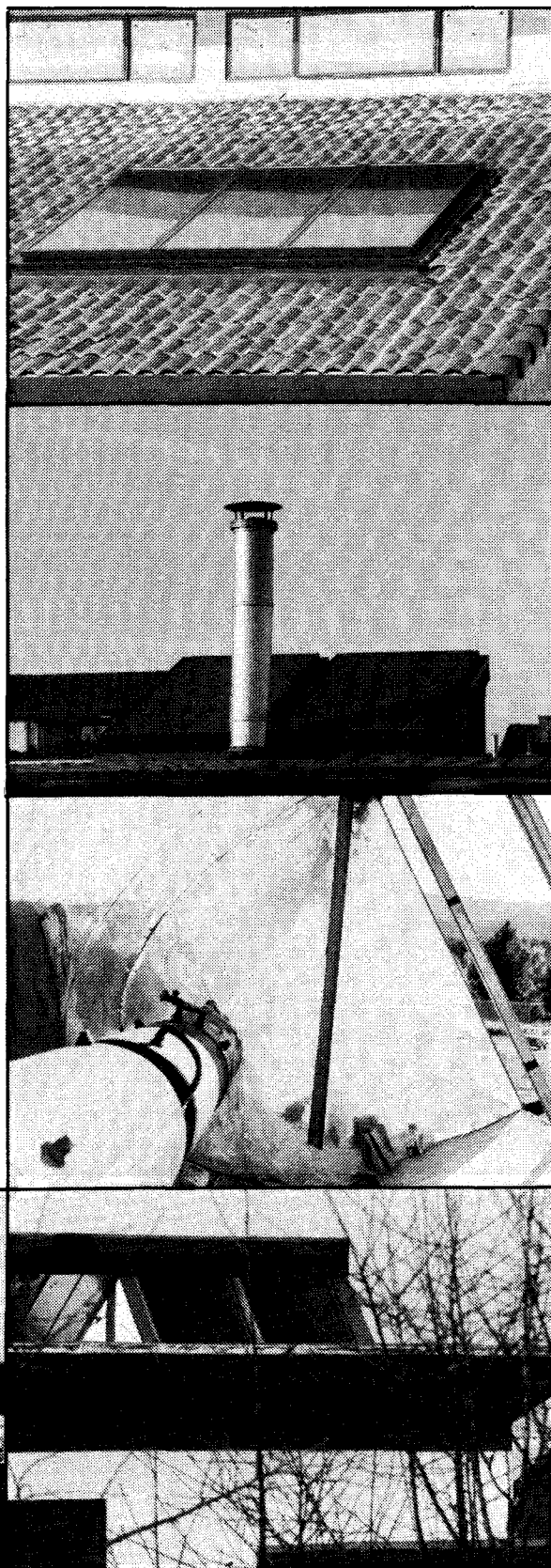

An Integral Passive Solar Water Heater for \$2.00

1979

The Minimum Cost Housing Group has developed the lowest cost IPSWH I have seen. It undoubtedly offers more BTU's per dollar than any other solar water heater, and should be of interest for summer camping and weekend homes in the U.S. and for year round use in less developed countries with warmer climates. The "off the shelf" hardware and "do it yourself" assembly enable the user to assemble the heater with the minimum amount of time, effort, and money.

The key to this heater is the common plastic garbage bag of 1.6 mil dark green polyethylene in a 26 x 35 inch (65 x 90 cm) bag. As sealants and solvents were not available for assembly, a technique for a melt-seal using a cigarette and thumb pressure was developed. The drain outlet, made with PVC pipe, washers and nuts is fastened to the bag mechanically. Tests showed adequate strength for filling to a depth of 3 inches (7.5 cm) or about 13.5 gallons.

A variety of tests were conducted in Montreal to determine the performance that might be expected in various configurations: exposed bag resting on one inch (2.5 cm) of insulation, bag in insulated box, bag in insulated box with single glazing, and bag in box with single glazing and reflector. The results are included in Table 1.

All of the configurations passed the design temperature of 104°F (40°C). Hence, the added cost of additional improvements is probably not warranted in warm climates or for summer use. During the fall the glass cover proved necessary, as the open bag was unable to reach temperatures higher than 77°F to 95°F (25°C to 35°C).

Location: Montreal, Quebec 45°3'N 73°30'W 98 ft Nearest data: Montreal AP

Summer design dry bulb 5%: 84°F (29°C)

Summer daily outdoor range: 18°F (10°C)

Winter design temperature 99%: -16°F (-27°C)

Reference: "A Low Cost Garbage Bag Solar Water Heater," V.S. Nataraj, Witold Ryczynski, V.C. Bhatt, Minimum Cost Housing Group, McGill University, Montreal, Canada.

Table 1

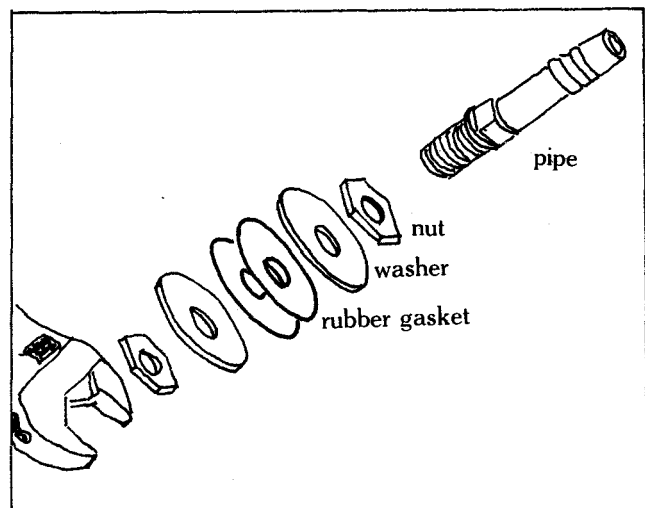
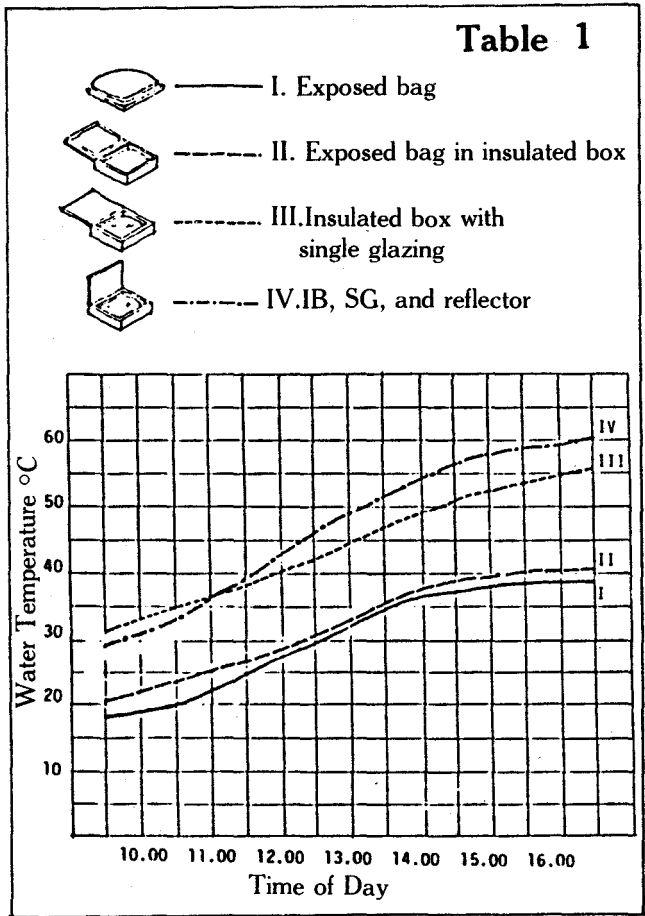

An IPSWH Shower

1979

As I mentioned earlier, the first use of IPSWHs was probably for showers using the simple black can in the sun. The principle still works and its application still makes sense. Lyle Carey of Shanadoah Holler, up in the Ozark Mountains of Arkansas, uses an IPSWH for his solar showers and is very pleased with it.

A high spring allows gravity feed to a black 55 gallon (208 l) drum resting on a 6.5 ft (2 m) tall platform built with small oak poles. A pipe nipple in the bottom leads through a valve to a shower head. The pipe nipple was screwed into a smaller hole in the base and sealed with tub sealant. If tools were handy it could be brazed and welded instead.

A plastic sheet provides privacy and reduces heat loss-of the showeree. The water was warm enough for a shower the second day. And as he says, "it sure beats a little dish pan" bath. Cost, including drum and fittings, was less than \$7.

Source: Lyle Carey, "Outdoor Solar Shower," *Farmstead Magazine*, no. 32, Summer 1980.

Backup water heater: wood stove

Freeze protection: draindown

Location: Shanadoah Holler, Arkansas 36°N 94°W
2,000 ft

Nearest data: Fort Smith

Summer design dry bulb 5%: 96°F (36°C)

Days per year at 90°F (32°C) or above: 87

HDD: about 3,188

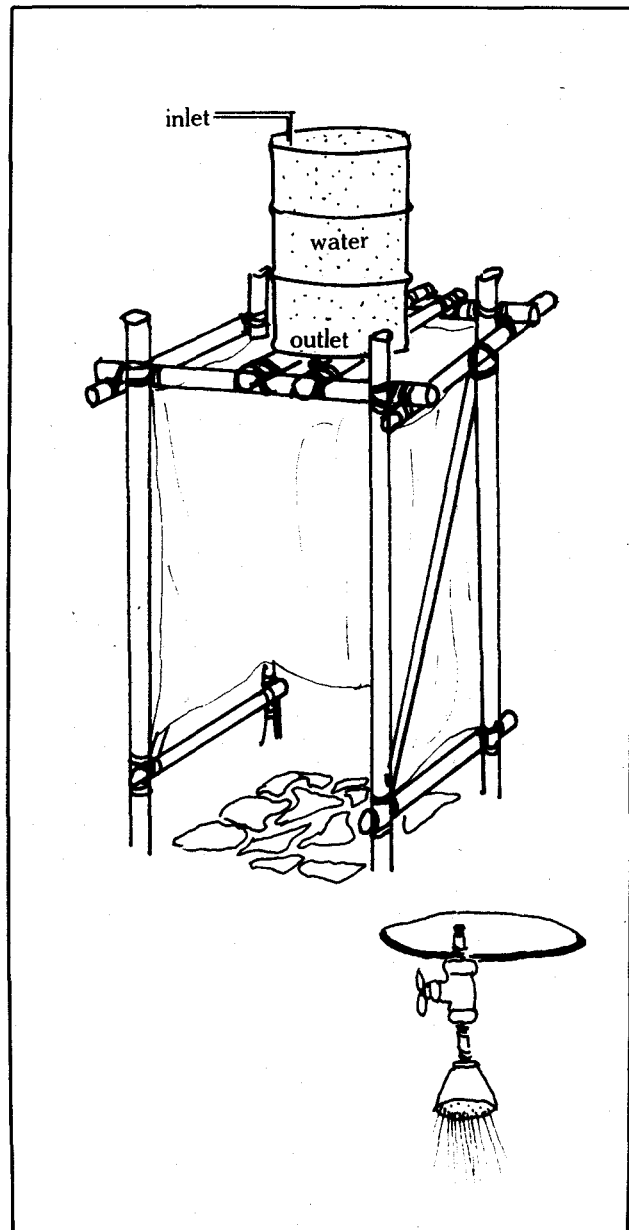

A Simple Preheater in Florida

Dinh Kahn has built and used a simple IPSWH in Gainesville, Florida. His "Solar Bubble" is a 66 gallon (250 l) water heater tank enclosed in a simple insulated double glazed enclosure. Polished aluminum on the inside bottom reflects energy to the back of the tank. The exterior skin on the enclosure is 22 gauge galvanized steel. The exterior skin on the enclosure is 22 gauge galvanized steel. Fiberglass insulation is used. Box ends are 2 x 4 inches (5 x 10 cm) with one inch (2.5 cm) of Styrofoam and two inches (5 cm) of fiberglass. The glazing is Plexiglas on the exterior, with Tedlar film inside.

The tank is plumbed in line with the electric backup heater. Performance has been good for this ground mounted one tank heater. On cold winter days, 25°F to 65°F (-4°C to 18°C) outside, the water reaches 90°F (32°C) in the afternoon, dropping to 80°F (27°C) in the morning. In April the temperature averaged 135°F to 140°F (57°C to 60°C) with morning lows of about 100°F+ (38°C+).

The Kahns schedule use to fit supply to maximize savings. Most bathing is done in the evening when water temperatures are higher and they try to limit use to 66 gallons (250 l) per day- the capacity of the heater. They also keep the backup water temperature at 110°F (43°C), to save even more. After a year's operation, utility bill savings were about 50 percent-for a total investment of \$180.

Backup water heater: conventional

Freeze protection: air bubble

Location: Gainesville, Florida 29°4'N 82°1'W 155ft

Hours exceeding 80°F (23°C) dry bulb: 1,724

Summer design dry bulb 5%: 89°F (32°C)

Summer daily outdoor range: 18°F (10°C),

Winter design temperature 99%: 28°F (-2°C)

HDD: 732

Reference: Ed Moran (1976), "Solar Bubble," **Popular Science**, page 101, September 1976.

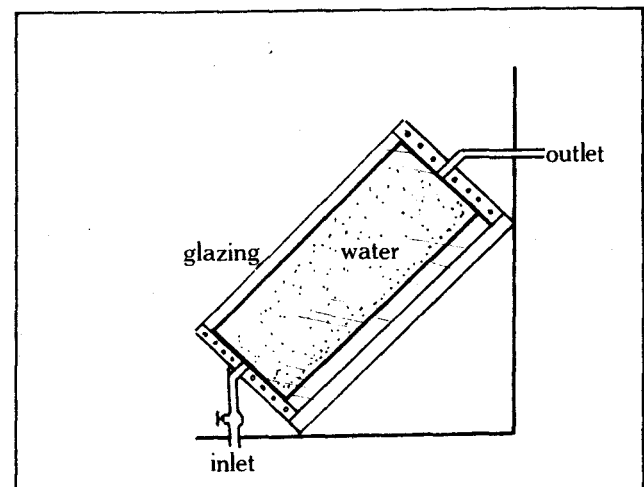
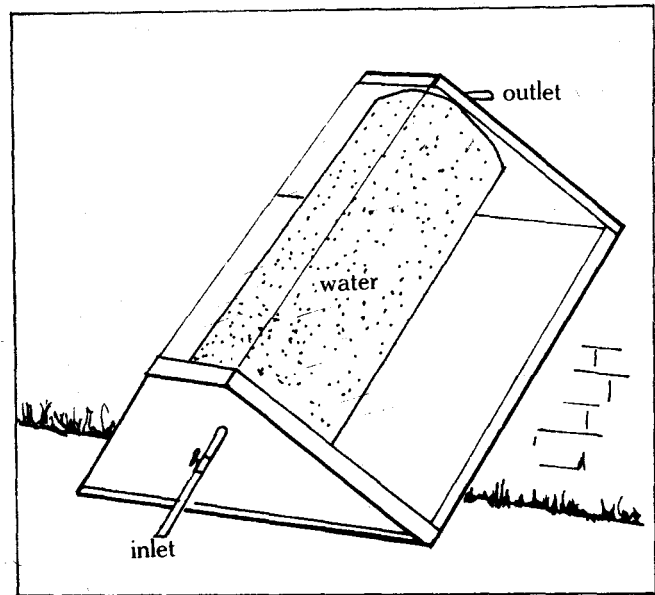

A Tube Heater 1980

The Decker Manufacturing Company uses an elegantly simple IPSWH. It consists of a truck inner tube with hose connections vulcanized to it. It is placed on the roof where it is held in place by a vent pipe.

It holds about 25 gallons (95 l) of water and often reaches 180°F (82°C) by 2 p.m. By the next morning the temperature will drop to 100°F (38°C). This is more than adequate for hand washing.

Location: Keokuk, Iowa 40°20'N 91°20'W 526ft

Summer design dry bulb 5%: 90°F (32°C) Summer

daily outdoor range: 22°F (12°C)

Winter design temperature 99%: -3°F (-19°C)

Source: Duff Decker

A Simple IPSWH for a Mountain Cabin 1979

The simplicity of the IPSWH and the ease with which it can be incorporated in a simple water system makes it an ideal choice for the back country. Fred Klammt's system in the mountains of northern California is a very good example of the effectiveness of the IPSWH for this type of use.

The heart of the system is a recycled 40 gallon (151 l) water heater tank (\$10). This was painted black and set in an insulated, double glazed box painted with aluminum paint inside. The 25 sq ft (2.3 sq m) of glazing, 1.6 gallons per sq ft (651 l per sq m) keeps the performance at the desired levels despite night cool down.

The system uses a reversible 12 volt pump to pump water to the roof mounted IPSWH and to the faucet. The system is freeze protected by manual draindown, when the Klammts leave the cabin.

The heater has provided full hot water, typically 110°F (43°C) whenever the Klammts have needed it. The cabin is used about forty days a year up to two weeks at a time. The fifty dollar system cost less than a propane heater would have cost. It took 24 hours to build-and the only problem encountered was the task of getting the heater up on the roof.

Location: Northern California mountains 40°30'N

Annual mean temperature: 52.8°F (11.5°C) Yearly

% possible sunshine: 60%

Source: Fred Klammt

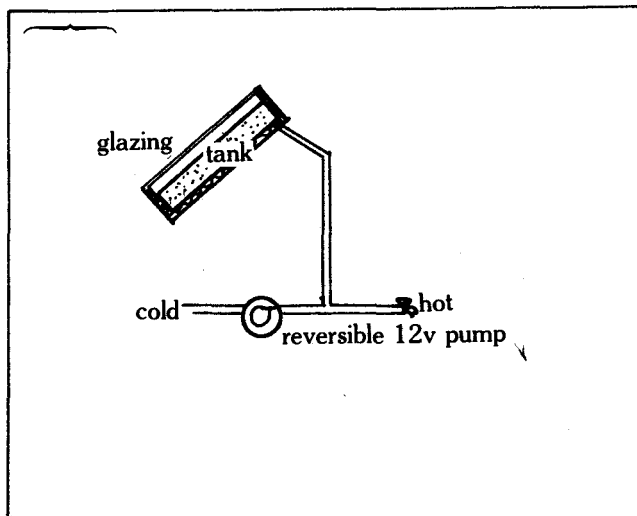

A Senior Citizen's IPSWH 1979

Solar water heaters aren't just for young folks as this heater in Tucson so clearly demonstrates. In fact these simple solar water heaters can be a real help to anyone on a fixed income faced with rapidly increasing energy prices.

The heater uses a recycled 40 gallon (151 l) glass lined gas water heater tank vertically inclined in an insulated box double glazed with 24 sq ft (2.2 sq m) of Lascolite. The glazing angle was set at 45° to improve winter performance. It has performed very well indeed, providing almost 100 percent of the hot water required for the year. The backup heater was turned off in April and on again in late November. Even when the backup heater is on its load is very low.

The owner was distressed to find she was paying \$2 per month for a meter reading charge even though the gas was completely off. In future years she plans to have service discontinued during this period of the year.

Location: Tucson, Arizona 32°20'N 111° W 2,500ft

Summer design dry bulb 5%: 100°F (38°C)

Summer daily outdoor range: 26°F (14°C)

Winter design temperature 99%: 23°F (-5°C)

Source: John Burton

A Coop Water Heater 1976

The Lehco-op Production System group developed a simple IPSWH that could be built with local materials and skills. It works quite well and a number of installations have now been made.

The Lehco-op heater uses a 3 ft x 3 ft x 2 in. (*about 1 m x 1 m x 5 cm*) rectangular tank built with galvanized iron sheet. This 17 gallon (64 l) tank is painted black and set in a pine box with window glass cover and insulation underneath the tank. The feed line is along the bottom and the hot water is drawn from the top.

The cost of the heater was about 60 rand, 70 rand installed, in 1978. The tank life is expected to be about five years—although the rest of the heater will be good for many years. Over the five year life of the water tank it will provide hot water at an equivalent energy cost of 0.023 rand per kwh, about half the then current price for electricity and cheaper than any other form of heating except dung or wood—when these are available.

Backup: stovetop, wood, dung or electric

Freeze protection: draindown

Location: Maseru, Lesotho 29°S 27.5°E

Nearest data: Johannesburg, South Africa

Summer design dry bulb 5%: 85°F (29°C)

Summer outdoor daily range: 23°F (13°C)

Winter design temperature 99%: 32°F (0°C)

Source: Willi Sureman, Solar Expert, Ministry of Rural Development, P.O. 686, Maseru, Lesotho

Capsule Collector 1979

John Golder has been involved in IPSWH research and development for several years in Santa Cruz, California. He has also built several IPSWHs with a reflective insulated blanket and sold many plan sets for them. His standard unit has one horizontal 30 gallon (114 l) glass lined tank wrapped with fiberglass glazing. The reflective insulated cover is flexible and wraps around the tank at night. It can be sent for optimum reflection during the day.

This heater provides a 30 to 35°F (17 to 19°C) temperature rise on a sunny day in a monitored installation in Santa Cruz. Temperatures typically drop 10 to 20°F (6 to 11°C) at night. The household using this monitored model is very careful when using hot water and used only slightly more than 10 gallons (38 l) of hot water per day over a year. This is less than 4 gallons (15 l) per day per person.

Location: Santa Cruz, California 37°N 122°W

Summer design dry bulb 5%: 80°F (27°C)

Summer daily outdoor range: 28°F (16°C)

Winter design temperature 99%: 32°F (0°C)

Source: John Golder

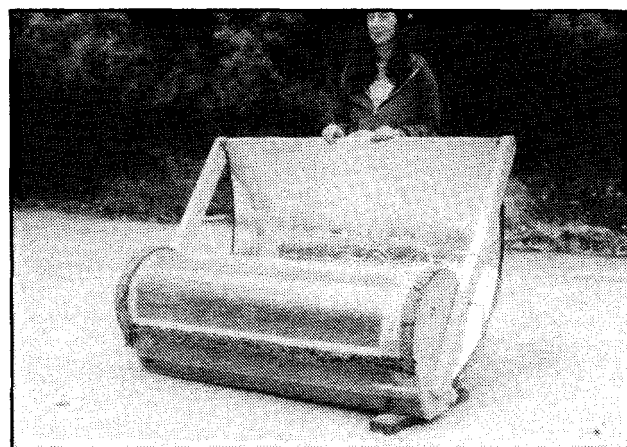
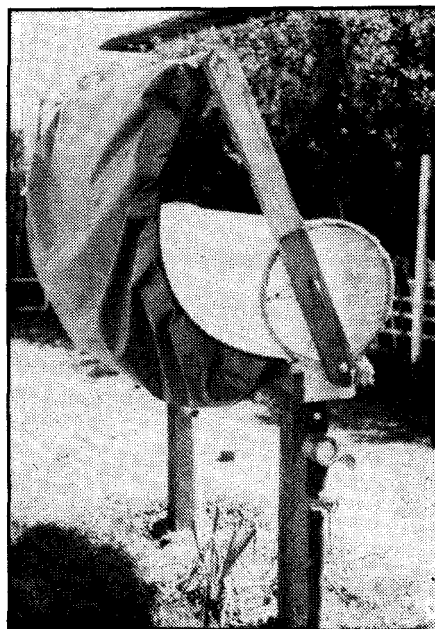

Courtesy John Golder

An IPSWH in India

1974

The need for an inexpensive, yet effective solar water heater for India has been realized for many years. R.S. Chauhan and V. Kadambi evaluated the various types of solar water heaters and concluded that an IPSWH would be the best alternative for India. They therefore developed an inexpensive tank type collector which can be built without welding using only glass, galvanized iron sheet, wood, glass wool, and simple hardware. The details of construction are shown in the accompanying drawing. A light insulated lid was developed to reduce night heat loss.

Performance was monitored under a variety of conditions and modes. Circulating the water with a pump showed little advantage. Typically water reached 122 to 140°F (50 to 60°C) at 11 to 12 noon, 140 to 158°F (60 to 70°C) at 12 noon to 1 p.m., and 158 to 176°F (70 to 80°C) at 1 to 2 p.m. The maximum temperature recorded was 187°F (86°C) at 3:30 p.m. with an ambient air temperature of 95°F (35°C). With the insulated lid installed, water temperatures of 131 to 135°F (55 to 57°C) were recorded at 7 a.m. after night cool down from temperatures of 165 to 171°F (74 to 77.5°C) at 8 p.m. the night before. Efficiency was calculated to be about 65 percent if the use kept tank water temperature below 140°F (60°C). A second layer of glass was found desirable to maintain efficiency at tank temperatures above 167°F (75°C).

Location: Kanpur, India 27°N 80°30'E
Nearest station: New Delhi

80°F Dry Bulb exceeded: 3,464
Summer design dry bulb 5%: 105°F (41°C)
Summer outdoor daily range: 26°F (14°C)
Winter design temperature 99%: 39°F (4°C)

Reference: "Performance of a Collector-Cum Storage Type of Solar Water Heater," R.S. Chauhan and V. Kadambi, *Solar Energy*, vol. 18, pp. 327-335, 1976.

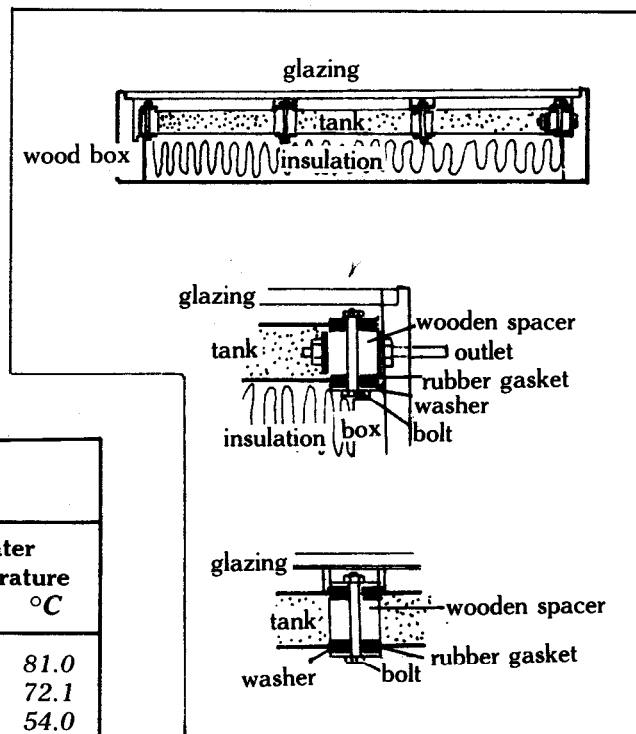

Table 1. Energy storage characteristics

	Date	Time	Ambient temperature		Water temperature	
			°F	°C	°F	°C
With glass cover only	25.4.74	3:30p.m.	110	43.2	178	81.0
		6:15p.m.	102	38.9	163	72.1
		10:45p.m.	88	31.3	129	54.0
	26.4.74	6:15a.m.	85	29.2	102	39.0
		30.4.74	3:30p.m.	106	41.0	185
	1.5.74	7:35p.m.	97	36.0	156	68.7
10:40p.m.		90	32.0	133	56.1	
6:30a.m.		82	28.0	101	38.5	
With additional insulated cover	2.5.74	3:45p.m.	108	42.0	182	83.5
		7:45p.m.	97	36.0	165	74.0
		11:15p.m.	90	32.5	153	67.0
	3.5.74	6:15a.m.	83	28.3	133	56.1
	5.5.74	4:15p.m.	107	41.8	189	87.5
		8:00p.m.	93	33.7	172	77.6
	6.5.74	11:30p.m.	89	31.5	157	69.3
		7:00a.m.	83	28.2	134	56.8

m)

Rodale's IPSWH 1980

The good folks at the innovative Rodale's Research Center (publishers of Organic Gardening, New Shelter, Bicycling, New Farm', etc.) have also done some work with IPSWH's. They chose the simplest system with only one 40 gallon (151 l) tank. This tank sits in an insulated wood box, 54 x 24 x 94 inches (137 x 61 x 239 cm), with a cusp reflector behind it made with aluminized Mylar on a hardboard form. The heater has 29 sq ft (2.7 sq m) of 3M's "7410" plastic glazing material.

The heater is plumbed into the feed line to the backup water heater. It has insulated lids which can be shut at night. It is expected the Rodale IPSWH will pay for itself in about six years. The heater itself cost \$490, and installation added another \$140. Net cost after the Federal tax credit was only \$378.

Location: Emmaus, Pennsylvania 40°30'N 75°30'W

Summer design dry bulb 5%: 87°F (31°C)

Summer daily outdoor range: 22°F (12°C)

Winter design temperature 99%: 3 of (.16°C)

Reference: Frederic S. Langa (1980), "The Sun on Tap: Pure and Simple," New Shelter, vol. 1, no. 7, October 1980.

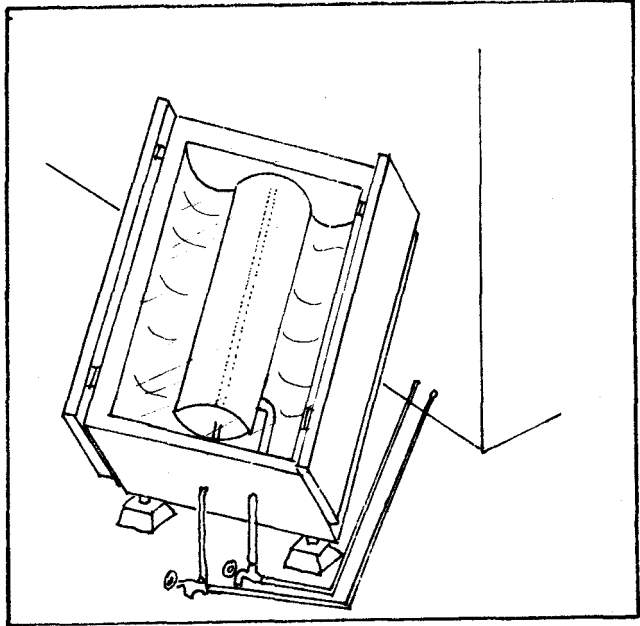

A Farm Worker Center IPSWH Project 1980

The Fred Young Farm Labor Center in Indio, California was retrofitted with thirty IPSWHs. Two two-tank units serve each 100 gallon (380 l), 90,000 BTU backup heater. There are five apartments for each heater system with an average of seven people per family. Thus although typical use per person is below U.S. average there is still a very large load for each heater system-as much as 400 gallons (1,500 l) per day-and the IPSWHs are only about one tenth the size suggested by normal design criteria. Even so, the heaters are expected by the design consultants, Davis Alternative Technology Associates, to meet 25 percent of demand.

The IPSWH units include two 30 gallon (114 l) glass lined tanks in a simple insulated wood box with 60 sq. ft. (5.6 sq. m.) of fiberglass glazing. The IPSWHs were built by the San Bernardino West Side C.D.C. The cost was about \$500 per heater for materials.

Location: Indio, California 33°40'N 115°20'W

Summer design dry bulb 5%: 105°F (41°C)

Summer daily outdoor range: 35°F (19°C) Winter design temperature 99%: 32° (0°C)

Source: Bruce Melzer, DATA

Reference: Melzer, B. and Maeda, B. (1980), Breadbox Design for the Fred Young Farm Labor Center, OAT A, California Solar Business Office.

An Economical Solar Water Preheater 1977

Ted Lucas was another of the pioneers in the resurgence of IPSWH activity in the United States. His book *How to Use Solar Energy* includes information on several IPSWH's including his own. It uses a 50 gallon (189 l) recycled water heater tank set in an insulated plywood box with double glazing. The horizontal tank rests in the center of a semiparabolic reflector built with foil faced foam.

The heater is 96 x 48 x 28 inches (244 x 122 x 71 cm) and has about 40 sq ft (3.7 sq m) of collector area thanks to domed glazing. The inner glazing is Tedlar film and the outer glazing is fiberglass reinforced plastic.

The heater provides 100°F (38°C) water on winter afternoons and up to 160°F (71°C) in the summer. The heater cost less than \$500 in 1977 and saved about \$20 per month on electric water heating bills.

Location: Fountain Valley, California 33°40'N 118°W
Nearest data: Santa Ana, California

Summer design dry bulb 5%: 86°F (30°C)
Summer daily outdoor range: 28°F (16°C)
Winter design temperature 99%: 33°F (0.6°C)

Reference: Ted Lucas (1978), *Economical Solar Water Preheater*, 10371 Stone River Ct., Fountain Valley, CA 92708

A Utility Sponsored IPSWH

The Union Electric Company in Missouri has been involved in developing and promoting IPSWH's. Work was begun in 1977 with William Tao and Associates as consultants. Their IPSWH uses two 30 gallon (114 l) galvanized tanks in parallel. These are set in an insulated wood box with 24 sq ft (2.2 sq m) of collection area. The inside of the box is shaped in a reflector behind the tank. Freeze protection is by draindown for the winter.

The utility has now sent out 2,500 sets of plans but has no record of the number actually built. Twelve units in the St. Louis area have been monitored for two years now. Performance has been good and the units have been trouble free. These heaters provide about forty percent of the hot water used by a family of three in St. Louis-for a cost of only \$350 in materials and two weekends of work.

Location: St. Louis, Missouri 38°40'N 90°40'W 500ft

Summer design dry bulb 5%: 92°F (33°C)
Summer daily outdoor range: 21°F (12°C)
Winter design temperature 99%: 4°F (-16°C)
HDD: 5,000

Source: Charles Gravely, Union Electric Company, P.O. Box 149, St. Louis, MO 63166.

Refrigerator IPSWH 1979

Charlie Burton's IPSWH uses two recycled refrigerator cases and two recycled 40 gallon (151 l) glass lined water heater tanks. The heater sits in adjustable racks on the garage roof. A pipe bridge had to be built for the hot water return to the house. It is double glazed with the glazing down inside the box so the covers could be closed. Performance has been good enough without the covers and they currently aren't installed.

The heater cost about \$500, but most of the cost was for the new footings and supports-which will also hold up a new redwood roof deck. The heaters themselves cost only about \$150. The Burtons estimate the IPSWH provides 50 percent of the hot water for the year. Summer afternoon temperatures reach 120°F to 130°F (49°C to 54°C) while winter afternoons are more commonly 80°F to 100°F (27°C to 38°C).

Location: Albany, California

Nearest data: Richmond, California

Summer design dry bulb 5%: 77°F (25°C)

Summer daily outdoor range: 17°F (9°C)

Winter design temperature 99%: 35°F (2°C)

Source: Charlie Burton



Washing Facility IPSWH 1981

All the hot water for the hand washing facility at the GIMM Dry Yards in Winters, California, comes from the IPSWH on the roof. It will typically provide hand washing water at three to four sinks for 10 to 20 people although midsummer use at the peak of activity at the yard may include 100. The season begins in May and ends in October and coincides nicely with the expected performance of the system.

The IPSWH uses one recycled 40 gallon (151 l) glass lined gas water heater tank. This is set in an insulated (R-16) box with 25 sq ft (2.3 sq m) of glazing, one layer of filon fiberglass. The IPSWH has no backup heater. It was designed and built by Marty Sengo with advice from the author. The heater cost less than \$100, thanks to clever use of recycled materials.

Location: Winters, California 38°30'N 121°50'W

Nearest data: Davis, California

Summer design dry bulb 5%: 94°F (34°C)

Summer outdoor daily range: 36°F (20°C)

Winter design temperature 99%: 30°F (-1°C)

Source: Marty Sengo

A Classic Breadbox Water Heater 1975

Steve Baer's work with IPSWH's in the early 1970's got many people started on their own IPSWH's. Jay Baldwin built a classic Baer bread box in Occidental, California at the Farallones Rural Center.

This simple solar water heater includes manually operated lids, a 90 gallon (341 l) horizontal tank, 48 sq ft (4.5 sq m) of single pane glass, and an insulated box painted black inside.

The system cost less than \$100 and has provided full water heating on sunny days between April and November and 25 to 75 percent the rest of the time. Wood is used for backup water heating. Summer water temperatures are typically 120°F to 150°F (49°C to 66°C) from noon til 9 p.m. Freeze protection is provided by the insulated lids.

The only complaint with the operation of the system is the necessity for manually closing the lids. The only difficulty with the installation was moving the completed heater from the ground to the roof.

Location: Occidental, California 38°30'N 122°45'W

Mean winter temperature: 45°F (7°C)

HDD: 3,000

Mean summer temperature: 70°F (21°C)

Winter % possible sunshine: 65%

Summer % possible sunshine: 75-80%

Source: Peter Zweig

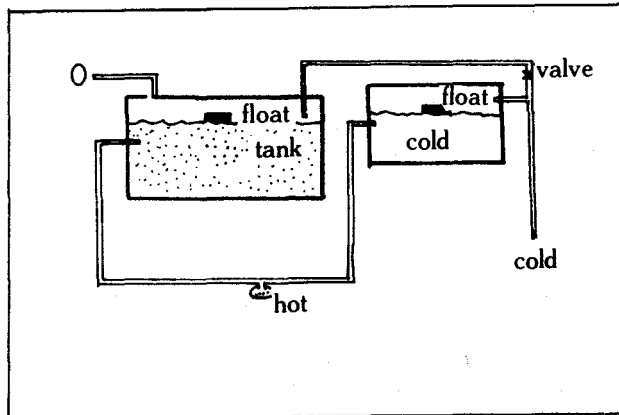

An Inexpensive IPSWH-with Lid

1980

The addition of glazing and an insulated lid becomes important in colder areas-yet needn't be expensive. Gene Watts of Alamosa, Colorado has built a 60 gallon (227 l) IPSWH with glazing and insulated, reflective lid for \$35. Gene's water heater is plumbed right into the house water system.

The heater tank is a stripped recycled electric water heater. Insulation is sawdust, crumpled newspaper, and fiberglass. The reflective lid uses used aluminum litho plates. The top is glazed with glass.

The insulated, reflective lid is raised in the morning and shut at night. Performance has been good enough in the summer for the backup electric water heater to be turned off.

Backup water heater: electric

Freeze protection: heat tape, draindown

Location: Alamosa, Colorado 37°3'N 105°50'W 7,536 ft

Summer design dry bulb 5%: 79°F (26°C)

Summer daily outdoor range: 35°F (19°C)

Winter design temperature 99%: -17°F (-27°C)

Reference: "A Homebuilt Breadbox Water Heater,"

Solar Flashes, November, 1980.

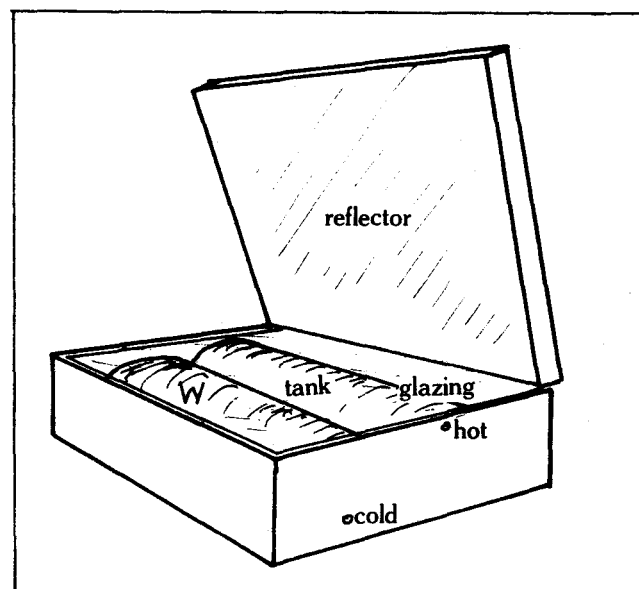

A Hot! Solar Water Heater 1980

John Burton has been one of the leaders in the resurgence of IPSWH's. In August, 1980 he led a workshop at the Farallones Center to build a two tank inclined IPSWH. The heater materials cost less than \$100 and the project took four days to complete, including design.

The heater has two 40 gallon (151 l) water heater tanks plumbed in series in an insulated box. There are 50 sq ft (4.6 sq m) of glazing. No lid was used and freeze protection is from thermal mass alone.

The heater has been almost too effective. With good exposure and 1.6 gallons per sq ft of glazing (65 l per sq m), the water temperatures have been very high. The electric backup heater thermostat was reset from 120°F (49°C) to 140°F (60°C) after the user complained that it was so much colder than the solar hot water.

Some rust from the recycled water heater tanks came through the lines due to inadequate rinsing of the tanks prior to installation.

Location: Occidental, California 30°30'N 122°45'W

Mean winter temperature: 45°F (7°C)

HDD: 3,000

Mean summer temperature: 70°F (21°C)

Winter % possible sunshine: 65%

Summer % possible sunshine: 75-80%

Source: Peter Zweig

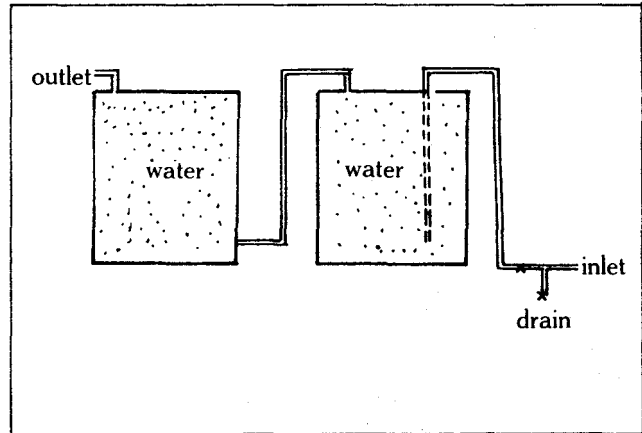

Burton Special 1979

Bob Burkhardt has devoted much of his time and energy in recent years to promote solar activities, including an innovative solar community. For hot water heating at his existing home he added a two tank system designed by John Burton. The IPSWH uses two 50 gallon (189 l) recycled glass lined gas water heater tanks inclined vertically in an insulated box. The box has 48 sq ft (4.5 sq m) of double glazed Kalwall fiberglass. It rests on a platform built near the back door of the house.

The heater was built under Burton's supervision as a project of the San Joaquin Valley Solar Association. He put in the footings for the platform Friday afternoon, plumbing connections were made Saturday afternoon, and the heater was finished at 2 p.m. on Sunday. This was followed by a cold beer. By 5 p.m. the water temperature had reached 150°F (66°C).

Location: Dinuba, California 36°30'N 119°20'W 350ft

Nearest data: Fresno, California

Summer design dry bulb 5%: 97°F (36°C)

Summer daily outdoor range: 34°F (19°C)

Winter design temperature 99%: 28°F (-2°C)

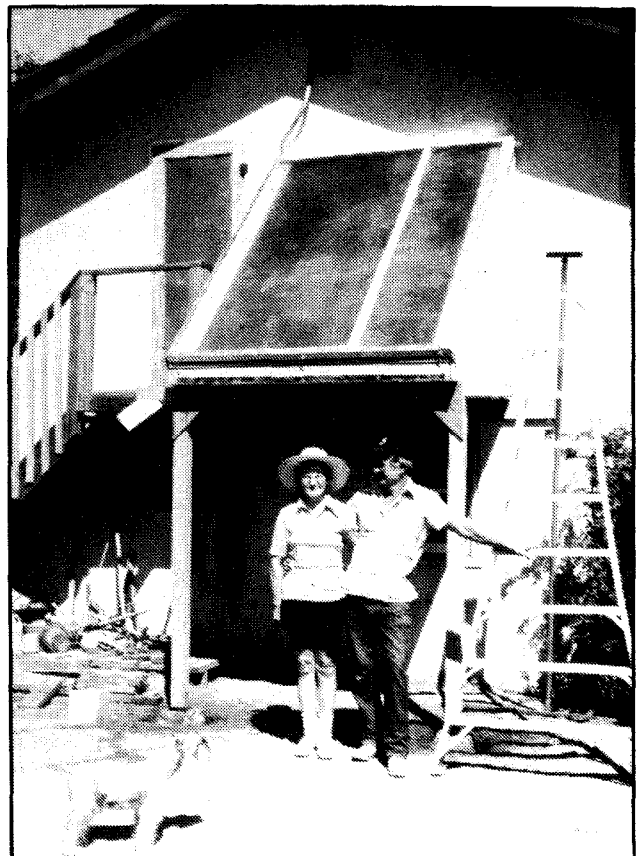

IPSWH in the Redwood Country

The folks on the north coast of California have also been active in IPSWH-despite the fog characteristic of the area. Tom Kelso of Passive Solar Designs has installed more than a dozen heaters in and around Arcata.

The typical IPSWH installation there would include two tanks with 60 gallons (227 l) total storage. This is set in an insulated box double glazed with tempered glass. The unit includes 36 sq ft (3.3 sq m) of collector. Most systems have been roof mounted. The systems are used in series with conventional heating systems-usually propane or gas, although wood has also been used.

The performance has been on the order of 50 to 75 percent with 100°F+ (38°C+) averaged in one heater. Payback is calculated at three years versus propane and five years versus electricity with the solar tax credits at current cost of \$895 plus installation.

Location: Arcata, California 41oN 124°20'W 200ft

Summer design dry bulb 5%: 63°F (17°C)

Summer outdoor daily range: 11°F (6°C)

Winter design temperature 99%: 32°F (DOC)

Source: Tom Kelso

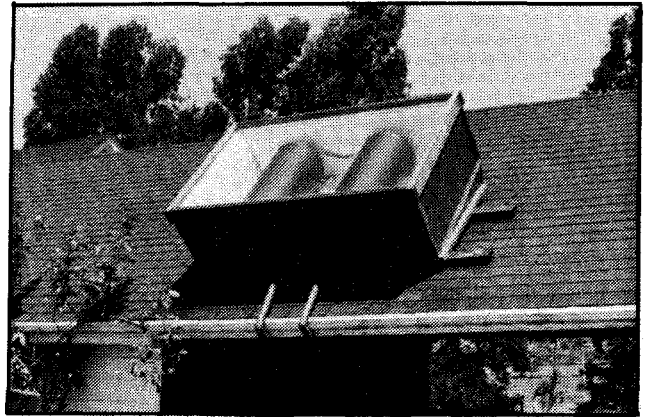

Little Egg 1980

The Little Egg IPSWH was developed by the designers at Net Energy and built by Solar Energy Trainees under Net Energy supervision. It has two 30 gallon (114 l) glass lined tanks inclined vertically within the insulated box. It has about 25 sq ft (2.3 sq m) of collector area, with two glazing layers. The exterior is Filon fiberglass and the inside is Tedlar film. The insulated box is wood framed and shaped like a quarter of a cylinder with a four foot (1.2 m) radius. The back is white, the sides are reflective foil. Materials for the heater cost around \$400.

The heater box is mounted on the ground, standing on blocks. It serves as a preheater for a conventional electric system. It is expected to provide 40 to 60 percent of the hot water for the year.

Location: Fortuna, California 40°40'N 124°30'W

Nearest data: Eureka, California

Summer design dry bulb 5%: 63°F (17°C)

Summer daily outdoor range: 11°F (6°C)

Winter design temperature 99%: 32°F (0°C)

Source: Net Energy

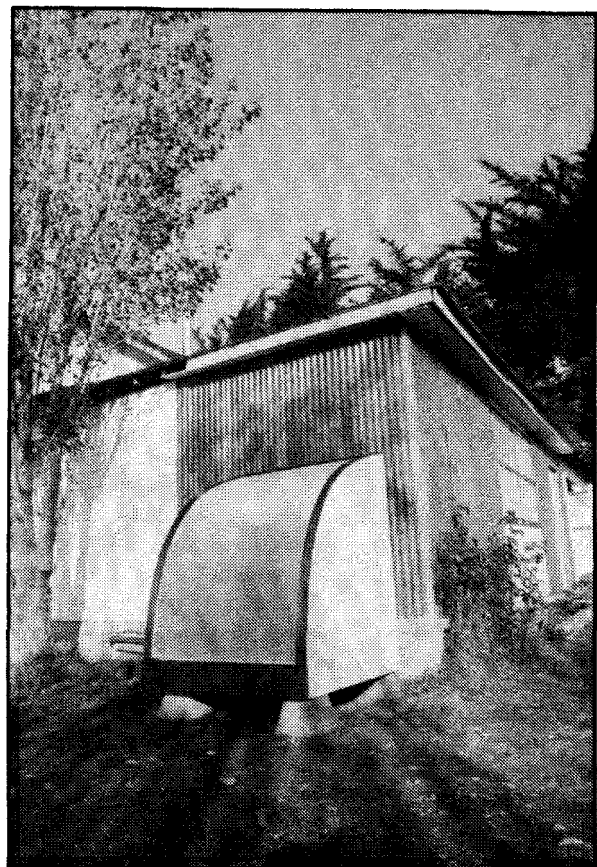

Mary Ellen King photo

Upside Down IPSWH 1980

By turning an IPSWH upside down it should be possible to reduce the radiant loss at night enough to make movable insulation at night unnecessary. Bristol Stickney and Curtis Nagy tested a 20 gallon (76 l) inverted heater in Santa Fe, New Mexico and showed that it was feasible with their \$360 collector.

The 20 gallon tank they used was a long, relatively slender, glass lined water heater tank designed for mobile homes. It was enclosed in insulation with a 2.94 sq ft (.273 sq m) double glazed window facing down toward a 9.3 sq ft (.864 sq m) parabolic reflector. The reflector was of 0.02 inch (5 mm) aluminum treated with Coricone® to prevent corrosion. The tank was tested painted with flat black enamel and with selective surface foil. The foil showed no improvement in performance.

The simple design of the reflector allowed collection for only three hours per day. Even this was enough to produce afternoon water temperatures of 104°F to 131°F (40°C to 55°C). Night heat retention was good with a drop of only 5 to 10°F (2.7 to 5.6°C). Usable hot water was available from 3 p.m. throughout the entire night following a sunny day. Average collection efficiency was calculated to be 30.9%.

Location: Santa Fe, New Mexico 35°4'N 106°W 7,045ft

Summer design dry bulb 5%: 85°F (29°C)

Summer outdoor daily range: 28°F (15.5°C)

Winter design temperature 99%: 7°F (-14°C)

Reference: B.L. Stickney and C. Nagy (1980), "Performance Comparisons of Several Passive Solar Water Heaters," **Fifth** Passive Solar Conference.

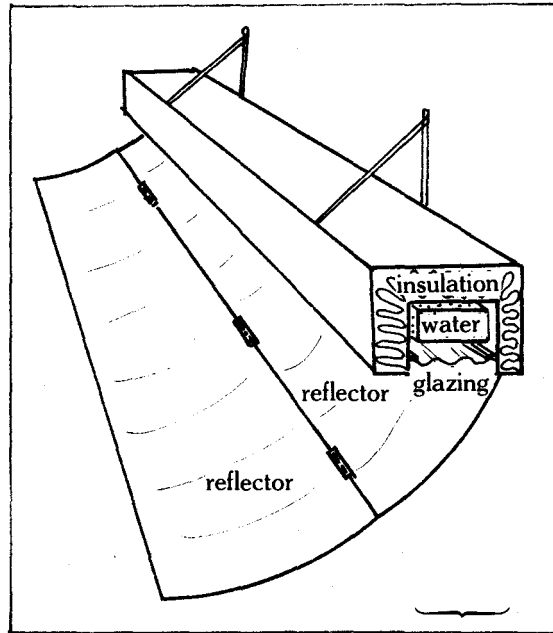
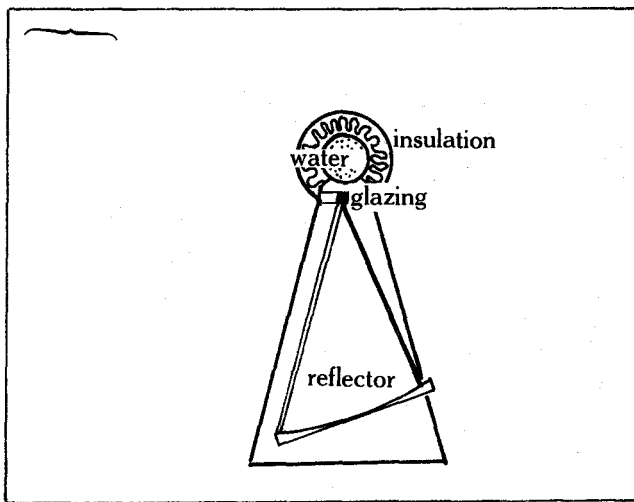

A Tunisian IPSWH

The hot arid days and cold nights of Tunisia and the fairly high cost of conventional fuels (\$55 per year) and water heaters (\$130) led to the development of a 15 gallon (57 l) inverted IPSWH for local use. This heater was designed for in line use with good night heat retention-yet no need for daily adjustment. Instead, seasonal adjustment regulates the angle of the movable reflector.

The 4 x 10 x 79 inch (10 x 25 x 200 cm) water tank was built from .024 inch (.6 mm) galvanized sheet metal at the local blacksmith. The problems in building the tank led to the development of a better crimping tool and healthy interaction between local blacksmiths and the solar designer. This eventually led to the local smiths taking over commercial production of the solar heater.

The tank is insulated on the top and sides with cork protected by cement and has a 10 x 79 inch (25 x 200 cm) corrugated plastic window facing down toward 20 sq ft (1.9 sq m) of fixed and movable reflectors. The reflectors were made with aluminum foil glued to the galvanized sheet.

With ambient temperature of 100°F (38°C) and inlet temperature of 75 to 80°F (24 to 29°C) the heater produced 167°F (75°C) water in two hours. Water was added and reached 157°F (69°C) by evening. Morning temperature was still 152°F (67°C). This first heater was installed at the local mosque-where it is used for foot washing before entering the mosque for prayer.

Location: Makthar , Tunisia

Nearest data: Tunis, Tunisia 36°47'N 10°12'E 217 ft

Summer design dry bulb 5%: 96°F (36°C)

Daily outdoor range: 22°F (12°C)

Winter design temperature 99%: 33°F (0.6°C)

Source: Alan Wyatt

VITA
3706 Rhode Island Ave.
Mt. Rainier, MD 20822

An IPSWH for a Solar Future (1979)

As part of an imaginative and superb retrofit of an older house in Sacramento, an IPSWH was added. Jeff Reiss and John Burton built a support platform as a shelter for the back door to ensure better solar access for the heater.

This tasteful IPSWH has two recycled 40 gallon (151 n) tanks inclined at 45°. These sit in a well insulated (R19) box glazed with 45 sq ft (4.2 sq m) of two layers of Kalwall Sunlite, a fiberglass glazing. A reflector at 75° provides additional gain in the winter-without shading the heater in the summer. The two tanks are plumbed in series with water drawn from the top of the west tank which has the best morning exposure.

The heater cost \$150 for plumbing and \$250 for other materials. It performs well, meeting 100 percent of the late spring to fall demand and probably 60 to 70 percent of the hot water on a yearly basis. A conventional gas water heater is used for backup heating. Fall temperatures have reached 160°F (71°C). A roll down thermal curtain may be added to extend performance.

The existing hot water system has also been upgraded with flow restrictors and retrofit blanket for the water heater. When the backup heater is used, the thermostat is set on low, about 120°F (49°C).

Location: Sacramento, California 38°30'N 121°30'W 20ft

Summer design dry bulb 5%: 94°F (34°C)

Summer outdoor daily range: 36°F (20°C)

Winter design temperature 99%: 30°F (-1°C)

Source: Jeff Reiss, Solar Future, P.O. Box 19453, Sacramento, CA 95819

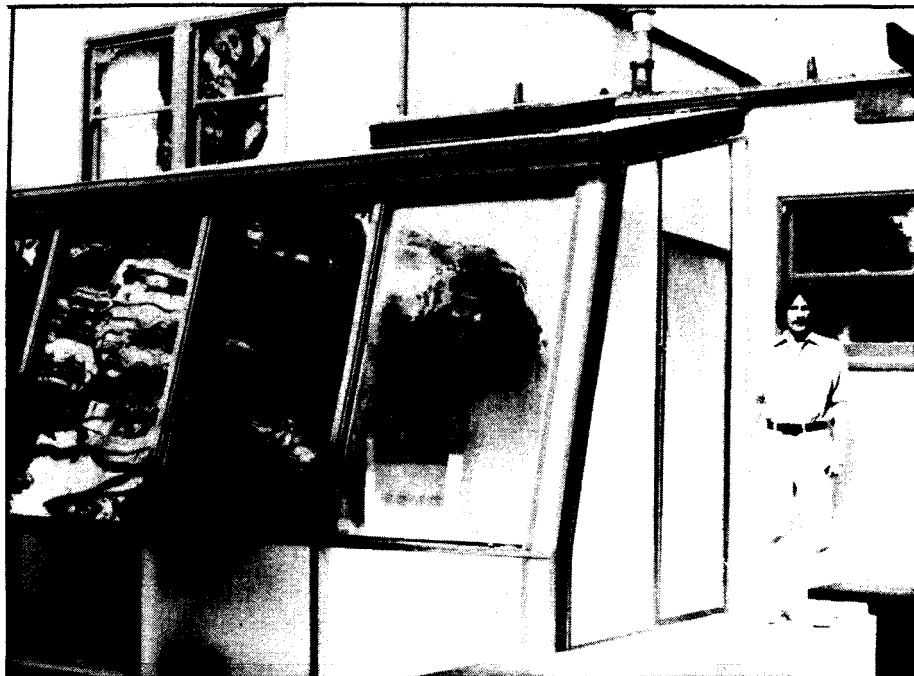
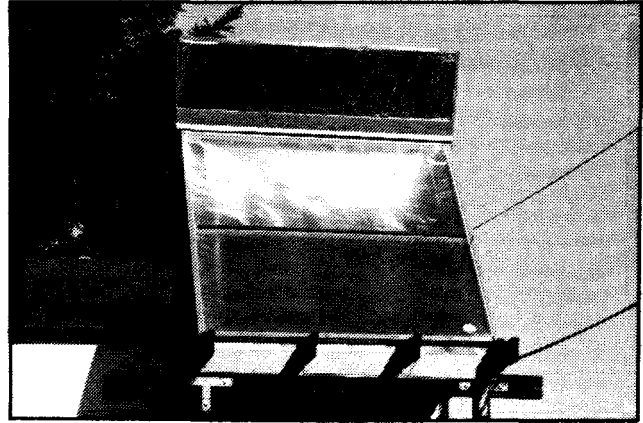

An IPSWH in Ceylon

The development of an IPSWH for Ceylon was undertaken by J.C.V. Chinnappa and K. Gnanalingnan in the late 1960's and continued into the early 1970's. They finally settled on a 44 foot long (13.4 m) square coil of 3 inch (7.6 cm) diameter pipe in an insulated box with 20 sq ft (1.9 sq m) of double glazing. This simple collector was connected to the mains and hot water was drawn off when it reached 120°F (49°C). On most days 30 to 50 gallons (114 to 190 l) of water at 120°F (49°C) could be drawn off for use.

The performance of the heater was thoroughly evaluated and a computer program was prepared to evaluate annual performance. This work suggested that no water could be drawn off on about 10 percent of the year. For an additional 10 percent of the year only one batch could be drawn off.

The efficiency of the collector was calculated to be 46%, based on the exposed glass area which is 1.55 times larger than the horizontally projected area of the pipe. Different pipe diameters were compared by a computer program which indicated diameters between 2.5 and 3.5 inches (6.35 and 8.9 cm) would be most appropriate.

Location: Colombo, Ceylon 6°54'N 79°52'E 24 ft

Summer design dry bulb 5%: 89°F (32°C)

80°F dry bulb exceeded: 2,870 hours

Summer daily outdoor range: 15°F (8°C)

Winter design temperature 99%: 69°F (21°C)

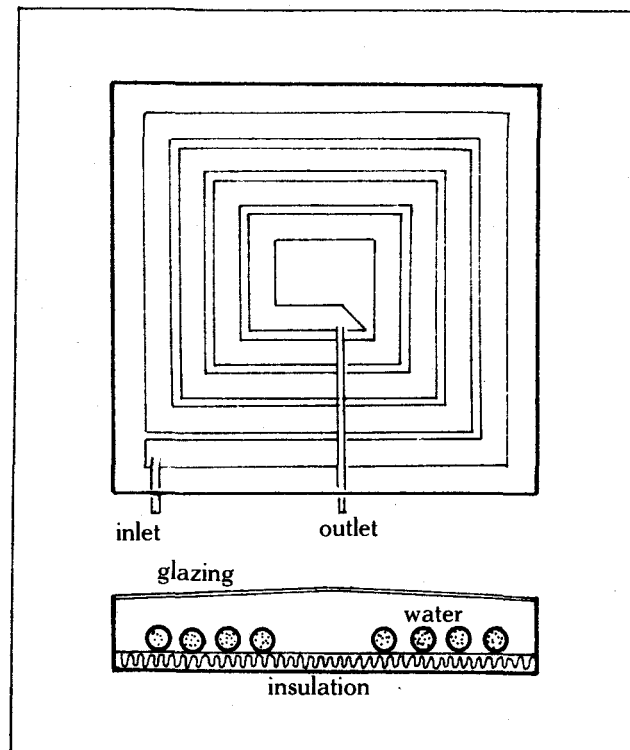

Reference: "Performance at Colombo, Ceylon, of a Pressurized Solar Water Heater of the Combined Collector and Storage Type," J.V.C. Chinnappa and K. Gnanalingnan, *Solar Energy*, vol. 15, pp. 195-204, 1973.

Table 1. Results of Tests on Solar Water Heater

Date (1969)	Time (hr)		Water temperature				Hot water drawn off lb (kg)	Total heat collected BTU	Total insolation BTU/ft ²
	from	to	°F	(°C)	°F	(°C)			
11 Feb	7:40	11:30	76	(24.4)	120	(48.9)	130 (59)	19060	2072.5
	11:30	13:06	82	(27.8)	120	(48.9)	136 (62)		
	13:06	14:55	82	(27.8)	120	(48.9)	136 (62)		
	14:55	17:00	82	(27.8)	104	(40.0)	-- --		
12 Feb.	8:00	11:20	80	(26.7)	120	(48.9)	133 (60.3)	20100	2170.0
	11:20	13:45	83	(28.3)	135	(57.2)	134 (61)		
	13:45	15:40	82	(27.8)	122	(50.0)	134 (61)		
13 Feb	15:40	17:15	82	(27.8)	100	(37.8)	-- --	19120	2000.0
	8:40	11:40	80	(26.7)	118.5	(48.0)	132 (60)		
	11:40	13:07	81	(27.2)	118	(47.8)	132 (60)		
	13:07	14:35	81	(27.2)	119	(48.3)	133 (60.3)		
14 Feb	14:35	17:10	81	(27.2)	111	(43.9)	-- --	18660	1875.0
	8:07	11:38	82	(27.8)	125	(51.7)	132 (60)		
	11:38	13:04	82	(27.8)	121	(49.4)	133 (60.3)		
	13:04	14:35	82	(27.8)	119.5	(48.6)	132 (60)		
19 Feb	14:35	15:45	82	(27.8)	103	(39.4)	-- --	10730	1985.0
	8:30	16:04	101	(38.3)	180	(82.2)	-- --		

A Mobile Home IPSWH 1980

IPSWH's also make sense for mobile home dwellers.

This two tank system is ground mounted on the south side of a mobile home near McKinleyville, California. It has two 30 gallon (114 l) glass lined water heater tanks plumbed in series. The insulated box faces south and has a 45 degree glazing angle. It has 25 sq ft (2.3 sq m) of single pane tempered glass with an inside layer of Tedlar plastic film.

This simple heater was built by Solar Energy Trainees under the supervision of Net Energy. Materials costs about \$400. The heater water temperature is usually 100°F+ (38°C+) on sunny afternoons, dropping to 70°F (21°C) in the early morning. It provides about 50 percent of the hot water for the year.

Location: McKinleyville, California 41°5'N 124°30'W
Nearest data: Eureka, California

Summer design dry bulb 5%: 63°F (17°C)
Summer daily outdoor range: 11°F (6°C)
Winter design temperature 99%: 32°F (0°C)

Source: Net Energy

A Triple Tanker 1980

This heater is based on the design I used for my heater in Davis-which was based on the work of F.A. Brooks in 1936. Three 30 gallon (114 l) glass lined tanks are used with hot water drawn from the top of the center tank. These tanks are set in an insulated box on the ground with 45 degree glazing facing south. The collection area is about 25 sq ft (2.3 sq m) of single pane tempered glass. It was built for about \$500 by Solar Energy Trainees under the supervision of Net Energy.

The heater is providing about 40 percent of the hot water for a family of four, with a baby and eight-year-old helping to keep water use up. The low performance is also attributable to a poor glass to water ratio with one tank too many for the glass area. The heater provides preheating for a conventional gas heater.

Location: Arcata, California 41°N 124°30'W

Summer design dry bulb 5%: 63°F (17°C)
Summer daily outdoor range: 11°F (6°C)
Winter design temperature 99%: 32°F (0°C)

Source: Net Energy

An Early IPSWH 1975

One of the early IPSWH's in the western U.S. was built by Horace McKracken near Lakeside, California. This used five 30 gallon (114 l) glass lined water heater tanks plumbed in series. These are painted black and placed horizontally in a simple wedge shaped box. The collector area is 24 sq ft (2.2 sq m).

An innovative method is used to reduce night heat loss. The exposed front of the tanks is covered with "angel hair" fiberglass (of the type commonly used for furnace air filters). This transmits 85 percent of the light through one inch and has increased tank temperature 5°F (2.8°C) in tests.

The heater performance has been very good and has made the \$850 cost for the installation a bargain. It provides 75 percent of the hot water for the family of three, saving about 4,000 kwh per year. Assuming a cost of 6 cents per kwh, this heater saves \$240 per year.

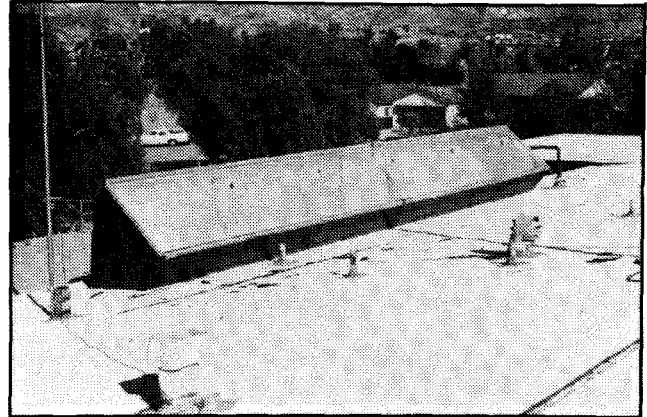

Location: Lakeside, California 33°N 117°20'W

Nearest data: San Diego, California

Summer design dry bulb 5%: 80°F (27°C)

Summer daily outdoor range: 12°F (7°C)

Winter design temperature 99%: 38°F (3°C)

Source: Horace McKracken

Reference: Horace McKracken (1980), How to Build a Passive Solar Water Heater, 329 W. Carlos, Alturas, CA 96101

A Desert IPSWH 1977

The hot, dry Imperial Valley of southern California is an ideal location for IPSWH use. Horace McKracken built a simple IPSWH there in 1977 which has worked very well. It consists of 30 gallon (114 l) glass lined water heater tanks set in a horizontal, wedge shaped insulated box. The heater has 20 sq ft (1.9 sq m) of glass collector area. The tanks are covered with "angel hair" fiberglass insulation to reduce night heat loss.

The installation cost \$500 and provides full hot water for two adults from March through November. Even in December and January the water was almost warm enough and in February averaged 96°F (36°C) during tests, so the backup heater has little work to do.

Location: Imperial Valley, California 30°30'N 115°30'W

Nearest data: Palm Springs, California 33°5'N

Summer design dry bulb 5%: 105°F (41°C)

Summer daily outdoor range: 35°F (19°C)

Winter design temperature 99%: 32°F (0°C)

Source: Horace McKracken

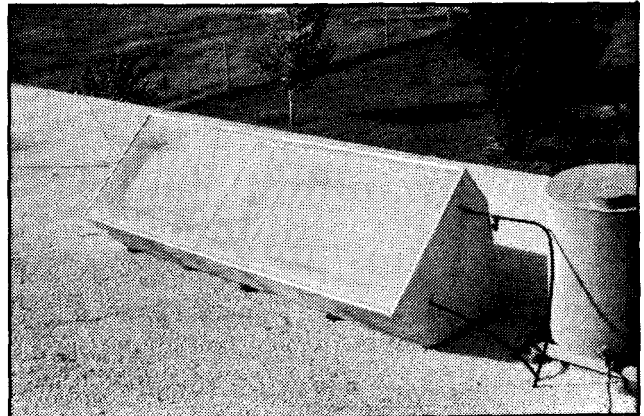

Courtesy Horace McKracken

An IPSWH with a Night Cap 1978

Peter Zweig designed and led the workshop that built this interesting IPSWH. The heater cost about \$200 and took a weekend to build.

The heater originally had three inclined 30 gallon (114 l) tanks in an insulated box with 36 sq ft (3.3 sq m) of glazing. This provided 2.5 gallons per sq ft of glass (102 l per sq m) and didn't warm up enough. With one of the three tanks bypassed, and 1.7 gallons per sq ft (69 l per sq m), it has worked quite well. It provides 100 percent on sunny days May through October and 25-75 percent on other days. Summer temperatures are 120°F to 150°F (49°C to 66°C) from noon to 9 p.m. Backup water heating is by wood stove to the IPSWH tank.

Insulated night caps were tried for night cool down protection. These R-12 polyurethane foam caps on the tops of the tanks have not worked because of the large diameter of the tanks and resultant internal circulation. Freeze protection is by mass alone and has proved sufficient to date.

Location: Occidental, California 38°30'N 122°45'W

Mean winter temperature: 45°F (7°C)

HDD: 3,000

Mean summer temperature: 70°F (21°C)

Winter % possible sunshine: 65%

Summer % possible sunshine: 75-80%

Source: Peter Zweig

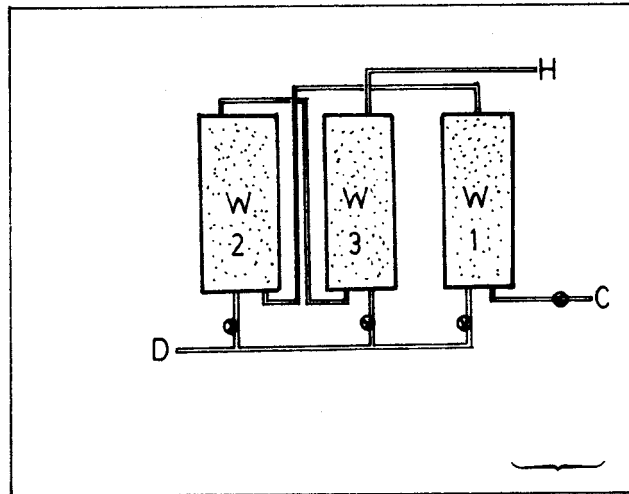

A Small Three Tank System 1978

Work in Davis by Marshall Hunt and Gary Starr suggested that F.A. Brooks' recommendation of the three tank inclined IPSWH might be worth following. This three tank system was built by Max Kroschell following the design developed during Starr's research. It cost less than \$50 to build and took a weekend workshop and a week of finish work.

The heater uses three inclined 12 gallon (45 l) soft water tanks connected in series with the center tank providing the outlet. An insulated box and 15 sq ft (1.4 sq m) of glazing provide good performance with 2.4 gallons per sq ft (98 l per sq m). The heater was built into a 3:12 pitch roof.

The heater has an insulated boat-hatch-type lid hinged on the top. The lid is operated with a winch from the bedroom window. The lid is used to prevent night cool down and for winter freeze protection.

This low cost, nicely integrated heater provides 100 percent of hot water from May through October. The only problem encountered with this heater is rusting of the soft water tanks-hot water now comes out rusty.

Location: Occidental, California 38°30'N 122°45'W

Mean winter temperature: 45°F (7°C)

HDD: 3,000

Mean summer temperature: 70°F (21°C)

Winter % possible sunshine: 65%

Summer % possible sunshine: 75-80%

Source: Peter Zweig

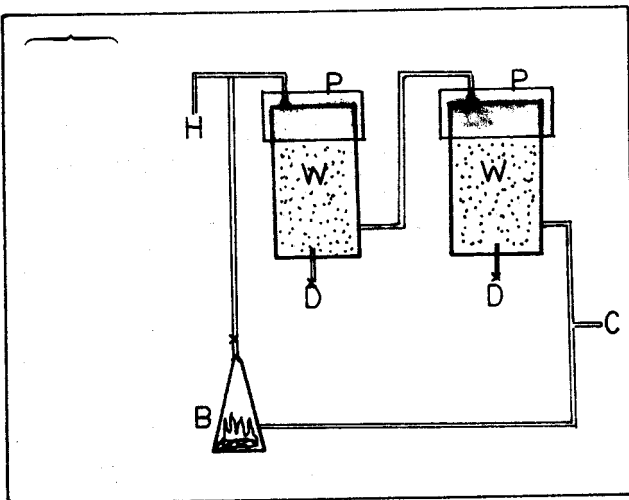

Bainbridge IPSWH 1978

My first hands on experience with IPSWH's was gained in 1978 when I built one for my passive solar heated and cooled house in Davis, California. I was able to put my heater on a flat carport roof, strengthened to support the load.

I used three 30 gallon (114 l) glass lined water heater tanks set at 45° in a well insulated box. The sides and bottom front inside were reflective for added gain on the tanks. The box was single glazed with 48 sq ft (4.5 sq m) of fiberglass. The tanks were in series with the middle tank the final feed tank. The pipe run was insulated with two inch (5 cm) polyurethane foam with an aluminum jacket for added freeze protection.

The performance was good with full heat from May through October and 25 to 75 percent through the rest of the year. For best performance the gas water heater was bypassed and turned off in the summer. Showers were occasionally cool in the morning, particularly in the spring, but rescheduling to fit supply was easily done. A water saver shower head ensured maximum shower time.

Backup water heater: gas

Freeze protection: none

Location: Davis, California 38°30'N 121°32'W 30ft

Summer design dry bulb 5%: 94°F (34°C)

Summer outdoor daily range: 36°F (10°C)

Winter design temperature 99%: 30°F (-1°C)

Mean July temperature: 75°F (24°C)

Yearly % possible sunshine: 79%

o)

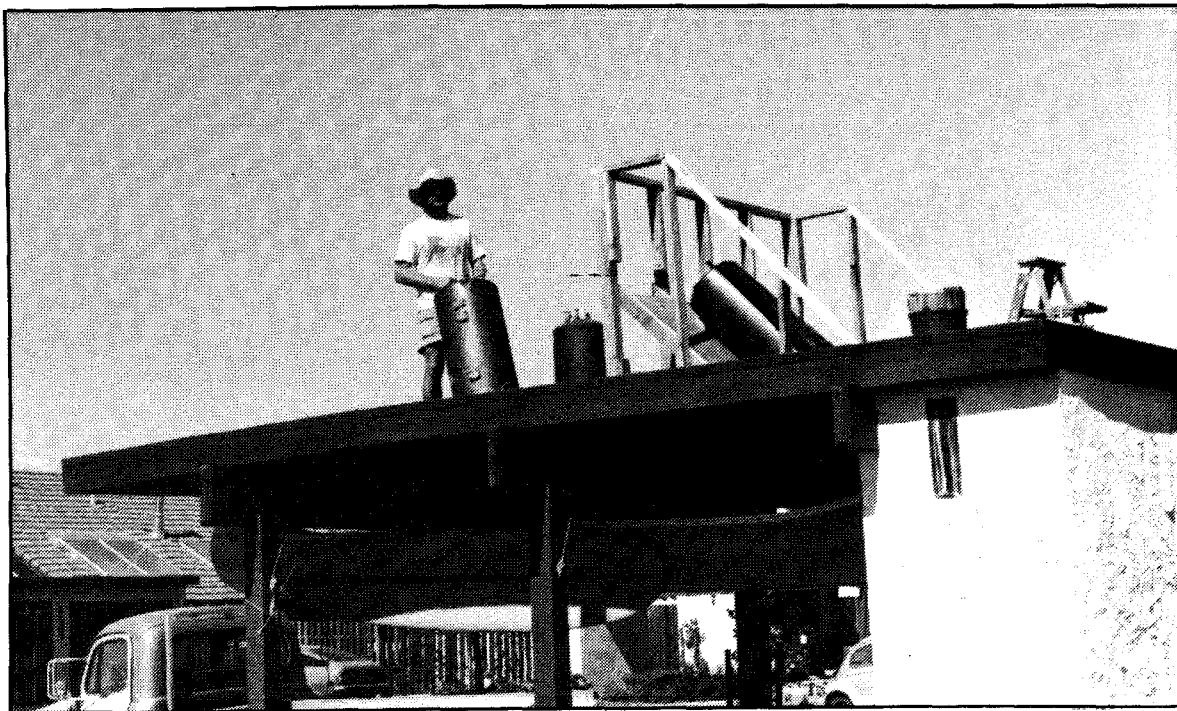
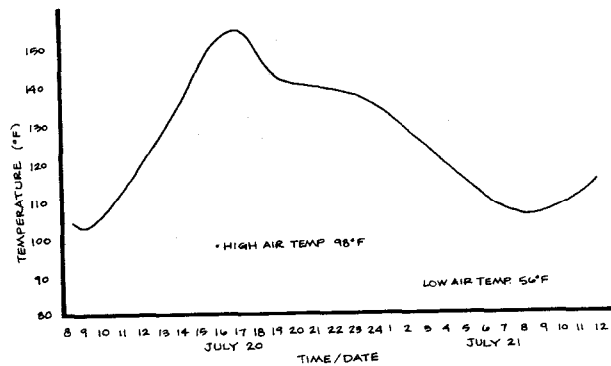
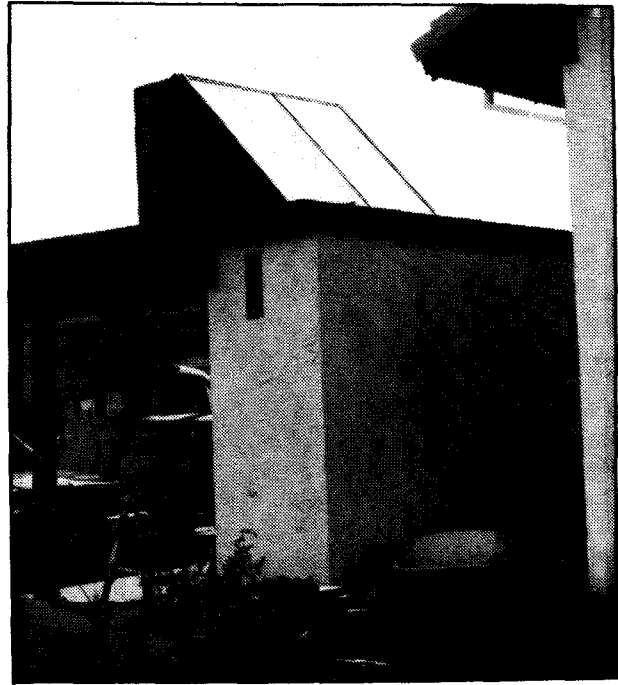

Bob Scutley photo

An IPSWH for Water and Space Heating 1980

This system shows that passive solar water heaters can be used for more than just water heating. Marshall Hunt designed and Bent Nail Construction built this system for a passive solar house designed by Paul Feller. It includes four 40 gallon (151 l) glass lined tanks plumbed in series.

These tanks are set in the roof, resting in an insulated heater room in the attic. The box is double glazed with four 30 x 96 inch (76 x 244 cm) Kalwall insulating glazing panels set flush with the roof.

In the summer the system provides full domestic water heating. In the winter it provides preheating for the gas water heater. The water heater provides backup space heating for the passive solar water wall system with a Turbonics "chill chaser" and two slave units. As the coldest days in the area are the clear days following the passage of storms, the passive solar water heater will contribute more than might be expected.

The system cost \$1,900, \$855 after state tax credits, and should pay for itself within five years.

Location: Davis, California 38°30'N 121°32'W 30ft

Summer design dry bulb 5%: 94°F (34°C)

Summer daily outdoor range: 36°F (20°C)

Winter design temperature 99%: 30°F (-1°C)

Source: Virginia Thigpen

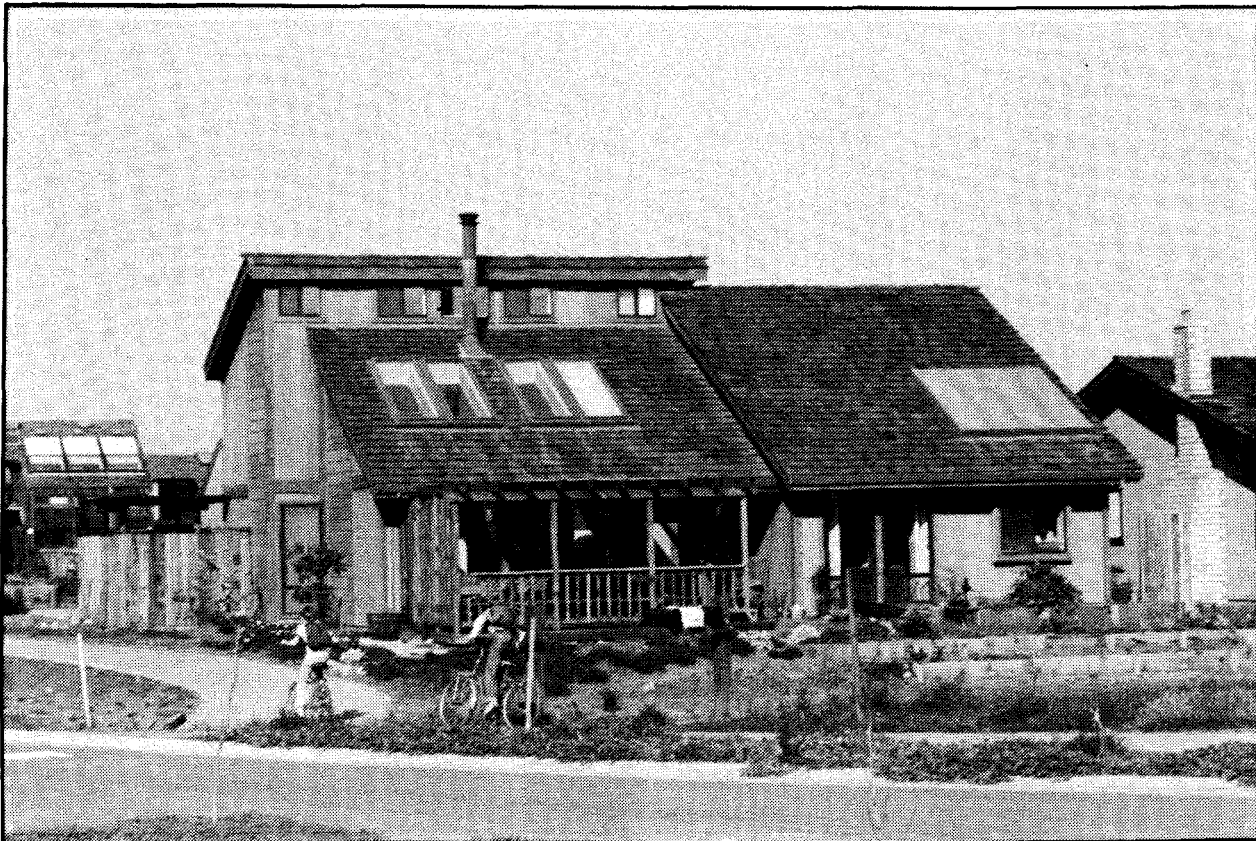
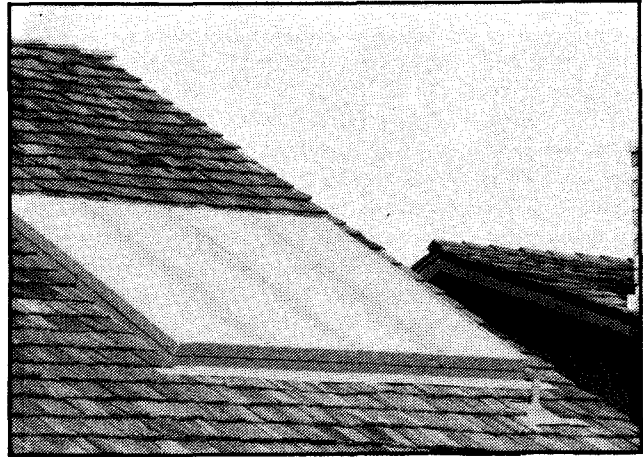

A Matter of Course IPSWH 1980

The big challenge for any new product is making the transition from a cottage industry, often with highly motivated but poorly paid workers, to business as usual. The critical step toward commercializing IPSWH's is perhaps most nearly realized in the IPSWH used by Bent Nail Construction on their most recent passive solar house in Davis, California.

This very attractive water heater has four 40 gallon (151 l) tanks set in the 5:12 roof above the kitchen. The tanks are plumbed in series and routed to the conventional gas water heater. The IPSWH provides domestic hot water (dhw) in the summer and serves as a preheater for dhw and space heating in the winter. A "chill chaser" and two "hide-a-vectors" from Turbonics provide space heat backup for the passive space conditioning system using the conventional gas heater and the IPSWH as heat sources.

The heater is glazed with three 92 x 109 inch (234 x 277 cm) Blomberg skylights set in a standard skylight frame, which hinges them at the top for access. This is set down on the curb, which is flashed to the tile roof before the skylights are added.

Source: Virginia Thigpen

The beauty of the system is more than skin deep-it includes ease of construction as well as aesthetics. The contractor was able to have virtually all of the heater work done by subcontractors-framing by framers, insulation by insulators, painting by painters, plumbing by plumbers, and glazing by glaziers. The only step performed directly by the contractor was installation of a drip pan under the heater and the plywood box walls. As a result the heater was started and finished in a week.

The system cost \$2,500 (\$1,125 after the State tax credit) and will provide eight months of virtually full water heating and a considerable contribution to winter water heating and space conditioning.

Backup water heater: gas

Freeze protection: none

Location: Davis, California 38°30'N 121°32'W 30ft

Summer design dry bulb 5%: 94°F (34°C)

Summer daily outdoor range: 36°F (20°C)

Winter design temperature 99%: 30°F (-1°C)

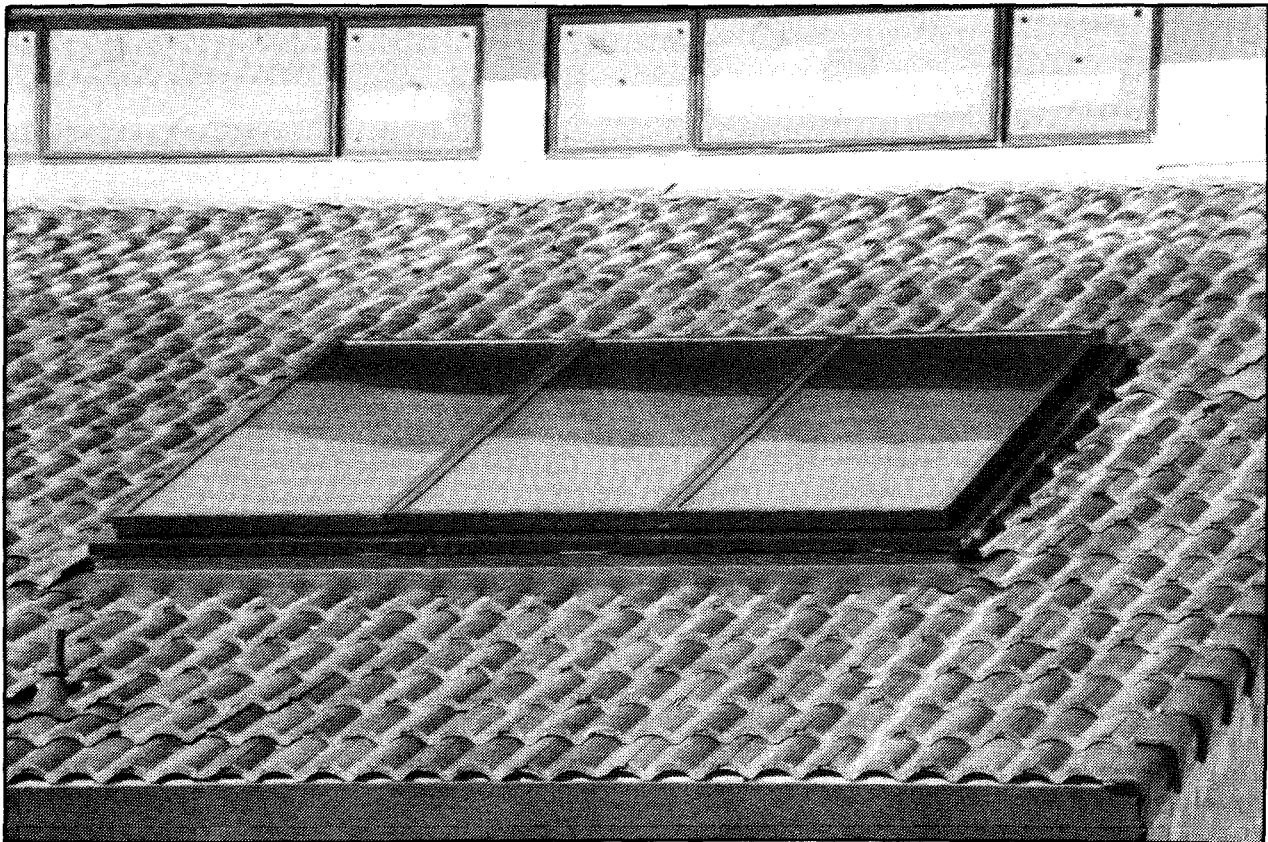

There is an excellent example of cold climate IPSWH design in Manchester, New Hampshire. It combines space heating and water heating in a glazed attic space with an insulated shutter to control night heat loss.

The passive space heating system includes a row of Kalwall Solar Storage tubes set vertically under the peak of the attic. The three 30 gallon (114 l) glass lined water tanks of the IPSWH rest horizontally in front of these tubes. The entire south side of the roof is glazed with Kalwall Sunlite and provides a collection area of 325 sq ft (30.2 sq m). The one piece reflective insulated shutter is operated by a chain drive from a gear motor. This is controlled by a differential thermostat.

Monitoring was conducted over a year in this superb passive house. The IPSWH provided 66 percent of the hot water load, 40 gallons a day at 120°F (151 l at 49°C), and the space conditioning system provided 72 percent of the space heating.

Location: Manchester, New Hampshire 43°N 71°5'W 253 ft

Summer design dry bulb 5%: 86°F (30°C)

Summer daily outdoor range: 24°F (13°C) Winter design temperature 99%: -5°F (-21°C)

Reference: A.V. Sedrick et.al. (1980), "Low Cost Hybrid Passive Solar Attic," 4th National Passive Conference, Kansas City.

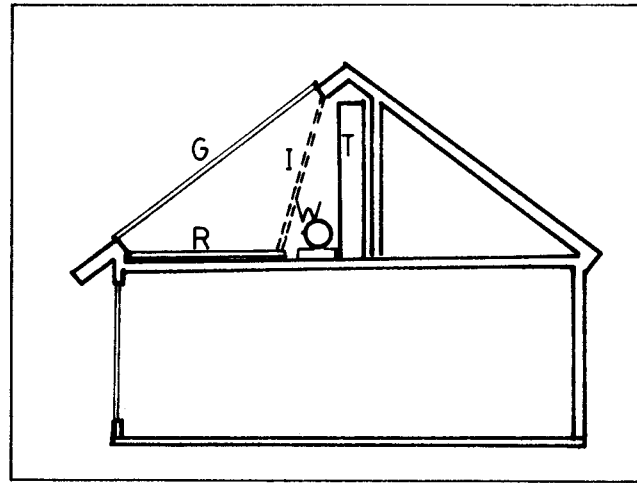

A Lidded Triple Tank 1980

The foothills near Grass Valley, California have become a hot bed of solar activity with many different types of solar houses and hot water systems. One of the nicer IPSWHs built in the area was designed and built by Jack Androvich in Rough and Ready. The triple tanker uses three 30 gallon (114 l) glass lined water tanks plumbed in series with the hot outlet from the center tank. It is glazed with tempered glass and has a reflective insulated lid which folds down.

Location: Rough and Ready, California 39°15'N 121°5'W
Nearest data: Auburn California

June average daily maximum: 85.4°F (29.7°C)

June average daily range: 29.9°F (16.6°C)

December average minimum: 36.4°F (2.4°C)

Source: Jack Androvich

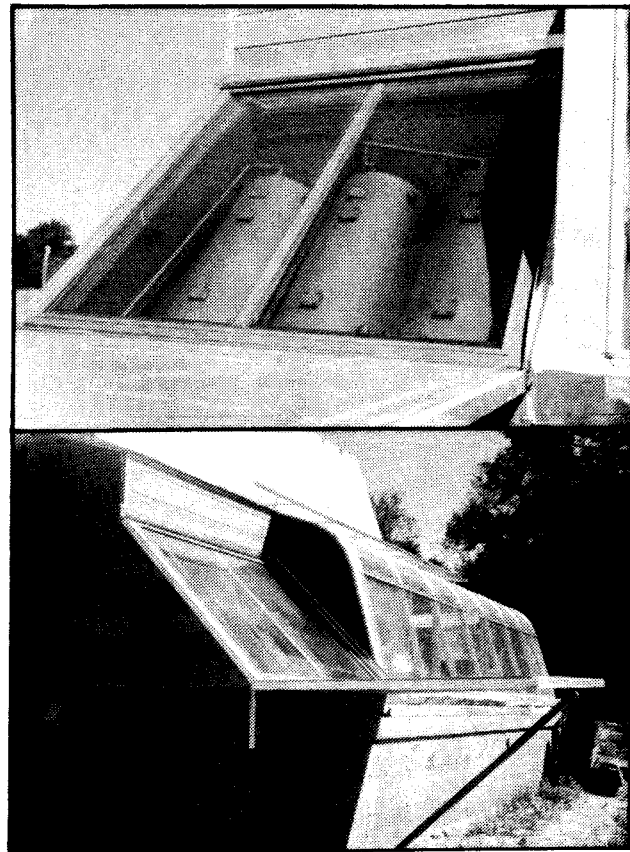

Courtesy Jack Androvich

A Factory IPSWH

1977

Horace McCracken has built one of the few IPSWH's I am aware of for commercial use in the U.S. The heater was built in 1977 for a factory where it is used for hand washing and shower water for one hundred people. It uses five 40 gallon (151 l) glass lined water heater tanks set horizontally in series in an insulated box.

The installed heater cost the buyer \$1,500 and required about eight days of labor for construction and installation. It was used with conventional backup heat originally-but the backup heater has subsequently been removed.

Location: San Diego, California 32°45'N 117°29'W

Summer design dry bulb 5%: 80°F (27°C)

Daily outdoor range: 12°F (7°C)

Winter design temperature 99%: 38°F (3°C)

Source: Horace McCracken

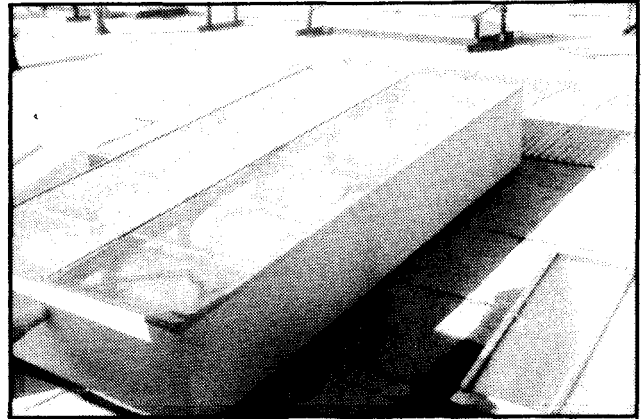

Courtesy Horace McCracken

An Institutional IPSWH 1979

The OARS river touring company runs wildwater tours all around the world but their major base is in a remote area of the Sierra foothills of California. In the summer a staff of twenty is involved in tour support at this base and the demand for hot showers is very strong. John Burton designed and built an IPSWH shower for them using three 40 gallon (151 l) glass lined water tanks set in an insulated 2 x 6 inch (2 x 15 cm) framed box. These are plumbed in series with hot water drawn from the center tank. The heater is double glazed with almost 100 sq ft (9.3 sq m) of fiberglass.

The heater support structure serves as the shower enclosure. With two low flow (2 gallons per minute) shower heads the heater provides about 100 minutes of shower time a day. The cost of \$1,750 was well worth it, providing fairly fast payback and much needed hot water in this remote location.

Location: near Angel's Camp, California 38°10'N 120°30'W 1,500 ft
Nearest data: Sonora, California

June average minimum temperature: 55°F (13°C)

June average maximum temperature: 86°F (30°C)

December average minimum temperature: 36°F (2°C)

December average maximum temperature: 56°F (13°C)

Source: John Burton

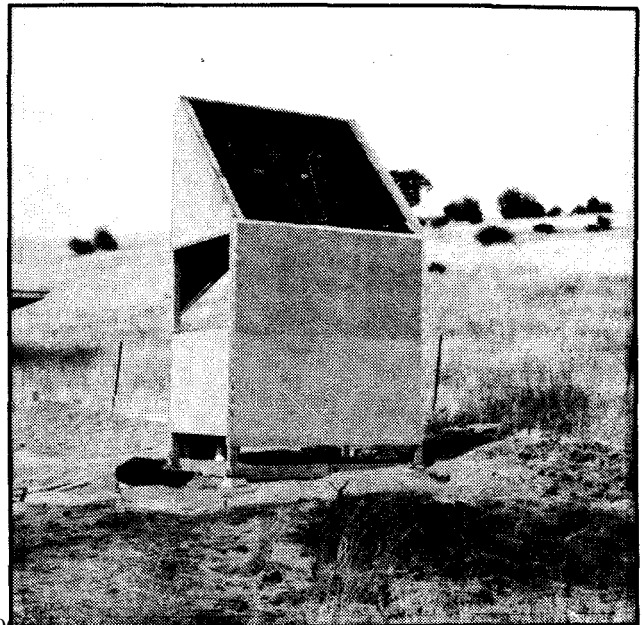

Courtesy John Burton

p)

The Hunt Heater 1977

Marshall Hunt built the first IPSWH in Davis in recent years and must be given credit for inspiring much of the activity there. His system is nicely integrated with the design of the house and shows that an IPSWH need not look like a box stuck on the roof.

The Hunt heater has two units each with three 30 gallon (114 l) glass lined mobile home water heater tanks inclined in a triangular, insulated box, double glazed with two 80 x 35 inch (203 x 89 cm) panes of tempered glass.

The two heater boxes are plumbed in series, with the tanks in series within each unit.

The Hunt heater provides full water heating for about eight months and preheating the rest of the year. The cost for this unit was about \$1,200. Utility bills for all uses are about \$12 per month.

Two of the heaters in one box developed pinhole failures; one subsequently self-healed. The tanks may have had their lining cracked or inadequately applied and did not have protective sacrificial anodes.

Location: Davis, California 38°30'N 121°32'W 30ft

Summer design dry bulb 5%: 94°F (34°C)

Summer daily outdoor range: 36°F (20°C)

Winter design temperature 99%: 30°F (-1°C)

Source: Virginia Thigpen



A Mountain IPSWH 1978

While IPSWH's are often thought of as warm climate heaters, they have also been successfully used in colder areas. W. Doug Davis has done some IPSWH research near Snowmass in the Colorado Rockies. His Climax Cusp uses a two compartment 60 gallon (227 l) glass lined water heater tank set at the focus of a reflector. The collector is single glazed with 28.9 sq ft (2.7 sq m) of glass.

Movable insulation is used to reduce night heat loss. The insulation system consists of five layers of relatively thin aluminized fabric with high reflectivity and low emissivity. The measured R-value for this assembly was about R-7.

On a mostly cloudy winter day 44°F (7°C) inlet water was heated to 74.4°F (23.5°C) in six hours. Net collection efficiency on this cool day was 72 percent.

Location: Snowmass, Colorado 39° 20'N 107°W
Nearest data: Leadville, Colorado

Summer design dry bulb 5%: 70°F (21°C)
Summer daily outdoor range: 30°F (17°C)
Winter design temperature 99%: -9°F (-23°C)

Reference: W. Doug Davis (1978), "The Climax Cusp Solar Water Heater," Second National Passive Solar Conference, Philadelphia, Pennsylvania.

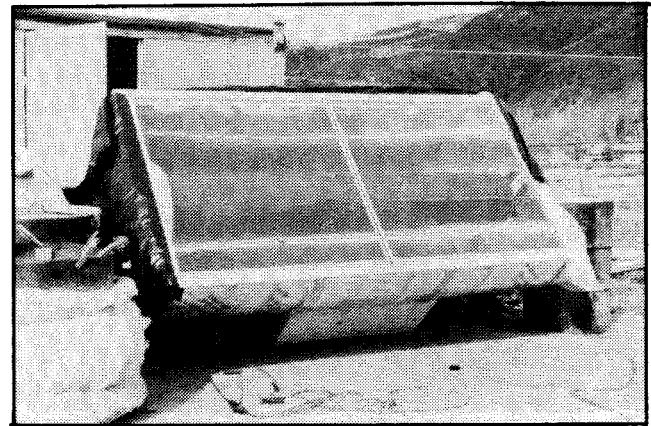
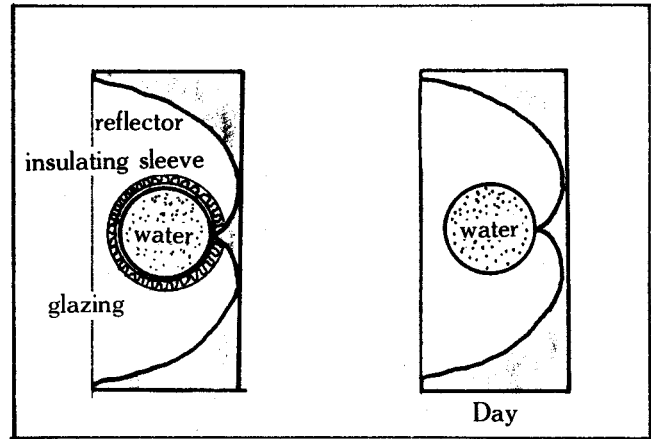

Courtesy Doug Davis

A Greenhouse IPSWH

One of the first installations with the IPSWH in a greenhouse was built by Alan Ross and the Brattleboro Design group in Brattleboro, Vermont.

Two 40 gallon (151 l) recycled gas water heaters are set in the peak of a solar greenhouse in insulated boxes with movable insulated reflector-covers. The tanks were suspended on pipes running through the gas flue and hung on chains at the end. The enclosures and lids are built from urethane insulation and plywood. The lids are operated manually with cords and can be adjusted for different seasons by the cord length.

The system serves as a preheater between the well and backup oil fired heater. A three valve bypass was installed so the tanks can be removed or drained without interrupting service.

Backup water heater: oil fired
Freeze protection: insulated lids, draindown
Location: Brattleboro, Vermont 43°N 73°30'W 300ft
Nearest station: Rutland, Vermont

Summer design dry bulb 5%: 82°F (28°C)
Summer outdoor daily range: 23°F (13°C) Winter design temperature 99%: -12°F (-24°C)
HDD: about 8,000

Reference: Rick Schwolsky (1979), "Preheating Water . in Greenhouses," Solar Age, June 1979.

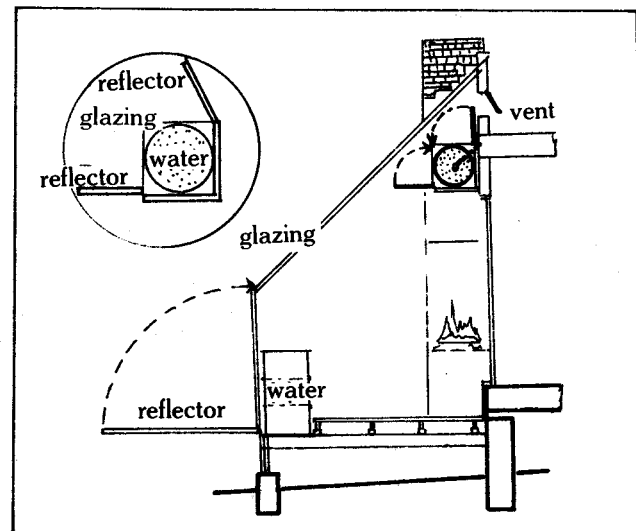

A Better IPSWH 1981

One of the better IPSWH's built yet is in Berkeley, California. It was designed and built by Dan Plambeck with advice from the author and John Burton. It is a triple tank horizontal model with two 30 gallon (114 l) and one 40 gallon (151 l) recycled glass lined water tanks. The horizontal layout was chosen for structural and aesthetic reasons, to bridge the main roof beams and minimize visibility from the street.

The heater sits in an insulated wood box. It is double glazed with fiberglass. The box interior is painted black and selective surface foil was applied to the top front quarter of the tanks to minimize night heat loss. The pipe run to the heater was run beside the gas heater vent pipe for freeze protection and supplemental heating.

Location: Berkeley, California 37°45'N 122°15'W
Nearest data: Richmond

Summer design dry bulb 5%: 77°F (34°C)
Summer daily outdoor range: 17°F (9°C)
Winter design temperature 99%: 35°F (2°C)

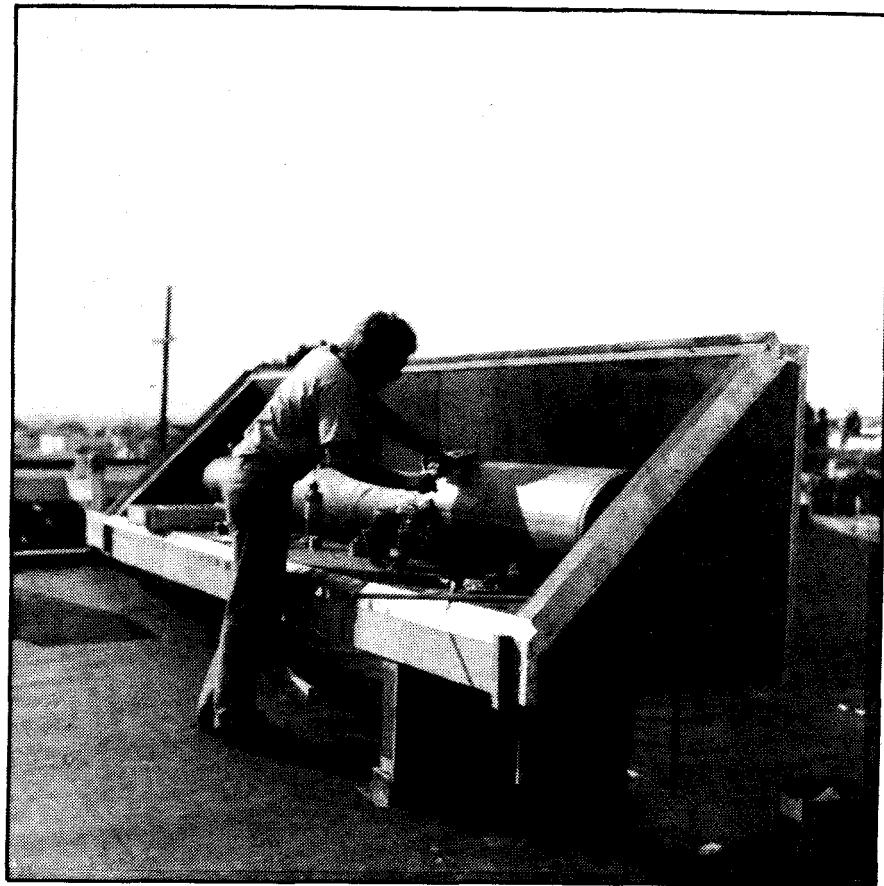

A Bigger IPSWH 1977

One of the hot beds of IPSWH activity has been Davis, California, and one of the earlier IPSWH's built there was designed by Bruce Maeda and built by Marshall Hunt. This bigger heater has four 30 gallon (114 l) glass lined water heater tanks in an insulated box built on the roof. The two middle tanks are in parallel with each other and in series with the other two. The box is double glazed with tempered glass. It cost about \$800 to build including labor.

The heater provides 100 percent of the hot water for three adults from June through October. The rest of the year the heater serves as a preheater to the conventional gas water heater. During the summer the temperatures were occasionally cooler than desired in the morning, 98°F to 105°F (37°C to 41°C), but afternoon and evening temperatures were very acceptable at 112°F to 130°F (44°C to 54°C).

The cool temperatures are attributed to a low glazing to mass ratio of the heater, at 3.3 gallons per sq ft (134 l per sq m). More collector area or fewer tanks would reduce this to a more acceptable level and provide higher temperatures.

Backup water heater: gas

Freeze protection: none

Location: Davis, California 38°30'N 121°32'W 30ft

Summer design dry bulb 5%: 94°F (34°C)

Summer outdoor daily range: 36°F (20°C)

Winter design temperature 99%: 30°F (-1°C)

Mean July temperature: 75°F (24°C)

Yearly % possible sunshine: 79%

Source: Bruce Melzer, D.A.T.A., P.O. Box 503, Davis, CA 95616 ..

Reference: Bruce Maeda, Dean Anson, Paul Grant (1979), "Suncatcher Monitoring and Performance Evaluation Project," **Third** Passive Solar Conference, San Jose.

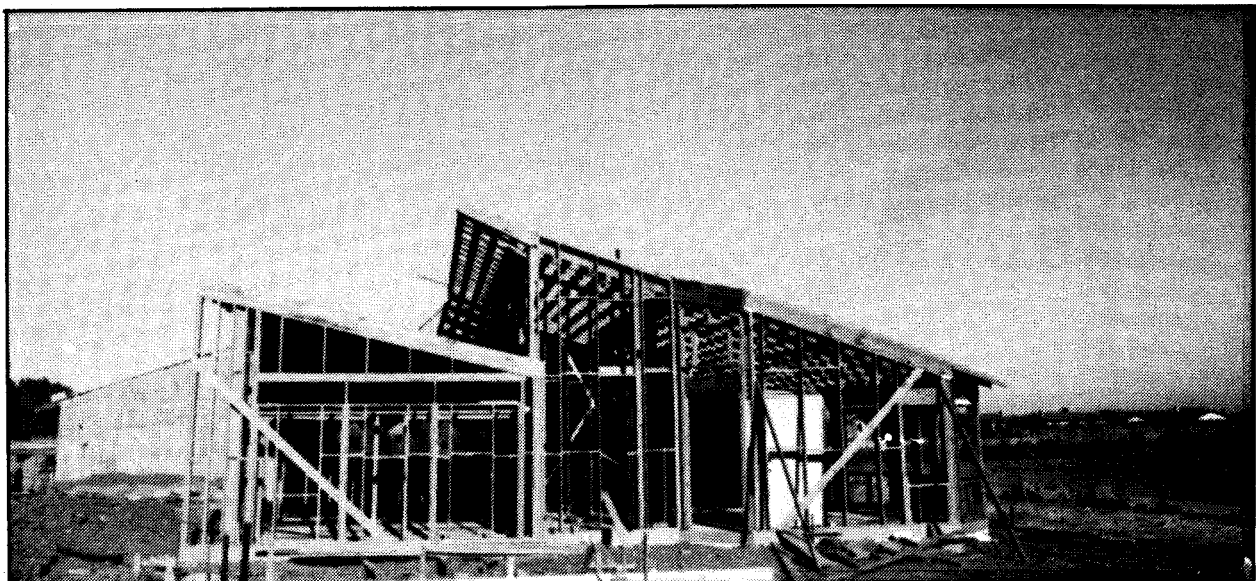
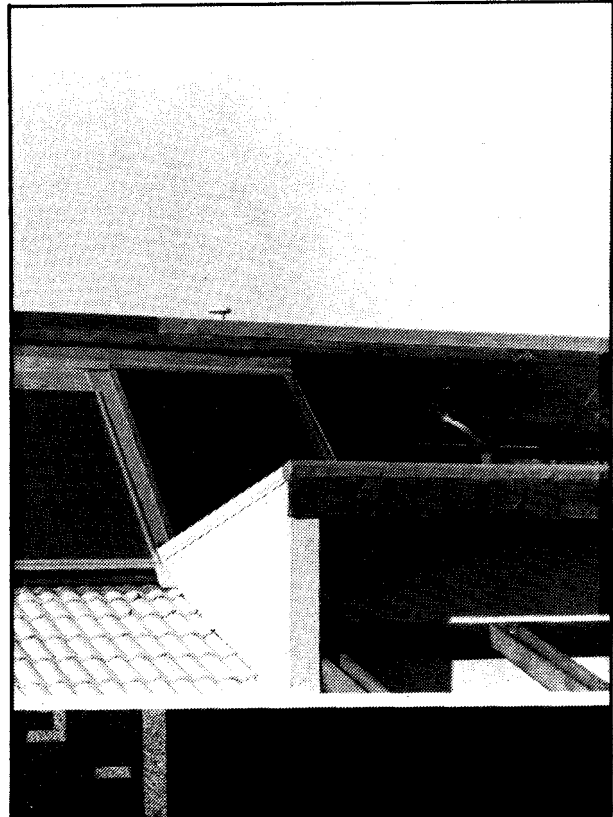

A Dormitory IPSWH 1979

The Colorado Rocky Mountain School Dormitory near Carbondale, Colorado has a 160 gallon (606 l) IPSWH. This large heater has a collector area of 100 sq ft (9.3 sq m) of single pane glass. A non-tracking symmetric cusp reflector made with bright rolled mill finish aluminum provides a concentration ratio of 1.3. The four 40 gallon glass lined tanks are plumbed in series at the focus of the reflector.

Nighttime heat loss is reduced with a gear motor driven automatic multilayered reflective insulating curtain, R-10. Freeze protection is provided by automatic draindown when tank temperatures approach 32°F (0°C). The lines to and from the heater are heat taped and heavily insulated.

The heater was designed and built by Doug Davis. If he were to do it again he would use a simpler design. The reflector was "like building a boat-a real challenge." It took almost three months to build and it cost "too much."

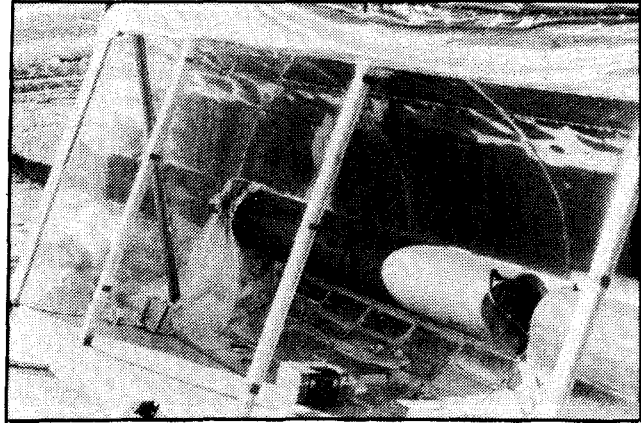

Courtesy Doug Davis

Location: Carbondale, Colorado 39°30'N 107°15'W 6,181 ft
Nearest data: Cedaredge, Colorado

January mean monthly temperature: 27.5°F (-2.5°C)
July mean monthly temperature: 71.9°F (39.9°C)
July mean daily range: 31.5°F (17.2°C)

Laundry Room IPSWH 1980

One of the largest IPSWH's currently in use in the U.S. is used to preheat water for a laundry room in the married students' housing at University of California, Santa Barbara. It includes three 80 gallon (303 l) glass lined steel tanks with sacrificial anodes, vertically inclined in an insulated box. It has 96 sq ft (8.9 sq m) of double pane glass. Fittings are all brass for very long life.

The heater serves as preheater to a natural gas boiler with storage tank that serves 15 washing machines. Because of the high demand, the tanks were plumbed in parallel and 1.5 inch (3.8 cm) feed pipes were used.

It was built as a SUN RAE workshop under the direction of Peter Alpert. John Burton was design consultant. It is a first "trial" project for the University of California system and will be duplicated if it is successful.

Location: Goleta, California 34°30'N 119°50'W 100 ft

Summer design dry bulb 5%: 81°F (27°C)
Summer daily outdoor range: 24°F (13°C)
Winter design temperature 99%: 34°F (1°C)

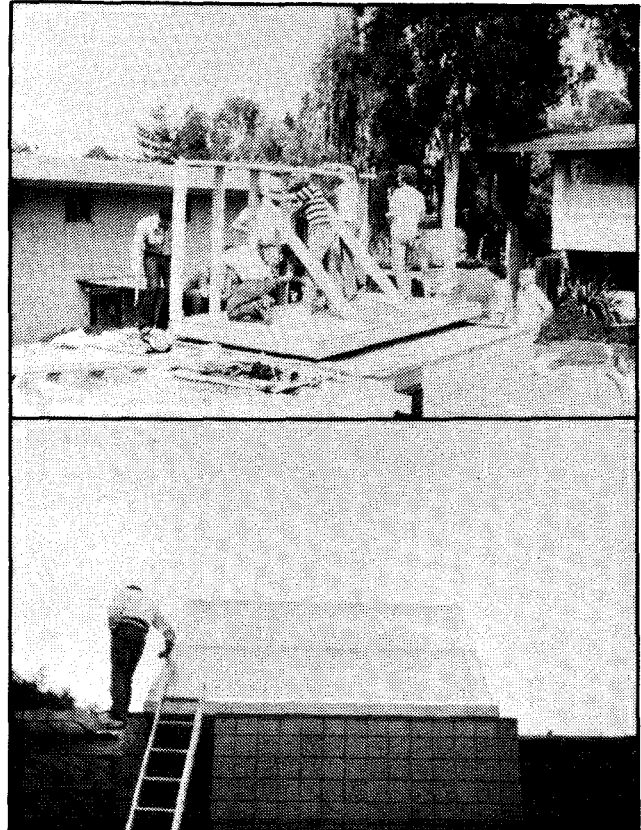

Courtesy John Burton

The Thing (not built)

q)

The promise of IPSWH's for large hot water demand was demonstrated in design work for the "Thing." This monster was designed for apartment complex use in New York. It would include six 20 ft (6.1 m) long, 6 inch (15 cm) clear fiberglass tubes set horizontally in an insulated, tilted box with glass cover. These tubes would be painted black on the back and would hold about 31 gallons (117 l) of water. The tanks would be connected in series with hot water drawn from the top tube. For night heat loss reduction and freeze protection the heater would include automatic movable insulated shutters.

The heater design was developed to meet a need for economical solar water heating in New York climate. The Thing was the only one of four alternatives (the others: two-fluid antifreeze active, draindown active, thermosyphon) that proved economically viable.

Location: New York, New York 40°5'N 74°W

Summer design dry bulb 5%: 88°F (31°C)

Summer daily outdoor range: 17°F (9°C)

Winter design temperature 99%: 11°F (-12°C)

Reference: Michael Golubov and John Leffler (1979), "The Thing," Proceedings Third Passive Solar Conference, San Jose, CA.

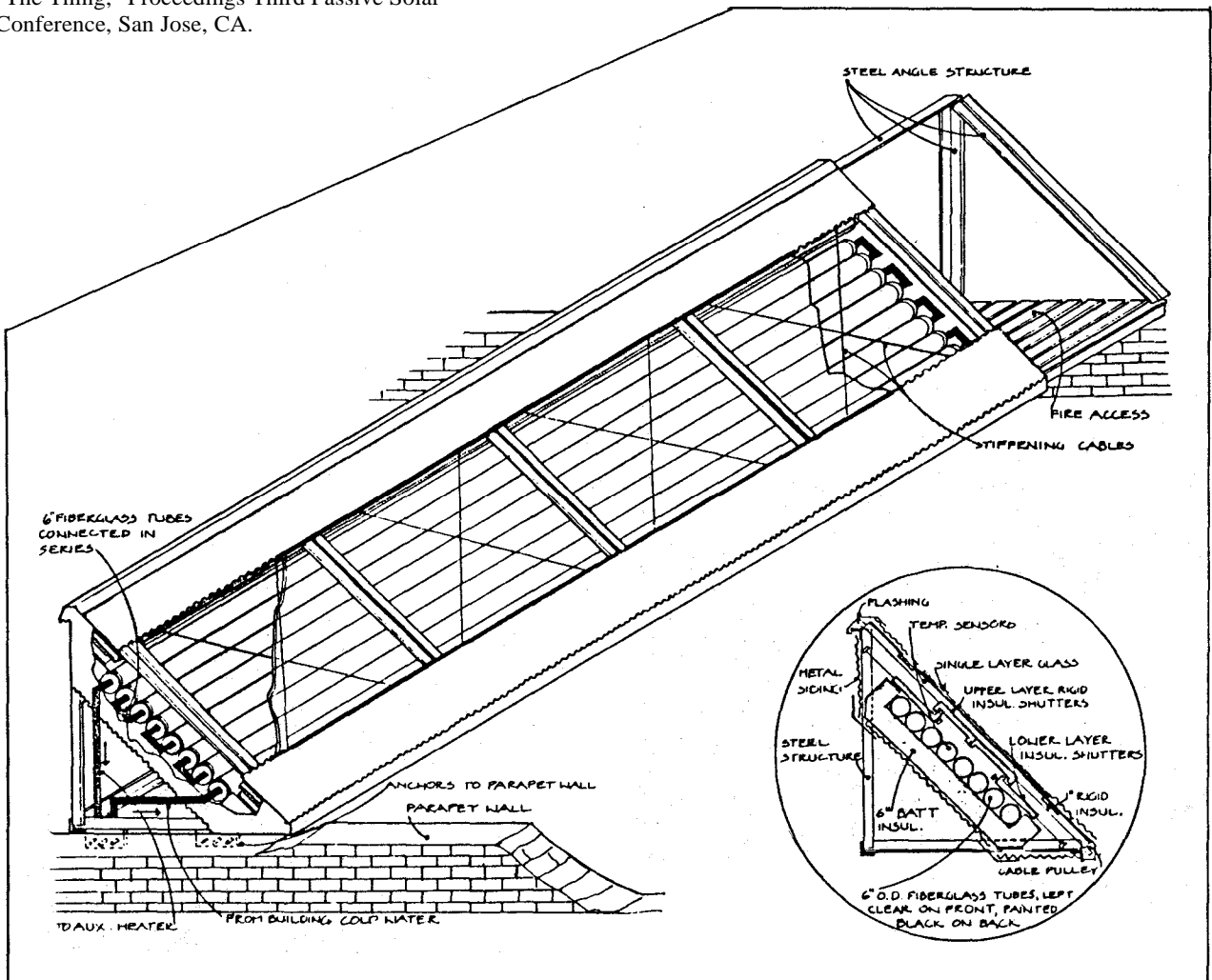

Chapter 8: Building Your Own

If you are reasonably familiar with carpentry and plumbing, are willing to learn, or have friends that are knowledgeable, you can build and install your own IPSWH for considerably less than you can buy one. The information in this Chapter should help you do it. The detailed instructions for building and connecting an IPSWH could fill another book so keep in mind that this Chapter includes only some of the information you may need if you haven't built anything before. P.S.I. will be preparing a construction manual in 1981 if expected funding becomes available or you can order a copy of Net Energy's IPSWH Manual for about \$10 after June 1, 1981. Their address is: Net Energy, 854 Ninth Street, Arcata, CA 95521. If you feel you need more construction experience, check your nearest bookstore for plumbing and carpentry books and investigate classes at local community colleges or owner-builder schools.

STEP 1: SELECTING LOCATION

The first step in building an IPSWH is prospecting for a location that receives enough sun, is accessible, and will support the weight of the completed heater. Take the time to do this properly (see Chapter 3 and Appendix 1). The ideal location is on the ground near the existing heater.

This is a good time to determine what your local climate is-and what type of IPSWH you might use. Will it need freeze protection? Do you want full solar hot water or only preheating?



Solar Prospecting

STEP 2: DESIGN

The next step is designing or obtaining plans for an IPSWH for your particular situation. You may want to examine some of the plans now available (listed at the end of this Chapter). However, IPSWH's are so straightforward you should have no trouble designing one specifically to fit your location, use, budget and aesthetics.

The type of tank you will use will obviously affect your design and this is often the hardest item to find. Therefore, you might prepare only a draft plan before you obtain your tank or tanks (see also Appendices 2 and 3).



This is also the time to determine if the roof will need additional bracing for the heater. Most but not an roof construction will support an additional ten to fifteen pounds per square foot (48-73 kg per sq m). If your heater adds more weight than that, or if the roof looks too weak for even that (mainly a problem in Hawaii and the Sun Belt where no snow load is planned), you would be wise to add reinforcing or consult an engineer. You can also use purlins to spread the load over a wider area. Make sure they don't impede drainage. This can be particularly helpful if you are working on a flat roof with strong beams that can be bridged with the purlins.



Bridging Support Beams

You should also consider the effect of an earthquake on your heater if you live in a seismically active area. Extra cross bracing may be required to resist the movement caused by an earthquake.

The design of your heater should also reflect the location and method you will use to install it. Building the heater in place is often the easiest method. If that would be awkward or inconvenient then consider building it in sections (a prefabricated heater) that can be moved easily and assembled on location. The third option is to build the complete heater and then move it into place. This can be difficult with the large IPSWH's-weighing 200+ pounds (90+ kg) empty-but it is a feasible project. I would put skids from ground to roof and then winch the heater up. Lay down plywood or wood strips to protect the roofing material.

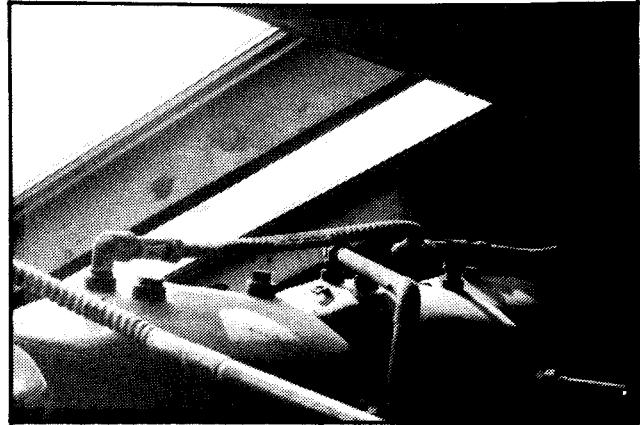

Tank Connections

At this stage you should plan the plumbing so you'll know where the pipes will enter and leave the box and how the drain pan or leak proofing will work. If a roof penetration is necessary it must be very carefully done to prevent future leaks.

While you are working on the plumbing design you should plan the drainage and connection to your existing system. Typical hookups are shown in the accompanying diagram for a preheater and full scale water heater.

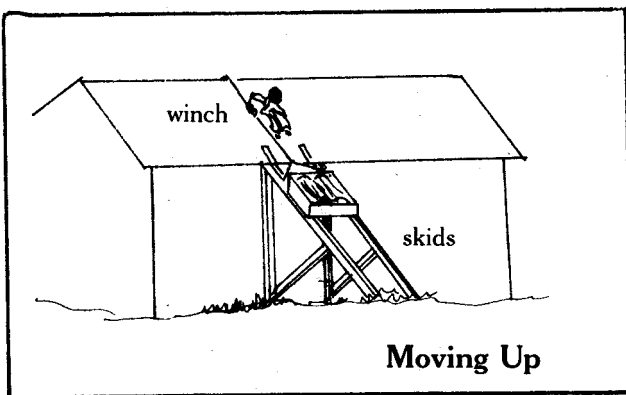

Moving Up

After taking care of these basics you can design the heater. Begin by choosing the angle and direction you want the glazing to face. This is usually due ,south tilted an amount about equal to the latitude of the site (or greater) for year round use and less for summer use only. You may want to round this off to 30°, 45°, or 60° for ease of construction.

First, design a frame around the tank you'll be using with 2 x 4 inch or 2 x 6 inch wood, just as a house wall is framed. Plan the spacing between frame members at 16 or 24 inches-this will make it easy to obtain standard size materials for construction and insulation. Include a rack or brace to support the tank(s). For vertical tanks this may be as simple as a notched 2 x 6 inch piece running from side wall to side wall. Or you might include an inclined deck made for 1/2 inch plywood resting on diagonal braces from end wall to end wall. Horizontal tanks can be simply blocked in place.

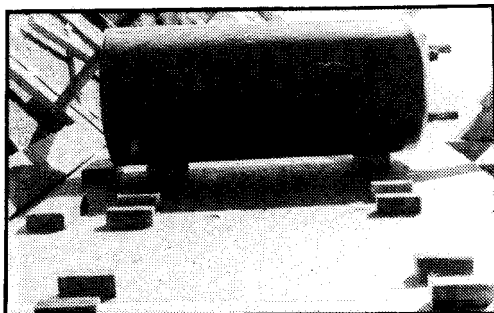

Tank Blocks

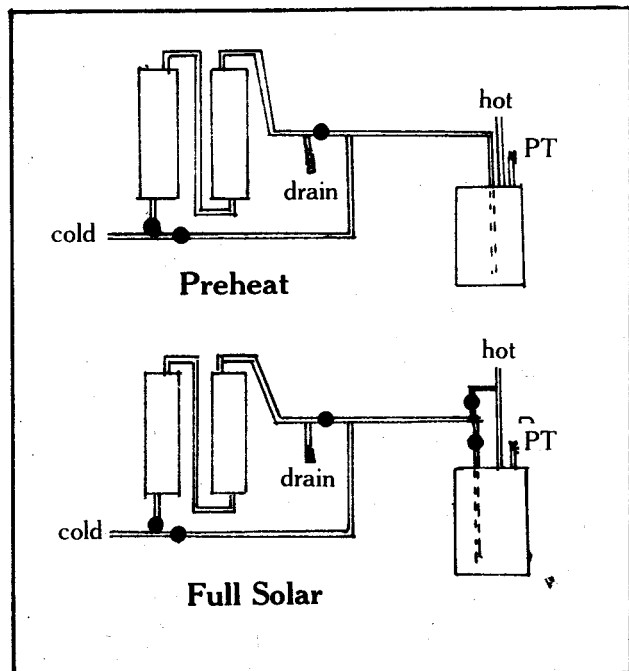

After completing the plans for plumbing you can return your attention to the box and design the exterior and interior covering for the frame. The most common outside cover will be exterior plywood, but other materials can be used to match your existing house siding or roofing. The interior will also usually be covered - with plywood-but waterproof sheetrock, aluminum covered foam or fiberglass insulation, hardboard, and many other materials have been used successfully.

The insulation should also be planned at this time. Fiberglass bats are easiest to use. If the frame members are spaced to match standard foil covered roll insulation, this will be very easy. You might also use foam insulation, either between the frame members or as an exterior or interior sheathing. Pipe insulation should also be selected.

The final step is detailing the glazing. Tempered glass is usually preferable-but fiberglass, polycarbonate, and acrylic can also be used. If tempered glass will be used, you should design the frame to match an existing pane size because tempered glass cannot be cut-and custom glass is quite expensive.

The glazing hold down can be made with 24 or 28 gauge sheet metal bent (and soldered) as shown. You can also do the job with wood battens and strips. The weatherseal demands careful attention, planning, and execution.

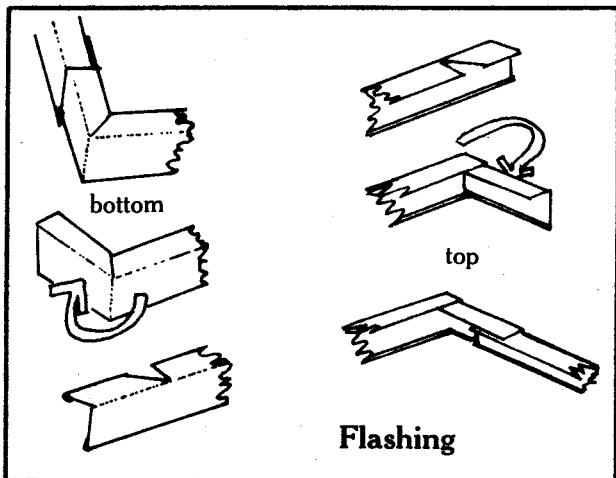

Your IPSWH plan should now be complete except for the finish work. At this time carefully determine what you'll have to do to prepare, prime, and seal all exposed surfaces. Decide whether you will paint or reflectorize the interior, paint or selective surface the tank, and determine the color for the exterior.

If movable insulation will be included it may be helpful to prepare a draft plan of the preceding steps and then integrate the movable insulation and control mechanism. These may be inside the box or outside depending on your preference and site factors.

The choice of installation method will influence the plan considerably. For example, prefabricated construction might be substantially different from site built, with walls, ends, and racks built in units designed to fasten together on site.

Finally, assemble a materials list. Plan plywood cuts at this time too if you will have the lumber store cut it for you.

Don't skimp at the planning stage-construction and installation will be easier with careful design and preparation.

This is the time to apply for a building permit if you need one; check at City Hall.

STEP 3: CONSTRUCTION

Begin by assembling all the materials. You may find that some are slightly different from what you had expected-so check them over and revise the plan if necessary.

Building basically follows the stages laid out in STEP 2. Build the frame, test the tank fit, then cover the outside, insulate, and cover the inside.

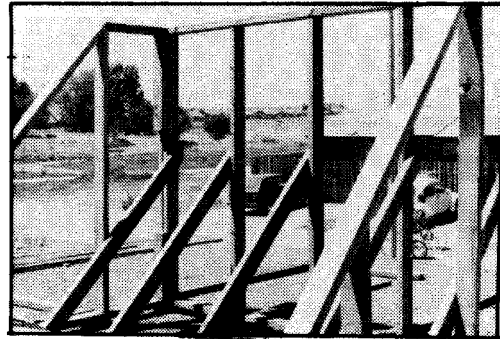

Framing



Tank Bed

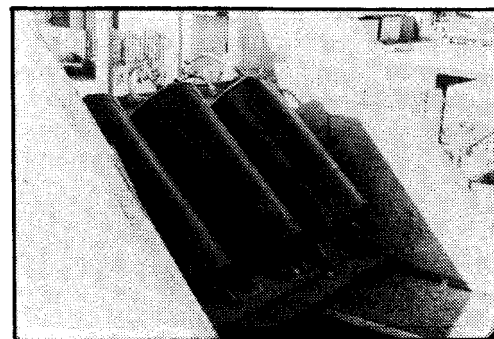

Tank Placement

Plumbing usually comes next. Plan carefully so you don't have to shut off the water for too long. Do all the tank plumbing and connecting lines before connecting these to the water lines. The house shut off valve is usually located at the front of the house. It may be outside in a box in the ground or inside if you have a basement. Turn off the water heater, then turn off the main valve and drain water from the pipes. Cut the hot and cold lines and attach your new fittings and pipes. Then turn on the water and check carefully for leaks. It is often advisable to bleed air out of the tank when filling the system. Unscrew a plug or install a bleed valve to do this. You can also do this by manually operating the pressure and temperature relief valve if you have installed one.

Note: Standard plumbing practice includes a static pressure test. This testing requires special equipment and needn't be done unless the code requires it in your area. The advantage of this overpressure test is that it pinpoints even small leaks quickly.

You can test your system just with line pressure but let it sit for several hours before covering anything. If you haven't done much plumbing you can expect a couple of leaks. These can usually be fixed without taking everything apart. Drain the system before resoldering.

You can use the time while you are testing the system to mark the valves and hang a sheet nearby describing the different use modes. You can paint just the handles or paint the valve itself.

After this test is successfully completed you can caulk and paint the box exterior and interior. Do it to last—a careful job now will mean refinishing may be needed only every ten years. The next step is to insulate the pipes. If foam wrap, such as Armaflex, is used remember to paint it with a proper protective finish. Exterior latex paint will work.

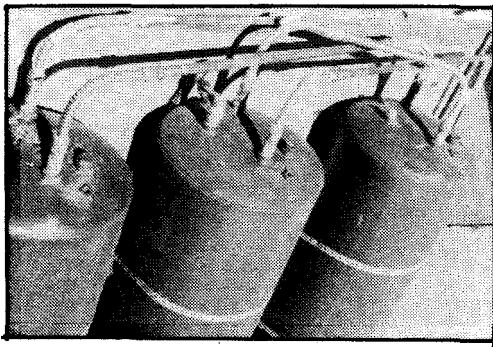

Plumbing Tanks

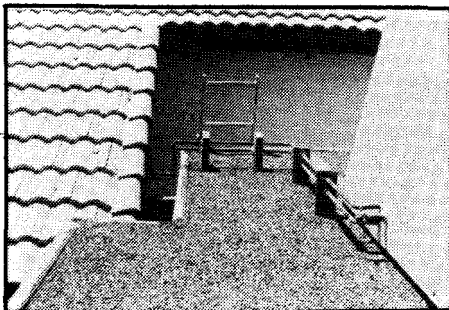

Connecting Pipe Run

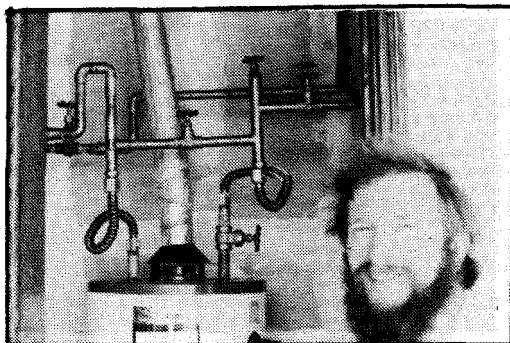

Hookup

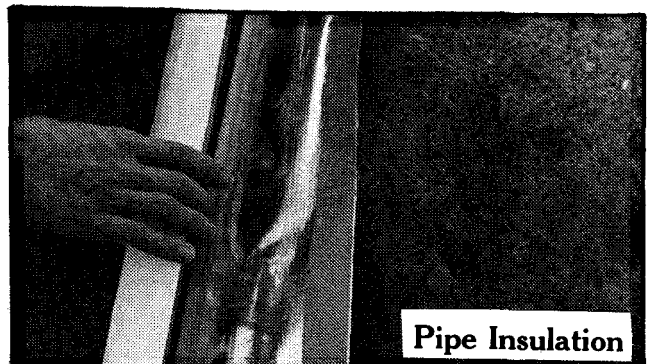

The final step is adding the glazing. Handle glass with care. The glass should rest on a bead of silicone caulk, glaziers tape, or foam. Fasten the glazing down and add the flashing to make it waterproof. After all is complete run a bead of silicone seal along joints and connections where the glass meets flashing or battens.

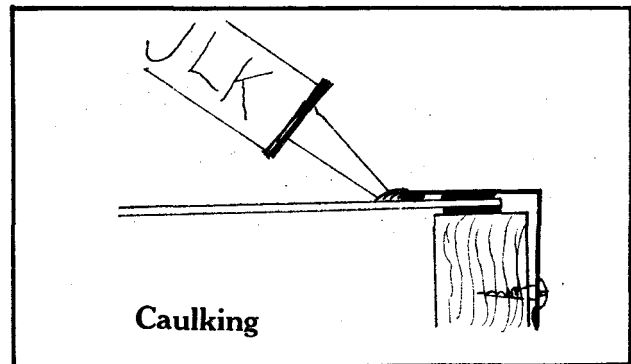

Let everything dry and start enjoying your solar hot water. Try turning off and bypassing the backup heater, if you have one. You may find that your new heater will do the job by itself.

SAFETY CONSIDERATIONS

Don't burn yourself when soldering

- wear gloves and *think* about what you're picking up

Don't cut yourself

- wear gloves cutting sheet metal
- wear gloves carrying glass, carry it vertically
- use power tools properly
- chisel wood not flesh

Don't fall off the roof

- wear rubber soled shoes
- build a work platform if the roof is steep or slippery
- use ladder carefully and set up properly

Don't get hit by falling objects

- fasten IPSWH once it's up on roof so it can't fall off
- keep tools and materials under control so they won't slide off
- keep people, kids and pets out from under-just in case

Don't strain yourself

- lift with knees not back
- use levers, rollers and winches rather than brute force
- quit when you're tired (that's when you make mistakes)
- ask for help when you need it (heroes die young)

Don't poison yourself

- paint with proper ventilation or mask
- wear mask and gloves when working with fiberglass

Don't electrocute yourself

- power to the house often enters through the roof so don't bump wires with your body, tools, or ladders

PLANS (p&h: postage & handling)

Passive Solar Institute P.O. Box 722 Davis, CA 95616	\$10 inc. p&h; 3 tanks vertical inclined
Integral Design 3825 Sebastopol Rd. Santa Rosa, CA 95401	\$15; horizontal & vertical two tank designs
Zomeworks Box 712 Albuquerque, NM 87103 with lids	\$5 + \$1 p&h; one tank vertical two tank
Ted Lucas 10371 Stone River Court Fountain Valley, CA 92708	\$5; horizontal tank with reflector lining

The Crystal City Collector \$5.50; one tank with
Center for Maximum Potential reflector underneath

Building Systems
8604 Webberville Rd.
Austin, TX 78729
(512) 928-4786

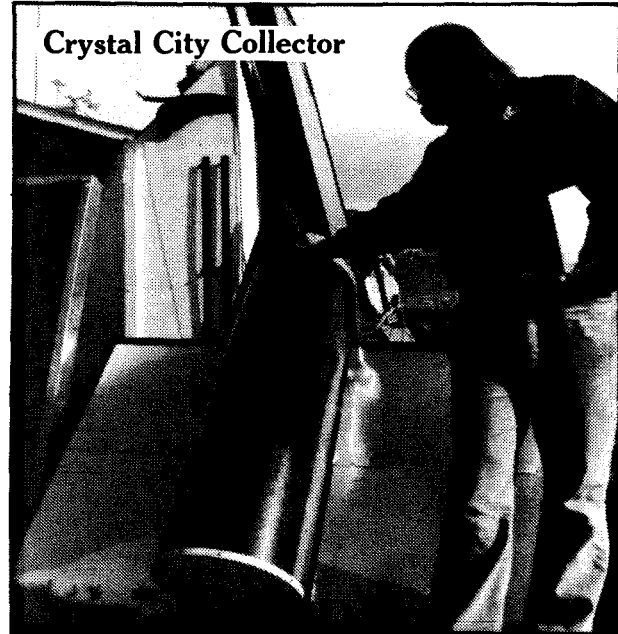

Solstice Publications
Box 2043
Evergreen, CO 80439

\$22 + \$1.50 p&h

Union Electric-Solar Preheater free; two tanks with
P.O. Box 149 reflector behind
St. Louis, MO 63166

Horace McCracken
*How to Build a Passive
Solar Water Heater*
329 W. Carlos
Alturas, CA 96101

\$6; Horizontal system
with one or more tanks

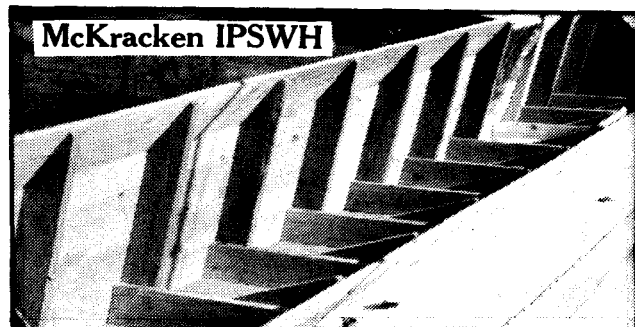

Published Plans:

Frederic Langa (1980) "Sun on Tap: Pure and Simple," *New Shelter* vol. 1, no. 7, October.

Bonnie Speer (1981) "Build a Solar Water Preheater," *Handyman*, January.

John Golder
P.O. Box 854
Santa Cruz, CA 95061

\$6; one tank horizontal
with reflective insulated
cover

John Golder's Capsule Collector

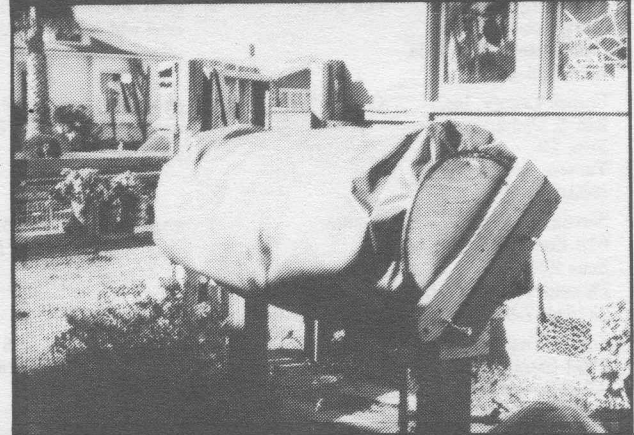
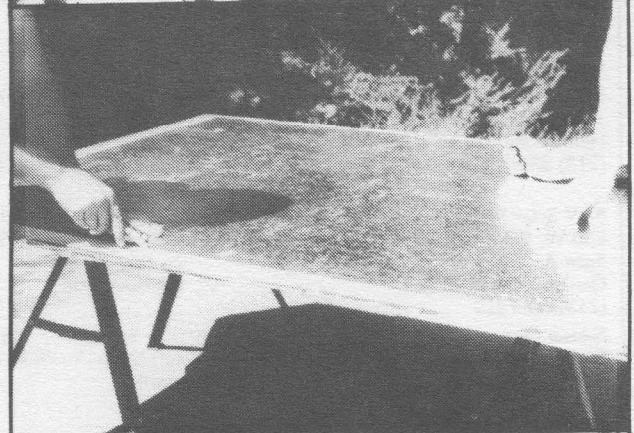
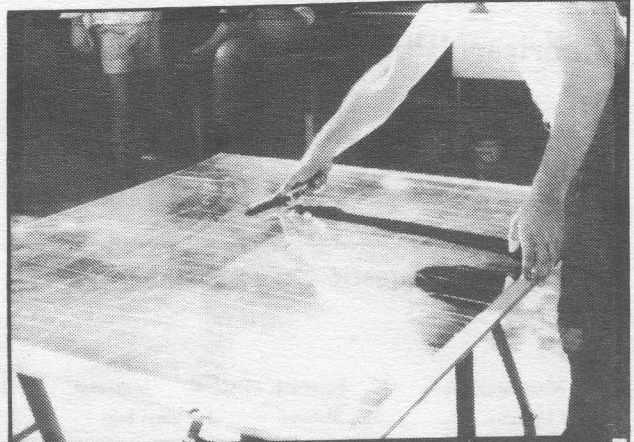
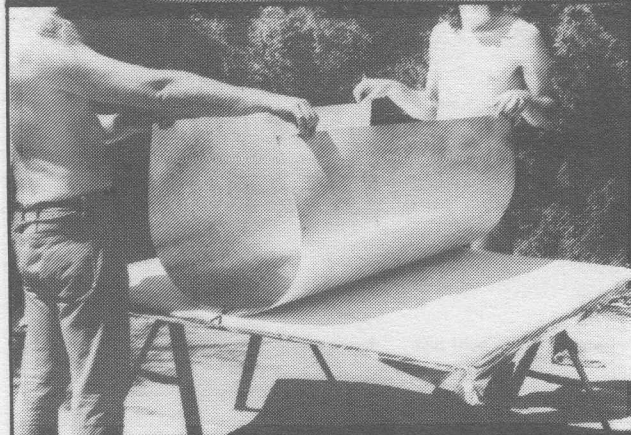
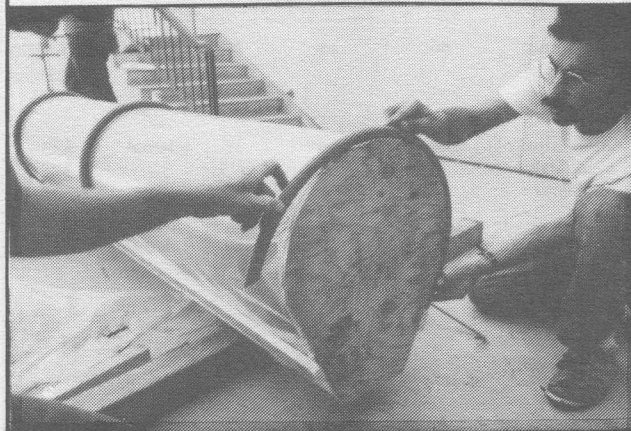
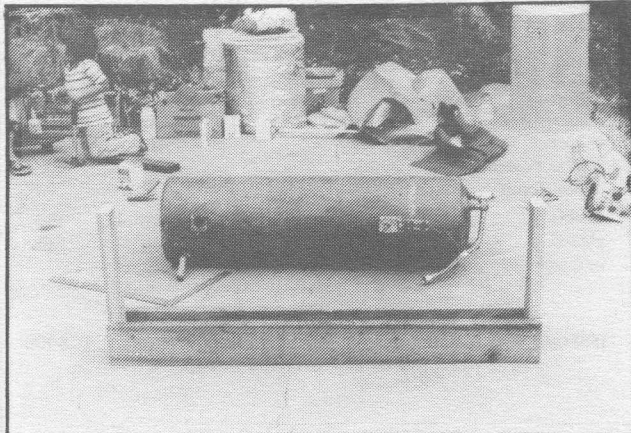

Chapter 9: Commercial IPSWH's

American IPSWH's

The availability of commercially built IPSWH's is still limited in the United States. At the time the research for this book was done (late 1980), only twelve firms were in the market. They produce the following heaters:

The most successful unit is the "Sun Shower" thanks to its low cost, and portability. After this the market is just beginning to develop, with no clear leader. These IPSWH's are described in greater detail in the following pages.

Table 9-1. Domestic Commercial IPSWH's

Manufacturer	Product	Tanks per unit	Tank material	Gallons water per unit (liters)	Glazing material	Internal thermosiphon tank	Freeze protection	Aperture area (sq. ft. (sq. m))	Reflectors	Approx. cost
Basic Designs, Inc. Muir Beach Star Rt. Box 479 Sausalito, CA 94965 (415)388-5141	Sun Shower	1	vinyl bag	2.5 (9.5)	one side clear	no	no	1.5 (0.1)	no	\$15
E.P.I. 1424 West 259th St. Harbor City, CA 90710 (213) 539-8590	Sun Wizard	1	glass lined water heater	50 is std, other avail. (189)	fiberglass-reinforced polyester, Tedlar coated honey comb	no	built-in heater	55 (5.1)	yes, white wall	\$750
SAV Solar Systems 550 W. Patrice Place Suite A Gardena, CA 90248 (213)327-7210	SAV, HD 20	1	steel with phenolic resin coating, selective surface	20 (76)	double glazed butyrate	yes	no	24 (2.2)	external semi-parabolic anodized aluminum	dist. only
Sekisui Chemical Co. Distributor: Sun Energy International P.O. Box 6542 Concord, CA 94524 (415)676-8717	Sekisui Model TM 1000	7	5 ft. x 6 in. OD black plastic cylinders	55.5 (210)	polycarbonate	no	no	67 (6.2)	internal	\$400
Solar American Co. P.O. Box 2088 Newport News, VA 23602 (804)874-0836	Summersun	1	galvanized steel, hot dipped with selective coating	30 (114) 40 (151)	fiberglass-reinforced polyester (Kalwall)	no	no	10 (0.9)	internal	30:\$650 40:\$675
Tao-Starr Solar Corp. 1515 Fairview Ave. St. Louis, MO 63132 (314) 423-7898	WTA Solar Water Heater	1	galvanized steel, hot dipped	30 (114)	polycarbonate with UV stabilizer	no	no	16 (1.5)	internal	\$350- \$450
Solar Tube, Inc. Box 12513 Austin, TX 78711 (512)928-4787	Solar Tube #1	1	glass lined steel with selective surface	30 (114)	single, fiberglass	no	no	14 (1.3)	external	\$400
Solar Tube, Inc. Box 12513 Austin, TX 78711 (512)928-4787	Solar Tube #2	1	glass lined steel with selective surface	30 (114)	single, fiberglass	no	yes, patented phase change	14 (1.3)	external	\$1,750
Sun Energy Builders 5838 Robertson Ave. Carmichael, CA 95608 (916)486-1801	Hot Stuff™	2	glass lined steel with selective surface	60 (227)	single, heat mirror	no	no	25 (2.3)	no	\$1,895
Cornell Energy, Inc. 245 S. Plummer Suite 29 Tucson, AZ 85719 (602)882-4060	Cornell 360	1	glass lined steel with selective surface	32 (121)	glass with two layers of filon	no	no	18 (1.7)	internal	\$895
Servomatic Solar 622 Contra Costa Suite 270 Pleasant Hill, CA 94523 (415)687-0600	Sunflow	1	stainless steel	18.9 (71.5)	double lexan	no	no	36 (3.3)	external	\$3,740
Energy Engineering 1704 Stanford Dr., NE Albuquerque, NM 97106 (505)266-9591	SunTrak	1	glass lined steel	66 (250)	none	heat pipe	heat pipe	44 (4)	yes	\$2,000



The Sun Shower

The most successful American IPSWH is the Sun Shower portable IPSWH. The Sun Shower is for showers and dish washing; several hundred thousand have been sold world wide. It consists of a 2.5 gallon (9.5 l) bag with fill spout and a shower hose, head and valve. The clear side is faced toward the sun as the heater is hung or laid flat on the ground or on an inclined surface. It has a temperature indicator to show when the water is hot enough.

Performance runs show temperatures reaching 105°F (41°C) after three hours in the sun on a bright day with a feed temperature of 60°F (16°C). Temperatures over 120°F (49°C) are not uncommon and may require mixing in cold water for comfort.

Sun Wizard

The latest Sun Wizard offering is one of the most interesting and innovative IPSWH's available today. After early work with traditional box type heaters they developed a vertical tank glazed with a honeycomb tedlar coated fiberglass glazing tube. The heater uses a 50 gallon (189 l) glass lined water heater tank with 55 sq ft (5.1 sq m) of glazing.

The heater is designed for placement in front of a white south-facing wall which acts as a reflector to increase solar collection. The heater has a built in electric heating element and can replace the existing water heater in milder climates. In colder areas movable insulation (not available yet) could make the heater workable.

SAV Solar

The SAV IPSWH is an American version of the system developed in New Zealand, described later in this chapter. The basic model has 25 sq ft (2.3 sq m) of glazing and holds 20 gallons (76 l). The SAV heater is double glazed with butyrate. The cylindrical tank with internal thermosiphon baffles is suspended above a semi-parabolic reflector. Current plant capacity is 500 per month.

Sekisui Solar

The Sekisui Solar system sold in the U.S. is similar to the Hitachi Hi Heater described later in this chapter. It uses 5 foot (152 cm) long, 6 inch (15 cm) diameter plastic pipes as the collector and storage. These hold 55 gallons (208 l) of water and are covered with 67 sq ft (6.2 sq m) of polycarbonate glazing. No freeze protection is included.

Sekisui

Characteristics of TM-1000

Dimensions: Length = 2.32 M (91.3")
Width = 1.33 M (52.5")
Thickness = 210 mm (8.3")
Capacity: 210 liters (55.5 gal.)

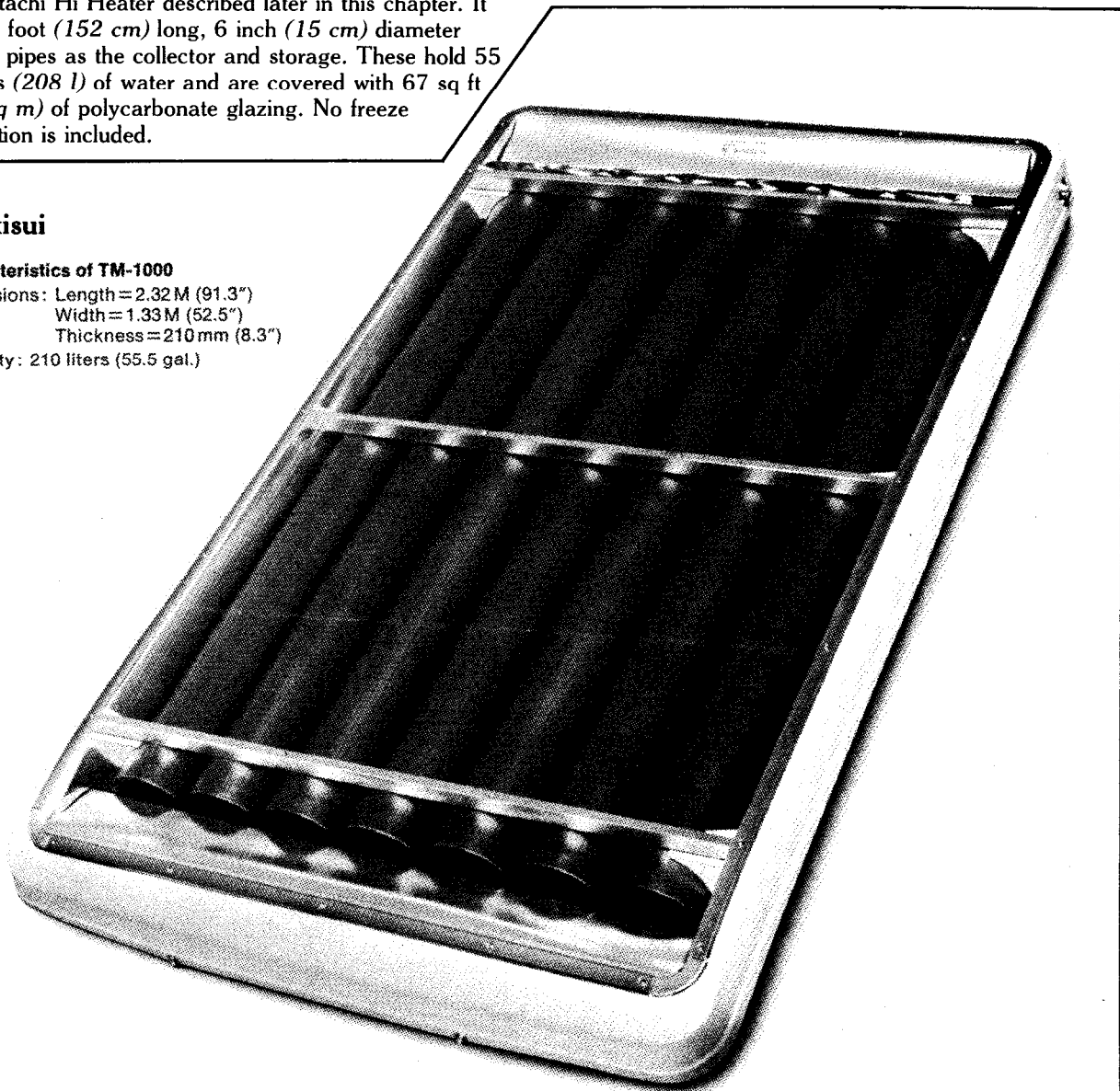

Summer Sun

The Summer Sun heater uses a 30 or 40 gallon (114. 151 l) galvanized tank for collector and storage. This tank rests in a 60 x 24 inch (152 x 61 cm) pie shaped trough. This trough is insulated and the inner surface is reflective. It is mounted on legs and is adjustable for improved performance with changing sun path.

The system provided a 70°F (21°C) rise in water temperature in Williamsburg, Virginia, Latitude 36°N. Freeze protection is by draindown.

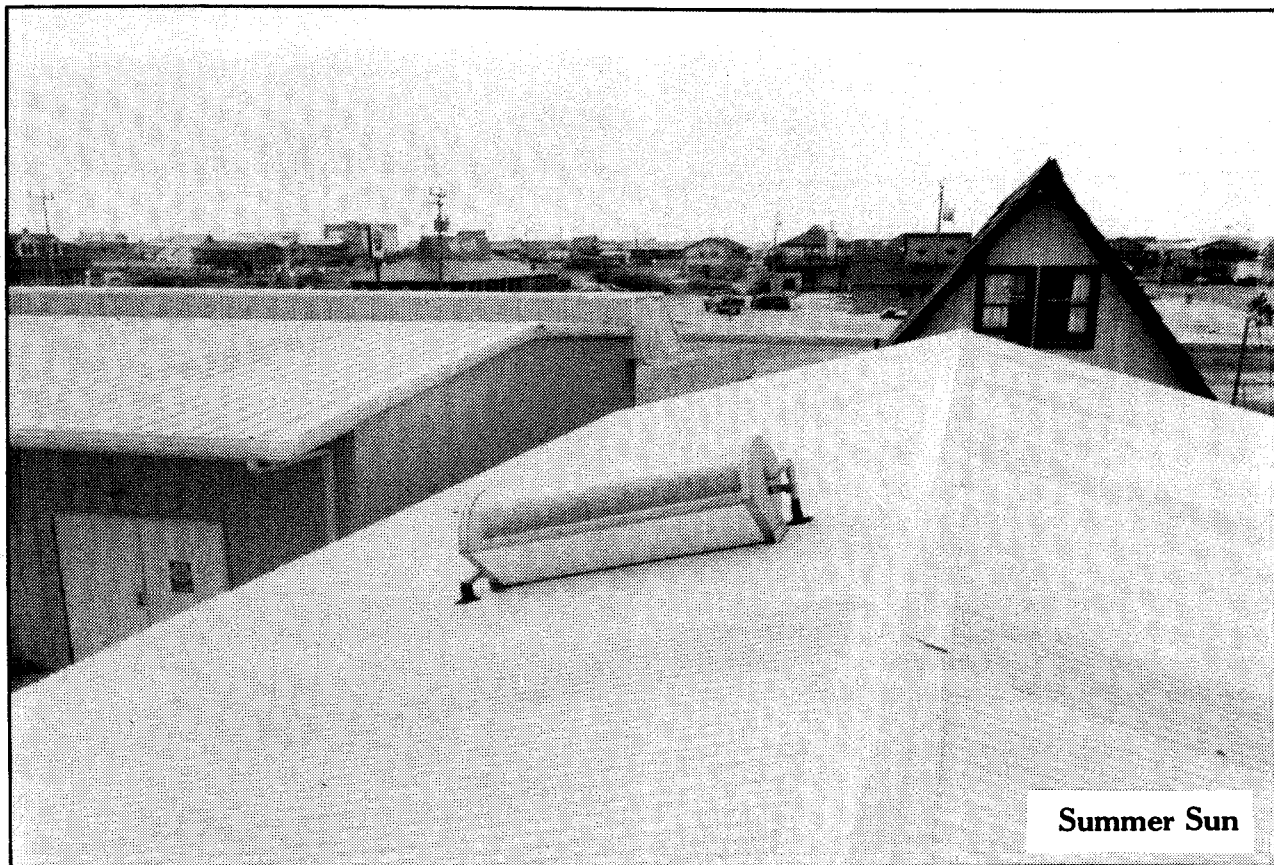

WT A Solar Heater

William Tao and Associates have done much of the development work on the Union Electric Solar Water preheater. In addition, William Tao and Michael Starr have gone into production of an IPSWH heater.

Their current design has a 30 gallon (114 l) galvanized tank set in a fairly low profile box with shaped polycarbonate glazing. The collector area is about 16 sq ft (1.5 sq m). The box is reflectorized on the inside. No freeze protection is provided and the system should be drained in winter.

Solar Tube

The first Solar Tube heaters were developed by the Center for Maximum Potential Building Systems of Austin, Texas in response to a cut off of natural gas in Crystal City, Texas. They helped set up the IPSWH production facilities for the City at a total cost of \$4,000 and designed the Crystal City collector, predecessor of the Solar Tube.

The Solar Tube #1 consists of a glass lined 30 gallon (114 l) water tank surrounded with fiberglass glazing, and suspended over a flat reflector. This flat reflector, made with recycled lithoplate, distributes the weight of the system and makes installation easier. The Solar Tube #2 also uses a 30 gallon tank but includes phase change freeze protection, heat exchanger, reflector plate system, and flash water heater.

One hundred twenty units have been installed in the Crystal City area in three modes: without backup, with conventional backup, and with CMPBS designed wood fired backup systems. The #1 heater will provide 50 gallons (189 l) of 110°F (43°C) water 300 days per year during an average year at San Antonio, Texas. The #2 heater will provide 75 gallons (284 l) during the same period.

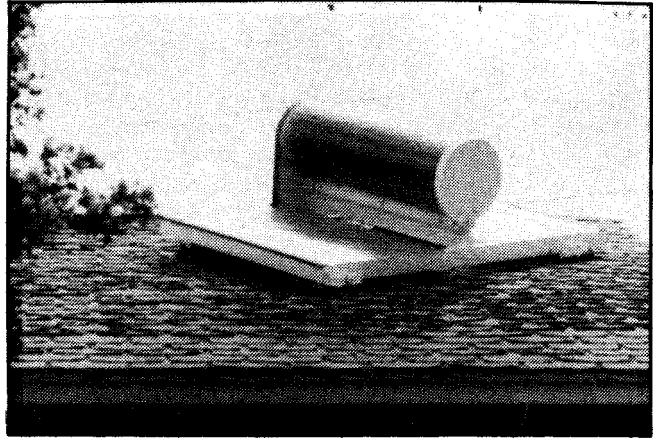

Sun Energy Builders

Sun Energy Builders has developed a straightforward IPSWH with two 30 gallon (114 l) glass lined steel tanks with sacrificial anodes set in an insulated box, glazed with 25 sq ft (2.3 sq m) of glass with heat mirror. The interior is painted flat black with a selective surface on the tank. In the Sacramento area these heaters are expected to provide 60 percent of the domestic hot water for the year. No freeze protection is provided except draindown.

Sun Energy Builders' innovation is in installation thanks to preframing and flashing during construction. The heaters are swung into place by crane, connected, and fastened down in fifteen minutes. This eliminates the problem of wrestling the heater up to the roof by skid and hard work, but it is only feasible in volume, preferably side by side in tract development.

The Cornell 360

Cornell Energy Inc. has been active in IPSWH production for the last couple of years. Their current IPSWH model is known as the "360" and consists of a 32 gallon (121 l) glass lined water heater tank set in a reflective insulated box. The tank has a selective surface. The collector area is 18.2 sq ft (1.7 sq m) and is triple glazed. The heater has no freeze protection and is not recommended for areas where temperatures fall below 0°F (-18°C) or remain subfreezing for several days.

Performance has been very good and tempering valves are recommended for all installations for protection from scalding. Temperatures as high as 162°F (72°C) have been recorded in the morning.

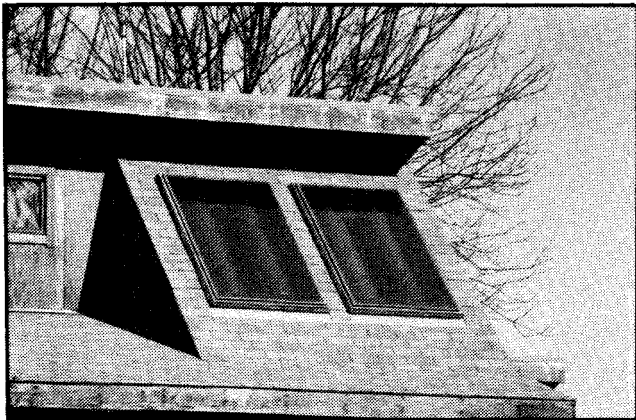

SunFlow

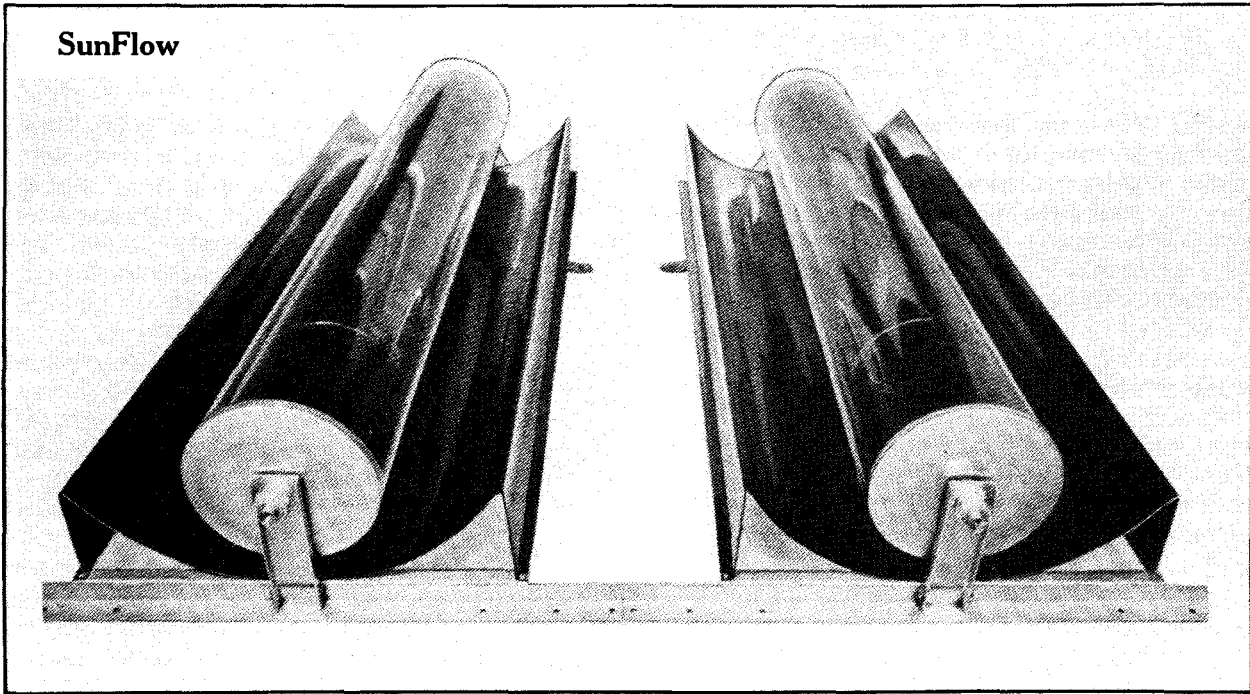

Sunflow

Servomatic Solar produces the Sunflow IPSWH. It includes a stainless steel 18.7 gallon (71 l) double glazed tank in a parabolic trough. The 36 sq ft (3.3 sq m) of reflector is focused on the tank and has produced temperatures as high as 258°F (126°C).

The Sunflow is derived from the Australian "Sun Trap" and the SAV solar heater. It was re-engineered for America's higher water use and for a longer life. The system may well weather fifty years with little deterioration.

The Heat Pipe IPSWH's

Energy Engineering of Albuquerque is gearing up to produce two innovative and efficient IPSWH's. These use a heat pipe with reflectors as the collector and a well insulated tank for storage. The heat pipe only transfers heat in one direction so night losses are low. This looks like the best IPSWH for colder climates.

These IPSWH heaters are only a beginning; they can and will be improved. My concerns with the current range of heaters include durability and aesthetics. In regard to durability, the use of anything but a stainless steel, glass lined steel (with anode), or plastic tank is questionable in light of previous experience. One of the main problems with the lifetime of the first IPSWH's in the early years of the century stemmed from the use of galvanized tanks. Tank durability will also depend on the heater's ability to withstand freezing-in case the owner forgets to drain it. Much more improvement can be made in this regard.

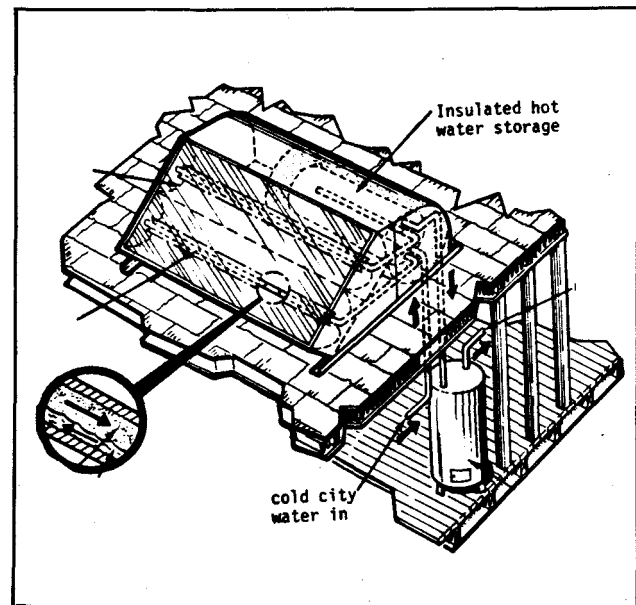

The aesthetics of a product is also important for marketability, and some of these IPSWH heaters are less than conventional "aesthetics" would desire. I personally believe that form follows function-that a basic IPSWH looks good because it works well-but some homeowners probably would not agree. More thought should be devoted to integrating IPSWH's with building design-as many of the scratch built systems have done.

International IPSWH's

The international market offers several other IPSWH's that may be of interest. These include the following models: the Solar Pillow and Hi Heater (Japan), the Solar Disc (South Africa), and SA V solar heater (New Zealand).



The Solar Pillow

The Solar Pillow is the most successful commercial IPSWH to date. Over one million have been sold in the Far East and Japan. The 38 gallon (114 l) IPSWH built by Poly Vinyl, Ltd. is representative of this type of heater. The Poly Vinyl heater looks like a giant 3 x 5 ft (90 x 150 cm) pillow and is made of reinforced welded polyvinyl chloride sheet. The upper part is clear and the base is black.

The fill/discharge pipe is on the bottom and an overflow pipe and safety bulb on the top provide protection. Filling and emptying are controlled with a three-way valve. A plastic hood is available to improve performance and extend the range of the heater.

Source: Poly Vinyl Kogyo Co., Ltd

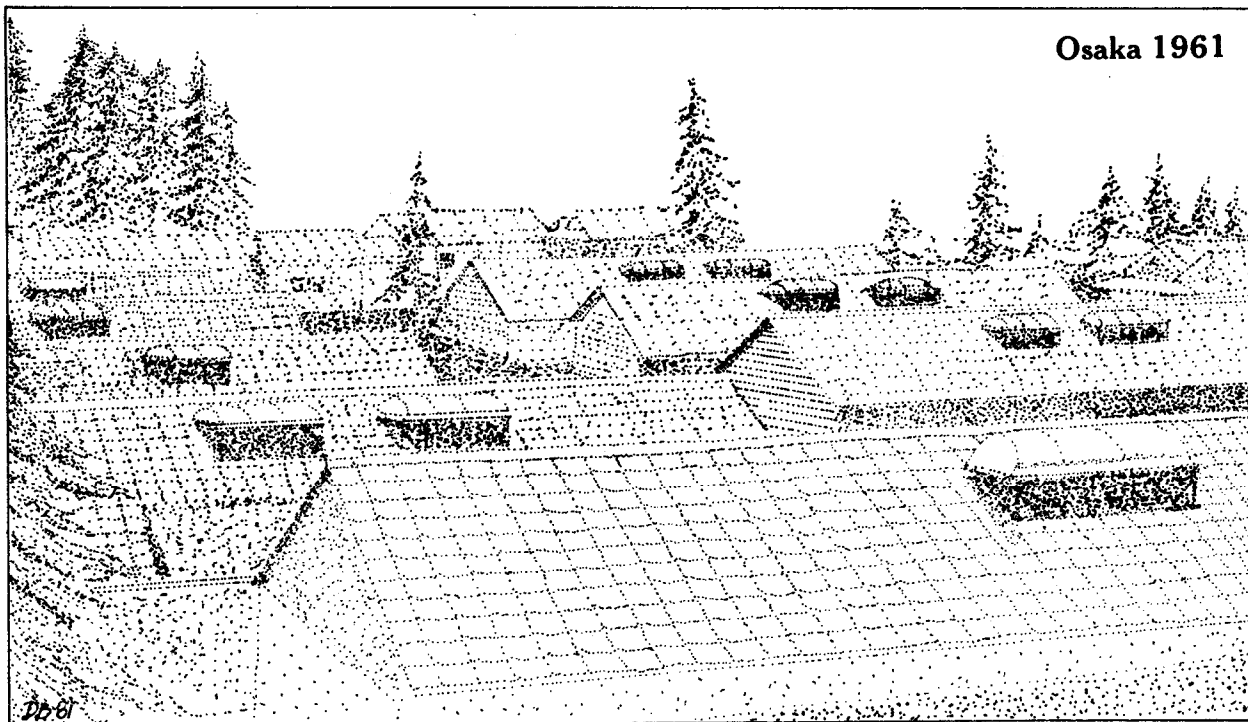
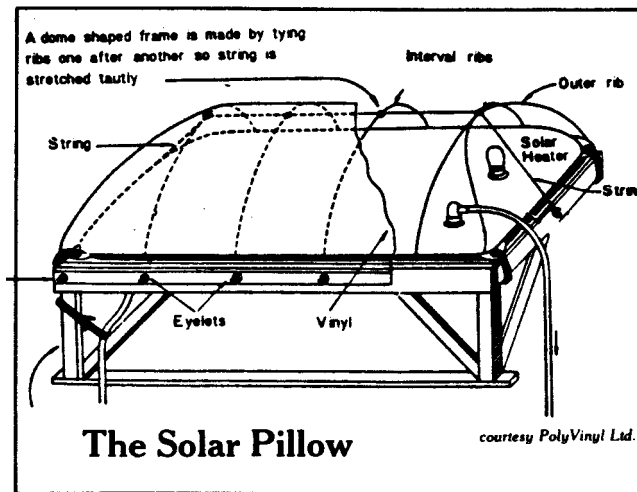

Hitachi Hi Heater

The Hitachi Hi Heater has also been produced for many years and tens of thousands have been Quilt and installed. This IPSWH uses six black rigid polyethylene plastic cylinders in the collector/storage unit. Holding 44 gallons (167 l), these cylinders rest in a 45 x 72 inch (114 x 183 cm) insulated steel box. The collector is single glazed with polycarbonate. The insulation on the inside of the box is covered with foil to reflect more solar energy to the cylinders.

The heater is available with different mounting kits to fit different situations. It is designed for non-pressurized use and does not have freeze protection. A water tank with float valve will allow you to use this in a pressurized system.

Source: Ted Lucas (1977) How To Build a Solar Hot Water Heater, Ward Ritchie Press

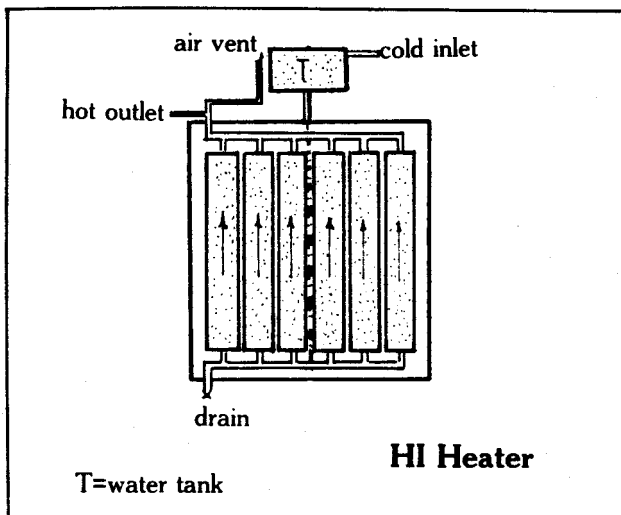

The Solar Shell IPSWH

The "Solar Shell" is one of several commercially manufactured IPSWH's in South Africa. Sizes, quality, efficiency, and price vary little between makes and it will be used as a typical African example.

The "solar shell" uses a special lens shaped stainless steel tank holding 26 gallons (100 l). This cylindrical tank is 3.35 feet (1.0 m) in diameter and rests in a fiberglass reinforced polyester holder. It has an acrylic cover that is also domed with a collection area of 8.7 sq ft (0.8 sq m).

In 1978 the solar shell cost 260 rand (300 rand installed). At this price it produces hot water at an equivalent cost of 0.04' rand per kwh over its ten year lifetime. This was below the cost of existing utility rates.

Source: Willi Sureman, Solar Expert, Ministry of Rural Development, P.O. 686, Maseru.100, Lesotho

A Kiwi IPSWH

The SA V cylindrical collector was one of the earliest modern commercial IPSWHs. It was developed in New Zealand and is now available elsewhere around the world. The heater installations often use two SA V units, at 12 gallons (4.5 l) each, with 6 sq ft (0.6 sq m) of collector area.

The tanks are baffled for internal circulation and double glazed with cylindrical glass shells. Collection is enhanced by adding aluminum reflectors below the SA V cylinders.

Temperatures reached 160°F (71°C) with the two SA V cylinders, while by comparison six flat plate collectors, 48 sq ft (4.5 sq m), heated a similar quantity of water to only 120°F (49°C) in the same period of time. Economic analysis showed the SA V cylinder would save 5.1 kwh per year per New Zealand dollar invested compared with 3.55 kwh per year per N.Z. dollar for the flat plate system.

Source: Stephen Vincze (1974) "Comparative Tests, Cylindrical v/s Flat Plate Solar Heat Collectors," P.O. 10368, New Zealand

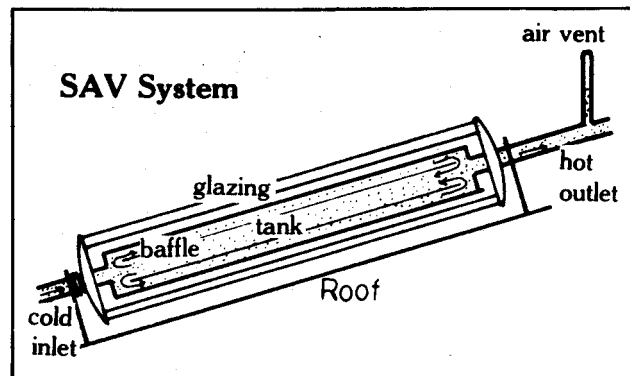

IPSWH's on the Horizon

The most interesting IPSWH waiting in the wings is being developed by Standard Oil of California. If all goes well it will be on the market in 1982 or 1983. It uses Shawn Buckley's patented "thermal diode" to reduce night heat loss and will be freeze proof thanks to stretch designed into the system.

Performance is expected to equal that of a conventional active solar system. Tests are now underway near San Francisco to verify calculated performance estimates. Here's hoping it all works out and can be built at a competitive price.

One of the problems their design group faces is also a particular concern for other large corporations and suggests why most innovation has been done by the "garage" builder. The problem is concern about liability thanks to their position as a large successful firm. This means everything must be much more thoroughly tested than it would be by the "garage" builder.

Source: Thomas Goldman, Standard Oil of California, Solar Projects, P.O. Box 3495, San Francisco, CA 94119

Chapter 10: Market Potential for IPSWH's

The ever rising prices for nonrenewable fuels and their increasing vulnerability are strong incentives for solar systems of all kinds. Integral passive solar water heaters are particularly attractive for the mass market because they are simple, durable, economical, and effective. Whether used as a full time solar heater or preheater or only used in the summer, they offer a very good return for little investment and with little potential for call backs for repair.

To evaluate the potential mass market we need to take a quick look at the demand for hot water in residential uses and a look at where the growth in this demand is most rapid.

A study by the Stanford Research Institute suggests that as much as three percent of all energy use in the U.S. is for residential and commercial water heating. Studies at the Solar Energy Research Institute (SERI) of Golden, Colorado show that the industrial demand for process heat below 100°F (38°C) accounts for probably two percent of U.S. total energy use. Thus, if we look closely at residential, commercial, and industrial thermal requirements we could conclude that as much as five percent of America's total energy demand could be provided by integral passive solar water heating if all sites received sufficient sun. Unfortunately, they won't all have this solar access, but it is certainly reasonable to assume that one half of them will. If all of these heaters were to be installed it could mean a saving of 1.9 trillion BTU's per year-the equivalent of 15 million gallons of oil per year.

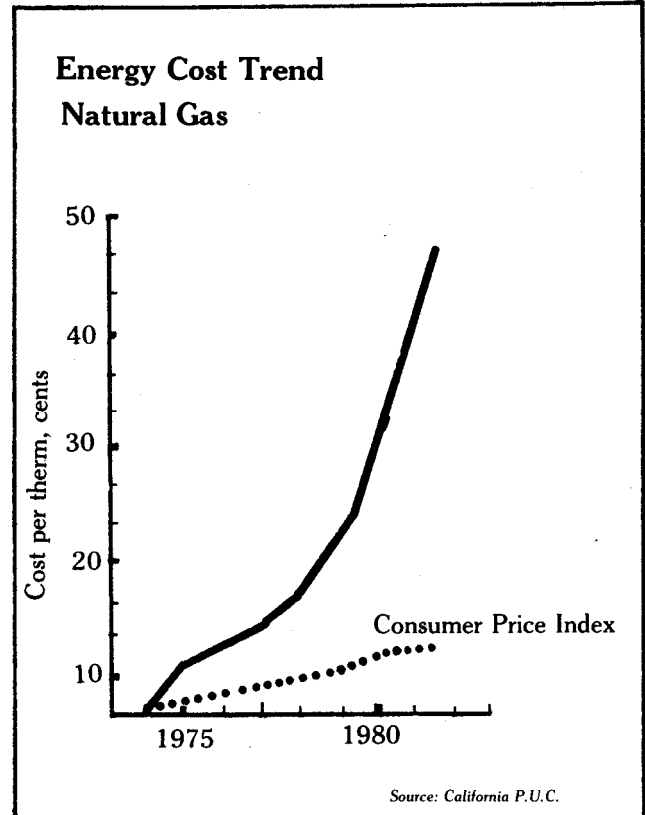

The First Priority-New Residential Construction

The first priority is to ensure that new residential and commercial buildings are equipped with solar water heaters as they are built. Fortunately, the most rapid growth is in the Sun Belt of the southern and southwestern U.S., where IPSWH's work very well indeed. The subdivision scale of development is a perfect environment for the mass produced IPSWH, and many companies will hopefully be entering this field. Probably no other area of solar development offers better opportunities at this instant in history.

The candidate systems for this market will vary some with climate, housing style, and site, but will fall into two major classes: the prefab unit for rooftop, ground, or platform installation, and the site assembled unit for full integration into the roof assembly.

The prefab unit will probably be fully assembled in a factory with only mounting bolts and final hookup required on site. The advantages of the IPSWH for this application will be obvious to anyone who has tried to hold down the cost of building a house. First, no complex plumbing is required-only a stub out from the backup heater and supply line.

New Residential IPSWH's

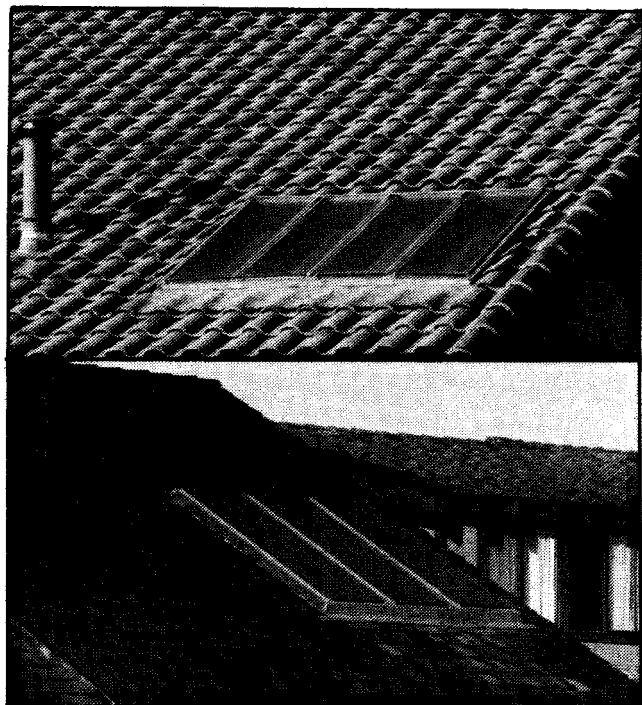

Second, there is no need to mount a tank high in the attic as there is for most thermosiphon systems. This will yield savings in installation and also ease of repair and reduced possibility of damage in the event leaks occur.

Third, there is virtually no problem with high stagnation temperatures damaging the collector as there can be with a flat plate. As soon as the tanks are full, the temperature will remain far below danger points. And even before the tanks are full, they have a higher mass than most flat plate systems and temperatures stay lower.

And finally, the system is considerably more resistant to freezing, and in many areas of the Sun Belt could probably get through the winter even without special protection of any kind. In colder areas, a movable insulation system of some kind will probably prove sufficient. And in very cold areas, some type of a tank within a tank heat exchanger should do the trick.

The site assembled units will almost certainly be more expensive but will probably most commonly be used on more expensive housing where this added cost will not be a handicap. The glazing for these systems can be installed like skylights to provide a harmonious roof line.

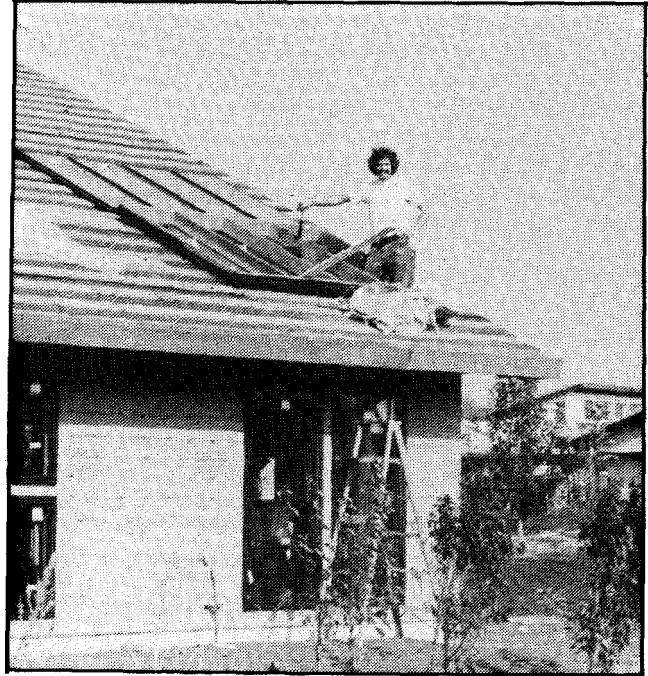

The Second Priority-New Non-Residential Projects

Although there has been little experience with IPSWH's in commercial and industrial projects, there is no doubt that they will prove very workable. In addition to ease of installation of many of these projects, there will be many possible hybrid systems where the IPSWH's are used to collect and store waste heat dumped from lighting, refrigerators, and other equipment.

In many cases the IPSWH's will be able to provide hot water at demand temperature, but they should prove equally economical when used primarily as a preheater.

makes them a very competitive system for much of this market. If we can envision thousands of units in 1981 and many thousands in 1982, there could well be hundreds of thousands in use by 1985. And with each of those units America's energy picture will be a little brighter, and the local economy a little stronger.

The Big Challenge

The largest and most challenging market, however, will be the retrofit market-which is ideally suited for the small business which can develop adequate systems for the many different types of installations more effectively than a large firm.

The winners in this market will be those who get started early in the game, adapt quickly as new materials and information become available, and provide a well crafted and reliable product at a competitive price. It's really not much different from any other business, but is, in my opinion, a better bet right now because it is basically an open market with little competition and with very strong external forces, primarily increasing energy cost and reduced security of supply, influencing it.

The retrofit market for solar water heaters in the Sun Belt alone is probably close to ten million homes, a considerable opportunity. The reduced first cost of IPSWH's compared to active or flatplate passive systems

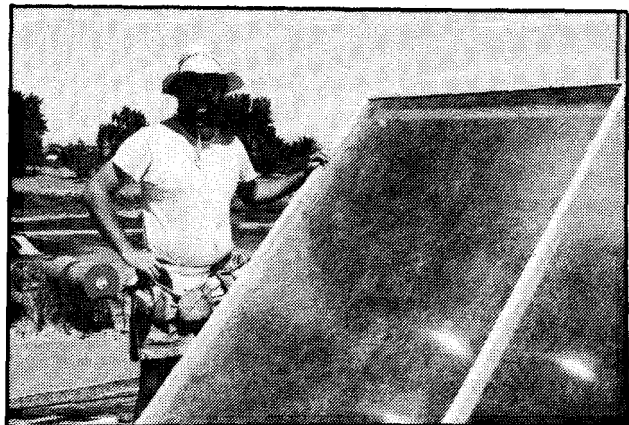

Retrofit IPSWH

Chapter 11: Starting an IPSWH Business

The opportunities for setting up a business building IPSWH's or supplying builders with IPSWH's are almost unequalled in America today. This section looks at some of these opportunities and offers some suggestions on how to get started-and stay-in business. These are listed in ascending order of cost and complexity. Before you begin any program involving IPSWH's, I would strongly urge you to build and use one on your own home.

Installer/Scratch Builder

The easiest, although not necessarily the most desirable, method to start an IPSWH business is to start installing commercial models or building your own IPSWH for customers. This can be started out of your home and garage for only a few hundred dollars in many states. In other states it may require a contractor's license, which will add to the cost and quite possibly to the time it takes you to get started.

Ideally, you should already have construction experience and be familiar with the techniques and tools of plumbing, carpentry, and roofing. A beginner's kit of tools could be purchased for about \$450 and should include:

- Good extension ladder, 20 to 24 ft (6 to 7 m), perhaps rented initially
- Circular Saw (Skil 77 or equivalent)
- Hammer
- Hand saw
- Tin snips
- Pipe wrenches
- Propane torch kit
- Paint brushes
- Chisel(s)
- Putty knife
- Drill
- Trisquare
- Caulking gun
- Tape measure, 16 ft
- Screwdriver(s)
- Large adjustable wrench
- Tubing cutter

Note: Always buy the best-they'll save time and be safer and easier to use-which means saving money for you.

You will also need a trailer, truck, station wagon, or roof rack which can be rented initially if you don't have one or have access to one.

Along with tools you should expand your insurance coverage to protect yourself and your clients. A good book on setting up a business should also be consulted. I would recommend *Small Time Operator* by Bernard Kamoroff.

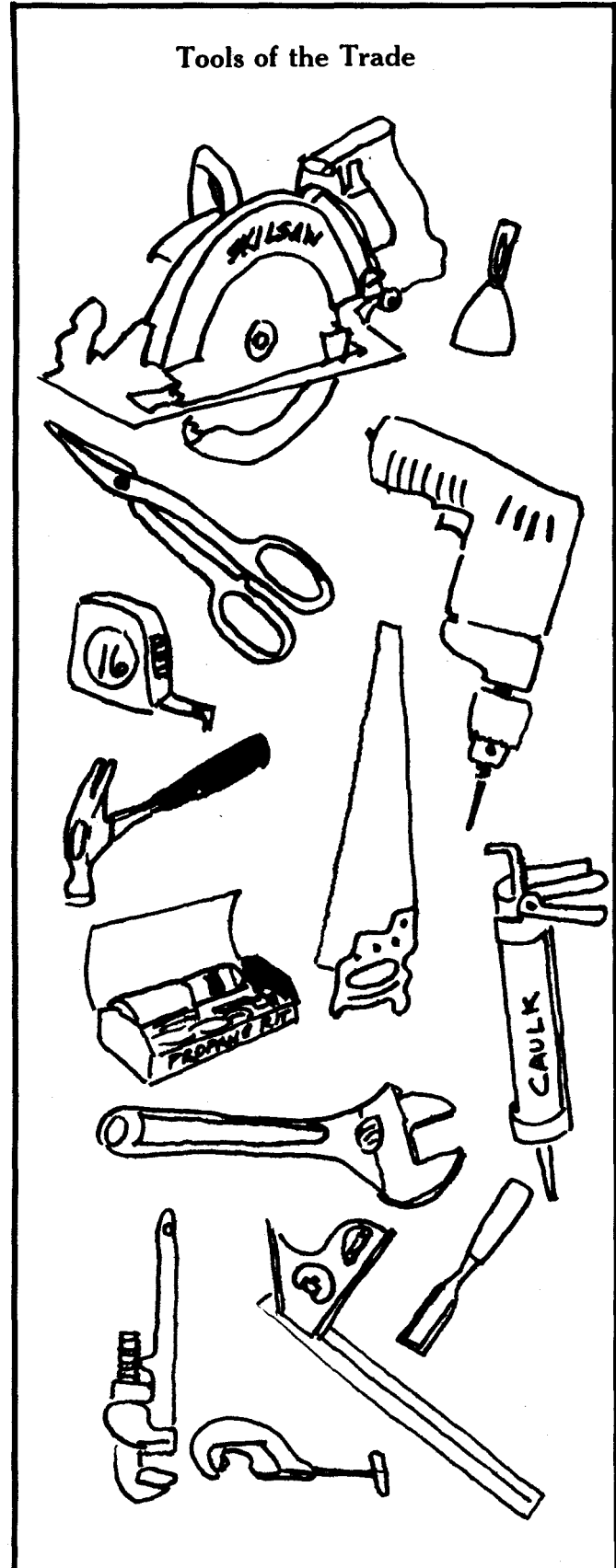

Start on weekends or evenings with solar systems for your friends or friends of friends. Keep the newspapers involved and you should be able to generate enough work for this stage. Later on, use ads in the local papers as necessary to drum up business. Do a good job-never stint on quality-and be fair and on time. This should generate enough word-of-mouth referrals to keep you as busy as you'd like.

A logical companion to an IPSWH business would be a solar greenhouse division. Not only do solar greenhouses provide efficient solar heating and potentially improved cooling, but they also make an excellent location for an IPSWH in colder climates.

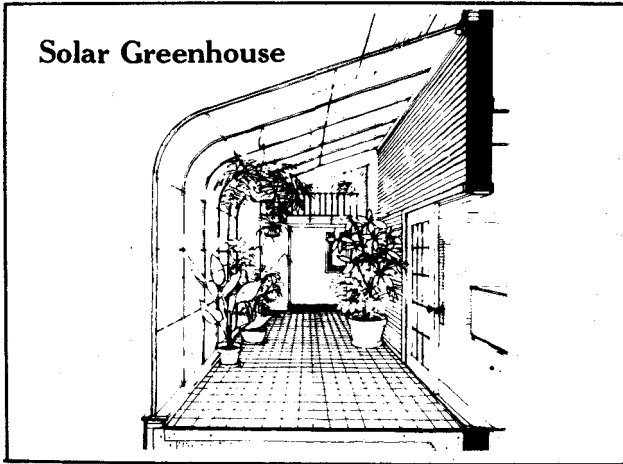

Courtesy: Four Seasons Greenhouses

Contractor/Installer/Builder

If the first stage goes well and is satisfying you might like to expand operations and add a crew. This brings the opportunity for greater success or failure, so think it over carefully before plunging in. You will have to be responsible for employees (and their work) and manage time, materials, and clients more carefully to succeed.

The chief advantage of this scale is increased volume-with the potential for savings on material and more experienced labor. This is particularly true if you can land a subdivision scale job.

Finding and keeping good employees will probably be almost as hard as dealing with the additional layers of bureaucracy that will inevitably accompany your expansion.

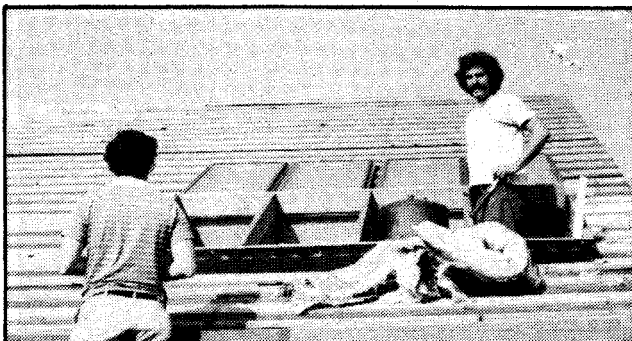

John Burton, Integral Design

It's as Easy as 1, 2, 3 . . .

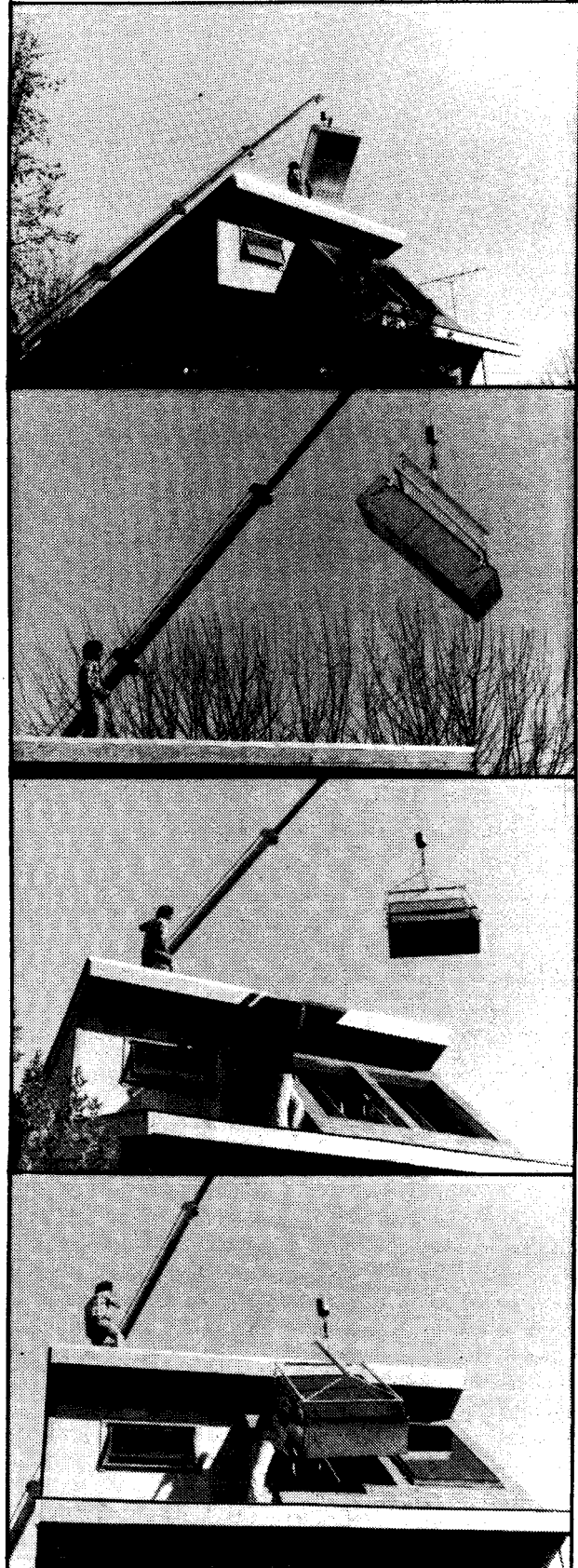

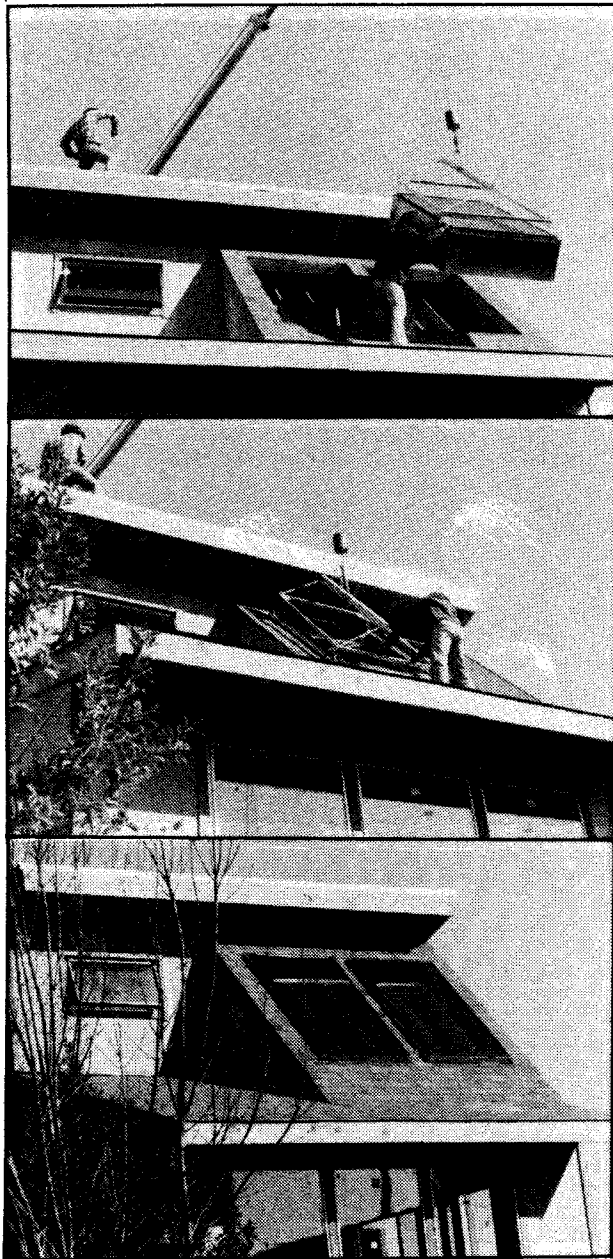

Supplier

One of the most attractive opportunities in IPSWH's right now appears to be as a supplier. This step requires more money for space, inventory, and promotion. It will probably also take longer to turn a profit. Location and marketing will be critical. Some idea of the potential can be appreciated by comparing the current retail cost of glass lined water tanks-about \$90-with the cost in large quantities of less than \$20 apiece.

In the beginning you might just warehouse and sell supplies locally as you test the market. If all goes well, a pre-cut kit might also be very successful. This kit might include all plumbing, tanks, insulation, and glazing with the buyer to supply locally available wood. As volume is built up the earnings should be very good.

As time and money allow, you might expand your service to include wholesale supplies to other energy conservation product stores and IPSWH contractors. This obviously would require more space, sales and marketing expertise, and capital. At this scale, however, you could begin to justify custom manufactured components-which could reduce your costs and improve your sales.

Manufacturer

The next step up is that of manufacturing a complete IPSWH. This could be begun on the small scale (the "cottage" level), but it might be easier to start manufacturing in quantity. This step requires considerable capital, skill in managing people and money, and engineering and manufacturing expertise. You will probably need a plant, manufacturing equipment (including stamping or moulding for copper and/or plastic), and a delivery system.

Manufacturing is the big leagues, with the opportunity for large monetary rewards-or losses. It is not for the timid, lazy, or unmotivated. It may well take virtually all your time and energy for several years, so planning is critical. Make sure you have the money, expertise, and market for a strong effort-or don't attempt one. There is of course no surefire road to success-but careful planning, hard work, and continued evaluation should afford a good chance.

The people at the Center for Maximum Potential Building Systems, developers of the Crystal City Collector facility and builders of the Solar Tube, will provide consulting advice on setting up a manufacturing facility for IPSWH s. They also sell a preliminary book on this subject for \$10. They are seeking a \$7,000 grant to refine the book and produce 200 copies for distribution. Write Pliny Fisk, CMPBS, 8604 Webberville Rd., Austin, TX 78724 for more information.

Crystal City Factory

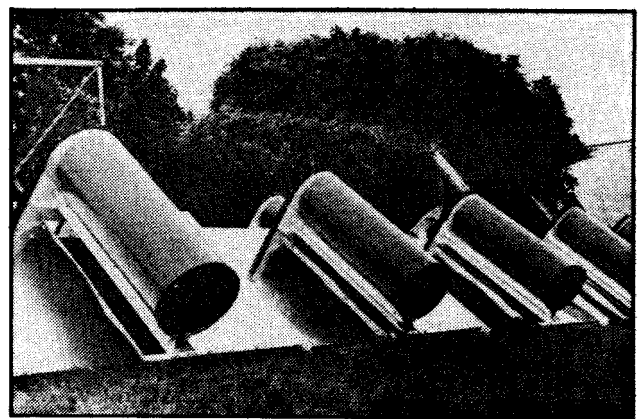

Courtesy: Pliny Fisk

Chapter 12: The Future is For IPSWH's

The ever escalating costs of traditional energy sources and the tenuous security in regions where oil is produced will make the 1980's the solar decade. IPSWH's will play a rapidly increasing role both in the United States and abroad.

The total number of IPSWH's in use in the U.S. is not precisely known. In conducting the research for this book I discovered about 5,000 units, and based on this I would "guesstimate" there are perhaps 10,000 IPSWH's in use in the U.S. In the next year I wouldn't be surprised to see this quadruple to an estimated 40,000 units.

As public awareness of IPSWH's grows, I expect to see much greater production activity on four broad fronts: the homeowner and owner-builder, the small business enterprise, the home building industry, and the larger corporation.

Homeowners and owner-builders, who have previously dominated the field, will continue to be a major force as more and more individuals construct and install their own IPSWH's. Because of its simplicity, building an IPSWH is a feasible project for the owner-builder, and the low price possible with recycled materials (\$1 to \$300) makes building your own the ideal choice for the economically pinched middle and lower income groups.

Substantially more activity is also expected in the small manufacturing/installation business sector. I have identified only twelve businesses in my research, but I would estimate twenty such groups now exist in the U.S., with the capability of producing a total of about 10,000 IPSWH's a year. By year's end, an increase to fifty such businesses, producing several thousand IPSWH's a year, would not be surprising.

The commercialization of IPSWH's by the building industry will also increase as the concept becomes more widely known. The simplicity of IPSWH's makes them an ideal candidate for integral construction by building subcontractors, just as passive space conditioning systems are. Perhaps we will finally see the beginning of subdivision scale IPSWH activity.

The larger scale of manufacturing is also likely to get underway this year. If testing proves successful, Standard Oil of California will begin manufacturing thousands of IPSWH's later this year or early in 1982. Other

companies are also likely to start production of IPSWH's or to increase existing production to a larger scale, either with standard models or exciting new IPSWH designs.

And finally, we can also expect to observe an intensified interest in IPSWH's by commercial and industrial users. These applications have been largely ignored to date, but are very promising. Industrial and commercial users generally have better solar access, higher demand for hot water, and are more energy cost conscious than the homeowner.

Overall, then, I expect 1981 to be the beginning of an IPSWH boom and invite you to participate in America's transition to renewable fuels. You can conserve energy, save money, make money, promote self-sufficiency, and provide a small measure of security for your family.

IPSWH activity around the world will also be expanding in the 1980's. First and foremost will be the continued success of the Japanese, South African, and New Zealand commercial models, working in a virtually open market against more conventional fuels. Installations will probably continue in the tens of thousands per year early in the decade, moving toward the hundreds of thousands by 1985.

IPSWH activity will also increase in the more impoverished areas around the world as the principles become more widely known. IPSWH's are ideal for the rural village with limited access to conventional fuels and the materials and skills needed for sophisticated solar systems. The necessary materials are available virtually everywhere: glass, black paint, wood, insulation (be it sawdust, cork, or reeds), and galvanized iron, ceramics, or drums. And the required construction skills are known to almost any homebuilder or local craftsman.

Because of its simplicity, cost-effectiveness and reliability, the IPSWH is an ideal-and perhaps the best-solar application, and will certainly be the focus for dramatically increased interest, development, and production in the 1980's. It is also a key element in the long overdue transition to renewable fuel sources. Let us begin.

"The journey of a thousand miles begins with a single step."

-Lao Tzu



Appendix 1: Captain Solar's Economy Solar Site Evaluators

Method 1:

To determine the best site for your IPSWH you may want to build a solar site evaluator. You can build a useful site evaluator in less than two hours virtually for free by following the directions here. It is best suited for evaluating the sun's winter, spring and fall exposure. If you will have a summer only heater, use method 2. You will need:

1. a cardboard box (file type or orange box 10in high x 12 in wide x 5 in long or a bit bigger)
2. a knife (razor knife is best)
3. a pen
4. string and paper clip
5. tape (masking or transparent)
6. a compass (or magnet, needle, and thread; or determine south empirically)
7. a ruler, yardstick, or tape measure

Begin by finding and marking the midpoint of each long side along the bottom of the box. Draw a line between these two midpoints across the bottom of the box, both on the inside and outside of the box bottom. This will represent the north-south line.

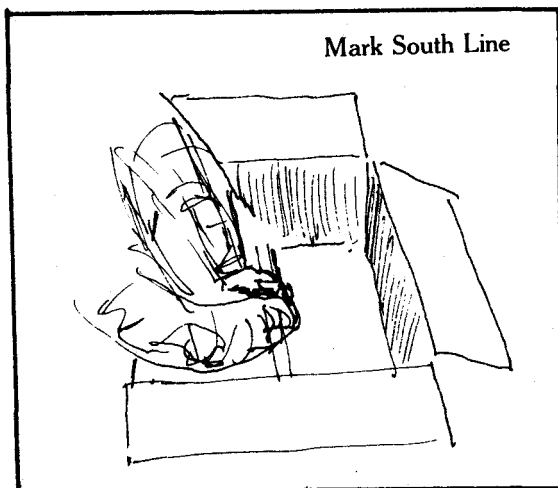

Interpolation is done by first figuring the difference between the A values for the two nearest latitudes. Divide this result by 8 to get the difference per degree. Then multiply this result by the number of degrees you are away from the lower listed latitude. Add this result to the lower listed A value and you're done.

For example: If you are at 36°N the Dec 11 a.m. A number is estimated in the following manner. (40° A value = 2.7) minus (32° A value = 1.9) = 0.8. 0.8 divided by 8 = 0.1. The difference in latitude is 36°-32° = 4°. Then (4 x 0.1) = 0.4, and add this to the lower A value, 1.9 + 0.4 = 2.3. Thus for 36°N you would use 2.3 as the A number for Dec. at 11 a.m. This is not exactly correct, but it is a reasonably good approximation—well within the tolerance of the instrument. (Interpolate between B values the same way.)

The next step is to layout the sun's path on the outside of one of the long sides of the box by using the information in Table 1. Start by drawing a vertical line down the middle of this side of the box. This will represent the noon line. Mark off on this line, starting from the bottom, the heights of the sun at noon during the different months of the year for your latitude. These will be the "A" values in the noon column for your latitude. You can either use the nearest latitude from the chart, or you can interpolate between the A values for the two nearest latitudes.

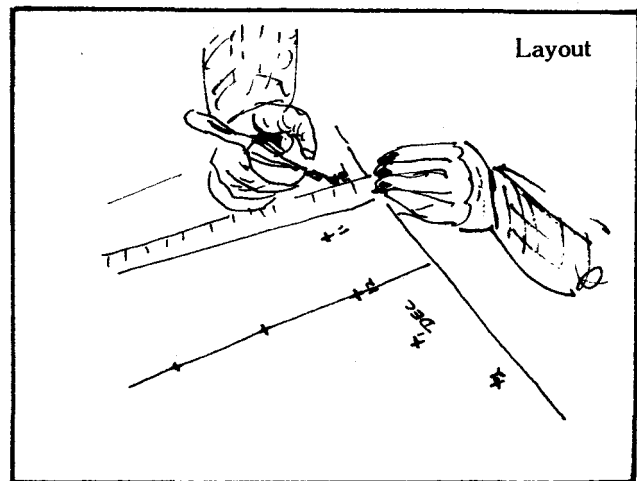
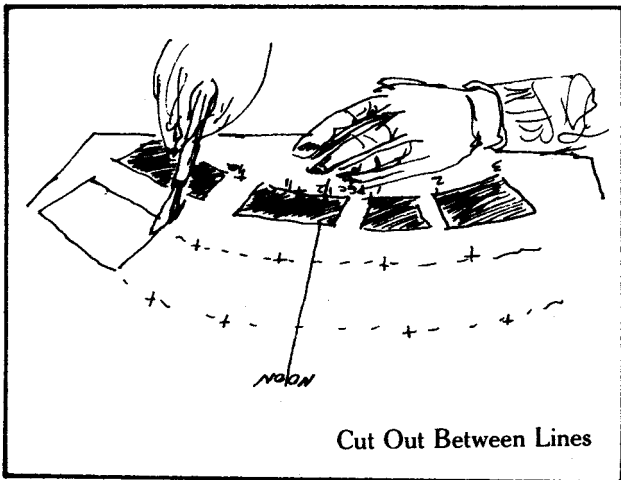

Table 1: Sun Position Converted to A and B in Inches

Latitude	Date	Time of Day a.m./p.m.				
		8/4	9/3	10/2	11/1	12 noon
24°N	Dec 21:	A = 1.8	2.7	3.3	3.6	3.7
		B = 5.7	4.1	3.0	1.3	0
	Feb/Oct 21:	A = —	5	5.4	5.7	5.7
		B = —	6.2	3.8	1.8	0
	Mar/Sept 21:	A = 8.9	8.9	8.9	8.9	8.9
	Dec 21:	A = —	2	2.4	2.7	2.8
32°N		B = —	3.8	2.4	1.2	0
	Feb/Oct 21:	A = —	3.7	4.1	4.3	4.4
		B = —	5.3	3.3	1.5	0
	Apr/Aug 21:	A = —	—	—	—	11.2
		B = —	—	—	—	0
	Mar/Sept 21:	A = 6.4	6.4	6.4	6.4	6.4
40°N	Dec 21:	A = —	1.3	1.7	1.9	2
		B = —	3.6	2.3	1	0
	Feb/Oct 21:	A = 2.2	2.8	3.1	3.2	3.3
		B = 7.5	4.7	2.9	1.4	0
	Mar/Sept 21:	A = 4.8	4.8	4.8	4.8	4.8
	Apr/Aug 21:	A = —	—	—	—	7.6
48°N		B = —	—	—	—	0
	Dec 21	A = —	—	1.1	1.3	1.4
		B = —	—	2.1	1.0	0
	Feb/Oct 21:	A = —	2.1	2.3	2.4	2.5
		B = —	4.3	2.5	1.2	0
	Mar/Sept 21:	A = 3.6	3.6	3.6	3.6	3.6
48°N	Apr/Aug 21:	A = —	—	—	—	5.5
		B = —	—	—	—	0
	Jun 21:	A = —	—	—	—	8.7
	B = —	—	—	—	0	

Next, fill in points on the box for each of the other hours for the different months for your latitude. For each case you start at the noon line at the bottom of the box. Measure horizontally over a distance "B" to both the left and right sides of the noon line. On each side then measure vertically up the box a distance "A", make a mark and note. For example, Dec. 11 a.m. for the right side mark and Dec. 1 p.m. for the left side mark.

When done, connect the dots for each month with as smooth a curved line as possible. Now cut out as much of this viewer side of the box as you can without overly weakening it. Start by cutting out between the December line and one-half inch below the October line, leaving only two or three cross pieces between for support. Then cut out between the October/February line and one half inch below the August/ April line, again leaving a few cross support pieces. And so on until the final cut out is between the top line and one half inch below the top of the box.



Next draw a line four inches from the viewer (sun path) side on both short sides, the top, and the bottom of the box and cut off the back of the box. This leaves the viewer side and a four inch border of the remaining box. Then cut away the four inch top flap.

You are now ready to finish the viewer. First bend a small (1/2 x 2 in) tab of cardboard to form a right angle. Punch or cut a small peephole in the tab next to the bend. Tape the tab to the bottom of the viewer at the cut off edge of the north-south line so that the peep hole is four inches from the viewer grid and right at the floor of the box.

Next, tape a piece of cardboard (about 2 x 8 in) across one top corner so that the middle of the piece is about three inches from the corner. Tape or tie the paper clip to the string and tie the other end of the string to the cardboard crosspiece so that the paper clip hangs just off the bottom of the viewer. Put the viewer on a level surface and make a mark where the paper clip nearly touches the bottom of the box. This is your plumb bob to keep the viewer level as you use it.

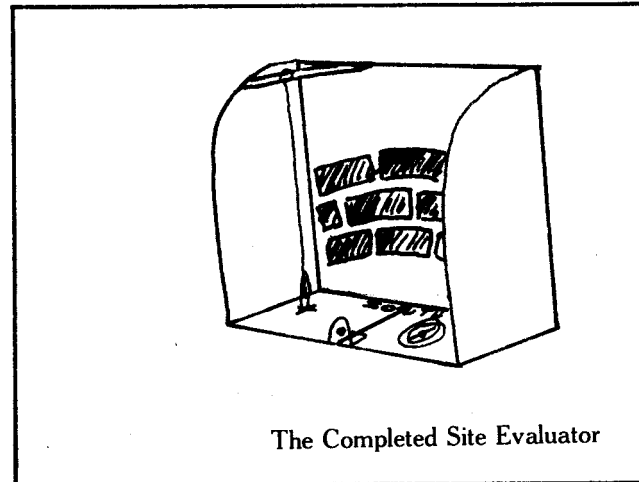

Finally, you will need a compass so that you can orient the viewer properly. If you don't have a compass, you can magnetize a common needle by stroking it lengthwise with a magnet, and then hang it by a string in the other corner of the viewer. Draw a line under it which shows magnetic south (not the same as solar south due to magnetic declination) and you are ready to begin.

To test a possible IPSWH site you will need to stand or sit so the site selector is approximately in the center of where the collector would be. Then orient the viewer to the south by using the compass. Level it by looking over at the paper clip and ensuring that it is centered. Then look through the peephole through the viewer and you can see when the sun will be available and when it will be blocked. For each of the months on your viewer you can estimate how many hours of sun you will have. Solar radiation data applicable to your area should be available, if you search for it. Combine this information with your estimates of exposure time to determine how much solar radiation your IPSWH will receive at different possible sites.

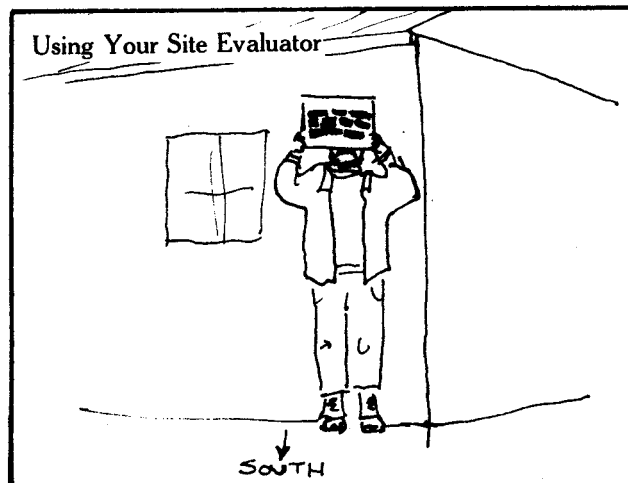

Method 2:

If you want a more detailed and accurate method that works well in summer you can use the site plotting method. You will have to obtain a good sun path chart for your latitude. Several solar books have these as appendices or you can order an excellent set from Robert Bennet, 6 Snowden Road, Bala Cynwyd, P A 19004 for \$5 ppd or \$2.50 for enlarged chart for your latitude.

You will also need to make a site calculator to help plot obstructions. A simple instrument can be built for less than \$5 using a protractor, a piece of string, a washer, and the cut off barrel of a pen with the clip left on. Plans for assembling the site calculator are included below.

To plot all the obstructions may take a while but you can spread it out over several days if desired. Begin by finding magnetic south with the compass. Correct for magnetic deviation and find true south. Now use the site calculator to find the boundaries of all obstacles directly to the south and plot them in pencil on your sun angle chart. You can generally disregard all sun below 20° above the horizon because the sun is weak when it is low.

Next find 10° to east of south and plot all the obstacles there. And so on around to the east and then to the west. Connect all the dots on your chart to show the times that will be shaded and those that will be in the sun. With local solar radiation data you can calculate performance fairly accurately if you wish.

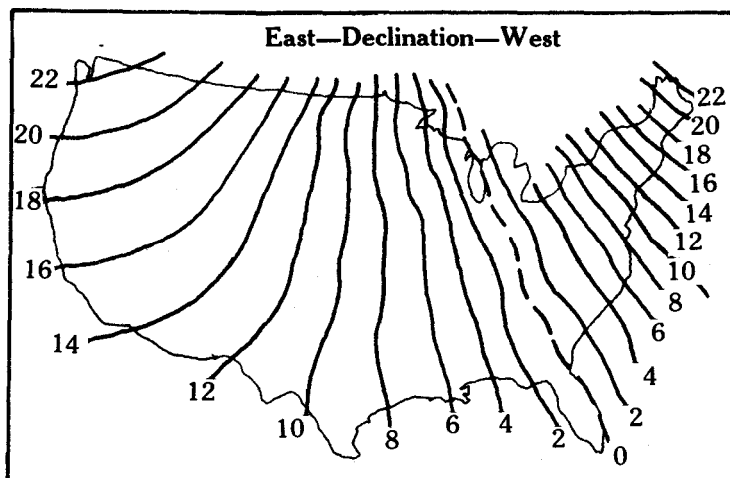
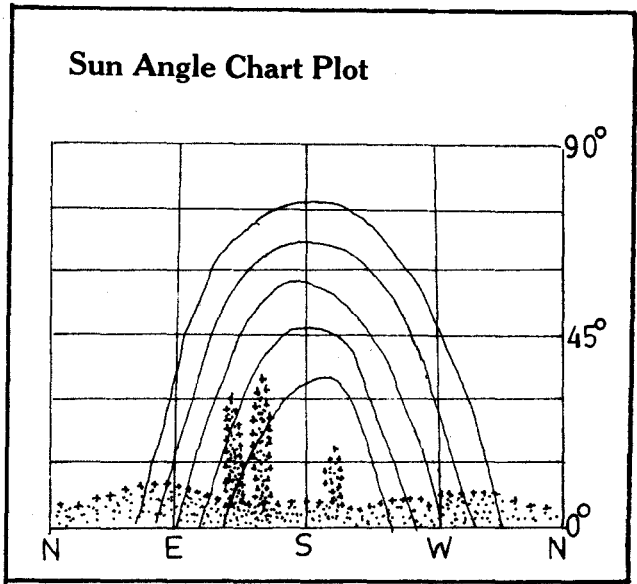
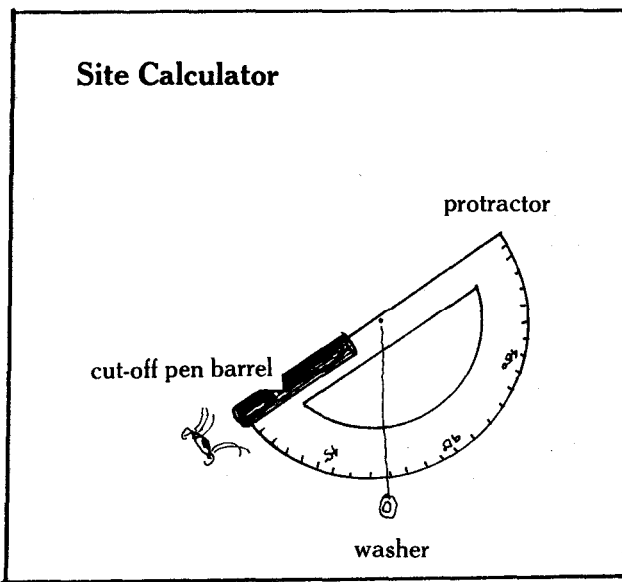

Finding True South

Appendix 2: Resources

I. Materials for IPSWH Construction

Major Suppliers:

Peoples Solar Sourcebook \$5
450 E. Tiffin
Bascom, Ohio 44809
419-937-2226

Energy House \$3
P.O. Box 5288
Salem, Oregon 97304

Solar Hardware Supply Company \$1
(refunded with first purchase)
2160 Clay Street
Denver, Colorado 80211

Energy Shack N/C
P.O. Box 7305
Flint, Michigan 48507

Kalwall Solar N/C
P.O. Box 237 Manchester,
N.H. 03105

Zomeworks
(send 9" x 12" Self Addressed Stamped Envelope)
P.O. Box 712
Albuquerque, New Mexico 87103

You may also find many products you will need at your local hardware store or through Sears or Wards.

A. Tanks

American Appliance
2425 Michigan Ave.
Santa Monica, CA 90404

Rheem (Quantity orders only)
7600 S. Kedzie
Chicago, IL 60652

Integral Design
3825 Sebastopol Rd.
Santa Rosa, CA 95401

B. Paint and Selective Surfaces

Berry Foil Selective Surface

Berry Solar Products
P.O. Box 327
Edison, N.J. 08817

Enersorb
Desoto, Inc.
1700 S. Mt. Prospect Rd.
Desplaines, Illinois 60018

Maxorb
Engenics
681 Lawlins Rd.
Wyckoff, N.J. 07481

C. Glazing

The best glazing material for most purposes is glass. It is the most durable, attractive, and is recyclable. For added strength use tempered glass. Design your IPSWH for existing glass size as custom tempered costs twice as much. The following sizes are usually available locally: 28"x54", 28"X76", 34"X76", 46"X76", 22"x76", 33"x76", 34"X74", 34"X78", 34"x79", 34"x92", 45"x76", 46"X77", 46"X78", 58"x76", 46"x79", 46"x92", 58"x92". You can often reduce the cost by buying seconds or used glass.

Good Earth Glass & Sun
729 Heinz Ave. #10
Berkeley, CA
415-843-3109
Bob Daley

Glass Factory
Box 1372
Taos, New Mexico 87571
505-758-9344

Kalwall Corp./Solar Division
P.O. Box 237
Manchester, NH 03105
603-668-8186
sales department

SolaRoll Framing Strips
Bio-Energy Systems, Inc.
Box 87
Ellenville, NY 12428

Ventarama Skylights
75 Channel Drive
Port Washington, NY 11050
(516) 883-5000

Kennedy Sky-Lites, Inc.
3647 All American Blvd.
Orlando, Florida 32810
(303) 293-3880

Pfeiffer Skylight Corp.
14692 Wicks Blvd.
San Leandro, CA 94577
(415) 357-1400

Exolite Obl. Skin
CY/RO Industries
West Main St.
Bound Brook, NH 08805
(201) 356-2000

Polycarbonate Glazing
Park Energy Company
Star Route 9
Jackson, Wyoming 83001
(307) 733-4950

Polycarbonate-Polyglaz
Sheffield Plastics, Inc.
Sheffield, MA 01257
(413) 229-8711

Filon Div. FRP Glazing
Vistron Corp.
12333 South Van Ness
Hawthorne, CA 90250

Heat Mirror
The Southwall Corporation
3961 East Bayshore Rd. Palo
Alto, CA 94303

D. Valves and Etc.

Richdel Inc.
Solar Division
P.O. Drawer A
Carson City, NV 89701

E. Pipe Insulation

Teledyne Mono-Thane
1460 Industrial Parkway
Akron, OH 44310

Urethane Molding Inc.
RFD 3 Route 11
Laconia, NH 03246
(603) 524-7577

Insultek Corp.
82 Crestwood Rd.
Rockaway, NJ 17866
(201) 625-3828

The Retro Co.
40 Oping Rd.
Pompton Plains, NJ 07444

Wrap-on Co.
341 W. Superior St.
Chicago, IL 60610

Frelen Co.
491 Dutton St.
Lowell, Mass 01852

Diversified Insulation
P.O. Box 188 Hamel,
Minn. 55340

F. Insulation

Thermax Foam

Celotex
Box 22602
Tampa, Fla. 33622
(813) 871-4811

BASF Wyandotte Corp.
Styropor Division
1609 Biddle Ave.
Wyandotte, MI 48192

Polyurethane Div.
Mobay Chemical Co.
Pittsburg, P A 15205
Foam Insulation

Dow-Styrofoam Insulation
1703 S. Saginaw Rd.
Midland, MI 48640

Zonolite Panel Foam
W. R. Grace
62 Whittemore Ave.
Cambridge, MA 02140

G. Reflectors

Edmund Scientific
7780 Edscorp Bldg.
Barrington, NJ 08007

Berry Solar Products
P.O. Box 327
Edison, NJ 08817

H. Movable Insulation

Skylid Insulating Louvres
Zomeworks Corp.
P.O. Box 712
Albuquerque, NM 87103
(505) 242-5354 .

Appropriate Technology Corporation Drapes 14
Green St.
Brattleboro, VT 15301

Sun Quilt
Box 374
Newport, NH 03773
(603) 863-2243

Pease
Ever-Strait Division - Rolling Shutters
2001 Troy Ave.
NewCastle, IN 47362
(317) 529-1700

Foylon-Foil Fabric Hybrid
Duracote Corporation
350 North Diamond Street
Ravenna, Ohio 44266 (216)
296-3486

Dalen Automatic Greenhouse Vent Activator
201 Shelake Drive
Knoxville, TN 37922
(615) 690-0050

Heat Motors, Inc.
635 W. Grandview Ave.
Sierra Madre, CA 91024

I. Caulk

The variety of caulk now available is almost staggering. You can get butyl, oil, acrylic, silicone, latex, and other base caulks. Make sure the one you chose is suitable for your application. Silicone seal is best for glass-glass. Butyl is generally best for wet areas or underground. Take a good look at the product literature. The foam caulks are very good for wider cracks.

Polycell One
Coplanar Corp.
1631 San Pablo Ave.
Oakland, CA 94612

Zeus Manufacturing
4 Buckingham St.
Toronto, Ontario M8Y 2W1
(416) 259-5474

Dow Corning 790 Building Sealant
Dow Corning Corporation
Box 1767
Midland, MI 48640
Sweet's Buy.Line or (517) 496-4000

Silicone Seal
Silicone Products Division, G.E.
RTV Products Department
Waterford, NY 12188

Maceo Adhesives, SCM
Wickliffe, OH 44092
(800) 321-3647; Ohio (216) 943-6161

Detco/Grove polysulfide, polyurethane and epoxy sealants
Detco Marine
3452 East Foothill Blvd.
Pasadena, CA 91107
(213) 681-2613

J. Weatherstrip

Macklanburg Duncan
Box 25188
Oklahoma City, OK 73125

Thermwell Products
2049 East 27th St.
Los Angeles, CA 90058

Pemko
Box 8216
Emeryville, CA 94662

Certain Seal
Box 889
Waco, TX 76703

Schlegel Corp.
Box 23113 Rochester,
NY 14692 (716)
244-1000

Gaska Tape, Inc.
1810 W. Lusher
Elkhart, IN 46514
(219) 294-5431

K. Backup Water Heaters 1.

Flash Water Heaters

There are two basic types of flash water heaters, those with a thermostat (necessary for backup use) and those with constant temperature rise (50°F-90°F 10C-32°C) over ambient). Make sure you get the right kind for your purpose.

Thorn Flash Water Heater

Environmental Research Assoc.
Box 351
Vineyard Haven, Mass. 02568
(617) 693-4402

Paloma

Low Energy Systems
Thorndike Arcade, Main St.
Rockland, ME 04841
(207) 596-6525

Chronomite Labs

21011 South Figueroa St.
Carson, CA 90745

Junkers

Pressure Cleaning Systems
612 N. 16th Ave.
Yakima, WA 98902

Net Energy

854 Ninth Street
Arcata, CA 95521

Silverstar RGS

41019 Solieva
Modena, Italy

Lorenzetti S.A.I.B.E.
Av. Pres. Wilson 1230
Sao Paulo, SP
Brazil

Sitam Modena

Viale Indipendenza 5
51010 Modena Est.
Italy

Silvio Serin

Via Col De. Rosso
35100 Padona Italy

2. Wood Water Heaters

If you use wood for much of your heating you may be able to get hot water as well.

Woodburning Water Heaters

Walden Foundation
P.O. Box 5
El Rito, NM 87530

Domestic water heater, wood

Aqua Heater
P.O. Box 815
Clark, CO 80428

Water jacket kitchen wood or coal ranges

Tirolia
169 Dunning Road
Middletown, NY 10950
(914) 343-5900

Handmade Hot Water Systems \$4.95 and Components

Blazing Showers
Elaine Walsh
P.O. Box 327
Pt. Arena, CA 95468

Firebox water heater exchanger

Holly Hydro Heater
Frizelle Enos Co.
265 Petaluma Ave.
P.O. Box 339
Sebastopol, CA 95472
(707) 823-6557

L. Space Heater using Water Heater

The Chill Chaser

T urbonics, Inc.
11200 Madison Ave.
Cleveland, Ohio 44102

II. Recommended Books

- Bruce Anderson and Michael Riordan (1976), *The Solar Home Book*, Brick House, \$9.50.
- Holly Antolini, ed. (1978), *Solar Heating and Cooling*, Sunset, \$2.95.
- Steve Baer (1975), *Sunspots*, Cloudburst, \$5.95.
- David Bainbridge (1979), *The First Passive Solar Catalog*, Passive Solar Institute, \$ 7 .50.
- David Bainbridge et. al. (1979), *Village Homes' Solar House Designs*, Rodale, \$6.95.
- Roger Bryenton et. al. (1980), *The Solar Water Heater Book*, Renewable Energy in Canada.
- Shawn Buckley (1979), *Sun Up to Sun Down*. McGraw-Hill, \$6.95.
- Peter Clegg and Derry Watkins (1978), *The Complete Greenhouse Book*, Garden Way, \$9.95.
- William Langdon (1980), *Movable Insulation*, Rodale, \$9.95.
- James McCullagh, ed. (1978), *The Solar Greenhouse Book*, Rodale, \$9.95.
- William Shurcliff (1979), *New Inventions in Low Cost Solar Heating*, Brick House, \$12.00.

Recommended Magazines

- Solar Age*, P.O. Box 4934, Manchester, New Hampshire 03108, \$20 per year.
- New Shelter*, 33 Minor, Emmaus, Pennsylvania 18049, \$9 per year.
- Alternative Sources of Energy*, 107 S. Central Ave., Milaca, Minnesota 56353, \$15 per year.

**“Informative,
well-written,
interesting and
authoritative . . .**

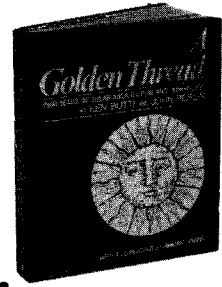

this historical masterpiece will last for a long, long time.”

— John Yellott

“A Golden Thread is must reading for anyone serious about the real potential for the sun’s energy and its place in our history and future.”

— Wilson Clark

“Excellent graphics and a highly readable style . . .”

— Library Journal



With a lively narrative, plus 261 drawings, diagrams and photographs, *A Golden Thread* documents the uses and abuses of solar energy over the past 2500 years, including:

- Greek and Roman solar architecture
- Medieval burning mirrors
- Greenhouses and hot boxes
- Solar motors and engines
- House heating in America and Europe
- Photovoltaic cells
- Solar water heating

Using history as a guide *A Golden Thread* helps you make the informed choices needed for a healthy, independent energy future.

ORDER FORM

A Golden Thread by Ken Butti & John Perlin, Foreword by Amory Lovins, 304 pages. From Cheshire Books, producers of *The Solar Home Book*, 514 Bryant St., Palo Alto, CA 94301.

Name _____

Address _____

City/State/Zip _____

- \$15.95 cloth or \$9.95 paper enclosed per copy.
- Ship COD—add \$2.25. Phone orders (415) 321-2449. California residents add 6% sales tax.
- Moneyback guarantee** if returned within 30 days.



SOD ROOFS

BEAM / DECK AND CORRUGATED FIBERGLAS

1" POLYSTYRENE
CORRUGATED FIBERGLAS-
WELD JOINT, USE NEO-
PRENE GASKETED NAILS
FELT UNDERLAY
RIGID P.U. INSULATION
2X T&G DECKING
BEAMS @ 4'-0" O.C. MAX.
SIZE FOR ALL LOADS

SLOPE FOR DRAINAGE
1 1/2 FT. / 12 FT.

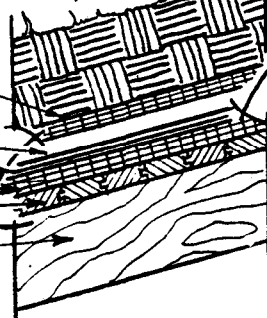

MEMBRANE AND JOISTS

PLANTING (ICEPLANT,
GRASSES, ROSEMARY, ?)
IRRIGATE IN ARID AREAS
1" POLYSTYRENE INSULA-
TION TO PROTECT
MEMBRANE
30 MIL FIBERGLAS
REINFORCED HYPALON
MEMBRANE - WELD
ALL JOINTS... MUST
RESIST ROOT ACIDS
FELT UNDERLAY
PLYWOOD
JOISTS

SLOPE MIN.
1/4 IN. / FT.

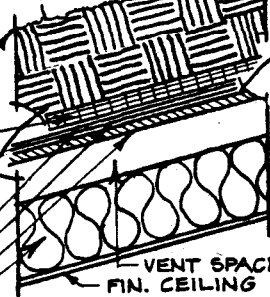

The 2nd Passive Solar Catalog by David A. Bainbridge

Includes: Why passive design makes sense, retrofitting houses for conservation and passive solar heating and cooling, passive solar construction details, fourteen examples of passive design, women in passive solar development, low energy use building materials, living the good life, passive solar design and America's energy future, and fully revised listings of products and consultants for passive solar design.

William Shurcliff, solar expert and author:

"Your Second Passive Catalog has arrived and is great. You have packed an enormous amount of material into a small space, and you have reinforced it with countless excellent sketches and photos... excellent, attractively printed, well worth the price."

**To order, send \$12.50 to:
The Passive Solar Institute
Dept. P**

PO 722, Davis, CA 95616
Allow 4-6 weeks delivery.

Get the Works! Special offer from PSI. Send \$50 for the 1st and 2nd Passive Solar Catalogs, Water Wall House Plan, Passive Water Heater Plan, Solar Simulator Kit, and Village Home Slide Set. An \$85 value.

Bookstores and retailers contact:
Bookpeople, 2940 Seventh, Berkeley, CA 94710.
Orders: 800-227-1516

Passive Solar House Plans and Specifications \$25 (CA add \$1.50 tax)

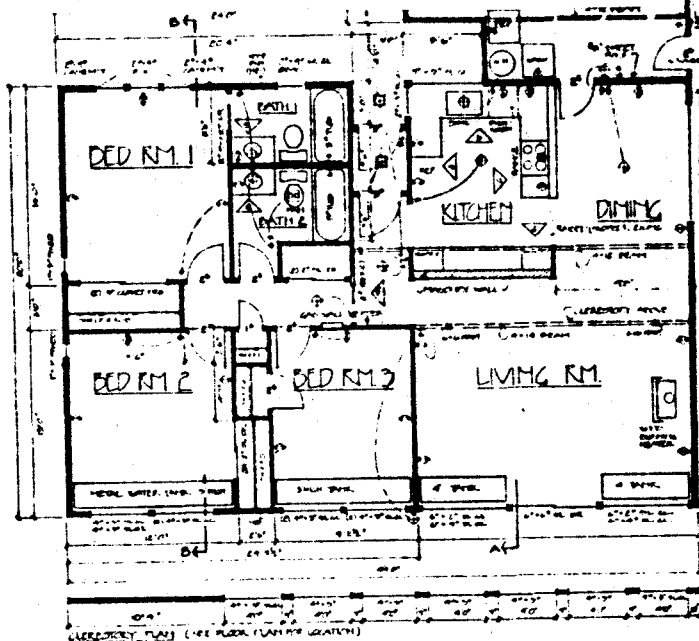

FLOOR PLAN

To help builders and developers get started in Passive Solar building, the Passive Solar Institute commissioned John Hofacre to design a simple, three-bedroom, two-bath water wall house for the sunbelt. Drawing upon his experience from more than 40 passive solar houses he has designed and seen built, John has developed a very pleasing solar clerestory which is presented in the plans.

After the house plans and details were finalized, the Passive Solar Institute engaged Davis Alternative Technology to evaluate the performance of this passive solar home in 10 cities in the areas of fastest growth in the U.S. The results were impressive and show very clearly what can be done without "radical" or expensive designs.

PERFORMANCE OF THE SOLAR CLERESTORY WATER WALL HOUSE

Area	Solar Heating	Natural Cooling
Los Angeles, CA	100%	100%
Sacramento, CA	94%	100%
Medford, OR	72%	100%
Phoenix, AZ	100%	50%
Denver, CO	82%	100%
Ft. Worth, TX	100%	30%
Little Rock, AK	89%	37%
Knoxville, TN	75%	100%
Raleigh, NC	99%	43%
Miami, FL	100%	57%

Appendix 3: Recycled Tanks

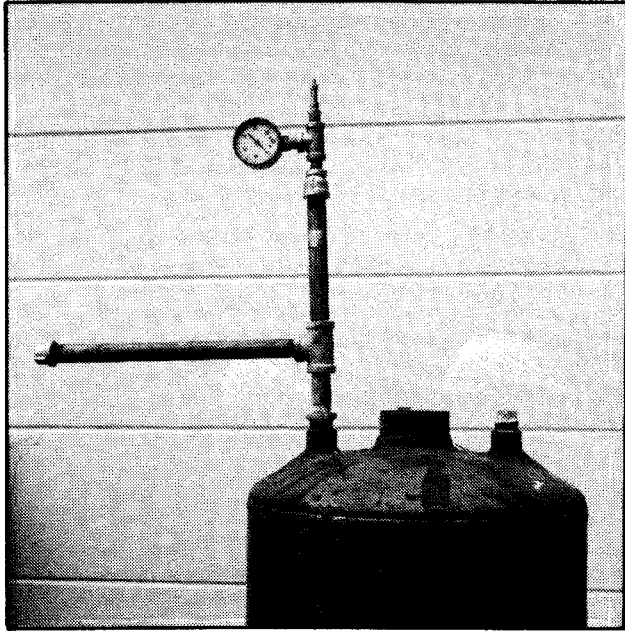

I wouldn't recommend used water heater tanks for anything except home built models with easy access (on the ground, for example). The initial savings in money can very easily be offset by the inconvenience if you have to take the heater apart after two or three years to replace the tank. However, for those of you who can or must use a recycled tank, here are some tips from John Burton and other IPSWH builders.

First, look over the tank before buying it or dragging it home. Only about one in three is usable and the more serious defects will be obvious. Pay particular attention to the welded seams which are generally the first place to fail. Electric tanks may also leak where the element mount is tack welded on, so inspect carefully.

Take home the tanks that appear to be good and clean up the outside. Then take out the fittings; use penetrating oil if necessary. If they won't come out with reasonable force you may be better off leaving them in unless you absolutely have to have them out for your plumbing hookup.

With the fittings off, tilt the tank so the sun shines in a bottom or side hole. You should be able to see the reflection from the glass lining. By rotating the tank carefully you can see most of the inside. An intact lining gives you much better odds for longevity of your tank.

Now rinse out the tank using water, a little detergent and/or mild acid to remove rust, salts, and mineral deposits. A considerable amount may come out even with a good tank so keep at it.

When it seems clean you are ready for a pressure test. First block all except one of the holes with plugs. Attach the garden hose to a hose nipple fitted in this last hole and turn it on. If you have an air compressor (or are willing to haul the tanks to the gas station) you can build an adapter to test the tank with air. If you have a portable compressor, an air test adapter would enable you to test the tanks in the junk yard before you take them home. Run the tanks upto at least local water pressure, 70 to 140 psi.

If the tank leaks (either now or later) you may be able to successfully patch it. Epoxy patching has been used with some success. Patch before painting or sand to the metal if it was already painted.

When there are no leaks your tank passes the pressure test. The next step is to wirebrush the exterior. Then paint the tank with rust preventive flat black paint. Refit with new or cleaned fittings, using Teflon tape or pipe joint compound. A new sacrificial anode may be very helpful in extending the life of the system.

Appendix 4: Performance Prediction

The relative lack of monitoring data for various configurations and types of integral passive solar water heaters makes performance prediction difficult. The following table is a best "guesstimate" of expected performance for an IPSWH with vertically inclined tanks, about two gallons of water per square foot of glazing, in a well insulated box with mild temperatures. This is based in large part on a series of unpublished experiments by Peter Zweig and John Burton and my own investigations.

You can help by monitoring the performance of your own IPSWH and sending me the details. Even simple measurements of water temperature at the kitchen sink (with backup heater off) can be meaningful. Utility bill comparisons, before and after IPSWH installation, are also needed. Please send copies of this type of information to me: David Bainbridge, P.O. Box 722, Davis, CA 95617. Send a photo, description, and details of the heater, too.

Increase in IPSWH Temperature Over Ambient Air Temperature

Type of IPSWH	Daytime High	Nighttime Low	Average
Clear glass bottle or solar pillow	20 to 30°F (11 to 17°C)	0 to 5°F (0 to 3°C)	10 to 15°F (6 to 8°C)
Black collector, insulated box, single glazed	80 to 90°F (44 to 50°C)	20 to 40°F (11 to 22°C)	50 to 60°F (28 to 33°C)
Black collector, insulated box, double glazed or triple glazed	90 to 100°F (50 to 56°C)	30 to 50°F (17 to 28°C)	60 to 70°F (33 to 39°C)

Correction factors:

Transmissive insulation: High -5 to -10°F (-3 to -6°C)
Low +5 to +10°F (+3 to +6°C)

Selective surface: High 0 to +5°F (0 to +3°C)
Low +5 to +10°F (+3 to +6°C)

Insulated lid, closed at night: High +5 to +10°F (+3 to +6°C)
Low +10 to +30°F (+6 to +17°C)

This simplified chart certainly won't cover all cases but should help you estimate how well your heater will work. The use pattern, temperature of water used, and local climate will all determine how much of your hot water will be solar heated. Ongoing experiments this year should help refine this information.

The only simulation program for IPSWH's that I am aware of was done by Davis Alternative Technology Associates, P.O. Box 470, Davis, CA 95617. This effort is a good beginning but needs more validation-by comparison with solid monitoring data from different types of heaters in different climates. Their program is described in the *5th National Passive Solar Conference Proceedings*, Amherst, Massachusetts, 1980.

I would also like to see more work done in system efficiency, as the collector efficiency by itself isn't enough. A good comparison of IPSWH's with thermosiphon and active solar systems would be very useful. This should include a 105°F set point for the backup heater and shifted load to afternoon and evening for the IPSWH. These factors will give a much better picture of expected performance in a real life situation.

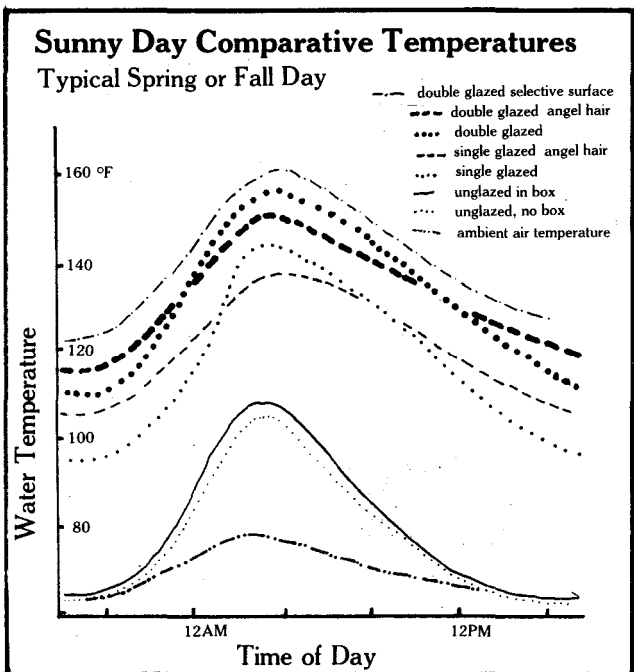

n unpublished research by Burton and Zweig and the author

NOTES:

Appendix 5: Feedback

Since this book is very much a “get started” book, I would appreciate your comments on the book and the impact it has on you. Please send this form to me at the Passive Solar Institute, P.O. 722, Davis, CA 95617.

The IPSWH Book, 1st Edition

Your Name and Address

	Yes	No
Was it easy to follow?	___	___
Was the text clear?	___	___
Were the illustrations and diagrams helpful?	___	___
Did you learn something about IPSWH's?	___	___
Do you plan to build your own IPSWH?	___	___
Did you read all of the book or just sections?	___	___
If just sections which ones?	_____	

What did you find most interesting? _____

What did you find most helpful? _____

What did you find least helpful? _____

What else would you like to have seen? _____

Any other comments? _____

About the Author

David Bainbridge was born in 1948 in Schenectady, N. Y. At the time his parents lived in a log cabin nestled in the woods by a beautiful mountain stream and the mountains and wilderness have continued to play an important role in his life. Family moves and travel have introduced him to the North Cascades, Canadian and Colorado Rockies, and the Sierra Nevada.

After graduating from U.C. San Diego with a major in earth sciences and a minor in surfing he worked for the San Diego Environmental Development Agency in a successful effort to save the coastal lagoons from imminent development. This project led to a Masters degree from U.c. Davis in Ecology with emphasis on ecology, planning, and environmental geology.

While going to school in Davis he worked with the state Joint Committee on Environmental Quality and formed an environmental consulting firm which specialized in Bikeway Planning, Environmental Impact Analysis, and Environmental Planning and Management.

He retired after two hectic and rewarding years to help his parents build a homestead in Cortez, Colorado. This involved completely dismantling and recycling a dilapidated house, including the nails, into an energy conserving house.

On his return to California he worked with the Association of Bay Area Governments on an innovative Land Capability study for the U.S. Geological Survey. This study received a planning award in 1980. At the same time he began the restoration of an 1892 Victorian house in a small town near Sacramento that was to take two years. After completing the ABAG report he began what was to become two years of very interesting and productive work as senior planner and writer for a solar design group in Winters, California.

These two years with Living Systems included project management, research, writing, photography, and design of passive solar and energy conservation projects. David was in charge of the innovative Planning for Energy Conservation study in Davis, which has received international recognition. He also worked on similar solar projects in several other areas and was involved in natural lighting studies for the State Office Building, development of the Energy Conservation Building Code Workbooks for Indio and Sacramento, and the first drafts of a report on the challenge of planning for Solar Access. This study received a planning award in 1977.

He retired to devote more time to completing his passive solar home in Davis and to his writing. Unfortunately, retirement lasted only a month before an urgent call put him to work on the development of the Passive Section of California's Solar Tax credit at the Solar Office of the California Energy Commission. He earned a special commendation from the Energy Commission for his work

on the Solar Tax Credit. Other reports and studies followed at regular intervals, including reports on: Solar Access, Natural Lighting, Solar Greenhouses, Breadbox Solar Water Heaters, and much more. He retired in late 1978 to form the Passive Solar Institute to promote the rapid, widespread transition to renewable fuels.

After finishing his house in Village Homes in January 1978 he became more involved in the affairs of this remarkable 70 acre solar subdivision. He has served on the Board of Directors, the Small Farms review board, and completed a book about the development which was published by Rodale Press early in 1979.

His work at the Passive Solar Institute has focused on the need for better information on the operation and construction of passive solar buildings. He has started the Passive Solar Catalog series, Volume I in 1979, Volume II in 1980, a mini-encyclopedia of passive solar design and directory of products and consultants. He has also prepared a passive solar plan set for sale, invented and marketed a Solar Simulator and consulted on a variety of passive projects for individuals, corporations, and utilities.

He was a contributor to the Passive Solar Design Handbook prepared by Cal Poly San Luis Obispo and the Solar Retrofit book being prepared by Rodale Press. He is currently working on a variety of design and research projects involving passive solar design, wind machines, and energy conservation. He has also taught a variety of subjects at the University of California and more recently at Lake Tahoe Community College where he taught Passive Design for Builders and The Self-Sufficient House. In addition to his work at the Passive Solar Institute he does freelance writing, photography, energy consulting, and concrete and carpentry work for friends. On his time off, which is all too rare, he enjoys backpacking, skiing, surfing, canoeing, playing guitar, and writing poetry.

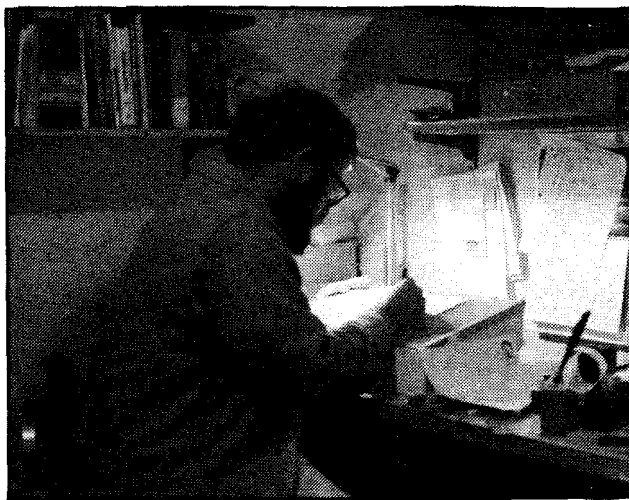

“ . . . so there ain't nothing more to write and I am rotten glad of it.”

Epilog



Are we too poor in purse or spirit to keep the land pleasant to look at and good to live in?

The www.BuildItSolar.com website provides hundreds of free plans for solar and renewable energy projects.

