

# Water for the World

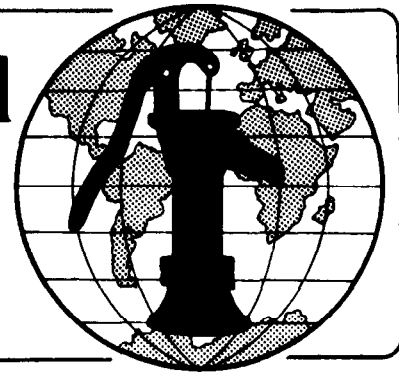

## Designing Privy Shelters Technical Note No. SAN 1.D.3

A privy shelter is a screen or structure that gives the person using the privy privacy. Depending on the design, a shelter can protect the privy and the user from the weather and keep out flies, rats, scavenging dogs, and other pests. Designing a shelter involves selecting the type of shelter; determining shape, size, and special features; and selecting materials, tools, and labor. The products of the design process are (1) a plan view of the shelter; (2) a detailed view of any special features; and (3) a detailed materials list. This technical note describes how to design a privy shelter and produce these three products.

Read the entire technical note before beginning design procedures.

### Materials Needed

Measuring tape - To obtain field measurements.

Scale - To draw accurate diagrams.

### Selecting the Type of Shelter

The three basic types of privy shelters are a simple screen, a shelter with a roof, and a shelter with a roof and door. Figures 1, 2 and 3 show the types of privy shelters.

The most important factors in selecting a type of shelter are local customs and personal preferences of the users. Determine how much privacy people want and whether or not a roof and door are acceptable or desired. Other factors that influence selection are available money, materials, and skilled labor, and the extent to which control of pests is important. Table 1 compares these factors for each type of shelter.

### Determining Shape, Size, and Special Features

Shape. The shelter can be square, rectangular, circular, or spiral-shaped, as shown in Figures 1 and 2,

Table 1. Comparison of Shelter Types

Shelter Type	Advantages	Disadvantages
Simple Screen	User privacy; very inexpensive and easy to build	No protection from weather; not suitable for ventilated privy, compost toilet, bucket latrine, or aqua privy; no pest control*
With Roof	User privacy; suitable for all privies; protection from weather	Slightly more expensive; some construction skills needed; no pest control*
Roof and Door	Complete user privacy; suitable for all privies; protection from weather; pest control*	Moderately expensive; construction skills required

\*All privies must have a lid for the hole. This keeps pests out of the pit, but not out of the shelter.

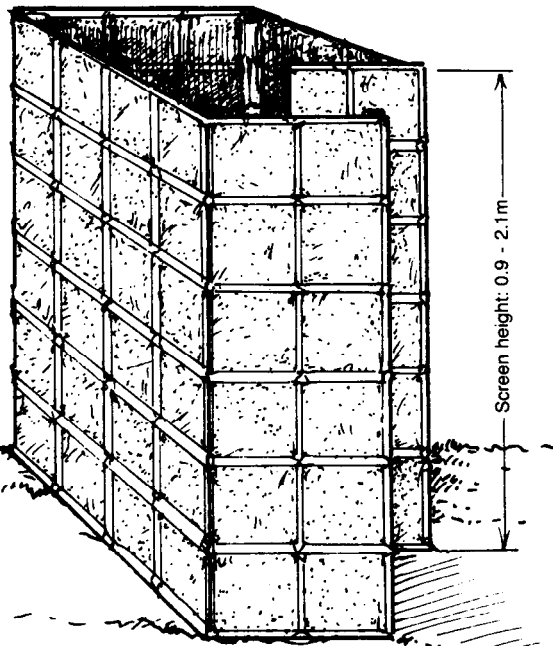

RECTANGULAR (Wattle and Daub)

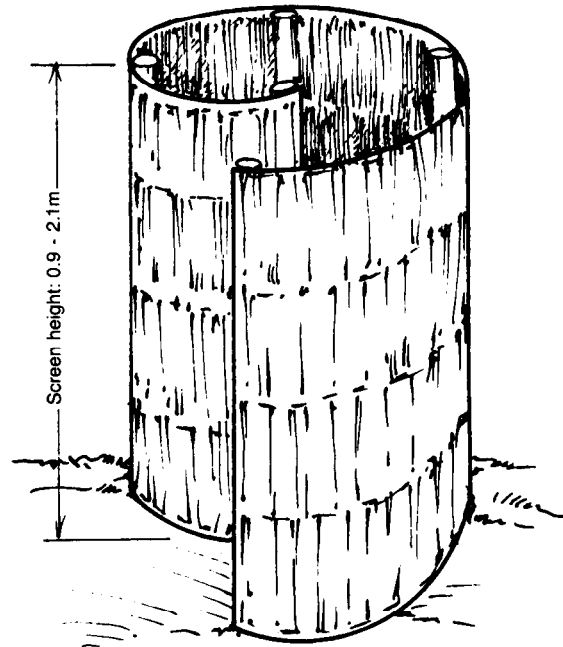

SPIRAL (Palm Thatch)

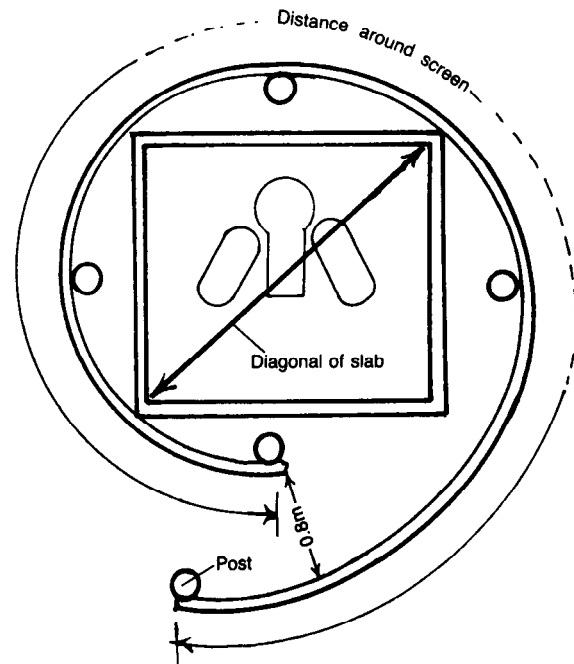
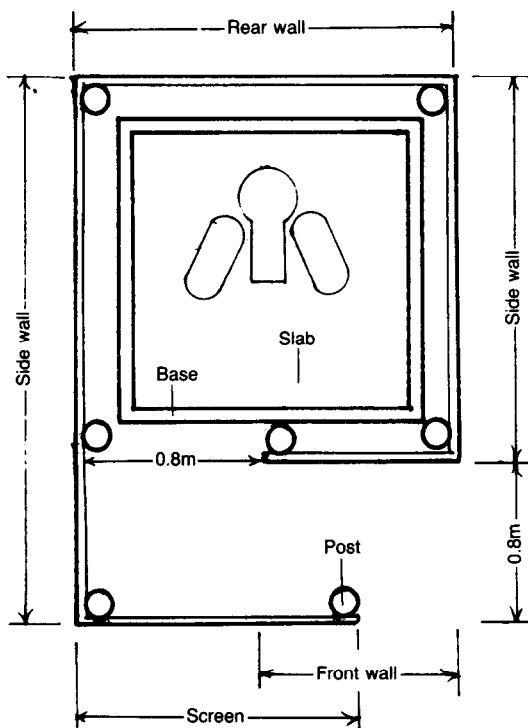
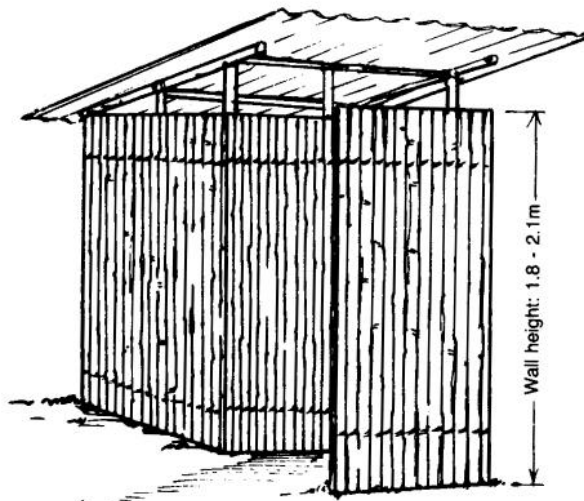

Figure 1. Simple Screen Shelters

depending on local preference. The screen or walls should be vertical. The roof should slope to the rear or sides of the shelter to allow rainwater to run off.

Size. The area inside the shelter should be 1.0-2.3m<sup>2</sup>. This allows enough room for the user without

wasting building materials. Unless the privy is ventilated with a vent pipe, the shelter should completely enclose the privy slab. For a ventilated privy, the part of the slab that holds the vent pipe will be outside the shelter, as shown in Figure 4. The back wall of the shelter should be 150-200mm from the defecation hole.



BAMBOO SHELTER WITH CORRUGATED METAL ROOF

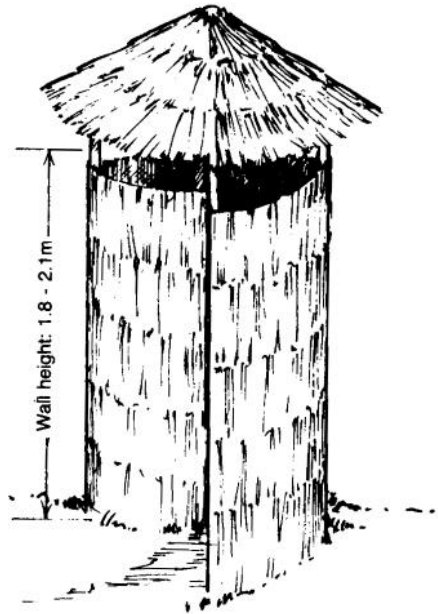

PALM THATCH SHELTER AND ROOF

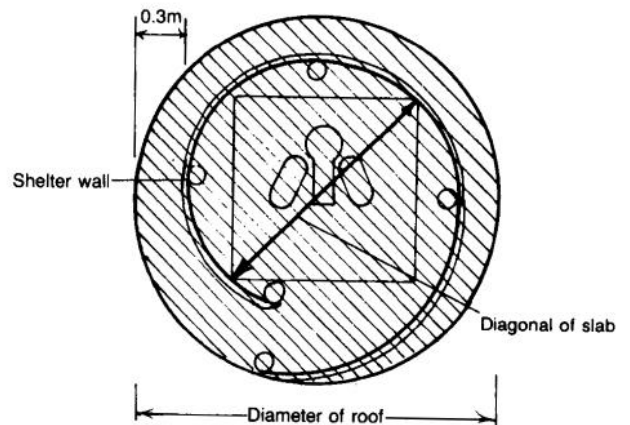
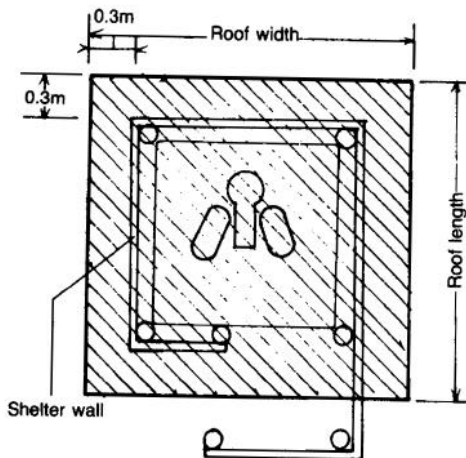

Figure 2. Privy Shelters with Roof

The shelter can be designed to rest on the base around the pit with the walls bordering the slab. With this design, the size of the slab determines the area within the shelter.

If the shelter is a simple screen with no roof, the bottom of the screen should touch the ground. The screen can be 1-2m high. If the shelter has a roof, the walls should be 1.8-2.1m high to allow enough headroom. The walls should rest on the ground.

Table 2 summarizes some requirements for a shelter.

**Special Features.** If the shelter has a roof, it should also have ventilation openings. The openings should be at least 100mm by 200mm and spaced along the top of the walls. One design has the entire roof raised above the walls on the corner posts, as shown in Figures 2 and 3.

**Table 2. Shelter Requirements**

Feature	Requirement
Walls	Vertical; touch ground
Wall Height (simple screen)	1-2m
Wall Height (with roof)	1.8-2.1m
Rear Wall	150-200mm from defecation hole
Roof	Sloped to rear or sides
Area in Shelter	1.0-2.3m <sup>2</sup>

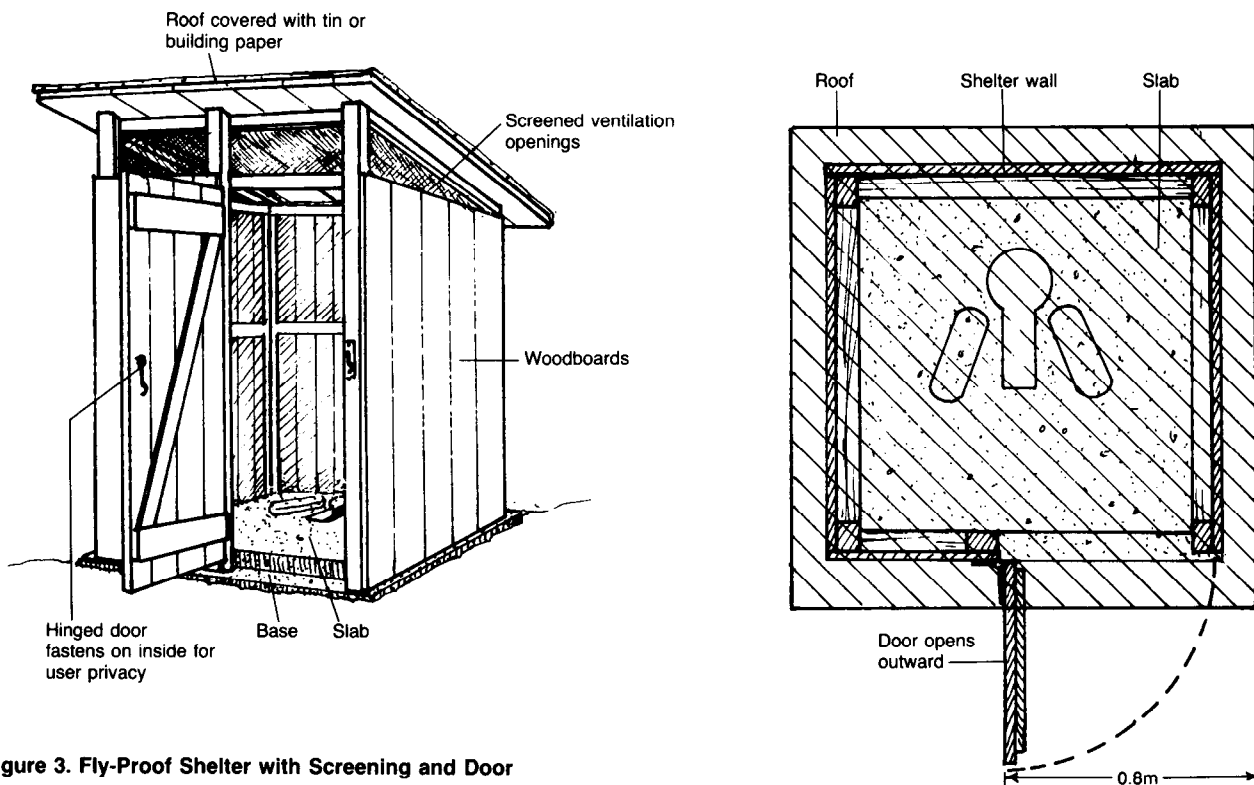

**Figure 3. Fly-Proof Shelter with Screening and Door**

If the shelter has a door, it must have sturdy hinges to keep the door in the correct position. An inside latch is needed to keep the door closed when the privy is in use. Figure 5 shows a well-designed privy door. The door may open from the right or left, but it should open outward unless this violates local custom. Ventilation openings are required. If pests are to

be kept out of the shelter, screens must cover all ventilation openings and the door must fit tightly, as shown in Figure 6.

If the shelter is for a ventilated privy, the vent pipe must be attached to an outside wall or to the roof, as shown in Figure 4.

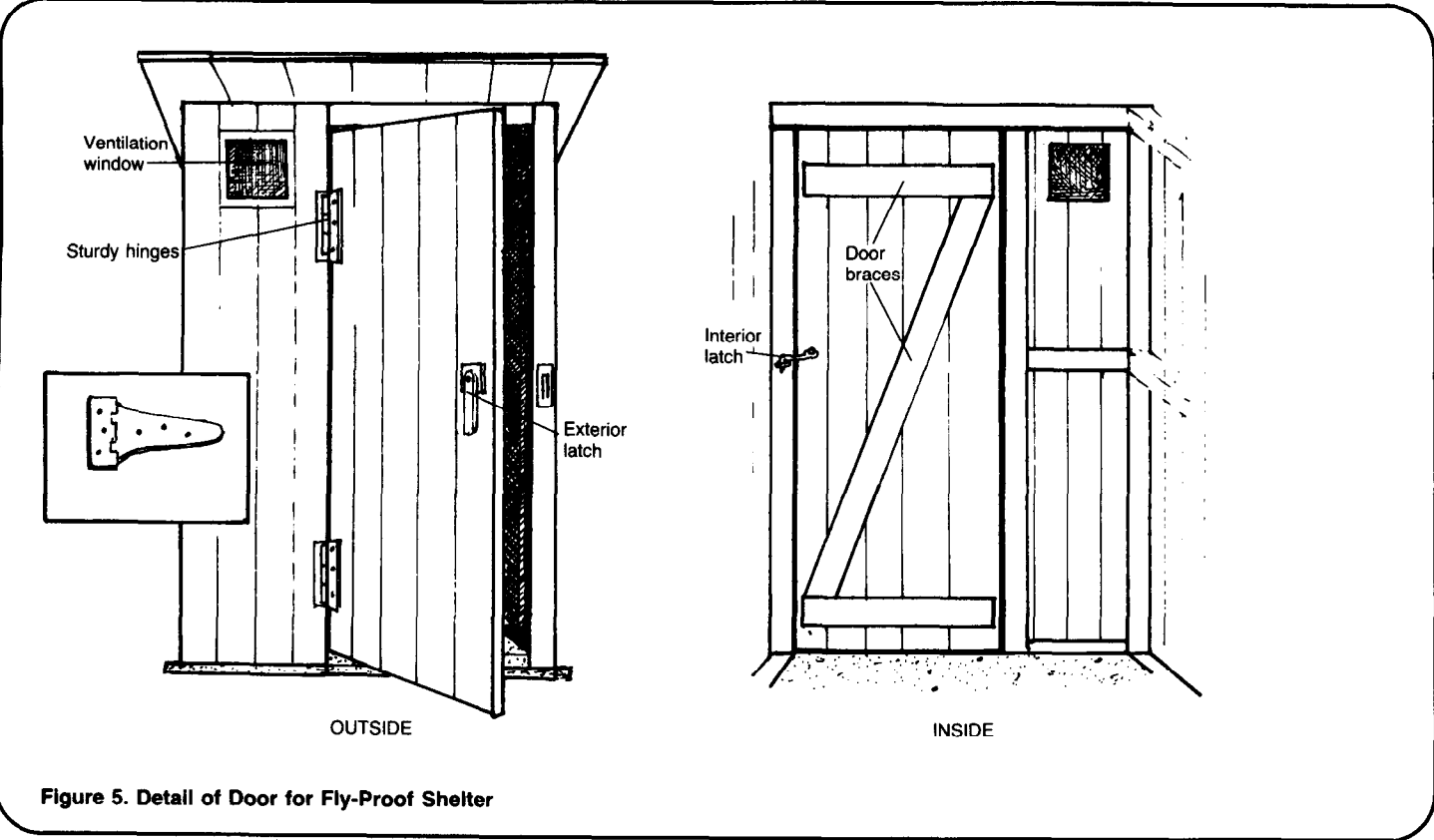
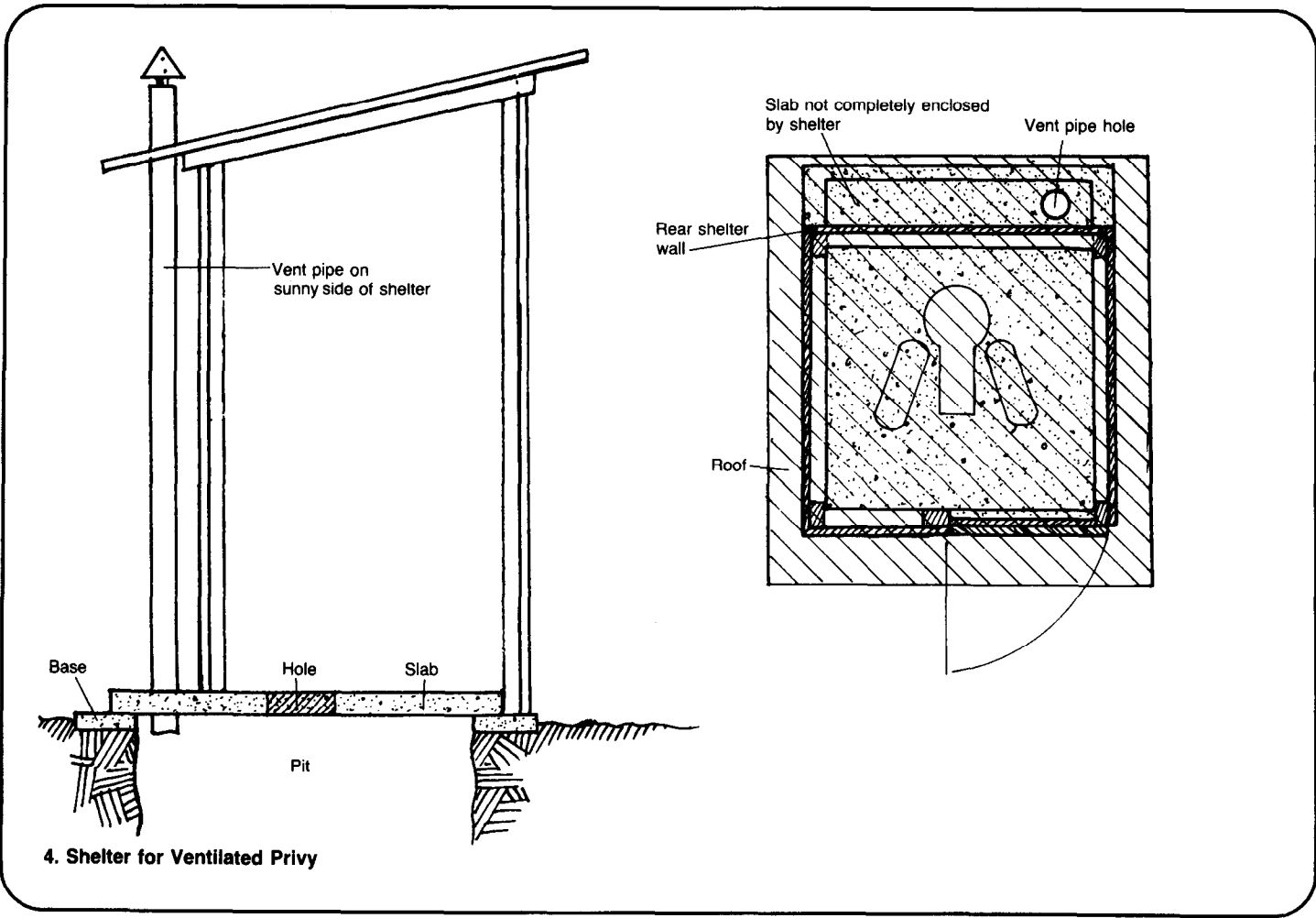

Figure 5. Detail of Door for Fly-Proof Shelter

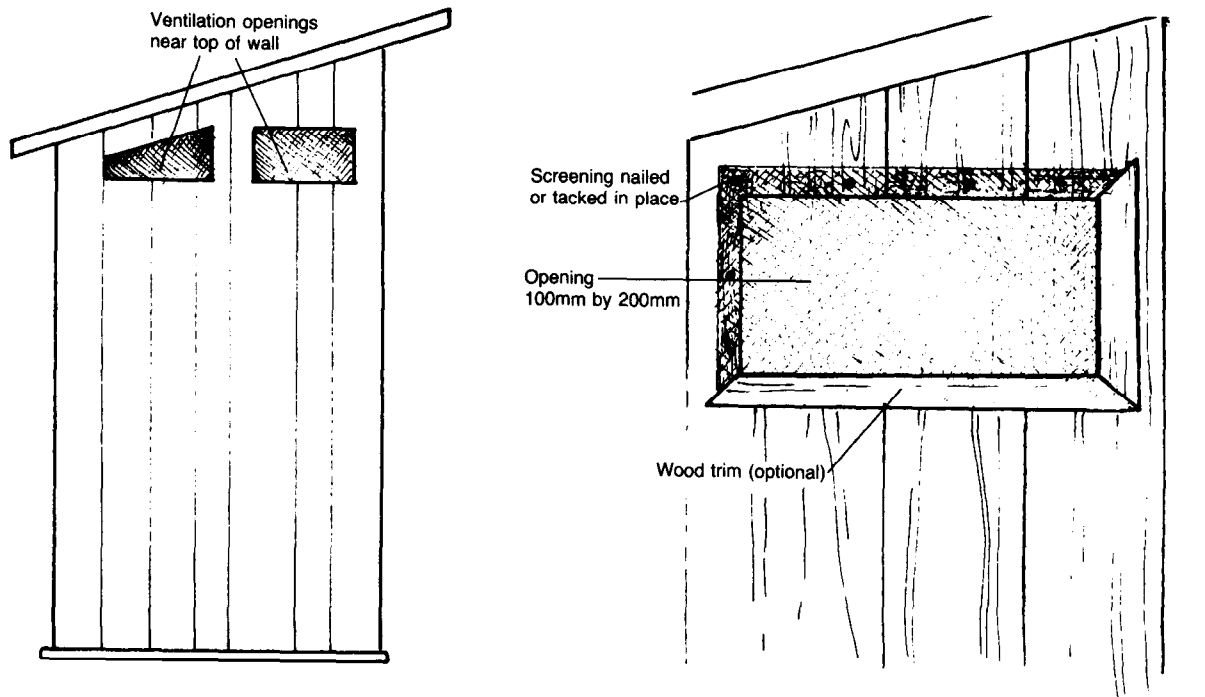

Figure 6. Fly-Proof Screening Covering Ventilation Openings

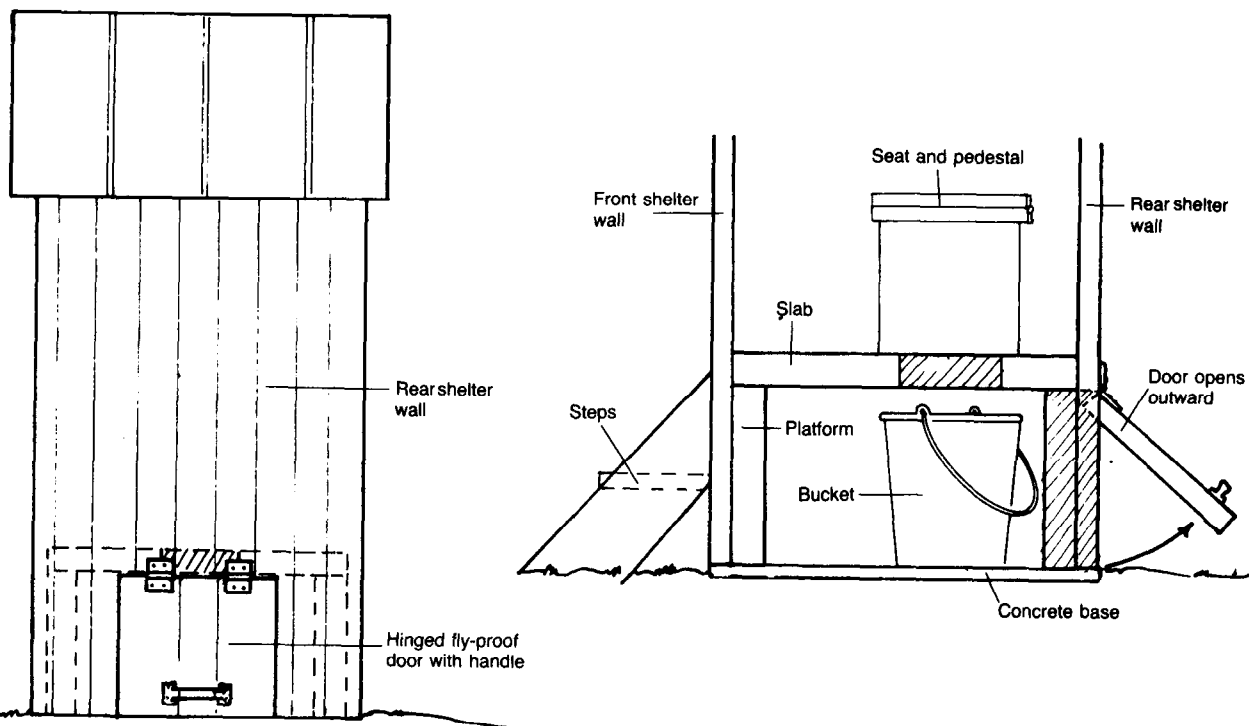

Figure 7. Detail of Shelter for Bucket Latrine

**Table 3. Special Feature Requirements**

Feature	Requirement
Ventilation Openings	At least 100 x 200mm; spaced along top of walls
Screens	Fly-proof; cover <u>all</u> openings
Door	Opens outward; sturdy hinges; inside latch
Vent Pipe	Attached to outside wall or roof
Privy Slab on Platform	Shelter rests on ground

**Table 4. Combinations of Materials for a Shelter**

Feature			
	Walls	Roof	Door
M a t e r i a l s	Mud and Wattle	Palm Thatch	Mud and Wattle, Palm Thatch, or Bamboo
	Bamboo	Palm Thatch	Mud and Wattle, Palm Thatch, or Bamboo
	Palm Thatch	Palm Thatch	Mud and Wattle, Palm Thatch, or Bamboo
	Wooden Boards	Wooden Boards or Corrugated Metal	Wooden Boards
	Brick and Mortar or Concrete Block and Mortar	Wooden Boards or Corrugated Metal	Wooden Boards

If the shelter is for a privy with a platform, such as an off-set pit, compost toilet, or bucket latrine, the walls should rest on the ground and enclose the platform. The height of the platform must be added to the height of the wall shown in Table 2. For a compost toilet or bucket latrine, the rear wall of the shelter must have a small door. It must be fly-proof for a bucket latrine and air-tight for a compost toilet. The door will allow for removal of the bucket or compost. This is shown in Figure 7.

Table 3 summarizes special feature requirements.

When the type of shelter, its shape, size, and special features have been decided, draw a plan view of the shelter showing all dimensions. Also prepare a detailed drawing of any special features. Give these drawings to the construction foreman before construction of the shelter begins.

### Selecting Materials

In general, a privy shelter should be built using locally available materials, tools, and labor. The sturdier the materials, the longer the life of the shelter.

A simple screen shelter can be bamboo, palm thatch, mud and wattle, or poles supporting canvas or fabric. A shelter with a roof, or roof and door, can be built from a variety of materials, some of which are shown in Table 4. The roof should be waterproof.

Depending on the area, termites may be a problem if wood structures are to be used. Special protection, such as a brick or concrete base, may be required to keep wood from coming into contact with the soil and giving termites access to the wood.

### Worksheet A. Calculating Quantities for a Privy Shelter

Shelter Type (check one):  simple screen     roof     roof and door

#### Simple Screen Shelter

1. Height of screen = 1.8 m
2. Length of sides = 0.3 m + 1.2 m + 1.2 m + 2.0 m + 1.2 m = 5.9 m
3. Quantity for screen = Line 1 x Line 2 = 1.8 m x 5.9 m = 10.6 m<sup>2</sup>  
\_\_\_\_\_
4. Distance around screen (for circular or spiral screen) = 6.1 m
5. Quantity for circular = Line 1 x Line 4 = 1.8 m x 6.1 m = 11.0 m<sup>2</sup>  
\_\_\_\_\_
6. Number of corner posts (or uprights) from drawing = 7
7. Minimum length of posts = Line 1 + 0.3m = 1.8 m + 0.3m = 2.1 m  
\_\_\_\_\_

#### Shelter with Roof

8. Width of shelter + 0.6m = 1.4 m + 0.6m = 2.0 m
9. Length of shelter + 0.6m = 1.5 m + 0.6m = 2.1 m
10. Quantity for roof = Line 8 x Line 10 = 2.0 m x 2.1 m = 4.2 m<sup>2</sup>  
\_\_\_\_\_
11. Diagonal of privy slab (measured in field) = 2.0 m
12. Diameter of circular roof = Line 11 + 0.9m = 2.0 m + 0.9m = 2.9 m
13. Quantity for circular roof =  $\frac{\text{Line 12}}{2} \times \frac{\text{Line 12}}{2} \times 3.1 = \frac{2.9}{2} \text{ m} \times \frac{2.9}{2} \text{ m} \times 3.1 = \frac{1.45}{2} \text{ m} \times \frac{1.45}{2} \text{ m} \times 3.1 = \frac{6.5}{2} \text{ m}^2$   
\_\_\_\_\_
14. Rear wall = height times width = 1.6 m x 1.4 m = 2.2 m<sup>2</sup>
15. Side wall = height times width = 1.8 m x 1.5 m = 2.7 m<sup>2</sup>
16. Side wall = height times width = 1.8 m x 1.5 m = 2.7 m<sup>2</sup>
17. Front wall = height times width = 2.0 m x 0.6 m = 1.2 m<sup>2</sup>
18. Screening wall = height times width = 2.0 m x 0.8 m = 1.6 m<sup>2</sup>
19. Screening wall = height times width = 2.0 m x 1.4 m = 2.8 m<sup>2</sup>
20. Quantity for shelter walls =  
Line 14 + Line 15 + Line 16 + Line 17 + Line 18 + Line 19 =  
2.2 m<sup>2</sup> + 2.7 m<sup>2</sup> + 2.7 m<sup>2</sup> + 1.2 m<sup>2</sup> + 1.6 m<sup>2</sup> + 2.8 m<sup>2</sup> = 13.2 m<sup>2</sup>  
\_\_\_\_\_

#### Shelter with Roof and Door

For roof and walls, use Lines 8 through 20.

21. Quantity for door = height times width 1.8 m x 0.9 m = 1.6 m<sup>2</sup>.



## Calculating Quantities of Materials

The quantities of materials needed depend on the type and size of the shelter. Most quantities are calculated in square meters and then converted to material units such as numbers of bricks, numbers of bamboo poles, and numbers and lengths of boards. Other quantities are determined by measurements made on plan view drawings.

Simple Screen Shelter. Materials include screening material and corner posts, or an upright post for a circular or spiral screen. Calculate the amount of screening material needed by adding the lengths of each section of the screen and multiplying the total by the height, as shown in Figure 1. For example, suppose the height of the screen is 1.8m and the lengths of the sections are 0.3m, 1.2m, 1.2m, 2.0m, and 1.2m. Then the quantity of screen needed is  $(0.3\text{m} + 1.2\text{m} + 1.2\text{m} + 2.0\text{m} + 1.2\text{m}) \times 1.8\text{m} = 5.9\text{m} \times 1.8\text{m} = 10.6\text{m}^2$ . See Worksheet A, Lines 1, 2 and 3. For a circular or spiral screen multiply the distance around the screen as shown in Figure 1, times the height. For example, if the distance around the screen is 6.1m and the height is 1.8m, the quantity of screen needed is  $6.1\text{m} \times 1.8\text{m} = 11.0\text{m}^2$ . See Worksheet A, Lines 4 and 5.

A corner post is needed at the end of each section of screen. Count the number of posts in the plan view. In the example above there are seven posts as shown in Figure 1. The post near the center of the longest section is for added stability. For circular or spiral screens, place upright posts 0.3-1.2m apart. Posts should be 0.3-0.6m longer than the height of the screen. This extra length will be driven or buried in the ground to hold the screen securely. In the example above, the length of the posts should be at least  $1.8\text{m} + 0.3\text{m} = 2.1\text{m}$ . See Worksheet A, Lines 6 and 7.

Shelter with Roof. Materials include roof and wall materials, corner posts or uprights, cross poles, rafters, and foundation.

Roof materials are calculated by multiplying the width of the shelter plus 0.6m times the length of the shelter plus 0.6m. For example, if the

shelter is 1.4m wide and 1.5m long, the quantity of materials is  $(1.4\text{m} + 0.6\text{m}) \times (1.5\text{m} + 0.6\text{m}) = 2.0\text{m} \times 2.1\text{m} = 4.2\text{m}^2$ . See Worksheet A, Lines 8, 9 and 10.

To calculate the quantity of materials for a circular roof, which may be desirable for a circular or spiral-shaped shelter, first obtain the diagonal dimension of the privy slab by measuring it, as shown in Figure 2. The diagonal plus 0.9m is the diameter of the roof. The quantity of materials equals the diameter divided by 2, multiplied by the diameter divided by 2, multiplied by 3.1. For example, suppose the diagonal of the privy slab is 2.0m. Then the diameter of the roof is  $2.0\text{m} + 0.9\text{m} = 2.9\text{m}$ . The quantity of materials is  $(\frac{2.9\text{m}}{2} \times \frac{2.9\text{m}}{2}) \times 3.1 = (1.45\text{m} \times 1.45\text{m}) \times 3.1 = 2.1\text{m}^2 \times 3.1 = 6.5\text{m}^2$ . See Worksheet A, Lines 11, 12 and 13.

Wall materials are calculated by adding together the area of each wall, including the screening wall, if there is one. The area of a wall is its height times its width. If the top of the wall is sloped, use the height in the middle. For a circular or spiral-shaped shelter, the area of the wall is calculated the same way as for a simple screen shelter. That is, the distance around the shelter is multiplied by the height. For example, suppose a shelter is to have a screening wall, and the roof and sidewalls slope from front to back as in Figure 2, and the wall dimensions are as follows:

rear wall	=	1.6m by 1.4m
side walls	=	1.8m by 1.5m and 1.8m by 1.5m
front wall	=	2.0m by 0.6m
screening walls	=	2.0m by 0.8m and 2.0m by 1.4m

Then the wall area and the quantity of materials needed =  $(1.6\text{m} \times 1.4\text{m}) + (1.8\text{m} \times 1.5\text{m}) + (1.8\text{m} \times 1.5\text{m}) + (2.0\text{m} \times 0.6\text{m}) + (2.0\text{m} \times 0.8\text{m}) + (2.0\text{m} \times 1.4\text{m}) = 2.2\text{m}^2 + 2.7\text{m}^2 + 2.7\text{m}^2 + 1.2\text{m}^2 + 1.6\text{m}^2 + 2.8\text{m}^2 = 13.2\text{m}^2$ . See Worksheet A, Lines 14-20.

The materials needed for cross poles, corner posts, rafters, and foundations, shown in Figures 8a and 8b are best calculated by drawing an accurate plan view and measuring lengths from the drawing. The length of each log, pole, or board used for the foundation equals

the width of the wall it supports. The length of each corner post or upright equals the height of the wall it supports. If the entire roof is to be raised above the walls for ventilation, add 0.15m to the length of each corner post or upright.

Shelter with Roof and Door. The materials needed for the roof are the same as those just discussed (see Worksheet A, Lines 8-20). Additional materials needed for the door are door braces, hinges, and latch.

Door materials are calculated by multiplying the height of the door times the width. For example, if the door is 1.8m high and 0.9m wide, the quantity of materials is  $1.8\text{m} \times 0.9\text{m} = 1.6\text{m}^2$ . See Worksheet A, Line 21.

The quantities of materials for the door braces are best obtained by drawing an accurate plan view similar

to Figure 3 and measuring lengths from the drawing. One inside latch and two hinges are needed.

### Materials List

The skills of the laborers and the tools needed depend on the materials used. For example, a wooden shelter requires a laborer with some carpentry skills and a hammer, saw, and nails. A brick-and-mortar shelter requires a laborer with some masonry skills and a shovel, mixing container, and trowel. When the materials, tools, and labor requirements have been determined, draw up a materials list similar to Table 5 and give it to the construction foreman.

In summary, give the construction foreman design drawings similar to Figures 1 through 8b, and a materials list similar to Table 5.

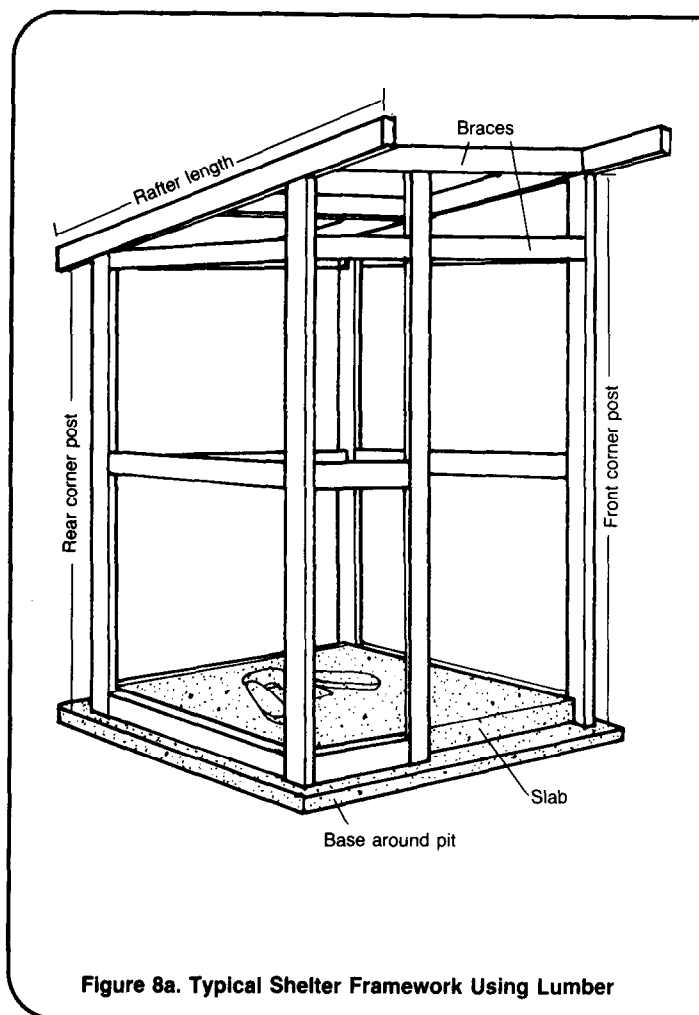

Figure 8a. Typical Shelter Framework Using Lumber

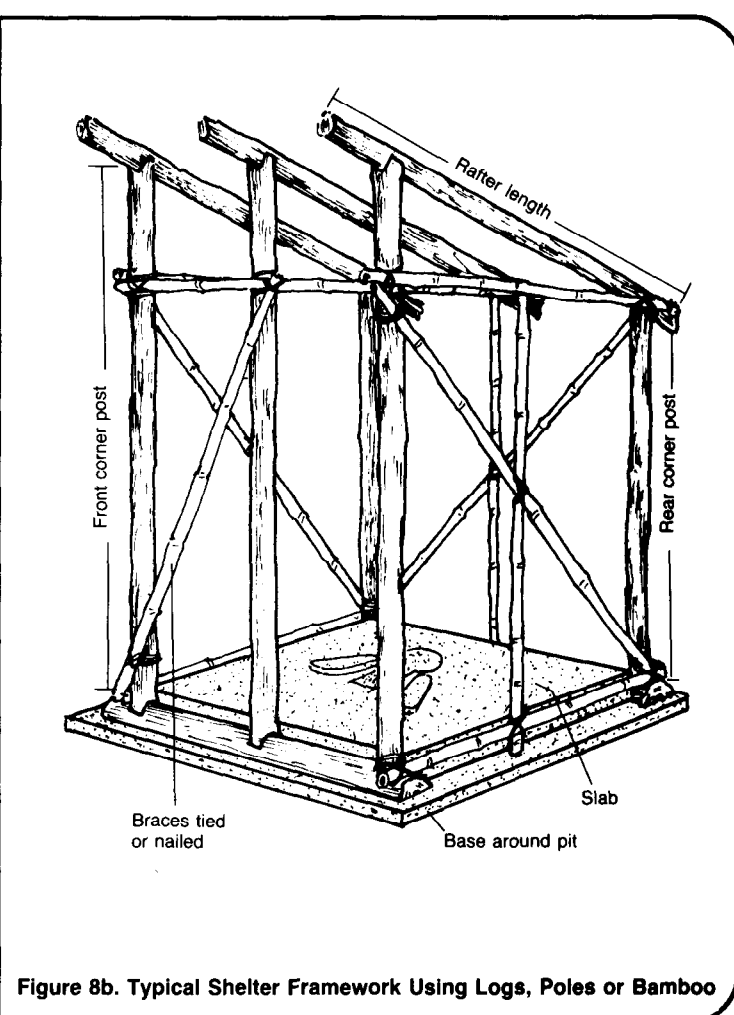

Figure 8b. Typical Shelter Framework Using Logs, Poles or Bamboo

**Table 5. Sample Materials List for Privy Shelter**

Item	Description	Quantity	Estimated Cost
Labor	Foreman	1	_____
	Laborer (carpentry skills)	1	_____
Supplies	Foundation: logs, 1.5m long, 100mm diam.	4	_____
	Corner posts: wood beams, 1.8m long, 50mm diam.	4	_____
	Walls: wood boards, various lengths, 25mm thick	13.2m <sup>2</sup>	_____
	Roof: Corrugated metal	4.2m <sup>2</sup>	_____
	Screens (flyproof) for ventilation openings, 150 x 250mm	12	_____
	Metal hinges	2	_____
	Latch	1	_____
	Nails	_____	_____
Other	_____	_____	
Tools	Measuring tape	1	_____
	Hammer	1	_____
	Saw	1	_____
	Carpenter's level or equivalent (not essential but very useful)	1	_____
	Carpenter's square or equivalent (not essential but very useful)	1	_____
	Other	_____	_____

Total Cost = \_\_\_\_\_

Do Not Use the Quantities in the Sample - Calculate Your Own