



# About Our Company

**QuinStar Technology, Inc.** is a millimeter-wave technology company. Founded in March 1993 by seasoned managers from major aerospace companies, QuinStar is dedicated to



the development, manufacture and marketing of millimeter-wave products serving established as well as emerging markets and system applications in the commercial, scientific and defense arenas. Our customers span the

world and our program experience includes Department of Defense research and development, high reliability space flight, and volume production of products fielded in leading edge broadband wireless communication networks.

QuinStar's products range from standard catalog components to specialized high-performance RF signal generating, amplifying and conditioning components to fully integrated and customized assemblies and subsystems for digital and analog sensor, communications and test applications.



QuinStar's primary goals are to deliver quality products and services to our customers while maintaining a pleasant work environment for our employees. We are committing our full resources, experiences and talents to achieving these simple yet most important goals.

## About This Catalog

The products offered in this catalog are standard and performance is not necessarily limited to the specifications presented. In addition, this catalog only presents a portion of our total product capability and offerings. Therefore, we encourage you to contact QuinStar to discuss your specific millimeter-wave product needs.

## Commitment to Quality

QuinStar Technology, Inc. is dedicated to providing the best service in the industry from initial inquiry all the way through

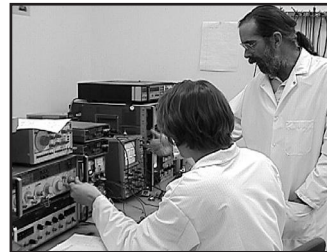

Limited Access Hi-Rel Assembly and Test Area

product delivery and after sales support. In addition, QuinStar strives to design and produce products that meet or exceed the performance specifications to which we have agreed upon and fully comply with all applicable quality standards. We are **ISO 9001:2000** certified in

2004 and our certification number is A2176US. Our quality standards address commercial through military and NASA Hi-Rel Space Flight requirements. As always, we stand behind our commitment to quality and on-time delivery.



Amplifier Manufacturing Area with QA Stations

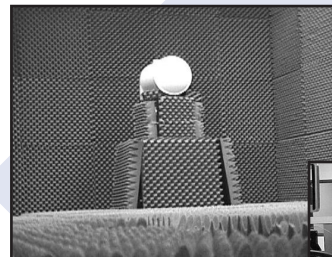

Antenna Range



Dual Microscope for Inspection and Training



## Our Vision:

To become the premier millimeter-wave technology company that provides innovative product solutions to the communications and sensor industries

## Our Mission:

To fulfill our customers' expectations of performance, delivery, value, quality, and service.

To employ superior technologies, responsive engineering, and efficient manufacturing.

To create highly rewarding careers for our employees in a stimulating and fun work environment.

## QuinStar Strategy and Legacy:

Throughout the years, QuinStar Technology grew its business by servicing the needs of customers in the millimeter-wave and microwave sensors and communication field. As a key growth strategy, QuinStar Technology also developed business by acquiring synergistic businesses to further broaden our products and services to better serve our customers.

We acquired DCL Inc. a small local electronic engineering firm in 1996.

In 1997, we acquired the complete assets of CERNEX Inc, a microwave amplifiers company in Sunnyvale, CA. We continued to operate in Sunnyvale as QuinStar Technology, Sunnyvale Division. In 2000, the facility was moved to our Torrance location to effect greater efficiency and responsiveness to our customers.

QuinStar acquired the manufacturing rights and all equipment and inventory of Silicon IMPATT diode product line from Raytheon in 1998. The technology was developed for Satellite communications in the mid 70s to 80s by Hughes

Aircraft Company and later acquired by Raytheon. This was the foundation of our IMPATT amplifier and oscillator business. We are the only commercial Silicon IMPATT diodes and components supplier in America today.

In 2002, we purchased all assets and the name of MPI / Millimeter Products, Inc., ([www.milpi.com](http://www.milpi.com)) a millimeter-wave components company in New Hampshire. The company was moved to our Torrance facility in 2003. This purchase expanded our waveguide and test components products similar to the TRG product line.

We expanded into the cryogenic amplifier business in 2004, with the acquisition of Berkshire Technologies, Inc. ([www.berkshiretech.com](http://www.berkshiretech.com)). This acquisition enables us to further support the scientific research customers.

With each acquisition, we increased our capabilities and broadened our areas of expertise. QuinStar continues to grow as a company of diverse abilities to meet the many needs of our customers.



## AMPLIFIER PRODUCTS 1

Microwave Broadband Low Noise Amplifiers	.....QLJ	9
Microwave Broadband General Purpose Amplifiers	.....QGJ	10
Microwave Broadband Power Amplifiers	.....QPJ	12
Millimeter Wave Full Waveguide Band Power Amplifiers	.....QPI	14
Millimeter Wave Broadband Amplifiers	.....QGW	15
Broadband Low Noise Millimeter Wave Amplifiers	.....QLW	17
Millimeter Wave Broadband Power Amplifiers	.....QPW	19
Millimeter Wave Low Noise Amplifiers	.....QLN	22
Millimeter Wave Narrowband Power Amplifiers	.....QPN	24
Millimeter Wave General Purpose Amplifiers	.....QGN	29
Outline Drawings	.....	31
Cryogenically Coolable Amplifiers and Systems	.....QCA	33
CW Injection-Locked Gunn Amplifiers	.....QTI	36
High Power CW IMPATT	.....QIC	37
High Power Pulse IMPATT Amplifiers	.....QIP	38

## RECEIVER PRODUCTS 2

Application Notes	.....	40
Broadband Detectors	.....QEA	41
Balanced Phase Detectors	.....QEP	43
Harmonic Mixers and Diplexers	.....QMH	45
Spectrum Analyzer Mixers and Diplexers	.....QMA	47
Single Ended Mixers	.....QMS	49
Balanced Mixers	.....QMB	51
Upconverters	.....QMU	53
Ultra Broadband Coaxial Mixers	.....QMC	55
Subharmonic Mixers	.....QHS	56
Active Mixers/Receivers	.....QAM	57
Coaxial Mixer	.....QCM	57
Image-reject and Single Sideband Mixers -Single Sideband Upconverters	.....QSM	58
I-Q Mixer	.....QMI	58
Bi-phase Modulator	.....QBP	58

## SOURCES AND FREQUENCY MULTIPLIERS 3

Application Notes	.....	60
Mechanically-Tunable Gunn Oscillators	.....QTM	62
Varactor-Tunable Gunn Oscillators	.....QTV	64
Gunn Regulators/Modulators	.....QCR	66
High Power IMPATT Oscillators	.....QIO	67
High Power IMPATT Diodes	.....QID	68
Stable Millimeter Wave Sources	.....QSO	70
Phase Locked Oscillators	.....QPL	71
Active Frequency Multipliers	.....QMM	72
Passive Frequency Multipliers	.....QPM	74
Noise Sources	.....QNS	76
Frequency Extenders	.....QBE	78

## CONTROL COMPONENTS AND FERRITE PRODUCTS 4

Glossary of Control Components Terminology	.....	80
Precision Junction Circulators and Isolators	.....QJY/QJI	82
Fullband Junction Circulators and Isolators	.....QJE/QJF	84
Fullband Isolators	.....QIF/QJM	86
Variable PIN Attenuators	.....QSA	88
PIN Switches	.....QSS/QSD/QSn	90
Coax PIN Switches	.....QSC	92

## WAVEGUIDE PRODUCTS AND FILTERS 5

Glossary of Waveguide Products & Filters	.....	94
Precision General Purpose Couplers	.....QJG	95
Precision High Directivity Couplers	.....QJR	97
Bidirectional and Dual-directional Waveguide Couplers	.....QBC	99
Broadband Waveguide Directional Coupler	.....QDC	101
Precision Crossguide Couplers	.....QJC	103
General Purpose Crossguide Couplers	.....QJX	105
Matched Hybrid Tees	.....QJH	107
Short Slot Hybrid Power Divider	.....QSP	109
Single and Triple Hybrid Ring Power Dividers	.....QHR	111
Multi-Output Power Dividers	.....QMD	112
Bandpass Filters	.....QFB	113
High Pass and Low Pass Filters	.....QFL/QFH	115
Notch Filter	.....QNF	117
E and H Plane Waveguide Tees	.....QUH	118
Waveguide Straight Sections, Terminations, Tapered Transitions	.....QWS/QWN/QWP	119
Custom Waveguide Assemblies	.....QAC	121
Medium and High Power Terminations	.....QTG/QTH	122
Waveguide Bends and Twists	.....QWB/QWT	124
Tunable Loads, Tunable Shorts, and E-H Tuners	.....QWG/QAT/QWU	125
Flanges, Bulkhead Waveguide Adapter, Hardware	.....QBA/QFA/QFF	126
Precision Drill Jig, Flange Pins, Screws, Waveguide Stands QPD,QFS,QDJ	.....QDP/QFS/QDJ	127
Pressurizing Unit	.....QPU	129
Waveguide to Coax Adapters	.....QWA	130

## TEST EQUIPMENT AND INSTRUMENTATION PRODUCTS 6

Manual Waveguide Switches	.....QWM	132
Electromechanical Waveguide Switches	.....QWZ	133
Micrometer type Level Set Attenuators and Variable Phase Shifters, Fixed Attenuators	.....QAF/QAL/QAS	135
Dial type Level Set Attenuators and Variable Phase Shifters	.....QDA/QDP	137
Direct Reading Attenuators, Frequency Meters, and Phase Shifters	.....QAD/QEF/QPS	139
Motorized, Programmable Attenuator	.....QPA	142
Motorized, Programmable Phase Shifter	.....QMP	144

## ANTENNA PRODUCTS 7

APPLICATION NOTES	.....	148
Standard Gain Horn Antennas	.....QWH	152
Custom Feed Horn Antennas	.....QRR	155
Narrow and Wide Beam Scalar Feed Horn	.....QSH/QSW	157
Sectoral Horn Antennas	.....QSF	158
Omni-directional Antennas	.....QOD	159
Lens Antennas	.....QLA	160
Cassegrain Reflector Antennas	.....QRC	162
Orthomode Transducers	.....QWO	164
Linear and Circular Fixed and Switchable Polarizers	.....QWL/QWQ	166
Circular-to-Rectangular Waveguide Transitions	.....QWC	168
Mode Transition TE01 to TE10	.....QMT	169
Mode Filter	.....QMF	171
Circular Waveguide (TE11) Section	.....QCF	172
Circular Waveguide Termination	.....QTC	174
TE01 Circular Waveguide Sections and Flanges	.....QCL/QCF	175
Rotary Joints	.....QRJ	177
Antenna Development Capability and Measurement Facility	.....	178

## ASSEMBLIES AND SUBSYSTEMS 8

Cryogenically Coolable Products & Capability	.....	182
Assemblies & Subsystem Experience	.....	183
Block Diagrams & Architectures for Assemblies	.....	185

## SYSTEM PRODUCTS CAPABILITY 9

## APPENDICES AND REFERENCES



# Alphabetic Model Numbers

Model	Description	Page
QAC	Custom Waveguide Assemblies .....	121
QAD	Direct Reading Attenuators, Frequency Meters, and Phase Shifters .....	139
QAF	Fixed Attenuator.....	135
QAL	Micrometer type Level Set Attenuators .....	135
QAM	Active Mixers/Receivers.....	57
QAS	Variable Phase Shifter.....	135
QAT	Tunable Shorts .....	125
QBA	Bulkhead Waveguide Adapter .....	126
QBC	Bidirectional and Dual-directional Waveguide Couplers .....	99
QBE	Frequency Extenders .....	78
QBP	Bi-phase Modulator .....	58
QCA	Cryogenically Coolable Amplifiers .....	33
QCF	TE01 Circular Waveguide Flanges .....	175
QCL	TE01 Circular Waveguide Sections .....	175
QCM	Coaxial Mixer .....	57
QCR	Gunn Regulators/Modulators .....	66
QCW	Circular Waveguide (TE11) Section .....	172
QDA	Dial type Level Set Attenuators .....	137
QDC	Broadband Waveguide Directional Coupler .....	101
QDJ	Precision Drill Jig .....	127
QDP	Dial type Variable Phase Shifters .....	137
QDP	Dowel Pins .....	127
QEA	Broadband Detectors.....	41
QEF	Direct Reading Frequency Meters .....	139
QEP	Balanced Phase Detectors.....	43
QFA	Flange Adapter.....	126
QFB	Bandpass Filters .....	113
QFF	Flanges .....	126
QFH	High Pass Filter.....	115
QFL	Low Pass Filters .....	115
QFS	Waveguide Flange Screws .....	127
QGJ	Microwave Broadband General Purpose Amplifiers .....	10
QGN	Millimeter Wave General Purpose Amplifiers .....	29
QGW	Millimeter Wave Broadband Amplifiers.....	15
QHR	Single and Triple Hybrid Ring Power Dividers .....	115
QHS	Subharmonic Mixers .....	56
QHT	H Plane Waveguide Tee.....	118
QIC	High Power CW IMPATT.....	37
QID	High Power IMPATT Diodes .....	68
QIF	Fullband Isolators .....	86
QIO	High Power IMPATT Oscillators .....	67
QIP	High Power Pulse IMPATT Amplifiers.....	38
QJC	Precision Crossguide Couplers.....	103
QJE	Fullband Junction Circulators .....	84
QJF	Fullband Junction Isolators .....	84
QJG	Precision General Purpose Couplers .....	95
QJH	Matched Hybrid Tees .....	107
QJI	Precision Junction Isolators .....	82
QJR	Precision High Directivity Couplers.....	97
QJX	General Purpose Crossguide Couplers .....	105
QJY	Precision Junction Circulators .....	82
QLA	Lens Antennas .....	160
QLJ	Microwave Broadband Low Noise Amplifiers.....	9
QLN	Millimeter Wave Low Noise Amplifiers.....	22
QLW	Broadband Low Noise Millimeter Wave Amplifiers .....	17
QMA	Spectrum Analyzer Mixers and Diplexers .....	47
QMB	Balanced Mixers .....	51

Model	Description	Page
QMC	Ultra Broadband Coaxial Mixers.....	55
QMD	Multi-Output Power Dividers .....	112
QMF	Mode Filter .....	171
QMH	Harmonic Mixers and Diplexers.....	45
QMI	I-Q Mixer .....	58
QMM	Active Frequency Multipliers .....	72
QMP	Motorized, Programmable Phase Shifter .....	144
QMS	Single Ended Mixers .....	49
QMT	Mode Transition TE01 to TE10.....	169
QMU	Upconverters .....	53
QNF	Notch Filter .....	117
QNS	Noise Sources .....	76
QOD	Omn-directional Antennas .....	159
QPA	Motorized, Programmable Attenuator .....	142
QPI	Millimeter Wave Full Waveguide Band Power Amplifiers .....	14
QPJ	Microwave Broadband Power Amplifiers .....	12
QPL	Phase Locked Oscillators .....	71
QPM	Passive Frequency Multipliers .....	74
QPN	Millimeter Wave Narrowband Power Amplifiers.....	24
QPR	Direct Reading Phase Shifter.....	139
QPW	Millimeter wave Broadband Power Amplifiers.....	19
QRC	Cassegrain Reflector Antennas .....	162
QRJ	Rotary Joints .....	177
QRR	Custom Feed Horn Antennas .....	155
QSA	Variable PIN Attenuators .....	88
QSC	Coax PIN Switches .....	92
QSD	PIN Switches, Single Pole Double Throw (SPDT) .....	90
QSF	Sectoral Horn Antennas .....	158
QSH	Narrow Beam Scalar Feed Horn .....	157
QSM	Image-reject and Single Sideband Mixers -Single Sideband Upconverters .....	58
QSn	PIN Switches (Multi-throw).....	90
QSP	Short Slot Hybrid Power Divider .....	109
QSS	PIN Switches, Single Pole Single Throw (SPST).....	90
QSW	Wide Beam Scalar Feed Horn.....	157
QTC	Circular Waveguide Termination.....	174
QTE	E Plane Waveguide Tees .....	118
QTG	Medium Power Terminations .....	122
QTH	High Power Terminations .....	122
QTI	CW Injection-Locked Gunn Amplifiers .....	36
QTM	Mechanically-Tunable Gunn Oscillators .....	62
QTV	Varactor-Tunable Gunn Oscillators .....	64
QWA	Waveguide to Coax Adapters .....	130
QWB	Waveguide Bends .....	124
QWC	Circular-to-Rectangular Waveguide Transitions .....	168
QWG	Tunable Loads.....	125
QWH	Standard Gain Horn Antennas.....	152
QWL	Linear and Circular Fixed Polarizers .....	166
QWM	Manual Waveguide Switches .....	132
QWN	Waveguide terminations.....	119
QWO	Orthomode Transducers .....	164
QWP	Waveguide Tapered Transitions .....	119
QWQ	Linear and Circular Switchable Polarizer.....	166
QWS	Waveguide Straight Sections .....	119
QWT	Waveguide Twists.....	124
QWU	E-H Tuners .....	125
QWZ	Electromechanical Waveguide Switches .....	133



# Alphabetic Product Names

Product	Page
Active Frequency Multipliers	72
Active Mixers/Receivers	57
Balanced Mixers	51
Balanced Phase Detectors	43
Bandpass Filters	113
Bidirectional and Dual-directional Waveguide Couplers	99
Bi-phase Modulator	58
Broadband Detectors	41
Broadband Low Noise Millimeter Wave Amplifiers	17
Broadband Waveguide Directional Coupler	101
Bulkhead Waveguide Adapter	126
Cassegrain Reflector Antennas	162
Circular Waveguide (TE11) Section	172
Circular Waveguide Termination	174
Circular-to-Rectangular Waveguide Transitions	168
Coax PIN Switches	92
Coaxial Mixer	57
Cryogenically Coolable Amplifiers	33
Custom Feed Horn Antennas	155
Custom Waveguide Assemblies	121
CW Injection-Locked Gunn Amplifiers	36
Dial type Level Set Attenuators	137
Dial type Variable Phase Shifters	137
Direct Reading Attenuators	139
Direct Reading Frequency Meters	139
Direct Reading Phase Shifter	139
Dowel Pins	127
E Plane Waveguide Tees	118
E-H Tuners	125
Electromechanical Waveguide Switches	133
Fixed Attenuator	135
Flange Adapter	126
Flanges	126
Frequency Extenders	78
Fullband Isolators	86
Fullband Junction Circulators	84
Fullband Junction Isolators	84
General Purpose Crossguide Couplers	105
Gunn Regulators/Modulators	66
H Plane Waveguide Tee	118
Harmonic Mixers and Diplexers	45
High Pass Filter	115
High Power CW IMPATT	37
High Power IMPATT Diodes	68
High Power IMPATT Oscillators	67
High Power Pulse IMPATT Amplifiers	38
High Power Terminations	122
Image -reject and Single Sideband Mixers/Upconverters	58
I-Q Mixer	58
Lens Antennas	160
Linear and Circular Fixed Polarizers	166
Linear and Circular Switchable Polarizer	166
Low Pass Filters	115
Manual Waveguide Switches	132
Matched Hybrid Tees	107
Mechanically-Tunable Gunn Oscillators	62
Medium Power Terminations	122

Product	Page
Micrometer type Level Set Attenuators and Variable Phase Shifters, Fixed Attenuators	135
Microwave Broadband General Purpose Amplifiers	10
Microwave Broadband Low Noise Amplifiers	9
Microwave Broadband Power Amplifiers	11
Millimeter wave Broadband Power Amplifiers	19
Millimeter Wave Broadband Amplifiers	15
Millimeter Wave Full Waveguide Band Power Amplifiers	14
Millimeter Wave General Purpose Amplifiers	29
Millimeter Wave Low Noise Amplifiers	22
Millimeter Wave Narrowband Power Amplifiers	24
Mode Filter	171
Mode Transition TE01 to TE10	169
Motorized, Programmable Attenuator	142
Motorized, Programmable Phase Shifter	144
Multi-Output Power Dividers	112
Multiplier, Active	72
Narrow Beam Scalar Feed Horn	157
Noise Sources	76
Notch Filter	117
Omni-directional Antennas	158
Orthomode Transducers	164
Passive Frequency Multipliers	74
Phase Locked Oscillators	71
PIN Switches (Multi-throw)	90
PIN Switches, Single Pole Double Throw (SPDT)	90
PIN Switches, Single Pole Single Throw (SPST)	90
Precision Drill Jig	127
Precision Crossguide Couplers	103
Precision General Purpose Couplers	95
Precision High Directivity Couplers	97
Precision Junction Circulators	82
Precision Junction Isolators	82
Rotary Joints	177
Sectoral Horn Antennas	158
Short Slot Hybrid Power Divider	109
Single and Triple Hybrid Ring Power Dividers	111
Single Ended Mixers	49
Spectrum Analyzer Mixers and Diplexers	47
Standard Gain Horn Antennas	152
Subharmonic Mixers	56
TE01 Circular Waveguide Flanges	175
TE01 Circular Waveguide Sections and Flanges	175
Tunable Loads	125
Tunable Shorts	125
Ultra Broadband Coaxial Mixers	55
Upconverters	53
Varactor-Tunable Gunn Oscillators	64
Variable Phase Shifter	135
Variable PIN Attenuators	88
Waveguide Bends	124
Waveguide Flange Screws	127
Waveguide Straight Sections	119
Waveguide Tapered Transitions	119
Waveguide terminations	119
Waveguide to Coax Adapters	130
Waveguide Twists	124
Wide Beam Scalar Feed Horn	157



# Directions to QuinStar Technology

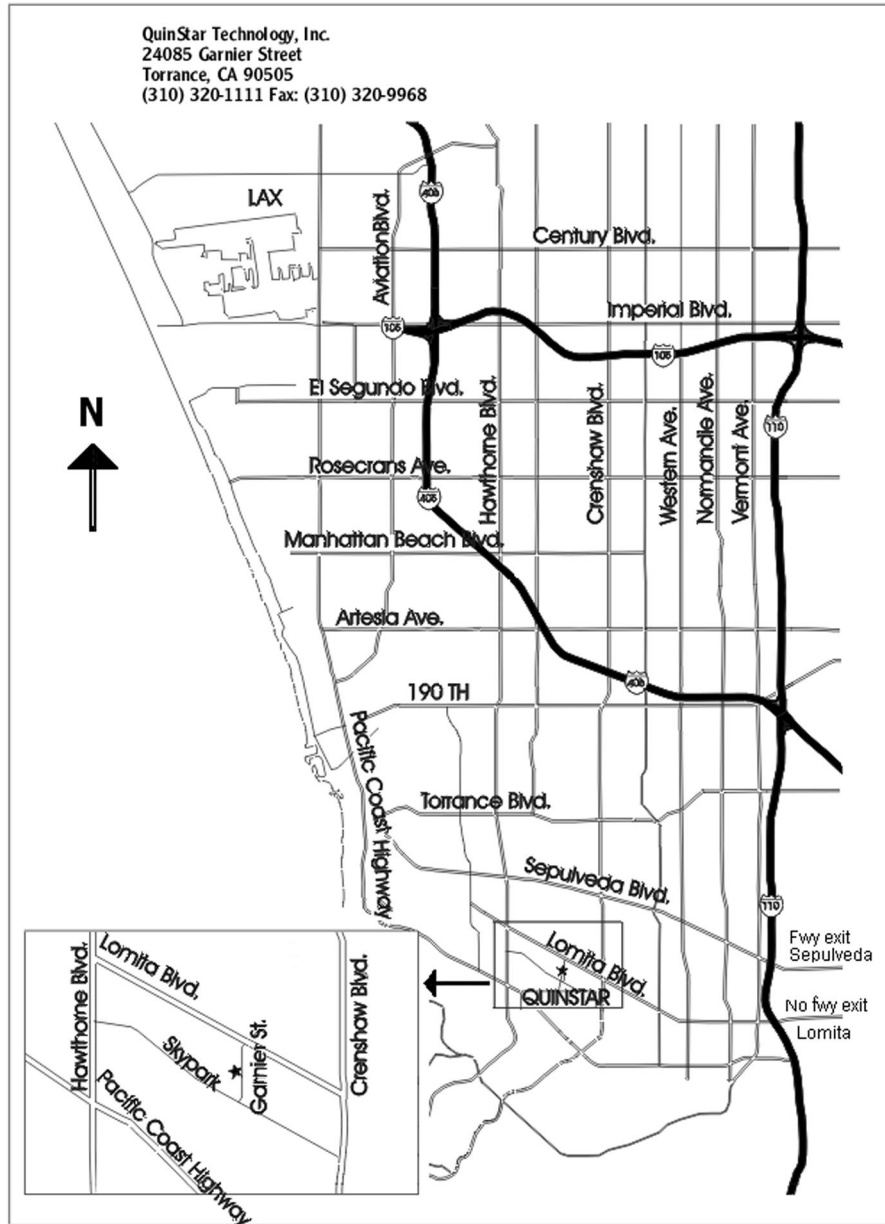

Directions from Los Angeles Airport (LAX) and Points North: Take 405 South toward Long Beach. Exit on Hawthorne Blvd exit. Stay in the right lane and turn right onto Hawthorne Blvd (southbound). Go approx. 5.5 miles, turn left on Lomita Blvd., go 0.5 mile, turn right on Garnier Street. QuinStar is on your right 1/2 block down.

Directions from San Diego and Points South: Take 405 North toward Santa Monica. Exit on Crenshaw Blvd, and head south toward Torrance. Go 4.5 miles, and turn right on Lomita Blvd. Go 0.5 mile, and turn left on Garnier Street. QuinStar is on your right 1/2 block down.



# Section 1

# Amplifier Products

Product Title	Model No.	Page Number
<b>Amplifier Products</b>		7
Glossary of Terminology for Amplifiers		8
Microwave Broadband Low Noise Amplifiers	<b>QLJ</b>	9
Microwave Broadband General Purpose Amplifiers	<b>QGJ</b>	10
Microwave Broadband Power Amplifiers	<b>QPJ</b>	12
Millimeter Wave Full Waveguide Band Power Amplifiers	<b>QPI</b>	14
Millimeter Wave Broadband Amplifiers	<b>QGW</b>	15
Broadband Low Noise Millimeter Wave Amplifiers	<b>QLW</b>	17
Millimeter wave Broadband Power Amplifiers	<b>QPW</b>	19
Millimeter Wave Low Noise Amplifiers	<b>QLN</b>	22
Millimeter Wave Narrowband Power Amplifiers	<b>QPN</b>	24
Millimeter Wave General Purpose Amplifiers	<b>QGN</b>	29
Outline Drawings		31
Cryogenic Amplifiers and Systems	<b>QCA</b>	33
CW Injection-Locked Gunn Amplifiers	<b>QTI</b>	36
High Power CW IMPATT	<b>QIC</b>	37
High Power Pulse IMPATT Amplifiers	<b>QIP</b>	38

# Glossary of Terminology for Amplifiers

**1 dB gain compression point (P1dB)** defines the output level at which the amplifier's gain is 1 dB less than the small signal gain, or is compressed by 1 dB.

**Conditionally stable** amplifier refers to an amplifier that may oscillate under particular load or source impedance (VSWR) conditions, an undesirable situation.

**Dynamic range** is the power range over which an amplifier provides useful linear operation, with the lower limit dependent on the noise figure and the upper level determined by the 1 dB compression point.

**Gain flatness** indicates the variation of an amplifier's gain characteristic over the full frequency response range at a given temperature expressed in dB.

**Gain (forward gain, G)** for RF amplifiers is the ratio of output power to input power, specified in the small signal, linear gain region, with a signal applied at the input. Gain in dB is defined as,  $G \text{ (dB)} = 10 \log_{10} G \text{ (numeric)}$ .

**Harmonic distortion** is produced by nonlinear amplifier operation and appears in the form of output signal frequencies at integral multiples of the input signal frequency. Since harmonic distortion is influenced by input power level it is generally specified in terms of the relative level for the harmonics to the fundamental signal power.

**Linearity** of an amplifier signifies its output power is a linear function of the input power. A linear amplifier produces at its output an amplified replica of the input signal with negligible compression and minimal or no harmonic generation.

**Maximum signal level** refers to the largest CW or pulse RF signal that can be safely applied to an amplifier's input. Exceeding the specified limit can result in noise figure degradation, increased distortion, gain reduction, and/or amplifier burnout.

**Noise factor** is the ratio of signal-to-noise power ratio at an amplifier's input to the signal-to-noise power ratio at the output. Noise figure NF in dB is related to noise factor F by

$$NF \text{ (in dB)} = 10 \log_{10} F$$

**Return loss (RL)** is the ratio of reflected power to incident power at the RF port of an amplifier, expressed in dB

$$RL = -20 \log |R|, \text{ where } R = \text{reflection coefficient.}$$

**Stability** of an amplifier is an indication of its tendency to oscillate or generate a signal at its output without an applied input.

**Two-Tone Third-order intercept point** Two-tone third-order intercept point is a measure of third-order products generated by a second signal arriving at the input of a device such as an amplifier. If F1 and F2 are the frequencies of the two signals arriving at the input, the amplifier generates intermod products at its output due to inherent nonlinearity, in the form  $\pm m \cdot F1 \pm n \cdot F2$  where m and n are positive integers which can assume any value from 1 to infinity. The order of the intermod is defined as m + n. Hence  $2 \cdot F1 - F2$ ,  $2 \cdot F2 - F1$ ,  $3 \cdot F1$  and  $3 \cdot F2$  are third-order products by definition. The first two products are called two-tone third-order products as they are generated when two tones are applied simultaneously at the input and the latter two are called single-tone third-order products.

For example, if 100 and 101 MHz are the frequencies of two applied signals, then 99 and 102 MHz are the two-tone third-order products and 300 and 303 MHz are single-tone third-order products. Two-tone third-order products are very close to the desired signals and are very difficult to filter out. Hence they are of great importance in system design. In the linear region, third-order products decrease/increase by 3 dB for every 1 dB decrease/increase of input power, and output signal power decreases/increases by a dB for every dB of input power. When drawn on a X-Y graph, with input power on X-axis and output power on the Y-axis, third-order products fall on a straight line with a slope of 3 and signal power on a straight line with a slope 1 as shown below. By extending the linear portions the two lines, they intercept at a point. The X co-ordinate and the Y co-ordinate of this point are called the input and output intercept point, and the two differ by an amount equal to the small-signal gain of the amplifier. Output intercept point, IP3(dBm) can also be calculated using a simple formula.

$$IP3(dBm)_{out} = P_{out}(dBm) + A/2$$

where  $P_{out}$  (dBm) is the output power of each tone in dBm and "A" is the difference of output power and intermod level in dB. Input intercept point is obtained by substituting  $P_{in}(dBm)$  for  $P_{out}(dBm)$  in the above formula. Single-tone and two-tone third-order intercept points differ by a fixed amount but have the same slope.

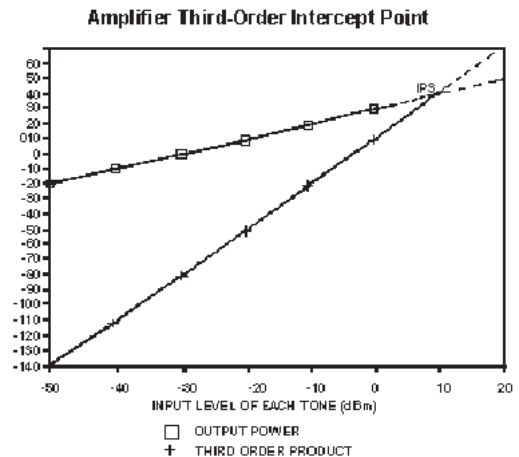

**Unconditionally stable** refers to an amplifier that will not oscillate regardless of load or source impedance.

**VSWR** (voltage standing wave ratio) is related to return loss (RL) by the following:

$$VSWR = \frac{1 + 10^{-RL/20}}{1 - 10^{-RL/20}}$$



# Microwave Broadband Low Noise Amplifiers

QLJ

## Characteristics

- ◆ Offered over 0.5-18 GHz
- ◆ Broad Bandwidth Operation
- ◆ State-of-the-art Low Noise Performance
- ◆ Compact Package

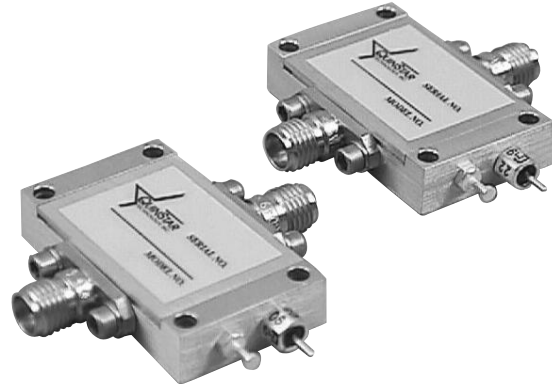

## Product Description

QuinStar Technology's series QLJ low noise microwave amplifiers utilize advanced MMICs and discrete devices

for state-of-the-art low noise performance in the 0.5-18 GHz frequency range.

## Specifications

Model Number	Frequency Range (GHz)	Noise Figure (dB)	Gain (dB)	Gain Flatness (±dB)	Current (mA) max., at 12V	Outline (pages 31-32)
QLJ-06184010-XX	6-18 GHz	4.0	10	1.75	60	H1, J
QLJ-06184020-XX	6-18 GHz	4.0	20	2.0	120	H2, J
QLJ-06184030-XX	6-18 GHz	4.0	30	2.2	180	H3, J
QLJ-06184040-XX	6-18 GHz	4.0	40	2.2	240	H4, J
QLJ-00124016-XX	.5-12 GHz	4.0	16	1.75	200	J,E
QLJ-00124026-XX	.5-12 GHz	4.0	26	2.0	300	J
QLJ-00124036-XX	.5-12 GHz	4.0	36	2.3	400	J
QLJ-02084010-XX	2-8 GHz	4.0	10	1.5	100	J,E
QLJ-02084020-XX	2-8 GHz	4.0	20	1.75	160	J,E
QLJ-02084030-XX	2-8 GHz	4.0	30	2.0	220	J
QLJ-02084040-XX	2-8 GHz	4.0	40	2.3	300	J
QLJ-02061514-XX	2-6 GHz	1.5	14	1.75	100	J
QLJ-02061527XX	2-6 GHz	1.5	27	2.0	160	J
QLJ-02061537-XX	2-6 GHz	1.5	37	2.3	220	J
QLJ-00021818-XX	.5-2 GHz	1.8	18	1.75	80	J,E
QLJ-00021832-XX	.5-2 GHz	1.8	32	2.0	150	J
QLJ-00021845-XX	.5-2 GHz	1.8	45	2.3	210	J
QLJ-00184514-XX	.5-18 GHz	4.5	14	1.5	200	E,J
QLJ-00184528-XX	.5-18 GHz	4.5	28	2.2	400	J

## Ordering Information

Model Number **QLJ - ABCD EF GH - IJ**

frequency range, minimum-maximum, in GHz (use 00 for minimum freq. below 1 GHz)

noise figure, in tenth of dB (EF = 40 for noise figure = 4.0 dB)

outline designation (see pages 31-32)

gain, in dB



# Microwave Broadband General Purpose Amplifiers

QGJ

## Characteristics

- ◆ Offered over 0.5-18 GHz
- ◆ Wide range of Gain Options
- ◆ Compact Package

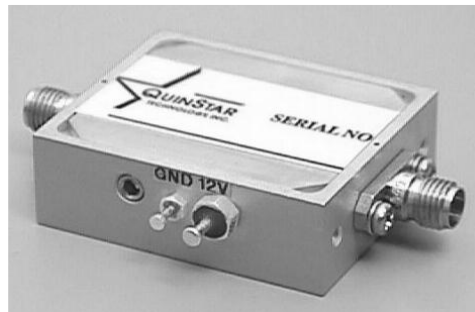

## Product Description

QuinStar Technology's series QGJ broadband high gain general purpose amplifiers are ideally suited for a very wideband amplification. The amplifiers are offered with

nominal gains in 10-50 dB range, and nominal output 1 dB compression point power (P-1 dB) in 13-20 dBm range.

## Specifications

Model Number	Frequency Range (GHz)	P1dB (dBm)	Gain (dB)	Gain Flatness (±dB)	Current (mA) max., at 12V	Outline (pages 31-32)
QGJ-06181310-XX	6-18 GHz	13	10	1.8	100	H1, J
QGJ-06181320-XX	6-18 GHz	13	20	1.9	180	H2, J
QGJ-06181330-XX	6-18 GHz	13	30	2.0	240	H3, J
QGJ-06181340-XX	6-18 GHz	13	40	2.2	300	H4, J
QGJ-06181710-XX	6-18 GHz	17	10	1.8	100	H1, J
QGJ-06181720-XX	6-18 GHz	17	20	1.9	180	H2, J
QGJ-06181730-XX	6-18 GHz	17	30	2.0	240	H3, J
QGJ-06181740-XX	6-18 GHz	17	40	2.2	300	H4, J
QGJ-06182017-XX	6-18 GHz	20	17	2.5	250	J
QGJ-06182027-XX	6-18 GHz	20	27	2.6	330	J
QGJ-06182037-XX	6-18 GHz	20	37	2.7	410	J
QGJ-06182047-XX	6-18 GHz	20	47	2.8	500	J
QGJ-00121314-XX	.5-12 GHz	13	14	1.8	200	J,E
QGJ-00121324-XX	.5-12 GHz	13	24	2.0	280	J
QGJ-00121334-XX	.5-12 GHz	13	34	2.5	340	J
QGJ-00121713-XX	.5-12 GHz	17	13	1.8	200	J
QGJ-00121723-XX	.5-12 GHz	17	23	2.0	300	J
QGJ-00121733-XX	.5-12 GHz	17	33	2.3	400	J
QGJ-00121743-XX	.5-12 GHz	17	43	2.5	500	J
QGJ-00122013-XX	.5-12 GHz	20	13	1.8	250	J
QGJ-00122023-XX	.5-12 GHz	20	23	2.0	350	J
QGJ-00122033-XX	.5-12 GHz	20	33	2.3	450	J
QGJ-00122043-XX	.5-12 GHz	20	43	2.5	500	J
QGJ-02081310-XX	2-8 GHz	13	10	1.8	100	J
QGJ-02081320-XX	2-8 GHz	13	20	2.0	160	J
QGJ-02081330-XX	2-8 GHz	13	30	2.2	220	J
QGJ-02081340-XX	2-8 GHz	13	40	2.5	300	J



# Microwave Broadband General Purpose Amplifiers

QGJ

Amplifier Products

## Specifications

Model Number	Frequency Range (GHz)	P1dB (dBm)	Gain (dB)	Gain Flatness (±dB)	Current (mA) max., at 12V	Outline (pages 31-32)
QGJ-02081710-XX	2-8 GHz	17	10	1.8	100	J
QGJ-02081720-XX	2-8 GHz	17	20	2.0	160	J
QGJ-02081730-XX	2-8 GHz	17	30	2.2	220	J
QGJ-02081740-XX	2-8 GHz	17	40	2.4	300	J
QGJ-02061310-XX	2-6 GHz	13	10	1.8	100	J
QGJ-02061320-XX	2-6 GHz	13	20	2.0	160	J
QGJ-02061330-XX	2-6 GHz	13	30	2.3	220	J
QGJ-02061340-XX	2-6 GHz	13	40	2.5	300	J
QGJ-02061710-XX	2-6 GHz	17	10	1.8	100	J
QGJ-02061720-XX	2-6 GHz	17	20	2.0	160	J
QGJ-02061730-XX	2-6 GHz	17	30	2.3	220	J
QGJ-02061740-XX	2-6 GHz	17	40	2.5	300	J
QGJ-02062018-XX	2-6 GHz	20	18	1.8	500	J
QGJ-02062028-XX	2-6 GHz	20	28	2.0	580	J
QGJ-02062038-XX	2-6 GHz	20	38	2.3	660	J
QGJ-02062048-XX	2-6 GHz	20	48	2.5	740	J
QGJ-00021312-XX	.5-2 GHz	13	12	1.0	100	J
QGJ-00021324-XX	.5-2 GHz	13	24	1.3	170	J
QGJ-00021336-XX	.5-2 GHz	13	36	1.5	210	J
QGJ-00021612-XX	.5-2 GHz	16	12	1.0	100	J
QGJ-00021624-XX	.5-2 GHz	16	24	1.3	170	J
QGJ-00021636-XX	.5-2 GHz	16	36	1.5	210	J
QGJ-00022013-XX	.5-2 GHz	20	13	1.5	150	J
QGJ-00022025-XX	.5-2 GHz	20	25	1.8	200	J
QGJ-00022037-XX	.5-2 GHz	20	37	2.0	270	J
QGJ-00022049-XX	.5-2 GHz	20	49	2.3	350	J

## Ordering Information

Model Number **QGJ - ABCD EF GH - IJ**

frequency range, minimum-maximum, in GHz (use 00 for minimum freq. below 1 GHz)

P1dB (Power at 1dB Gain Compression Point) in dBm

outline designation (see pages 31-32)

gain, in dB



# Microwave Broadband Power Amplifiers

QPJ

## Characteristics

- ◆ Offered over 1-18 GHz
- ◆ Wide Range of Gains & Output Power Options
- ◆ Compact Package

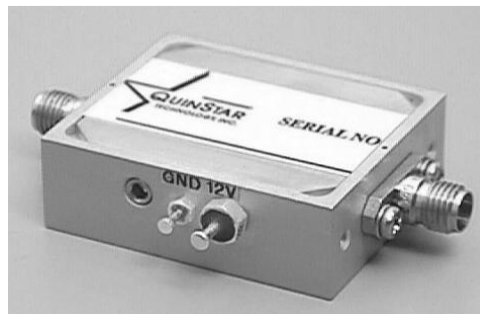

## Product Description

QuinStar Technology's series QPJ power amplifiers utilize advanced MMICs and discrete devices for state-of-the-art power performance in the 2-18 GHz frequency range. A wide range of gain values is offered for significantly high

power output levels. These amplifiers offer gain in the 18-48 dB range, with output power from 24-38 dBm available. The baseline amplifier is provided with coaxial input/output ports.

## Specifications

Model Number	Frequency Range (GHz)	Power (dBm)	Gain (dB)	Gain Flatness (±dB)	Voltage (V)	Current (A) max.	Outline (pages 31-32)
QPJ-06182310-XX	6-18	23	10	2.0	12	0.6	J
QPJ-06182320-XX	6-18	23	20	2.3	12	0.65	J
QPJ-06182330-XX	6-18	23	30	2.5	12	0.7	J
QPJ-06182340-XX	6-18	23	40	2.8	12	0.75	J
QPJ-06182720-XX	6-18	27	20	3.0	12	0.9	J
QPJ-06182730-XX	6-18	27	30	3.3	12	0.95	J
QPJ-06182740-XX	6-18	27	40	3.5	12	1	J
QPJ-06183020-XX	6-18	30	20	3.0	12	1.3	A
QPJ-06183030-XX	6-18	30	30	3.3	12	1.4	A
QPJ-06183040-XX	6-18	30	40	3.5	12	1.5	A
QPJ-06183320-XX	6-18	33	20	3.0	12	3	A
QPJ-06183330-XX	6-18	33	30	3.3	12	3.1	A
QPJ-06183340-XX	6-18	33	40	3.5	12	3.2	A
QPJ-06183620-XX	6-18	36	20	3.0	12	6	A
QPJ-06183630-XX	6-18	36	30	3.3	12	6.1	A
QPJ-06183640-XX	6-18	36	40	3.5	12	6.2	A
QPJ-06183818-XX	6-18	38	18	3.0	10	12	B
QPJ-06183828-XX	6-18	38	28	3.3	10	12.2	B
QPJ-06183838-XX	6-18	38	38	3.5	10	12.3	B
QPJ-06183848-XX	6-18	38	48	3.8	10	12.4	B
QPJ-06184016-XX	6-18	40	16	3.0	10	20	*
QPJ-06184026-XX	6-18	40	26	3.3	10	22	*
QPJ-06184036-XX	6-18	40	36	3.5	10	23	*
QPJ-06184046-XX	6-18	40	46	3.8	10	25	*
QPJ-02082310-XX	2-8	23	10	2.0	12	0.5	J
QPJ-02082320-XX	2-8	23	20	2.1	12	0.6	A
QPJ-02082710-XX	2-8	27	10	2.0	15	0.8	A



### Specifications

Model Number	Frequency Range (GHz)	Power (dBm)	Gain (dB)	Gain Flatness (±dB)	Voltage (V)	Current (A) max.	Outline (pages 31-32)
QPJ-02062318-XX	2-6	23	18	2.0	12	0.5	J
QPJ-02062328-XX	2-6	23	28	2.1	12	0.58	J
QPJ-02062338-XX	2-6	23	38	2.2	12	0.66	J
QPJ-02062348-XX	2-6	23	48	2.3	12	0.74	J
QPJ-02062718-XX	2-6	27	18	2.0	12	0.6	J
QPJ-02062728-XX	2-6	27	28	2.1	12	0.68	J
QPJ-02062738-XX	2-6	27	38	2.2	12	0.76	J
QPJ-02062748-XX	2-6	27	48	2.3	12	0.84	J
QPJ-02063017-XX	2-6	30	17	2.0	12	1	J
QPJ-02063027-XX	2-6	30	27	2.1	12	1.1	J
QPJ-02063037-XX	2-6	30	37	2.2	12	1.2	J
QPJ-02063047-XX	2-6	30	47	2.3	12	1.3	J
QPJ-02063317-XX	2-6	33	17	2.0	12	2	A
QPJ-02063327-XX	2-6	33	27	2.1	12	2.4	A
QPJ-02063337-XX	2-6	33	37	2.2	12	2.5	A
QPJ-02063347-XX	2-6	33	47	2.3	12	2.6	A
QPJ-02063615-XX	2-6	36	15	2.1	12	4	B
QPJ-02063625-XX	2-6	36	25	2.3	12	4.8	B
QPJ-02063635-XX	2-6	36	35	2.4	12	5	B
QPJ-02063645-XX	2-6	36	45	2.5	12	5.2	B
QPJ-02063815-XX	2-6	38	15	2.1	12	8	*
QPJ-02063825-XX	2-6	38	25	2.3	12	9.6	*
QPJ-02063835-XX	2-6	38	35	2.5	12	10	*
QPJ-02063845-XX	2-6	38	45	2.8	12	10.5	*

\*Custom outline.

### Ordering Information

Model Number **QPJ - ABCD EF GH - IJ**

frequency range, minimum-maximum, in GHz (use 00 for minimum freq. below 1 GHz)

P1dB (Power at 1dB Gain Compression Point) in dBm

outline designation (see pages 31-32)

gain, in dB



# Millimeter-Wave Full Waveguide Band Power Amplifiers

**QPI**

## Characteristics

- ◆ Power Output to 35 dBm
- ◆ Gain Options from 10 to 40 dB
- ◆ Frequency 26.5-40 GHz & 18-26.5 GHz

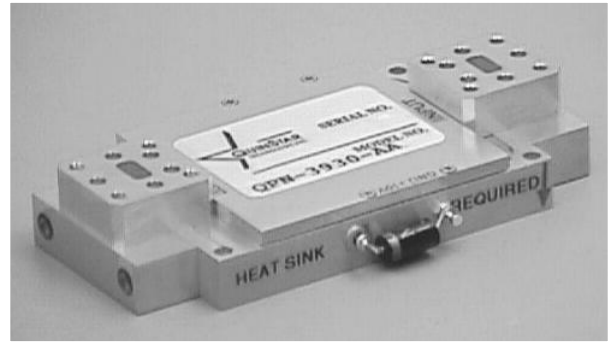

## Product Description

QuinStar Technology's series QPI power amplifiers provide state-of-the-art high power performance in the 18-26.5 GHz and 26.5-40-GHz frequency range. The standard amplifier products are offered with either a coaxial connector or

WR-42 (K-band) and WR-28 (Ka-band) waveguide ports. However, any combination of these interfaces is available as an option. Integral waveguide isolators are also available for improved input and output matches.

## Specifications

Model Number	P-1 dB (dBm)	Gain (dB)	Gain Flatness (±dB)	Voltage (V)	Current max. (A)	Outline (pages 31-32)
QPI-K02325-XX	23	25	1.8	12	0.6	J,G
QPI-K02340-XX	23	40	2.0	12	0.7	J,G
QPI-K02725-XX	27	25	1.8	12	1.1	J,G
QPI-K02740-XX	27	40	2.0	12	1.2	J,G
QPI-K03025-XX	30	25	2.0	12	1.8	A,R
QPI-K03040-XX	30	40	2.3	12	1.9	A,R
QPI-K03325-XX	33	25	2.0	12	3.4A	A,R
QPI-K03340-XX	33	40	2.3	12	3.5A	A,R
QPI-K03525-XX	35	25	2.0	12	6.8A	B,K
QPI-K03540-XX	35	40	2.3	12	7A	B,K
QPI-K03730-XX	37	30	2.3	10	13.5	*
QPI-K03740-XX	37	40	2.5	10	14.0	*
QPI-KA2325-XX	23	25	2	10	1.6	A,R
QPI-KA2333-XX	23	33	2	10	1.8	A,R

\*Custom outline.

## Ordering Information

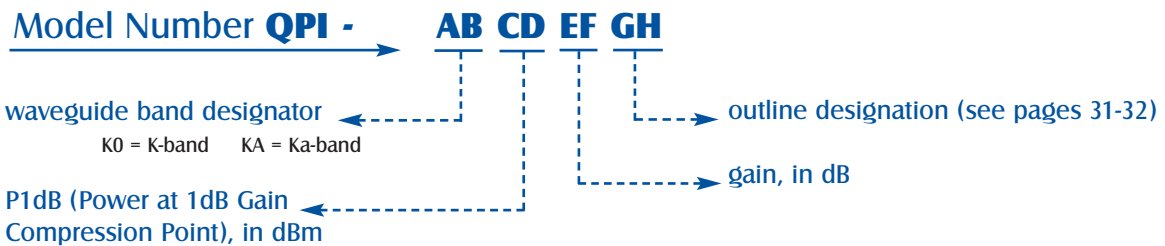



# Millimeter-Wave Broadband Amplifiers

QGW

## Characteristics

- ◆ Offered Over 18-66 GHz
- ◆ Broadband Performance
- ◆ Wide range of power and Gain options
- ◆ Choices of packages and interfaces

## Product Description

QuinStar Technology's series QGW broadband general purpose, high gain-amplifiers are ideally suited for power amplification over a wide bandwidth with gain and output power to suit virtually any application in the 18 to 66 GHz region. The amplifiers are offered with gains ranging from 10 to 50 dB, and nominal output power of 13 to 20 dBm, across the entire operating frequency band.

The standard amplifier housing offers a wide range and combinations of input and output coaxial connectors or

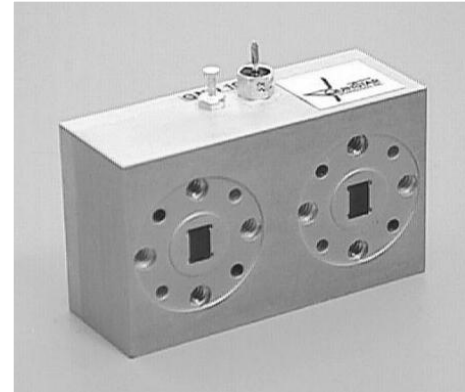

waveguide ports. For 18 to 40 GHz amplifiers, we offer 2.9 mm coaxial connectors, and 2.4 mm for 40-50 GHz and 1.9 mm connector for frequencies beyond. Appropriate waveguide input and/or output ports are offered for the entire range from 18 to 66 GHz. Any valid combination of coaxial and waveguide input and output ports can be supplied, if desired. Integral waveguide isolators are also available for improved input and output matches. QuinStar also offers other families of amplifiers in the 18-100 GHz range.

## Specifications

Model Number	Frequency Range (GHz)	P1dB (dBm)	Gain (dB)	Gain Flatness (±dB)	Current (mA max.) at 12V	Outline (pages 31-32)
QGW-18261315-XX	18-26.5 GHz	13	15	1.8	130	G,J
QGW-18261325-XX	18-26.5 GHz	13	25	2.0	190	G,J
QGW-18261335-XX	18-26.5 GHz	13	35	2.3	260	G,J
QGW-18261345-XX	18-26.5 GHz	13	45	2.5	330	G,J
QGW-18262015-XX	18-26.5 GHz	20	15	1.8	500	J,G
QGW-18262030-XX	18-26.5 GHz	20	30	2.0	600	J,G
QGW-18262040-XX	18-26.5 GHz	20	40	2.3	650	J,G
QGW-18262050-XX	18-26.5 GHz	20	50	2.5	750	J,G
QGW-18401415-XX	18-40 GHz	14	15	2.7	180	E,J
QGW-18401423-XX	18-40 GHz	14	23	2.8	230	E,J
QGW-18401431-XX	18-40 GHz	14	31	2.9	280	J
QGW-18401439-XX	18-40 GHz	14	39	3.0	330	J
QGW-18402015-XX	18-40 GHz	20	15	2.7	800	J
QGW-18402023-XX	18-40 GHz	20	23	2.8	850	J
QGW-18402031-XX	18-40 GHz	20	31	2.9	900	J
QGW-18402039-XX	18-40 GHz	20	39	3.0	950	J
QGW-37451418-XX	37-45 GHz	14	18	2.5	400	J,G
QGW-37451428-XX	37-45 GHz	14	28	2.7	550	J,G
QGW-37451438-XX	37-45 GHz	14	38	2.8	700	J,G
QGW-37451448-XX	37-45 GHz	14	48	3.0	850	J,G
QGW-37451718-XX	37-45 GHz	17	18	2.5	650	J,G





# Millimeter-Wave Broadband Amplifiers

QGW

## Specifications

Model Number	Frequency Range (GHz)	P1dB (dBm)	Gain (dB)	Gain Flatness (±dB)	Current (mA max.) at 12V	Outline (pages 31-32)
QGW-37451728-XX	37-45 GHz	17	28	2.7	800	J,G
QGW-37451738-XX	37-45 GHz	17	38	2.8	950	J,G
QGW-37451748-XX	37-45 GHz	17	48	3.0	1100	J,G
QGW-38481418-XX	38-48 GHz	14	18	2.5	400	J,G
QGW-38481428-XX	38-48 GHz	14	28	2.7	550	J,G
QGW-38481438-XX	38-48 GHz	14	38	2.8	700	J,G
QGW-38481448-XX	38-48 GHz	14	48	3.0	850	J,G
QGW-38481718-XX	38-48 GHz	17	18	2.5	650	J,G
QGW-38481728-XX	38-48 GHz	17	28	2.7	800	J,G
QGW-38481738-XX	38-48 GHz	17	38	2.8	950	J,G
QGW-38481748-XX	38-48 GHz	17	48	3.0	1100	J,G
QGW-33501316-XX	33-50 GHz	13*	16	2.5	300	J,G
QGW-33501327-XX	33-50 GHz	13*	27	2.8	440	J,G
QGW-33501337-XX	33-50 GHz	13*	37	3.0	570	J,G
QGW-33501347-XX	33-50 GHz	13*	47	3.2	700	J,G
QGW-50661310-XX	50-66 GHz	13*	10	2.0	250	P,I
QGW-50661320-XX	50-66 GHz	13*	20	2.3	400	P,I
QGW-50661330-XX	50-66 GHz	13*	30	2.5	550	P,I

\*Saturated Power Output Level

## Ordering Information

Model Number **QGW - ABCD EF GH - IJ**

frequency range, minimum-maximum, in GHz

P1dB (Power at 1dB Gain Compression Point) in dBm

outline designation (see pages 31-32)

gain, in dB



# Millimeter-Wave Broadband Low Noise Amplifiers

QLW

## Characteristics

- ◆ Offered over 6-98 GHz
- ◆ State-of-the-art Noise Performance
- ◆ Low Power Consumption

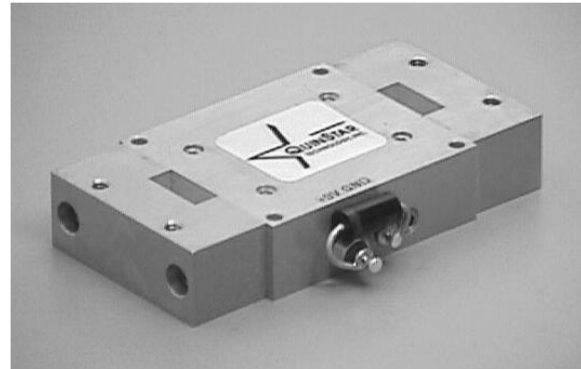

## Product Description

QuinStar Technology's series QLW low noise amplifiers utilize advanced MMICs and discrete devices for state-of-the-art noise performance in the 6-98 GHz frequency range. The majority of these amplifiers offer greater than a standard waveguide bandwidth, and use appropriate coaxial or waveguide interfaces. The standard amplifier housing offers a wide range and combinations of input and output coaxial connectors or waveguide ports. For 18

to 40 GHz amplifiers, we offer 2.9 mm coaxial connectors, and 2.4 mm for 40-50 GHz and 1.9 mm connector for frequencies beyond. Any valid combination of coaxial and waveguide input and output ports can be supplied, if desired. These low noise amplifiers are useful in EW systems, test equipment, and instrumentation systems where low system noise figure is very important.

## Specifications

Model Number	Frequency Range (GHz)	Noise Figure (dB)	Gain (dB)	Gain Flatness (±dB)	Current (mA) max. at 12V	Outline (pages 31-32)
QLW-06404513-XX	6-40	4.5t	13	3.25	150	J,E
QLW-06404527-XX	6-40	4.5t	27	3.5	300	J,E
QLW-11273715-XX	11-27	3.7	15	1.5	120	J,E
QLW-11273732-XX	11-27	3.7	32	1.75	220	J,E
QLW-11273748-XX	11-27	3.7	48	2.0	300	J
QLW-15262820-XX	15-26	2.8	20	2.75	100	J,E
QLW-15262840XX	15-26	2.8	40	3.0	180	J
QLW-15262855-XX	15-26	2.8	55	3.25	300	J
QLW-20333515-XX	20-33	3.5	15	1.75	100	J,E
QLW-20333530-XX	20-33	3.5	30	2.5	180	J,E
QLW-20333545-XX	20-33	3.5	45	2.75	250	J
QLW-18404515-XX	18-40	4.5	15	2.25	120	J,E
QLW-18404522-XX	18-40	4.5	22	2.5	180	J
QLW-18404530-XX	18-40	4.5	30	2.75	220	J
QLW-18404537-XX	18-40	4.5	37	2.85	300	J
QLW-24403520-XX	24-40	3.5	20	3.5	100	J,E,G
QLW-24403528-XX	24-40	3.5	28	3.5	180	J,E,G
QLW-24403536-XX	24-40	3.5	36	3.5	250	J,G
QLW-24403542-XX	24-40	3.5	42	3.5	250	J,G
QLW-36464815-XX	36-46	4.8	15	2.25	100	J,G,E
QLW-36464826-XX	36-46	4.8	26	2.5	180	J,G,E
QLW-36464835-XX	36-46	4.8	35	2.5	250	J,G



# Millimeter-Wave Broadband Low Noise Amplifiers

QLW

## Specifications

Model Number	Frequency Range (GHz)	Noise Figure (dB)	Gain (dB)	Gain Flatness (±dB)	Current (mA) max. at 12V	Outline (pages 31-32)
QLW-40505520-XX	40-50	5.5	20	3.0	80	J,G
QLW-40505530-XX	40-50	5.5	30	3.25	220	J,G
QLW-40505540-XX	40-50	5.5	40	3.5	350	J,G
QLW-48575016-XX	48-57	5	16	3.0	200	G
QLW-48575025-XX	48-57	5	25	3.25	300	G
QLW-48575035-XX	48-57	5	35	3.5	450	G
QLW-50754515-XX	50-75	4.5	15	3.0	100	P,I
QLW-50754530-XX	50-75	4.5	30	3.5	200	P,I
QLW-92986014-XX	92-98	6	14	3.0	60	P,I
QLW-92986028-XX	92-98	6	28	3.5	150	P,I

## Ordering Information

Model Number **QLW - ABCD EF GH - IJ**

frequency range, minimum-maximum frequencies, in GHz

Noise Figure, in tenths of dB  
(example: EF = 45 for Noise Figure = 4.5 dB)

outline designation (see pages 31-32)

gain, in dB



# Millimeter-Wave Broadband Power Amplifiers

QPW

## Characteristics

- ◆ Broad Bandwidth of Operation
- ◆ State-Of-The-Art Power Performance
- ◆ Available from 18-95 GHz

## Product Description

QuinStar Technology's series QPW power amplifiers utilize advanced MMICs and discrete devices for state-of-the-art power performance in the 18-95 GHz frequency range. The standard amplifier housing offers a wide range and combinations of input and output coaxial connectors or waveguide ports. For 18 to 40 GHz amplifiers, we offer 2.9 mm coaxial connectors, and 2.4 mm for 40-50 GHz and 1.9 mm connectors for frequencies beyond. Appropriate

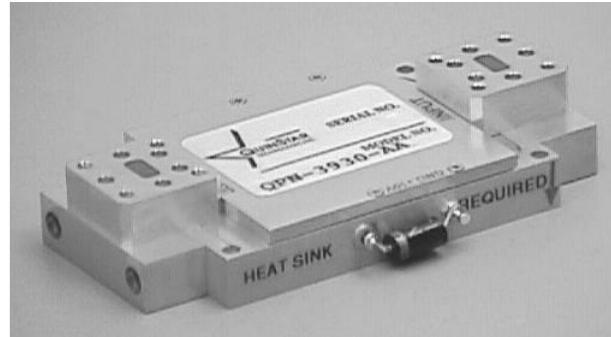

waveguide input and/or output ports are offered for the entire range from 18 to 95 GHz. Any valid combination of coaxial and waveguide input and output ports can be supplied, if desired. In addition to the standard products, QuinStar can produce customized amplifiers to specific requirements. Integral waveguide isolators are also available for improved input and output matches.

## Specifications

Model Number	Frequency Range (GHz)	P1dB (dBm)	Gain (dB)	Gain Flatness (±dB)	Current (A) max. at 12V	Outline (pages 31-32)
QPW-18282325-XX	18-28 GHz	23	25	1.8	0.6	J
QPW-18282340-XX	18-28 GHz	23	40	2.0	0.7	J
QPW-18282710-XX	18-28 GHz	27	10	1.5	0.8	J
QPW-18282725-XX	18-28 GHz	27	25	1.8	1.1	J
QPW-18282740-XX	18-28 GHz	27	40	2.0	1.2	J
QPW-18283025-XX	18-28 GHz	30	25	2.0	1.8	A
QPW-18283040-XX	18-28 GHz	30	40	2.3	1.9	A
QPW-18283310-XX	18-28 GHz	33	10	1.8	3.0	A
QPW-18283325-XX	18-28 GHz	33	25	2.0	3.4	A
QPW-18283340-XX	18-28 GHz	33	40	2.3	3.5	A
QPW-18283525-XX	18-28 GHz	35	25	2.0	6.8	B
QPW-18283540-XX	18-28 GHz	35	40	2.3	7.0	B
QPW-26352315-XX	26.5-34.5GHz	23	15	1.8	0.4	J,G
QPW-26352326-XX	26.5-34.5GHz	23	26	2.0	0.45	J,G
QPW-26352337-XX	26.5-34.5GHz	23	37	2.3	0.5	J,G
QPW-26352348-XX	26.5-34.5GHz	23	48	2.5	0.55	J,G
QPW-26352815-XX	26.5-34.5GHz	28	15	2.0	1.5	A,R
QPW-26352826-XX	26.5-34.5GHz	28	26	2.3	1.6	A,R
QPW-26352837-XX	26.5-34.5GHz	28	37	2.5	1.7	A,R
QPW-26352848-XX	26.5-34.5GHz	28	48	2.8	1.8	A,R
QPW-26353013-XX	26.5-34.5GHz	30	13	2.0	3.0	B,K
QPW-26353024-XX	26.5-34.5GHz	30	24	2.3	3.2	B,K
QPW-26353035-XX	26.5-34.5GHz	30	35	2.5	3.4	B,K
QPW-26353046-XX	26.5-34.5GHz	30	46	2.8	3.6	B,K
QPW-31372314-XX	31-37GHz	23	14	2.5	0.8	J,G



# Millimeter-Wave Broadband Power Amplifiers

QPW

Amplifier Products



## Specifications

Model Number	Frequency Range (GHz)	P1dB (dBm)	Gain (dB)	Gain Flatness (±dB)	Current (A) max. at 12V	Outline (pages 31-32)
QPW-31372330-XX	31-37GHz	23	30	2.8	0.95	J,G
QPW-31372342-XX	31-37GHz	23	42	3.0	1.1	J,G
QPW-31372352-XX	31-37GHz	23	52	3.3	1.2	J,G
QPW-31372714-XX	31-37GHz	27	14	2.5	1.2	J,G
QPW-31372730-XX	31-37GHz	27	30	2.8	1.4	J,G
QPW-31372742-XX	31-37GHz	27	42	3.0	1.5	J,G
QPW-31372752-XX	31-37GHz	27	52	3.3	1.6	J,G
QPW-31373029-XX	31-37GHz	30	29	2.8	2.8	A,R
QPW-31373040-XX	31-37GHz	30	40	3.0	3.0	A,R
QPW-31373050-XX	31-37GHz	30	50	3.3	3.2	A,R
QPW-31373229-XX	31-37GHz	32	29	2.8	4.8	A,R
QPW-31373240-XX	31-37GHz	32	40	3.0	5.0	A,R
QPW-31373250-XX	31-37GHz	32	50	3.3	5.2	A,R
QPW-31373428-XX	31-37GHz	34	28	3.0	9.6	B,K
QPW-31373439-XX	31-37GHz	34	39	3.3	10.0	B,K
QPW-31373449-XX	31-37GHz	34	49	3.5	10.4	B,K
QPW-37452018-XX	37-45 GHz	20	18	2.5	0.8	J,G
QPW-37452028-XX	37-45 GHz	20	28	2.7	0.95	J,G
QPW-37452038-XX	37-45 GHz	20	38	2.8	1.1	J,G
QPW-37452048-XX	37-45 GHz	20	48	3.0	1.3	J,G
QPW-37452318-XX	37-45 GHz	23	18	2.5	1.6	J,G
QPW-37452328-XX	37-45 GHz	23	28	2.7	1.9	J,G
QPW-37452338-XX	37-45 GHz	23	38	2.8	2.2	J,G
QPW-37452348-XX	37-45 GHz	23	48	3.0	2.6	J,G
QPW-36472025-XX	36-47GHz	20	25	2.8	1.1	J,G
QPW-36472035-XX	36-47GHz	20	35	3.0	1.3	J,G
QPW-36472045-XX	36-47GHz	20	45	3.3	1.5	J,G
QPW-36472325-XX	36-47GHz	23	25	2.8	1.8	J,G
QPW-36472335-XX	36-47GHz	23	35	3.0	2.0	J,G
QPW-36472345-XX	36-47GHz	23	45	3.3	2.2	J,G



# Millimeter-Wave Broadband Power Amplifiers

QPW

## Specifications

Model Number	Frequency Range (GHz)	P1dB (dBm)	Gain (dB)	Gain Flatness (±dB)	Current (A) max. at 12V	Outline (pages 31-32)
QPW-45571622-XX	45-57GHz	16**	22	3.3	0.6	G
QPW-45571629-XX	45-57GHz	16**	29	3.5	0.65	G
QPW-45571636-XX	45-57GHz	16**	36	3.8	0.75	G
QPW-45571822-XX	45-57GHz	18**	22	3.3	0.8	R
QPW-45571829-XX	45-57GHz	18**	29	3.5	0.85	R
QPW-45571836-XX	45-57GHz	18**	36	3.8	0.95	R
QPW-45572021XX	45-57GHz	20**	21	3.3	1.6	R
QPW-45572028-XX	45-57GHz	20**	28	3.5	1.7	R
QPW-45572035-XX	45-57GHz	20**	35	3.8	2.8	R
QPW-50661620-XX	50-66GHz	16**	20	2.5	0.35	P,I
QPW-50661630-XX	50-66GHz	16**	30	3.0	0.5	P,I
QPW-50661820-XX	50-66GHz	18**	20	2.5	0.5	X
QPW-50661830-XX	50-66GHz	18**	30	3.0	0.65	X
QPW-50662018-XX	50-66GHz	20**	18	2.5	0.9	*
QPW-50662028-XX	50-66GHz	20**	28	3.0	1.0	*
QPW-90951616-XX	90-95GHz	16	16	2.5	0.65	P,I
QPW-90951625-XX	90-95GHz	16	25	3.0	0.7	P,I
QPW-90951816-XX	90-95GHz	18	16	2.5	0.65	P,I
QPW-90951825-XX	90-95GHz	18	25	3.0	0.7	P,I
QPW-90952016-XX	90-95GHz	20**	16	2.5	0.65	P,I
QPW-90952025-XX	90-95GHz	20**	25	3.0	0.7	X
QPW-90952215-XX	90-95GHz	22**	15	2.5	0.9	X
QPW-90952225-XX	90-95GHz	22**	25	3.0	1.2	X

\*\*Saturated Power Output Level

\*Custom Outline

## Ordering Information

Model Number **QPW - ABCD EF GH IJ**

frequency range, minimum-maximum frequencies, in GHz

P1dB (Power at 1dB Gain Compression Point) in dBm (or saturated power where applicable)

outline designation (see pages 31-32)

gain, in dB



# ..... Millimeter-Wave Low Noise Amplifiers

QLN

## Characteristics

- ◆ Offered Over 18-95 GHz Range
- ◆ State-of-the-art Low Noise Performance
- ◆ Wide Selection of Gain and Noise Figures
- ◆ Low Power Consumption

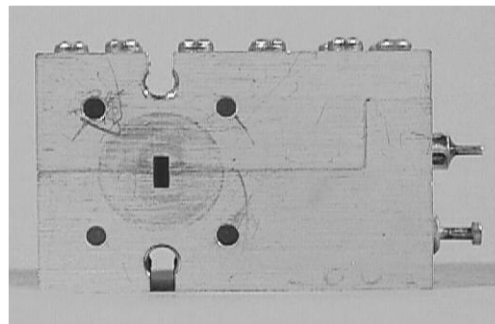

## Product Description

QuinStar Technology's series QLN low noise amplifiers utilize advanced MMICs and discrete devices for state-of-the-art low noise performance in the 18-95 GHz frequency range. These amplifiers operate over up to 4 GHz bandwidth at most frequency ranges of commercial or military interest. Wide range of noise figures and gains are offered over each frequency interval.

waveguide ports. For 18 to 40 GHz amplifiers, we offer 2.9 mm coaxial connectors, and 2.4 mm for 40-50 GHz and 1.9 mm connector for frequencies beyond. Appropriate waveguide input and/or output ports are offered for the entire range from 18 to 96 GHz. Any valid combination of coaxial and waveguide input and output ports can be supplied, if desired. Integral waveguide isolators are also available for improved input and output matches.

The standard amplifier housing offers a wide range and combinations of input and output coaxial connectors or

## Specifications

Model Number	Frequency Range (GHz)	Noise Figure (dB)	Gain (dB)	Current (mA) max.	Outline (pages 31-32)
QLN-ABCD2520-XX	18-22 GHz	2.5	20	100	J,E,G
QLN-ABCD2540-XX	18-22 GHz	2.5	40	180	J,E,G
QLN-ABCD2550-XX	18-22 GHz	2.5	50	250	J,G
QLN-ABCD2520-XX	22-26 GHz	2.5	20	100	J,E,G
QLN-ABCD2540-XX	22-26 GHz	2.5	40	180	J,E,G
QLN-ABCD2550-XX	22-26 GHz	2.5	50	250	J,G
QLN-ABCD2822-XX	26-32 GHz	2.8	22	100	J,E,G
QLN-ABCD2834-XX	26-32 GHz	2.8	34	150	J,E,G
QLN-ABCD2846-XX	26-32 GHz	2.8	46	250	J,G
QLN-ABCD2822-XX	33-36 GHz	2.8	22	100	J,E,G
QLN-ABCD2834-XX	33-36 GHz	2.8	34	150	J,E,G
QLN-ABCD2846-XX	33-36 GHz	2.8	46	250	J,G
QLN-ABCD2822-XX	37-40 GHz	2.8	22	100	J,E,G
QLN-ABCD2834-XX	37-40 GHz	2.8	34	150	J,E,G
QLN-ABCD2846-XX	37-40 GHz	2.8	46	250	J,G
QLN-ABCD3215-XX	38-42 GHz	3.2	15	100	J,E,G
QLN-ABCD3225-XX	38-42 GHz	3.2	25	150	J,E,G
QLN-ABCD3235-XX	38-42 GHz	3.2	35	250	J,G
QLN-ABCD3245-XX	38-42 GHz	3.2	45	350	J,G
QLN-ABCD4518-XX	42-46 GHz	4.5	18	100	J,E,G
QLN-ABCD4527-XX	42-46 GHz	4.5	27	150	J,G
QLN-ABCD4537-XX	42-46 GHz	4.5	37	250	J,G



### Specifications

Model Number	Frequency Range (GHz)	Noise Figure (dB)	Gain (dB)	Current (mA) max.	Outline (pages 31-32)
QLN-ABCD4818-XX	50-54 GHz	4.8	18	100	J,P,I
QLN-ABCD4836-XX	50-54 GHz	4.8	36	180	P,I
QLN-ABCD4818-XX	54-58 GHz	4.8	18	100	P,I
QLN-ABCD4836-XX	54-58 GHz	4.8	36	180	P,I
QLN-ABCD4818-XX	58-62 GHz	4.8	18	100	P,I
QLN-ABCD4836-XX	58-62 GHz	4.8	36	180	P,I
QLN-ABCD4518-XX	62-66 GHz	4.5	18	100	P,I
QLN-ABCD4536-XX	62-66 GHz	4.5	36	180	P,I
QLN-ABCD6015-XX	74-77 GHz	6.0	15	220	P,I
QLN-ABCD6015-XX	92-95 GHz	6.0	15	80	P,I
QLN-ABCD6028-XX	92-95 GHz	6.0	28	150	P,I

### Ordering Information

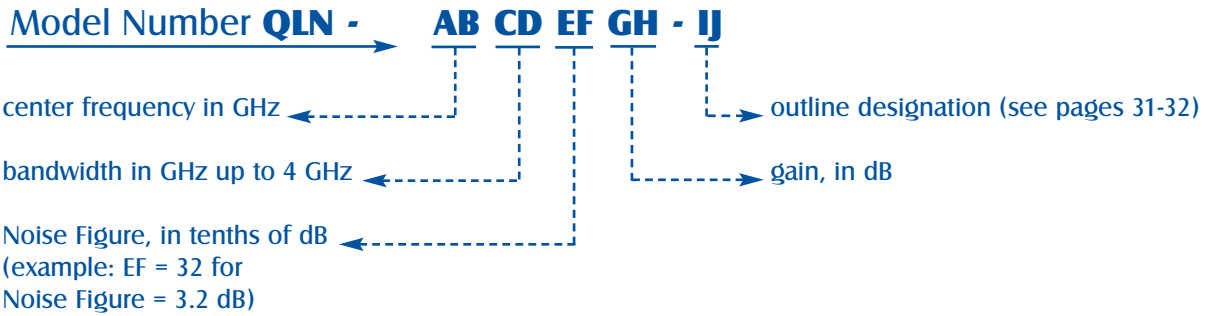



# Millimeter-Wave Narrowband Power Amplifiers

QPN

## Characteristics

- ◆ Offered over 18-95 GHz
- ◆ State-Of-The-Art Power Performance
- ◆ Compact MIC Design

## Product Description

QuinStar Technology's series QPN power amplifiers utilize advanced Millimeter wave Monolithic Integrated Circuits (MMICs) and discrete devices for state-of-the-art power performance up to 4 GHz bandwidth in the 18-95 GHz frequency range. The standard amplifier housing offers a wide range and combinations of input and output coaxial connectors or waveguide ports. For 18 to 40 GHz amplifiers, we offer 2.9 mm coaxial connectors, and 2.4 mm for 40-50 GHz and 1.9 mm connectors for frequencies

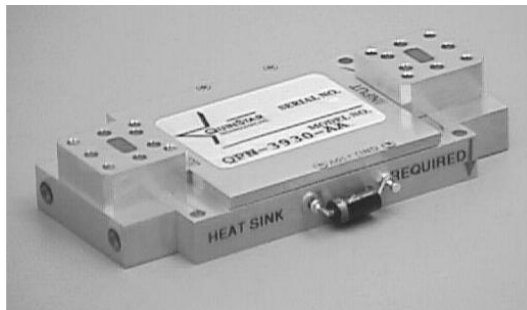

beyond. Appropriate waveguide input and/or output ports are offered for the entire range from 18 to 95 GHz. Any valid combination of coaxial and waveguide input and output ports can be supplied, if desired.

In addition to the standard products, QuinStar can produce customized amplifiers to specific requirements. Integral waveguide isolators are also available for improved input and output matches.

## Specifications

Model Number	Frequency Range <sup>1</sup> (GHz)	P1dB (dBm)	Gain (dB)	Voltages (V)	Current (A) max.	Outline (pages 31-32)
QPN-ABCD2325-XX	18-22 GHz	23	25	12	0.6	J,G
QPN-ABCD2340-XX	18-22 GHz	23	40	12	0.7	J,G
QPN-ABCD2725-XX	18-22 GHz	27	25	12	1.1	J,G
QPN-ABCD2740-XX	18-22 GHz	27	40	12	1.2	J,G
QPN-ABCD3025-XX	18-22 GHz	30	25	12	1.8	A,R
QPN-ABCD3040-XX	18-22 GHz	30	40	12	1.9	A,R
QPN-ABCD3325-XX	18-22 GHz	33	25	10	3.4	A,R
QPN-ABCD3340-XX	18-22 GHz	33	40	10	3.5	A,R
QPN-ABCD3625-XX	18-22 GHz	36	25	±10	6	B,K
QPN-ABCD3640-XX	18-22 GHz	36	40	±10	6.5	B,K
QPN-ABCD3825-XX	18-22 GHz	38	25	±10	12.0	*
QPN-ABCD3840-XX	18-22 GHz	38	40	±10	13.0	*
QPN-ABCD2325-XX	22-26 GHz	23	25	12	0.6	J,G
QPN-ABCD2340-XX	22-26 GHz	23	40	12	0.7	J,G
QPN-ABCD2725-XX	22-26 GHz	27	25	12	1.1	J,G
QPN-ABCD2740-XX	22-26 GHz	27	40	12	1.2	J,G
QPN-ABCD3025-XX	22-26 GHz	30	25	12	1.8	A,R
QPN-ABCD3040-XX	22-26 GHz	30	40	12	1.9	A,R
QPN-ABCD3325-XX	22-26 GHz	33	25	10	3.4	A,R
QPN-ABCD3340-XX	22-26 GHz	33	40	10	3.5	A,R
QPN-ABCD3625-XX	22-26 GHz	36	25	±10	6	B,K
QPN-ABCD3640-XX	22-26 GHz	36	40	±10	6.5	B,K
QPN-ABCD3825-XX	22-26 GHz	38	25	±10	12	*
QPN-ABCD3840-XX	22-26 GHz	38	40	±10	13	*
QPN-ABCD2326-XX	26-32 GHz	23	26	12	0.45	J,G



# Millimeter-Wave Narrowband Power Amplifiers

QPN

## Specifications

Model Number	Frequency Range' (GHz)	P1dB (dBm)	Gain (dB)	Voltages (V)	Current (A) max.	Outline (pages 31-32)
QPN-ABCD2337-XX	26-32 GHz	23	37	12	0.5	J,G
QPN-ABCD2348-XX	26-32 GHz	23	48	12	0.55	J,G
QPN-ABCD2526-XX	26-32 GHz	25	26	12	0.8	J,G
QPN-ABCD2537-XX	26-32 GHz	25	37	12	0.85	J,G
QPN-ABCD2548-XX	26-32 GHz	25	48	12	0.9	J,G
QPN-ABCD2828-XX	26-32 GHz	28	28	12	1.7	J,G
QPN-ABCD2839-XX	26-32 GHz	28	39	12	1.8	J,G
QPN-ABCD2850-XX	26-32 GHz	28	50	12	1.8	J,G
QPN-ABCD3027-XX	26-32 GHz	30	27	12	3.1	A,R
QPN-ABCD3038-XX	26-32 GHz	30	38	12	3.2	A,R
QPN-ABCD3050-XX	26-32 GHz	30	50	12	3.3	A,R
QPN-ABCD3327-XX	26-32 GHz	33	27	±12	4.4	A,R
QPN-ABCD3338-XX	26-32 GHz	33	38	±12	4.5	A,R
QPN-ABCD3350-XX	26-32 GHz	33	50	±12	4.6	A,R
QPN-ABCD3527-XX	26-32 GHz	35	27	±12	8.8	B,K
QPN-ABCD3538-XX	26-32 GHz	35	38	±12	9	B,K
QPN-ABCD3550-XX	26-32 GHz	35	50	±12	9.6	B,K
QPN-ABCD2325-XX	33-36 GHz	23	25	12	0.8	J,G
QPN-ABCD2336-XX	33-36 GHz	23	36	12	0.9	J,G
QPN-ABCD2347-XX	33-36 GHz	23	47	12	0.95	J,G
QPN-ABCD2725-XX	33-36 GHz	27	25	12	1.6	J,G
QPN-ABCD2736-XX	33-36 GHz	27	36	12	1.8	J,G
QPN-ABCD2747-XX	33-36 GHz	27	47	12	2	J,G
QPN-ABCD3023-XX	33-36 GHz	30	23	12	3	A,R
QPN-ABCD3035-XX	33-36 GHz	30	35	12	3.2	A,R
QPN-ABCD3045-XX	33-36 GHz	30	45	12	3.5	A,R
QPN-ABCD3323-XX	33-36 GHz	33	23	±12	5t	A,R
QPN-ABCD3335-XX	33-36 GHz	33	35	±12	5.2	A,R
QPN-ABCD3345-XX	33-36 GHz	33	45	±12	5.5	A,R
QPN-ABCD3621-XX	33-36 GHz	36	21	±12	10	B,K
QPN-ABCD3630-XX	33-36 GHz	36	30	±12	10.5	B,K
QPN-ABCD3640-XX	33-36 GHz	36	40	±12	11	B,K
QPN-ABCD3820-XX	33-36 GHz	38	20	12	20	**
QPN-ABCD3830-XX	33-36 GHz	38	30	12	21	**
QPN-ABCD3840-XX	33-36 GHz	38	40	12	22	**
QPN-ABCD2324-XX	37-40 GHz	23	24	12	0.4	J,G
QPN-ABCD2335-XX	37-40 GHz	23	35	12	0.5	J,G
QPN-ABCD2345-XX	37-40 GHz	23	45	12	0.5	J,G
QPN-ABCD2723-XX	37-40 GHz	27	23	12	1.2	J,G
QPN-ABCD2734-XX	37-40 GHz	27	34	12	1.3	J,G
QPN-ABCD2745-XX	37-40 GHz	27	45	12	1.4	J,G
QPN-ABCD3021-XX	37-40 GHz	30	21	12	2.7	A,R
QPN-ABCD3032-XX	37-40 GHz	30	32	12	2.8	A,R
QPN-ABCD3043-XX	37-40 GHz	30	43	12	2.9	A,R
QPN-ABCD3330-XX	37-40 GHz	33	30	12	4.7	A,R



# Millimeter-Wave Narrowband Power Amplifiers

QPN

Amplifier Products



## Specifications

Model Number	Frequency Range <sup>1</sup> (GHz)	P1dB (dBm)	Gain (dB)	Voltages (V)	Current (A) max.	Outline (pages 31-32)
QPN-ABCD3342-XX	37-40 GHz	33	42	12	4.8	A,R
QPN-ABCD3353-XX	37-40 GHz	33	53	12	5	A,R
QPN-ABCD3530-XX	37-40 GHz	35	30	±10	9.4	B,K
QPN-ABCD3542-XX	37-40 GHz	35	42	±10	9.6	B,K
QPN-ABCD3553-XX	37-40 GHz	35	53	±10	10	B,K
QPN-ABCD3730-XX	37-40 GHz	37	30	±10	18.5	**
QPN-ABCD3742-XX	37-40 GHz	37	42	±10	19	**
QPN-ABCD3753-XX	37-40 GHz	37	53	±10	20	**
QPN-ABCD2028-XX	40-44 GHz	20	28	12	0.85	J,G
QPN-ABCD2038-XX	40-44 GHz	20	38	12	0.9	J,G
QPN-ABCD2048-XX	40-44 GHz	20	48	12	1.1	J,G
QPN-ABCD2325-XX	40-44 GHz	23	25	12	1.8	A,R
QPN-ABCD2335-XX	40-44 GHz	23	35	12	1.95	A,R
QPN-ABCD2345-XX	40-44 GHz	23	45	12	2.2	A,R
QPN-ABCD2355-XX	40-44 GHz	23	55	12	2.4	A,R
QPN-ABCD2724-XX	40-44 GHz	27	24	12	2	A,R
QPN-ABCD2734-XX	40-44 GHz	27	34	12	2.2	A,R
QPN-ABCD2744-XX	40-44 GHz	27	44	12	2.4	A,R
QPN-ABCD2754-XX	40-44 GHz	27	54	12	2.6	A,R
QPN-ABCD3033-XX	40-44 GHz	30	33	±12	4	A,R
QPN-ABCD3043-XX	40-44 GHz	30	43	±12	4.2	A,R
QPN-ABCD3053-XX	40-44 GHz	30	53	±12	4.5	A,R
QPN-ABCD3333-XX	40-44 GHz	33	33	±12	6.5	A,R
QPN-ABCD3343-XX	40-44 GHz	33	43	±12	6.6	A,R
QPN-ABCD3353-XX	40-44 GHz	33	53	±12	6.7	A,R
QPN-ABCD3531-XX	40-44 GHz	35	31	±10	13t	B,K
QPN-ABCD3541-XX	40-44 GHz	35	41	±10	13.2	B,K
QPN-ABCD3551-XX	40-44 GHz	35	51	±10	13.5	B,K
QPN-ABCD3731-XX	40-44 GHz	37	31	±10	26	**
QPN-ABCD3741-XX	40-44 GHz	37	41	±10	26.5	**
QPN-ABCD3751-XX	40-44 GHz	37	51	±10	27	**
QPN-ABCD2025-XX	44-47GHz	20	25	12	1.7	A,R
QPN-ABCD2035-XX	44-47GHz	20	35	12	1.85	A,R
QPN-ABCD2045-XX	44-47GHz	20	45	12	2	A,R
QPN-ABCD2055-XX	44-47GHz	20	55	12	2.2	A,R
QPN-ABCD2325-XX	44-47GHz	23	25	12	3.5	A,R
QPN-ABCD2335-XX	44-47GHz	23	35	12	3.7	A,R
QPN-ABCD2345-XX	44-47GHz	23	45	12	3.85	A,R
QPN-ABCD2355-XX	44-47GHz	23	55	12	4	A,R
QPN-ABCD1720-XX	50-54GHz	17*	20	12	0.35	P,I,J
QPN-ABCD1730-XX	50-54GHz	17*	30	12	0.5	P,I,J
QPN-ABCD1918-XX	50-54GHz	19*	18	12	0.5	I
QPN-ABCD1928-XX	50-54GHz	19*	28	12	0.65	I
QPN-ABCD2218-XX	50-54GHz	22*	18	12	0.85	X
QPN-ABCD2228-XX	50-54GHz	22*	28	12	1	X



# Millimeter-Wave Narrowband Power Amplifiers

QPN

## Specifications

Model Number	Frequency Range <sup>1</sup> (GHz)	P1dB (dBm)	Gain (dB)	Voltages (V)	Current (A) max.	Outline (pages 31-32)
QPN-ABCD2416-XX	50-54GHz	24**	16	12	1.7	*
QPN-ABCD2426-XX	50-54GHz	24**	26	12	2	*
QPN-ABCD1710-XX	54-58GHz	17**	10	12	0.2	P,I
QPN-ABCD1720-XX	54-58GHz	17**	20	12	0.35	P,I
QPN-ABCD1730-XX	54-58GHz	17**	30	12	0.5	P,I
QPN-ABCD1918-XX	54-58GHz	19**	18	12	0.5	I
QPN-ABCD1928-XX	54-58GHz	19**	28	12	0.65	I
QPN-ABCD2218-XX	54-58 GHz	22**	18	12	0.85	X
QPN-ABCD2228-XX	54-58 GHz	22	28	12	1	X
QPN-ABCD2416-XX	54-58 GHz	24	16	12	1.7	*
QPN-ABCD2426-XX	54-58 GHz	24	26	12	2	*
QPN-ABCD1720-XX	58-62 GHz	17	20	12	0.35	P,I
QPN-ABCD1730-XX	58-62 GHz	17	30	12	0.5	P,I
QPN-ABCD1918-XX	58-62 GHz	19	18	12	0.5	I
QPN-ABCD1928-XX	58-62 GHz	19	28	12	0.65	I
QPN-ABCD2218-XX	58-62 GHz	22	18	12	0.85	X
QPN-ABCD2228-XX	58-62 GHz	22	28	12	1	X
QPN-ABCD2416-XX	58-62 GHz	24	16	12	1.7	*
QPN-ABCD1720-XX	62-66 GHz	17	20	12	0.35	P,I
QPN-ABCD1730-XX	62-66 GHz	17	30	12	0.5	P,I
QPN-ABCD1918-XX	62-66 GHz	19	18	12	0.5	I
QPN-ABCD1928-XX	62-66 GHz	19	28	12	0.65	I
QPN-ABCD2218-XX	62-66 GHz	22	18	12	0.85	X
QPN-ABCD2228-XX	62-66 GHz	22	28	12	1	X
QPN-ABCD2416-XX	62-66 GHz	24	16	12	1.7	*
QPN-ABCD2426-XX	62-66 GHz	24	26	12	2	*
QPN-ABCD1315-XX	74-77 GHz	13	15	12	0.2	P,I
QPN-ABCD1320-XX	90-95 GHz	13	20	12	0.55	P,I
QPN-ABCD1720-XX	90-95 GHz	17	20	12	0.55	P,I
QPN-ABCD2010-XX	90-95 GHz	20**	10	12	0.3	P,I
QPN-ABCD2020-XX	90-95 GHz	20**	20	12	0.55	P,I
QPN-ABCD2208-XX	90-95 GHz	22**	8	12	0.6	I
QPN-ABCD2218-XX	90-95 GHz	22**	18	12	0.85	I
QPN-ABCD2418-XX	90-95 GHz	24**	18	12	1.25	X
QPN-ABCD2616-XX	90-95 GHz	26**	16	12	2.5	*

<sup>1</sup> Standard product has 2 GHz of operating bandwidth within this Frequency Range.

\*\*Saturate Power Level

\*Custom Outline



# Millimeter-Wave Narrowband Power Amplifiers

QPN

## Ordering Information

Model Number **QPN - AB CD EF GH - IJ**

center frequency in GHz

bandwidth in GHz up to 4 GHz

P1dB (Power at 1dB Gain Compression Point), in dBm  
(or Saturated Power, where applicable)

outline designation (see pages 31-32)

gain, in dB



# Millimeter-Wave General Purpose Amplifiers

QGN

## Characteristics

- ◆ Offered Over 18-95 GHz
- ◆ Wide Range of Frequency and Gain Options
- ◆ Choice of Packages & Interfaces



## Product Description

QuinStar Technology's series QGN amplifiers are ideally suited for most common applications requiring high RF gain over a relatively narrow bandwidth. The amplifiers are offered with nominal gains of 20 to 50 dB typically, and nominal output power of 10-17 dBm, across their entire operating frequency range

The standard amplifier housing offers a wide range and combinations of input and output coaxial connectors or

waveguide ports. For 18 to 40 amplifiers, we offer 2.9 mm coaxial connectors, and 2.4 mm for 40-50 GHz and 1.9 mm connector for frequencies beyond. Appropriate waveguide input and/or output ports are offered for the entire range from 18 to 95 GHz. Any valid combination of coaxial and waveguide input and output ports can be supplied, if desired. Integral waveguide isolators are also available for improved input and output matches.

## Specifications

Model Number	Frequency Range (GHz)	P1dB (dBm)	Gain (dB)	Gain Flatness (±dB)	Current (mA) max. at 12V	Outline (pages 31-32)
QGN-18221720-XX	18-22	17	20	1.5	350	J,G,E
QGN-18221730-XX	18-22	17	30	1.65	450	J,G
QGN-18221740-XX	18-22	17	40	1.8	500	J,G
QGN-18221750-XX	18-22	17	50	2.0	600	J,G
QGN-22261718-XX	22-26	17	18	1.5	350	J,G
QGN-22261730-XX	22-26	17	30	1.65	450	J,G
QGN-22261740-XX	22-26	17	40	1.8	550	J,G
QGN-22261750-XX	22-26	17	50	2.0	600	J,G
QGN-26321716-XX	26-32	17	16	1.5	350	J,G
QGN-26321727-XX	26-32	17	27	1.65	450	J,G
QGN-26321737-XX	26-32	17	37	1.8	550	J,G
QGN-26321748-XX	26-32	17	48	2.0	600	J,G
QGN-33361715-XX	33-36	17	15	1.5	400	J,G
QGN-33361726-XX	33-36	17	26	1.65	480	J,G
QGN-33361737-XX	33-36	17	37	1.8	560	J,G
QGN-33361748-XX	33-36	17	48	2.0	630	J,G
QGN-37401713-XX	37-40	17	13	1.5	350	J,G
QGN-37401724-XX	37-40	17	24	1.65	450	J,G
QGN-37401735-XX	37-40	17	35	1.8	550	J,G
QGN-37401745-XX	37-40	17	45	2.0	600	J,G
QGN-38421717-XX	38-42	17	17	1.5	450	J,G
QGN-38421727-XX	38-42	17	27	1.65	470	J,G



# Millimeter-Wave General Purpose Amplifiers

QGN

## Specifications

Model Number	Frequency Range (GHz)	P1DB (dBm)	Gain (dB)	Gain Flatness (±dB)	Current (mA) max. at 12V	Outline (pages 31-32)
QGN-38421735-XX	38-42	17	37	1.8	690	J,G
QGN-38421745-XX	38-42	17	47	2.0	790	J,G
QGN-42461718-XX	42-46	17	18	1.5	450	J,G
QGN-42461728-XX	42-46	17	28	1.65	570	J,G
QGN-42461738-XX	42-46	17	38	1.8	700	J,G
QGN-42461748-XX	42-46	17	48	2.0	850	J,G
QGN-58621310-XX	58-62	13	10	2.0	350	P,I
QGN-58621320-XX	58-62	13	20	2.25	500	P,I
QGN-58621330-XX	58-62	13	30	2.5	550	P,I
QGN-62661310-XX	62-66	13	10	2.0	350	P,I
QGN-62661320-XX	62-66	13	20	2.25	500	P,I
QGN-62661330-XX	62-66	13	30	2.5	550	P,I
QGN-74771010-XX	74-77	10	10	2.5	200	P,I
QGN-92961010-XX	92-95	10	10	2.25	300	P,I
QGN-92961020-XX	92-95	10	20	2.5	550	P,I

## Ordering Information

Model Number **QGN - ABCD EF GH - IJ**

frequency range, minimum-maximum frequencies, in GHz

Power at 1 dB Gain Compression Point, in dBm

outline designation (see pages 31-32)

gain, in dB

Outline J,A,B

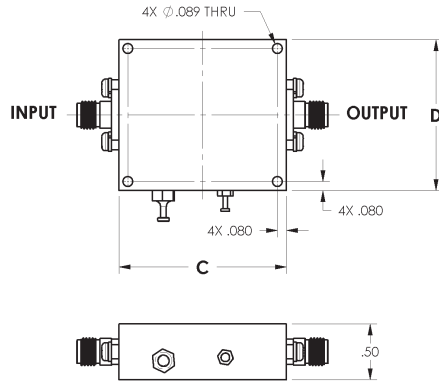

OUTLINE	C	D
J	1.50	1.35
A	2.50	1.75
B	2.50	3.00

Outline E

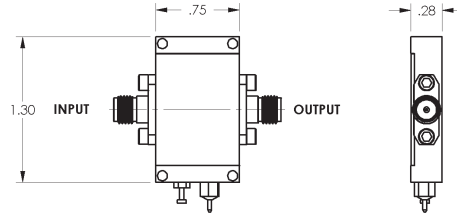

Outline G

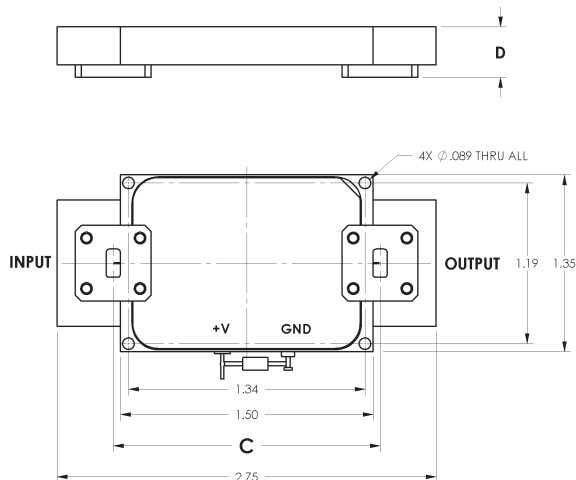

DIM	WR-34	K	Ka	Q	U
C	1.67		1.64	1.61	1.59
D		.69			.66

Outline H

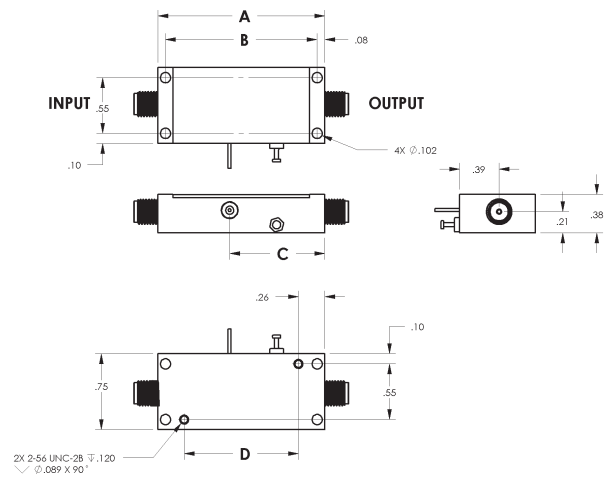

OUTLINE	A	B	C	D	REF STAGES
H1	.75	.60	.30	.25	1
H2	.98	.83	.49	.48	2
H3	1.20	1.05	.71	.70	3
H4	1.43	1.28	.71	.93	4



# Amplifier Outlines

Outline I

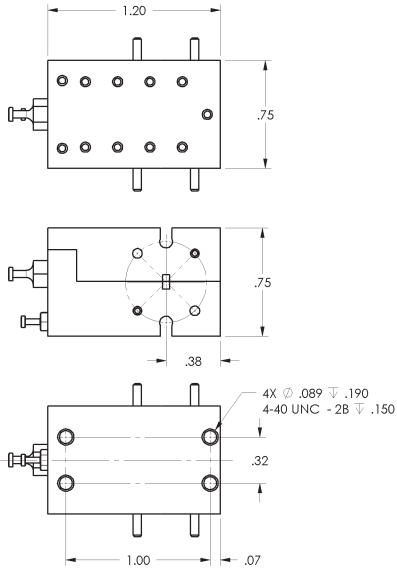

Outline X

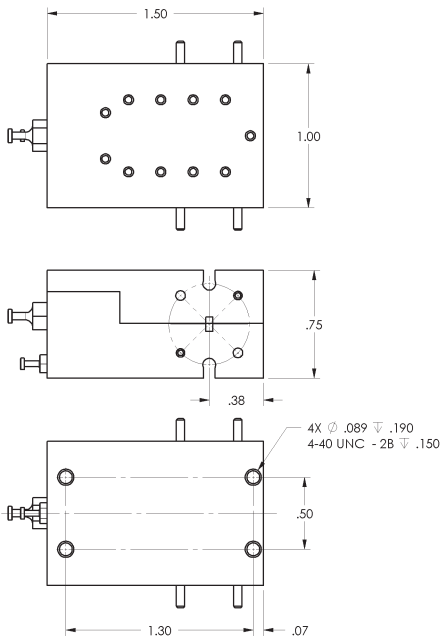

Outline K

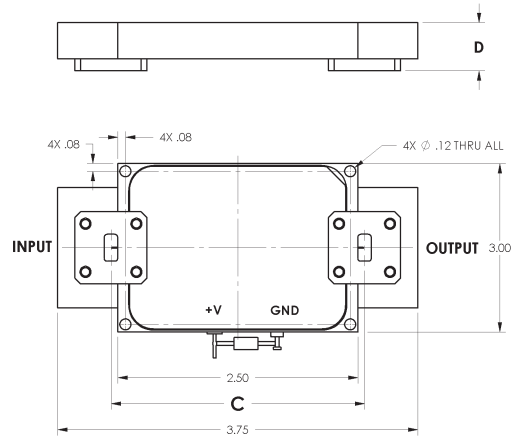

DIM	WR-34	K	Ka	Q	U
C	2.67		2.64	2.61	2.59
D		.57		.54	

Outline P

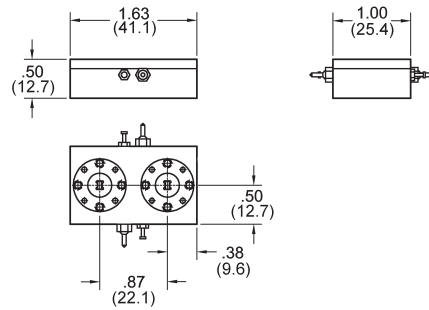

Outline R

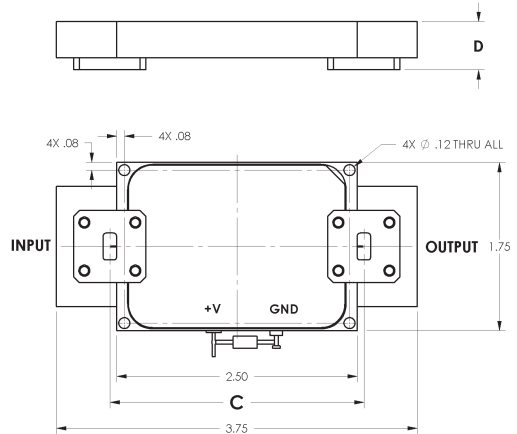

DIM	WR-34	K	Ka	Q	U
C	2.67		2.64	2.61	2.59
D		.57		.54	



# Cryogenic Amplifiers and Systems

QCA

QUINSTAR TECHNOLOGY has acquired the product line and the capability of Berkshire Technologies, inc, a small innovative company specializing in the manufacture of ultra low noise microwave amplifiers and systems. Berkshire Products incorporate many years of unique experience in designing GaAsFET and HEMT amplifiers tailored for ultra low noise at spot frequencies. QuinStar offers a standard line of coolable low-noise amplifiers (LNAs) that cover the most popularly used frequencies in the 1 to 18 GHz range. We can also custom-design and build special-purpose coolable amplifiers to customer specifications.

### APPLICATIONS

Cooled, low noise amplifiers are used in critical applications that require the ultimate in sensitivity. Cooled LNAs find important uses in radio astronomy, satellite earth stations, radiometers, and electron spin resonance measurements. They can also serve as IF amplifiers for SIS and Schottky diode-based millimeter and sub-millimeter mixers.

### COOLING HEMT BASED AMPLIFIERS

Cooling a HEMT-based amplifier to 20K decreases the noise temperature by a factor of ten (and increases gain by about 3dB) compared to room temperature values. A typical cooling curve showing amplifier noise temperature as a function of physical temperature is shown below. Note that the noise continues to decrease below 20K, and that amplifier performance continues to improve down to physical temperatures of 4K and lower.

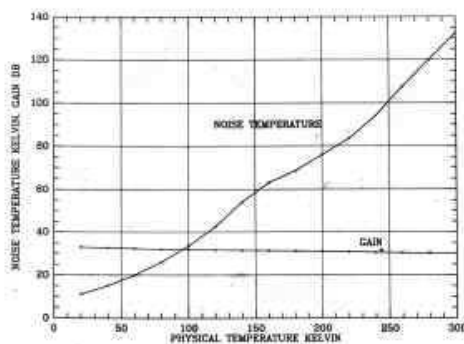

An amplifier cooled to 20K physical produces the lowest noise temperature, which can be estimated by the relation 1.0K per 1 GHz of operating frequency plus 1K. That is, an amplifier operating at 8.5 GHz can be expected to have a typical noise temperature of 10K (1.0K \* 8.5 + 1K).

### CRYOGENIC COOLING SYSTEMS

Cooling the amplifier to 20K or below requires a cryogenic refrigeration system. Components of this system are the

helium refrigerator, the dewar and its radiation heat shield, together with the amplifiers and associated waveguide and coaxial components. The amplifiers, which are attached to a 20K refrigerator cold head, are in a vacuum. They are surrounded by the radiation shield (temperature approximately 70K) which impedes the flow of heat from the dewar to the amplifiers. Microwave connections in and out of the dewar are designed to achieve low electrical loss and to provide a large thermal barrier. Input isolators are cooled to 20K to reduce the loss temperature of those components. Cool down time for such a system is several hours; the exact time depends upon the size of the refrigerator.

A 20K cryogenic system of the type described provides nearly the ultimate in noise performance for only moderate complexity and cost. Such systems can be custom built by QuinStar Technology. To exceed its performance, one would have to go to a liquid Helium cooling system, or employ a refrigerator capable of maintaining the amplifiers at temperatures of 4K.

Refrigerator-cooled HEMT systems have been found to be very reliable in field use on antennas. The MTBF for a 20K refrigerator is much greater than one year; amplifier life is extremely long based on the performance of hundreds of units operating in the field.

### POWER SUPPLIES FOR COOLABLE AMPLIFIERS

Power Supply Model PS-3D is recommended for use with our cooled amplifiers. This servo-controlled power supply is complete with metering and maintains the proper bias on the cooled FETs.

### AUTOMATED NOISE FIGURE TEST SYSTEMS

The Automated Test Bench measures the noise performance of low-noise microwave amplifiers as a function of frequency and displays the results as a graph and as a table of values. The frequency coverage is up to 18 GHz; measurement accuracy is better than 1 K. The Test Bench is computer controlled.

The system performs noise figure measurements by switching the input of the LNA between a terminated load at ambient temperature, and one at 77K (or other temperature). The Automated Test Bench consists of two units. The RF unit contains a precision test receiver; the D/A unit contains the analog-to-digital converter, relay drivers, and digital-to-analog converters. The Test Bench is controlled by an IBM-PC or compatible computer through the IEEE-488 bus.

### MANUFACTURING PRACTICES AND PROCEDURES

All our amplifiers are designed using computer aided techniques to optimize performance over the frequency range of interest. Computer design techniques have



# Cryogenic Amplifiers and Systems

QCA

enabled us to achieve much wider bandwidths than formerly possible. At 4 GHz, 30 percent bandwidth is available with only a small degradation of noise performance; we produce an octave band amplifier in the 2-4 GHz range. For cooled amplifiers, each stage is supplied with an external regulator circuit which stabilizes the operating point over the large range of temperature changes encountered during cool down. We test each amplifier several times at the appropriate temperatures in the process of manufacture, and adjust for optimum performance in the cold condition.

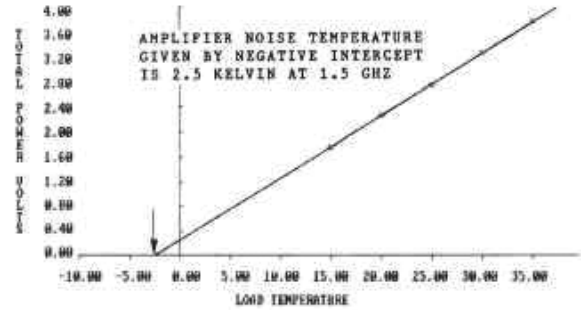

Noise temperature and gain of our cooled HEMT amplifiers are measured on an automated test system. The inherent accuracy of measurements is a few tenths of a degree Kelvin. With each amplifier shipped, we provide test data showing frequency range of the amplifier, noise figure, small signal gain, and optimum operating biases.

Additional test data over operating temperature and frequency ranges may be available at additional cost. Below is a sample list of some of our amplifier models. Most amplifiers we produce are custom-designed to meet the customer's specific requirements.

### Noise Temperature Measured at 20 Kelvin Physical Temperature

MODEL NUMBER	FREQUENCY GHZ	NOISE TEMPERATURE	GAIN dB
QCA-L-1.5-30H	1.3 - 1.7	5 K	33
QCA-S-2.3-30H	2.1 - 2.4	6 K	33
QCA-C-4.0-30H	3.5 - 4.5	8 K	30
QCA-C-5.0-30H	4.8 - 5.1	9 K	28
QCA-X-8.5-30H	8.0 - 9.0	10 K	30
QCA-X-11-30H	9.0 - 10.0	12 K	30
QCA-K-15-25H	12.0 - 18.0	20 K	25

### General Specifications

Gain Flatness	± 1.5dB
Gain Slope	± 0.1dB/10MHz Max.
Power Out @ 1dB Compression	+5dBm
Third Order Intercept	+15dBm
Group Delay:	
Linear	± 0.1 nS/100MHz
Ripple	± 0.1 nS/10MHz
VSWR In/Out	1.25:1 Max; 2:1 L- & S-Band
Connectors In/Out	SMA M/F

### Cooled Amplifier Systems

We supply complete cryogenically cooled systems containing our line of Ultra-Low-Noise cooled HEMT amplifiers. These systems include the closed cycle helium refrigerator (CCR), vacuum dewar, cooled amplifiers, power supplies

and remote control monitor unit. Standard models are available in the frequency ranges indicated below. The amplifiers are cooled to 20 Kelvin in the dewar, where they are interfaced with low loss gapped waveguide. Low loss stainless steel coax lines are employed at the lower frequencies. Vacuum instrumentation and a cryogenic thermometer are included, and a remote helium compressor is supplied with a set of 10 feet of flexible helium lines. In addition a post amplifier of approximately 20 dB gain can be provided to overcome subsequent filter and mixer losses.

The standard system employs the Cryogenic Technology (CTI) model 22 refrigerator. For faster cool down and greater cooling capacity the CTI model 350 refrigerator may be supplied at additional cost.



Model Number	Freq. GHz	Noise Temp.	Gain dB
QCA-L-22H	1.4-1.7	8K	30
QCA-SX-22H	2.2-2.45 8.2-8.8	10K 12K	30 30
QCA-C-4.0-30-350C	3.7-4.2	10K	30
QCA-C-22H	3.7-4.2	12K	30
QCA-XA-22H	8.18-8.98	15K	30
QCA-X-8.5-30-350C	8.2-8.5	12K	30
QCA-XB-22H	10.2-10.7	20K	28
QCA-K-15-30-350C	14.0-16.0	20K	25
QCA-K-22H	14.7-15.3	30K	28

### General Specifications:

Gain Flatness	+/-1.5dB
Gain Ripple	+/-0.2dB/50MHz
Group delay, Linear	0.01 nSec/MHz max.
1 dB Gain Compression	+5 dBm min.
3rd Order Intercept	+15 dBm
Input/output VSWR	1.25:1 max.
Input Connector	Waveguide/Type N
Output Connector	Type N
Phase linearity	5 deg. max. deviation from linear

Improved input VSWR of 1.2:1 is available with Model suffix-1, which incorporates a cooled input isolator at extra cost.

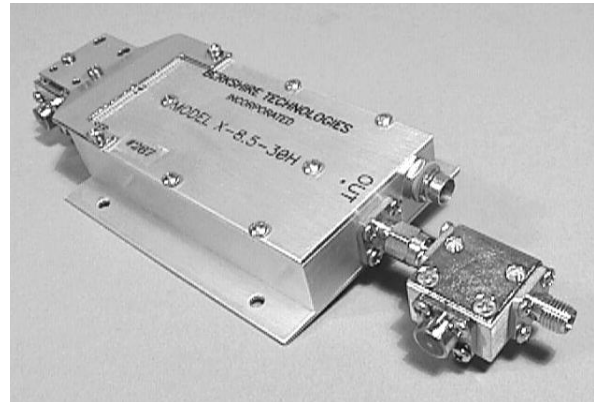



# CW Injection-Locked Gunn Amplifiers

QTI

## Characteristics

- ◆ High Power Output
- ◆ CW Operation
- ◆ Frequency Up to 100 GHz

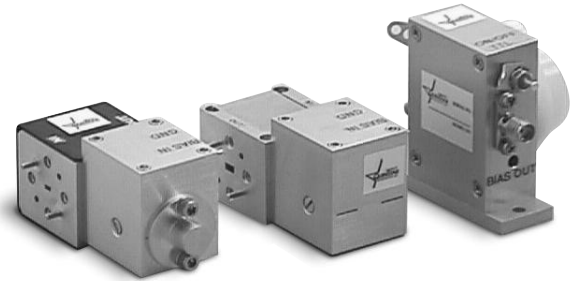

## Product Description

QuinStar Technology's series **QTI CW injection-locked Gunn amplifiers** are alternatives to 3-terminal devices and IMPATT diode-based CW amplifiers, especially at high millimeter wave frequencies. They are offered in the frequency range of 26.5-100 GHz in four waveguide sizes with power levels up to 300 mW. The spectrum purity of the output signal is the same as that of the input signal when the amplifier is injection-locked. In the absence of an

in-band input signal of sufficient power to attain injection-lock, there is a free running output signal. The amplifiers are provided with integral circulators and a DC voltage regulator, and an optional heater is available for improved temperature stability. To achieve higher gain, broader locking bandwidth and higher output, multi-stage and multi-diode configurations are available.

## Specifications

Frequency Band	Ka	Q	V	W
Frequency Range (GHz)	26.5-40	33-50	50-75	90-100
Waveguide Size	WR-28	WR-22	WR-15	WR-10
Bandwidth Range (GHz)	Up to 1 GHz depending on input power			
Power Output Range (mW) <sup>1</sup>	Up to 200	Up to 150	Up to 100	Up to 50
Input Power (mW typ)	10 to 50 depending upon output power and bandwidth.			

<sup>1</sup> Single diode configuration.

Contact factory for detailed specifications and outline drawings.

## Ordering Information

Model Number **QTI- AB CD E 0**



Please specify exact frequency range when ordering.

center frequency rounded to nearest GHz

options

power output in dBm

0 = none  
H = heater



# High Power CW IMPATT Amplifiers

QIC

## Characteristics

- ◆ High Power Output
- ◆ Stable and Injection-Locked Versions
- ◆ Temperature Stabilized

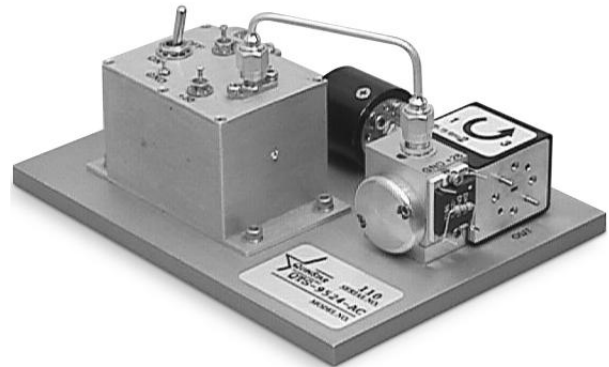

## Product Description

QuinStar Technology's series **QIC CW IMPATT amplifiers** utilize a double drift IMPATT diode mounted in a temperature stabilized waveguide cavity to amplify and generate high RF output power. They are available in stable (linear) or injection-locked, single or multiple stage configurations in commonly used frequency ranges between 43 and 97 GHz. Injection-locked versions have a free running output signal in the absence of an in-band input signal of sufficient power to attain lock.

The amplifiers are provided with integral circulators, DC voltage regulator, and shielded interconnecting cable mounted on a baseplate. Heatsink stands and temperature controllers are also available to help maintain frequency and power stability over a wide baseplate operating temperature range.

## Specifications

FREQUENCY BAND		Q	V	W
Frequency Range (GHz)		43-47	58-62	92-97
Waveguide Size		WR-22	WR-15	WR-10
Bandwidth Range (GHz)		Up to 2 GHz depending on number of stages		
Power Output Range (Watts)		0.2-1.0	0.1-0.4	0.1-0.2
Gain Range (dB)	Single Stage	7-13	6-13	6-13
	Double Stage	10-20	10-20	10-20

Consult factory for detailed specifications and outline drawings.

## Ordering Information

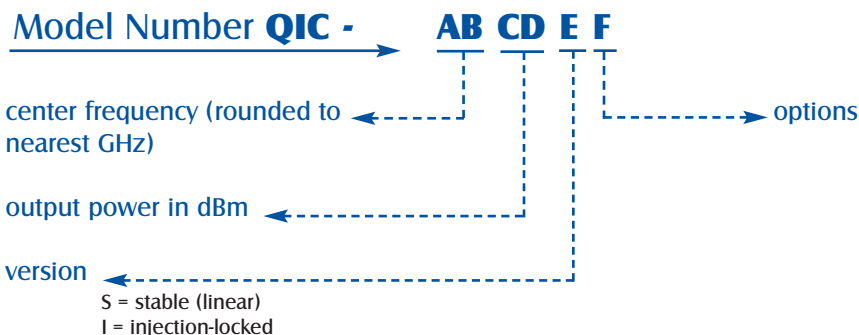

- H = temperature controller with baseplate
- J = temperature controller with heatsink stand
- K = baseplate only
- L = heatsink stand only
- Z = custom



# High Power Pulsed IMPATT Amplifiers

QIP

## Characteristics

- ◆ High Power Output
- ◆ Long and Short Pulse Versions
- ◆ Temperature Stabilized



## Product Description

QuinStar Technology's series **QIP pulsed IMPATT amplifiers** are injection-locked amplifiers (ILA) that utilize a double drift IMPATT diode mounted in a temperature stabilized waveguide cavity to amplify and generate high RF output power. They are available in long and short pulsed, single or multiple stage configurations in commonly used frequency ranges between 43 and 97 GHz.

The amplifiers are provided with integral circulators, pulse modulators, shielded interconnecting cable, and are mounted on a baseplate. Heatsink stands and temperature controllers are also available to help maintain frequency and power stability over a wide baseplate operating temperature range.

## Specifications

FREQUENCY BAND		Q	V	W
Frequency Range (GHz)		43-47	58-62	92-97
Waveguide Size		WR-22	WR-15	WR-10
Bandwidth Range (GHz)		Up to 2 GHz depending on number of stages		
Power Output Range (Watts)	Long Pulse (pulse width 1us-1ms/ duty 0-50%)	0.2-1.0	0.1-0.5	0.1-0.2
	Short Pulse (pulse width 50-150ns/ duty 0-0.5%)	--	--	1-15

Consult factory for detailed specifications and outline drawings.

## Ordering Information

Model Number **QIP -** AB CD E F

center frequency rounded to nearest GHz ←

peak output power in dBm ←

version ←

L = long pulse  
S = short pulse

options →

H = temperature controller with baseplate  
J = temperature controller with heatsink stand  
K = baseplate only  
L = heatsink stand only  
Z = custom



## Section 2

# Receiver Products

Product Title	Model No.	Page Number
<b>Receiver Products</b>		39
Application Notes & Technical Information		40
Broadband Detectors	QEA	41
Balanced Phase Detectors	QEP	43
Harmonic Mixers and Diplexers	QMH	45
Spectrum Analyzer Mixers and Diplexers	QMA	47
Single Ended Mixers	QMS	49
Balanced Mixers	QMB	51
Upconverters	QMU	53
Ultra Broadband Coaxial Mixers	QMC	55
Subharmonic Mixers	QHS	56
Active Mixers/Receivers	QAM	57
Coaxial Mixer	QCM	57
Image -reject and Single Sideband Mixers -Single Sideband Upconverters	QSM	58
I-Q Mixer	QMI	58
Bi-phase Modulator	QBP	58

# Receiver Products

## Application Notes and Technical Information

**1 dB gain compression point.** –The dynamic range of a mixer is the range of input RF power levels (in dBm) for which the mixer produces useful IF output power. Dynamic range is limited at the low end by the noise performance of the mixer devices. When the input power is such as to produce a discernable IF output signal a constant power ratio (equal to the conversion loss) is established between input RF power and output IF power. As input power is increased, a point is reached where this constant power ratio is no longer maintained and conversion loss begins to increase. When conversion loss has increased by 1 dB, the upper limit of the mixers dynamic range is deemed to have been reached and this “1 dB compression point” generally delineates the upper level of input power for which the mixer should be used

**1 dB desensitization level** – The RF input level of an interfering signal that causes a mixer’s small signal conversion loss to increase by 1 dB.

**Conversion loss (SSB)** – The ratio of RF input power to the IF output power of one sideband. If an IF amplifier is used, conversion gain may result.

**DC polarity** – The mixer IF voltage measured with only the LO operating and the RF port terminated.

**Harmonic intermodulation products** – Mixer output signals other than the desired  $f_{LO} +$  or  $- f_{RF}$ , which are harmonically related to either or both of the input signals. (Also termed NRF + or  $- MLO$ , NxM or “spurs.”)

**Isolation** – The amount an input signal is attenuated when measured at another mixer port.

### Noise Effective Power (NEP)

$$NEP = NV/R \sqrt{Hz}$$

Where NV is noise voltage in Volts/  $\sqrt{Hz}$ , and R = Responsivity in Volts/Watt

**Noise floor = NEP • (modulation frequency)<sup>1/2</sup> in Watts**

**Noise figure (SSB)** – The ratio of the signal-to-noise ratio at the mixer input divided by the signal-to-noise ratio of one of the sidebands at the output.

**Responsivity** – The detector responsivity is the voltage produced at the output for a specific power input, usually expressed in millivolts per microwatt CW.

**Sensitivity** – The minimum input signal required to produce an output signal having a specified signal-to-noise ratio. Tangential sensitivity (TSS) typically assumes 8 dB signal-to-noise ratio.

**Spurious products** – Undesired or spurious products are generated in addition to the desired signal sidebands as a result of diode non-linearities. These products increase the amount of signal power lost, in addition to providing “false” outputs.

**Two-tone intermodulation products** – The generation of spurious output frequencies in a mixer is the result of using non-linear switching elements. Even for the single input frequency the number of such products that is generated as discernible power levels is quite large.

These products have even higher power when the input signal contains multitone components. A figure of merit indicative of the ability of a mixer to suppress such intermodulation products is the “two-tone third order

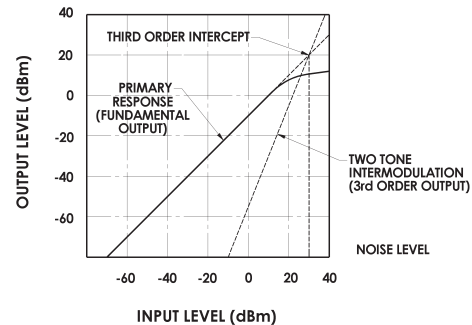
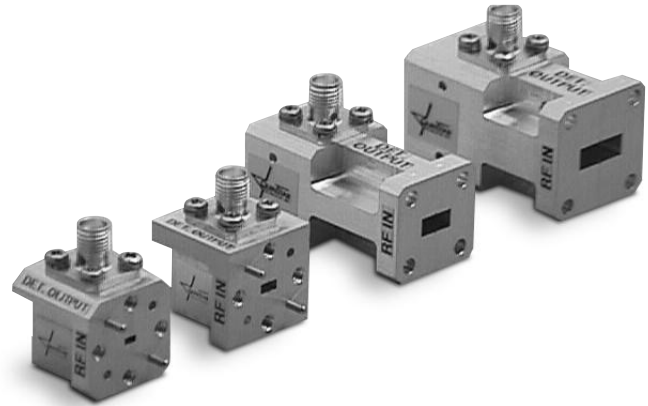

Figure 1. Two-Tone Third Order Intercept Point.

intercept point" (usually measured in dBm). See Figure 1 above. The hypothetical intercept point is arrived at by extrapolating measured data to suggest an input RF power level at which IF power and intermodulation products would be equal. Mixers with high intercept points generate low intermodulation distortion products.

### Characteristics

- ◆ Full Waveguide Bandwidths
- ◆ High Sensitivity
- ◆ No Bias Required
- ◆ Positive or Negative Output



### Product Description

QuinStar Technology's **QEA series broadband detectors** cover the frequency range of 18 to 110 GHz in seven waveguide bands. These detectors provide an output voltage which is directly proportional to the power level of an RF signal without needing any external DC bias. They are useful for power detection, monitoring, built-in-test and frequency measurement. The detectors can also be

used in millimeter-wave test systems with a wide variety of high-impedance oscilloscopes and scalar analyzers. They can be used for both CW and pulsed power measurements. They are constructed with a very rugged, reliable split-block mechanical design and are available with either positive or negative output voltage polarity.

### Specifications

FREQUENCY BAND	K	Ka	Q	U	V	E	W
Frequency Range (GHz)	18-26.5	26.5-40	33-50	40-60	50-75	60-90	75-110
Waveguide Size	WR-42	WR-28	WR-22	WR-19	WR-15	WR-12	WR-10
Sensitivity (mV/mW min) <sup>1,2</sup>	1000	1000	1000	800	800	500	500
Flatness (dB max) <sup>3</sup>	±1.5	±1.5	±1.5	±1.5	±1.5	±1.5	±2.0
Input Power (mW max)	100	100	100	100	100	100	100

<sup>1</sup> The sensitivity of QEA broadband detectors can be optimized over a narrow bandwidth if desired.

<sup>2</sup> Measured at -10dBm input power level, into a 100 K ohm load.

<sup>3</sup> Better flatness can be achieved over reduced bandwidth

Other waveguide bands available for higher frequency operation beyond 110 GHz. Please consult factory.

### Outline Drawings/Mechanical Specifications

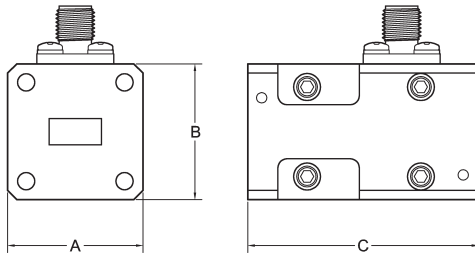

WR-42 and WR-28

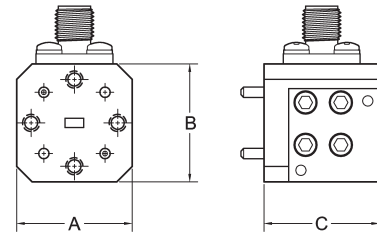

WR-22 through WR-10

FREQUENCY BAND	WAVEGUIDE SIZE	FLANGE PATTERN	VIDEO OUTPUT	OUTLINE DIMENSIONS, inches/mm		
				A	B	C
K	WR-42	UG-595/U	SMA JACK	0.88/22.4	0.88/22.4	1.5/38.1
Ka	WR-28	UG-599/U	SMA JACK	0.75/19.1	0.75/19.1	1.5/38.1
Q	WR-22	UG-383/U	SMA JACK	1.13/28.7	1.13/28.7	1.25/31.75
U	WR-19	UG-383/U	SMA JACK	1.13/28.7	1.13/28.7	1.25/31.75
V	WR-15	UG-385/U	SMA JACK	0.75/19.1	0.75/19.1	0.75/19.1
E	WR-12	UG-387/U	SMA JACK	0.75/19.1	0.75/19.1	0.75/19.1
W	WR-10	UG-387/U	SMA JACK	0.75/19.1	0.75/19.1	0.75/19.1

### Ordering Information

Model Number **QEA - AB CD E F**

center frequency rounded to nearest GHz  
 (1A = 100-109 GHz, FB = fullband)

bandwidth rounded to nearest GHz  
 (FB = fullband)

polarity \*

P = positive  
 N = negative  
 \* Detector output voltage with respect to case

waveguide band designator

K = K-band                      V = V-band  
 A = Ka-band                    E = E-band  
 Q = Q-band                      W = W-band  
 U = U-band



### Characteristics

- ◆ Phase Comparison of 2 RF Signals
- ◆ High RF Isolation
- ◆ Balanced Configuration



### Product Description

QuinStar Technology's **QEP** series **balanced phase detectors** enable phase comparison of two RF signals. They utilize GaAs beam lead diodes which offer significant advantages over other detector types.

The diodes are carefully matched to achieve high isolation between RF ports, low DC offset, noise cancellation and

suppression of the adverse effect of amplitude modulation. The detected output is proportional to phase differences up to 180 degrees for two equal amplitude signals at the same frequency.

Balanced phase detectors are typically used in phase bridges and phase modulated receiver systems.

### Specifications

FREQUENCY BAND	K	Ka	Q	U	V	E	W
Frequency Range (GHz)	18-26.5	26.5-40	33-50	40-60	50-75	60-90	75-110
Waveguide Size	WR-42	WR-28	WR-22	WR-19	WR-15	WR-12	WR-10
Bandwidth (GHz typ)	4	4	4	4	4	4	4
Sensitivity (mV/degrees, typ) <sup>1</sup>	5	5	5	5	4	3	3
RF Isolation (dB typ)	20	20	20	20	20	20	20
AM Suppression (dB typ)	20	20	20	20	20	20	20
Input Power (mW max)	100	100	100	100	100	100	100

Other waveguide sizes are available.

<sup>1</sup> At 5 dBm input into each port with >100K ohm output load.

### Outline Drawings/Mechanical Specifications

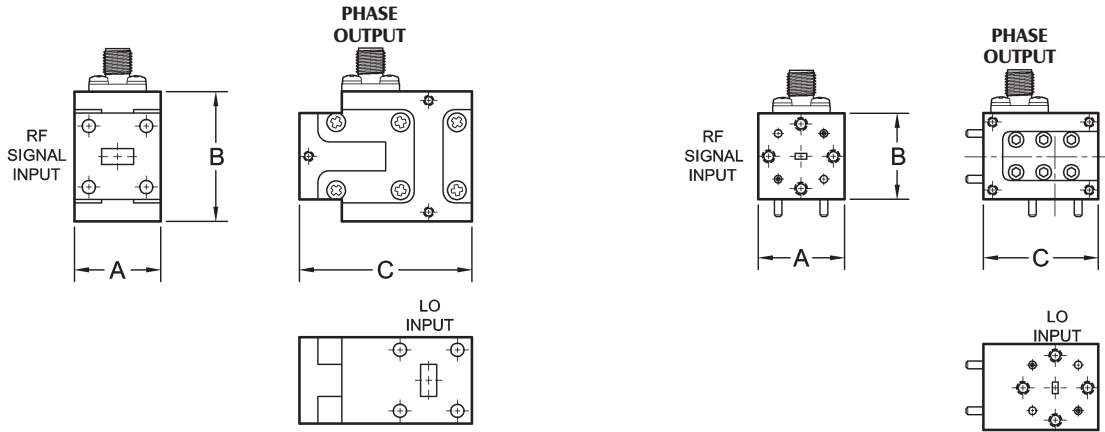

WR-42 and WR-28

WR-22 through WR-10

FREQUENCY BAND	WAVEGUIDE SIZE	FLANGE PATTERN	IF OUTPUT	OUTLINE DIMENSIONS, inches/mm		
				A	B	C
K	WR-42	UG-595/U	SMA JACK	0.88/22.4	1.13/30.2	1.89/48.0
Ka	WR-28	UG-599/U	SMA JACK	0.75/19.1	1.13/30.2	1.50/38.1
Q	WR-22	UG-383/U	SMA JACK	1.13/28.7	1.13/28.7	1.50/38.1
U	WR-19	UG-383/U	SMA JACK	1.13/28.7	1.13/28.7	1.50/38.1
V	WR-15	UG-385/U	SMA JACK	0.75/19.1	0.75/19.1	1.00/25.4
E	WR-12	UG-387/U	SMA JACK	0.75/19.1	0.75/19.1	1.00/25.4
W	WR-10	UG-387/U	SMA JACK	0.75/19.1	0.75/19.1	1.00/25.4

### Ordering Information

Model Number **QEP - AB CD E 0**



Please specify exact RF frequency range when ordering.

center frequency rounded to nearest GHz (1A = 100-109 GHz)

bandwidth rounded to nearest GHz

waveguide band designator

- K = K-band
- A = Ka-band
- Q = Q-band
- U = U-band
- V = V-band
- E = E-band
- W = W-band



### Characteristics

- ◆ Optimized for Any Harmonic Number
- ◆ External Diplexer Option
- ◆ High Sensitivity
- ◆ Broad Bandwidth

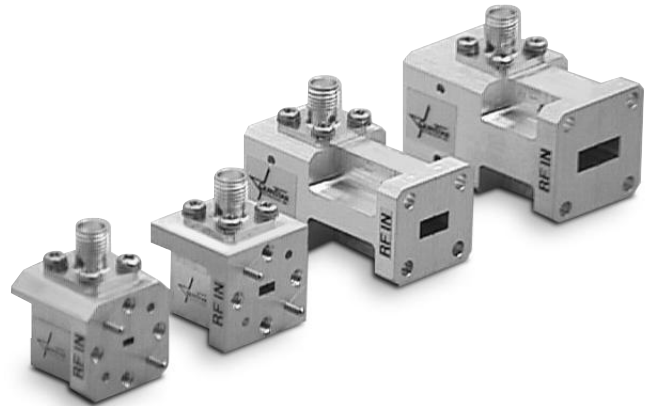

### Product Description

QuinStar Technology's **QMH series harmonic mixers** enable downconversion of millimeter-wave signals using lower frequency (microwave) local oscillator signals. They cover the frequency range of 18 to 170 GHz in nine full waveguide bands. These harmonic mixers are useful for subsystem applications involving frequency sampling such as phase-locked oscillators and frequency linearizers. They are also ideally suited for test and measurement equipment, such as spectrum analyzers, frequency counters and power meters.

Harmonic mixers can be optimized for either odd or even harmonics of the local oscillator (LO). They can also be produced to operate on all harmonics, even or odd. Series QMH harmonic mixers have a common SMA port for LO and IF signals, and hence require an external diplexer. Those mixers can be supplied with external diplexers to combine/separate LO and IF signals. Several choices of LO & IF ranges are offered as standard products. Typical LO ranges from 1.5 GHz to 20 GHz and IF from DC to 2.5 GHz.

### Specifications

FREQUENCY BAND	K	Ka	Q	U	V	E	W	F	D
Frequency Range (GHz)	18-26.5	26.5-40	33-50	40-60	50-75	60-90	75-110	90-140	110-170
Waveguide Size	WR-42	WR-28	WR-22	WR-19	WR-15	WR-12	WR-10	WR-8	WR-6
Conversion Loss (dB typ) <sup>1</sup>	20	22	24	26	28	30	32	35	37

Other waveguide sizes are available.

<sup>1</sup> For 9th harmonic of LO, IF < 1 GHz. Typical LO power range is 7 to 14 dBm.

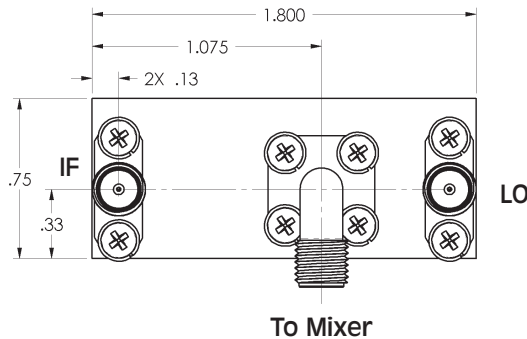

Diplexer Outline

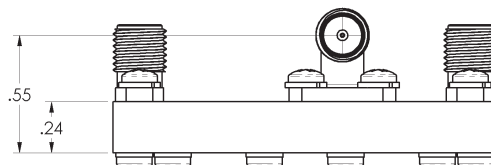



### Outline Drawings/Mechanical Specifications

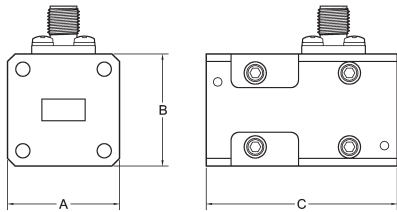

WR-42 and WR-28

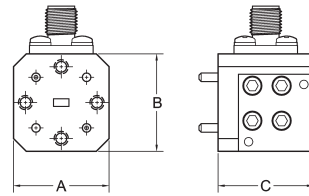

WR-22 through WR-10

FREQUENCY BAND	WAVEGUIDE SIZE	FLANGE PATTERN	LO AND IF	OUTLINE DIMENSIONS, inches/mm <sup>1</sup>		
				A	B	C
K	WR-42	UG-595/U	SMA JACK	0.88/22.4	0.88/22.4	1.5/38.1
Ka	WR-28	UG-599/U	SMA JACK	0.75/19.1	0.75/19.1	1.5/38.1
Q	WR-22	UG-383/U	SMA JACK	1.13/28.7	1.13/28.7	1.25/31.75
U	WR-19	UG-383/U	SMA JACK	1.13/28.7	1.13/28.7	1.25/31.75
V	WR-15	UG-385/U	SMA JACK	0.75/19.1	0.75/19.1	0.75/19.1
E	WR-12	UG-387/U	SMA JACK	0.75/19.1	0.75/19.1	0.75/19.1
W	WR-10	UG-387/U	SMA JACK	0.75/19.1	0.75/19.1	0.75/19.1

### Ordering Information

**Model Number QMH -** **AB CD E F GH** Please specify exact RF and LO/IF frequency range when ordering.

**RF center frequency rounded to nearest GHz** (1A = 100-109 GHz, 1B = 110-119 GHz, etc; FB = fullband)

**LO frequency rounded to nearest GHz** (If not fixed or defined, use XX)

**harmonic number**  
 O = odd  
 E = even  
 B = both

**diplexer option**  
 00 = no diplexer provided (customer to provide)  
 D1 = diplexer provided IF = DC-1 GHz, LO = 18 to 7.5 GHz  
 D2 = diplexer provided IF = DC-1 GHz, LO = 5 to 20 GHz  
 D3 = diplexer provided IF = DC-2.5 GHz, LO = 5 to 20 GHz

**waveguide band designator**  
 K = K-band      E = E-band  
 A = Ka-band    W = W-band  
 Q = Q-band      F = F-band  
 U = U-band      D = D-band  
 V = V-band



# Spectrum Analyzer Mixers and Diplexers

QMA

## Characteristics

- ◆ Extends Spectrum Analyzer Frequency Range
- ◆ High Sensitivity
- ◆ Compatible with Many Popular Spectrum Analyzer Models

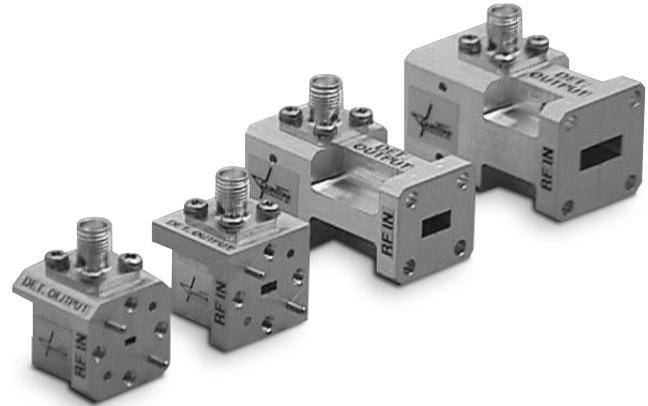

## Product Description

QuinStar Technology's **QMA** series of **spectrum analyzer mixers** facilitate the display and measurement of millimeter-wave signals using lower frequency (microwave) local oscillator signals. They cover the frequency range of 18 to 110 GHz in seven waveguide bands. These mixers are designed to operate with many popular spectrum analyzer models that have local oscillator outputs and IF inputs.

For spectrum analyzers with separate LO output and IF input ports, an optional diplexer that combines the LO and IF signals is available from QuinStar. Spectrum analyzers with built-in diplexers, such as the HP8555A, HP8565A, HP8569A, Tektronix 7L18 and Tektronix 492, do not require the diplexer option. However, the diplexer option is required for spectrum analyzers without built-in diplexers such as the HP8566A/B, HP8569B and Anritsu 710.

## Specifications

FREQUENCY BAND	K	Ka	Q	U	V	E	W
Frequency Range (GHz)	18-26.5	26.5-40	33-50	40-60	50-75	60-90	75-110
Waveguide Size	WR-42	WR-28	WR-22	WR-19	WR-15	WR-12	WR-10
Min. Detectable Signal in 1 kHz Bandwidth (dBm typ)	-110	-110	-105	-100	-95	-90	-85

Other waveguide sizes are available.

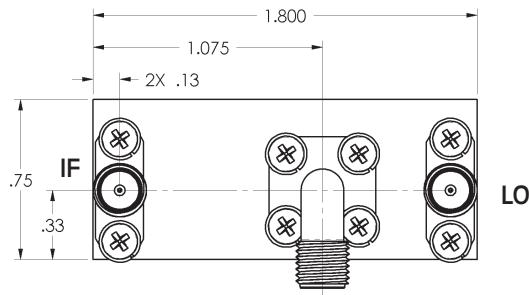

Diplexer Outline

To Mixer

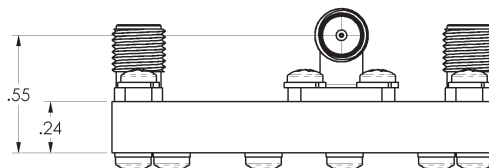



# Spectrum Analyzer Mixers and Diplexers

QMA

## Outline Drawings/Mechanical Specifications

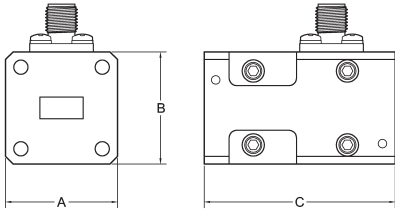

WR-42 and WR-28

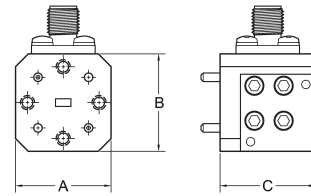

WR-22 through WR-10

FREQUENCY BAND	WAVEGUIDE SIZE	FLANGE PATTERN	LO AND IF	OUTLINE DIMENSIONS, inches/mm <sup>1</sup>		
				A	B	C
K	WR-42	UG-595/U	SMA JACK	0.88/22.4	0.88/22.4	1.5/38.1
Ka	WR-28	UG-599/U	SMA JACK	0.75/19.1	0.75/19.1	1.5/38.1
Q	WR-22	UG-383/U	SMA JACK	1.13/28.7	1.13/28.7	1.25/31.75
U	WR-19	UG-383/U	SMA JACK	1.13/28.7	1.13/28.7	1.25/31.75
V	WR-15	UG-385/U	SMA JACK	0.75/19.1	0.75/19.1	0.75/19.1
E	WR-12	UG-387/U	SMA JACK	0.75/19.1	0.75/19.1	0.75/19.1
W	WR-10	UG-387/U	SMA JACK	0.75/19.1	0.75/19.1	0.75/19.1

<sup>1</sup> Dimensions do not include diplexer option.

## Ordering Information

Model Number **QMA - A B C 000**

waveguide band designator

- K = K-band
- A = Ka-band
- Q = Q-band
- U = U-band
- V = V-band
- E = E-band
- W = W-band

diplexer option

- 0 = no diplexer provided by QuinStar
- D = with diplexer provided by QuinStar

polarity \*

- P = positive
- N = negative

\* Mixer bias voltage with respect to case.

## Characteristics

- ◆ General Purpose
- ◆ Broad or Narrowband
- ◆ Low Cost/Moderate Performance

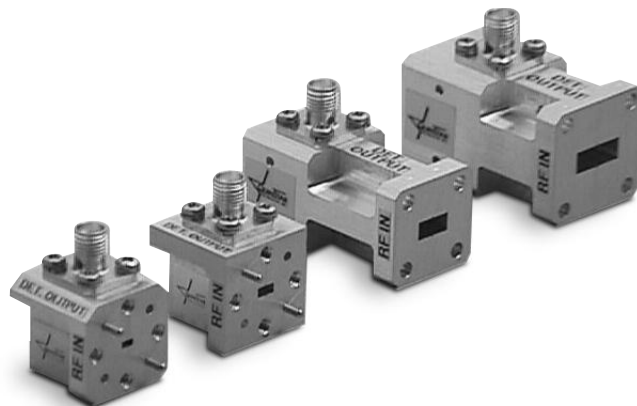

## Product Description

QuinStar Technology's **QMS** series **single ended mixers** are available in either narrowband or broadband fixed tuned configurations. The narrowband mixers are tuned for optimum performance at a specified frequency and have lower conversion loss. The broadband mixers are tuned for operation over a full waveguide band. Both versions are offered in waveguide bands from 18 to 110 GHz, utilize a single diode and have a common RF/LO input port (no diplexer).

Single ended mixers are well suited for general laboratory test setups that require conversion of millimeter-wave signals to IF signals. For applications requiring better LO to RF isolation or lower conversion loss, refer to QMB series balanced mixers. For other applications harmonic mixers (series QMH), spectrum analyzer mixers (series QMA) and upconverters (series QMU) are available.

## Specifications

FREQUENCY BAND		K	Ka	Q	U	V	E	W
Frequency Range (GHz)		18-26.5	26.5-40	33-50	40-60	50-75	60-90	75-110
Waveguide Size		WR-42	WR-28	WR-22	WR-19	WR-15	WR-12	WR-10
Conversion Loss (dB max)	Narrowband	6.0	6.0	6.5	6.5	7.0	7.5	8.0
	Broadband	10.0	10.0	10.5	11.0	11.0	11.5	11.5
Bandwidth	Narrowband	20% of waveguide band						
	Broadband	Full waveguide band						
Maximum CW RF Power (LO and Signal, mW)		100						
LO Input Power (dBm typ)		13						

Other waveguide sizes are available.

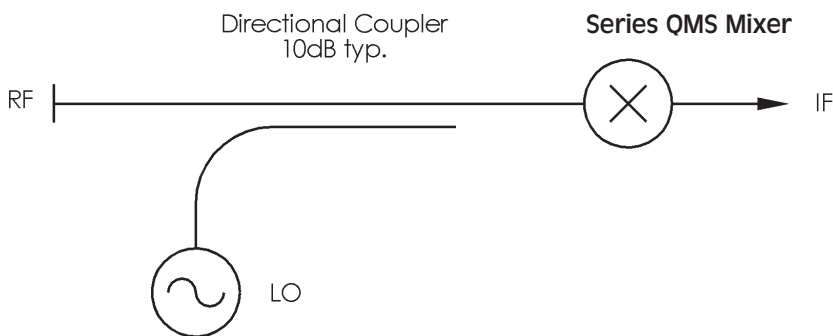

**Typical Application**

## Outline Drawings/Mechanical Specifications

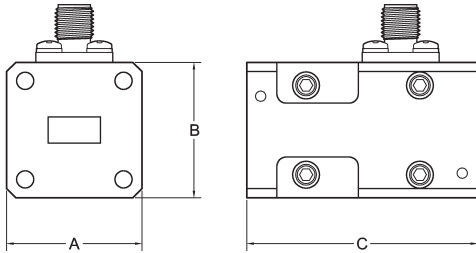

WR-42 and WR-28

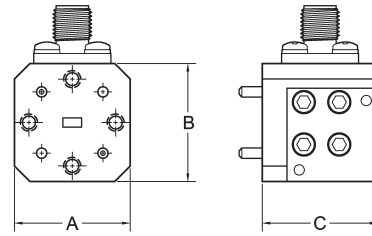

WR-22 through WR-10

FREQUENCY BAND	WAVEGUIDE SIZE	FLANGE PATTERN	IF	OUTLINE DIMENSIONS, inches/mm		
				A	B	C
K	WR-42	UG-595/U	SMA JACK	0.88/22.4	0.88/22.4	1.5/38.1
Ka	WR-28	UG-599/U	SMA JACK	0.75/19.1	0.75/19.1	1.5/38.1
Q	WR-22	UG-383/U	SMA JACK	1.13/28.7	1.13/28.7	1.25/31.75
U	WR-19	UG-383/U	SMA JACK	1.13/28.7	1.13/28.7	1.25/31.75
V	WR-15	UG-385/U	SMA JACK	0.75/19.1	0.75/19.1	0.75/19.1
E	WR-12	UG-387/U	SMA JACK	0.75/19.1	0.75/19.1	0.75/19.1
W	WR-10	UG-387/U	SMA JACK	0.75/19.1	0.75/19.1	0.75/19.1

## Ordering Information

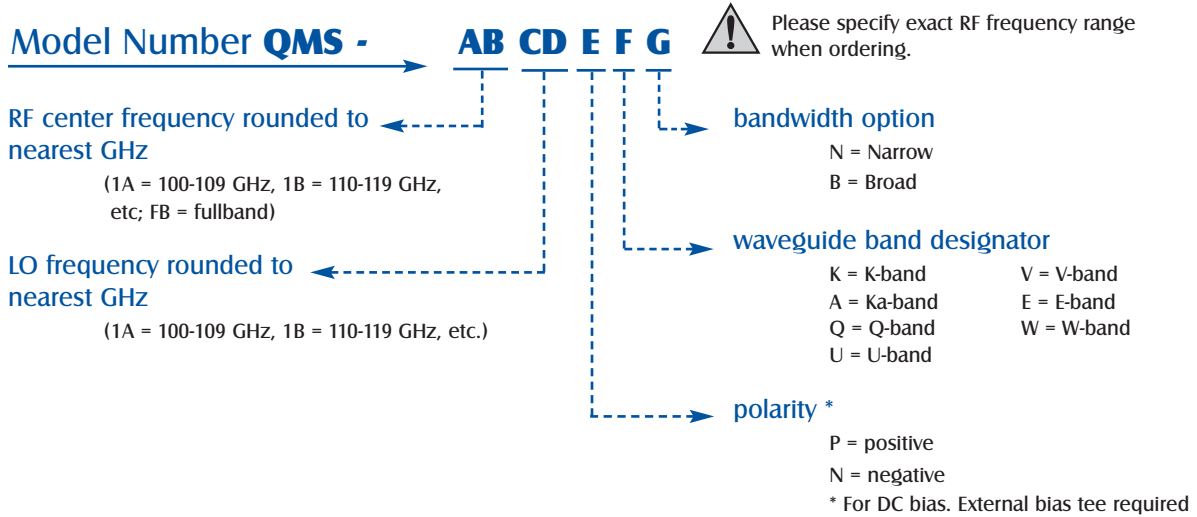

### Characteristics

- ◆ Full Waveguide Band Coverage
- ◆ Low Conversion Loss
- ◆ High LO to RF Isolation
- ◆ Variety of IF Bands



### Product Description

QuinStar Technology's **QMB** series **balanced mixers** enable millimeter-wave signals to be down converted to broad IF bandwidths with a local oscillator. They are available for RF over 18-110 GHz in seven waveguide bands and operate over very broad RF, LO and IF bandwidths. For fixed LO frequency applications, a very wide IF range may

be provided if desired. The local oscillator waveguide port may be in either the same waveguide band as RF waveguide port, or in lower or higher waveguide bands (the two adjacent bands). For IF above 18 GHz, a K-connector is provided on the IF port.

### Specifications

RF Waveguide Band		Multi-Octave	K	—	Ka	Q	U	V	E	W
RF Frequency Range (GHz)		18-40	18-26.5	22-33	26.5-40	23-50	40-60	50-75	60-90	75-110
RF Port Designation		WRD-180	WR-42	WR34	WR-28	WR-22	WR-19	WR-15	WR-12	WR-10
LO Port Options		WR-22	WR-42	WR-42	WR-28	WR-22	WR-19	WR-15	WR-12	WR-10
		WR-28	SMA	WR-34	WR-22	WR-28	WR-22	WR-19	WR-15	WR-12
		K-Connector		K-Conn.	K-Conn.	WR-19	WR-15	WR-12	WR-10	WR-15
										WR-08
IF Range and Conversion Loss	IF Range (GHz)	0-5	0-5	0-5	0-5	0-5	0-5	0-5	0-5	0-5
	Conversion Loss (dB)	6.0	5.5	5.5	5.5	5.5	5.5	5.5	5.5	5.5
	IF Range (GHz)	5-17	5-12	5-12	5-14	5-17	5-20	5-25	5-30	5-35
	Conversion Loss (dB)	8.0	6.5	6.5	6.5	6.5	7.0	7.5	7.5	7.5
	IF Range (GHz)						18-40	18-40	18-40	18-40
	Conversion Loss (dB)						8.0	8.0	8.0	8.0

**NOTES:**

- 1 Local oscillators (LO) drive level required is 11.0 dBm minimum, 13 dBm typical (nominal) and 17 dBm max.
- 2 LO to RF isolation is typical 20 dB.
- 3 LO to IF isolation is 40 dB typical for LO above RF range and is 20 dB min. for LO below the RF range.

### Outline Drawings/Mechanical Specifications

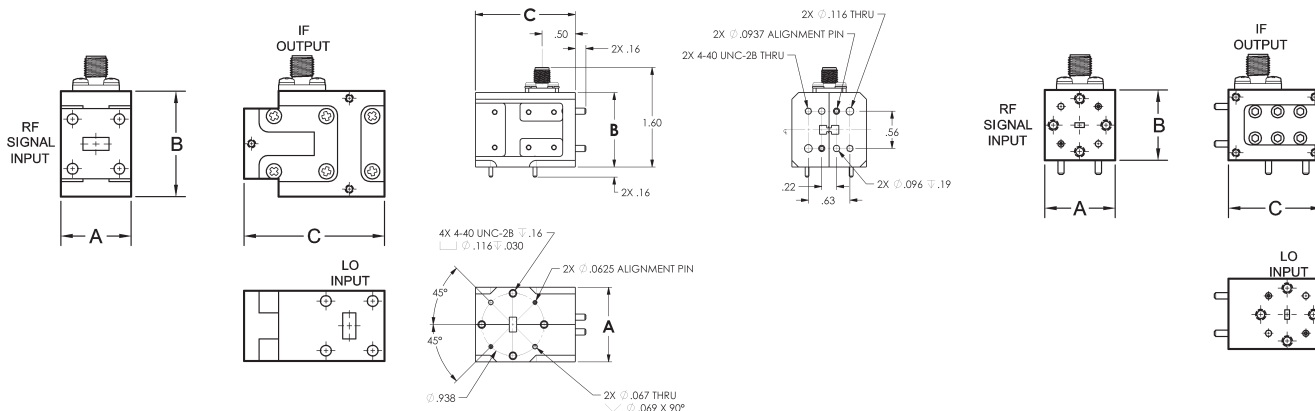

WR-42 and WR-28

WRD-180

WR-22 through WR-10

FREQUENCY BAND	WAVEGUIDE SIZE	FLANGE PATTERN	IF OUTPUT	OUTLINE DIMENSIONS, inches/mm		
				A	B	C
WRD-180	WRD-180	—	SMA JACK	1.12/28.5	1.12/28.5	1.50/29.2
K	WR-42	UG-595/U	SMA JACK	0.88/22.4	1.19/30.2	1.89/48.0
Ka	WR-28	UG-599/U	SMA JACK	0.75/19.1	1.19/30.2	1.20/30.5
Q	WR-22	UG-383/U	SMA JACK	1.13/28.7	1.13/28.7	1.20/30.5
U	WR-19	UG-383/U	SMA JACK	1.13/28.7	1.13/28.7	1.20/30.5
V	WR-15	UG-385/U	SMA JACK	0.75/19.1	0.75/19.1	1.00/25.4
E	WR-12	UG-387/U	SMA JACK	0.75/19.1	0.75/19.1	1.00/25.4
W	WR-10	UG-387/U	SMA JACK	0.75/19.1	0.75/19.1	1.00/25.4

### Ordering Information

Model Number **QMB -**

**AB CD E F**



Please specify RF, IF and LO frequencies when ordering.

RF center frequency rounded to nearest GHz

(1A = 100-109 GHz, FB = fullband)

LO frequency rounded to nearest GHz

1A = 100-109 GHz,  
BB = Broadband

local oscillator waveguide band

S = same waveguide band as RF  
L = lower waveguide band (next below RF)  
U = upper waveguide band (next above RF)  
C = coaxial LO input  
Z = custom

waveguide band designator

K = K-band                      V = V-band  
A = Ka-band                    E = E-band  
R = WRD-180                 W = W-band  
Q = Q-band  
U = U-band

## Characteristics

- ◆ Customized RF Bandwidth
- ◆ Low Conversion Loss
- ◆ High Output Power
- ◆ Integral Filter for SSB

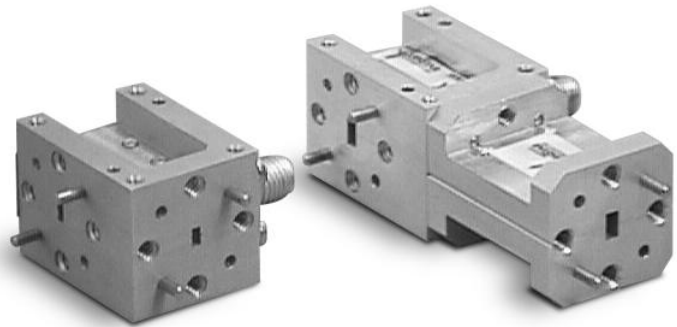

## Product Description

QuinStar Technology's QMU series **upconverters** cover the frequency range of 18 to 110 GHz in seven waveguide bands. These upconverters have a balanced mixer configuration for high LO to RF isolation. They are constructed with a rugged, split-block mechanical design that utilizes GaAs beam-lead Schottky barrier diodes.

The upconverter combines LO and IF signals and produces RF output signals at frequencies of their sum and difference, i.e.,  $LO \pm IF$ . An optional integral waveguide

filter is available to produce a single-sideband output signal. Typical IF bandwidth is a few GHz, but wider bandwidth upconverters are available.

Local oscillator waveguide port may be in either the same waveguide band as RF waveguide port, or in a lower or higher waveguide band (the two adjacent bands), depending on LO frequency. The upconverter can supply several milliwatts of single-sideband output power with the proper input power levels.

## Specifications

FREQUENCY BAND	K	Ka	Q	U	V	E	W
Frequency Range (GHz)	18-26.5	26.5-40	33-50	40-60	50-75	60-90	75-110
Conversion Loss (dB typ)	6-8	6-8	6-8	6-8	7-9	7-9	7-9
RF Output Power (dBm Sat. SSB)	4	4	4	4	4	3	3
Bandwidth (GHz typ) <sup>1</sup>	0.5-8.0	0.5-8.0	0.5-8.0	0.5-8.0	0.5-10.0	0.5-10.0	0.5-10.0
IF for SSB (GHz typ)	1-4	1-4	1-4	1-4	1-5	1-5	1-5
LO Input Power (dBm typ/min)	17/13	17/13	17/13	17/13	17/13	17/13	17/13
Maximum IF input Power (dBm) <sup>2</sup>	17	17	17	17	17	17	17
LO plus IF Power (dBm max)	20	20	20	20	20	20	20
LO to RF Isolation (dB typ)	30	30	30	30	30	30	30
LO to IF Isolation (dB typ)	35	35	35	35	35	35	35

Other waveguide sizes are available.

As specifications are dependent on application-specific configurations, typical ranges are tabulated.

<sup>1</sup> Standard product RF/IF bandwidth is typically 2 GHz. Single sideband (SSB) upconverters must have IF band selection consistent with sideband filtering requirements. Contact QuinStar with your exact requirements to obtain an optimal solution.

<sup>2</sup> IF input power range is determined by application requirements, intermod and linearity considerations. Compression and saturation occur at high IF power levels.

**Outline Drawings/Mechanical Specifications**

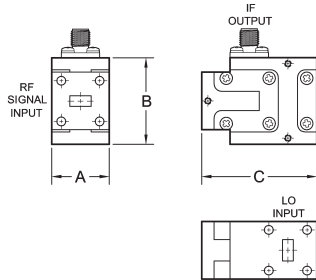

WR-42 and WR-28

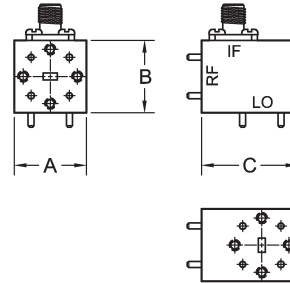

WR-22 through WR-10

Double sideband version (without SSB filter)

FREQUENCY BAND	WAVEGUIDE SIZE	FLANGE PATTERN	BIAS INPUT	OUTLINE DIMENSIONS, inches/mm		
				A	B	C
K	WR-42	UG-595/U	SMA JACK	0.88/22.4	1.19/30.2	1.89/48.0
Ka	WR-28	UG-599/U	SMA JACK	0.75/19.1	1.19/30.2	1.20/30.5
Q	WR-22	UG-383/U	SMA JACK	1.13/28.7	1.13/28.7	1.20/30.5
U	WR-19	UG-383/U	SMA JACK	1.13/28.7	1.13/28.7	1.20/30.5
V	WR-15	UG-385/U	SMA JACK	0.75/19.1	0.75/19.1	1.00/25.4
E	WR-12	UG-387/U	SMA JACK	0.75/19.1	0.75/19.1	1.00/25.4
W	WR-10	UG-387/U	SMA JACK	0.75/19.1	0.75/19.1	1.00/25.4

Note: Filter dimensions for single sideband upconverters available upon request. Please see series QFB for approximate size.

**Ordering Information**

**Model Number QMU -** **AB CD E F** Please specify exact RF, IF and LO frequencies when ordering.

RF center frequency rounded to nearest GHz  
(1A = 100-109 GHz, FB = fullband)

LO frequency rounded to nearest GHz  
(1A = 100-109 GHz)

options

D = double sideband  
 S = single sideband (filter included please specify exact sideband and LO filtering requirements)  
 Z = custom

waveguide band designator

K = K-band      V = V-band  
 A = Ka-band    E = E-band  
 Q = Q-band      W = W-band  
 U = U-band



### Characteristics

- ◆ Covers 18-40 GHz RF Band
- ◆ Exceptionally Low Conversion Loss
- ◆ Broad LO Range

### Product Description

QuinStar Technology series QMC coaxial mixers operate over the full 18-40 GHz RF band with typically 15 GHz of local oscillator bandwidth in the 25 to 60 GHz range. These mixers offer a very broad IF range, typically extending from 0.1 to 20 GHz. The RF and IF ports have coaxial connectors. Series QMC coaxial mixers are characterized by a low conversion loss (typically 5 to 7 dB) and relatively flat frequency response over a wide range of LO, RF and IF frequencies making them ideal for EW, ESM and

instrumentation or test equipment applications. Integral IF amplifier can be provided as an option.

QuinStar can customize these mixers to suit the performance requirements and frequency ranges applicable to a broad range of wideband receivers and downconverters. Please contact QuinStar with your specifications.

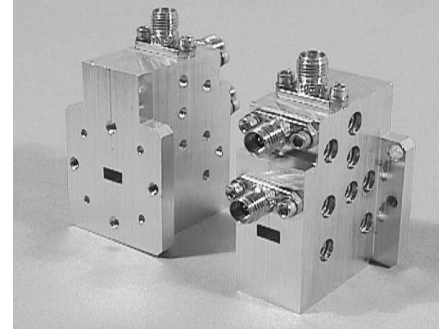

### Typical Performance

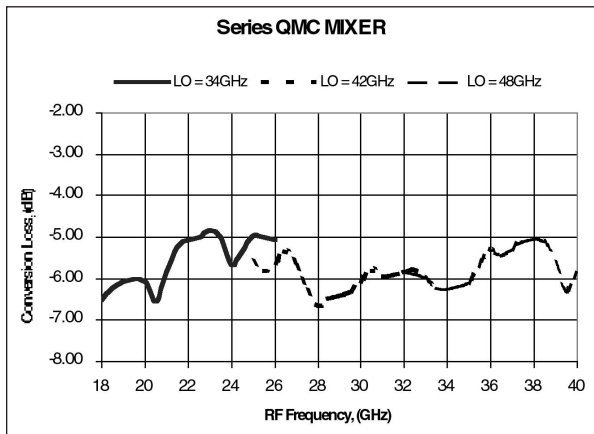

RF Range	18-40 GHz min.
IF Range	0.1-20 GHz
LO Range	25-60 GHz
LO Bandwidth	15 GHz typ.
LO Port	Waveguide or coaxial
RF and IF Ports	Coaxial
Conversion loss	5 to 7dB typical

### Ordering Information

Model Number **QMC -** **AB CD EFG**

RF minimum frequency, in GHz

RF maximum frequency, in GHz

assigned to denote customer specific requirements



**Characteristics**

- ◆ Second and Third Harmonic of LO
- ◆ Low Conversion Loss

**Product Description**

QuinStar Series QHS mixers operate at second or third harmonic of the Local Oscillator frequency with a low conversion loss. Hence, the LO frequency is either one half or one third of the RF signal in the applicable waveguide band. These mixers offer the advantage of a relatively low frequency Local Oscillator (compared to a fundamental mixer) while providing a reasonably low conversion loss and/or noise figure, typically between 9 and 15 dB. They generally operate over full waveguide RF band, and over a considerable broad LO frequency range and wide IF range. These mixers are particularly suited for applications that employ a millimeter wave low-noise amplifier (LNA) at the front end of the receiver, thus establishing a low noise figure, which is not significantly influenced by the conversion loss of the mixer that follows. Subharmonic Local Oscillators are significantly lower in cost, and can be

more readily implemented using lower frequency sources. Typical subharmonic LO power is 10-15 dBm.

QuinStar provides an external diplexer as an integral part of the Series QHS mixers. However, QuinStar can provide customized configuration to suit specific needs. These mixers may be optimized over a narrow RF range and fixed LO to achieve better conversion loss. QuinStar can also produce mixers at higher frequencies (beyond 110 GHz) for high frequency subharmonic LO receivers.

QuinStar series QHS mixers find numerous applications in frequency extenders, broadband receivers, test equipment and instrumentation, EW receivers, and MMW communication links.

**Specifications**

Model Number	QHS-V2	QHS-V3	QHS-E2	QHS-E3	QHS-W2	QHS-W3
Waveguide Band	WR-15	WR-15	WR-12	WR-12	WR-10	WR-10
RF Frequency Range <sup>1</sup> , GHz	50-75	50-75	60-90	60-90	75-110	75-110
LO Frequency Range <sup>2</sup> , GHz	25-37.5	16.7-25	30-45	20-30	37.5-55	25-36.7
Harmonic Number <sup>1</sup>	2	3	2	3	2	3
Conversion Loss, dB	9-15	10-17	9-15	10-17	9-16	10-18
IF Range <sup>3</sup> , GHz	0.1 to 4 GHz					

<sup>1</sup> Other harmonic numbers and RF ranges are possible. Please contact QuinStar with your exact requirements.

<sup>2</sup> Typical LO power required is between 10 and 15 dBm. Conversion loss has some dependence on LO power level.

<sup>3</sup> Higher IF frequency offered as an option.

**Ordering Information**

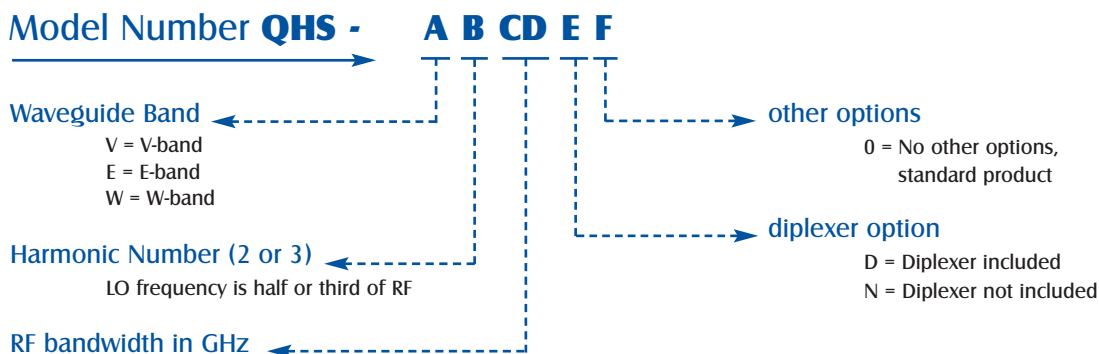



# Custom Mixer Products Capability

## Active Mixers/Receivers

QAM

### Product Description

QuinStar offers Active Mixers/Receivers based on a integrated combination of millimeter wave Low Noise Amplifiers (LNA) and state of the art planar mixers, and optional IF amplifiers. Figure 1 below shows the general configuration of this type of products. They are offered in highly integrated compact outlines and packages. These mixers are available over 18-110 GHz RF frequency range in

all standard waveguide bands as well as with coaxial interface connectors. These receiver modules are particularly suited for larger quantity production of communication systems, MMW radars and other low noise receivers. Products are customized to suit customer's specific needs. Please contact QuinStar with your specific requirements.

FIGURE 1

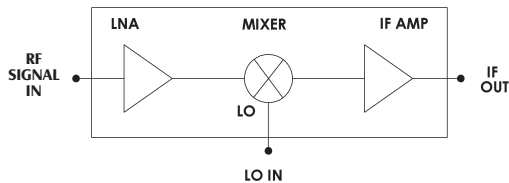

Figure 1: Typical Active Mixer/Receiver Architecture. The mixer can be configured as standard balanced, single sideband, or image reject type with either fundamental or sub-harmonic local oscillator (LO at half RF frequency)

### Product Description

QuinStar provides a series of coaxial mixers operating over specific RF and LO ranges in the 8 to 65 GHz frequency range. These typically operate over very broad frequency ranges with reasonable performance in terms of conversion loss and IF bandwidth. A wide selection of RF, LO and IF bandwidths are available for these mixers.

## Coaxial Mixers

QCM

Sub-harmonic local oscillator (LO) operation is also offered for these mixers. In addition to standard coaxial mixer products, QuinStar also offers products that are customized to meet application-specific performance requirements.



# Image-Reject and Single Sideband Mixers

## Single-Sideband Upconverters

QSM

### Product Description

QuinStar offers Image-Reject or Single Sideband Mixers/Upconverters for applications in the 18-110 GHz frequency range. These mixers are specially designed and configured to meet specific performance needs of customer's application. The construction of image reject and single sideband mixers involves a pair of balanced mixers and a set of hybrids for RF, LO and IF to create the

required performance. Figure 2 below shows various possible arrangements. These mixers can be offered with either fundamental or sub-harmonic LO (LO at half RF frequency). QuinStar can test and optimize the component assembly to meet the required specifications for these special purpose mixers.

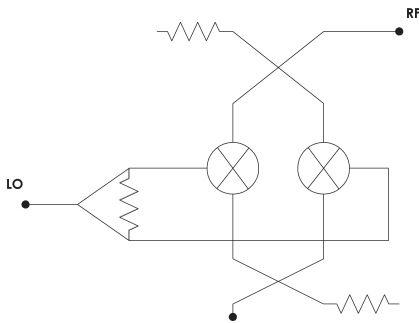

Figure 2: Single Sideband and Image-Reject Mixers and Upconverters.

### Product Description

QuinStar offers millimeter wave IQ detectors over the frequency range of 18-110 GHz for radar and digital communication systems. Figure 3 below shows the configuration of the components used to produce the

I-Q detectors. These are custom-designed, tested and optimized to meet customer's specific performance needs.

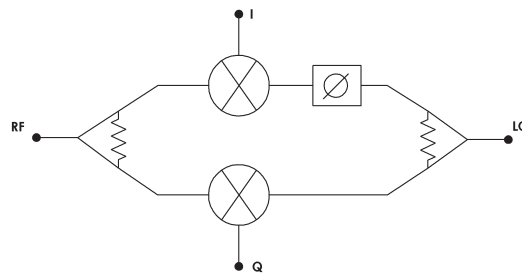

Figure 3: Mixer with I-Q output

## I-Q Mixer

QMI

### Product Description

QuinStar Series QBP phase modulators are specially optimized to generate bi-phase modulated output for digital signal input. A driver that converts the input digital data to appropriate drive levels for bi-phase modulation

(with suppressed carrier) is also included with the mixer. Both fundamental and second harmonic (LO at one half of output RF frequency) Bi-phase modulators are offered.

## Bi-phase Modulator

QBP



## Section 3

# Sources and Frequency Multipliers

Product Title	Model No.	Page Number
<b>Sources and Frequency Multipliers</b>		59
Application Notes		60
Mechanically-Tunable Gunn Oscillators	<b>QTM</b>	62
Varactor-Tunable Gunn Oscillators	<b>QTV</b>	64
Gunn Regulators/Modulators	<b>QCR</b>	66
High Power IMPATT Oscillators	<b>QIO</b>	67
High Power IMPATT Diodes	<b>QID</b>	68
Stable Millimeter Wave Sources	<b>QSO</b>	70
Phase Locked Oscillators	<b>QPL</b>	71
Active Frequency Multipliers	<b>QMM</b>	72
Passive Frequency Multipliers	<b>QPM</b>	74
Noise Sources	<b>QNS</b>	76
Frequency Extenders	<b>QBE</b>	78

## Application Notes

**AFC (Automatic Frequency Control)** -Voltage tunability allows the user to provide an analog voltage input to the oscillator to provide "correction" tuning. This input may also be used with an external phase-locked circuit with digital inputs.

**Fixed tuning** – This type of oscillator provides a single output frequency to agreed-upon specifications. In some models, a fine tune adjustment is provided for long-term readjustment due to aging characteristics and frequency drift. The fixed tuned oscillator gives the best performance with respect to temperature stability, microphonic induced FM noise, and overall efficiency.

**Frequency stability with temperature** – The frequency drift of an oscillator with change in temperature (MHz/\_C) is a measure of its frequency stability. Various frequency stabilization techniques are provided and relate to the absolute frequency required and tuning options selected. The frequency stability of a free-running oscillator is determined by the Q of the cavity and the temperature characteristics of the materials used in the design.

**FM noise** – A.) Residual FM Noise, B.) SSB Phase Noise or C.) Phase Jitter. FM noise requirement is expressed in terms of either a total signal-to-noise ratio measured in a given bandwidth centered at some offset from the signal frequency of a signal sideband or the phase-noise-to-signal ratio per Hz bandwidth specified over a wide range of offset frequencies. Typical free-running and phase-locked noise characteristics are shown in oscillator and amplifier product capability section.

**Harmonic suppression** – The measured rejection of unwanted signals which are harmonically related to the output frequency. Measured in dBc (dB below carrier level). Harmonic band pass or low pass output filters may be added as options, if required.

**Load pulling** – Frequency pulling is the amount of frequency change as a result of change in load VSWR or phase angle associated with the VSWR. It is a measure of stability of the oscillator with external load, and is determined by the Q of the oscillator. An isolator in front of the oscillator significantly reduces load pulling, and hence, enhances the stability with load variation. Generally, all oscillators are designed to work into a load VSWR of up to 1.5:1 max., any phase. If load VSWR is greater, a load isolator should be specified.

**Mechanical tuning** – Most of the oscillator types are available with some type of mechanical tuning. Tuning types available are: (1) micrometer tuning, (2) recessed screwdriver-tuning shaft, accessible from outside of unit. All mechanical tuning methods may degrade the frequency stability, noise and microphonic performance used in the tuning mechanism. The amount of degradation depends upon the type of tuner used, the precision of tolerance, and the level of mechanical vibration and/or shock.

**Modulation rate** – The rate at which the output frequency can be modulated with an input modulation signal. The frequency tuning mechanism (voltage tuned oscillator, bias-tunable versus varactor-tunable) has a major impact on maximum modulation rate achievable.

**Phase-locked oscillator** - The output signal stability is directly related to the stability of the reference signal. The

reference signal may be external to the oscillator, or an internal crystal oscillator reference may be provided.

**Power stability vs. temperature** – The output RF power of an oscillator can vary relative to input voltage, load VSWR, temperature changes, and as a result of tuning. The change in output power only due to temperature is generally expressed in dB/deg.C, and ranges between 0.01 to 0.05 dB/deg C.

**Pushing** – Frequency pushing is the amount of frequency change proportional to change in input voltage, usually expressed in (MHz/Volt).

**Spurious responses** – Spurious frequencies are unwanted signals present at the oscillator output as a result of harmonics bias supply, phase-locked circuits, or undesirable internally generated frequencies. Spurious response is usually specified in terms of dBc (dB below output carrier).

**Tuning resolution** – The absolute instantaneous frequency to which an oscillator may be tuned or set.

**Tuning range** – Oscillators can be tuned in a number of ways: (1) fixed, (2) mechanical, (3) analog voltage (AFC), (4) digital (phaselocked types). See definitions on this page for individual tuning types.

**Voltage tuning** – Several models of oscillators are provided with a voltage tuning option. The maximum amount of voltage tuning available depends on center frequency and output power. Tuning can be achieved either through a varactor or by varying the diode bias voltage. For AFC (Automatic Frequency Control) applications, the voltage tuning provided must be wider than the free-running temperature stability of the oscillator. The effect of varactor tuning on noise or the temperature stability varies proportionally to the frequency tuning range specified.

### Glossary of Multiplier Terminology

**Bandwidth** – Frequency range over which the specifications of minimum output power will be met for a given input power level. In some cases a 3 dB bandwidth is specified, denoting the minimum frequency range over which power drops by half (3 dB) of a given fixed input power level.

**Cascading** – Arranging one multiplier to power a second multiplier for an overall frequency multiplication of the product of the two multipliers. To maintain the bandwidth of both multipliers, an isolator of the same bandwidth must be included between the two cascaded multipliers. For narrow band cascades, however, an isolator may not be necessary.

**Efficiency** – The efficiency of the conversion from the input frequency to the desired harmonic frequency. The ratio of output power to input power under specified conditions. Note that efficiency changes with input power level. Generally expressed as a percentage. Also expressed in dB as conversion loss.

**External bias** – The DC voltage and current necessary for efficient frequency multiplication is provided by a manually adjustable separate biasing box. The ability to change the biasing level of a multiplier extends the input power level range which may be used to efficiently drive the multiplier. Care must be taken whenever an external

bias connection is broken or reconnected to avoid electrostatic discharge (ESD).

**internal bias** – The DC voltage and current necessary for efficient frequency multiplication is provided internally. The voltage which is set for a particular multiplier is set for a particular input power level to that multiplier.

**Integral feedhorn** – The means by which the output power from the multiplier is launched into free space. Integral refers to the feedhorn and transition from a waveguide to feedhorn aperture being machined into the multiplier body, rather than being a separate unit. This reduces the losses associated with waveguide flanges, which can be very high for submillimeter wave connections.

**Resistive multiplier** – A frequency multiplier which predominantly uses the resistance modulation of a diode

for harmonic generation. Resistive multipliers have wider bandwidth, but lower efficiency than varactor multipliers.

**Spurious harmonic content** – The power level at frequencies harmonic to the input, other than the desired harmonic, at the output port of a multiplier. This power level is usually expressed in dB relative to the power level of the desired harmonic frequency, as  $-X$  dBc, i.e., as  $X$  dB below the level of the carrier.

**Varactor multiplier** – A frequency multiplier which predominantly uses the capacitance modulation of a diode for harmonic generation. Varactor multipliers are higher efficiency, but narrower bandwidth than resistive multipliers.

## Millimeter Wave Sources and Subsystems

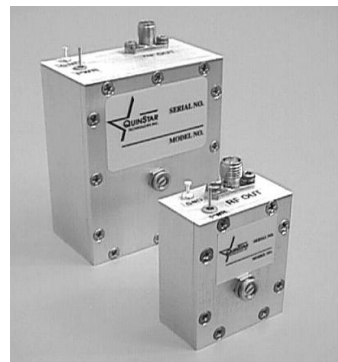
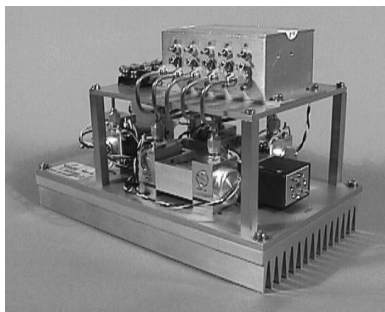
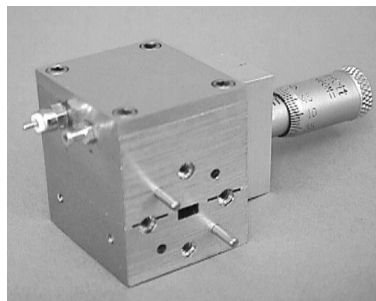
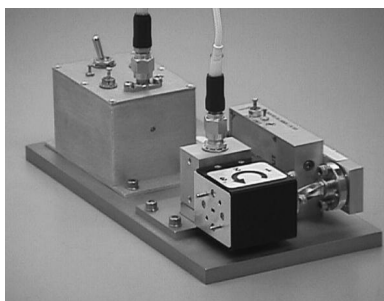
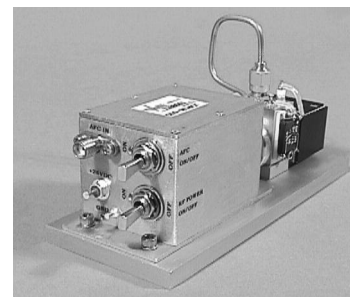
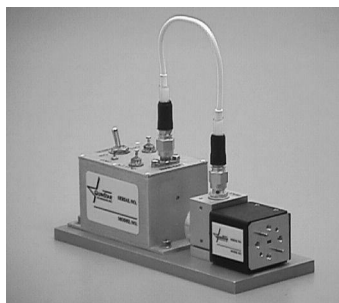
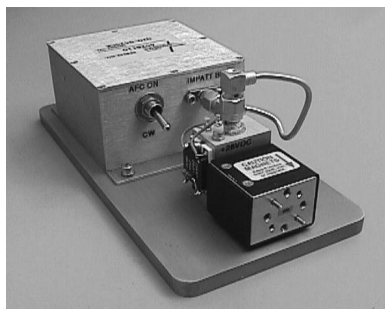



# Mechanically-Tunable Gunn Oscillators

## QTM

### Characteristics

- ◆ High Output Power
- ◆ Excellent Frequency Stability
- ◆ Low AM and FM Noise



### Product Description

QuinStar Technology's **QTM** series of **mechanically-tunable Gunn oscillators** cover the frequency range of 18 to 150 GHz in nine waveguide bands. They combine a high-Q resonant circuit with either a GaAs or InP Gunn diode. Typically, InP diodes are used for high-power applications at the higher frequencies. Each oscillator has an internal low-frequency bias circuit with an oscillation suppression network and over-voltage protection. Standard units are rated over 0 to +50° C operating temperature and incorporate a screw tuner with a reliable self-locking

feature. Gunn oscillators can be provided with broader tuning ranges, higher power levels, micrometer tuners, temperature controlled heaters, integral isolators, voltage regulators, modulators and injection-locking capability.

Series QTM oscillators provide a small bias tuning of operating frequency. Often, bias tuning can be used in place of varactor-tuning (series QTV). Phase-locked oscillators (Series QPL) and injection-locked oscillators (Series QTI) are also available.

### Specifications

FREQUENCY BAND		K	Ka	Q	U	V	E	W	F	D
Frequency Range (GHz)		18-26.5	26.5-40	33-50	40-60	50-75	60-90	75-110	100-140	130-150
Waveguide Size		WR-42	WR-28	WR-22	WR-19	WR-15	WR-12	WR-10	WR-8	WR-6
Output Power Range <sup>1</sup>	(mW)	10-500	10-300	10-250	10-200	10-100	10-80	10-50	1-30	1-20
	(dBm)	10-27	10-25	10-24	10-23	10-20	10-19	10-17	0-15	0-13
DC Bias Voltage Range (typ)	GaAs (volts)	5-8	5-7	5-6	5-6	4-6	3-6	3-6	---	---
	InP (volts)	---	---	6-11	6-10	6-10	8-10	8-10	8-10	8-10
DC Bias Current Range (typ)	GaAs (Amp)	0.6-2.0	0.6-2.6	0.6-2.0	0.6-2.0	0.6-1.5	0.6-1.5	0.6-1.5	---	---
	InP (Amp)	---	---	0.3	0.3	0.3	0.25	0.25	0.25	0.25
Mechanical Tuning Range (GHz) <sup>2</sup>		0.1-4	0.1-5	0.1-5	0.1-5	0.1-5	0.1-8	0.1-10	0.1-2	0.1-2
Frequency Stability (MHz/°C typ)		-1.5	-2.0	-2.5	-3.0	-4.0	-4.0	-5.0	-6.0	-6.0
Power Stability (dB/°C typ)		-0.02	-0.02	-0.03	-0.03	-0.03	-0.03	-0.03	-0.03	-0.03
Operating Temperature		0 to 50°C								

Other waveguide sizes are available.

<sup>1</sup> Higher power outputs are available at selected frequencies.

<sup>2</sup> Standard units have a minimum tuning range of ± 250 MHz. Broader mechanical tuning ranges are available.

## Outline Drawings/Mechanical Specifications

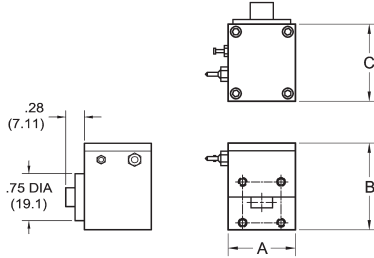

WR-42 and WR-28

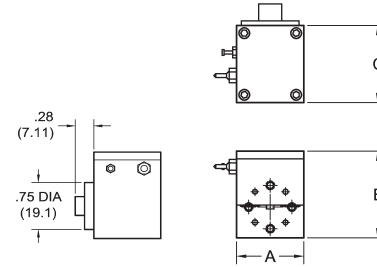

WR-22 through WR-6

FREQUENCY BAND	WAVEGUIDE SIZE	FLANGE PATTERN	OUTLINE DIMENSIONS, inches/mm <sup>1</sup>		
			A	B	C
K	WR-42	UG-595/U	1.13/28.7	1.38/35.1	1.00/25.4
Ka	WR-28	UG-599/U	1.13/28.7	1.38/35.1	1.00/25.4
Q	WR-22	UG-383/U	1.13/28.7	1.38/35.1	1.00/25.4
U	WR-19	UG-383/U	1.13/28.7	1.38/35.1	1.00/25.4
V	WR-15	UG-385/U	0.88/22.4	1.13/28.7	1.00/25.4
E	WR-12	UG-387/U	0.88/22.4	1.13/28.7	1.00/25.4
W	WR-10	UG-387/U	0.88/22.4	1.13/28.7	1.00/25.4
F	WR-8	UG-387/U	0.88/22.4	1.13/28.7	1.00/25.4
D	WR-6	UG-387/U	0.88/22.4	1.13/28.7	1.00/25.4

<sup>1</sup> Consult factory for exact outline dimensions if options are specified.

## Ordering Information

Model Number **QTM -**

**AB CD E F**



Please specify exact center frequency, tuning range and options when ordering.

center frequency (rounded to nearest GHz)

(1A = 100-109 GHz, 1B = 110-119 GHz, etc.)

power output in dBm

options

H = heater \*  
I = isolator \*  
B = heater and isolator \*  
R = compact regulator  
(see Gunn Regulators/Modulators, QCR)  
C = heater, isolator and compact regulator \*

M = micrometer tuner  
A = full feature regulator  
(see Gunn Regulators/Modulators, QCR)  
0 = no option  
S = special combination of preceding options (please specify)  
Z = custom

waveguide band designator

K = K-band  
A = Ka-band  
Q = Q-band  
U = U-band  
V = V-band  
E = E-band  
W = W-band  
F = F-band  
D = D-band

\* Addition of heater and isolator options reduce output power.



# Varactor-Tunable Gunn Oscillators

## QTV

### Characteristics

- ◆ High Output Power
- ◆ Wide Tuning Bandwidth
- ◆ Low Phase Noise
- ◆ Optional Mechanical Tuning Capability

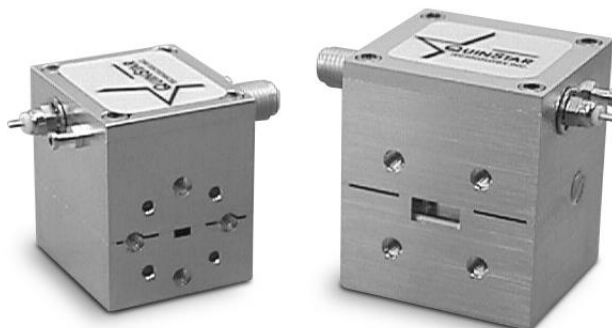

### Product Description

QuinStar Technology's series **QTV varactor-tunable Gunn oscillators** cover the frequency range of 18 to 110 GHz in seven waveguide bands. These oscillators combine proprietary cavity design, abrupt or hyperabrupt tuning varactor diodes and high performance Gunn diodes to produce power in the millimeter wave frequency range. Tuning voltages range from 0 to +30 VDC. The electrical tuning rate may be as high as 50 MHz (20ns per sweep).

Each oscillator has an internal low frequency suppression circuit to ensure stable RF oscillation and over-voltage protection. Mechanical tuning in addition to voltage tuning can be offered as an option. Gunn oscillators can be provided with broader tuning ranges, higher power

levels, temperature controlled heaters, integral isolators and voltage regulators.

These varactor-tunable Gunn oscillators exhibit low AM and FM noise, moderately high output power and wide tuning bandwidth, as well as monotonic tuning characteristics. These characteristics make the oscillator a unique low cost solution for most FM transmitter, local oscillator, AFC loops and phase locked subsystem applications.

For many applications, a bias tuned Gunn oscillator is adequate. Please see mechanically-tunable Gunn oscillators (series QTM) and contact QuinStar for more information.

### Specifications

FREQUENCY BAND		K	Ka	Q	U	V	E	W
Frequency Range (GHz)		18-26.5	26.5-40	33-50	40-60	50-75	60-90	75-110
Waveguide Size		WR-42	WR-28	WR-22	WR-19	WR-15	WR-12	WR-10
Output Power Range <sup>1</sup>	(mW)	10-250	10-200	10-200	10-100	10-100	10-60	10-50
	(dBm)	10-24	10-23	10-23	10-20	10-20	10-18	10-17
DC Bias Voltage Range (typ)	GaAs (volts)	5-8	5-7	5-6	5-6	4-6	3-6	3-6
	InP (volts)			6-11	6-10	6-10	8-10	8-10
DC Bias Current Range (typ)	GaAs (Amp)	0.6-2.0	0.6-2.0	0.6-2.0	0.6-2.0	0.6-1.5	0.6-1.5	0.6-1.5
	InP (Amp)			0.3	0.3	0.3	0.25	0.25
Varactor Tuning Range (MHz) <sup>2</sup>		50-250	50-500	50-500	50-500	50-500	50-500	50-500
Frequency Stability (MHz/°C typ)		-2.0	-3.0	-4.0	-4.0	-5.0	-5.0	-6.0
Power Stability (dB/°C typ)		-0.03	-0.03	-0.04	-0.04	-0.04	-0.04	-0.04
Operating Temperature		0 to 50°C						

Other waveguide sizes are available.

<sup>1</sup> This is the range for standard products within the band. Higher power outputs are available at selected frequencies.

<sup>2</sup> Standard units have a minimum tuning range of  $\pm 150$  MHz. Broader varactor tuning ranges are available.



# Varactor-Tunable Gunn Oscillators

QTV

## Outline Drawings/Mechanical Specifications

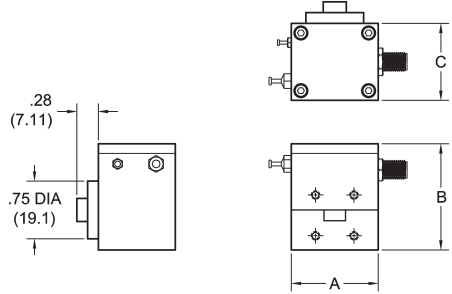

WR-42 and WR-28

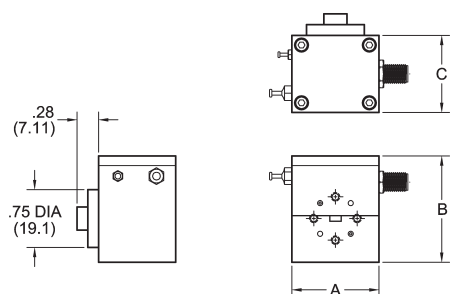

WR-22 through WR-10

FREQUENCY BAND	WAVEGUIDE SIZE	FLANGE PATTERN	OUTLINE DIMENSIONS, inches/mm <sup>1</sup>		
			A	B	C
K	WR-42	UG-595/U	1.13/28.7	1.38/35.1	1.00/25.4
Ka	WR-28	UG-599/U	1.13/28.7	1.38/35.1	1.00/25.4
Q	WR-22	UG-383/U	1.13/28.7	1.38/35.1	1.00/25.4
U	WR-19	UG-383/U	1.13/28.7	1.38/35.1	1.00/25.4
V	WR-15	UG-385/U	0.88/22.4	1.13/28.7	1.00/25.4
E	WR-12	UG-387/U	0.88/22.4	1.13/28.7	1.00/25.4
W	WR-10	UG-387/U	0.88/22.4	1.13/28.7	1.00/25.4

<sup>1</sup> Consult factory for exact outline dimensions if options are specified.

## Ordering Information

**Model Number QTV -** **AB CD E F**

**center frequency rounded to nearest GHz**  
(1A = 100-109 GHz, 1B = 110-119 GHz, etc.)

**power output in dBm**

**options**

**waveguide band designator**

**Please specify exact center frequency, tuning range and options when ordering.**

K = K-band      V = V-band  
 A = Ka-band      E = E-band  
 Q = Q-band      W = W-band  
 U = U-band

H = heater \*      A = full feature regulator (see page 32)  
 I = isolator \*      0 = no option  
 B = heater and isolator \*      S = special combination of preceding options (please specify)  
 R = compact regulator (see page 32)      Z = custom  
 C = heater, isolator and compact regulator \*  
 M = micrometer tuner

\* Addition of heater and isolator options reduce output power.



# Gunn Regulators/Modulators

## QCR

### Characteristics

- ◆ Low Noise/Low Ripple
- ◆ Adjustable Output
- ◆ Source Locking Capability

### Product Description

QuinStar Technology's **QCR** series **Gunn regulators** are available in three configurations. The **Basic Compact regulator** is available with and without AM or FM modulation capability. **Modulator Version** includes both AM and FM capability. The **Full Feature Version** offers numerous options, including AM/FM modulation. All versions provide a low noise, low ripple, constant voltage output at a maximum of 2 Amps for bias control. They also have short circuit and over-voltage/over-current protection to prevent oscillator destruction by inadvertent application of a high voltage or current to which Gunn oscillators are

very sensitive. These regulator features are important for optimum reliable operation of a Gunn diode oscillator.

For laboratory test stations it is sometimes useful, or required as in an HP8757 Scalar Analyzer, to apply an AM or FM modulation. Provisions exist on the full feature regulator for this modulation to be internally or externally supplied. In addition, the FM modulation option can be used to phase lock the Gunn oscillator using a source locking counter.

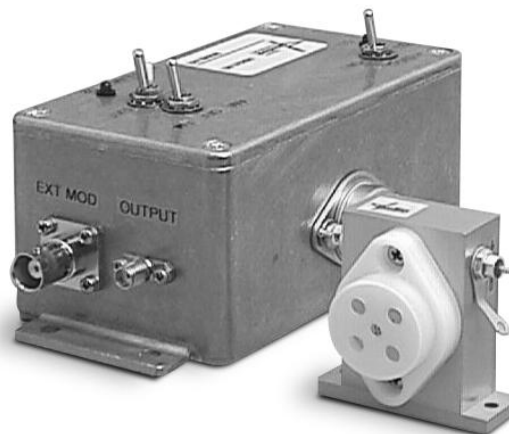

### Outline Drawings

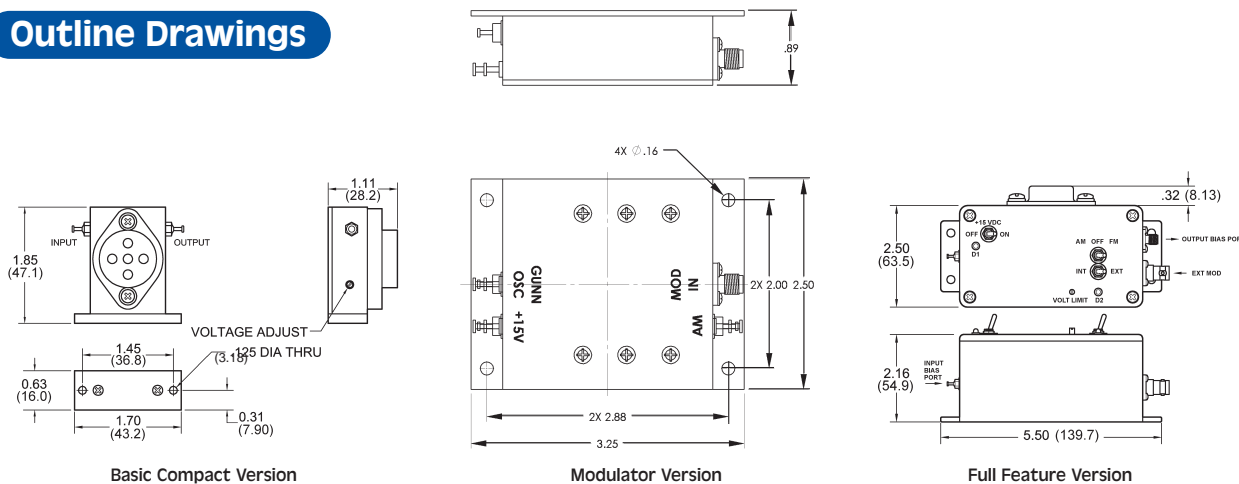

### Ordering Information

Model Number **QCR -** **AB C D 00**

output voltage (rounded to nearest Volt)

version

C = compact (basic)  
F = full feature  
M = Modulator (AM & FM)

options

0 = none  
A = AM modulation  
F = FM modulation  
M = AM/FM modulation  
L = source locking capability  
Z = custom



# High Power IMPATT Oscillators

QIO

## Characteristics

- ◆ High Power Output
- ◆ CW and Pulsed Versions
- ◆ Temperature Stabilized



## Product Description

QuinStar Technology's series **QIO IMPATT oscillators** utilize a double drift IMPATT diode mounted in a temperature stabilized waveguide cavity to generate high RF output power. They are available in CW and pulsed versions in commonly used frequency ranges between 34 and 97 GHz.

shielded interconnecting cable mounted on a baseplate. The frequency of operation can be electronically tuned by applying a DC voltage to the AFC input connector located on the voltage regulator or micrometer tuning can be provided. Heatsink stands and temperature controllers are also available to help maintain frequency and power stability over a wide baseplate operating temperature range.

The oscillators are provided with an integral isolator, DC voltage regulator, pulse modulator (pulsed versions) and

## Specifications

FREQUENCY BAND		Ka	Q	V	W
Frequency Range (GHz)		34-36	43-47	58-62	92-97
Waveguide Size		WR-28	WR-22	WR-15	WR-10
Power Output Range (Watts)	CW	0.2-1.0	0.2-1.0	0.1-0.5	0.1-0.3
	Long Pulse (pulse width 1us-1ms/ duty 0-50%)	0.2-1.0	0.2-1.0	0.1-0.5	0.1-0.2
	Short Pulse (pulse width 50-150ms/ duty 0-0.5%)	1-20	--	--	1-15

Consult factory for detailed specifications and outline drawings.

## Ordering Information

Model Number **QIO -**

**AB CD E F**

center frequency rounded to nearest GHz

CW or peak output power in dBm

version

- C = CW
- S = short pulse
- L = long pulse

options

- H = temperature controller with baseplate
- J = temperature controller with heatsink stand
- K = baseplate only
- L = heatsink stand only
- Z = custom
- M = micrometer
- O = none



## Characteristics

- ◆ High Power
- ◆ CW and Pulsed
- ◆ Low Parasitic Package
- ◆ Low Thermal Resistance( $R_{TH}$ )  
Diamond Heatsink



## Product Description

QuinStar Technology's **QID** series **IMPATT diodes** are high power silicon double drift diodes packaged in a low parasitic, hermetically sealed package. The diodes are mounted on a metallized diamond heatsink and copper base for efficient heat removal.

CW, long and short pulse diodes are offered and power outputs are tested over specific frequency windows. QID

series high power short pulse diodes are available in dual diode packages for W-band short pulse applications.

QuinStar also offers high power IMPATT oscillators (QIO Impatt Oscillators) and amplifiers (QIC CW IMPATT Amplifiers, QIP Pulsed IMPATT Amplifiers) for a variety of applications.

## Specifications

CW and Long Pulse <sup>1</sup> Diodes					
Test Circuit Waveguide Band	Ka	Q	V	W	D
	26.5-40	33-50	50-75	75-110	110-170
Test Frequency Range (GHz)	33-37	42-46	58-62	92-96	135-145
Power Outputs Available (mW typ) <sup>2</sup>	1000	800	800	400	20
Operating Voltage Range (V)	35-50	30-42	24-34	16-22	7-12
Total Capacitance at V=0 (pF)	1.0-3.0	1.0-3.0	1.2-2.5	0.7-1.5	0.7-1.0

Short Pulse Diodes					
Test Circuit Waveguide Band	Ka	Q	V	W	D
	26.5-40	33-50	50-75	75-110	110-170
Test Frequency Range (GHz)	33-37	42-46	58-62	92-96	135-145
Peak Power Outputs Available (W typ) <sup>2</sup>	15	—	—	20	—
Total Capacitance at V=0 (pF)	5.0-9.0	—	—	6.0-9.0	—
Pulse Width (ns typ)	100	—	—	100	—

High Power Short Pulse W-Band Dual Diodes	
Test Circuit Waveguide Band	W 75-110
Test Frequency Range (GHz)	88-96
Peak Power Outputs Available (W typ)	40
Total Capacitance at V=0 (pF typ)	3.0-5.0
Pulse Width (ns typ)	<100
Duty Factor (% max)	0.8

<sup>1</sup> Long Pulse: >1 uSec, up to 100% duty factor

<sup>2</sup> Diodes are tested to provide specified minimum power output at an unspecified single frequency in the test frequency range with estimated junction temperature not exceeding 250°C with the test fixture cavity at 50°C.

Outline Drawing/Mechanical Specifications

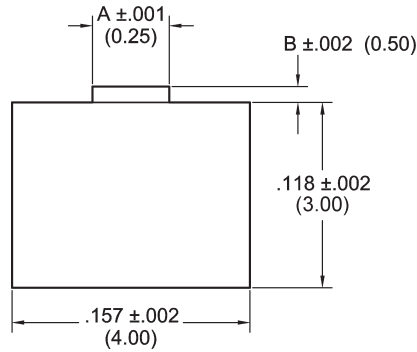

FREQUENCY BAND	OUTLINE DIMENSIONS, inches/mm		
	A (CW, Long Pulse, Short Pulse)	A (Hi Power Dual Diode, (Short Pulse)	B
Ka	0.035/0.89	—	0.13/0.33
Q	0.035/0.89	—	0.13/0.33
V	0.035/0.89	—	0.13/0.33
W	0.035/0.89	0.030/0.76	0.13/0.33
D	0.018/0.45	—	0.10/0.25

Ordering Information

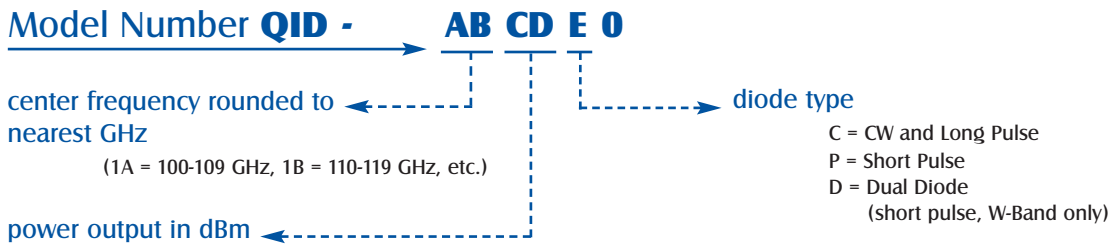



# Stable Millimeter Wave Sources

QSO

## Characteristics

- ◆ Compact Design
- ◆ Extremely Low Spurious and Harmonic Contents
- ◆ High Frequency Stability
- ◆ Excellent DC to RF Power Efficiency

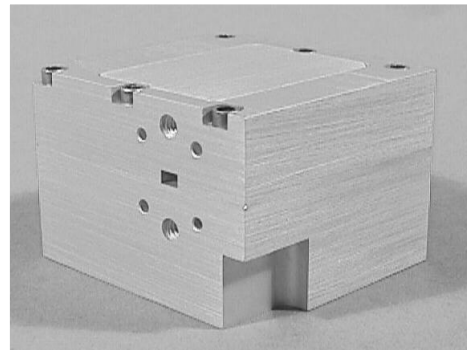

## Product Description

QuinStar series QSO Stable Millimeter Wave Sources are compact, low thermal drift sources operating at customer-specified fixed frequencies in the most popular millimeter wave bands. They are ideally suited for use as local oscillators in millimeter wave receivers, and as master source or exciters in transmitters for communication and radar systems. In general, these sources are optimal solutions for applications where a phase-locked oscillator is not necessary, but relatively low drift is essential for operation or compliance. They typically demonstrate a temperature stability of operating frequency (drift) of better than 50 kHz per degree C. The other noteworthy

feature of these sources is the extremely low spurious signal content achieved by incorporating high performance filters in the architecture of the sources. These sources are designed to operate on a single voltage supply anywhere between 8-12 volts.

In addition to the standard products offered here, QuinStar Technology can design and build a custom stable oscillator for your specific application and requirement anywhere in the frequency range of 20-95 GHz.

## Specifications

PERFORMANCE CHARACTERISTICS	V-BAND STABLE SOURCE (QSO-V XXXX)	W-BAND STABLE SOURCE (QSO-W XXXX)
Frequency Range <sup>1</sup> , GHz	52-64	72-80
Power Output, dBm minimum	14	12
Frequency Drift, kHz/deg. C, typical	50	50
Phase Noise, typical	80 dBc/Hz at 10 kHz offset 103 dBc/Hz at 100 kHz offset 127 dBc/Hz at 1 MHz offset	78 dBc/Hz at 10 kHz offset 102 dBc/Hz at 100 kHz offset 127 dBc/Hz at 1 MHz offset
DC Power Consumption	8-12 V, 400 mA max.	8-12 V, 400 mA max.
Operating temperature range	-40 to +55 degree C.	-40 to +55 degree C.
Size	1.75 x 1.75 x 1.5 inch	1.25 x 1.25 x 1.1 inch

## Ordering Information

Model Number **QSO -**

**A BC DE F**

output waveguide

V = V-band  
W = W-band

frequency in GHz

options and features

O = no special features or options

power in dBm



**Characteristics**

- ◆ Low Phase Noise
- ◆ Internal or External Reference
- ◆ High output capability
- ◆ Compact Outline

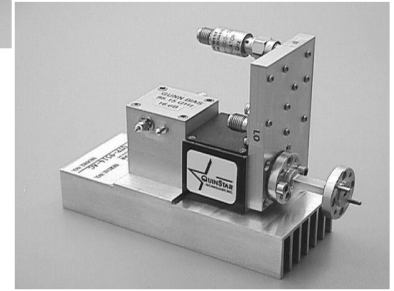
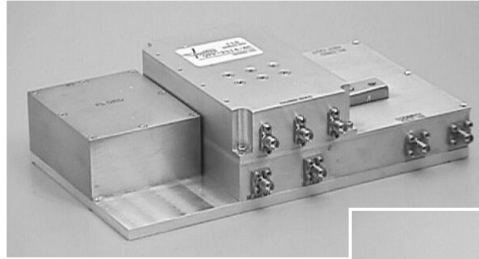

**Product Description**

QuinStar Technology's QPL series of Phase Locked Oscillators are available over the frequency range of 26 to 150 GHz. These sources are produced using one of several possible methods of generating the microwave or millimeter wave power, and phase-locking the source to an appropriate reference oscillator. Depending on the frequency of operation, QuinStar's series QPL Phase-Locked Sources are created using one or more of the following oscillators:

- (a) Microwave GaAsFET or SiGe Device-based Dielectric Resonator Oscillator
- (b) Microwave Voltage Controlled Oscillator
- (c) Microwave Oscillators followed by Active or Passive Frequency Multipliers
- (d) Gunn Diode or IMPATT diode-based Oscillators

Also, phase-locking of the oscillator to a reference source is achieved by employing the most suitable and optimal

technique from a variety of approaches and/or architectures. Each design approach has unique advantages and features that allow QuinStar to provide an optimal Phase-Locked Source for virtually any application.

QuinStar can integrate high power amplifiers to achieve maximum power levels available at a given frequency.

QuinStar's PLO's are available with either internal or external crystal references. Internal crystal oscillator frequencies can range from 5 MHz to 150 MHz. Synthesizers and special-purpose Phase-locked oscillators are also offered as customized products.

These sources can be provided with varying degrees of packaging and integration, ranging from miniature modules to stand-alone Instrumentation-style products with complete power supplies, and in customer-specific outlines.

**Ordering Information**

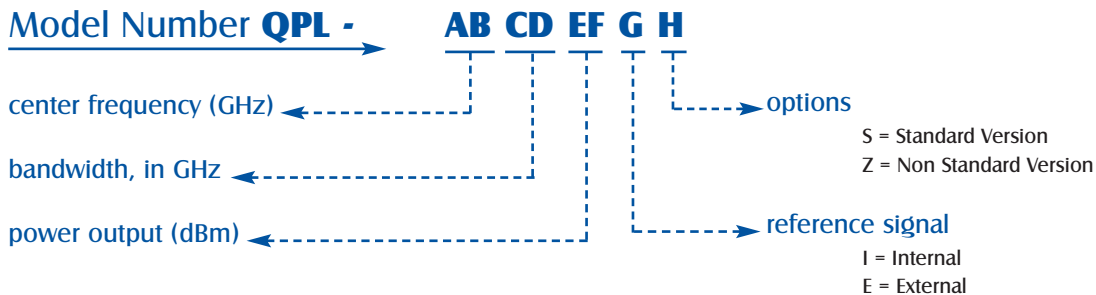



## Characteristics

- ◆ Offered Over 18-110 GHz Output Frequency
- ◆ Active Amplification with Integral Filter
- ◆ Low Power Consumption

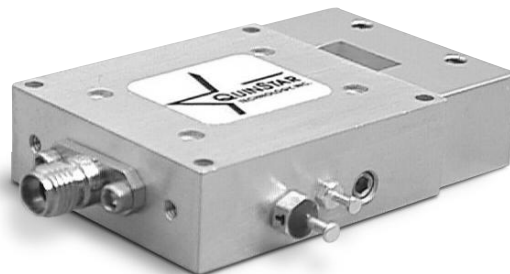

## Product Description

QuinStar Technology's series **QMM active multipliers** utilize state-of-the-art active multiplier devices for frequency multiplication and amplification over the 18-110 GHz frequency range. These frequency multipliers provide a broad bandwidth with multiplying factors between 2 and 6. The standard multiplier housing enables I/O ports of SMA (18-26.5 GHz) and 2.9 mm (18-40 GHz) coaxial connectors and WR-42 through WR-10 waveguide sizes.

These multipliers are useful as part of the LO chain of communication, radar and instrumentation systems. They provide a simple and economical solution for adding signal multiplication and gain in a variety of system applications.

## Specifications

Output Frequency <sup>1</sup> , GHz	Multiplier Factor	Input Frequency, GHz	Output Bandwidth, GHz	Output Power Offered <sup>2</sup> , dBm	Input Power Required, dBm typ.	Input Connector or Waveguide	Output Connector or Waveguide	Outline
18-26.5	2	9-13.25	Up to Full Band	13 to 27	10	SMA (F)	WR-42/SMA(F)	S <sub>J</sub>
26.5-40	2	13.25-20	Up to Full Band	10-20	10	SMA (F)	WR-28/K (F)	S <sub>J</sub>
26.5-40	3	8.83-13.33	Up to Full Band	10-20	10	SMA (F)	WR-28/K (F)	S <sub>J</sub>
26.5-40	4	6.625-10	Up to Full Band	10-20	10	SMA (F)	WR-28/K (F)	S <sub>J</sub>
33-50	2	16.5-25	2-10	10-17	10	SMA (F)	WR-22	S
33-50	3	11-16.67	2-10	10-17	10	SMA (F)	WR-22	S
33-50	4	8.25-12.5	2-10	10-15	10	SMA (F)	WR-22	S
40-60	2	20-30	2-10	10-13	10	K (F)/WR-34	WR-19	S
40-60	3	13.3-20	2-10	10-13	10	SMA (F)	WR-19	S
54-65	2	27-32.5	2-11	7-16	5	K (F)/WR-28	WR-15/WR-19	W
54-65	3	18-21.67	2-11	7-16	10	SMA (F)/WR-42	WR-15/WR-19	W
54-65	4	13.5-16.25	2-11	7-16	10	SMA (F)	WR-15/WR-19	W
50-75	2	25-37.5	5 to Full Band	7-10	10	K (F)/WR-28	WR-19/WR-15	W
50-75	3	16.67-25	5 to Full Band	7-10	10	K (F), SMA (F)/WR-42	WR-15/WR-19	W
50-75	4	12.5-18.75	4 to Full Band	7-10	10	SMA (F)	WR-15/WR-19	W
60-90	3	20-30	4 to Full Band	0	10	K (F)	WR-12/WR-15/WR-10	W
73-79	2	36.5-39.5	2-6	10	5	K (F)	WR-12/WR-10	W
80-86	2	40-43	2-6	5	5	K (F)	WR-12/WR-10	W
92-95	2	46-48	2-4	7-20	10	K (F)/WR-19	WR-10	W
92-95	3	30.67-32	2-4	7-20	10	K (F)/WR-28	WR-10	W
92-95	4	23-24	2-4	7-20	10	SMA (F)	WR-10	W
92-95	6	15.33-16	2-4	7-20	10	K (F)	WR-10	W
75-110	3	25-36.67	4 to Full Band	0-6	10	K (F)	WR-10	W

<sup>1</sup> Active Multipliers with other frequency ranges and multiplier factors are available upon request as custom products.

<sup>2</sup> Maximum available power output varies depending on bandwidth (range) selected. Consult QuinStar for other frequency bands and input and output interfaces.

### Outline Drawings/Mechanical Specifications

Outline S

BAND	C	D
K	1.59	UG-595/U
Ka	1.57	UG-599/U
Q	1.56	UG-383/U
U	1.55	UG-383/U MOD

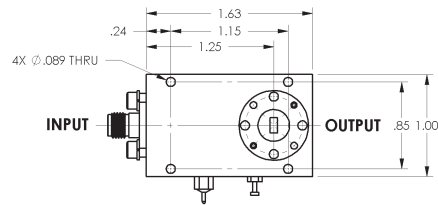
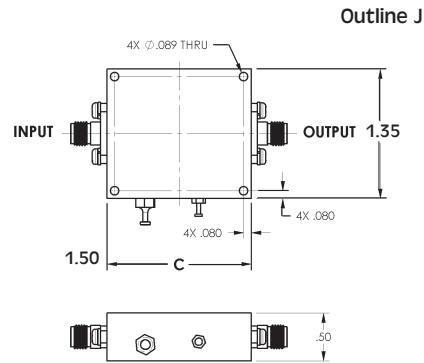
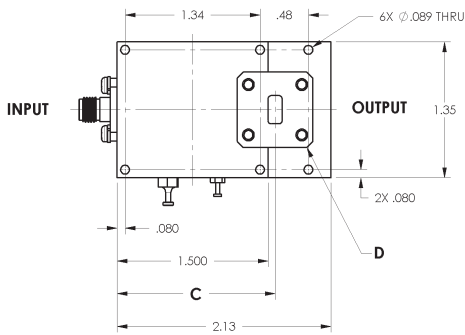

### Ordering Information

Model Number **QMM -**

**AB CD EF G H**



Please specify exact output frequency range when ordering.

output center frequency (rounded to nearest GHz)

bandwidth, in GHz

power output in dBm

outline drawing (see above)

Z = non-standard

multiplying factor

2 = x2, 3 = x3, 4 = x4



# Passive Frequency Multipliers

## QPM

### Characteristics

- ◆ No External Bias Required
- ◆ Full Waveguide Bandwidth
- ◆ Low Conversion Loss

### Product Description

QuinStar Technology's **QPM** series of **passive multipliers** cover the output frequency range of 18 to 110 GHz. The design enhances either even or odd harmonics while suppressing unwanted odd or even harmonics. No external bias is required providing flexibility for system implementation. Standard units are rated over the 0 to +50°C operating temperature range with a maximum input power of +23 dBm. Standard RF interfaces are SMA or K female coaxial for the input and wave-

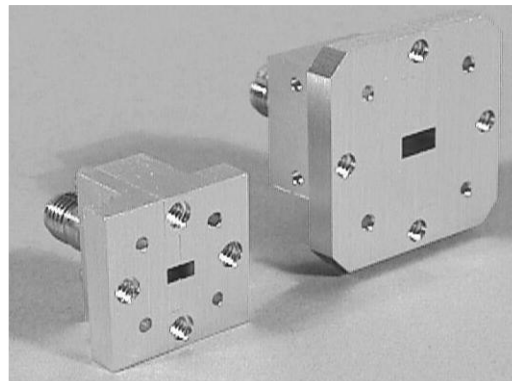

guide for the output. Other RF interface configurations are available.

QuinStar can provide higher output power over narrower bandwidth. Models with significantly higher output power over narrowband (1 GHz typically) are offered over 40-100 GHz range. QuinStar also produces series QMM Active Multipliers over 18-110 GHz.

### Specifications

Output Waveguide Band	Output Frequency Range, GHz	Multiplication Factor	Input Frequency Range, GHz	Input Power Level <sup>1</sup> , dBm	Output Power Level <sup>1</sup> , dBm min	Ouptut Waveguide	Input Connector or Waveguide <sup>2</sup>
K	18-26.5	2	9.0-13.25	20	8	WR-42	SMA
Ka	26.5-40	2	13.25-20.0	20	8	WR-28	SMA
Ka	26.5-40	3	8.67-13.33	20	5	WR-28	SMA
Q	33-50	2	16.5-25	20	8	WR-22	SMA
Q	33-50	3	11-16.67	20	3	WR-22	SMA
U	40-60	2	20-30	20	8	WR-19	K (F)
U	40-60	3	13.33-20	20	2	WR-19	SMA
V	50-75	2	25-37.5	20	7	WR-15	K (F), WR-28
V	50-75	3	16.67-25	20	2	WR-15	K (F)
E	60-90	2	30-45	20	3	WR-12	K (F), WR-22
E	60-90	3	20-30	20	0	WR-12	K (F)
W	75-110	2	37.5-55	18	0	WR-10	V (F), WR-19
W	75-110	3	25-36.67	20	-2	WR-10	K (F), WR-28

<sup>1</sup> Typical optimum input power level. Output power saturates at around this level. Lower input power produces lower output power in non-linear fashion. Maximum safe power level is typically 2 dB higher. Higher output power available over narrower range.

<sup>2</sup> Other Waveguide or connectors available as custom products. Please contact QuinStar.

<sup>3</sup> Outline Drawings available upon request.



# Passive Frequency Multipliers

QPM

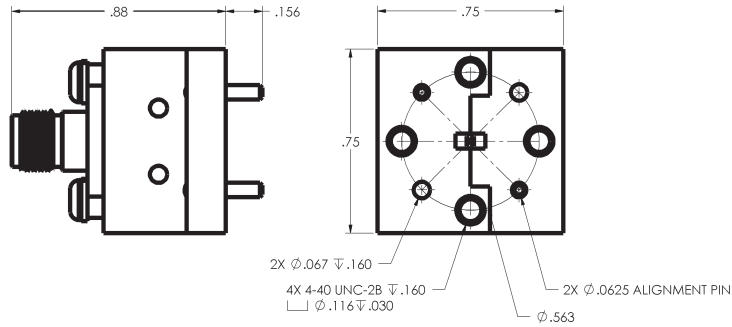

V-Band Doubler

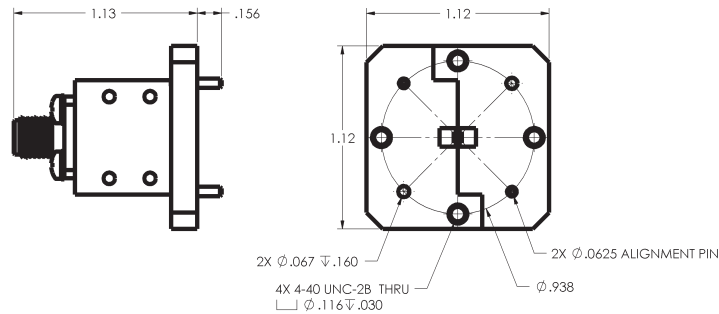

Q-Band Doubler

## Ordering Information

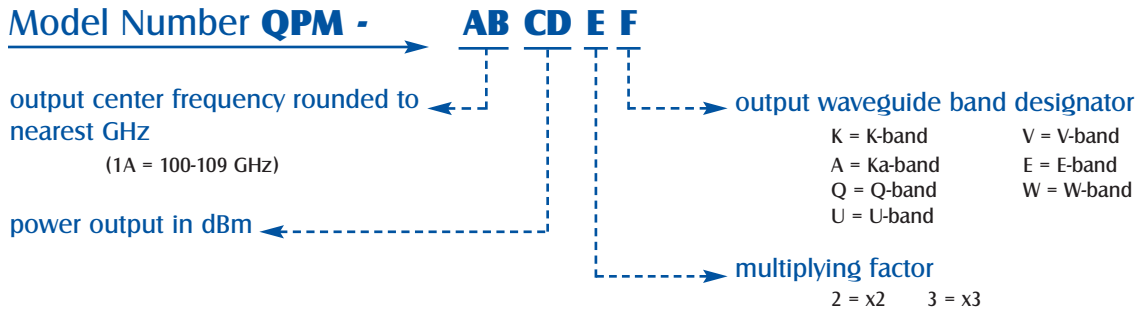



## Characteristics

- ◆ Broadband Coverage
- ◆ High Noise Power Output
- ◆ Compatible with Most Noise Figure Meters
- ◆ Fast Rise/Fall Time

## Product Description

QuinStar Technology's **QNS** series of **millimeter-wave noise sources** cover the frequency range of 18 to 110 GHz in seven waveguide bands with up to full standard waveguide band coverage. They feature stable noise power output, high switching speed and relatively flat high output power. Careful device selection, special cavity design and matching circuits have all contributed to a reliable design that is highly stable with time and over temperature.

The noise output power of these noise sources is specified in terms of **excess noise power ratio** (ENR) as a function of frequency. QuinStar Technology offers three versions of these noise sources to suit virtually any application. Full waveguide band noise sources are offered for use with Noise Figure Meters. These models provide very flat ENR (nominally 15 dB) over complete standard waveguide bands in the 18 to 110 GHz region. Higher power noise

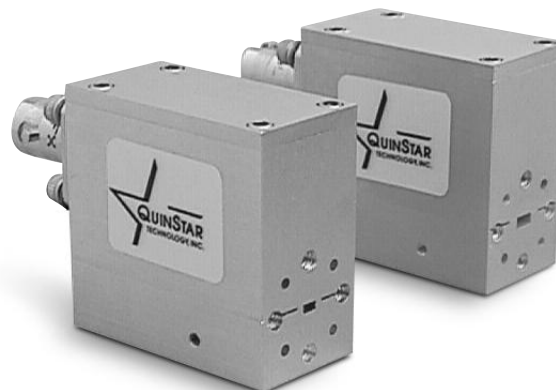

sources offer amplified output power (ranging from 20 to 25 dB ENR) over the 18 to 110 GHz frequency range. Narrowband versions with high output power are offered for subsystem applications and special test equipment. These nominally offer 1 to 2 GHz bandwidth with excellent flatness and stable characteristics. An integral isolator is offered as an option for improved VSWR. QuinStar can readily provide a custom-designed noise source to suit unique applications or subsystem requirements.

Series QNS noise sources are ideally suited for measuring noise figure of amplifiers and receivers using the most currently available noise figure meters and eliminate the need for gas tubes. They are also well suited for calibration and built-in test functions in many sensitive receiver subsystems, radiometers and measurement instruments.

## Specifications

Frequency Range (GHz)		18-26.5	26.5-40	33-50	40-60	50-75	60-90	75-110
Output Waveguide Size		WR-42	WR-28	WR-22	WR-19	WR-15	WR-12	WR-10
<b>Excess Noise Ratio (ENR) (dB typ)</b>	Instrumentation Sources (Fullband Version) <sup>1</sup>	15	15	15	15	15	15	12
	Amplified Noise Power Sources (Broadband Version) <sup>2</sup>	25	25	23	23	23	17	17
	High Power Sources (Narrowband Version) <sup>3</sup>	25	25	25	25	23	20	20
<b>Output Power Flatness (dB typ)</b>	Instrumentation Sources (Fullband Version) <sup>1</sup>	±1	±1	±1	±1	±2	±3	±3
	Amplified Noise Power Sources (Broadband Version) <sup>2</sup>	±1.5	±2.0	±2.5	±2.5	±2.5	±2.5	±2.5
	High Power Sources (Narrowband Version) <sup>3</sup>	±0.5	±0.5	±1	±1	±1	±1	±1
<b>Stability of Noise Power Output for All Models (typ)</b>	Temperature Stability, dB/°C typ.	0.01	0.01	0.01	0.01	0.015	0.015	0.015
	Stability With Bias Voltage, dB/1% Bias Voltage Change <sup>4</sup>	0.1	0.1	0.1	0.1	0.15	0.15	0.15

<sup>1</sup> Fullband coverage. Other waveguide bands are available.

<sup>2</sup> Fullband up to 40 GHz, any 10 GHz band within the 40-110 GHz range.

<sup>3</sup> 2 GHz bandwidth anywhere in waveguide band.

<sup>4</sup> Operating voltage 28 VDC (optional 15 VDC).

### Outline Drawings/Mechanical Specifications

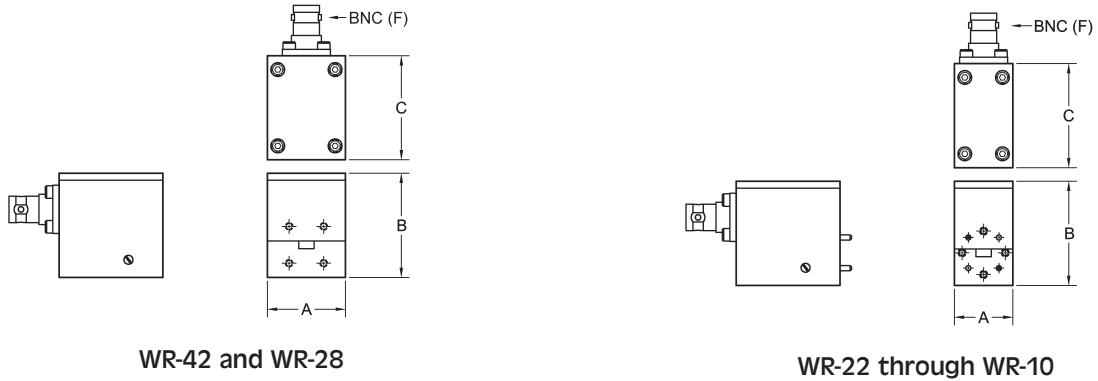

FREQUENCY BAND	WAVEGUIDE SIZE	FLANGE PATTERN	OUTLINE DIMENSIONS, inches/mm		
			A	B	C
K	WR-42	UG-595/U	1.13/28.7	1.50/38.1	1.50/38.1
Ka	WR-28	UG599/U	1.13/28.7	1.50/38.1	1.50/38.1
Q	WR-22	UG383/U	1.13/28.7	1.50/38.1	1.50/38.1
U	WR-19	UG383/U-M	1.13/28.7	1.50/38.1	1.50/38.1
V	WR-15	UG385/U	0.76/19.3	1.50/38.1	1.50/38.1
E	WR-12	UG387/U	0.76/19.3	1.50/38.1	1.50/38.1
W	WR-10	UG387/U-M	0.76/19.3	1.50/38.1	1.50/38.1

### Ordering Information

**Model Number QNS -** **AB CD E F** Please specify exact frequency range when ordering.

**frequency** ← **AB** → **waveguide band designator** → **CD**

Fullband: FB  
Narrowband: center frequency rounded to nearest GHz (1A = 100-109 GHz)

**excess noise ratio (ENR) in dB** ← **E**

**version** ← **F**

T = instrumentation version (fullband) without isolator  
E = amplified power version without isolator  
M = narrowband, high power version without isolator  
L = instrumentation version (fullband) with isolator  
P = amplified power version with isolator  
N = narrowband, high power version with isolator  
Z = custom

K = K-band      V = V-band  
A = Ka-band      E = E-band  
Q = Q-band      W = W-band  
U = U-band



# Frequency Extenders

## QBE

### Characteristics

- ◆ Broadband and Sweepable
- ◆ Output Frequency up to 110 GHz
- ◆ Excellent Power Flatness

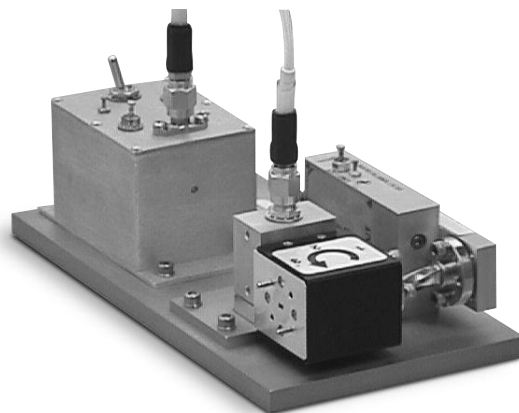

### Product Description

QuinStar Technology's series **QBE frequency extenders** utilize a chain of passive or active multipliers and amplifiers to extend a microwave source to cover the frequency range of 18 to 110 GHz. The extenders also allow the use of network analyzers, sweepers and synthesizers operating in the 2-20 GHz range to frequencies in the 20-110 GHz range. Multiplication factors of 2 to 12 are available and integral

filters guarantee low spurious levels. Both full waveguide bandwidth/moderate output power and narrow bandwidth/high output power versions are available. The standard product has all extender components integrated and mounted on a baseplate. Typically, input is a coaxial SMA-F or K connector and output is waveguide. Other RF interface configurations are available.

### Specifications

OUTPUT FREQUENCY BAND	K	Ka	Q	U	V	E	W
<b>Multiplying Factor</b>	2	2-4	2-6	2-8	2-8	2-12	2-12
<b>Input Power Range (dBm)</b>	10-20	10-20	10-20	10-20	10-20	10-20	10-20
<b>Output Frequency Range (GHz)</b>	18-26.5	26.5-40	33-50	40-60	50-75	60-90	75-110
<b>Fullband Output Power (dBm min)</b>	20	20	15	10	6	2	0
<b>Narrowband Output Power (dBm min)<sup>1</sup></b>	23	23	20	17	18	17	20
<b>Input Connector</b>	SMA	SMA	SMA	SMA	SMA or K	SMA or K	SMA or K
<b>Output Waveguide Size</b>	WR-42	WR-28	WR-22	WR-19	WR-15	WR-12	WR-10

Other frequency bands and input and output interfaces are available.

<sup>1</sup> Typical bandwidth 2 GHz. Larger bandwidth available. Please contact QuinStar for power output level for moderate bandwidth versions.

### Ordering Information

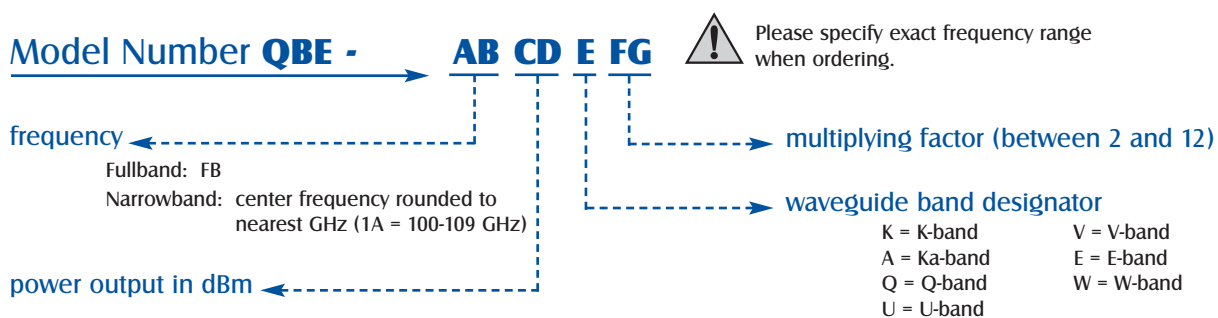



## Section 4

# Control Components and Ferrite Products

Product Title	Model No.	Page Number
<b>Control Components and Ferrite Products</b>		79
Glossary of Control Component Terminology		80
Precision Junction Circulators and Isolators	<b>QJY/QJI</b>	82
Fullband Junction Circulators and Isolators	<b>QJE/QJF</b>	84
Fullband Isolators	<b>QIF/QIM</b>	86
Variable PIN Attenuators	<b>QSA</b>	88
PIN Switches	<b>QSS/QSD/QSn</b>	90
Coax PIN Switches	<b>QSC</b>	92

## Glossary of Control Component Terminology

**1 dB gain compression point** – As RF signal input level to a phase modulator is increased, output should follow in a linear manner. However, after a certain point, output signal level increases at a lower rate until the modulator output level becomes fairly constant. The RF input level for which the output level deviates from linearity by 1 dB is the “1 dB compression point.”

**Amplitude imbalance** – Amplitude unbalance is a measure of the worst-case variation in insertion loss between the states in a modulator. For a demodulator, amplitude imbalance is the difference of the I and Q power. Amplitude Imbalance = PI(dBm)-PQ(dBm).

**Attenuation** – This is the amount by which the input signal is decreased when the PIN diodes are fully biased (in other words, when maximum current is drawn). It is also often termed “isolation” of a PIN switch.

**Carrier rejection** – The amount of carrier measured in dB below the desired output signal when a coherent signal of equal amplitude and 90 degrees phase difference is applied to the I&Q ports. This is shown in **Figure 1** below.  $f_c$  &  $f_i$  are the carrier and IF (I-port/Q-port) frequencies, respectively. This also applies to biphase modulators

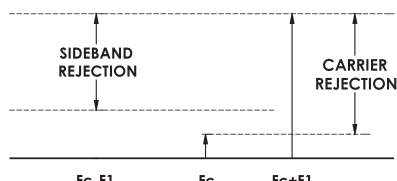

Figure 1. Carrier Rejection.

**Conversion loss** – For a modulator, conversion loss (C.L.), in dB, is defined as below:

**C.L.(dB) = Input(I+Q) Power – Output RF Power of the dominant sideband.**

For a demodulator, it is defined as:

**C.L.(dB) = RF Input Power – (I+Q) Output Power.**

**Harmonic suppression** – In a modulator, besides the undesired sideband and carrier, harmonic products of the IF combine with the carrier to produce undesired signals at RF as below:

$$f_c \pm n f_i$$

The most important products are the third and fifth,  $f_c \pm 3 f_i$  and  $f_c \pm 5 f_i$  since they are very close to the desired sideband and almost impossible to filter. For a demodulator, the harmonic products of interest are  $n f_i$ . The products of most interest are  $n = 3$  and  $n = 5$ .

**I & Q.** In-phase and quadrature-phase components of output.

**Insertion loss** – This loss figure is the minimum amount of attenuation when the bias current is zero and the PIN diodes are off. The loss is made up of any device losses and the individual insertion losses of the circuit. The insertion loss of a phase modulator is measured statically in one of the possible states and represents the worst-case loss for any state. For QPSK modulators, the insertion loss is 6 dB typically.

**Phase imbalance** – Phase imbalance is a measure of the offset from the desired carrier phase relative to the actual phase shift in any of the possible phase states. This is measured with respect to a reference or 0 degree phase state. The deviation from 90 degrees of the phase angle difference of the I&Q port output signals.

**Quadrature phase shift keying modulator** – Quadrature phase shift keying (QPSK) modulators are four-port devices with RF-in, RF-out, and two data input ports. A bipolar signal is applied at data ports to produce an RF output signal phase-modulated by 0 (reference), 90, 180, or 270 degrees, depending on the state of the modulating signal.

**Sideband rejections** - The amount of undesired sideband measured in dB below the desired sideband under the same conditions as the carrier rejection measurement.

**Switching Speed**- Please see Figure 2 below for explanation of Switching Speed.

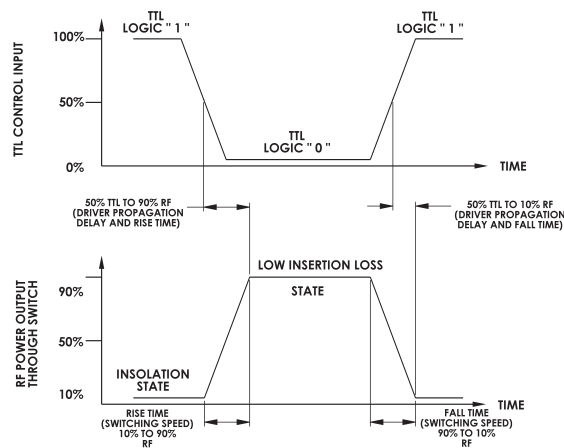
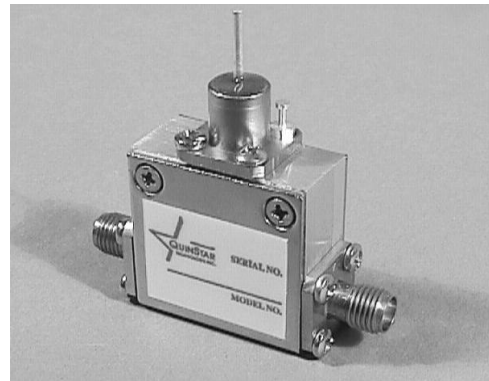
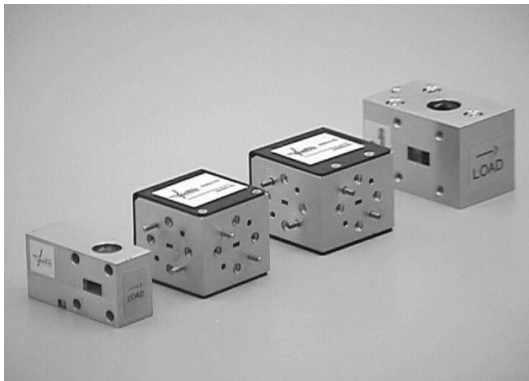
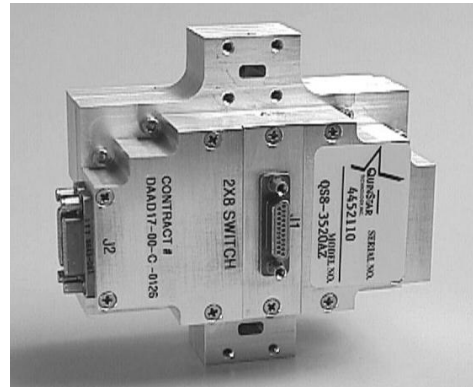
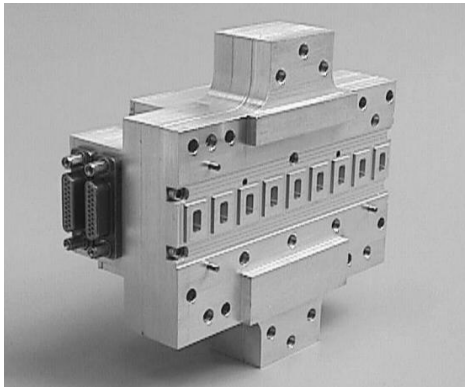
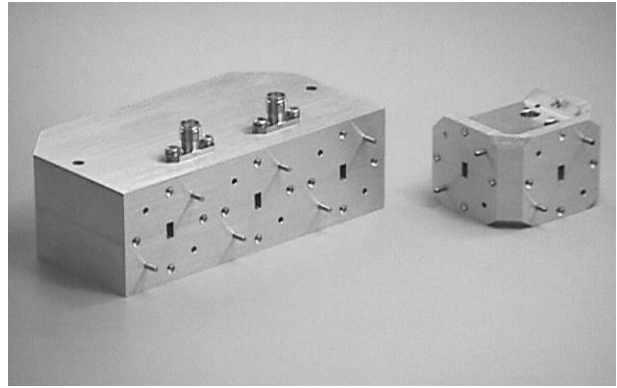
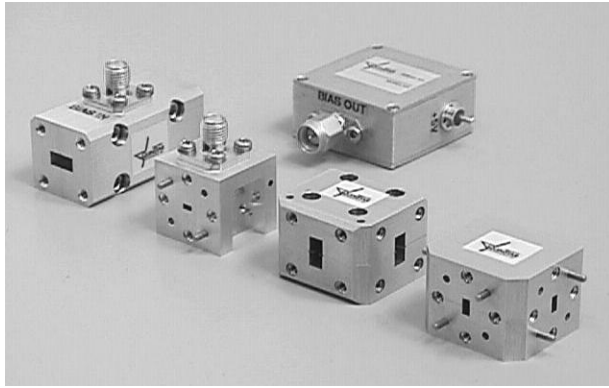

Figure 2. Switching Speed and Driver Propagation Delay Measurement.

**VSWR** – VSWR is a measure of impedance match at input and output ports of the modulator. This parameter represents imperfect input and output impedances.

# Control Components and Ferrite Products





# Precision Junction Circulators and Isolators

## QJY/QJI

### Characteristics

- ◆ Compact
- ◆ High Isolation
- ◆ Low Insertion Loss
- ◆ Broadband



### Product Description

QuinStar Technology's **QJY** series **precision junction circulators** and **QJI** series **precision junction isolators** are available in seven waveguide bands covering the frequency range of 18 to 110 GHz. Single-junction isolators and single- and three- junction circulator versions are offered. These three-port Y-junction ferrite devices feature high isolation, low insertion loss, and broad bandwidth. The three-junction circulators effectively combine a standard circulator with input and output isolators in a compact package.

Junction circulators and isolators are used to provide load isolation in a wide variety of components including Gunn and IMPATT oscillators and amplifiers, upconverters and downconverters, power combiners, and also as duplexers at the antenna ports of millimeter-wave transceiver systems.

### Specifications

FREQUENCY BAND		K	Ka	Q	U	V	E	W
Frequency Range (GHz)		18-26.5	26.5-40	33-50	40-60	50-75	60-90	75-110
Waveguide Size		WR-42	WR-28	WR-22	WR-19	WR-15	WR-12	WR-10
Bandwidth (GHz min)		2	2	2	2	2	2	2
Isolation (dB min)	Single-Junction	20	20	20	20	20	18	18
	Three-Junction (Circulator Only)	35	35	35	35	35	35	35
Insertion Loss (dB max)	Single-Junction	0.3	0.5	0.5	0.6	0.7	0.8	1.0
	Three-Junction (Circulator Only)	1.0	1.0	1.1	1.2	1.3	1.5	1.6
VSWR (max)		1.2:1	1.2:1	1.2:1	1.2:1	1.3:1	1.3:1	1.3:1
Power Rating (Watts max), QJY Junction Circulator		10	8	8	6	5	5	4
Power Rating (Watts max), QJI Junction Isolator		3	3	2	2	1.5	2	2

Other waveguide sizes are available.

### Outline Drawings/Mechanical Specifications

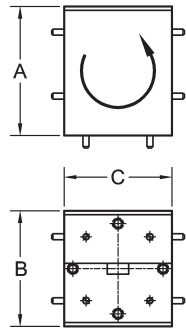

Single-Junction Circulators and Isolators  
(round flange pattern shown)

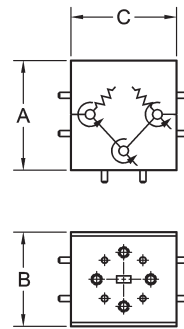

Three-Junction Circulators  
(round flange pattern shown)

FREQUENCY BAND	WAVEGUIDE SIZE	FLANGE PATTERN	SINGLE JUNCTION OUTLINE DIMENSIONS, inches/mm			THREE-JUNCTION OUTLINE DIMENSIONS, inches/mm		
			A	B	C	A	B	C
K	WR-42	UG-595/U	1.20/30.5	0.88/22.4	1.00/25.4	1.50/38.1	1.20/30.5	2.00/50.8
Ka	WR-28	UG599/U	0.90/22.9	0.80/20.3	0.90/22.9	1.50/38.1	1.20/30.5	1.50/38.1
Q	WR-22	UG-383/U	1.45/36.8	1.20/30.5	1.13/28.7	1.50/38.1	1.20/30.5	1.50/38.1
U	WR-19	UG-383/U	1.45/36.8	1.20/30.5	1.13/28.7	1.50/38.1	1.20/30.5	1.50/38.1
V	WR-15	UG-385/U	1.05/26.7	0.85/21.6	1.00/25.4	1.14/29.0	0.98/24.9	1.10/27.9
E	WR-12	UG-387/U	1.05/26.7	0.85/21.6	1.00/25.4	1.14/29.0	0.98/24.9	1.10/27.9
W	WR-10	UG-387/U	1.05/26.7	0.85/21.6	1.00/25.4	1.14/29.0	0.98/24.9	1.10/27.9

### Ordering Information

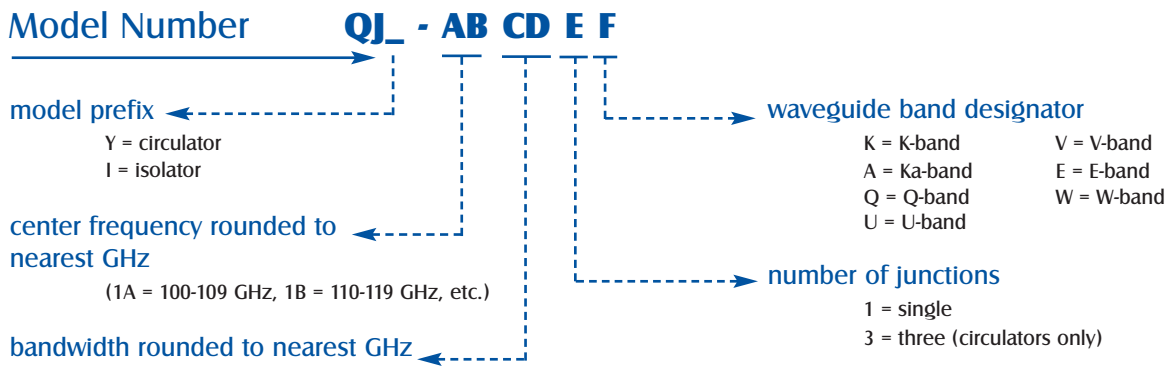



## Fullband Junction Circulators and Isolators

QJE/QJF

### Characteristics

- ◆ Full Waveguide Band
- ◆ Compact
- ◆ High Isolation
- ◆ Low Insertion Loss



### Product Description

QuinStar Technology's **QJE** series **fullband junction circulators** and **QJF** series **fullband junction isolators** are available in two waveguide bands covering the frequency range of 18 to 40 GHz. These H-plane three-port Y-junction ferrite devices feature high isolation, low insertion loss and full waveguide bandwidth.

Junction circulators and isolators are used to provide load isolation in a wide variety of components including Gunn oscillators and amplifiers, upconverters and downconverters, power combiners, and also as duplexers at the antenna ports of millimeter-wave transceiver systems. They are also ideally suited for broadband or swept frequency applications.

### Specifications

FREQUENCY BAND	K	Ka
Frequency (GHz)	18-26.5	26.5-40
Waveguide Size	WR-42	WR-28
Bandwidth (GHz min)	Full	Full
Isolation	20	18
Insertion Loss (dB max)	0.4	0.6
VSWR	1.25:1	1.3:1
Power Rating (W max)	5	4

### Outline Drawings/Mechanical Specifications

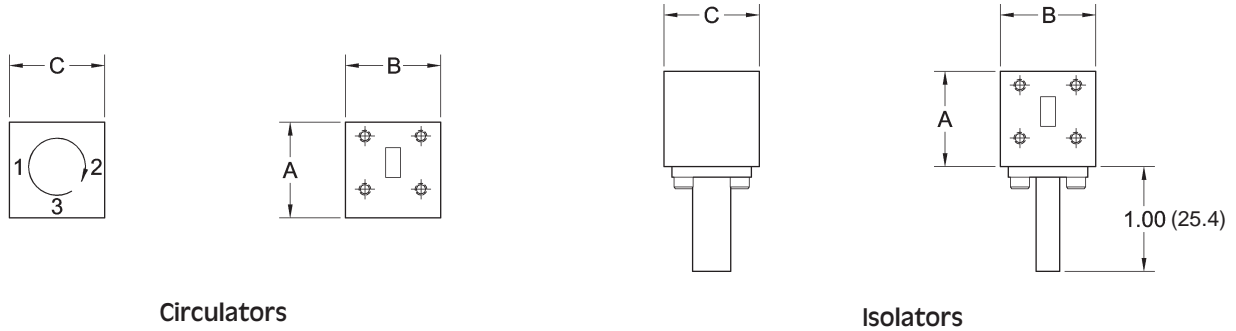

FREQUENCY BAND	WAVEGUIDE SIZE	FLANGE PATTERN	OUTLINE DIMENSIONS, inches/mm		
			A	B	C
K	WR-42	UG-595/U	1.15/29.2	0.88/22.4	1.00/25.4
Ka	WR-28	UG-599/U	0.90/22.9	0.90/22.9	0.90/22.9

### Ordering Information

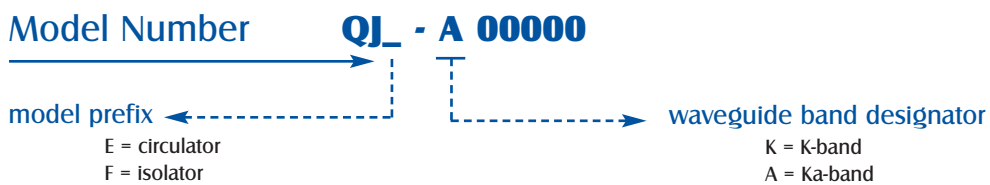



# Fullband Isolators and Modulators

## QIF/QIM

### Characteristics

- ◆ Full Waveguide Bandwidths
- ◆ Low Insertion Loss and VSWR
- ◆ High Wideband Isolation



### Product Description

QuinStar Technology's **QIF** series **fullband isolators and modulators** are available in six waveguide bands covering the frequency range of 26.5 to 110 GHz. These isolators are Faraday-rotation type ferrite devices with bandwidths covering a full waveguide band.

Series QIF isolators provide a minimum of 25 dB of isolation and typically more than 30 dB across most of the waveguide bands. The isolators and modulators can handle power levels from one Watt at W-band to two Watts at Ka-band. They provide isolation over wider bandwidths than single-junction waveguide isolators. The wide bandwidth of these isolators makes them ideally suited for

broadband or swept frequency applications and wideband measurement systems.

Series QIM modulators provide an on-off ratio of more than 25 dB across most of the waveguide band. They also provide an isolation of greater than 20 dB in reverse direction when biased in the low insertion loss state. A magnetic bias is applied through a solenoid coil wound around the ferrite core. An optional external driver unit (model QCM-0000-AA) applies current to the coil to bias the ferrite to a minimum insertion loss state. Rise time from 10% to 90% is typically 3μs

### Specifications

FREQUENCY BAND	Ka	Q	U	V	E	W
Frequency Range (GHz)	26.5-40	33-50	40-60	50-75	60-90	75-110
Waveguide Size	WR-28	WR-22	WR-19	WR-15	WR-12	WR-10
<b>FULLBAND ISOLATORS</b>						
Insertion Loss (dB max)	1.3	1.4	1.6	1.7	2.0	2.2
Isolation (dB min)	25	27	27	27	27	27
VSWR (max)	1.45:1	1.4:1	1.4:1	1.4:1	1.4:1	1.4:1
Power Rating (W max)	2.0	1.5	1.5	1.0	1.0	1.0
<b>FULLBAND MODULATORS</b>						
Forward Insertion Loss (dB max)	1.7	1.7	1.8	1.8	2.0	2.5
On-Off Ratio (dB typ)	25	25	25	25	25	25
Input/Output (VSWR (max.))	1.5:1	1.5:1	1.5:1	1.5:1	1.5:1	1.5:1
Power Rating (W max)	2.0	1.5	1.5	1.0	1.0	1.0

Other waveguide sizes are available.

### Outline Drawing/Mechanical Specifications

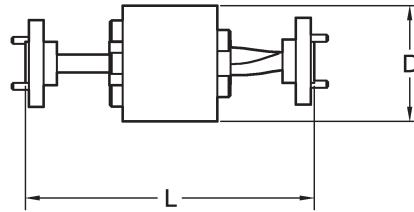

(round flange pattern shown)

FREQUENCY BAND	WAVEGUIDE SIZE	FLANGE PATTERN	OUTLINE DIMENSIONS, inches/mm	
			L	D
Ka	WR-28	UG599/U	2.95/74.9	1.31/33.3
Q	WR-22	UG-383/U	2.69/68.3	1.31/33.3
U	WR-19	UG-383/U	2.69/68.3	1.31/33.3
V	WR-15	UG-385/U	2.50/63.5	1.00/25.4
E	WR-12	UG-387/U	2.50/63.5	1.00/25.4
W	WR-10	UG-387/U	2.50/63.5	1.00/25.4

### Ordering Information

Model Number **QI - A 00000**

model prefix

- F = isolator
- M = modulator

waveguide band designator

- A = Ka-band
- Q = Q-band
- U = U-band
- V = V-band
- E = E-band
- W = W-band



## Variable PIN Attenuators

QSA

### Characteristics

- ◆ Broad RF Bandwidth
- ◆ Low Insertion Loss
- ◆ Current Controlled

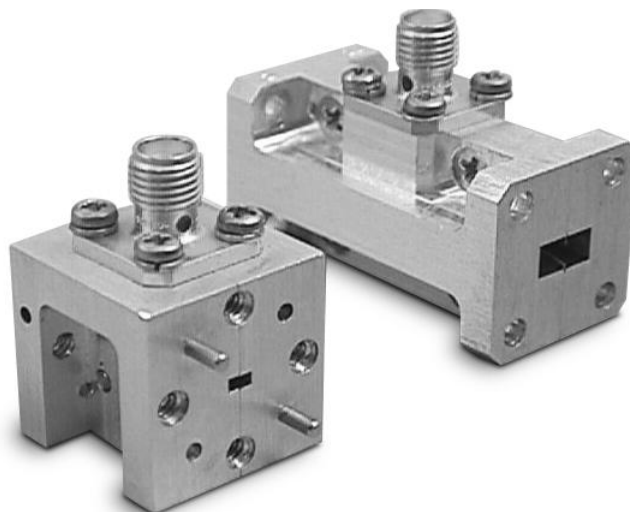

### Product Description

QuinStar Technology's **QSA** series **millimeter-wave variable PIN attenuators** cover the frequency range of 18 to 110 GHz in seven waveguide bands. They are constructed with a rugged, split block mechanical design that utilizes PIN diodes, and are capable of handling RF power levels up

to 1 Watt. Standard units feature broad bandwidth. However, they can be optimized over a narrower frequency range for greater attenuation range or lower insertion loss. They are ideal for signal level control and amplitude modulation.

### Specifications

FREQUENCY BAND	K	Ka	Q	U	V	E	W
Frequency Range (GHz)	18-26.5	26.5-40	33-50	40-60	50-75	60-90	75-110
Waveguide Size	WR-42	WR-28	WR-22	WR-19	WR-15	WR-12	WR-10
Insertion Loss (dB max)	1.0	1.0	1.0	1.2	1.5	2.0	2.0
Bandwidth (GHz min)	Full	Full	Full	Full	10	10	10
Attenuation Range (dB min)	0-23	0-23	0-23	0-23	0-20	0-20	0-20

For ON-state (low insertion loss), the attenuator requires a reverse voltage of 10 Volts; for increasing attenuation, a forward bias current ramping up to 25 mA must be applied.

Power Rating: 1 Watt (max).

## Outline Drawings/Mechanical Specifications

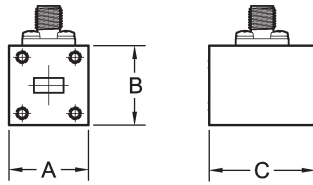

WR-42 and WR-28

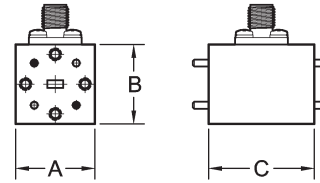

WR-22 through WR-10

FREQUENCY BAND	WAVEGUIDE SIZE	FLANGE PATTERN	BIAS INPUT	OUTLINE DIMENSIONS, inches/mm		
				A	B	C
K	WR-42	UG-595/U	SMA JACK	0.88/22.4	0.88/22.4	1.50/38.1
Ka	WR-28	UG-599/U	SMA JACK	0.75/19.1	0.75/19.1	1.50/38.1
Q	WR-22	UG-383/U	SMA JACK	1.13/28.7	1.13/28.7	1.00/25.4
U	WR-19	UG-383/U	SMA JACK	1.13/28.7	1.13/28.7	1.00/25.4
V	WR-15	UG-385/U	SMA JACK	0.75/19.1	0.75/19.1	1.00/25.4
E	WR-12	UG-387/U	SMA JACK	0.75/19.1	0.75/19.1	1.00/25.4
W	WR-10	UG-387/U	SMA JACK	0.75/19.1	0.75/19.1	1.00/25.4

## Ordering Information

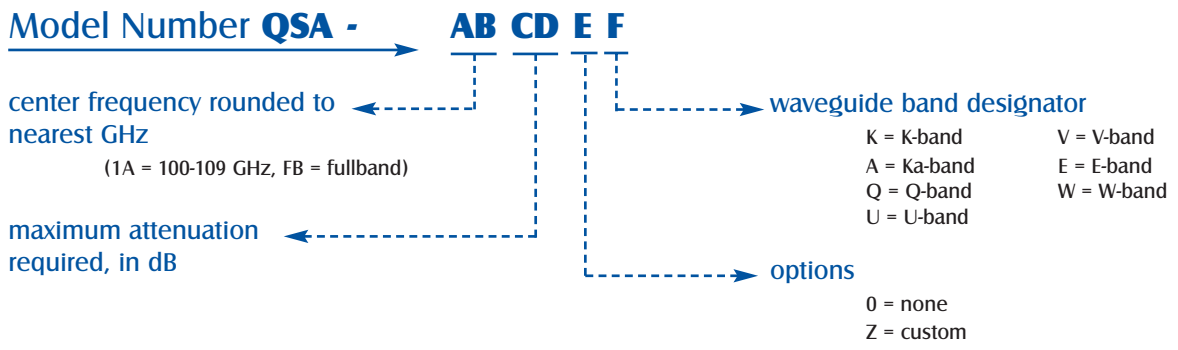



### Characteristics

- ◆ Single, Double and Multi-Throw Versions
- ◆ Broad RF Bandwidth
- ◆ Low Insertion Loss
- ◆ High Speed Switching Option



### Product Description

QuinStar Technology's **QSS**, **QSD** and **QSn** series millimeter-wave broadband **PIN switches** cover the frequency range of 18 to 110 GHz in seven waveguide bands. These waveguide switches are constructed with a rugged, split-block mechanical design that utilizes PIN diodes. Most standard switches operate over a full waveguide band, and all can be optimized over a specific narrower frequency

range for better isolation or lower insertion loss. They are ideal for signal attenuation, on/off switching such as receiver protection, and variable pulse width control. The switches can handle RF power levels of up to 1 Watt and optional integral drivers that accept a TTL input as the control signal are available.

### Specifications

FREQUENCY BAND		K	Ka	Q	U	V	E	W	
Frequency Range (GHz)		18-26.5	26.5-40	33-50	40-60	50-75	60-90	75-110	
Waveguide Size		WR-42	WR-28	WR-22	WR-19	WR-15	WR-12	WR-10	
Bandwidth (GHz min)		Full	Full	Full	Full	10	10	10	
Insertion Loss (dB max)	QSS	1.0	1.0	1.0	1.2	1.5	2.0	2.0	
	QSD	1.5	1.5	1.5	1.7	2.0	2.5	2.5	
	QSn	> 2 throws/Consult Factory							
Isolation (dB min)		23	23	23	23	20	20	20	
DC Bias Input <sup>1</sup>	Low Loss (Reverse)	+5V, -5V							
	Isolation (Forward)	25mA							
Switching Speed (ns typ) <sup>2</sup>		250	250	250	250	250	250	250	
VSWR (typ)		2:1	2:1	2:1	2:1	2:1	2:1	2:1	

<sup>1</sup> For ON-state (low insertion loss), the switch requires a reverse voltage of 10 Volts; for OFF-state (isolation), a forward bias current of up to 25 mA is needed. For integral driver option, bias voltage supplies of +5 V and -10 V are required. The switch is controlled by TTL signals.

<sup>2</sup> Standard PIN switches require a total switching time of 350 ns max. Faster switching speed options (< 10 ns) are available.

### Outline Drawings/Mechanical Specifications

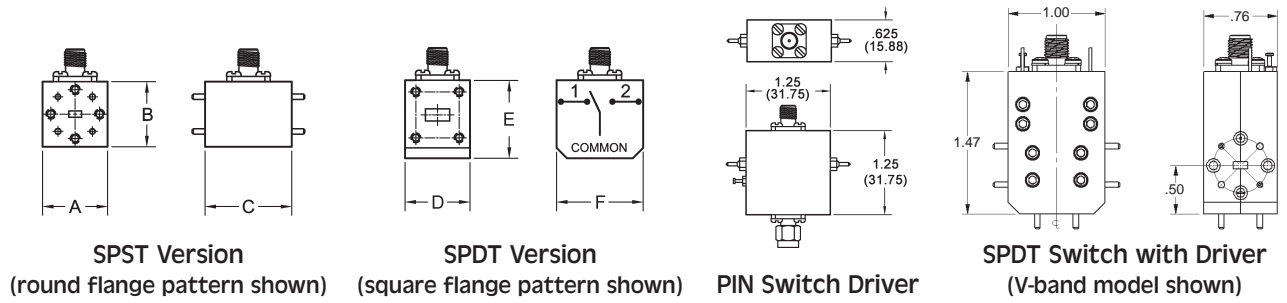

FREQUENCY BAND	WAVEGUIDE SIZE	FLANGE PATTERN	BIAS INPUT	OUTLINE DIMENSIONS, inches/mm					
				A	B	C	D	E	F
K	WR-42	UG-595/U	SMA JACK	0.88/22.4	0.88/22.4	1.50/38.1	0.88/2.4	0.94/23.9	1.00/25.4
Ka	WR-28	UG-599/U	SMA JACK	0.75/19.1	0.75/19.1	1.50/38.1	0.75/19.1	0.88/22.4	1.00/25.4
Q	WR-22	UG-383/U	SMA JACK	1.13/28.7	1.13/28.7	1.00/25.4	1.13/28.7	1.31/33.3	1.50/38.1
U	WR-19	UG-383/U	SMA JACK	1.13/28.7	1.13/28.7	1.00/25.4	1.13/28.7	1.31/33.3	1.50/38.1
V	WR-15	UG-385/U	SMA JACK	0.75/19.1	0.75/19.1	0.75/19.0	0.75/19.1	0.88/22.4	1.00/25.4
E	WR-12	UG-387/U	SMA JACK	0.75/19.1	0.75/19.1	0.75/19.0	0.75/19.1	0.88/22.4	1.00/25.4
W	WR-10	UG-387/U	SMA JACK	0.75/19.1	0.75/19.1	0.75/19.0	0.75/19.1	0.88/22.4	1.00/25.4

Consult factory for dimensions on switches with greater than 2 throws.

### Ordering Information

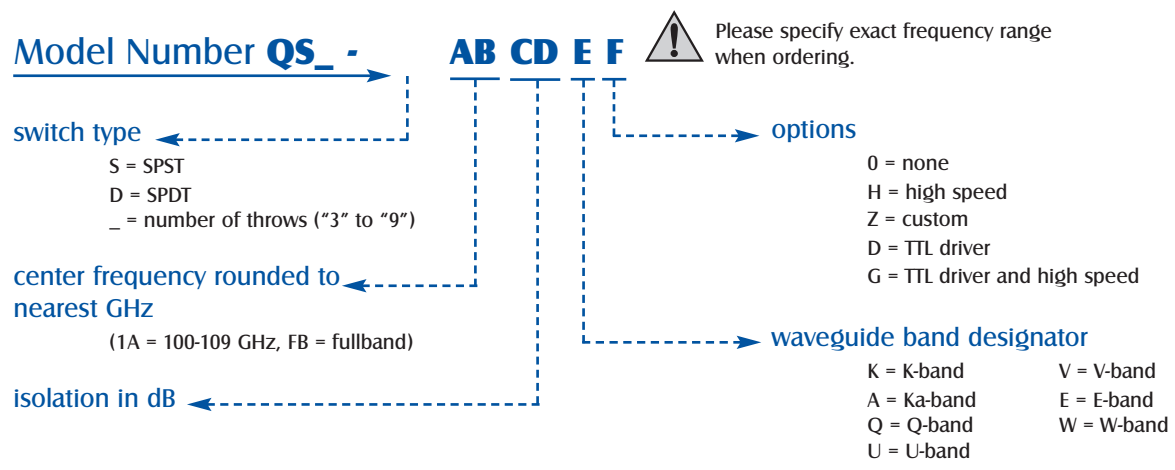



# Coax PIN Switches

## QSC

### Characteristics

- ◆ Fullband Operation
- ◆ Fast Switching Speed
- ◆ High Isolation

### Product Description

QuinStar Technology's **QSC** series coaxial **PIN** switches provide fast, high isolation and low insertion loss switching over the full K- and Ka- frequency bands. They are available in SPST and SPDT configurations and feature a compact package that incorporates the driver circuitry.



Standard input/output RF ports are K-female connectors, and DC bias/control signal is via feed-through pins. These switches are well suited for pulse modulation and receiver protection in broadband systems utilizing coaxial components.

### Specifications

FREQUENCY BAND	K	Ka	K-Ka
Frequency Range (GHz)	18-26.5	26.5-40	18-40
Connectors	K-F	K-F	K-F
Insertion Loss (dB max)	1.5	2.5	2.5
Isolation (dB min)	28	26	28
Switching Speed (ns typ)	5	5	6
DC Bias	-5V, +5V; 50mA		
Control Signal	TTL		

### Outline Drawings/Mechanical Specifications

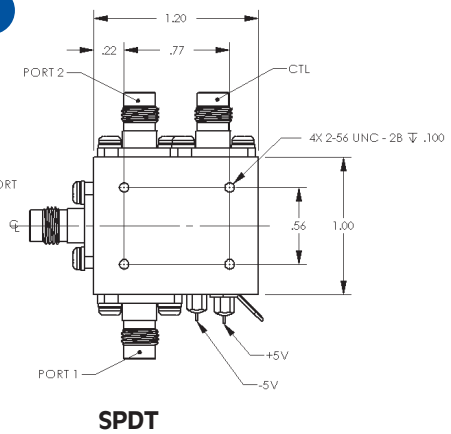
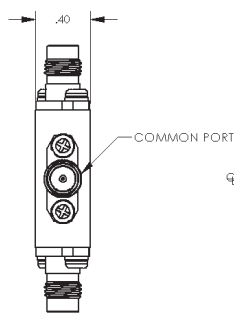
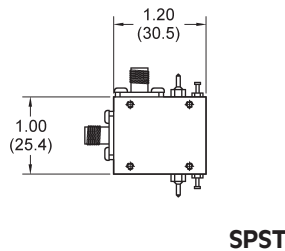

### Ordering Information

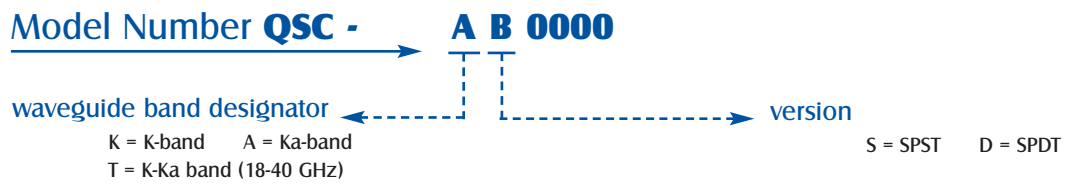



## Section 5

# Waveguide Products and Filters

Product Title	Model No.	Page Number
<b>Waveguide Products and Filters</b>		93
Glossary of Waveguide Products & Filters		94
Precision General Purpose Couplers	<b>QJG</b>	95
Precision High Directivity Couplers	<b>QJR</b>	97
Bidirectional and Dual-directional Waveguide Couplers	<b>QBC</b>	99
Broadband Waveguide Directional Coupler	<b>QDC</b>	101
Precision Crossguide Couplers	<b>QJC</b>	103
General Purpose Crossguide Couplers	<b>QJX</b>	105
Matched Hybrid Tees	<b>QJH</b>	107
Short Slot Hybrid Power Divider	<b>QSP</b>	109
Single and Triple Hybrid Ring Power Dividers	<b>QHR</b>	111
Multi-Output Power Dividers	<b>QMD</b>	112
Bandpass Filters	<b>QFB</b>	113
High Pass and Low Pass Filters	<b>QFL/QFH</b>	115
Notch Filter	<b>QNF</b>	117
E and H Plane Waveguide Tees	<b>QUH</b>	118
Waveguide Straight Sections, Terminations, Tapered Transitions	<b>QWS/QWN/QWP</b>	119
Custom Waveguide Assemblies	<b>QAC</b>	121
Medium and High Power Terminations	<b>QTG/QTH</b>	122
Waveguide Bends and Twists	<b>QWB/QWT</b>	124
Tunable Loads, Tunable Shorts, and E-H Tuners	<b>QWG/QAT/QWU</b>	125
Waveguide Flanges, Adapters and Associated Hardware	<b>QBA/QFA/QFF/QDP/QFS/QDJ</b>	126
Precision Drill Jig, Flange Pins and Screws, Waveguide Stands	<b>QDP,QFS,QDJ</b>	127
Pressurizing Unit	<b>QPU</b>	129
Waveguide to Coax Adapters	<b>QWA</b>	130

# Glossary of Waveguide Products and Filters

**Center frequency** – The nominal frequency at which bandpass filters are geometrically centered. For example, if |1 and |2 represent the 3 dB frequency points of a bandpass filter, then the center frequency |0 is calculated as follows:

$$f_0 = \sqrt{f_1 \times f_2}$$

When the bandwidth,  $f_2 - f_1$ , is a small percentage of the value of  $f_0$ , then  $f_0$ , the geometric mean between  $f_2$  and  $f_1$  will approximately equal the arithmetic mean between  $f_2$  and  $f_1$ , i.e., the average  $(f_2 + f_1)/2$ .

**Cut-off frequency (corner frequency)** – This frequency is generally 3 dB below the insertion loss of the filter; it denotes the point at which the filter is considered to be rejecting unwanted signals. Above (or below) this frequency the filter is said to be in its passband and exhibits a low loss. This is the frequency that marks the edge of the passband of a filter and the beginning of the transition to the stopband. In waveguide, this figure is the lowest frequency at which the waveguide propagates energy in some particular mode without attenuation.

**Group delay** – The amount of time it takes for a signal having a finite time duration, such as a pulse, to pass through the filter. Ideally, all frequencies present in the signal should have the same time delay, so that the signal will not be distorted. In most types of filters, this is not the case, and group delay defined as  $d\theta/d\omega$  varies with frequency. For linear phase filters the group delay is constant. It is observed that the linear phase filters have a much lower and flatter value of group delay.

**Insertion loss** – Insertion loss is equal to the difference in its power measured at the component input and output. The power measured at the input is equal to the measured power when the component is replaced by a properly matched power meter or network analyzer. The input impedance of the measuring instrument should be equal to the characteristic impedance of the system. Similarly, the power measured at the output is equal to the measured power when the component is terminated by the same measuring instrument. The insertion loss will be equal to the sum of three loss factors. One is the loss due to the impedance mismatch at the input, the second is due to the mismatch at the output, and the third is due to the dissipative loss associated with each reactive element within the component.

**Linear phase or flat time delay** – Filters have the characteristic of enabling the signal at the filter output to have a constant phase difference for each fixed increment of frequency difference of the signal. Thus,

$$\Delta\theta = K \Delta f$$

where K is a constant. This enables the transmission of various frequency components contained in a pulse waveform to be delayed by the same amount while traveling through the filter thus preserving the pulse wave shape.

**Passband** – Passband is the desired band of frequencies in which the only loss is the insertion loss of the filter. It is the actual band of frequencies, which the filter is required to pass through with very little effect on system performance. Most of the QuinStar's low pass filter models are specified to have a maximum insertion loss value of 1.5 dB within the passband.

**Rejection band (stopband)**– The frequency range(s) which are undesired and must be strongly attenuated from the stopband or rejection band. The term "rejection" indicates the amount of attenuation of specific frequencies within this undesired frequency range.

**VSWR** - VSWR is a measure of the impedance looking into one port of the filter while the other filter port is terminated in its characteristic impedance. Many time, the impedance match is expressed in terms of return loss. The conversion between return loss and VSWR can be carried out using the chart given in the reference materials section.

**Average power handling capacity** – The CW average power handling capability with one-way transmission through the main line of the component under matched load conditions

**Bandwidth** – The range of frequencies over which performance falls within specific limits.

**Bidirectional coupler** – Another name for a 4-port coupler; that is, a single coupler having no internal termination. It is intended to allow forward and reflected signals to be sampled simultaneously.

**Coupling coefficient of a coupler** – The ratio in dB of the incident power fed into the main port to the coupled port power when all ports are terminated by reflectionless terminations. See figure below.

$$\text{Coupling value} = -10 \log_{10} (P_3/P_1).$$

**Coupling flatness** – The maximum peak-to-peak variation in coupling coefficient that may be expected over a specified frequency range.

**Coupling tolerance** – The allowable unit-to unit variation in nominal coupling.

**Directivity** - The difference in dB of the power output at a coupled port, when power is transmitted in the desired direction, to the power output at the same coupled port when the same amount of power is transmitted in the opposite direction. In the case of a bidirectional coupler, an alternative definition is the difference in dB of the power output of the two coupled ports, when power is transmitted in a constant direction on the main line. Reflectionless terminations are assumed to be connected to all ports. See figure below.

$$\text{Directivity} = 10 \log_{10} (P_3/P_3').$$

**Main-line loss** – The change in load power, due to the insertion of the coupler in a transmission system, with reflectionless terminations connected to the ports of the coupler. The main-line loss includes the effect of power transferred to the coupled line. See figure below.

$$\text{Main line loss} = 10 \log_{10} [(P_2+P_3)/P_1].$$

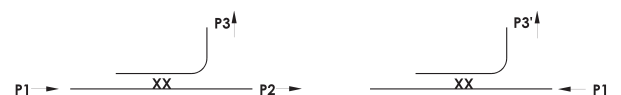

## Characteristics

- ◆ Fullband Coverage
- ◆ Excellent Coupling Accuracy
- ◆ Low VSWR
- ◆ High Directivity



## Product Description

QuinStar Technology's **QJG** series of **precision general purpose directional couplers** cover the frequency range of 18 to 170 GHz in nine waveguide bands. They are available in 3 and 4 port configurations with coupling values of 3, 6, 10, 20, 30 and 40 dB. They are constructed with a rugged splitblock mechanical design for long-lasting durability to maintain their coupling value.

transmission line without affecting the transmitting signal. They prove especially useful in applications such as RF power and signal reflection measurements in test systems. The directivity, insertion loss, and coupling flatness characteristics make these directional couplers useful for a wide range of laboratory requirements and subsystem applications.

Precision general purpose directional couplers are ideal devices for sampling or inserting RF energy in a waveguide

## Specifications

FREQUENCY BAND	K	Ka	Q	U	V	E	W	F	D
Frequency Range (GHz)	18-26.5	26.5-40	33-50	40-60	50-75	60-90	75-110	90-140	110-170
Waveguide Size	WR-42	WR-28	WR-22	WR-19	WR-15	WR-12	WR-10	WR-8	WR-6
Coupling Values (dB) (Nominal $\pm 1.0$ dB at center frequency)	3, 6, 10, 20, 30 and 40 (For 3 and 6 dB, please consult factory for all bands)								
Coupling Flatness ( $\pm$ dB typ)	0.8	0.8	0.8	0.8	0.8	0.8	0.9	1.0	1.0
Directivity (dB typ) <sup>1</sup>	3, 6 dB couplers	20	20	20	20	20	20	20	20
	10, 20 dB couplers	25	25	25	25	25	25	25	25
	30, 40 dB couplers	15	15	15	15	15	15	15	15
Insertion Loss, dB <sup>2</sup>	0.7	0.7	0.7	0.7	0.8	1.4	1.4	2.0	2.0
VSWR, Main Line (max)	3, 6 dB couplers	1.2:1	1.2:1	1.2:1	1.2:1	1.2:1	1.2:1	1.2:1	1.25:1
	10, 20, 30, 40 dB couplers	1.1:1	1.1:1	1.1:1	1.1:1	1.2:1	1.2:1	1.2:1	1.25:1
VSWR, Secondary Line (max)	3, 6 dB couplers	1.2:1	1.2:1	1.2:1	1.2:1	1.2:1	1.25:1	1.25:1	1.3:1
	10, 20, 30, 40 dB couplers	1.1:1	1.1:1	1.1:1	1.1:1	1.2:1	1.25:1	1.25:1	1.3:1

Other waveguide sizes are available.

<sup>1</sup> Directivity is the difference between power levels at the coupled port when input and output ports are interchanged.

<sup>2</sup> Insertion loss is defined as the power loss in excess of the loss due to coupling.

## Outline Drawings/Mechanical Specifications

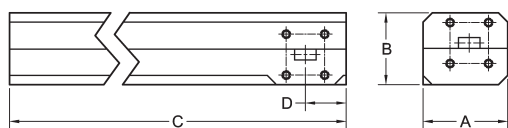

WR-42 and WR-28

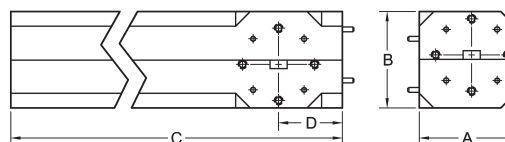

WR-22 through WR-6

FREQ. BAND	WAVEGUIDE SIZE	FLANGE PATTERN	OUTLINE DIMENSIONS, inches/mm			
			A	B	C	D
K	WR-42	UG-595/U	1.40/35.6	1.10/27.9	7.75/196.8	0.44/11.2
Ka	WR-28	UG-599/U	1.10/27.9	0.93/23.6	6.21/157.7	0.53/13.5
Q	WR-22	UG-383/U	1.25/31.8	1.25/31.8	5.50/139.7	0.83/21.1
U	WR-19	UG-383/U	1.25/31.8	1.25/31.8	5.50/139.7	0.83/21.1
V	WR-15	UG-385/U	1.20/30.5	0.834/21.2	3.84/97.5	0.60/15.2
E	WR-12	UG-387/U	1.20/30.5	0.825/21	3.4/86.4	0.60/15.2
W	WR-10	UG-387/U	1.20/30.5	0.80/20.3	3.24/82.3	0.60/15.2
F	WR-8	UG-387/U	1.20/30.5	0.80/20.3	2.42/61.5	0.60/15.2
D	WR-6	UG-387/U	1.20/30.5	0.80/20.3	2.82/71.6	0.60/15.2

## Ordering Information

Model Number **QJG -**

**A BC D E O**

waveguide band designator

K = K-band  
A = Ka-band  
Q = Q-band  
U = U-band  
V = V-band  
E = E-band  
W = W-band  
F = F-band  
D = D-band

version

0 = standard  
Z = custom

number of ports

3 = 3 ports  
4 = 4 ports

coupling value in dB

03, 06, 10, 20, 30 or 40



# Precision High Directivity Couplers

**QJR**

## Characteristics

- ◆ Fullband Coverage
- ◆ Excellent Coupling Flatness and Accuracy
- ◆ Low VSWR
- ◆ Very High Directivity

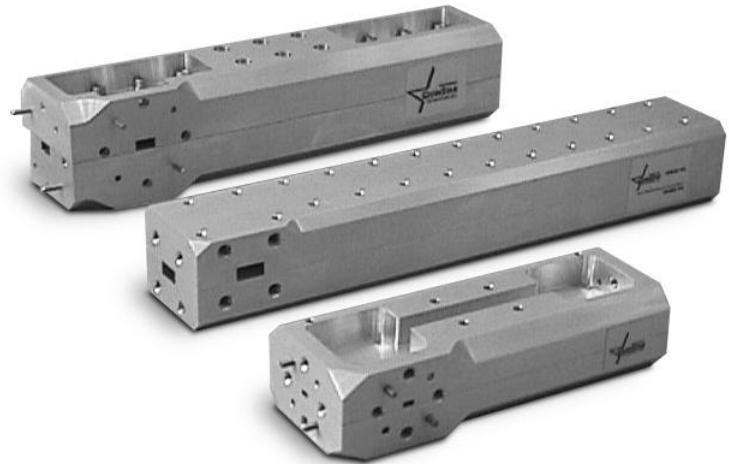

## Product Description

QuinStar Technology's **QJR series precision high directivity couplers** cover the frequency range of 18 to 170 GHz in nine waveguide bands. They are available in 3 and 4 port configurations with coupling values of 3, 6, 10, 20, 30 and 40 dB. They are constructed with a rugged splitblock mechanical design for long-lasting durability to maintain their coupling value.

transmission line without affecting the transmitting signal. They prove especially useful in applications such as RF power and signal reflection measurements in test systems. The superior directivity, insertion loss, coupling flatness and accuracy also make these directional couplers useful for a wide range of laboratory requirements and subsystem applications. In addition to the standard three-port directional couplers, QuinStar offers custom four-port directional couplers.

Precision high directivity directional couplers are ideal devices for sampling or inserting RF energy in a waveguide

## Specifications

FREQUENCY BAND	K	Ka	Q	U	V	E	W	F	D
Frequency Range (GHz)	18-26.5	26.5-40	33-50	40-60	50-75	60-90	75-110	90-140	110-170
Waveguide Size	WR-42	WR-28	WR-22	WR-19	WR-15	WR-12	WR-10	WR-8	WR-6
Coupling Values (dB at center frequency)	3, 6, 10, 20, 30 and 40 ± 1								
Coupling Flatness (±dB typ)	0.7	0.7	0.7	0.7	0.7	0.8	0.8	1.0	1.0
Directivity (dB typ) <sup>1, 3</sup>	37	37	37	37	35	35	35	30	28
Insertion Loss (dB max) <sup>2</sup>	0.7	0.7	0.7	0.7	0.8	1.0	1.2	2.0	2.5
VSWR, Main Line (max)	1.1:1	1.1:1	1.1:1	1.1:1	1.1:1	1.1:1	1.1:1	1.15:1	1.15:1
VSWR, Secondary Line (max)	1.1:1	1.1:1	1.1:1	1.1:1	1.1:1	1.15:1	1.15:1	1.2:1	1.21:1

Other waveguide sizes are available.

<sup>1</sup> Directivity is the difference between power levels at the coupled port when input and output ports are interchanged.

<sup>2</sup> Insertion loss is defined as the power loss in excess of the loss due to coupling.

<sup>3</sup> For 30 dB and 40 dB couplers: directivity = 25 dB typ.

### Outline Drawings/Mechanical Specifications

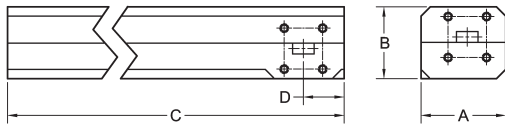

WR-42 and WR-28

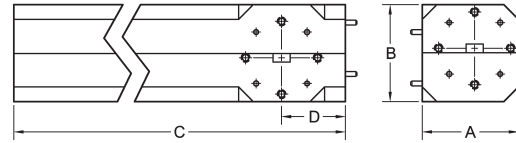

WR-22 through WR-6

FREQ. BAND	WAVEGUIDE SIZE	FLANGE PATTERN	OUTLINE DIMENSIONS, inches/mm			
			A	B	C	D
K	WR-42	UG-595/U	1.40/35.6	1.10/27.9	7.75/196.8	0.44/11.2
Ka	WR-28	UG-599/U	1.10/27.9	0.93/23.6	6.21/157.7	0.53/13.5
Q	WR-22	UG-383/U	1.25/31.8	1.25/31.8	5.50/139.7	0.83/21.1
U	WR-19	UG-383/U	1.25/31.8	1.25/31.8	5.50/139.7	0.83/21.1
V	WR-15	UG-385/U	1.20/30.5	0.834/21.2	3.84/97.5	0.60/15.2
E	WR-12	UG-387/U	1.20/30.5	0.825/21	3.4/86.4	0.60/15.2
W	WR-10	UG-387/U	1.20/30.5	0.80/20.3	3.24/82.3	0.60/15.2
F	WR-8	UG-387/U	1.20/30.5	0.80/20.3	2.42/61.5	0.60/15.2
D	WR-6	UG-387/U	1.20/30.5	0.80/20.3	2.82/71.6	0.60/15.2

### Ordering Information

Model Number **QJR -**

**A BC D E O**

waveguide band designator

K = K-band  
A = Ka-band  
Q = Q-band  
U = U-band  
V = V-band  
E = E-band  
W = W-band  
F = F-band  
D = D-band

version

0 = standard  
Z = custom

number of ports

3 = 3 ports  
4 = 4 ports

coupling value in dB

03, 06, 10, 20, 30 or 40



# Bi-directional and Dual-directional Waveguide Couplers

QBC

## Characteristics

- ◆ Convenient Configurations
- ◆ High Directivity
- ◆ Full Waveguide Bandwidth

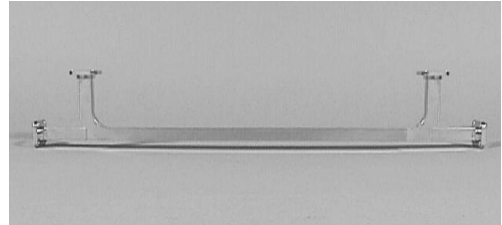

## Product Description

QuinStar products QBC series bi-directional and dual couplers are 4-port broadband, broadwall components with an inherently high directivity. Figure 1 below explains the port configurations and the difference between these two types of 4-port directional couplers. **Bidirectional Couplers** typically require an external load or termination on one of the coupled ports, while using the other coupled port for measurements. **Dual-directional couplers** are essentially

two complete directional couplers, in-line (back-to-back), each with its own internal load or termination. Dual-directional couplers are useful in simultaneously sampling or monitoring the signals in both directions of the main arm of the coupler, for example, the transmitted and reflected signals. The QBC series couplers are available in 3 dB, 6 dB, 10 dB, 20 dB, 30 dB, and 40 dB coupling values for standard waveguide bands from 26.5 to 110.0 GHz.

## Specifications

WAVEGUIDE BAND	Ka	Q	U	V	E	W
Frequency Range (GHz)	26.5-40.0	33.0-50.0	40.0-60.0	50.0-75.0-	60.0-90.0	75.0-110.0
Coupling (dB)	3, 6, 10, 20, 30, 40					
Coupling Variation (dB)	+/- 0.7	+/- 0.7	+/- 0.8	+/- 1.0	+/- 1.0	+/- 1.0
Coupling Accuracy (dB)	+/- 1.0	+/- 1.0	+/- 1.2	+/- 1.5	+/- 1.5	+/- 1.5
Directivity (dB) Typical	30	30	30	30	30	30
Main Line VSWR, typ	1.05	1.05	1.10	1.10	1.10	1.10
Coupled Arm VSWR, typ.	1.15	1.15	1.20	1.20	1.20	1.20



BIDIRECTIONAL COUPLER

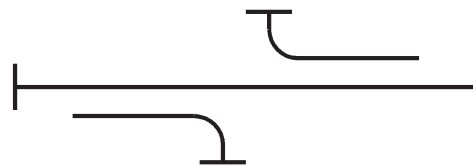

DUAL COUPLER

Figure 1



# Bi-directional and Dual-directional Waveguide Couplers

QBC

## Outline Drawings/Mechanical Specifications

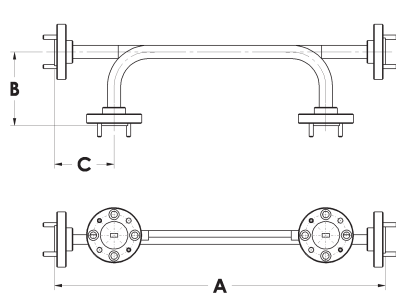

Bidirectional Coupler

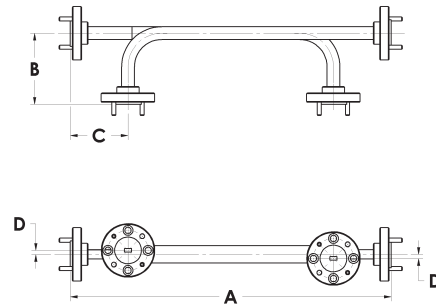

Dual-directional Coupler

WAVEGUIDE BAND	COUPLING VALUES, dB	OUTLINE DIMENSIONS, inches/mm			
		A	B	C	D
KA	10, 20, 30, 40	9.62/244.0	1.75/44.5	1.38/35.1	.16/4.06
KA	3, 6	12.0/304.8	1.75/44.5	1.38/35.1	.16/4.06
Q	10, 20, 30, 40	8.40/213.0	1.674/41.7	1.30/33.0	.13/3.30
Q	3, 6	10.25/259.1	1.64/41.7	1.30/33.0	.13/3.30
U	10, 20, 30, 40	7.38/187.4	1.38/35.1	1.12/28.5	.11/2.80
U	3, 6	9.12/231.6	1.38/35.1	1.12/28.5	.11/2.80
V	10, 20, 30, 40	6.285/159.0	1.13/28.6	0.88/22.4	.08/2.03
V	3, 6	7.25/184.1	1.13/28.7	0.88/22.4	.08/2.03
E	10, 20, 30, 40	5.50/140.0	1.13/28.5	0.88/22.4	.07/1.78
E	3, 6	6.62/168.1	1.13/28.7	0.88/22.4	.07/1.78
W	10, 20, 30, 40	4.50/114.0	1.00/25.4	0.81/20.6	.06/1.52
W	3, 6	5.50/139.7	1.00/25.4	0.81/20.6	.06/1.52

## Ordering Information

Model Number **QBC -**

**A B CD EFG**

coupler type:

- B = Bi-directional coupler
- D = Dual-directional coupler

flange type

(see appendix A-H)

waveguide band

- A = Ka-band
- Q = Q-band
- U = U-band
- V = V-band
- E = E-band
- W = W-band

coupling value, in dB



# Broadband Waveguide Directional Couplers

## QDC

### Characteristics

- ◆ Broadband
- ◆ Low VSWR
- ◆ High Directivity
- ◆ Minimum Coupling Variation with Frequency



### Product Description

QuinStar products QDC series broadband directional couplers are multi-hole waveguide couplers. The QDC series couplers are offered in 7 waveguide sizes from 18.0 to 110 GHz. Nominal coupling of 3 dB, 6 dB, 10 dB, 20 dB, 30 dB, and 40 dB are offered as standard products. Two different mechanical configurations or outlines are offered for these waveguide couplers- one with E-plane bend

and the other with H-plane bend in the coupled port to suit the physical layout of all applications or test set requirements.

QuinStar also offers Series QJG and QJR Precision Directional Couplers in rectangular block geometry.

### Specifications

WAVEGUIDE BAND	K	Ka	Q	U	V	E	W
Frequency Range (GHz)	18.0-26.5	26.5-40.0	33.0-50.0	40.0-60.0	50.0-75.0	60.0-90.0	75.0-110.0
Coupling (dB)	3, 6, 10, 20, 30, 40						
Coupling Variation (dB)	+/- 0.6	+/- 0.6	+/- 0.6	+/- 0.8	+/- 1.0	+/- 1.0	+/- 1.0
Coupling Accuracy (dB)	+/- 1.0	+/- 1.0	+/- 1.0	+/- 1.2	+/- 1.5	+/- 1.5	+/- 1.5
Directivity (dB) Typical	35	35	35	35	35	35	30
Main Line VSWR	1.05	1.05	1.05	1.10	1.10	1.10	1.10
Coupled Line VSWR	1.12	1.12	1.12	1.15	1.15	1.15	1.17



# Broadband Waveguide Directional Couplers

QDC

## Outline Drawings/Mechanical Specifications

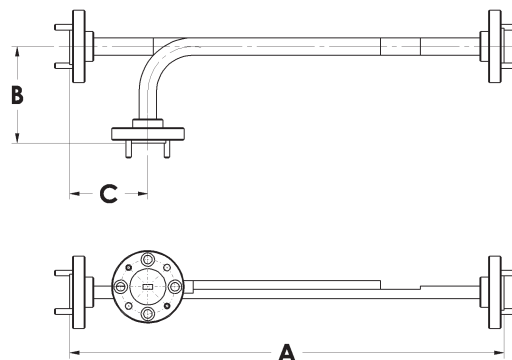

FREQUENCY BAND AND COUPLING LEVEL (dB)	OUTLINE DIMENSIONS, inches/mm			
	A	B	C	D
K 10, 20, 30, 40	11.50/292.0	2.00/50.8	1.50/38.1	.25/6.35
K 3, 6	12.75/323.9	2.00/50.8	38.1/38.1	.25/6.35
Ka 10, 20, 30, 40	9.62/244.0	1.75/44.5	1.38/35.1	.16/4.06
Ka 3, 6	12.0/304.8	1.75/44.5	1.38/35.1	.16/4.06
Q 10, 20, 30, 40	8.40/213.0	1.64/41.7	1.30/33.0	.13/3.30
Q 3, 6	10.25/259.1	1.64/41.7	1.30/33.0	.13/3.30
U 10, 20, 30, 40	7.38/187.4	1.38/35.1	1.12/28.5	.11/2.80
U 3, 6	9.12/231.6	1.38/35.1	1.12/28.5	.11/2.80
V 10, 20, 30, 40	6.25/159.0	1.13/28.6	0.88/22.4	.08/2.03
V 3, 6	7.25/184.1	1.13/28.7	0.88/22.4	.08/2.03
E 10, 20, 30, 40	5.50/140.0	1.13/28.5	0.88/22.4	.07/1.78
E 3, 6	6.62/168.1	1.13/28.7	0.88/22.4	.07/1.52
W 10, 20, 30, 40	4.50/114.0	1.00/25.4	0.81/20.6	.06/1.52
W 3, 6	5.50/139.7	1.00/25.4	0.81/20.6	.06/1.52

## Ordering Information

Model Number **QDC - A B CD 00**

Coupled Port Configuration

E = E-plane bend on coupled port  
H = H-plane bend on coupled port

Coupling Level in dB

Waveguide Band

K = K-band                      V = V-band  
A = Ka-band                    E = E-band  
Q = Q-band                      W = W-band  
U = U-band

## Characteristics

- ◆ Compact Size
- ◆ Low Insertion Loss
- ◆ Excellent Coupling Accuracy and Good Directivity



## Product Description

QuinStar Technology's **QJC** series of compact **precision crossguide directional couplers** cover the frequency range of 18 to 170 GHz in nine waveguide bands. Three- and four-port configurations are available for standard models with midband nominal coupling values of 20, 30 and 40 dB. Other coupling values are available as custom products. Crossguide couplers are ideal devices for sampling or inserting RF energy in a waveguide transmission

line without affecting the transmitting signal. Typical applications include frequency monitoring, power sampling and built-in testing. The crossguide type of directional coupler has the advantage of lower insertion loss, smaller size and lower cost when compared to broadwall directional couplers. QuinStar can provide custom configurations and application-specific interfaces to suit unique needs.

## Specifications

FREQUENCY BAND	K	Ka	Q	U	V	E	W	F	D
Frequency Range (GHz)	18-26.5	26.5-40	33-50	40-60	50-75	60-90	75-110	90-140	110-170
Waveguide Size	WR-42	WR-28	WR-22	WR-19	WR-15	WR-12	WR-10	WR-8	WR-6
Coupling Values (dB at center frequency)	Standard (20, 30 and 40 ± 1); Custom (17 to 40)								
Bandwidth (min)	20% of waveguide band								
Insertion Loss (dB max) <sup>1</sup>	0.4	0.4	0.5	0.6	0.6	0.8	1.0	1.2	1.3
Directivity (dB typ) <sup>2</sup>	20	20	20	20	20	20	20	15	15
Main Line VSWR (max)	1.15:1	1.15:1	1.15:1	1.15:1	1.2:1	1.2:1	1.2:1	1.2:1	1.25:1
Secondary Line VSWR (max)	1.2:1	1.2:1	1.2:1	1.2:1	1.25:1	1.25:1	1.25:1	1.25:1	1.25:1
Coupling Flatness (± dB typ)	1.5	1.5	1.5	1.5	1.8	1.8	1.8	2.0	2.0

<sup>1</sup> Insertion loss is defined as the power loss in excess of the loss due to coupling.

<sup>2</sup> Directivity is the difference between power levels at the coupled port when input and output ports are interchanged.

## Outline Drawings/Mechanical Specifications



WR-42 and WR-28

WR-22 through WR-6

FREQUENCY BAND	WAVEGUIDE SIZE	FLANGE PATTERN	OUTLINE DIMENSIONS, inches/mm	
			A	B, C
K	WR-42	UG-595/U	1.25/31.8	1.25/31.8
Ka	WR-28	UG-599/U	0.90/22.9	1.00/25.4
Q	WR-22	UG-383/U	1.38/35.1	1.38/35.1
U	WR-19	UG-383/U	1.38/35.1	1.38/35.1
V	WR-15	UG-385/U	0.84/21.3	1.00/25.4
E	WR-12	UG-387/U	0.84/21.3	1.00/25.4
W	WR-10	UG-387/U	0.84/21.3	1.00/25.4
F	WR-8	UG-387/U	0.84/21.3	1.00/25.4
D	WR-6	UG-387/U	0.84/21.3	1.00/25.4

## Ordering Information

Model Number **QJC -**

**AB CD E F**



Please specify exact center frequency when ordering.

center frequency rounded to nearest GHz  
(1A = 100-109 GHz, 1B = 110-119 GHz, etc.)

coupling value in dB (20, 30, 40 for standard products)

waveguide band designator

K = K-band                      E = E-band  
A = Ka-band                    W = W-band  
Q = Q-band                      F = F-band  
U = U-band                       D = D-band  
V = V-band

number of ports

3 = 3 ports  
4 = 4 ports



# General Purpose Crossguide Couplers

QJX

## Characteristics

- ◆ Compact Size
- ◆ Low Insertion Loss
- ◆ Low Cost/Moderate Performance

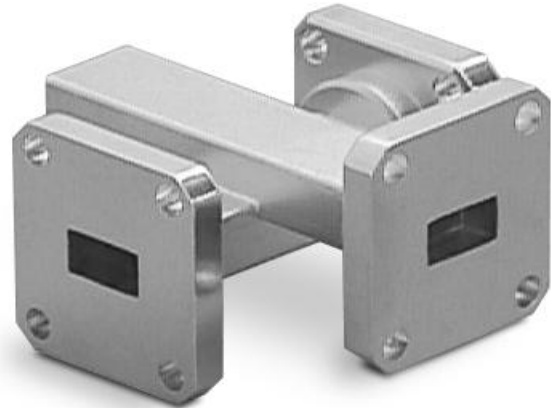

## Product Description

QuinStar Technology's **QJX** series of compact **general purpose** 3-port **crossguide directional couplers** cover the frequency range of 18 to 60 GHz in four waveguide bands with midband nominal coupling values of 20 and 30 dB. These crossguide couplers are ideal devices for sampling or inserting RF energy in a waveguide transmission line

without affecting the transmitting signal. Typical applications include frequency monitoring, power sampling and built-in testing. The crossguide type of directional coupler has the advantage of lower insertion loss, smaller size and lower cost when compared to broadwall directional couplers.

## Specifications

FREQUENCY BAND	K	Ka	Q	U
Frequency Range (GHz)	18-26.5	26.5-40	33-50	40-60
Waveguide Size	WR-42	WR-28	WR-22	WR-19
Coupling Values, (dB at center frequency)	20 and 30 ± 2 dB			
Bandwidth (min)	20% of waveguide band			
Insertion Loss (dB max) <sup>1</sup>	0.5	0.5	0.6	0.7
Directivity (dB typ) <sup>2</sup>	15			
Main Line VSWR (max)	1.15:1			
Secondary Line VSWR (max)	1.2:1			
Coupling Flatness (dB max)	± 1.5			

<sup>1</sup> Insertion loss is defined as the power loss in excess of the loss due to coupling.

<sup>2</sup> Directivity is the difference between power levels at the coupled port when input and output ports are interchanged.



# General Purpose Crossguide Couplers

**QJX**

## Outline Drawing/Mechanical Specifications

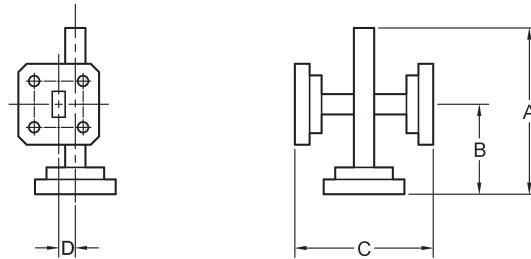

FREQUENCY BAND	WAVEGUIDE SIZE	FLANGE PATTERN	OUTLINE DIMENSIONS, inches/mm		
			A, C	B	D
K	WR-42	UG-595/U	2.00/50.8	1.00/25.4	0.19/4.7
Ka	WR-28	UG-599/U	1.50/38.1	0.75/19.1	0.16/4.1
Q	WR-22	UG-383/U	1.50/38.1	0.75/19.1	0.13/3.2
U	WR-19	UG-383/U	1.50/38.1	0.75/19.1	0.11/2.8

## Ordering Information

Model Number **QJX -**

**AB CD E 0**



Please specify exact center frequency when ordering.

center frequency rounded to nearest GHz

coupling value in dB (20 or 30)

waveguide band designator

- K = K-band
- A = Ka-band
- Q = Q-band
- U = U-band

### Characteristics

- ◆ Broadband Operation
- ◆ High Isolation
- ◆ Low Insertion Loss
- ◆ Low VSWR

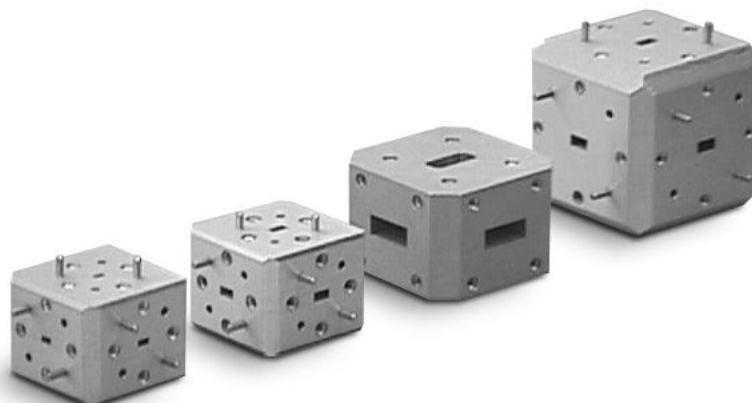

### Product Description

QuinStar Technology's **QJH** series of **matched hybrid tees (magic tees)** cover the frequency range of 18 to 170 GHz in nine waveguide bands. These four-port devices are used for balanced power-combining and/or dividing RF signals over a broad bandwidth. They are constructed using a rugged and compact split-block mechanical design with convenient interfaces. A signal entering either of the two input ports is split equally between two of the other ports and is isolated from the fourth port. The signals emanating from the "E" plane port are 180 degrees out of phase. The signals emanating from the "H" plane port are in phase. The ports are matched so that isolation between the series arm (E-plane) and the shunt arm (H-plane) is 30dB minimum. Isolation between co-linear arms is 20dB typical.

Typical applications for these tees include power dividers/combiners, bridge circuits, balanced mixers, amplifiers, and instrumentation setups. QuinStar can provide custom 4- or 8-way power dividers by combining several hybrid tees (power dividers) into a single housing. It is also possible to configure the hybrid junctions to achieve unequal power split in 3, 5, 6 or 7 ports.

QuinStar Technology can also supply custom configurations ("folded tees") with output ports in different locations than in the standard product. Other power dividers (short slot hybrids and "rat-race" hybrids) are also available as special orders. If your application requires a unique power division scheme, please contact QuinStar with your requirements.

### Specifications

FREQUENCY BAND	K	Ka	Q	U	V	E	W	F	D
Frequency Range (GHz) <sup>1</sup>	18-26.5	26.5-40	33-50	40-60	50-75	60-90	75-110	90-140	110-170
Waveguide Size	WR-42	WR-28	WR-22	WR-19	WR-15	WR-12	WR-10	WR-8	WR-6
Insertion Loss (dB max)	0.5	0.5	0.7	0.8	1.0	1.0	1.0	1.2	1.2
VSWR, H-Plane (max)	1.5:1	1.5:1	1.5:1	1.5:1	1.5:1	1.5:1	1.5:1	1.5:1	1.5:1
VSWR, E-Plane (max)	1.6:1	1.6:1	1.6:1	1.6:1	1.6:1	1.6:1	1.6:1	1.6:1	1.6:1
Balance (+/- dB typ)	0.5	0.5	0.5	0.5	0.5	0.5	0.5	0.5	0.5

Other waveguide sizes are available.

<sup>1</sup> Standard products meet full performance specifications over 80% of the waveguide band, with slightly degraded performance over the balance of the band. Narrow bandwidth versions (25% of waveguide band) with superior isolation and lower insertion loss are available.

### Outline Drawing/Mechanical Specifications

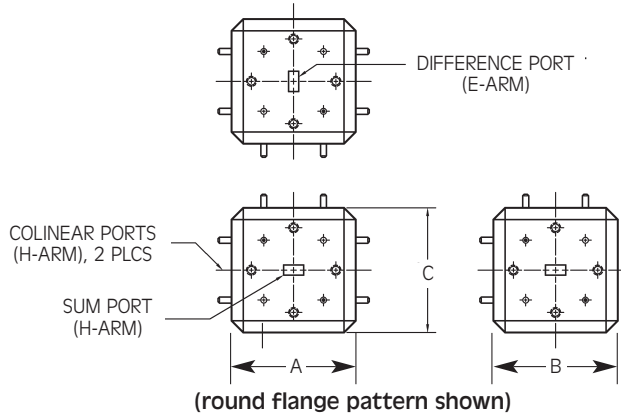

FREQUENCY BAND	WAVEGUIDE SIZE	FLANGE PATTERN	DIMENSIONS (inches/mm)		
			A	B	C
K	WR-42	UG-595/U	1.25/31.8	1.25/31.8	0.89/22.6
Ka	WR-28	UG-599/U	1.00/25.4	1.00/25.4	1.00/25.4
Q	WR-22	UG-383/U	1.38/35.1	1.38/35.1	1.38/35.1
U	WR-19	UG-383/U	1.38/35.1	1.38/35.1	1.38/35.1
V	WR-15	UG-385/U	1.00/25.4	1.00/25.4	0.80/20.3
E	WR-12	UG-387/U	1.00/25.4	1.00/25.4	0.80/20.3
W	WR-10	UG-387/U	1.00/25.4	1.00/25.4	0.80/20.3
F	WR-8	UG-387/U	1.00/25.4	1.00/25.4	0.80/20.3
D	WR-6	UG-387/U	1.00/25.4	1.00/25.4	0.80/20.3

### Ordering Information

Model Number **QJH -**

**A B CD 00**



Please specify exact center frequency when ordering narrowband version.

waveguide band designator

- K = K-band
- A = Ka-band
- Q = Q-band
- U = U-band
- V = V-band
- E = E-band
- W = W-band
- F = F-band
- D = D-band

frequency

- Fullband: FB
- Narrowband: center frequency rounded to nearest GHz  
(1A = 100-109 GHz, 1B = 110-119 GHz, etc.)

version

- U = upper 80% of waveguide band
- L = lower 80% of waveguide band
- N = narrowband
- Z = custom



# Short Slot Hybrid Power Dividers

QSP

## Characteristics

- ◆ Small
- ◆ Compact
- ◆ Negligible Coupling Variation

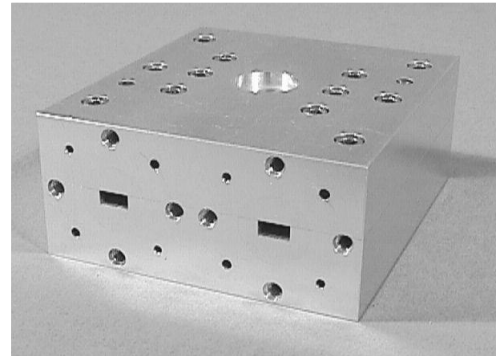

## Product Description

QuinStar Technology's short slot hybrid is a narrow wall 3 dB coupler, available in standard waveguide sizes from 18 to 110 GHz. This compact, four-port device is inherently matched and well-suited for balanced mixers and power splitting circuits. There is a 90 degree phase difference between the two output signals, while the fourth port is isolated from the input.

The QSP series short slot hybrids are power dividers (3 dB couplers) that can be used in waveguide bridge circuits, image-reject and single sideband mixers, phase shifters, and power splitters where 90 degree phase shift between output power ports is required.

## Specifications

FREQUENCY BAND	Ku	K	Ka	Q	U	V	E	W
Insertion Loss (dB) Max.	0.5	0.5	0.6	0.7	0.7	0.8	0.8	0.9
VSWR Max.	1.15	1.15	1.15	1.15	1.15	1.15	1.15	1.15
Isolation (dB) Min.	20	20	20	20	20	20	20	18
Bandwidth (GHz)	2	2	3	3	4	4	4	4

### Outline Drawings/Mechanical Specifications

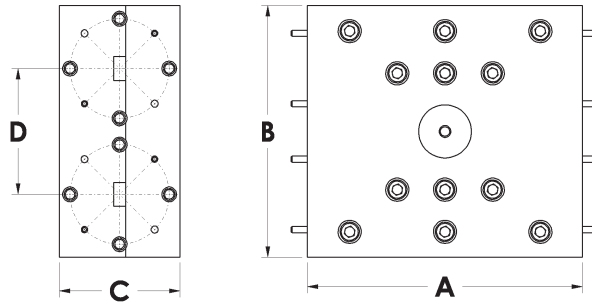

FREQUENCY BAND	OUTLINE DIMENSIONS, inches/mm			
	C	A	B	D
<b>K</b>	3.75/95.3	2.47/62.7	1.12/28.5	1.38/35.1
<b>Ka</b>	3.75/95.3	2.47/62.7	1.12/28.5	1.38/35.1
<b>Q</b>	2.60/66.0	2.37/60.2	1.14/29.0	1.18/30.2
<b>U</b>	2.60/66.0	2.37/60.2	1.14/29.0	1.18/30.2
<b>V</b>	2.45/62.2	1.75/44.5	1.0/25.4	0.90/22.86
<b>E</b>	2.45/62.2	1.75/44.5	1.0/25.4	0.90/22.86
<b>W</b>	2.45/62.2	1.75/44.5	1.0/25.4	0.90/22.86

### Ordering Information

Model Number **QSP -** **A B 0000**

waveguide band designator

- K = K-band
- A = Ka-band
- Q = Q-band
- U = U-band
- V = V-band
- E = E-band
- W = W-band

options

- 0 = standard product
- C = custom product



# Single and Triple Hybrid Ring Power Dividers

**QHR**

## Characteristics

- ◆ High Isolation
- ◆ Low Insertion Loss

## Product Description

QuinStar Technology's QHR series of hybrid rings are four-port, inherently-matched 3 dB power splitting devices. Available in standard waveguide size from 18 to 220 GHz, these units are capable of both in-phase and out-of-phase splitting.

QuinStar Technology's QHR series triple hybrid rings consist of three single hybrid rings integrated into one compact component. This device provides four output

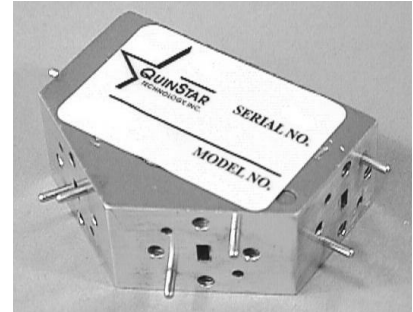

ports (each with power that is nominally 6 dB below input power level) for use in dual balanced mixers and power divider/combiner circuits.

The QHR series hybrid rings are used in balanced mixers and power divider/combiner circuits where precise power splitting, high isolation, and accurate phase inversion are necessary

## Specifications

FREQUENCY BAND	K	Ka	Q	U	V	E	W	F	D	G
Isolation (dB) Max.	20	20	20	20	20	20	20	20	20	20
Insertion Loss (dB) Max.	0.5	0.5	0.5	0.5	0.5	0.5	0.7	0.7	0.8	0.8
Power Imbalance Max (dB)	0.5	0.5	0.5	0.5	0.5	0.5	0.5	0.5	0.5	0.5
VSWR Max.	1.25	1.25	1.25	1.25	1.25	1.25	1.25	1.25	1.25	1.30
Bandwidth (GHz)	2	3	3	4	4	4	4	4	4	4

## Ordering Information

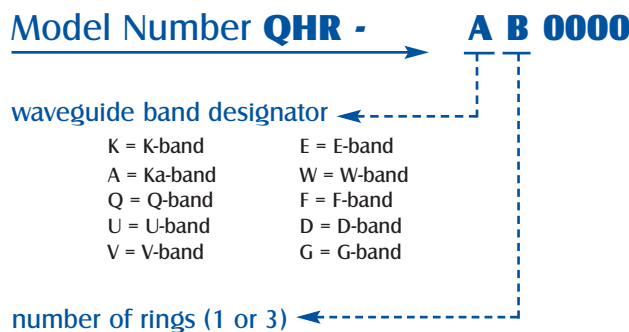



# Multi-Output Power Dividers

QMD

## Characteristics

- ◆ Low Insertion Loss over Broad Bandwidth
- ◆ Compact, Miniature
- ◆ Between 3 and 16 Output Ports
- ◆ Customized Configuration and Outline

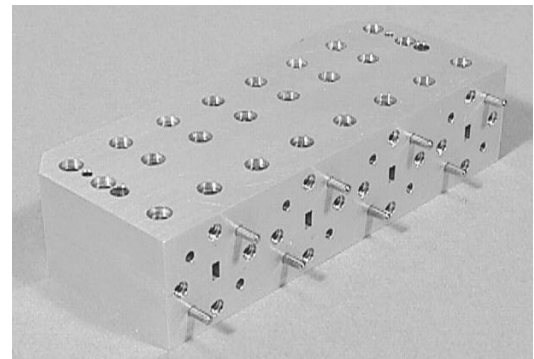

## Product Description

QuinStar Technology offers compact multi-output power dividers for frequencies in the 18 to 140 GHz range as standard and customized products to suit specific application and assembly needs. Typical configuration has one input waveguide port and multiple (between 3 and 16) equal output power waveguide ports with minimal additional loss. These output ports may be located either in line, or at customer specified locations. Wide range of options is offered for port orientation, power divider type (short-slot hybrid, hybrid tee, rat-race or ring hybrid, etc.) and port separation/location. Also, several different applicable choices of phase relationship between the output ports and input port can be offered. Standard Products have four output ports in-line with the input port.

Output ports are designed to have isolation between them with minimal additional insertion loss. These power dividers offer considerable savings in space, cost and insertion loss over a conventional assembly of individual 2-way power dividers.

Custom Multi-Output Power Divider Arrays find numerous applications in subsystems and antenna assemblies as well as multi-channel receivers and transmitter products. QuinStar has a large selection of standard compact power dividers for 4 output ports, and miniaturized power dividers. In addition, custom configurations and geometries can be readily created to suit specific mechanical and performance requirements.

## Specifications

Performance Parameter	Typical Value
Number of Output Ports	Between 3 and 16 (typically 2N output ports)
Additional Insertion Loss	0.5 x N dB (in addition to the power division loss) for 2N output ports.
Isolation	From 15 dB minimum to greater than 60 dB depending on the output port number

## Ordering Information

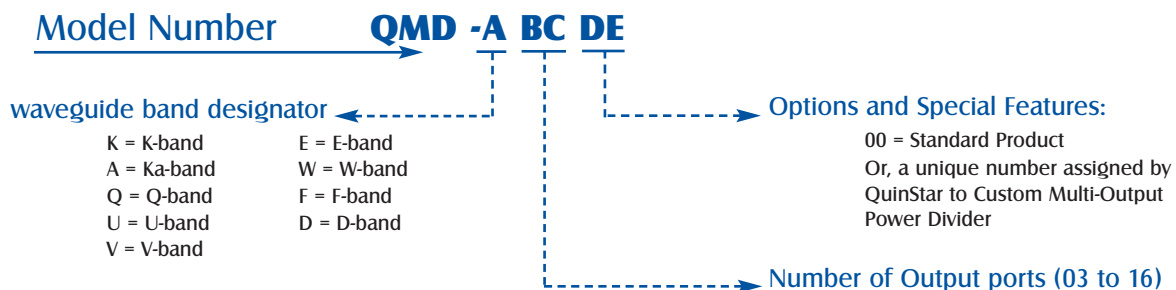



**Characteristics**

- ◆ Low Pass-Band Insertion Loss
- ◆ High Out-of-Band Rejection
- ◆ Wide Range of Bandwidth Options

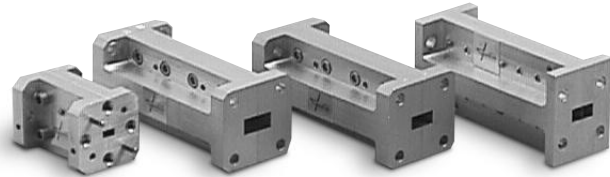

**Product Description**

QuinStar Technology's QFB series **waveguide bandpass filters** are available in ten waveguide bands covering the frequency range of 18 to 220 GHz. Bandwidths may be specified from 2% to 20% of center frequency. The filters can handle up to one Watt (CW) of RF power. Standard versions are for 2%, 5% and 10% passband bandwidth.

The design ripple is typically 0.1 dB with a Chebychev response. High out-of-band rejection is offered with customer-specific attenuation characteristics. Since filter requirements vary widely, QuinStar Technology is set up to design and supply custom products in a short turn-around time.

**Specifications**

PERFORMANCE PARAMETER	TYPICAL CHARACTERISTICS
Range of Passband Bandwidth	2% to 20% of center frequency; standard versions 5%, 10%
Passband Attenuation (typ)	Less than 1 dB (Bandwidth & rejection dependent)
Rejection (typ)	20-40 dB at $f_c \pm$ bandwidth
Ripple in Passband	0.1 dB to 0.5 dB depending on percent bandwidth and rejection requirements

### Outline Drawings/Mechanical Specifications

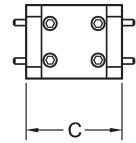
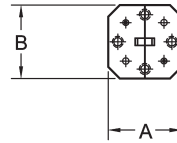
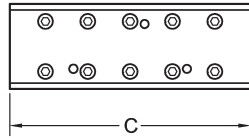
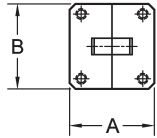

WR-42 and WR-28

WR-22 through WR-5

FREQUENCY BAND	WAVEGUIDE SIZE	FLANGE PATTERN	OUTLINE DIMENSIONS, inches/mm		
			A	B	C <sup>1</sup>
K	WR-42	UG-595/U	0.88/22.4	0.88/22.4	2.00/51.0
Ka	WR-28	UG-599/U	0.75/19.1	0.75/19.1	2.00/51.0
Q	WR-22	UG-383/U	1.12/28.4	1.12/28.4	1.50/38.1
U	WR-19	UG-383/U	1.12/28.4	1.12/28.4	1.50/38.1
V	WR-15	UG-385/U	0.75/19.1	0.75/19.1	1.50/38.1
E	WR-12	UG-387/U	0.75/19.1	0.75/19.1	1.00/25.4
W	WR-10	UG-387/U-M	0.75/19.1	0.75/19.1	1.00/25.4
F	WR-8	UG-387/U-M	0.75/19.1	0.75/19.1	1.00/25.4
D	WR-6	UG-387/U-M	0.75/19.1	0.75/19.1	1.00/25.4
G	WR-5	UG-387/U-M	0.75/19.1	0.75/19.1	1.00/25.4

<sup>1</sup> Standard versions.

### Ordering Information

Model Number **QFB -**

**AB CD E O**



Please specify exact center frequency and complete rejection requirements when ordering.

center frequency rounded to nearest GHz

(1A = 100-109 GHz, 1B = 110-119 GHz, etc.)

passband bandwidth rounded to nearest GHz

waveguide band designator

K = K-band	E = E-band
A = Ka-band	W = W-band
Q = Q-band	F = F-band
U = U-band	D = D-band
V = V-band	G = G-band



# High Pass and Low Pass Filters

QFL/QFH

## Characteristics

- ◆ Low Insertion Loss
- ◆ Frequency Up to 110 GHz
- ◆ Custom Versions Available

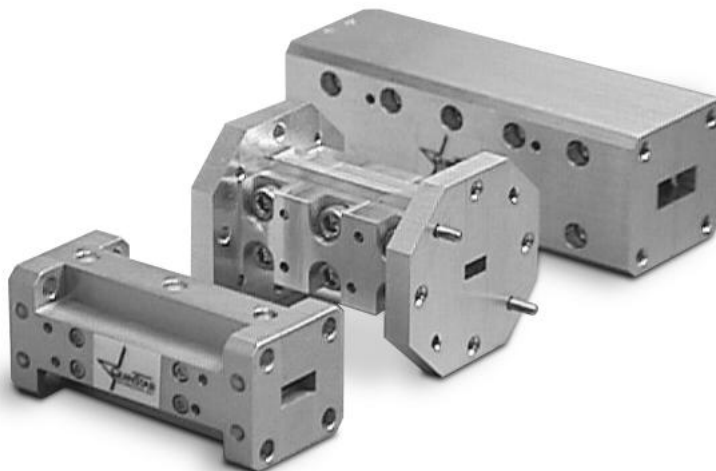

## Product Description

QuinStar Technology's QFL series high pass filters are available from 18 to 110 GHz in seven waveguide bands. These filters offer low loss and minimum ripple in the pass band and high rejection in the stop band.

The high pass filters consist of precisely machined reduced width waveguide below cutoff sections with input/output impedance transformer sections. High pass filters may be custom-designed to meet your specific requirements.

## Specifications

FREQUENCY BAND	K	Ka	Q	U	V	E	W
Frequency Range (GHz)	18-26.5	26.5-40	33-50	40-60	50-75	60-90	75-110
Waveguide Size	WR-42	WR-28	WR-22	WR-19	WR-15	WR-12	WR-10
LOW PASS FILTERS							
Typical 3 dB Upper Cutoff Frequency (GHz)	28.5	41.5	52.2	62.3	77.0	93.0	114.0
Rejection Band (GHz)	30-100	48-120	60-145	72-185	90-220	108-270	132-330
Lower Cutoff Frequency (GHz) <sup>1</sup>	14.1	21.1	26.3	31.4	39.9	48.4	59.1
Insertion Loss (dB max)	1.0	1.0	1.0	1.0	1.2	1.5	1.8
Rejection Band for Attenuation >40 dB (GHz)	35-66	50-95	62-120	75-145	92-180	110-215	140-265
HIGH PASS FILTERS							
Cutoff Frequency Range (GHz)	14-23	21-35	26-44	31-53	40-65	48-80	59-95
Pass Band Insertion Loss (dB max)	0.8	0.9	1.0	1.0	1.0	1.2	1.2
Pass Band VSWR (max)	1.15:1						
Rejection at 90% of Cutoff Frequency (dB min) <sup>2</sup>	45	45	40	40	40	35	35
Skirt Selectivity (dB/GHz typ) <sup>2</sup>	20	15	10	10	8	6	5

Other waveguide sizes are available.

<sup>1</sup> The lower cutoff frequency can be modified to meet special application requirements.

<sup>2</sup> High pass filters are typically custom designed to meet your specific requirements. Typical performance presented here.



### Outline Drawings/Mechanical Specifications

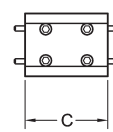
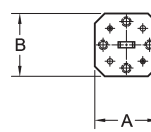
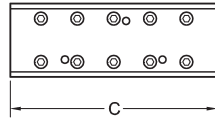
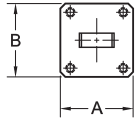

WR-42 and WR-28

WR-22 through WR-10

FREQUENCY BAND	WAVEGUIDE SIZE	FLANGE PATTERN	OUTLINE DIMENSIONS, inches/mm <sup>1</sup>	
			A, B	C
K	WR-42	UG-595/U	0.88/22.4	3.0/76.2
Ka	WR-28	UG-599/U	0.75/19.1	1.65/41.9
Q	WR-22	UG-383/U	1.13/28.7	2.0/50.8
U	WR-19	UG-383/U	1.13/28.7	1.5/38.0
V	WR-15	UG-385/U	0.75/19.1	1.0/25.4
E	WR-12	UG-387/U	0.75/19.1	1.0/25.4
W	WR-10	UG-387/U	0.75/19.1	1.0/25.4

<sup>1</sup> Standard versions.

Please contact QuinStar for High Pass Filter Mechanical Specifications.

### Ordering Information

**Model Number** → **QF - AB C D 00**

filter type

- L = low pass
- H = high pass

cutoff frequency rounded to nearest GHz

(1A = 100-109 GHz)

configuration

- S = standard
- Z = custom

waveguide band designator

- K = K-band
- A = Ka-band
- Q = Q-band
- U = U-band
- V = V-band
- E = E-band
- W = W-band



### Characteristics

- ◆ Offered over 18-185 GHz
- ◆ High Rejection
- ◆ Low Insertion Loss over Pass Band
- ◆ Custom Designs Offered

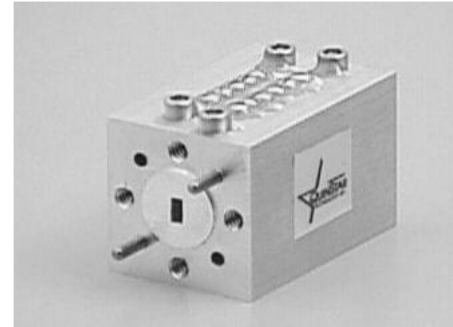

### Product Description

QuinStar Technology offers Series QNF band-reject and notch filters at any rejection frequency in the 18-185 GHz range. The performance of these filters is custom-tailored to suit the specific attenuation need of the application. The insertion loss depends on the separation between the rejection frequency and the pass band, and the amount of rejection required. Very large rejection (attenuation) can be achieved over a relatively narrow frequency range to allow a high power signal (or interference signals) to be virtually eliminated from the band. These filters are

particularly well suited for eliminating harmonics and known interference frequencies from a system input or output in communication and plasma diagnostic receivers and radars.

The mechanical dimensions and performance characteristics are largely determined by the rejection requirements. QuinStar can also design and produce harmonic-reject filters for specific systems or equipment to meet compliance with regulations.

### Specifications

Performance Parameter	Notch Filter	Band-Reject Filter
Frequency Range (Pass Band)	Up to Full Waveguide Band	
Rejection Frequency (center)	From Waveguide Cutoff to 2.5 Waveguide Cutoff	
Rejection Bandwidth (at 10 dB insertion loss points in rejection band)	From 1% to 5% of Notch Center Frequency	4% to 10% of Rejection Center Frequency
Insertion Loss	1-2.5 dB depending on required rejection characteristics	2-2.5 dB depending on bandwidth and desired rejection level
Rejection Level	20 dB to 65 dB	From 15 to 40 dB over the rejection band

### Ordering Information

Model Number **QNF -**

**ABC DE F GH**

rejection band center frequency (or notch frequency), in GHz

rejection (min.) at rejection band center (notch frequency)

rejection bandwidth (full width at 10 dB rejection points)

waveguide band

- K = K-band
- A = Ka-band
- Q = Q-band
- U = U-band
- V = V-band
- E = E-band
- W = W-band
- F = F-band
- D = D-band



# E- & H-Plane Waveguide Tees

QUH

## Characteristics

- ◆ Unmatched Ports
- ◆ Geometrical Symmetry
- ◆ Available from 12.4 to 220 GHz
- ◆ Equal Power Division Between the Two Outputs

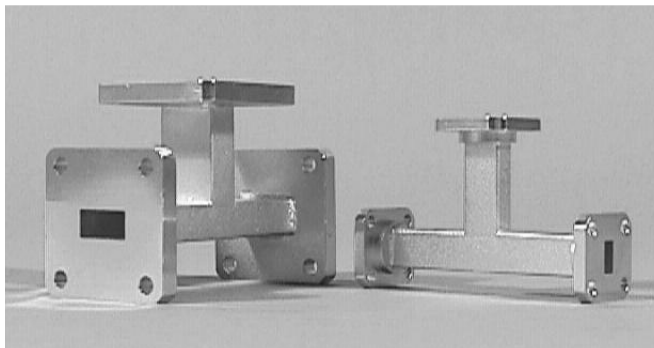

## Product Description

QuinStar Technology's E-plane tees consist of a length of standard flanged waveguide with a perpendicular E-plane coupling arm symmetrically located on the broad waveguide wall. Input power is divided equally and in opposite phase between the two outputs.

Similarly, the H-plane tees feature an H-plane coupling arm located on the narrow waveguide wall. Power at the coupling arm input is divided into equal signals in phase at the main outputs. These devices are available in standard waveguide sizes from 12.4 to 220 GHz. Neither of the tees has matched junctions and therefore they are not recommended for low VSWR applications.

## Outline Drawings/Mechanical Specifications

FREQUENCY BAND	OUTLINE DIMENSIONS, inches/mm	
	A	B
Ku	2.5/63.5	1.25/31.75
K	2.00/50.80	1.00/25.40
Ka	2.40/60.96	1.20/30.48
Q	2.40/60.96	1.20/30.48
U	2.40/60.96	1.20/30.48
V	2.00/50.80	1.00/25.40
E	2.00/50.80	1.00/25.40
W	2.00/50.80	1.00/25.40
F	1.5/38.10	0.75/19.05
D	1.5/38.10	0.75/19.05
G	1.5/38.10	0.75/19.05

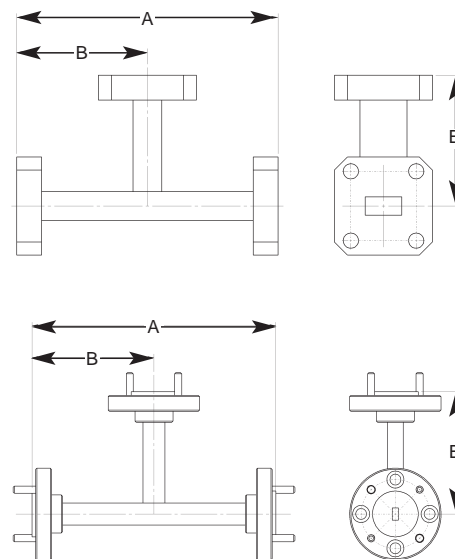

## Ordering Information

Model Number **QUH - A B 000**

waveguide band designator

waveguide plane

- Y = Ku-band
- K = K-band
- A = Ka-band
- Q = Q-band
- U = U-band
- V = V-band

- E = E-band
- W = W-band
- F = F-band
- D = D-band
- G = G-band

- E = E-plane tee
- H = H-plane tee



# Waveguide Straight Sections, Terminations, and Tapered Transitions

## QWS/QWN/QWP

### Characteristics

- ◆ Low VSWR
- ◆ Minimum Insertion Loss
- ◆ Precise Construction



### Product Description

QuinStar Technology's **QWS**, **QWN** and **QWP** series **waveguide straight sections, terminations and tapered transitions** cover the frequency range of 18 to 220 GHz in ten waveguide bands. Straight waveguide sections are available in standard lengths as well as customer-specific lengths.

The terminations (loads) consist of an RF-absorbing material mounted in a flanged waveguide. Standard terminations can dissipate 0.5-2 W average power

depending on the specific waveguide band. Custom high power terminations are also available. The tapered transitions allow very efficient propagation of RF energy from one waveguide size to another.

The straight sections and terminations are built with precision and plated for low insertion loss and high corrosion resistance. Typical VSWR for straight sections is 1.05:1 over the entire frequency band.

### Specifications

FREQUENCY BAND	K	Ka	Q	U	V	E	W	F	D	G
Frequency Range (GHz)	18-26.5	26.5-40	33-50	40-60	50-75	60-90	75-110	90-140	110-170	140-220
Waveguide Size	WR-42	WR-28	WR-22	WR-19	WR-15	WR-12	WR-10	WR-8	WR-6	WR-5
VSWR (max)	1.03:1	1.03:1	1.04:1	1.05:1	1.05:1	1.06:1	1.06:1	1.08:1	1.1:1	1.12:1
Termination Length	(in)	3.31	2.81	2.56	2.56	1.56	1.56	1.56	0.90	0.90
	(mm)	84.0	71.3	65.0	65.0	39.6	39.6	39.6	22.8	22.8
Termination Power Handling (W max)	2.0	1.0	1.0	1.0	0.5	0.5	0.5	0.5	0.5	0.5
Flange Pattern	UG-595/U	UG-599/U	UG-383/U	UG-383/U	UG-385/U	UG-387/U	UG-387/U	UG-387/U	UG-387/U	UG-387/U

Other waveguide sizes are available.



# Waveguide Straight Sections, Terminations, and Tapered Transitions

## QWS/QWN/QWP

### Outline Drawings/Mechanical Specifications

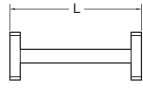

Straight Section

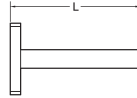

Termination

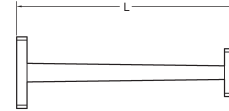

Tapered Transition

TAPERED TRANSITION LENGTHS, inches/mm										
FREQUENCY BAND	K	Ka	Q	U	V	E	W	F	D	G
Freq. Range (GHz)	18-26.5	26.5-40	33-50	40-60	50-75	60-90	75-110	90-140	110-170	140-220
Waveguide Size	WR-42	WR-28	WR-22	WR-19	WR-15	WR-12	WR-10	WR-8	WR-6	WR-5
K-band to		2.20/56.0	2.20/56.0	2.50/64.0	2.70/69.0	3.30/84.0	3.30/84.0	3.40/86.0	3.50/89.0	3.60/92.0
Ka-band to			2.00/51.0	2.00/51.0	2.00/51.0	2.40/61.0	1.80/46.0	2.20/56.0	2.30/58.0	2.40/61.0
Q-band to				1.80/46.0	1.80/46.0	1.80/46.0	1.80/46.0	1.80/46.0	1.80/46.0	1.80/46.0
U-band to					1.20/31.0	1.50/38.0	1.50/38.0	1.50/38.0	1.50/38.0	1.50/38.0
V-band to						1.40/36.0	1.40/36.0	1.40/36.0	1.40/36.0	1.40/36.0
E-band to							1.30/33.0	1.30/33.0	1.30/33.0	1.30/33.0
W-band to								1.20/31.0	1.20/31.0	1.20/31.0
F-band to									1.10/27.0	1.10/27.0
D-band to										1.00/26.0

### Ordering Information

#### Model Number

**QW - A BCD E 0**

model prefix

S = straight section  
N = termination

options

0 = none  
Z = special features  
(such as circular input)

waveguide band designator

K = K-band      E = E-band  
A = Ka-band     W = W-band  
Q = Q-band      F = F-band  
U = U-band      D = D-band  
V = V-band      G = G-band

length rounded to nearest tenth of an inch

010 = 1.0 inch  
000 = termination

#### Model Number QWP -

**A B 0000**

larger waveguide band designator

K = K-band      E = E-band  
A = Ka-band     W = W-band  
Q = Q-band      F = F-band  
U = U-band      D = D-band  
V = V-band      G = G-band

smaller waveguide band designator  
(see list at left)



## Characteristics

- ◆ Accurate Mechanical Dimensions for Complex Geometries
- ◆ Low Insertion Loss and VSWR
- ◆ Built Precisely to Customer's Specifications and Drawings
- ◆ Options in material, finish and features

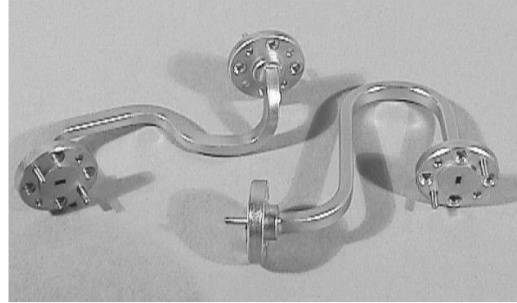

## Product Description

QuinStar Technology specializes in producing custom waveguide assemblies for use in virtually any product assembly and for interconnects in millimeter wave subsystems. These waveguide assemblies can involve complex bend, twists, and other mechanical features required for low loss interconnections within subsystem

assemblies. Each waveguide assembly is manufactured to customer's precise mechanical drawing and specifications using the most suitable material, waveguide flanges and finish. Examples of some of the previously delivered assemblies are shown.

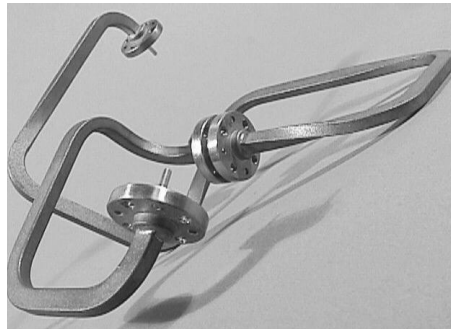

## Ordering Information

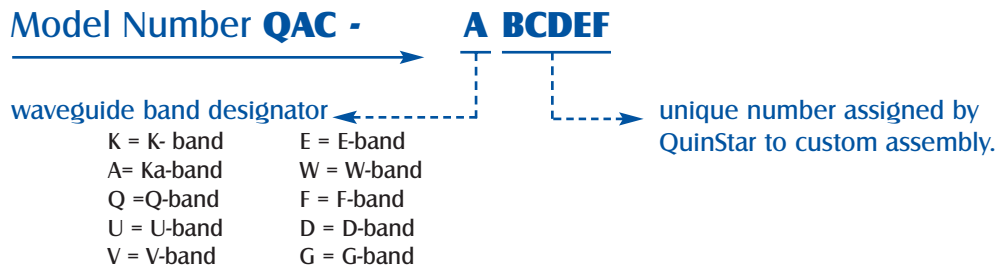



# Medium and High Power Terminations

QTG/QTH

## Characteristics

- ◆ Low VSWR
- ◆ Compact Size
- ◆ Full Waveguide Bandwidths
- ◆ Available for High Power up to 250 watts CW Applications



## Product Description

QuinStar Technology's terminations are designed with standard waveguide flanges for use from 12.4 to 220 GHz. Each unit consists of a short length of waveguide and an integral matched terminal load. Individual resistive dielectric loads are tapered to precise wedge configurations for maximum effective energy absorption. The gradual taper provides a low VSWR over the full waveguide bandwidth.

The QTG/QTH terminations are used in experimental and developmental test sets and instruments where a low VSWR waveguide load is essential for valid and accurate measurements.

## Specifications

MEDIUM POWER TERMINATIONS											
WAVEGUIDE BAND	Ku	K	Ka	Q	U	V	E	W	F	D	G
Frequency Band (GHz)	12.4-18.0	18.0-26.5	26.5-40.0	33.0-50.0	40.0-60.0	50.0-75.0	60.0-90.0	75.0-110.0	90.0-140.0	110.0-170.0	140.0-220.0
VSWR Max.	1.10	1.10	1.10	1.10	1.10	1.10	1.10	1.10	1.15	1.15	1.15
Average Power (Watts)	10.0	8.0	7.0	5.0	3.0	2.0	2	2	2	2	2
HIGH POWER TERMINATIONS											
WAVEGUIDE BAND	Ku	K	Ka	Q	U	V	E	W	F	D	G
Frequency Band (GHz)	12.4-18.0	18.0-26.5	26.5-40.0	33.0-50.0	40.0-60.0	50.0-75.0	60.0-90.0	75.0-110.0	90.0-140.0	110.0-170.0	140.0-220.0
VSWR Max.	1.10	1.10	1.10	1.10	1.10	1.10	1.10	1.10	1.15	1.15	1.15
Average Power (Watts)	300	250	250	200	150	100	100	75	50	50	50



**Outline Drawings/Mechanical Specifications**

Medium Power

High Power

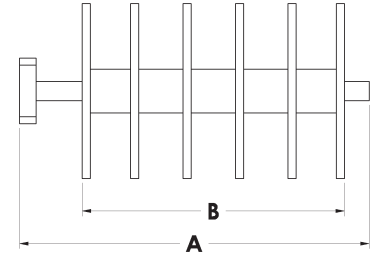
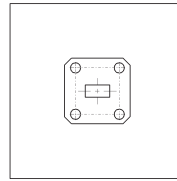
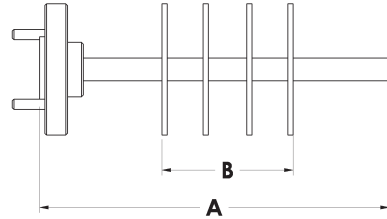
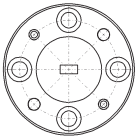

FREQUENCY BAND	MEDIUM POWER TERMINATION		HIGH POWER TERMINATION	
	A	B	A	B
<b>Ku</b>	3.88/98.6	1.50/31.8	5.00/127.0	4.00/101.6
<b>K</b>	2.88/73.2	1.74/44.2	4.00/101.6	3.00/76.2
<b>Ka</b>	2.43/61.7	1.25/31.8	4.00/101.6	3.00/76.2
<b>Q</b>	2.43/61.7	1.12/28.4	4.00/101.6	3.00/76.2
<b>U</b>	2.43/61.7	1.25/31.8	4.00/101.6	3.00/76.2
<b>V</b>	2.00/50.8	0.75/19.1	3.50/88.9	2.50/63.5
<b>E</b>	2.00/50.8	0.75/19.1	3.50/88.9	2.50/63.5
<b>W</b>	2.00/50.8	0.75/19.1	3.50/88.9	2.50/63.5
<b>F</b>	1.38/35.1	0.75/19.1	3.00/76.2	2.00/50.8
<b>D</b>	1.38/35.1	0.75/19.1	3.00/76.2	2.00/50.8
<b>G</b>	1.38/35.1	0.75/19.1	3.00/76.2	2.00/50.8

**Ordering Information**

Model Number **QT - A B 000**

model number

- G = medium power
- H = high power

waveguide band designator

- K = K-band
- A = Ka-band
- Q = Q-band
- U = U-band
- V = V-band
- E = E-band
- W = W-band
- F = F-band
- D = D-band
- G = G-band

flange type

- R = round
- S = square
- Z = custom



# Waveguide Bends and Twists

## QWB/QWT

### Characteristics

- ◆ 30°, 45°, 60° and 90° Bends
- ◆ 45° and 90° Twists
- ◆ Minimum Insertion Loss

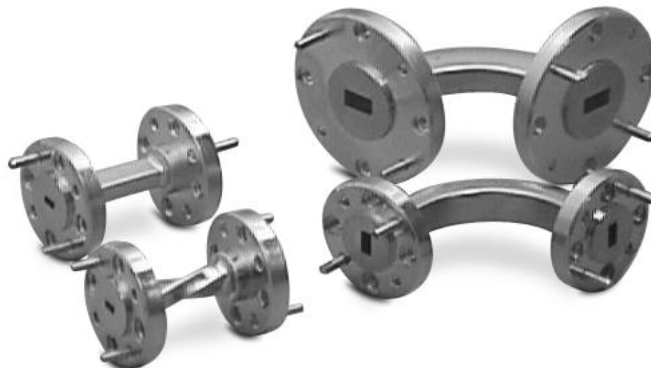

### Product Description

QuinStar Technology's **QWB** and **QWT** series **waveguide bends and twists** cover the frequency range of 18 to 220 GHz in ten waveguide bands. E-Plane and H-Plane formed bends are available with angles of 30°, 45°, 60°, and 90°. The twists allow changing the orientation in a waveguide

assembly. They are available with angles of 45° in either a left- or right-hand twist or a standard 90°. The bends and twists are built with high precision and then gold plated for low insertion loss and high corrosion resistance. Typical VSWR is 1.10:1 over entire frequency band.

### Outline Drawings/Mechanical Specifications

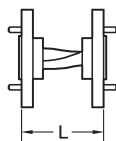

Waveguide Twist  
(round flange pattern shown)

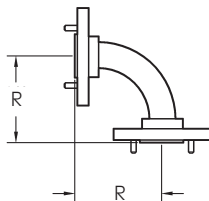

Right Angle

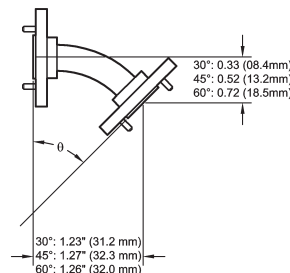

Waveguide Bends  
(round flange pattern shown)

FREQUENCY BAND	K	Ka	Q, U	V, E, W, F, D, G
Waveguide Size	WR-42	WR-28	WR-22, -19	WR-15, -12, -10, -8, -6, -5
Twist Length, inches/mm	2.5/63.5	1.75/44.5	1.25/31.8	1.00/25.4
Right Angle (90°) Bend Radius, inch/mm	1.5/38.1	1.5/38.1	1.5/38.1	1.0/25.4

### Ordering Information

#### Model Number

**QW - A BC D E**

#### model prefix

B = bend  
T = twist

#### flange type

R = round  
S = square  
Z = custom

#### waveguide band designator

K = K-band      E = E-band  
A = Ka-band     W = W-band  
Q = Q-band      F = F-band  
U = U-band      D = D-band  
V = V-band      G = G-band

#### type of twist or bend

L = left-handed twist      E = E-plane bend  
R = right-handed twist    H = H-plane bend  
0 = 90° twist

#### angle of twist or bend

30 = 30° / 60 = 60° / 45 = 45° / 90 = 90°



# Tunable Loads, Tunable Shorts, and E-H Tuners

## QWG/QAT/QWU

### Characteristics

- ◆ Full Waveguide Bandwidth
- ◆ Frequency 26.5-220 GHz
- ◆ Precision Micrometer Adjustment



### Product Description

QuinStar Technology's series **QWG, QAT and QWU tunable loads, tunable shorts** and **E-H tuners** are available in nine waveguide bands. They provide full waveguide band coverage and are ideally suited for precision measurements, experimental testing and developmental tuning.

**Tunable Loads:** Consist of a precision tapered waveguide load coupled to a micrometer drive. Repositioning of the sliding load permits determination of a minimum/maximum VSWR due to the phasing between the VSWR of the load and the VSWR of the unit under test.

**Tunable Shorts:** Consist of a movable non-contacting choke type short circuit designed to operate with high elec-

trical stability over the entire waveguide band. A micrometer drive provides smooth accurate positional tuning of one-half wavelength at the lowest operating frequency and a positive locking feature is included.

**E-H Tuners:** Consist of a hybrid tee section with micrometer drive tunable shorts (described above) in both the E-plane and H-plane arms. These tuners introduce discontinuities into the waveguide transmission line for simultaneous control of both phase and amplitude of the RF reflection coefficient. They can be used as matching devices to cancel reflections in transmission lines or to match detectors, terminations or similar components.

### Ordering Information

Model Number **Q - A 00000**

model prefix

- WG = tunable load
- AT = tunable short
- WU = E-H tuner

waveguide band designator

- A = Ka-band
- Q = Q-band
- U = U-band
- V = V-band
- E = E-band
- W = W-band
- F = F-band
- D = D-band
- G = G-band





# Waveguide Flanges, Adapters and Associated Hardware

## Bulkhead Waveguide Adapter

QBA

### Product Description

QuinStar Technology's series QBA waveguide bulkhead adapter was developed for use as panel feed-through in assemblies and equipment packaging. These adapters operate over the full waveguide bandwidth in waveguide bands from 18.0 to 140 GHz. O-rings are provided on the panel mount for moisture resistance and a wide variety of flange types and configurations are offered. Standard lengths are 1.00 inches with custom lengths available upon request.

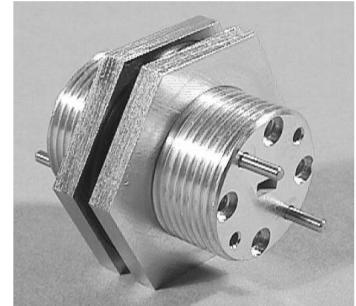

### Ordering Information

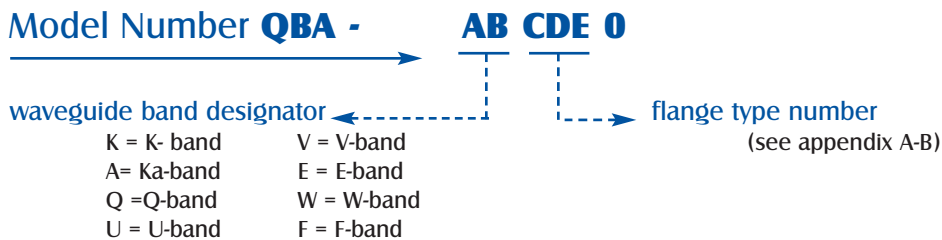

## Flange Adapters

QFA

### Product Description

QuinStar series QFA Flange Adapters are used to facilitate connection between different types or formats of flanges used for the same waveguide size. These are produced in various waveguide bands in the 12.4 to 220 GHz range with various combinations of commonly used flange styles attached to the two ends of a short low-loss waveguide. Custom combinations are also available upon request. Standard length is 1.0"



### Ordering Information

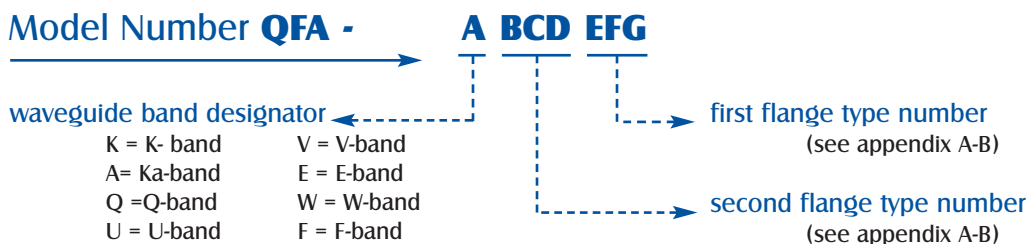



# Waveguide Flanges, Adapters and Associated Hardware

## Waveguide Flanges

QFF

### Product Description

QuinStar series QFF are precision machined waveguide flanges for virtually any waveguide size and flange style in 12.4 to 220 GHz range covering waveguide bands WR-62 (KU) to WR-5 (G-band). Flanges with choke and O-ring groove are also available. All flanges are available in brass, aluminum or copper as material. Special flanges can be designed and manufactured as custom products.

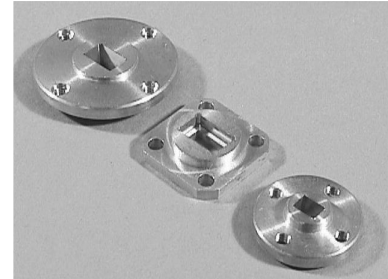

### Ordering Information

Model Number **QFF -**

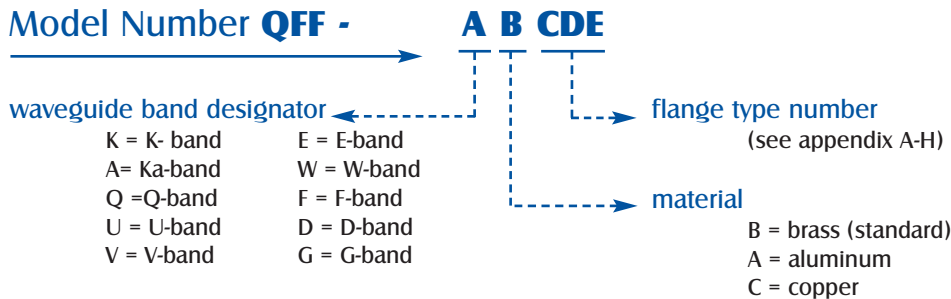

## Stainless Steel Dowel Pins

QDP

### Product Description

Available in 0.062-inch diameter (standard size) in units of 100 pins per bag

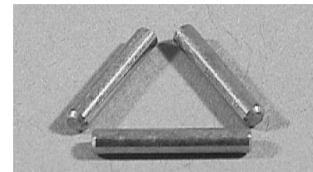

## Captivated Waveguide Flange Screws

QFS

### Product Description

Available in standard 4-40 size with socket head, in units of 100 screws per bag





# Waveguide Flanges, Adapters and Associated Hardware

## Precision Drill Jigs

QDJ

### Product Description

Available in standard Ka to G waveguide bands (WR-28 to WR-06)

QuinStar Technology's Drill Jigs consists of a solid steel block with accurately positioned drill holes and a tapered locating tab that will locate the drill holes in precise relation to the internal waveguide surfaces. Hardened steel minimizes wear to ensure drilling accuracy. These precision drill jigs are designed to facilitate accurate fabrication of flanged waveguide sections for standard waveguide sizes from 26.5 to 220 GHz. They are used to locate alignment pins, mating pin holes, and connecting screw holes in the waveguide flanges.

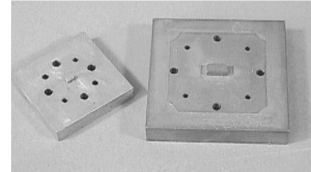

### Ordering Information

Model Number **QDJ - A BCD 00**

← waveguide band designator

→ flange type number

(see appendix A-B)

- |             |            |
|-------------|------------|
| K = K- band | V = V-band |
| A= Ka-band  | E = E-band |
| Q =Q-band   | W = W-band |
| U = U-band  | F = F-band |

## Waveguide Stands

QVS

### Product Description

QuinStar Technology's waveguide stand consists of an adjustable clamp mounted on an adjustable height base stand. The waveguide clamp may be readily adjusted to fit all waveguide sizes and orientations. The stand has a large base area to prevent moving or tipping under normal test bench conditions. For further stability, the base may be secured to the bench with mounting bolts.





## Characteristics

- ◆ Continuous Monitoring of Pressure
- ◆ Easy to Install and Use

## Product Description

QuinStar Technology’s Series QPU waveguide based pressurizing unit consists of a short length of flanged rectangular waveguide section fitted with a Schrader valve and an optional pressure gauge. These units are available in all waveguide sizes covering 12.4 to 220 GHz in standard waveguide bands.

These pressurizing units are designed for system applications involving high microwave or millimeter wave

power, such as radar systems, where waveguide pressurization is employed to prevent arcing during peak power operation. These pressurizing units can also be used to purge systems with dry gas in order to prevent condensation or moisture build up. Continuous monitoring of the pressure is accomplished by the use of an optional pressure gauge.

## Ordering Information

Model Number **QPU - A B00**

waveguide band designator

Options

- K = K band
- A = Ka band
- Q = Q band
- U = U band
- V = V band
- E = E band
- W = W band
- F = F band
- D = D band
- G = G band

- G = pressure gauge included
- 0 = no gauge included



# Waveguide to Coax Adapters

**QWA**

## Characteristics

- ◆ Low Insertion Loss, VSWR
- ◆ Full Waveguide Band Operation
- ◆ Frequency Ranges 12.4 to 75 GHz

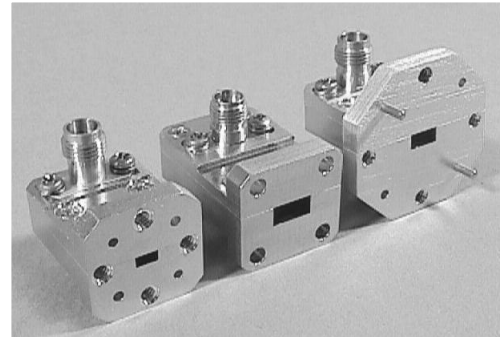

## Product Description

QuinStar Technology's QWA series waveguide to coax adapters allow an efficient method of adapting from rectangular waveguide to a coaxial connector. Full waveguide bands available from 12.4 to 75 GHz. Coaxial

connectors include SMA, K, 2.4 mm and V as appropriate for the frequency range and application, with both male and female types. Exceptionally low insertion losses and low VSWR are the key feature of these adapters.

## Specifications

Model No.	Frequency Band (GHz)	Waveguide	Flange	Standard Connectors Available	Insertion Loss (dB) max.	VSWR (max.)
QWA-62	12.4-18.0	WR-62	UG-419/U	N, SMA	0.30	1.25:1
QWA-42	18.0-26.5	WR-42	UG-595/U	K, 2.4mm	0.30	1.25:1
QWA-34	22.0-33.0	WR-34	UG-595/UM	K, 2.4mm	0.35	1.25:1
QWA-28	26.5-40.0	WR-28	UG-599/U	K, 2.4mm	0.40	1.25:1
QWA-22	33.0-50.0	WR-22	UG-383/UM	K, 2.4mm	0.60	1.35:1
QWA-19	40.0-60.0	WR-19	UG-383/UM	2.4mm, V	0.80	1.40:1
QWA-15	50.0-75.0	WR-15	UG-385/U	2.4mm, V	1.2	1.45:1

Outline Drawings available upon request.

## Ordering Information

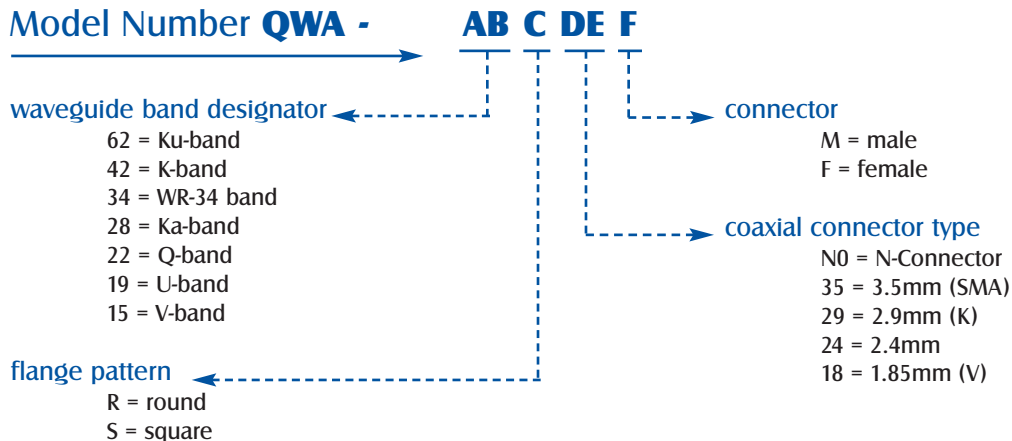



# Section 6

# Test Equipment & Instrumentation Products

Product Title	Model No.	Page Number
<b>Test Equipment and Instrumentation Products</b>		131
Manual Waveguide Switches	<b>QWM</b>	132
Electromechanical Waveguide Switches	<b>QWZ</b>	133
Micrometer type Level Set Attenuators and Variable Phase Shifters, Fixed Attenuators	<b>QAF/QAL/QAS</b>	135
Dial type Level Set Attenuators and Variable Phase Shifters	<b>QDA/QDP</b>	137
Direct Reading Attenuators, Frequency Meters, and Phase Shifters	<b>QAD/QEF/QPS</b>	139
Motorized, Programmable Attenuators	<b>QPA</b>	142
Motorized, Programmable Phase Shifters	<b>QMP</b>	144



# Manual Waveguide Switches

**QWM**

## Characteristics

- ◆ Full Waveguide Band
- ◆ Low Loss
- ◆ High Isolation
- ◆ Smooth, Accurate Positioning



## Product Description

QuinStar Technology's series **QWM waveguide switches** are manual 4-port devices. They have a 3-channel rotor accurately indexed to eight 45 degree positions that allows each port to be connected or isolated from any other port. The switches are available in seven waveguide bands covering the frequency range of 18-110 GHz and are precision

machined with bearing and indexing grooves for smooth operation and accurate positioning. They are useful in test set ups and system applications where transfer switching is required. In addition to standard manual switches, custom electromechanical waveguide switches are also available.

## Specifications

FREQUENCY BAND	K <sup>1</sup>	Ka	Q	U	V	E	W
Frequency Range (GHz)	18-26.5	26.5-40	33-50	40-60	50-75	60-90	75-110
Waveguide Size	WR-42	WR-28	WR-22	WR-19	WR-15	WR-12	WR-10
Flange Pattern	UG-595/U	UG-599/U	UG-383/U	UG-383/U	UG-385/U	UG-387/U	UG-387/U
Bandwidth (GHz)	Full						
Isolation (dB typical)	60						
Insertion Loss (dB max)	0.4	0.4	0.5	0.5	0.6	0.7	0.8
VSWR (typical)	1.15:1						
Dimension "A" (inches/mm)	0.74/18.7	0.73/18.5	0.72/18.3	0.71/18.0	0.70/17.8	0.69/17.5	0.68/17.2

<sup>1</sup> K-band two-channel bidirectional rotor.

## Outline Drawing

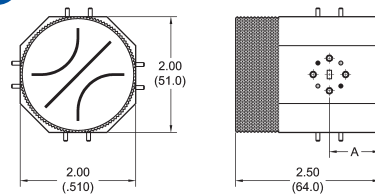

## Ordering Information

Model Number **QWM - A 00000**

waveguide band designator

- K = K-band
- Q = Q-band
- V = V-band
- W = W-band
- A = Ka-band
- U = U-band
- E = E-band



# ..... Electromechanical Waveguide Switches

**QWZ**

## Characteristics

- ◆ Full Waveguide Band
- ◆ High Isolation/Low Loss
- ◆ Accurate Positioning
- ◆ Bi-directional



## Product Description

QuinStar Technology's series **QWZ electromechanical waveguide switches** are 4-port mechanical devices that are rotational solenoid driven and electronically controlled. They have a bi-directional rotor accurately indexed to 90 degree positions that allows each port to be connected to either of the adjacent ports. The switches are available in

seven waveguide bands covering the frequency range of 18-110 GHz and are precision machined with bearing and indexing grooves for smooth operation and accurate positioning. They are useful in automated test set ups and system applications where remotely controlled transfer switching is required.

## Specifications

FREQUENCY BAND	K	Ka	Q	U	V	E	W
Frequency Range (GHz)	18-26.5	26.5-40	33-50	40-60	50-75	60-90	75-110
Waveguide Size	WR-42	WR-28	WR-22	WR-19	WR-15	WR-12	WR-10
Flange Pattern	UG-595/U	UG-599/U	UG-383/U	UG-383/U	UG-385/U	UG-387/U	UG-387/U
Bandwidth (GHz)	Full						
Isolation (dB typical)	60						
Insertion Loss (dB max)	0.4	0.4	0.5	0.5	0.6	0.7	0.8
VSWR (typical)	1.15:1						
Control Interface	TTL or microswitch						
Switching Speed (ms typ)	50						
DC Power Requirement	15VDC/2.0A or 28VDC/1.0A pulse typical						
Dimension "A" (inches/mm)	0.74/18.7	0.73/18.5	0.72/18.3	0.71/18.0	0.70/17.8	0.69/17.5	0.68/17.2



# Electromechanical Waveguide Switches

QWZ

## Outline Drawing

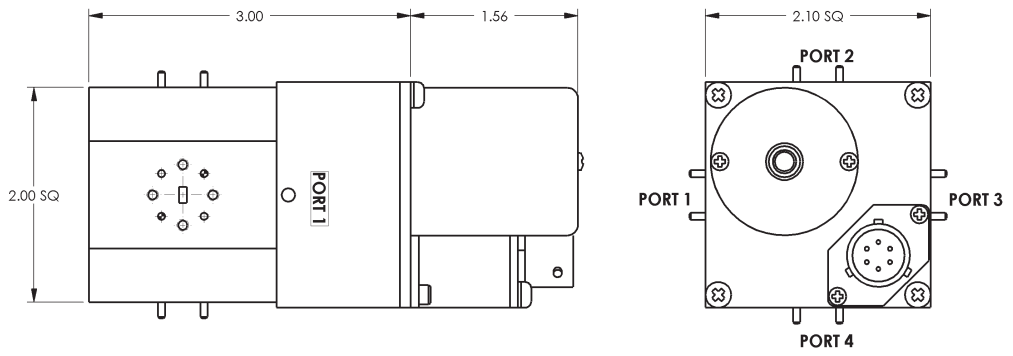

(round flange pattern shown)

## Ordering Information

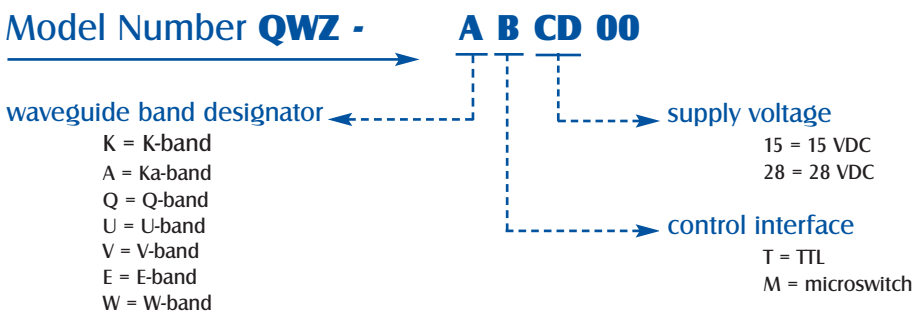



# Micrometer Type Level Set Attenuators, Variable Phase Shifters and Fixed Attenuators QAF/QAL/QAS

## Characteristics

- ◆ Broadband Operation
- ◆ 3-30 dB Fixed Attenuation
- ◆ 0-25 dB Variable Attenuation
- ◆ 0-180° Variable Phase Shift



## Product Description

QuinStar Technology's **QAF** and **QAL** series **fixed and level set attenuators** and **QAS** series **variable phase shifters** are available in seven waveguide bands covering the frequency range of 18 to 110 GHz. The fixed attenuators feature low VSWR in five standard values of attenuation. The level set attenuators and phase shifters incorporate a

micrometer which enables very fine and repeatable adjustments to be made. They are fabricated using a straight waveguide section into which is placed either a lossy material for the attenuators, or a dielectric vane for the phase shifters. Operating characteristics are relatively constant over full waveguide bandwidths.

## Specifications

FREQUENCY BAND	K	Ka	Q	U	V	E	W
Frequency Range (GHz)	18-26.5	26.5-40	33-50	40-60	50-75	60-90	75-110
Waveguide Size	WR-42	WR-28	WR-22	WR-19	WR-15	WR-12	WR-10
Fixed Attenuator Attenuation Values	03, 06, 10, 20, 30 dB or customer specific value						
VSWR (typ)	1.15:1						
Level Set Attenuator Range	0 to 25 dB variable						
Insertion Loss (dB typ)	0.5	0.5	0.6	0.7	0.8	0.9	1.0
VSWR (typ)	Attenuation < 20 dB 1.2:1, attenuation > 20 dB: 1.5:1						
Variable Phase Shifter Range	0-180 degrees						
Insertion Loss (dB typ)	0.5	0.5	0.6	0.7	0.8	0.9	1.0
VSWR (typ)	1.4:1						
Power Rating (all products)	0.5 Watts up to 60 GHz, 0.3 Watts beyond						



# Micrometer Type Level Set Attenuators, Variable Phase Shifters and Fixed Attenuators QAF/QAL/QAS

## Outline Drawings/Mechanical Specifications

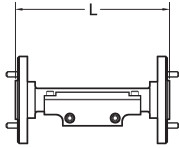

Fixed Attenuator  
(round flange pattern shown)

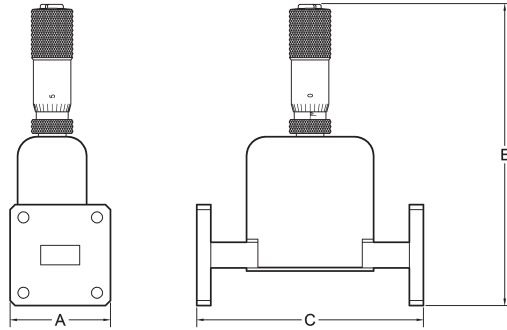

Level Set Attenuator/Variable Phase Shifter  
(square flange pattern shown)

FREQUENCY BAND	WAVEGUIDE SIZE	FLANGE PATTERN	OUTLINE DIMENSIONS, inches/mm			
			LEVEL SET ATTENUATOR/PHASE SHIFTER			FIXED ATTENUATOR
			A	B	C	L
K	WR-42	UG-595/U	0.88/22.4	3.70/94.0	4.00/101.6	3.0/76.2
Ka	WR-28	UG-599/U	0.75/19.1	3.60/91.4	2.96/75.2	2.75/69.9
Q	WR-22	UG-383/U	1.25/31.8	3.60/91.4	2.96/75.2	2.75/69.9
U	WR-19	UG-383/U	1.25/31.8	3.60/91.4	2.96/75.2	2.75/69.9
V	WR-15	UG-385/U	0.75/19.1	3.60/91.4	2.96/75.2	2.0/50.8
E	WR-12	UG-387/U	0.75/19.1	3.60/91.4	2.96/75.2	2.0/50.8
W	WR-10	UG-387/U	0.75/19.1	3.60/91.4	2.96/75.2	2.0/50.8
F	WR-8	UG-387/U	0.75/19.1	3.60/91.4	2.96/75.2	2.0/50.8
D	WR-6	UG-387/U	0.75/19.1	3.60/91.4	2.96/75.2	2.0/50.8

## Ordering Information

Model Number **QA - A BC 000**

model prefix

- F = fixed attenuator
- L = level set attenuator
- S = variable phase shifter

fixed attenuator value in dB

("00" for level set attenuator and variable phase shifter)

waveguide band designator

- K = K-band
- A = Ka-band
- Q = Q-band
- U = U-band
- V = V-band
- E = E-band
- W = W-band
- F = F-band
- D = D-band



# Dial Type Level Set Attenuator and Variable Phase Shifter QDA/QDP

## Characteristics

- ◆ Broadband Operation
- ◆ 0 to 25 dB Attenuation Range
- ◆ Mechanically Stable, Lockable
- ◆ High resolution



## Product Description

QuinStar Technology's QDA and QDP series Level Set Attenuators and Phase Shifters operate over the full waveguide band, and are offered in 7 waveguide bands covering the frequency range of 18 to 110 GHz. These adjustable level-set attenuators and variable phase shifters are driven by a mechanically stable, multi-turn miniature

dial knob to allow accurate and repeatable setting of attenuation and phase shift. The locking feature of the dial allows reliable operation when used in laboratory test setup, subsystems and instruments. The dial can be calibrated at a specified frequency, if desired. These adjustable components offer broadband performance.

## Specifications

PERFORMANCE PARAMETER	K	Ka	Q	U	V	E	W
Frequency range, GHz	18-26.5	26.5-40	33-50	40-60	50-75	60-90	75-110
Typical Insertion Loss, in dB, at 0 dB setting	0.2	0.2	0.2	0.2	0.3	0.3	0.3
Attenuation Range, dB (for Attenuator)	0-30	0-30	0-25	0-25	0-25	0-25	0-25
Average Power Handling, Watts	1.5	1.0	1.0	1.0	0.6	0.6	0.6
Phase Shift, degrees (for Phase Shifter)	0-180	0-180	0-180	0-180	0-180	0-180	0-180



# Dial Type Level Set Attenuator and Variable Phase Shifter QDA/QDP

## Outline Drawings/Mechanical Specifications

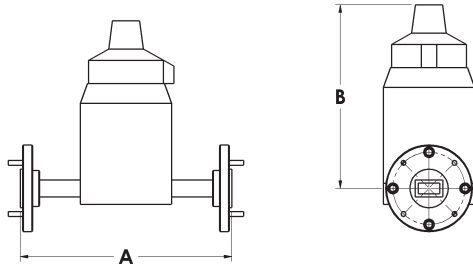

WAVEGUIDE BAND	OUTLINE DIMENSIONS, inches/mm	
	A	B
K	3.00/76.2	2.35/59.7
KA	2.75/69.9	2.16/54.9
Q	2.75/69.9	2.16/54.9
U	2.75/69.9	2.16/54.9
V	2.5/63.5	1.94/49.3
E	2.5/63.5	1.94/49.3
W	2.5/63.5	1.94/49.3

## Ordering Information

Model Number **QD - A 0000**

model prefix

A = Level Set Attenuator  
P = Variable Phase Shifter

waveguide band designator

K = K-band  
A = Ka-band  
Q = Q-band  
U = U-band  
V = V-band  
E = E-band  
W = W-band



# Direct Reading Attenuators, Frequency Meters and Phase Shifters

## QAD/QEF/QPS

### Characteristics

- ◆ Fullband Coverage
- ◆ Accurate Direct Readings
- ◆ Highly Repeatable Settings
- ◆ Easy to Use

### Product Description

QuinStar Technology's **direct reading attenuators, frequency meters** and **phase shifters** are designed and built for precision millimeter-wave measurements. These instruments cover the range of 26.5-110 GHz in six waveguide bands. Series **QAD direct reading attenuators** and series **QPS direct reading phase shifters** are of classical rotary vane construction. They offer highly repeatable settings and frequency independent readings. Both instruments have low VSWR. In addition, the attenuator has negligible phase shift versus attenuation setting while the phase shifter has low insertion loss.



Series **QEF direct reading frequency meters** utilize a high precision TE 111 mode cavity that permits quick and accurate determination of the frequency of an in-band millimeter-wave input signal. They also have low VSWR and low insertion loss.

All three instruments are well suited for accurate millimeter-wave measurements. Direct reading attenuators and phase shifters are available in motorized versions for ATE or other applications requiring remote control.

### Specifications

FREQUENCY BAND	K	Ka	Q	U	V	E	W
Frequency Range (GHz)	18-26.5	26.5-40	33-50	40-60	50-75	60-90	75-110
Waveguide Size	WR-42	WR-28	WR-22	WR-19	WR-15	WR-12	WR-10
<b>DIRECT READING PRECISION ATTENUATORS</b>							
Insertion Loss (dB max)	0.5	0.5	0.6	0.7	0.8	1.0	1.2
VSWR (typical)	1.15	1.15	1.15	1.15	1.20	1.20	1.25
Average Power (Watts)	0.5	0.5	0.5	0.4	0.3	0.2	0.2
Attenuation Range	0 dB to 50 dB (above insertion loss) over full waveguide band						
<b>DIRECT READING PHASE SHIFTERS</b>							
Accuracy (degrees)	3	3	3	4	4	4	4
Insertion Loss (dB)	1.0	1.2	1.3	1.5	1.8	2.0	2.0
VSWR (typical)	1.30	1.30	1.30	1.35	1.35	1.35	1.35
Average Power (Watts)	1.0	1.0	1.0	0.8	0.7	0.6	0.6
Phase Shift Range	0 to 360 degrees direct reading						
Read-Out	0 to 360 degrees in 5 degree divisions						
Loss Variation	1.0 dB (max)						
<b>DIRECT READING FREQUENCY METERS</b>							
Absolute Accuracy (%)	0.12	0.12	0.20	0.20	0.20	0.20	0.20
VSWR (max)	1.15	1.15	1.15	1.20	1.20	1.20	1.20
Insertion Loss (dB max)	0.30	0.30	0.30	0.50	0.50	0.50	0.50
Scale Divisions (MHz)	10	10	20	20	20	20	20

Other waveguide sizes are available.

<sup>1</sup> Scale increments: 0dB to 0.1dB = 0.01dB; 0.1dB to 1.0dB = 0.05dB; 1.0dB to 10dB = 0.10dB; 10.0dB to 20.0dB = 0.20dB; 20.0dB to 30.0dB = 0.5dB; 30.0dB to 50.0dB = 1.0dB. Maximum setting 60dB typical.



# Direct Reading Attenuators, Frequency Meters and Phase Shifters

## QAD/QEF/QPS

### Outline Drawings/Mechanical Specifications

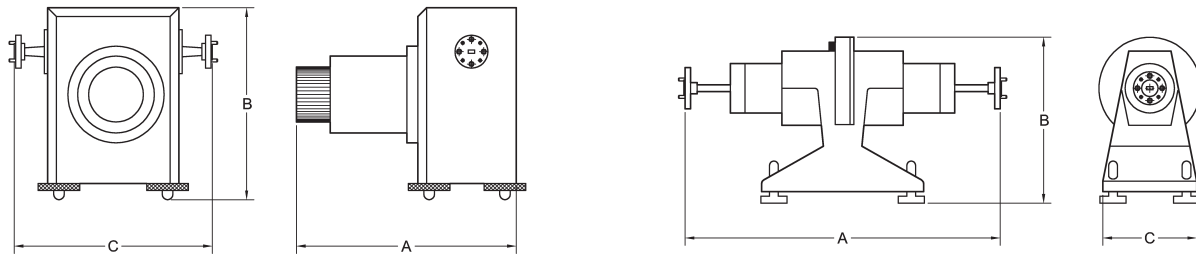

Series QAD

Series QPS

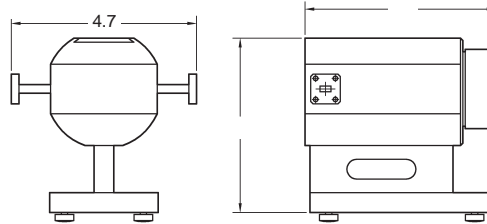

Series QEF

#### SERIES QAD DIRECT READING ATTENUATOR

FREQUENCY BAND	WAVEGUIDE SIZE	OUTLINE DIMENSIONS, inches/mm		
		A	B	C
Ka	WR-28	5.00/127.0	4.00/102.0	7.2/183
Q	WR-22	5.00/127.0	4.00/102.0	6.6/168
U	WR-19	5.00/127.0	4.00/102.0	6.0/152.4
V	WR-15	5.00/127.0	4.00/102.0	4.4/111.8
E	WR-12	5.00/127.0	4.00/102.0	4.2/106.7
W	WR-10	5.00/127.0	4.00/102.0	4.0/101.6

#### SERIES QPS DIRECT READING PHASE SHIFTER

FREQUENCY BAND	WAVEGUIDE SIZE	OUTLINE DIMENSIONS, inches/mm		
		A	B	C
Ka	WR-28	8.6/218.4	3.66/93.0	3.22/81.8
Q	WR-22	5.8/147.3	3.66/93.0	3.22/81.8
U	WR-19	6.1/154.9	3.66/93.0	3.22/81.8
V	WR-15	5.1/129.5	3.66/93.0	3.22/81.8
E	WR-12	4.5/114.3	3.66/93.0	3.22/81.8
W	WR-10	3.7/94.0	4.00/102.0	4.50/114.3



# Direct Reading Attenuators, Frequency Meters and Phase Shifters

## QAD/QEF/QPS

SERIES QEF DIRECT READING FREQUENCY METER				
FREQUENCY BAND	WAVEGUIDE SIZE	OUTLINE DIMENSIONS, inches/mm		
		A	B	C
Ka	WR-28	5.00/127.0	3.89/98.8	4.69/119.1
Q	WR-22	5.00/127.0	3.89/98.8	4.69/119.1
U	WR-19	5.00/127.0	3.89/98.8	4.69/119.1
V	WR-15	5.00/127.0	3.89/98.8	4.69/119.1
E	WR-12	5.00/127.0	3.89/98.8	4.69/119.1
W	WR-10	5.00/127.0	3.89/98.8	4.69/119.1

### Ordering Information

Direct Reading Attenuators:

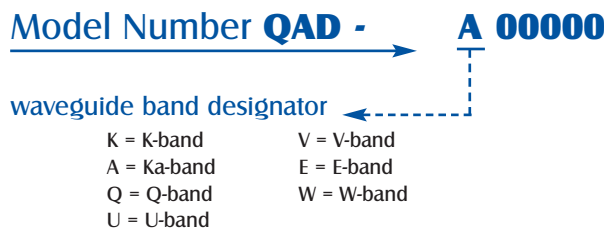

Direct Reading Phase Shifters:

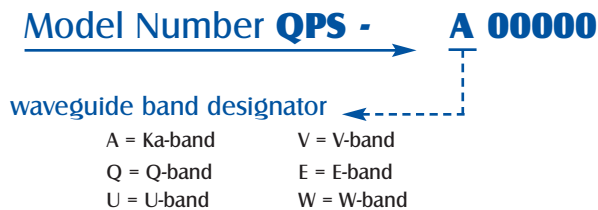

Direct Reading Frequency Meters:

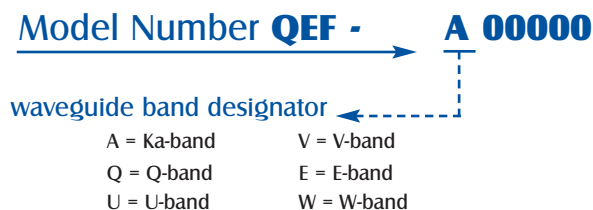



# .....Motorized, Programmable Attenuators

**QPA**

## Characteristics

- ◆ Compact Size
- ◆ Offered over 7.0 to 170 GHz
- ◆ High Accuracy and Reliability
- ◆ Digital Readout, IEEE-488 Interface
- ◆ Manual/Motorized Operation Modes



## Product Description

QuinStar Technology's precision Motorized Programmable Rotary Vane Attenuators are available in full waveguide bands from 7.0 to 170.0 GHz. Attenuation control can be either manual via a front panel or remote-controlled using a standard IEEE-488 interface. Series QPA motorized attenuator's small compact package incorporates both the electronic controller and microwave attenuator components. The unit operates with a single +24 volt DC source or with an optional AC adapter.

Attenuation range is from 0 to 60 dB in 0.1 dB steps with 0.05 dB steps over 0 to 20 dB. A digital readout is provided on the front panel to display the current attenuation setting. The attenuators are highly reliable and designed to be used in Automated Test Equipment and in applications requiring remote power control.

## Specifications

Waveguide Band	Frequency Band (GHz)	Insertion Loss (Max.)	VSWR (Max.)	Power (Max.)
<b>XL (WR-112)</b>	7.0 - 10.0	0.5 dB	1.2:1	5 watts
<b>X (WR-90)</b>	8.2 - 12.4	0.5 dB	1.2:1	2 watts
<b>XS (WR-75)</b>	10.0 - 15.0	0.5 dB	1.25:1	2 watts
<b>KU (WR-62)</b>	12.4 - 18.0	0.5 dB	1.25:1	2 watts
<b>K (WR-42)</b>	18.0 - 26.5	0.5 dB	1.15:1	1 watt
<b>Ka (WR-28)</b>	26.5 - 40.0	0.5 dB	1.15:1	0.5 watt
<b>Q (WR-22)</b>	33.0 - 50.0	0.6 dB	1.15:1	0.5 watt
<b>U (WR-19)</b>	40.0 - 60.0	0.7 dB	1.15:1	0.4 watt
<b>V (WR-15)</b>	50.0 - 75.0	0.8 dB	1.20:1	0.3 watt
<b>E (WR-12)</b>	60.0 - 90.0	1.0 dB	1.2:1	0.25 watt
<b>W (WR-10)</b>	75.0 - 110.0	1.0 dB	1.2:1	0.25 watt
<b>F (WR-08)</b>	90.0 - 140.0	1.2 dB	1.3:1	0.2 watt
<b>D (WR-06)</b>	110.0 - 170.0	1.4 dB	1.3:1	0.2 watt

**Outline Drawings/Mechanical Specifications**

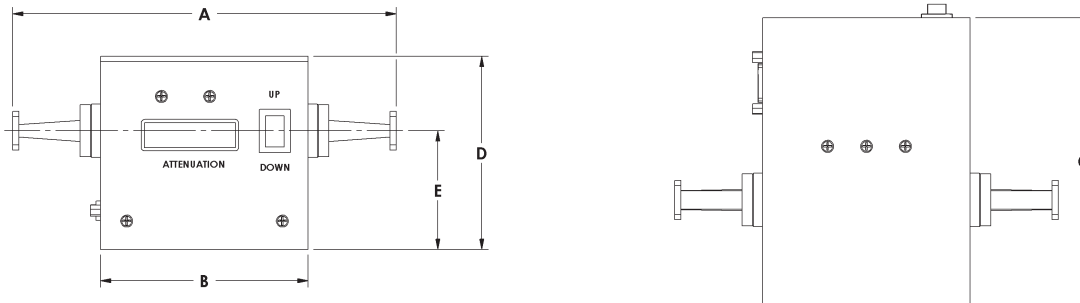

WAVEGUIDE BAND	OUTLINE DIMENSIONS, inches/mm				
	A	B	C	D	E
XL	11.69/296.9	4.66/118.3	6.32/160.5	3.73/94.7	2.29/58.2
X	11.69/296.9	4.66/118.3	6.32/160.5	3.73/94.7	2.29/58.2
XS	11.19/284.2	4.66/118.3	6.32/160.5	3.73/94.7	2.29/58.2
KU	10.94/277.8	4.00/101.6	5.50/139.7	3.73/94.7	2.29/58.2
K	8.48/215.4	4.00/101.6	5.50/139.7	3.73/94.7	2.29/58.2
KA	6.87/174.5	4.00/101.6	5.50/139.7	3.73/94.7	2.29/58.2
Q	6.24/158.4	4.00/101.6	5.50/139.7	3.73/94.7	2.29/58.2
U	5.74/145.7	4.00/101.6	5.50/139.7	3.73/94.7	2.29/58.2
V	4.50/114.3	4.00/101.6	5.50/139.7	3.73/94.7	2.29/58.2
E	4.50/114.3	4.00/101.6	5.50/139.7	3.73/94.7	2.29/58.2
W	4.50/114.3	4.00/101.6	5.50/139.7	3.73/94.7	2.29/58.2
F	4.50/114.3	4.00/101.6	5.50/139.7	3.73/94.7	2.29/58.2
G	4.50/114.3	4.00/101.6	5.50/139.7	3.73/94.7	2.29/58.2

**Ordering Information**

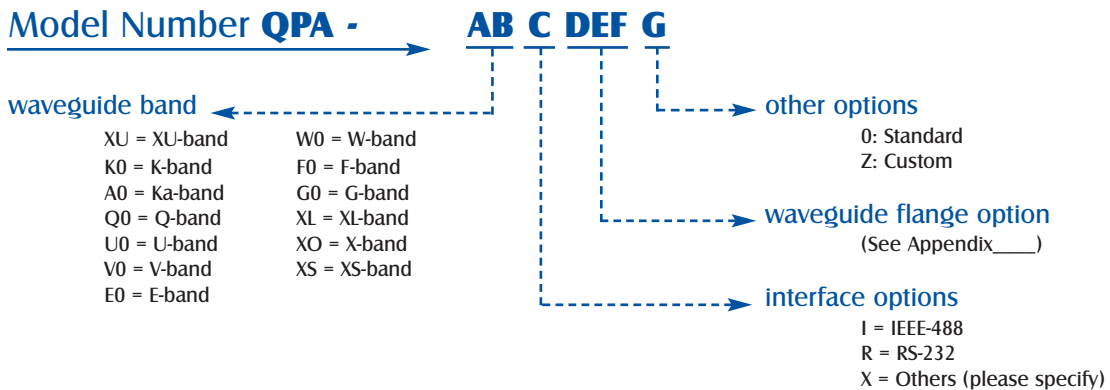



**Characteristics**

- ◆ Offered over 18-110 GHz
- ◆ High Accuracy
- ◆ Digital Readout
- ◆ Low Insertion Loss
- ◆ Manual and Computer Controlled
- ◆ Full Waveguide Bands



**Product Description**

QuinStar Technology offers Motorized Rotary Vane Phase Shifters in all waveguide bands from 18.0 to 110 GHz. The QMP series is a motorized, computer controllable version of QuinStar’s standard Direct Reading Phase Shifter and provides a 0 to 360° phase shift range with 0.5 degree resolution.

signals to the motor. Motor speed is variable to ensure accurate positioning and smooth operation. The Phase Shifter can be controlled remotely through an IEEE-488 interface or manually with a front panel control. A three-digit readout on the front panel displays the setting. The product requires a 24-volt, 500 mA power supply.

The phase shifter is controlled by a precision stepping motor and all control and driver electronics are packaged within the phase shifter housing. Microprocessor-based electronics translates the desired phase shifter setting into the required motor position and provides the proper drive

The QMP series motorized direct reading phase shifters are used in automated RF measurement systems. They are frequently used in RF substitution type test arrangements for precise measurement of phase characteristics including bridge circuits and phase networks.

**Specifications**

Waveguide Band	Frequency Range (GHz)	Insertion Loss dB typical	VSWR	Average Power
K	18.0-26.5	1.0	1.30	1.0
Ka	26.5-40.0	1.0	1.15	0.5
Q	33.0-50.0	1.0	1.15	0.5
U	40.0-60.0	1.1	1.15	0.4
V	50.0-75.0	1.2	1.20	0.3
E	50.0-90.0	1.4	1.20	0.2
W	75.0-110.0	1.5	1.20	0.2

Resolution (degree)	Repeatability	Accuracy	Speed (sec) 0-360
0.5	0.5	4 deg.	5 sec.



# ..... Motorized, Programmable Phase Shifter

**QMP**

## Outline Drawings/Mechanical Specifications

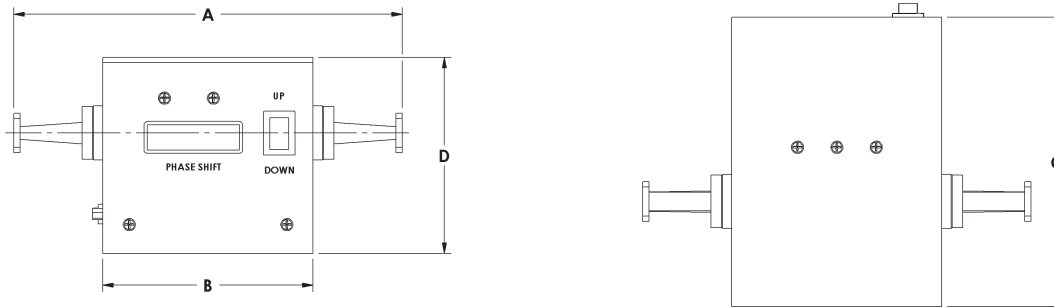

WAVEGUIDE BAND	OUTLINE DIMENSIONS, inches/mm			
	A	B	C	D
K	8.48/215.4	4.00/101.6	5.50/139.7	3.73/94.7
KA	6.87/174.5	4.00/101.6	5.50/139.7	3.73/94.7
Q	6.24/158.4	4.00/101.6	5.50/139.7	3.73/94.7
U	5.74/145.7	4.00/101.6	5.50/139.7	3.73/94.7
V	4.50/114.3	4.00/101.6	5.50/139.7	3.73/94.7
E	4.50/114.3	4.00/101.6	5.50/139.7	3.73/94.7
W	4.50/114.3	4.00/101.6	5.50/139.7	3.73/94.7

Test Equipment & Instrumentation Products **6**

## Ordering Information

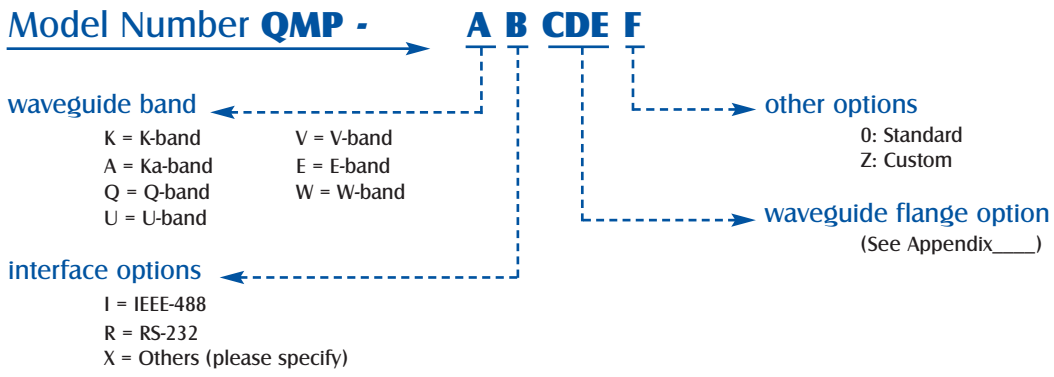



## Instrumentation and Measurement Products supplied by QuinStar Technology

In addition to the products described in this section, QuinStar also supplies the following millimeter wave and microwave products that are generally employed in most commonly used test and measurement subsystems and for instrumentation applications.

### Broadband Receiver Products

- Broadband Detectors (QEA)
- Harmonic Mixers and Diplexers (QMH)
- Spectrum Analyzer Mixers and Diplexers (QMA)
- Ultra Broadband Coaxial Mixers (QMC)

### Signal Sources and Frequency Extenders

- Broadband Frequency Multipliers- Active/Passive (QMM/QPM)
- Noise Sources (QNS)
- Frequency Extenders (QBE)

### Control Components and Ferrite Products

- Fullband Isolators (QIF, QJF)
- Fullband Modulators (QIM)
- Broadband PIN Switches and Attenuators (QSS/QSA)

### Waveguide Products

- Broadband Directional Couplers (QJG, QJR, QBC, QDC)
- Low Pass Filters (QFL)

### Amplifiers

- Full Band and Broadband Amplifiers



# Section 7

## Antenna Products

Product Title	Model No.	Page Number
<b>Antenna Products</b>		147
Application Notes		148
Standard Gain Horn Antennas	<b>QWH</b>	152
Custom Feed Horn Antennas	<b>QRR</b>	155
Narrow and Wide Beam Scalar Feed Horn	<b>QSH/QSW</b>	157
Sectoral Horn Antennas	<b>QSF</b>	158
Omni-directional Antennas	<b>QOD</b>	159
Lens Antennas	<b>QLA</b>	160
Cassegrain Reflector Antennas	<b>QRC</b>	162
Orthomode Transducers	<b>QWO</b>	164
Linear and Circular Fixed and Switchable Polarizers	<b>QWL/QWQ</b>	166
Circular-to-Rectangular Waveguide Transitions	<b>QWC</b>	168
Mode Transition TE01 to TE10	<b>QMT</b>	169
Mode Filter	<b>QMF</b>	171
Circular Waveguide (TE11) Section	<b>QCW</b>	172
Circular Waveguide Termination	<b>QTC</b>	174
TE01 Circular Waveguide Sections and Flanges	<b>QCL/QCF</b>	175
Rotary Joints	<b>QRJ</b>	177
Antenna Development Capability & Measurement Facility		178

# Application Notes

**QuinStar Technology** is a leading supplier of millimeter wave antennas and associated products for frequencies ranging from 18 to above 140 GHz. The range of products offered cover virtually every application and functional requirement. Several options in terms of physical construction or operating principle are generally available to achieve an optimal solution for a specific application or requirement. The half-power beamwidth of a typical antenna is determined by the aperture diameter  $D$  and is typically  $70 \times \text{Wavelength}/D$  over much of the band. Figure 1 shows the relationship between gain, beamwidth and antenna size as a function of operating frequency. QuinStar's antennas exhibit high overall efficiency and achieve the maximum possible gain. Custom products are designed to meet special requirements and configurations specific to a system application. Key product families produced by QuinStar and their associated technology are described here.

## Feeds, Orthomode Transducers and Related Products

QuinStar offers a wide range of standard and customer specific feed horns, orthomode transducers, polarizers and other antenna-related products for virtually any application and system requirement. We have an extensive library of fully developed and proven designs in this area. Our entire antenna feed products and related components are fully tested for all pertinent characteristics and specifications. In particular, QuinStar has designs for optimal performance and compact or miniaturized versions of many complex products.

## Quasi-Optical Products Capability

Free space propagation of millimeter waves is exploited for achieving low loss in many antenna-related components. QuinStar uses quasi-optics concepts in combination with other techniques to produce high performance antennas for many systems such as radar, surveillance, remote sensing, material measurements, radioastronomy and plasma diagnostics. The major advantage of quasi-optical transmission over conventional waveguide is its low loss, especially at high millimeter wave frequencies. The actual loss in propagation between optical elements can be made extremely small by proper design and fabrication. The reflection loss from metal mirrors is virtually immeasurable throughout the millimeter wave region, and the loss from well designed lenses is only a few tenths of dB. Other important advantages of free space transmission over waveguide-based components include the ability to support all possible polarizations. Very high isolation (often greater than 30 dB) can be obtained between orthogonal polarizations.

## Applications of Quasi-Optical Components and Subsystems

Quasi-optical antenna assemblies can be made very compact in comparison to equivalent systems utilizing waveguide components. Devices such as frequency duplexers, polarization diplexers, circular-to-linear polarizers, and phase shifters can be placed in the otherwise unutilized space between the lens or mirrors and the feed system instead of being added externally. Adding waveguide components such as a circular-to-linear polarizer, a circular-to-rectangular transition or an orthomode transducer to a quasi-optical lens antenna would increase the overall length by over 50%. Figure 2

shows various antenna functions and polarization options using quasi-optical waveguide components and their corresponding waveguide counterparts.

## Reflector Antennas

QuinStar offers Cassegrain reflector antennas in diameters ranging from 6 to 48 inches. Other modified versions of Cassegrain reflector antenna are also available by special order. These offset reflector antennas have no beam blockage, which makes the sidelobes significantly lower and the gain higher than that of symmetric Cassegrain antennas. Cassegrain antennas are frequently used in millimeter wave radars, communication systems or data links, and in special applications. Our near-field and far-field antenna ranges are ideal tools for evaluating antennas and related systems.

## Glossary of Antenna and Quasi-optics terms:

**Antenna** – Component or structure for radiating or receiving electromagnetic waves.

**Antenna efficiency of an aperture-type antenna** – For an antenna with a specified planar aperture, the ratio of the maximum effective area of the antenna to the physical aperture area.

**Aperture of an antenna** – A surface, near or on an antenna, on which it is convenient to make assumptions regarding the field values for the purpose of computing fields at external points. NOTE: The aperture is often taken as the portion of a plane surface near the antenna, perpendicular to the direction of maximum radiation, through which the major part of the radiation passes.

**Aperture blockage** – A blocking of or interfering with the radiation from the feed of secondary radiator by obstacles such as the feed itself or support struts.

**Aperture illumination** – The field over the aperture as described by amplitude, phase and polarization distributions.

**Axial ratio** – The ratio of the axes of the polarization ellipse, denoting the ratio of two orthogonal polarizations.

**Bandwidth of an antenna** – The range of frequencies within which the performance of the antenna, with respect to some antenna characteristics (gain, VSWR, beam shape, etc.), conforms to a specified specifications.

**Beam of an antenna** – The major lobe of the radiation pattern of an antenna.

**Boresight** – See electrical boresight; reference boresight.

**Boresight error** – The angular deviation of the electrical boresight of an antenna from its reference boresight.

**Cassegrain reflector antenna** – A dual-reflector antenna with a subreflector (usually hyperboloidal) located between the focal point and the vertex of the main reflector.

**Conical scanning** – A form of sequential lobing in which the direction of maximum radiation generates a cone whose vertex angle is of the order of the antenna halfpower beamwidth.

**Cross polarization** – The polarization orthogonal to a reference polarization. NOTE: Two fields have orthogonal polarizations if their polarization ellipses have the same axial ratio, major axes at right angles, and opposite sense of rotation.

**Directive gain** - In a given direction,  $4\pi$  times the ratio of the radiation intensity in that direction to the total power radiated by the antenna. NOTE: The directive gain is fully realized on reception only when the incident polarization is the same as the polarization of the antenna on transmission.

**Directivity** - The value of the directive gain in the direction of its maximum value.

**Effective area of an antenna** - In a given direction, the ratio of the power available at the terminals of a receiving antenna to the power per unit area of a plane wave incident on the antenna from that direction, polarized coincident with the polarization that the antenna would radiate.

**Efficiency** - See antenna efficiency; aperture illumination efficiency; radiation efficiency.

**Electrical boresight** - The tracking axis as determined by an electrical indication, such as the null direction of a conical scanning or monopulse antenna system, or the beam maximum direction of a highly directive antenna.

**E-plane, principal** - For a linearly polarized antenna, the plane containing the electric field vector and the direction of maximum radiation.

**Far-field region** - That region of the field of an antenna where the angular field distribution is essentially independent of the distance of the antenna. NOTE: 1.) If the antenna has a maximum overall dimension  $D$  which is large compared to the wavelength, the far-field region is commonly taken to exist at distances greater than  $2D^2/\lambda$  from the antenna,  $\lambda$  being the wavelength. 2.) For an antenna focused at infinity, the far-field region is sometimes referred to as the Fraunhofer region on the basis of analogy to optical terminology.

**Feed of an antenna** - That portion of an antenna coupled to the terminals which functions to produce the aperture illumination. NOTE: A feed may consist of a distribution network and a primary radiator.

**Front-to-back ratio** - The ratio of the directivity of an antenna to its directive gain in a specified direction toward the back.

**Gain** - See directive gain.

**Half-power beamwidth** - In a plane containing the direction of the maximum of a beam, the angle between the two directions in which the radiation intensity is one half the maximum value of the beam.

**Horn antenna** - A radiating element having the shape of a horn.

**Isolation between antennas** - A measure of power transfer from one antenna to another. NOTE: The isolation between antennas is the ratio of power input to one antenna to the power received by the other, usually expressed in decibels.

**Lens antenna** - An antenna consisting of an electromagnetic lens and a radiating feed.

**Main lobe** - See major lobe.

**Major lobe (main lobe)** - The radiation lobe containing the direction of maximum radiation.

**Monopulse** - In radar, simultaneous lobing whereby direction-finding information is obtainable from a single pulse

**Near-field region, radiating** - That region of the field of an antenna between the reactive near-field region and the far-field region wherein radiation fields predominate and wherein the angular field distribution is dependent upon distance from the antenna. NOTE: 1.) If the antenna has a maximum overall dimension which is not large compared to the wavelength, this field region may not exist. 2.) For an antenna focused at infinity, the radiating near-field region is sometimes referred to as the Fresnel region on the basis of analogy to optical terminology.

**Noise temperature of an antenna** - The temperature of a resistor having an available thermal noise power per unit bandwidth equal to that at the antenna output at a specified frequency. NOTE: Noise temperature of an antenna depends on its coupling to all noise sources in its environment as well as noise generated within the antenna.

**Paraboloidal reflector** - A reflector which is a portion of a paraboloid of revolution.

**Pattern** - See radiation pattern.

**Pencil beam antenna** - A unidirectional antenna having a narrow major lobe with approximately circular contours of equal radiation intensity in the region of the major lobe.

**Phase center** - In a given direction and for a specified polarization, the center of curvature of the wavefront of the radiation from an antenna in a given plane.

**Plane of polarization** - A plane containing the polarization ellipse. NOTE: 1.) When the ellipse degenerates into a line segment, the plane of polarization is not uniquely defined. In general, any plane containing the segment is acceptable; however, for a plane wave in an isotropic medium, the plane of polarization is taken to be normal to the direction of propagation. 2.) In optics, the expression plane of polarization is associated with a linearly polarized plane wave (sometimes called a plane polarized wave) and is defined as a plane containing the field vector of interest and the direction of propagation. This usage would contradict the above one and is deprecated.

**Polarization of an antenna** - In a given direction the polarization of the wave radiated by the antenna. Alternatively, the polarization of a plane wave incident from the given direction which results in maximum available power at the antenna terminals. NOTE: 1.) The polarization of these two waves is the same in the following sense. In the plane perpendicular to the direction considered, their electric fields describe similar ellipses. The sense of rotation of these ellipses is the same if each one is referred to the corresponding direction of propagation, outgoing for the radiated field, incoming for the incident plane wave.

**Polarization of a plane wave** - The polarization of a specified field vector in the plane wave. NOTE: 1.) It is the convention in electrical engineering to specify the polarization of the plane wave by that of the electrical field vector. 2.) In an isotropic medium, the plane of polarization is the plane perpendicular to the direction of propagation. It is the convention in electrical engineering to describe the sense of polarization at a fixed point in space as righthand (clockwise) or lefthand (counterclockwise) by choosing the direction of propagation as the reference direction. 3.) The

polarization of a plane wave is the same at every point in space.

**Power gain** – In a given direction, 4 p\_times the ratio of the radiation intensity in that direction of the net power accepted by the antenna from the connected transmitter. NOTE: 1.) When the direction is not stated, the power gain is usually taken to be the power gain in the direction of its maximum value. 2.) Power gain does not include reflection losses arising from mismatch of impedance.

**Power gain referred to a specified polarization** – The power gain of an antenna, reduced by the ratio of that portion of the radiation intensity corresponding to the specified polarization to the radiation intensity.

**Primary radiator** – A feed which illuminated a secondary radiator.

**Pyramidal horn antenna** – A horn antenna the sides of which form a pyramid.

**Radiating element** – A basic subdivision of an antenna which in itself is capable of effectively radiating or receiving radio waves. NOTE: Typical examples of a radiating element are a slot, horn or dipole antenna.

**Radiation efficiency** – The ratio of the total power radiated by an antenna to the net power accepted by the antenna from the connected transmitter.

**Radiation pattern (antenna pattern)** – A graphical representation of the radiation properties of the antennas a function of space coordinates. NOTE: 1.) In the usual case, the radiation pattern is determined in the far-field region and is represented as a function of directional coordinates. 2.) Radiation properties include power flux density, field strength, phase and polarization.

**Radome** – An enclosure for protecting an antenna from the harmful effects of its physical environment, generally intended to leave the electrical performance of the antenna unaffected.

**Reference boresight** – A direction defined by an optical, mechanical, or electrical axis of an antenna established as a reference for the alignment. See also electrical boresight.

**Reflector antenna** – An antenna consisting of a reflector and a radiating feed.

**Scan angle (beam angle)** - The angle between the maximum of the major lobe of an antenna. NOTE: Reference boresight is usually chosen as the reference direction.

**Scanning, of a beam antenna** - A repetitive motion given to the major lobe of an antenna.

**Shaped beam antenna** – An antenna which is designed to have a prescribed pattern shape differing substantially from that obtained from a uniform-phase aperture of the same size.

**Sidelobe** – A radiation lobe in any direction other than that of the intended lobe. NOTE: When the intended lobe is not specified, it shall be taken to be the major lobe.

**Sidelobe level, maximum relative** – The relative level of the highest sidelobe.

**Spillover** – That part of the power radiated by a feed not intercepted by the secondary radiator.

**Squint angle** – A small difference in pointing angle between a reference beam direction and the direction of maximum radiation.

**Subreflector** – A reflector which redirects the power radiated from the feed to the main reflector.

**Tracking (angle tracking)** – A motion given to the major lobe of an antenna such that a selected moving target is contained within the major lobe.

**Vertically polarized plane wave** – A plane wave in which the electric vector is in the vertical plane containing the direction of propagation.

## Antenna Beamwidth and Gain Characteristics

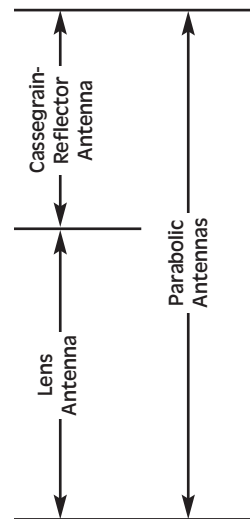
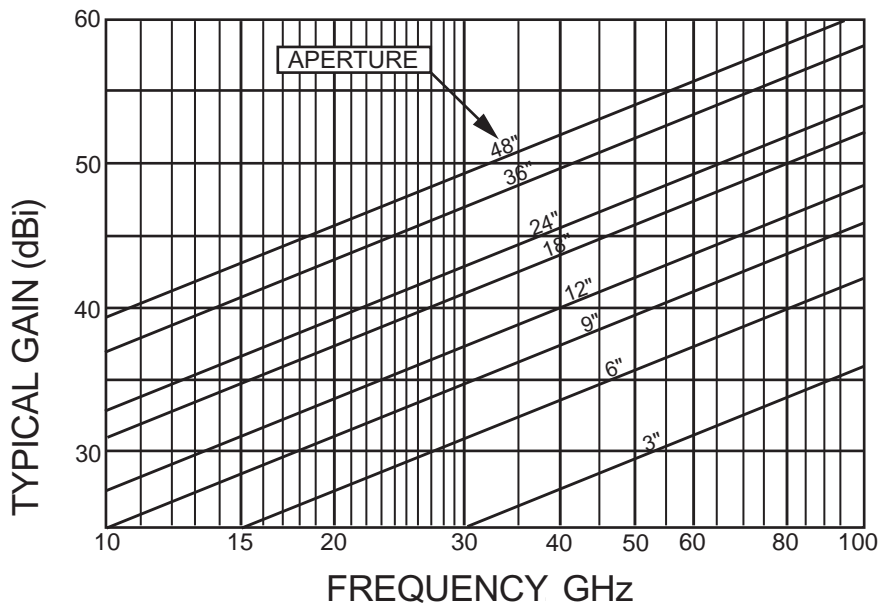
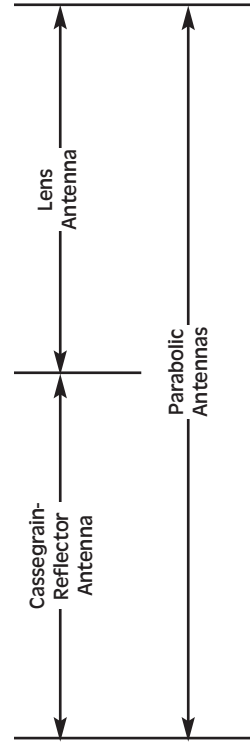
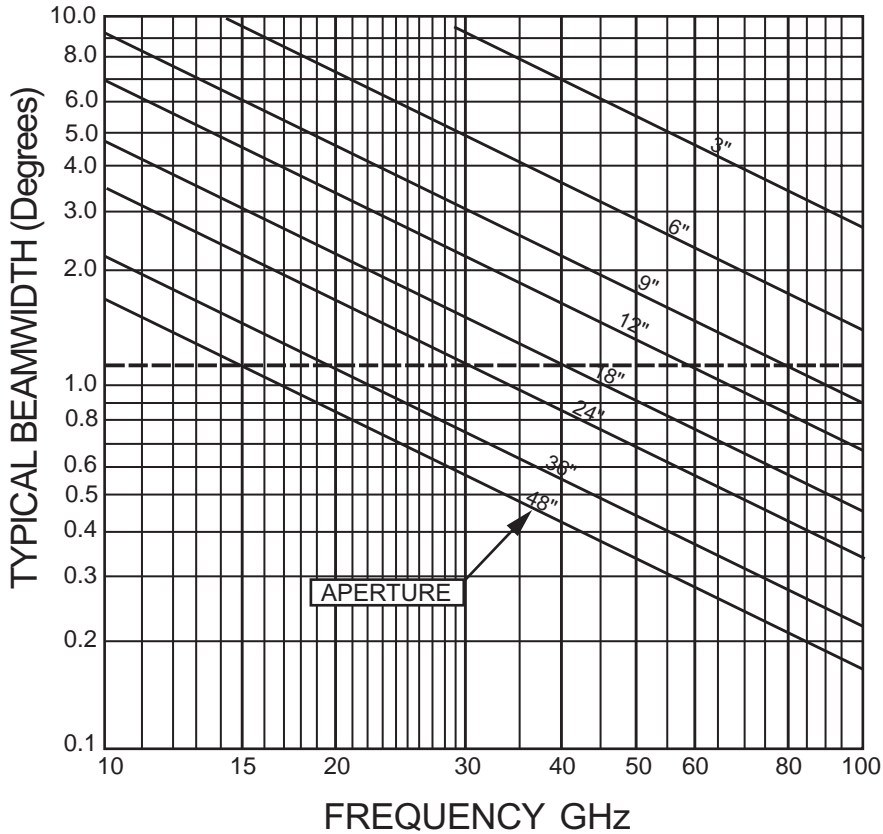



### Characteristics

- ◆ Pyramidal or Conical Shape
- ◆ Rectangular or Circular Waveguide Input
- ◆ Low VSWR



### Product Description

QuinStar Technology's **QWH** series of **standard gain horn antennas** cover the frequency range of 18 to 220 GHz in ten waveguide bands. They are available with either a rectangular aperture (pyramidal shape) for connecting to rectangular waveguide or a round aperture (conical shape) for use with either rectangular or circular waveguide. The pyramidal horns have a nominal mid-band gain of 24dB, with 21dB typical for the circular horns.

Standard gain horns are useful for a wide variety of propagation applications, including antenna testing and RF radiation measurements. Conical horns can be used to radiate or receive either linearly or circularly polarized waves. Both shapes are also usable as feed horns for lens and reflector antennas. The horns are precisely fabricated to control the aperture size and flare angle. Horns capable of producing customer-specific beam shapes and gain covering broad ranges are also available. Refer to series QRR custom feed horns.

### Specifications

FREQUENCY BAND	K	Ka	Q	U	V	E	W	F	D	G
Frequency Range (GHz)	18-26.5	26.5-40	33-50	40-60	50-75	60-90	75-110	90-140	110-170	140-220
Waveguide Size	WR-42	WR-28	WR-22	WR-19	WR-15	WR-12	WR-10	WR-8	WR-6	WR-5
VSWR (max)	1.10:1	1.10:1	1.10:1	1.10:1	1.15:1	1.15:1	1.15:1	1.20:1	1.25:1	1.25:1
Pyramidal Horn Mid-band Gain (dB typ)	24									
Conical Horn Mid-band Gain (dB typ)	21									

## Outline Drawings/Mechanical Specifications

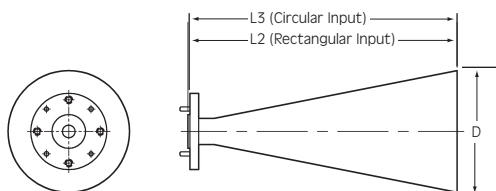

**Conical**  
(circular waveguide with round flange pattern shown)

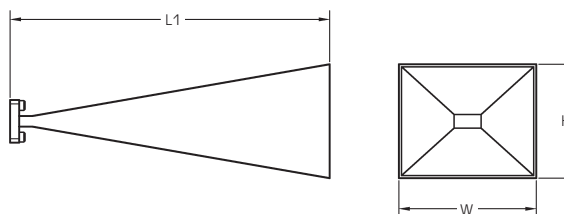

**Pyramidal**  
(rectangular waveguide with square flange pattern shown)

PYRAMID AND CONICAL HORNS WITH RECTANGULAR WAVEGUIDE INPUT							
Frequency Band	Waveguide Size	Flange Pattern	Outline Dimensions, inches/mm				
			Pyramidal Horns			Conical Horns	
			W	H	L1	D	L2
Ku	WR-62	UG-419/U	5.60/142.2	4.16/105.7	11.95/303.5	—	—
K	WR-42	UG-595/U	4.15/105.4	2.85/72.4	7.30/185.4	2.37/60.2	4.3/109.2
Ka	WR-28	UG-599/U	3.14/79.8	2.04/51.8	5.50/139.7	1.87/47.5	3.5/88.9
Q	WR-22	UG-383/U	2.61/66.3	1.67/42.4	4.25/107.9	1.51/38.4	3.0/76.2
U	WR-19	UG-383/U	2.20/	1.67/42.4	3.50/88.9	1.25/31.8	2.6/63.5
V	WR-15	UG-385/U	1.79/45.5	1.16/29.5	2.75/69.9	1.02/25.9	2.0/50.8
E	WR-12	UG-387/U	1.54/39.1	1.00/25.4	2.50/63.5	0.85/21.6	1.7/43.2
W	WR-10	UG-387/U	1.33/33.8	0.90/22.9	2.00/50.8	0.7/18.0	1.5/38.1
F	WR-8	UG-387/U	1.13/28.7	0.77/19.6	1.75/44.4	0.58/14.7	1.2/30.5
D	WR-6	UG-387/U	1.00/25.4	0.62/15.7	1.25/31.8	0.49/14.7	1.0/25.4
G	WR-5	UG-387/U	0.85/21.6	0.52/13.2	1.25/31.8	0.40/10.2	1.0/25.4

CONICAL HORNS WITH CIRCULAR WAVEGUIDE INPUT				
Frequency Band	Waveguide Diameter, inches/mm	Flange Pattern	Outline Dimensions, Inches/mm	
			D	L3
K	0.455/11.5	UG-381/U	2.37/60.2	4.0/101.6
Ka	0.315/8.0	UG-381/U	1.87/47.5	3.3/83.8
Q	0.251/6.3	UG-383/U	1.51/38.4	2.7/68.5
U	0.211/5.3	UG-383/UM	1.25/31.8	2.25/57.1
V	0.166/4.1	UG-385/U	1.02/25.9	1.90/40.2
E	0.137/3.4	UG-387/U	0.85/21.6	1.60/40.6
W	0.113/2.8	UG-387/UM	0.71/18.0	1.30/33.0
F	0.090/2.2	UG-387/UM	0.58/14.7	1.10/27.9
D	0.073/1.8	UG-387/UM	0.49/12.5	0.90/22.8
G	0.058/1.4	UG-387/UM	0.40/10.2	0.75/19.0



# Standard Gain Horn Antennas

QWH

## Ordering Information

Model Number **QWH - A B C D 00**

waveguide band designator

- K = K-band
- A = Ka-band
- Q = Q-band
- U = U-band
- V = V-band
- E = E-band
- W = W-band
- F = F-band
- D = D-band
- G = G-band

horn shape

- C = conical
- P = pyramidal

flange type

- r = round
- S = square

waveguide input

- C = circular (conical only)
- R = rectangular (conical and pyramidal)

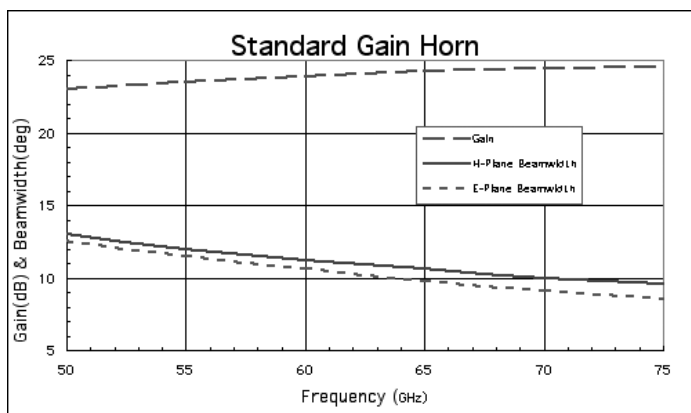



# Custom Feed Horn Antennas

## QRR

### Characteristics

- ◆ Custom Performance
- ◆ Low Sidelobes
- ◆ High Gain
- ◆ Low VSWR

### Product Description

QuinStar Technology offers a wide range of custom feed horns available in the 18-140 GHz frequency range. Products include conical and scalar (corrugated) horns and very wide beam pyramidal and sectoral horns. These horn antennas can be designed and produced to satisfy virtually any application or equipment requirement and can be fully tested at QuinStar to determine their precise radiation patterns and gain.

Beamwidth of the majority of conical and scalar horns is in the range of 6 to 40 degrees while broad beam pyramidal and sectoral horns range from 25 to 90 degrees at half-power full width points (3 dB beamwidth). The geometric design of the feed horns is carefully conducted to provide the best possible performance in a relatively compact size. The length of the antenna is determined by the beam pattern requirements and desired VSWR.

Feed horns provided by QuinStar are linearly polarized unless circular or dual polarization is requested. In addition, customized beam patterns, special materials and unique geometry can be provided. Some of the more commonly used feed horns are described below:

**Conical Feed Horn:** Least expensive horn and well suited for the majority of general purpose applications. Beam patterns in the E- and H-planes are dissimilar and gain ranges from 10 to 26 dB for most frequencies depending on aperture (beamwidth) and frequency.

**Pyramidal Feed Horn:** Relatively inexpensive and well suited for most general purpose applications. Beam patterns in the E- and H-planes are generally dissimilar and gain ranges from 10 to 27 dB depending on aperture and frequency.

**Sectoral Feed Horn:** Radiates a fan-shaped beam which is broad in one plane and relatively narrow in the other for



wide angular coverage. Typical beamwidths are in the range of 30 to 120 degrees in one plane and a few degrees in the other plane. The narrow beam can be obtained in either of the two planes (E- or H-plane). The gain of these antennas is largely determined by their beam patterns, and is generally in the 9-24 dB range.

**Scalar Feed Horn:** More expensive and highest performance horn. Beam shape is virtually independent of rotational angle (i.e. E- and H-plane radiation patterns are very similar). They are ideal when highly symmetrical antenna patterns are desired and well suited for reflector or lens antenna system feeds. Low VSWR and low sidelobes are also among the benefits of these horns.

**Special Application Feed Horns:** A variety of system applications, such as plasma diagnostics, depth or range measurement and receiver/transmitter arrays, require specially designed and produced feed horns or antennas. QuinStar can custom design such antennas and provide detailed measurements on their radiation characteristics.

The following parameters are necessary to completely specify a feed horn. However, QuinStar can propose a solution for your application if only some of the parameters are provided:

- ◆ Horn type—conical, pyramidal, scalar, sectoral, or custom (if unspecified QuinStar will select the best type);
- ◆ Beam shape—beamwidth in E- and H-plane, beam symmetry and any special features;
- ◆ Aperture—size and length constraints, if any;
- ◆ VSWR requirements;
- ◆ Sidelobe levels and cross polarization isolation requirements.



# Custom Feed Horn Antennas

## QRR

### Specifications

CHARACTERISTIC	PYRAMIDAL	CONICAL	SCALAR	SECTORAL
Beamwidth Range (degrees typ)	7-60	7-60	7-45	Broadbeam plane: 30 to 120 Other: 8 to 40
Gain Range (dB typ)	10-27	10-26	10-27	9-24
First Sidelobe Level (dB typ)	-12 to -16	-12 to -16	-20 to -25	-12 to -16

Consult QuinStar for outline drawings and mechanical specifications.

### Ordering Information

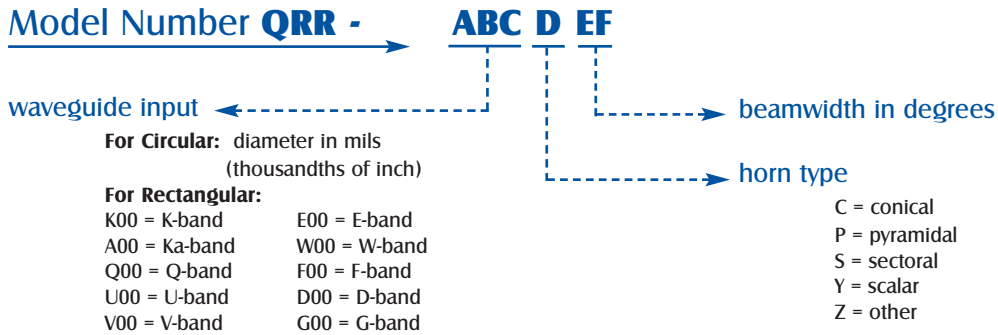

Antenna Products 7



# Narrow and Wide Beam Scalar Feed Horns QSH/QSW

## Characteristics

- ◆ Symmetrical Beam in E and H-planes
- ◆ Large Range of Beam Widths Offered
- ◆ Low VSWR, Low Sidelobes
- ◆ Polarization Insensitive

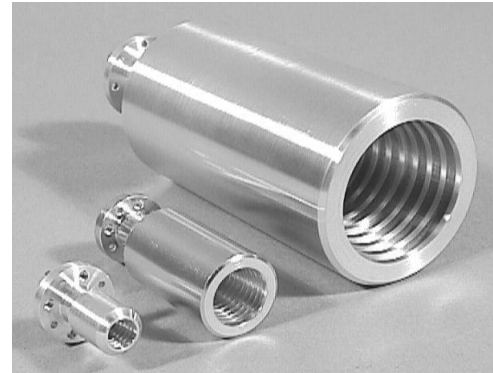

## Product Description

QuinStar Technology series QSH and QSW narrow and wide beam scalar feed horn antennas have been designed for use in antenna applications requiring highly symmetric beam pattern, low VSWR and low sidelobes. The radiation patterns are polarization-independent, i.e., relatively independent of plane of measurement. Scalar feed horn with half-power full beam width ranging from about 10 degrees to 60 degrees are available, with standard designs

at 25, 40 and 55 degrees. These feed horns are ideally suited for illuminating lens (in Lens Horn Antennas) and as feeds for Cassegrain Reflector Antennas with virtually any f/D ratio. QuinStar's Scalar Feed Horns offer a fairly broad operating bandwidth, up to 50% of center frequency, and high cross-polarization isolation (typically 30 dB).

## Specifications

Performance Characteristics	Available Range
Beamwidth (Half Power Full Width)	Series QSH10 to 40 degrees Series QSW 40 to 60 degrees
Pattern Variation between E- and H- Planes	+/- 2 dB over main lobe
Sidelobe Level	Typically 25 dB below main beam
Cross Polarization Isolation	30 dB typical
Bandwidth	50% of center freq.

## Ordering Information

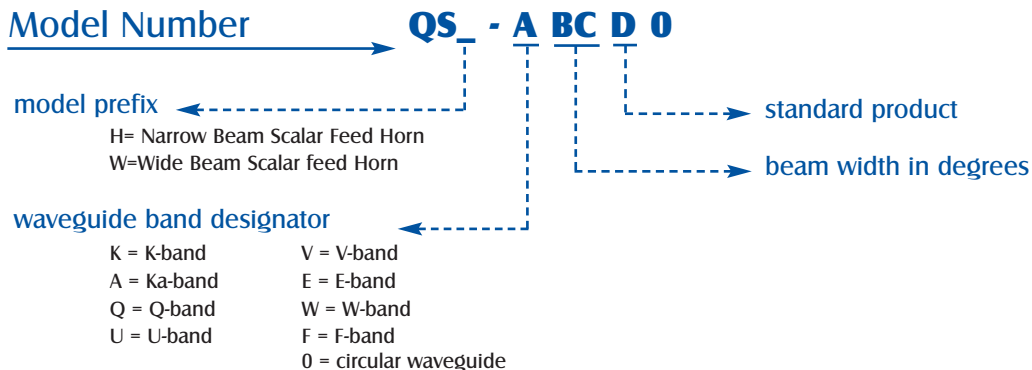



# Sectoral Horn Antennas

## QSF

### Characteristics

- ◆ Customized Beam Patterns in both Planes
- ◆ Optimum Gain Characteristics

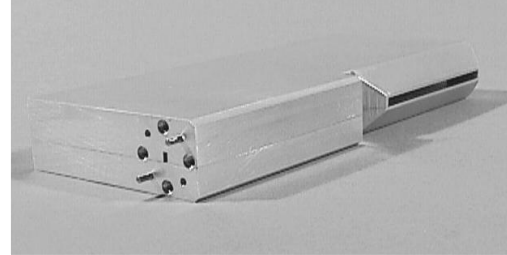

### Product Description

QuinStar Series QSF Sectoral Horn Antennas are custom products designed and manufactured to meet specific broad beam patterns in one of the planes, and relatively narrow beam in the other orthogonal plane. These antennas are offered for frequencies from 18 to 110 GHz. The horn geometry and mechanical features are designed to create a precise beam shape to match the application requirement in both planes. Broad beam (fan beam) pattern can be offered in either polarization, oriented in either azimuth or elevation plane with the narrower beam

in the other plane. Several standard products are also offered to suit a majority of system applications.

The directional gain of the antenna may be estimated using the following formula:

$$\text{Gain} = 27000 / (\text{Beamwidth in Azimuth Plane} * \text{Beamwidth in Elevation plane})$$

Beamwidths are in degrees, full width at half power points.

### Specifications

Frequency range and Bandwidth	Range of Beamwidths in Broad Beam Plane	Range of Beamwidths in Narrow Beam Plane
18-110 GHz		
10 % of Center Frequency	30 to 120 degrees	2 to 20 degrees

### Ordering Information

Model Number **QSF -**

**A BCD EFG H**

waveguide band designator

K = K-band      V = V-band  
 A = Ka-band     E = E-band  
 Q = Q-band      W = W-band  
 U = U-band

polarization

V= Vertical  
 H= Horizontal

beam width in azimuth plane, in degrees

beam width in elevation plane, in degrees



# Omnidirectional Antennas

## QOD

### Characteristics

- ◆ Offered over 18-110 GHz
- ◆ Uniform 360 degree Coverage in Azimuth
- ◆ Narrow Elevation Beam with Moderate Gain



### Product Description

QuinStar series QOD Omnidirectional Antennas provide a uniform 360 degrees coverage in the azimuth plane and a relatively narrower beam in elevation plane. They offer a reasonable gain over approximately 5% bandwidth. The elevation beamwidth can be designed to be in the 8 to 30 degree range to suit most common applications. The beam can be pointed up or down with respect to the horizon, if desired. An integral radome is normally provided with these Omnidirectional Antennas. Custom designs to suit

specific needs can be readily produced and fully tested. Typical interface is a standard rectangular waveguide, with options for circular waveguide. Antennas with circular polarization are also available as custom products. QuinStar also offers a wide range of Sectoral Coverage Antennas

Omnidirectional Antennas find applications in millimeter wave communications, EW/ESM and sensing applications.

### Specifications

Performance Parameter	Typical Range
Frequency Range	18-110 GHz
Bandwidth	5% typical
Elevation Beam Angle Range (Half Power Full Width)	Between 8 and 30 degrees
Gain Range (for Elevation Beam Range)	14 to 5 dB

### Ordering Information

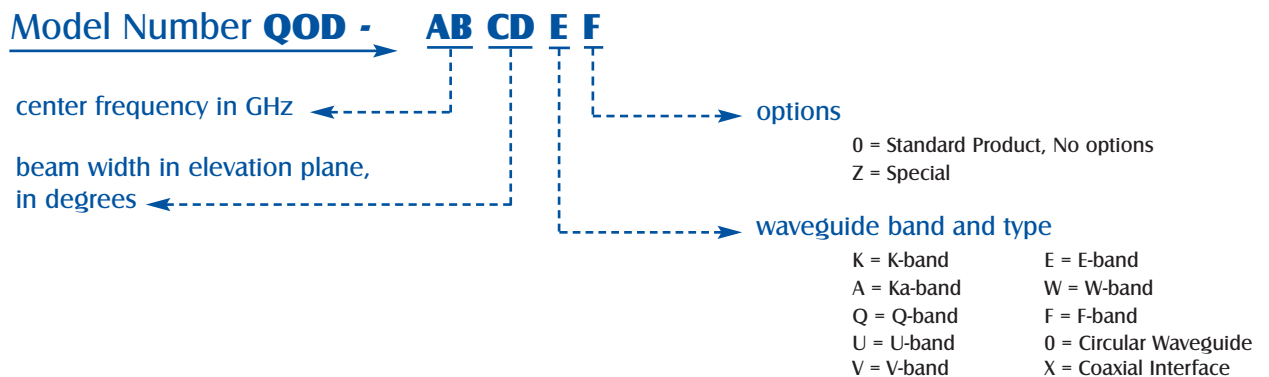



**Characteristics**

- ◆ Low Sidelobes
- ◆ High Gain and Efficiency
- ◆ Broadband
- ◆ Low Cost

**Product Description**

QuinStar Technology's QLA series lens antennas are available with apertures ranging from 3 to 12 inches (76-300 mm) for any frequency in the 18-140 GHz range. These antennas consist of a lens which is fed (illuminated) by a specially-designed feed horn. They have inherently low sidelobes, particularly in comparison to Cassegrain reflector antennas, as there is no blockage of the main beam by a subreflector or feed structure. Specially designed lenses when combined with high performance feeds produce high gain, precise beam patterns and efficiency comparable to the best reflector antennas, even at high millimeter wave frequencies. They operate over a fairly wide frequency range, which is generally determined by the characteristics of the input circular waveguide and feed horn. Standard antennas are focused at infinity (far field). However, custom designs focused at a finite range, generally 4 to 40 inches (0.1 to 1 meter) from the lens, can be provided.

The length of the antenna is nearly equal to its lens diameter ( $f/D = 1$ ) to achieve a reasonable size with optimal performance, although other  $f/D$  ratios are available as special products. The feed horn for these antenna may be either conical (standard product) or scalar

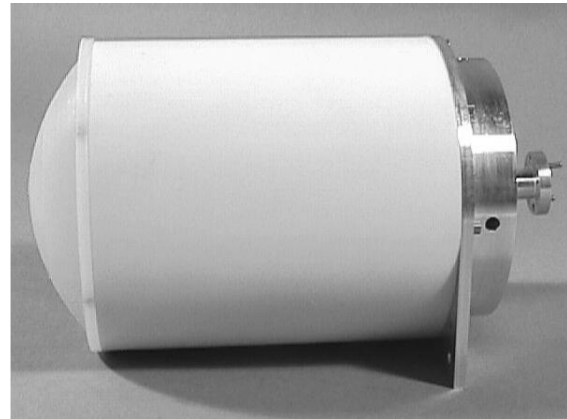

feed horn (symmetrical, low side lobe). Typical lenses have a smooth external surface and operate virtually independent of frequency. However, for specific narrowband applications, the lens can be zoned to reduce size and weight. The interface to these antennas is a circular waveguide of suitable diameter for the center frequency. However, an integral circular-to-rectangular waveguide transition is available as well as a variety of other options including a detachable circular-to-rectangular transition, orthomode transducer (OMT), circular polarizer (fixed or adjustable) and mountable bore-sighted telescope.

QuinStar can also provide antennas with dual-polarization capability and dual-frequency band operations as customized products.

Lens antennas are most practical in 3 to 12 inch (150 to 300 mm) diameters in the 30 to 140 GHz frequency range for applications where high performance, particularly low sidelobes, is critical. They can also be produced at a fairly low cost in large quantity. In addition, the antenna housing can be used as an enclosure for other components, system electronics or the entire system.

**Specifications**

CHARACTERISTIC	SPECIFICATION	COMMENTS
Frequency Range	18-140 GHz	Ideal above 20 GHz
Bandwidth	50% waveguide band	Dependent on circular waveguide
Lens Diameter Range	3-12 inches (76-300 mm)	Larger sizes available as custom products
Gain Range	25 to 50 dB depending on frequency and diameter	Refer to page 107 for expected gain and beamwidth associated with antenna size and frequency. Efficiency is typically greater than 50% for most combinations.
Beamwidth Range	0.2 to 10 degrees depending on frequency and diameter	
Input VSWR (typ)	1.15:1	Feed dependent
Sidelobes (typ)	>25 dB	Dependent on frequency and performance optimization

**Outline Drawings/Mechanical Specifications**

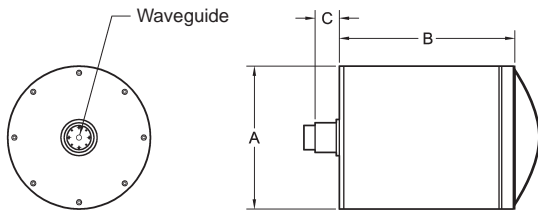

Cylindrical

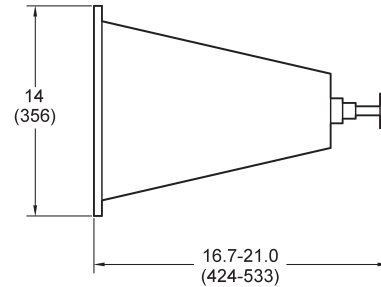

Conical

LENS DIAMETER, inches/mm nominal	OUTLINE DIMENSIONS, inches/mm nominal <sup>1</sup>		
	A	B	C <sup>2</sup>
3.0/76.2	3.5/89	3.8/96.5	1.0-2.0/25-51
6.0/152	6.63/168.4	7.4/188	1.0-2.0/25-51
9.0/229	9.5/235	11.0/279	1.0-2.0/25-51
12.0/305	12.75/324	14.5/368.3	2.0-3.0/51-76

<sup>1</sup> Actual dimensions may vary slightly due to adjustments and mechanical tolerances.

<sup>2</sup> Range of "C" dimension provided to show variation due to adjustments and feed horn variations.

**Ordering Information**

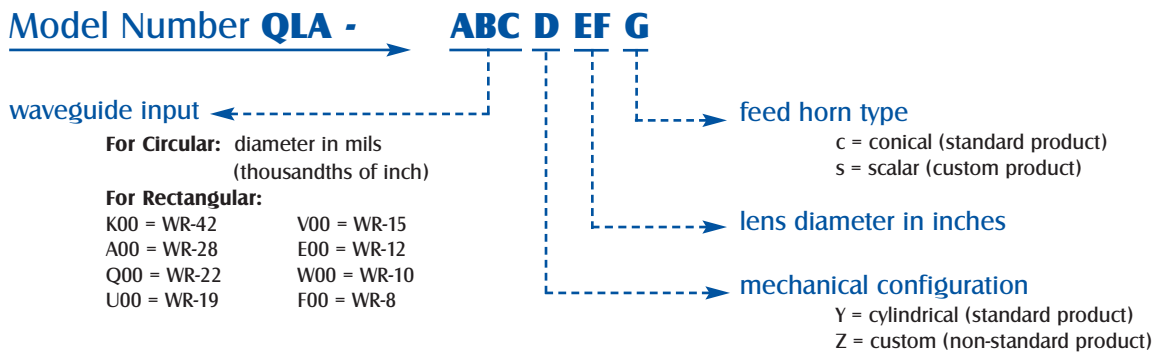



# Cassegrain Reflector Antennas

QRC

## Characteristics

- ◆ Compact and Low Profile
- ◆ High Gain
- ◆ Low VSWR
- ◆ 1 to 4 Foot Diameters



## Product Description

QuinStar Technology's **QRC** series **Cassegrain reflector antennas** are available in diameters ranging from 1 to 4 feet (30 to 120 cm) for any frequency in the 18-140 GHz range. They operate over a fairly wide frequency range which is limited only by the circular waveguide bandwidth. Gain is determined by antenna diameter, frequency of operation and feed illumination. These antennas are typically more efficient than the prime focus antennas, as the feed line losses are eliminated and a better match is obtained.

low sidelobe levels, generally below 16 dB. The feed horns are selected to produce optimal illumination for low sidelobes and high gain. The interface to these antennas is a circular waveguide of suitable diameter for the center frequency. However, an integral circular-to-rectangular waveguide transition is available as well as a variety of other options, including a detachable circular-to-rectangular transition, orthomode transducer (OMT), circular polarizer (fixed or adjustable) and mountable bore-sighted telescope.

The main reflector is parabolic in shape and machined very accurately of either aluminum or a composite material. The subreflector is optimally designed and adjusted for best performance. The subreflector and support structure create minimal blockage and hence produce reasonably

QuinStar's series QRC Cassegrain reflector antennas are ideally suited for applications requiring relatively low depth and good input match. However, Cassegrain antennas of diameters smaller than 12 inches (30 cm) are not recommended, particularly for frequencies below 30 GHz.

## Specifications

CHARACTERISTIC	SPECIFICATION	COMMENTS
Frequency Range	18-140 GHz	Ideal above 30 GHz
Bandwidth	Please see appendix	Dependent on circular waveguide
Reflector Diameter Range	12-48 inches (30-120 cm)	24 inch (60 cm) and larger for frequencies below 30 GHz
Gain Range	25 to 50 dB depending on frequency and diameter	Refer appendix for expected gain and beamwidth associated with antenna size and frequency.
Beamwidth Range	0.2 to 6 degrees depending on frequency and diameter	Efficiency is typically greater than 50% for most combinations.
Input VSWR (typ)	1.15:1	Feed dependent
Sidelobes (typ)	16 dB	Dependent on operating frequency and diameter of main and subreflectors

## Outline Drawing/Mechanical Specifications

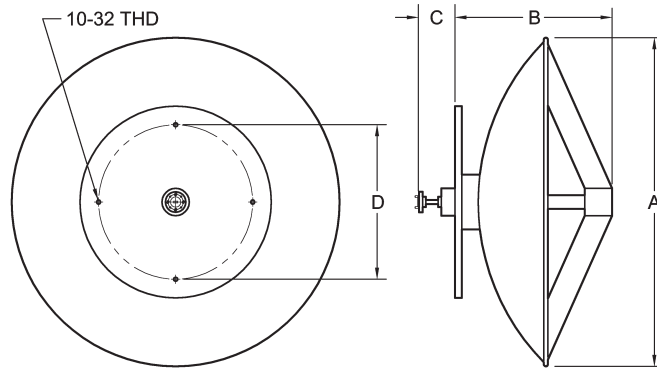

REFLECTOR DIAMETER, inches/mm nominal	OUTLINE DIMENSIONS, inches/mm			
	A	B <sup>1</sup>	C <sup>1</sup>	D
12.0/305	12.0/305	5.0-7.0/127-178	1.0-2.0/25.4-50.8	7.0/178
18.0/457	18.0/457	7.0-9.0/178-229	2.0-3.0/50.8-76.2	7.0/178
24.0/610	24.0/610	9.0-11.0/229-279	2.0-3.0/50.8-76.2	7.0/178
36.0/914	36.0/914	12.0-15.0/305-381	3.0-4.0/76.2-101.6	Note 2
48.0/1219	48.0/1219	16.0-19.0/406-483	3.0-5.0/76.2-127.0	Note 2

<sup>1</sup> Dimensions for "B" and "C" are given as ranges to allow for factory alignment and geometrical tolerances.

<sup>2</sup> Please consult factory to determine mounting "bolt circle" diameter for large reflectors.

## Ordering Information

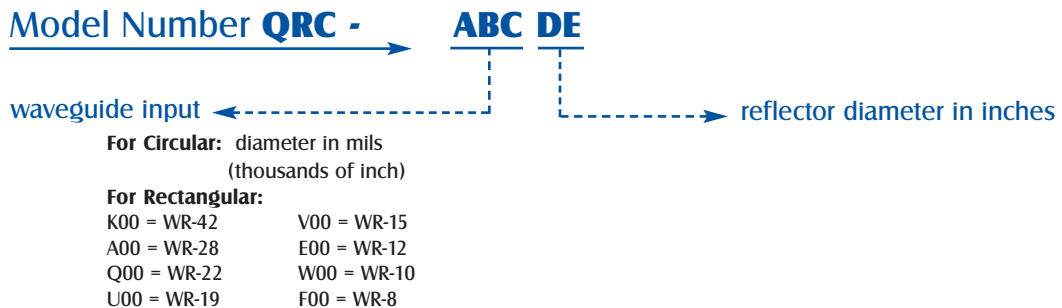

## Characteristics

- ◆ High isolation
- ◆ Low VSWR
- ◆ Minimum Insertion Loss
- ◆ Compact
- ◆ Broadband

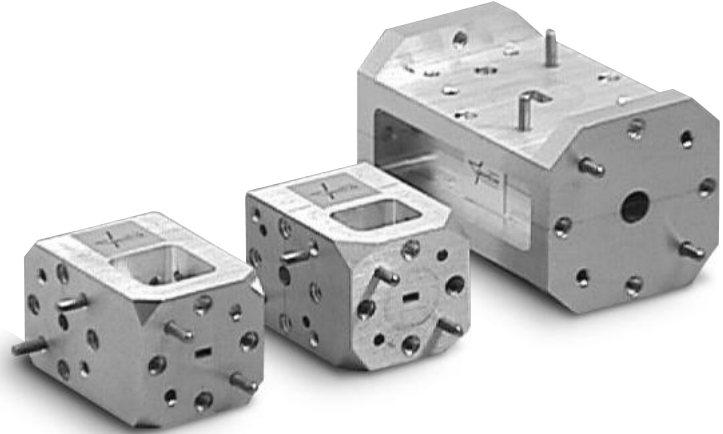

## Product Description

QuinStar Technology's **QWO** series **orthomode transducers** cover the frequency range of 26.5 to 110 GHz in six waveguide bands. They are used to separate a signal applied to the circular waveguide port into vertical and horizontal components at the two linear ports with greater than 25 dB isolation.

In reverse, two orthogonal linearly-polarized signals can be combined, producing an output in the circular waveguide

port. The resultant polarization may be linear, circular, or elliptical depending on the relative phase and amplitude of the two orthogonal input signals. An integrated compact rectangular-to-circular transition ( $< 0.25''/6.35$  mm) for the V port is available as an option.

Orthomode transducers operate over a bandwidth of typically 10% centered at a specific operating frequency. They are used in multipolarization radars, sensors, radiometers and instrumentation.

## Specifications

PERFORMANCE PARAMETER	TYPICAL CHARACTERISTICS
Frequency Range	26.5 to 110 GHz
Operating Bandwidth	50% of waveguide band
Isolation	25 dB minimum
VSWR (typ)	1.3:1 26.5 to 75 GHz; 1.4:1 75 to 110 GHz

## Outline Drawings/Mechanical Specifications

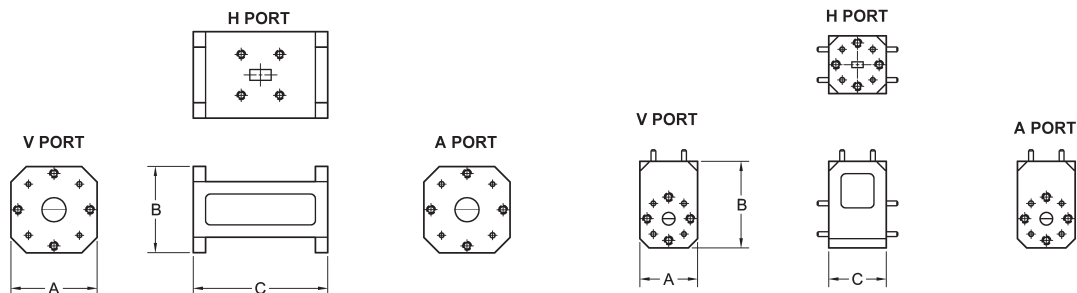

WR-28 through WR-19

WR-15 through WR-10

FREQUENCY BAND	WAVEGUIDE SIZE	FLANGE PATTERN	OUTLINE DIMENSIONS, inches/mm		
			A	B	C
Ka	WR-28	See Note 1	1.12/28.4	1.12/28.4	1.75/44.5
Q	WR-22	UG-383/U	1.12/28.4	1.12/28.4	1.75/44.5
U	WR-19	UG-383/U	1.12/28.4	1.12/28.4	1.75/44.5
V	WR-15	UG-385/U	0.75/19.1	1.12/28.4	0.75/19.1
E	WR-12	UG-387/U	0.75/19.1	1.12/28.4	0.75/19.1
W	WR-10	UG-387/U	0.75/19.1	1.12/28.4	0.75/19.1

<sup>1</sup> "H" port is UG-599/U. "V" and "A" ports are UG-381/U (circular cover flange).

## Ordering Information

Model Number **QWO - ABCDEO**

center frequency rounded to nearest GHz

1A = 100-110 GHz

configuration

A = standard  
 R = optional circular to rectangular V-port transition  
 Z = custom

waveguide band designator

A = Ka-band      V = V-band  
 Q = Q-band      E = E-band  
 U = U-band      W = W-band

circular waveguide diameter

L = low band (large)  
 M = mid band (medium)  
 H = high band (small)  
 Z = custom



# Linear-to-Circular Fixed and Switchable Polarizers

## QWL/QWQ

### Characteristics

- ◆ Low VSWR
- ◆ Minimum Insertion Loss
- ◆ Fixed; Manual and Motorized Switching
- ◆ Linear, LHCP and RHCP

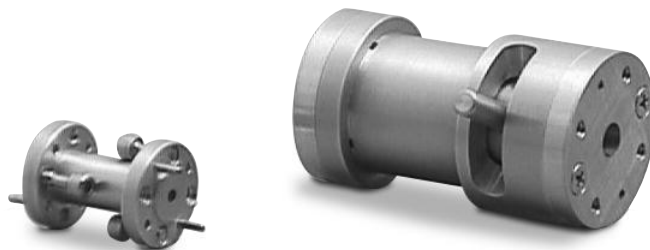

### Product Description

QuinStar Technology's **QWL** and **QWQ** series **linear-to-circular fixed** and **switchable polarizers** cover the frequency range of 26.5 to 110 GHz in six waveguide bands. Fixed polarizers are sections of circular waveguide with a built-in polarization converter that converts a linearly-polarized signal to either a left- or right-hand circularly-polarized signal, depending on the orientation of the waveguide section.

Series **QWQ switchable polarizers** have an internal polarizing card that can be manually rotated to change the signal between right- and left-hand circular polarization without disconnecting the waveguide. A center position

on the switch allows linearly-polarized signals to pass through the waveguide without changing polarization. These polarizers operate over a bandwidth of typically  $\pm 10\%$  centered at a specific operating frequency.

Electromechanically switchable polarizers have a microswitch- or TTL-compatible driver. The switch between linear-circular polarization conversion state and linear-linear non-conversion state. When used with the electro-mechanical switch and orthomode transducer, a linear input can be converted into linear vertical, linear/horizontal, RHCP or LHCP polarization at the output port.

### Specifications

PERFORMANCE PARAMETER	TYPICAL CHARACTERISTICS
Frequency Range	26.5 to 110 GHz
Operating Bandwidth	20% of waveguide band
Axial Ratio (max)	1 dB
VSWR (typ)	1.3:1

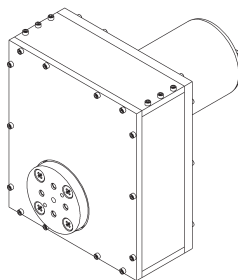

Motorized Polarizer



# Linear-to-Circular Fixed and Switchable Polarizers

## QWL/QWQ

### Outline Drawings/Mechanical Specifications

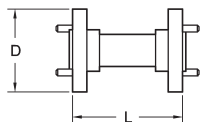

**Fixed Polarizer**  
(round flange pattern shown)

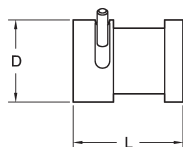

**Switchable Polarizer**  
(round flange pattern shown)

FREQUENCY BAND	WAVEGUIDE SIZE	FLANGE PATTERN	OUTLINE DIMENSIONS, inches/mm			
			Switchable Polarizer		Fixed Polarizer	
			Diameter (D)	Length (L)	Diameter (D)	Length (L)
Ka	WR-28	UG-381/U	1.25/31.8	2.12/53.8	1.13/28.7	1.50/38.1
Q	WR-22	UG-383/U	1.25/31.8	2.12/53.8	1.13/28.7	1.50/38.1
U	WR-19	UG-383/U	1.25/31.8	2.12/53.8	1.13/28.7	1.50/38.1
V	WR-15	UG-385/U	1.25/31.8	1.5/38.1	0.75/19.1	1.00/25.4
E	WR-12	UG-387/U	1.25/31.8	1.5/38.1	0.75/19.1	1.00/25.4
W	WR-10	UG-387/U	1.25/31.8	1.5/38.1	0.75/19.1	1.00/25.4

### Ordering Information

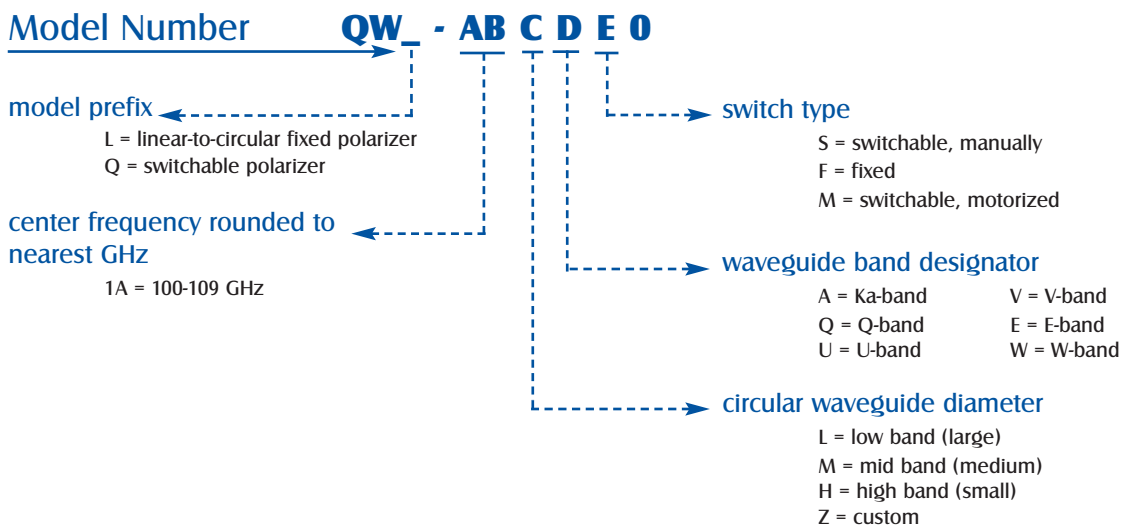



# Circular-to-Rectangular Waveguide Transitions

QWC

## Characteristics

- ◆ 26.5 to 110 GHz
- ◆ Low VSWR
- ◆ Minimum Insertion Loss



## Product Description

QuinStar Technology's **QWC** series **circular-to-rectangular waveguide transitions** cover the frequency range of 18 to 220 GHz in ten waveguide bands. The waveguide transitions are used to connect standard rectangular waveguide to circular waveguide with a minimum of loss

and reflections. They are available with a variety of flange types to join two components of the same waveguide size which differ in both waveguide aperture size and flange types. The transitions have a wide bandwidth and low VSWR.

## Specifications

FREQUENCY BAND	K	Ka	Q	U	V	E	W	F	D	G
Frequency Range (GHz)	18-26.5	26.5-40	33-50	40-60	50-75	60-90	75-110	90-140	110-170	140-220
Insertion Loss (dB max)	0.3	0.3	0.4	0.5	0.6	0.7	0.8	0.8	1.0	1.0
VSWR (max)	1.10	1.10	1.10	1.15	1.15	1.15	1.15	1.15	1.15	1.15
Length, inches/mm (typ)	2.0/50.8	1.50/38.1	1.50/38.1	1.50/38.1	1.10/27.9	1.10/27.9	1.10/27.9	1.10/27.9	1.10/27.9	1.10/27.9
Flange Pattern	UG-595/U	UG-599/U	UG-383/U	UG-383/U	UG-385/U	UG-387/U	UG-387/U-M	UG-387/U-M	UG-387/U-M	UG-387/U-M

Other waveguide sizes are available.

## Ordering Information

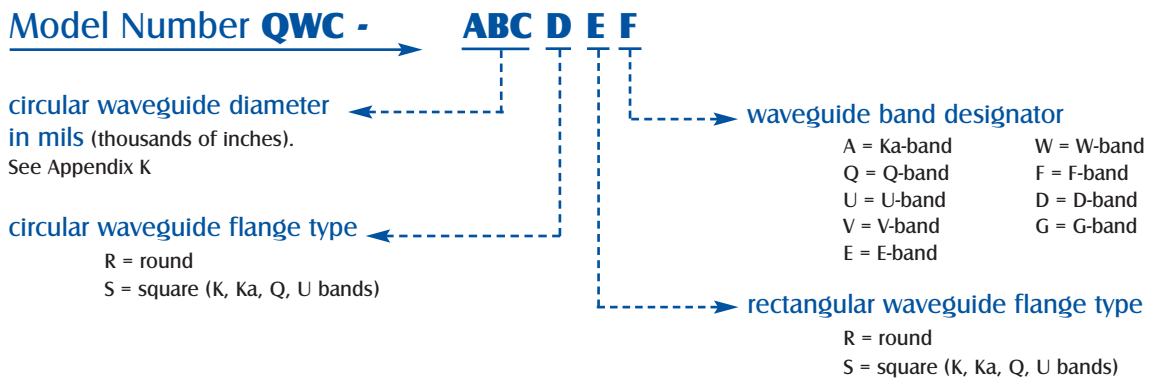

## Characteristics

- ◆ Minimal Insertion Loss, Low VSWR
- ◆ Optional Pressurized Models Available
- ◆ Efficient Conversion

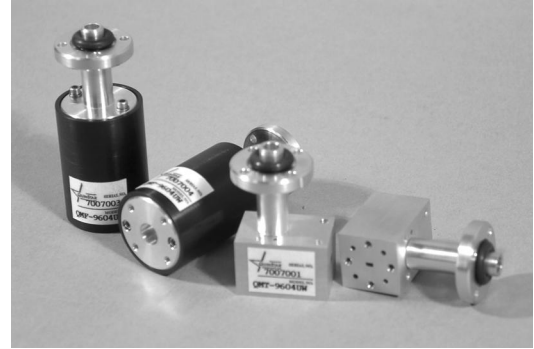

## Product Description

QuinStar Technology's QMT series TE01 to TE10 mode transitions are available for operation from 18.0 to 140.0 GHz. These reciprocal devices have a standard rectangular TE10 mode waveguide input and a circular waveguide TE01 mode output. Because of the larger frequency ranges of rectangular waveguide when compared to a circular TE01 mode waveguide, it is possible for a mode transition with a rectangular waveguide input to have one of several different circular waveguide size outputs, depending on frequency range of interest.

The QMT series circular mode waveguide features low VSWR and low insertion loss. The flanges used for circular

waveguide output are QuinStar's standard male/female type. For maximum mode purity, mode filters are recommended.

The QMT series rectangular-to-circular waveguide transitions are useful in millimeter wave radar systems or laboratory setups where long transmission lines are required. These transitions will provide efficient conversion from the TE10 rectangular waveguide mode to the TE 01 circular waveguide mode for high-power low-loss transmission.

## Specifications

Rectangular Waveguide Band	KU	K	A	B	U	V	E	W	F
Frequency Band (GHz)	12.4-18.0	18.0-26.5	26.5-40.0	33.0-50.0	40.0-60.0	50.0-75.0	60.0-90.0	75.0-110.0	90.0-140.0
Insertion Loss (dB) Max. <sup>1</sup>	0.3	0.3	0.3	0.4	0.4	0.5	0.5	0.6	0.8
VSWR Max.	1.4:1	1.4:1	1.4:1	1.4:1	1.4:1	1.4:1	1.4:1	1.5:1	1.60
Bandwidth <sup>4</sup>	6%	6%	6%	6%	5%	5%	4%	4%	3%
Average Power (Watts) <sup>2</sup>	4000	2000	1000	1000	600	400	200	100	50
Peak Power (kW) <sup>2</sup>	20	10	5	4	3	2	1	0.5	0.2
Weight (oz) <sup>3</sup>	40	30	25	25	25	10	5	5	4

<sup>1</sup> Loss measured using two Mode Transitions and Mode Filter

<sup>2</sup> Estimated

<sup>3</sup> Average: Weight varies with circular waveguide size and flange configuration

<sup>4</sup> Percentage of waveguide band



# Mode Transitions TE01 to TE10

## QMT

### Outline Drawings/Mechanical Specifications

RECTANGULAR WAVEGUIDE BAND	OUTLINE DIMENSIONS, inches/mm					
	A	B	C	D	E	F
KU	5.17/131.3	4.46/113.3	0.267/6.78	2.00/50.80	5.14/130.6	2.75/130.6
K	3.50/88.9	2.56/65.02	.267/6.78	1.25/31.75	*/*	*/*
Ka, Q, U	3.62/91.95	2.79/70.87	.267/6.78	1.12/28.45	2.25/57.15	1.30/33.02
V	2.00/50.80	1.41/35.81	.211/5.36	.75/19.05	1.16/29.46	.59/14.99
W	1.98/50.29	1.39/35.31	.211/5.36	.75/19.05	1.16/29.46	.59/14.99
F	1.98/50.29	1.39/35.31	.211/5.36	.75/19.05	1.16/29.46	.59/14.99

\* Dimension varies with frequency range

### Ordering Information

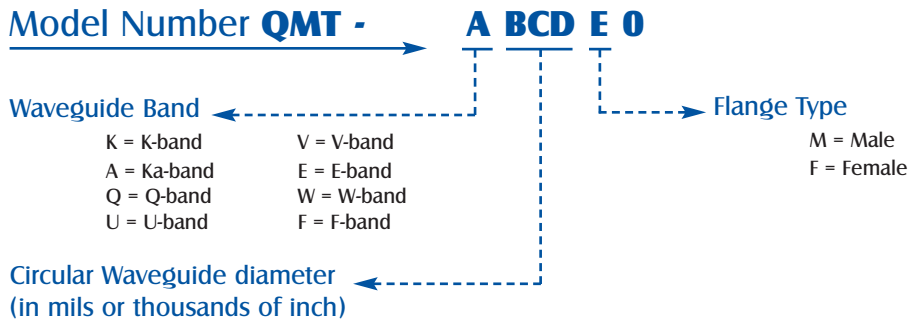



**Characteristics**

- ◆ Low Loss
- ◆ High Spurious Mode Attenuation

**Product Description**

QuinStar Technology's QMF series Mode Filters provide a solution to the critical need for mode purity when using TE<sub>01</sub> mode circular waveguide. Due to the similarities between the TE<sub>01</sub> and TM<sub>11</sub> modes, even the slightest irregularities in the circular waveguide cause mode conversion from TE<sub>01</sub> to TM<sub>11</sub>. The large waveguide diameters will readily propagate TE<sub>M1</sub> modes, which degrade the purity of the TE<sub>01</sub> signal. Extraneous TE<sub>M1</sub> and TE<sub>MN</sub> modes cannot be reconverted to the TE<sub>10</sub> rectangular mode – they show up as large spurious losses.

Each QMF series mode filter consists of a section of lossy wall waveguide. Because the higher order modes (TM<sub>M1</sub>, TE<sub>MN</sub>) have wall currents, they are sharply attenuated and do not propagate. Although the energy transferred to these modes is minimal, mode filters must be placed

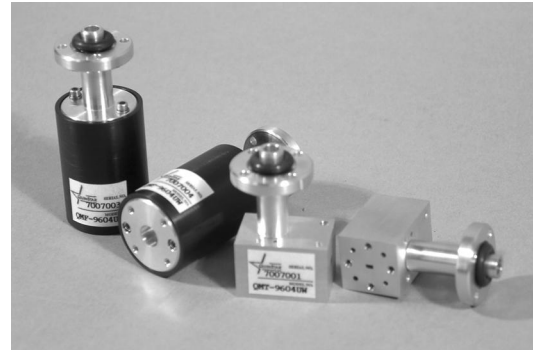

periodically along the transmission line. The TE<sub>01</sub> mode, which does not have wall currents, passes through this section unaffected. The QMF series mode filters are available in circular waveguide sizes from 12.4 to 140 GHz. They are fitted with one male and one female type of QuinStar's standard circular flanges.

The QMF series mode filters are used to prevent TE<sub>01</sub> conversion to higher order modes. By attenuating unwanted TEM<sub>1</sub> modes, the 340 series filters allow for the low loss transmission of TE<sub>01</sub>, TE<sub>02</sub> modes in circular waveguide and eliminate unwanted resonance, it is recommended that the QMF series filters be placed at least every 10 feet apart.

**Specifications**

Frequency Band (GHz)	11.6-48.0	48.0-96.0	96.0-150.0
Insertion Loss TE <sub>01</sub> (dB) Max.	0.2	0.3	0.4
Insertion Loss TE <sub>11</sub> (dB) Min.	10.0	10.0	10.0
VSWR Min.	1.20	1.20	1.25

Note: Contact factory for outlines

**Ordering Information**

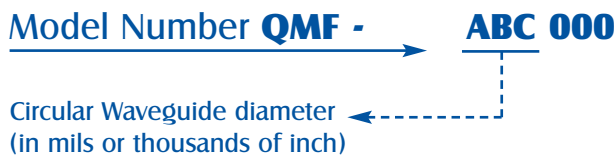



# Circular Waveguide Sections and Flanges

QCW

## Characteristics

- ◆ Available in Internal Diameter from 0.059-0.660 inch
- ◆ Precise Dimensions

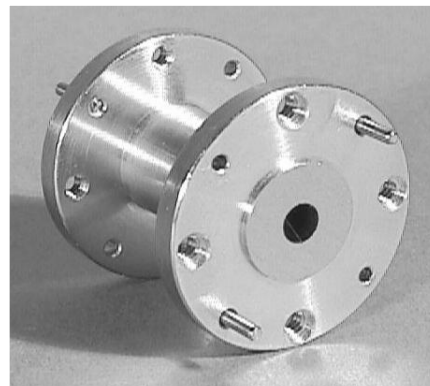

## Product Description

QuinStar Technology offers circular waveguides (flanged and unflanged) for operation in the TE11 mode for frequencies from 12 to 220 GHz in all standard and many custom internal diameters ranging from 0.059 to 0.660 inches. The bandwidth associated with these TE11 mode circular waveguides is narrower than a typical rectangular waveguide in the same general frequency range. Since several internal circular waveguide diameters are

applicable for a given frequency, please contact QuinStar with your specific requirement.

QuinStar also can supply rectangular to circular waveguide transitions (Series QWC) for all applicable combinations of these circular and rectangular waveguides.

## Specifications

See Appendix for Mechanical Specifications for Circular Waveguide Flanges

Table Of Internal Diameters for TE11 Circular Waveguides

Band Designation	Frequency Range, GHz	Internal Diameter, inch	Band Designation	Frequency Range, GHz	Internal Diameter, inch
Ku-1	12.4-14.6	0.660	E-0	58-68	0.141
Ku-2	14.6-17.5	0.550	E-1	68-77	0.125
K-1	17.5-20.5	0.470	E-2	77-87	0.110
K-2	20.5-24.5	0.396	E-3	87-100	0.094
K-3	24.5-26.5	0.328	W-0	77-87	0.110
Ka-0	26-28.5	0.328	W-1	87-100	0.094
Ka-1	28.5-33	0.281	W-2	100-112	0.082
Ka-2	33-38.5	0.250	F-0	87-100	0.094
Ka-3	38.5-43	0.219	F-1	100-112	0.082
Q-0	33-38.5	0.250	F-2	112-125	0.075
Q-1	38.5-43	0.219	F-3	125-140	0.067
Q-2	43-50	0.188	D-0	100-112	0.082
U-0	38.5-43	0.219	D-1	112-125	0.075
U-1	43-50	0.188	D-2	125-140	0.067
U-2	50-58	0.165	D-3	140-160	0.059
V-0	50-58	0.165	G-0	125-140	0.067
V-1	58-68	0.141	G-1	140-220	0.059
V-2	68-77	0.125			



# Circular Waveguide Sections and Flanges

## QCW

### Ordering Information

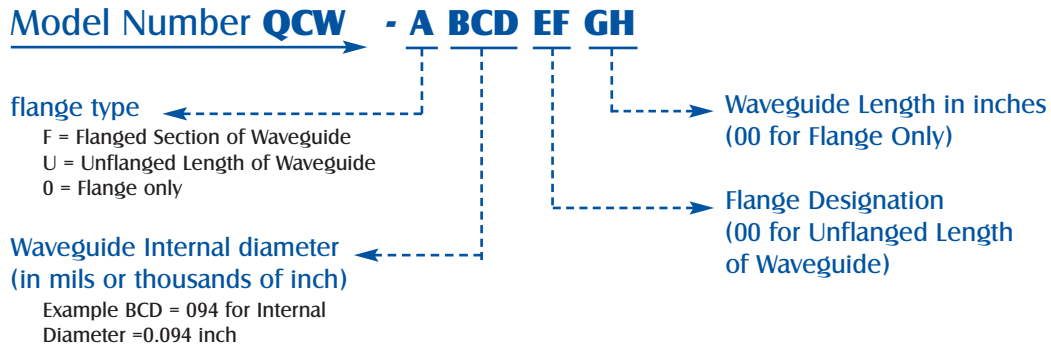



# Circular Waveguide Terminations

QTC

## Characteristics

- ◆ Low VSWR
- ◆ Full Circular Waveguide Bandwidth

## Product Description

QuinStar Technology's QTC series termination is a section of circular waveguide with an integral conical load made from a dielectric absorber material. The long precise taper allows

optimum absorption of the microwave energy with minimum reflection. Each termination is fitted with a standard male or female circular flange, specified at the time of order. The QTC terminations are used in experimental and developmental test set-ups where a low VSWR waveguide load is essential for measurement validity. When measuring the VSWR that results from insertion of various waveguide components in a system, these terminations ensure precise determination of the individual effects.

## Specifications

Frequency Range (GHz)	11.6-48.0	48.0-96.0	96.0-150.0
VSWR	1.05	1.08	1.10

## Outline Drawings/Mechanical Specifications

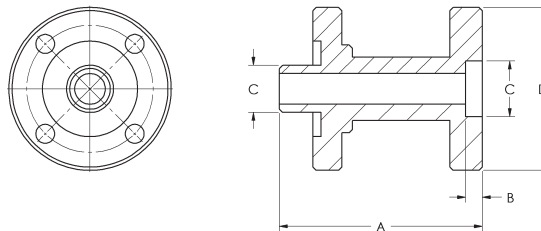

CIRCULAR WAVEGUIDE INTERNAL DIAMETER	OUTLINE DIMENSIONS, inches/mm			
	A	B	C	D
0.210	2.22/56.39	.211/5.36	.250/6.35	1.20/30.48
0.250	2.22/56.39	.211/5.36	.291/7.39	1.20/30.48
0.291	2.22/56.39	.211/5.36	.375/9.53	1.20/30.48
0.353	2.22/56.39	.211/5.36	.437/11.10	1.20/30.48
0.495	4.26/108.2	.264/6.71	.625/15.88	1.95/49.53
0.545	3.76/95.5	.264/6.71	.625/15.88	1.95/49.53
0.634	3.76/95.5	.264/6.71	.750/19.05	1.95/49.53
0.688	4.76/120.9	.264/6.71	.788/20.02	1.95/49.53

Contact QuinStar for other circular waveguide diameters.

## Ordering Information

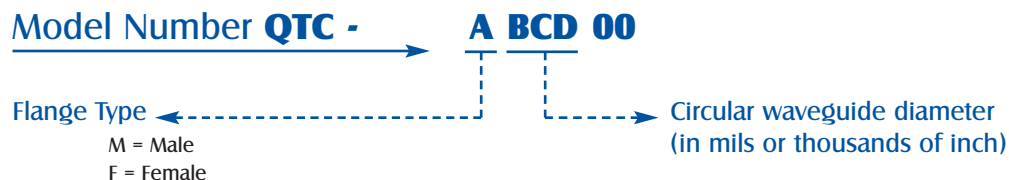



# TE<sub>01</sub> Waveguide Sections and Flanges

## QCL/QCF

### Characteristics

- ◆ Very Low Loss
- ◆ Low VSWR
- ◆ Precise Dimensions

### Product Description

QuinStar Technology's series QCL flanged and unflanged TE<sub>01</sub> mode circular waveguides are available in standard sizes from internal diameters of 0.186 to 1.500 inch for use over 11.6 to 171 GHz. These waveguide sections are fitted with standard male/female flanges. Both waveguide types are manufactured primarily in copper. QuinStar recommends using the Series QMF mode filters in any circular waveguide system to maintain mode purity.

QuinStar Technology's Series QCF circular waveguide flanges have been designed specifically for the TE<sub>01</sub> low loss mode circular waveguide components. These flanges

are precision-machined to facilitate low loss, low reflection waveguide connections at millimeter wave frequencies. O-ring gaskets are included to make these flanges appropriate for use in pressurized waveguide systems. The circular waveguide flanges are self aligning male/female connectors and are available in both standard and custom size waveguide.

Since a wide variation of circular diameters is applicable for a given frequency, please contact QuinStar with your specific requirement.

### Specifications

Series QCL TE <sub>01</sub> Circular Waveguide						
Standard Waveguide			MIL-W-23068 Circular Waveguide			
I.D.	O.D. (inches)	Frequency (GHz)	I.D.	O.D. (inches)	Frequency (GHz)	Designation
1.500	1.750	11.6-16.0	1.500	1.700	11.6-16.0	WRC530D1
1.265	1.375	13.2-18.9	1.281	1.441	13.2-18.9	WRC621D1
1.106	1.250	15.9-21.9	1.094	1.224	15.9-21.9	WRC727D1
0.951	1.125	18.6-25.6	0.938	1.068	18.6-25.6	WRC849D1
0.686	0.750	25.3-34.9	0.797	0.897	21.9-30.1	WRC997D1
0.688	0.888	25.3-34.9	0.688	0.788	25.3-34.9	WRC116C1
0.634	0.750	27.3-38.0	0.594	0.674	29.3-40.4	WRC134C1
0.545	0.625	32.0-44.0				N/A
0.495	0.625	34.8-48.0	0.500	0.580	34.8-48.0	WRC159C1
			0.438	0.518	39.8-54.8	WRC182C1
0.370	0.500	46.4-63.9	0.375	0.435	46.4-63.9	WRC212C1
0.353	0.438	50.0-68.0	0.328	0.388	53.1-73.1	WRC243C1
0.291	0.375	62.0-84.0	0.281	0.341	61.9-85.2	WRC283C1
0.249	0.313	69.7-95.9	0.250	0.290	69.7-95.9	WRC318C1
0.201	0.290	86.0-115.0	0.219	0.259	79.6-110.0	WRC364C1
0.186	0.250	93.0-128.0	0.188	0.228	92.9-128.0	WRC424C1
			0.172	0.212	101.0-139.0	WRC463C1
			0.141	0.181	124.0-171.0	WRC566C1



# TE<sub>01</sub> Waveguide Sections and Flanges

QCL/QCF

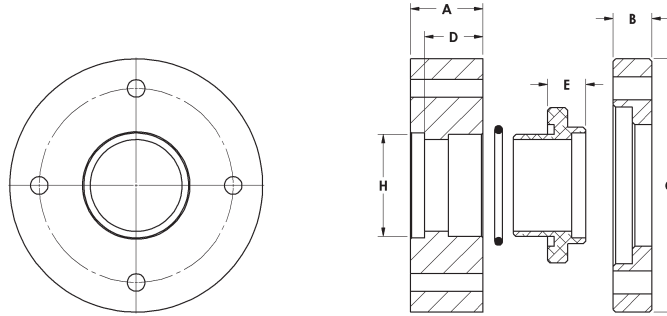

Series QCL TE <sub>01</sub> Circular Waveguide Flanges						
CIRCULAR WAVEGUIDE INTERNAL DIAMETER, INCH	OUTLINE DIMENSIONS, inches/mm					
	A	B	C	D	E	H
0.688	0.55/13.97	0.30/7.62	1.95/49.53	.450/11.43	.185/4.70	.788/20.02
0.635	0.55/13.97	0.30/7.62	1.95/49.53	.450/11.43	.185/4.70	.750/19.05
0.545	0.55/13.97	0.30/7.62	1.95/49.53	.450/11.43	.185/4.70	.625/15.88
0.495	0.55/13.97	0.30/7.62	1.95/49.53	.450/11.43	.185/4.70	.625/15.88
0.353	0.40/10.16	0.27/6.86	1.20/30.48	.300/7.62	.141/3.58	.437/11.10
0.291	0.40/10.16	0.27/6.86	1.20/30.48	.300/7.62	.141/3.58	.375/9.35
0.250	0.40/10.16	0.27/6.86	1.20/30.48	.300/7.62	.141/3.58	.291/7.39

## Ordering Information

Model Number → **QC - A BC DEF**

L = TE<sub>01</sub> Waveguide Section  
F = Flanges for Circular Waveguide

F = Flanged Section of Waveguide  
U = Unflanged Section of Waveguide  
0 = Flange only (for Series QCF)

Waveguide Internal diameter (in mils or thousands of inch)

Example DEF = 291 for  
Internal Diameter = 0.291 inch

Waveguide length in inches

### Characteristics

- ◆ Minimal Variation With Rotation
- ◆ Reliable, Rugged and Light Weight

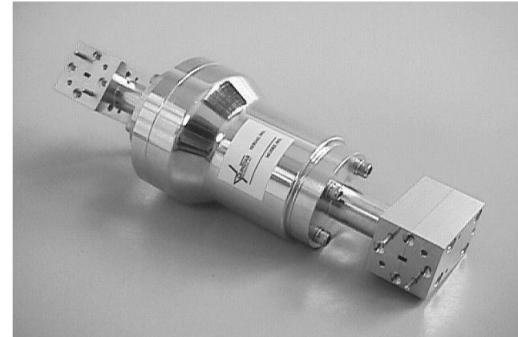

### Product Description

QuinStar Technology's Series QRJ rotary joints are available in standard circular waveguide sizes to cover frequencies from 11.6 to 150 GHz. Each rotary joint consists of two circular waveguide sections mounted on ball bearings. Connections to the guides are made using standard male and female circular flanges. Precise alignment of the waveguide sections prevents spurious mode generation, and the very small gap between abutting surfaces results in only a negligible loss in the TE01 circular mode. Amplitude variation with rotation is less than 0.2 dB and phase variation is less than 2 degrees for all models.

The QRJ rotary joints provide efficient energy transfer in radar antenna systems or in other applications requiring for

low phase variation, low insertion loss, and low return loss. They are also useful in special laboratory test set-ups for the measurement of millimeter wave parameters including phase variation in radiated fields. These rotary joints are designed for use with (or to interface with) circular waveguides.

The QRJ rotary joint can also be fitted with two Series QMT Mode Transitions and a Series QMF Mode Filter to provide a rotary joint assembly for rectangular waveguide applications.

### Specifications

Frequency Range	11.6-48.0 GHz	48.0-96.0 GHz	96.0-150.0 GHz
Insertion Loss TE01 (dB) Max.	0.3	0.4	0.5
VSWR Min.	1.1	1.1	1.15
Weight (oz)	30	24	15

### Ordering Information

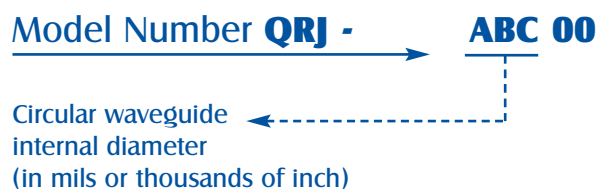



## QuinStar Technology Antenna Development Capability and Measurement Facility:

QuinStar has technical capability and analysis tools to develop advanced and special-purpose antennas and optics for use in the entire microwave and millimeter wave spectrum. For detailed evaluation and testing of these antennas and optical components, QuinStar has also created a well-instrumented and fully equipped measurement facility. For accurately measuring and rigorously diagnosing a very wide range of antenna sizes and types operating over a significantly large frequency interval, QuinStar has configured several different types of measurement facilities for optimal results and efficiency/speed.

### Fully Automated MW / MMW Antenna Measurement System:

QuinStar's new near-field antenna measurement system is designed to measure near-field antenna patterns and to generate near-field and calculated-far-field characteristics of the antenna response and performance. The system is composed of an Antcom NFH0003-8 scanner housed in a state-of-the-art, 13- by 17-foot anechoic chamber, capable of making planar scans for high gain narrow beam reflector, lens, and phased array antennas; spherical scans for low gain broad beam horn and lens antennas; and cylindrical scans for fan beam, omnidirectional, and linear array antennas. Additionally, it can take measurements at

multiple frequencies during each scan, and can process the near-field data to produce far-field graphical patterns.

Graphical and numerical presentations include radiation patterns for co- and cross-polarizations, axial ratio, gain (amplitude) and phase, rectangular and polar cuts, contour and 3D visualization, and elevation and azimuth cuts for different angles. The system can make presentations in color or grayscale plots, and create data tables exportable to Microsoft Excel and other programs.

The scanner can accommodate antennas up to five feet in diameter and up to a combined total of 142 foot-pounds in weight at the mounting point. The antenna under test can automatically be rotated 360° along the vertical mounting axis, and 360° along the horizontal mounting axis (typically the E-H plane axis). The center point for rotation on the vertical axis is software-selectable.

The system has been instrumented to measure antennas in the 1 to 140 GHz region. In addition to evaluating QuinStar's own antennas, this near-field antenna measurement system is also available for testing customer's antennas. Testing can be performed by QuinStar personnel, or under special arrangement, by the customer themselves using their own signal-generating and retrieval equipment. Please contact our Sales Department for information.

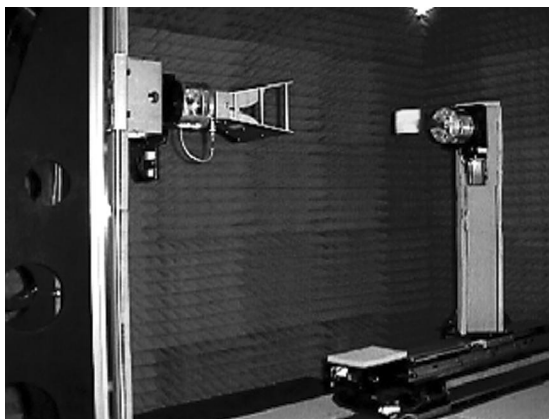

Above: A Com-Power AH-118 1-18 GHz wide-band probe (left antenna) illuminates a K-band horn Antenna Under Test (AUT, right antenna). The AUT rides on two tracks, the lower being the z-axis adjustment, while the upper track (actually a 360° horizontally-rotating boom) is used to adjust the AUT aperture directly over the vertical axis of rotation (phase center adjustment in spherical scans). Additionally, both AUT and probe can be rotated 360° along the z-axis (polarization).

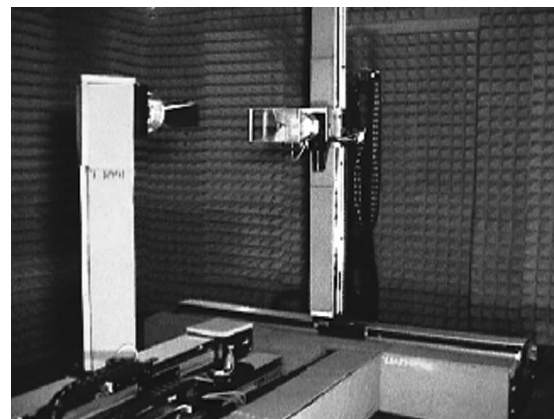

Above: The probe (right antenna) moves along the x- and y-axis and rotates 360° along the z-axis. The system can perform planar polar (pie-section), planar rectangular (raster), planar linear, spherical and cylindrical scans. All movement is under software control. Signals are generated by, and data is gathered from, a vector network analyzer.

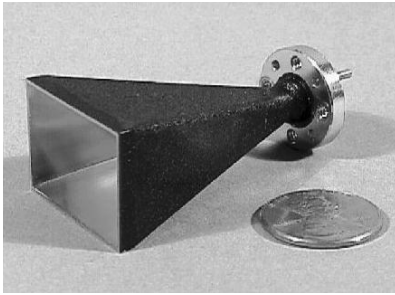

Antenna under test: 94-GHz Standard Gain Horn

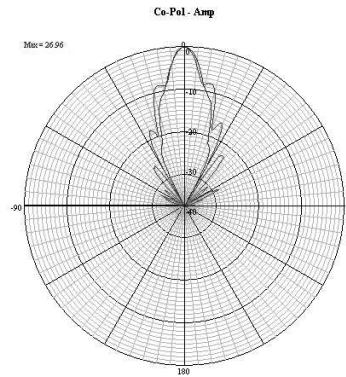

Polar far-field gain pattern

### Far-Field W-band Standard Gain Horn Patterns Generated From a Near-Field Antenna Measurement System

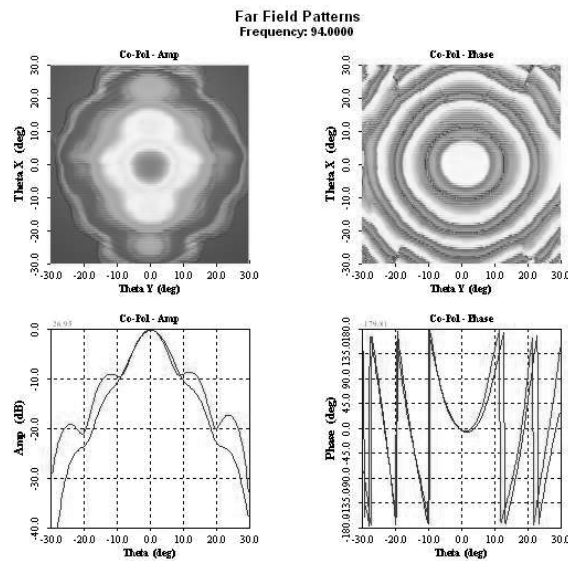

Rectangular far-field gain and phase patterns.

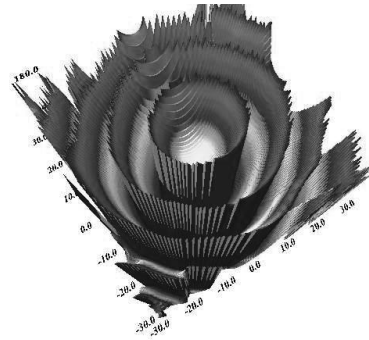
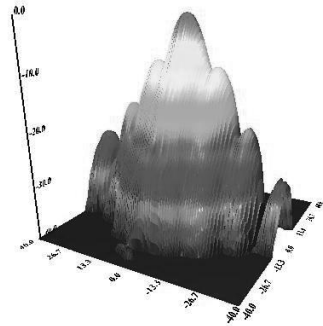

Three-dimensional representation of horn's far-field gain and phase patterns  
(The measurement system allows image rotation for viewing from any side or angle)

### Standard Far Field Measurement Antenna Range

In addition to the Near-Field Antenna range, QuinStar also has an anechoic chamber that houses a conventional antenna measurement range. This facility is equipped to operate between 12 and 170 GHz. This range includes an Az-El antenna positioner, source/receiver instrumentation and data acquisition subsystem for automated measurement of radiation patterns of most antennas.

### Design and Development Antenna Tools for Antenna Products:

QuinStar has a suite of computer simulation and design tools for the design and development of novel antenna products and subsystems.

### Antenna Measurement Services

QuinStar offers antenna measurement services to its customers contingent upon availability of the facility and the staff. Both near-field range and standard far-field anechoic chamber are made available for evaluating and characterizing antennas and optics. QuinStar can also provide the support of its technical staff for conducting the tests and measurements. Please contact QuinStar Technology's Sales Department with your specific measurement needs.



## Section 8

# Assemblies & Subsystems

Product Title	Model No.	Page Number
<b>Assemblies &amp; Subsystems</b>		181
Cryogenically Coolable Products and Capability		182
Subsystem and Assembly Experience		183
Block Diagrams and Architectures for Assemblies		185



## Cryogenically Coolable Products and Capability

QuinStar Technology offers a selection of cryogenically-coolable products and measurement services associated with them. Standard products as well as custom designed products are offered in these product areas. The following products are offered as standard products:

- Low Noise Amplifiers
- Receivers
- Isolators and Circulators
- Loads
- Passive Components and Waveguide Products

Capabilities and general information about the cryogenically coolable Low Noise Amplifiers and Receivers are presented in Section 1.

QuinStar offers a complete line of coolable coaxial ferrite products operating in the frequency range of 300 MHz to 50 GHz. Waveguide-based ferrite components, passive components, and waveguide components operating over 18-140 GHz frequency range are also available for cooled

operation (down to around 4 deg. K).

### 4-8 GHz cryogenic isolator and circulator

- Broadband performance (4 to 8 GHz)
- Low Insertion loss 0.4 dB max. @ 77 degrees Kelvin
- VSWR 1.28:1 max.
- Optional bias pin and I/O connectors
- Compact size 1"X1"X0.5"

### Measurement Services at Low Temperatures:

QuinStar has facilities and personnel to conduct extensive measurements on components and subsystems at cryogenic temperatures (4 degree to 100 deg. K). Test and evaluation services are offered for the following:

- Measurement and Characterization of Active and Passive Components
- Subsystem Evaluation and Testing

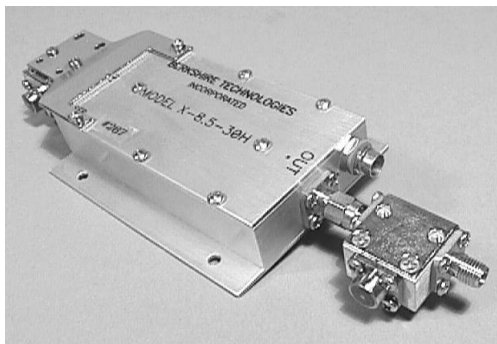

Coolable Amplifier and Isolator



## Characteristics

- ◆ Customized
- ◆ Compact
- ◆ State-of-the-Art Performance
- ◆ Quick Delivery
- ◆ Cost Effective

## Applications

- ◆ Rapid Prototyping
- ◆ Application-Specific Test Equipment
- ◆ Communication, Sensor and Receiver Systems

QuinStar Technology, Inc. specializes in producing a broad range of fully integrated and customized millimeter-wave assemblies and subsystems meeting customer-specific application requirements for digital and analog **Sensor**,

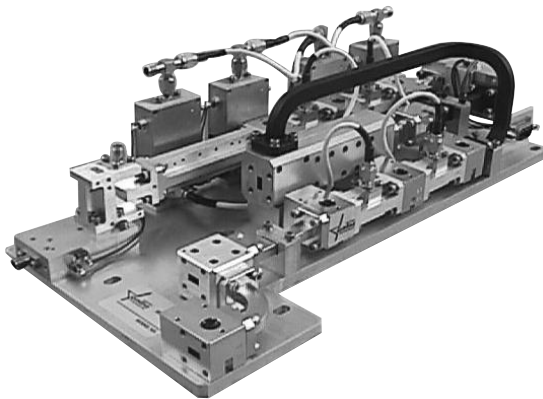

**35 GHz Linear Exciter With High Isolation and High Speed Switching Communications and Test applications.** QuinStar has designed, produced and delivered dozens of different millimeter-wave assemblies and subsystems ranging from **Miniature Transceivers and Broadband Receivers to Antenna Subsystems and Communication Front Ends.**

QuinStar's in-house oscillator, amplifier and frequency multiplier product design and manufacturing resources greatly enhance our capability to offer **State-of-the-Art** solutions



Ultra-Linear 35 GHz FMCW Transceiver Module with Integral Lens Antenna

for **Rapid Prototyping and Proof of Concept Demonstration** all the way through **Production**. The level of integration, circuit complexity, packaging and testing provided by QuinStar are all determined by the customers' precise needs, budget limitations and environmental constraints. In addition, customers are often able to select from a vast variety of existing generic millimeter-wave assemblies and subsystems that are fully developed and readily producible. This results in significant cost savings, quick delivery and avoidance of developmental risks.

QuinStar can develop and produce customized assemblies and subsystems from virtually any starting point in the customers' application development cycle and on the basis of any degree of definition or specification.

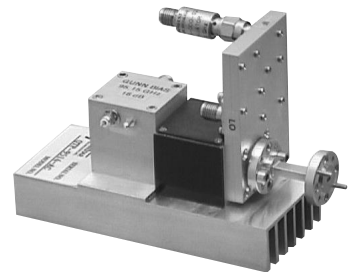

We can work from **W-Band Phase-Lockable Source Assembly** just a **Conceptual Design or Generic Description**, or convert a **Functional Block Diagram or Circuit Schematic** into a customized assembly or subsystem. We are also well positioned to economically manufacture an assembly or subsystem on a **Build to Print** basis if desired.



# Assemblies and Subsystems

Some of QuinStar's commonly produced millimeter-wave assemblies and subsystem products include:

**Sensitive Receivers:** QuinStar has developed a complete line of sensitive receiver front ends that operate over the 18-140 GHz frequency interval. These receiver front ends may be used in systems ranging from EW receivers to environmental sensors and meteorological radiometers. Low-noise amplifiers produced

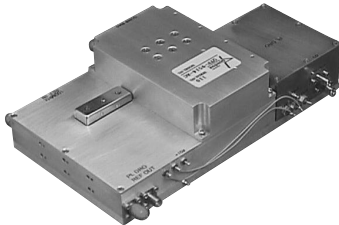

Phase-Lock Electronics

by QuinStar allow us to offer state-of-the-art performance.

**Generic Transceivers:** Front ends for radars with virtually any waveform (CW, FMCW, pulsed or various other complex modulation waveforms) have been produced to meet requirements ranging from automobile collision warning systems to plasma diagnostic instruments. QuinStar's strength in high performance transmitter components, such as amplifiers and oscillators, greatly enhances the performance of these custom products. In

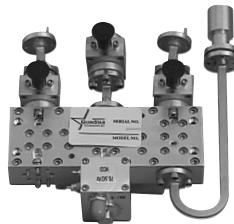

76.5 GHz 3-Channel Monopulse Transceiver

addition, our significant experience allows us to deliver a cost-effective, fully compliant assembly or subsystem well matched to the application. Antennas and other assemblies can also be integrated with these transceivers.

**Antenna-Related Subsystems:** QuinStar routinely provides complex antenna product assemblies consisting of a variety of antennas, polarizers, orthomode transducers and associated waveguide products integrated to achieve customer-specified performance.

**Special Test and Measurement Equipment:** QuinStar produces customized test and measurement equipment for special applications and/or dedicated production measurements. These include Noise/Gain Test Sets, Voltage Standard Measurement Systems and Frequency Extension Kits for Network Analyzers.

**Transmitters and Sources:** Sources especially suited for transmitters for communication equipment, sensors, seekers, plasma diagnostic instruments and test equipment are offered as customized products. These are based on QuinStar's broad active component product line. In addition, frequency agile (sweepers), synthesized and phase-locked sources are offered.

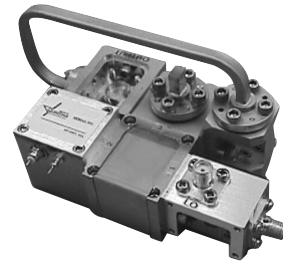

76.5 GHz FMCW Transceiver Assembly

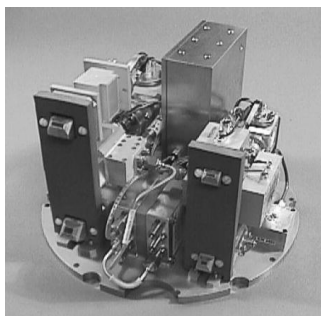

Broadband Millimeter Wave Receiver with Wide Field of View Antennas

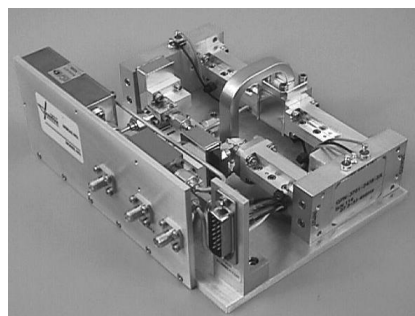

Rapid Prototype of Millimeter Wave Communication Link Front End

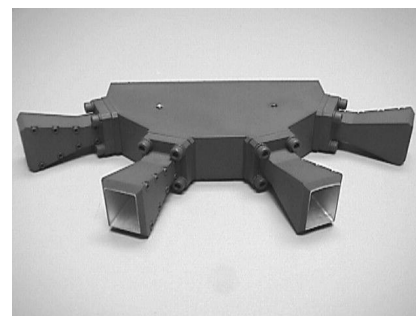

Antenna Assembly for Millimeter Wave Direction Finding Receiver

## Millimeter Wave Subsystems and Assemblies for Various Applications using QuinStar Products:

QuinStar Technology provides all critical components, interconnects and antennas to allow the customers to create virtually any millimeter wave subsystem, test and measurement configuration or application-specific assembly. Some of the most commonly used configurations or architectures are shown here. QuinStar can also develop fully integrated assemblies or subsystems in modular format to suit its customer's performance requirements and physical constraints.

### A. Millimeter Wave Communication Radios and Data Links:

**COMMUNICATION DATA LINK-ARCHITECTURE**

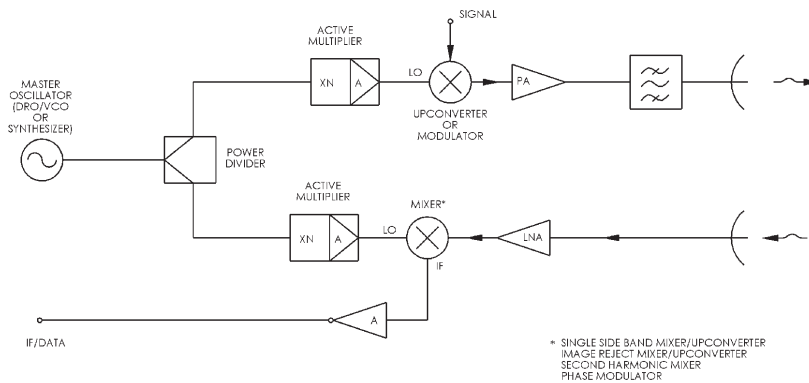

**COMMUNICATION DATA LINK-ARCHITECTURE**

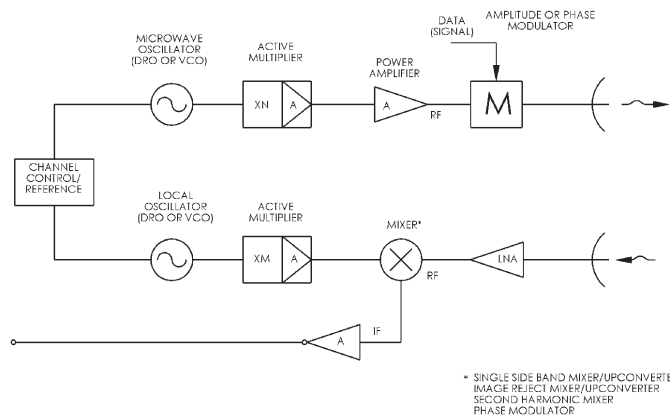

**COMMUNICATION DATA LINK-ARCHITECTURE**

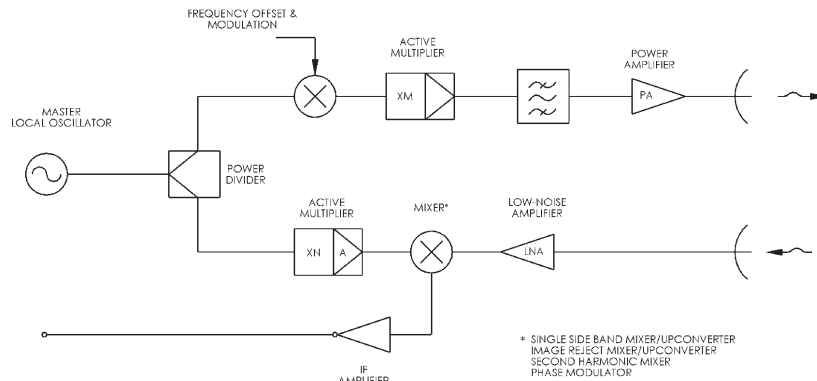

## B. Pulsed and FMCW Radar:

**DIRECT PULSE MODULATION SCHEME**

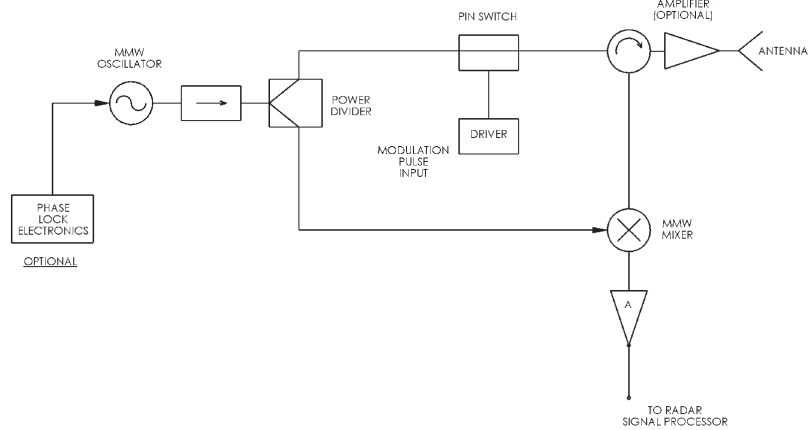

**FMCW RADAR**

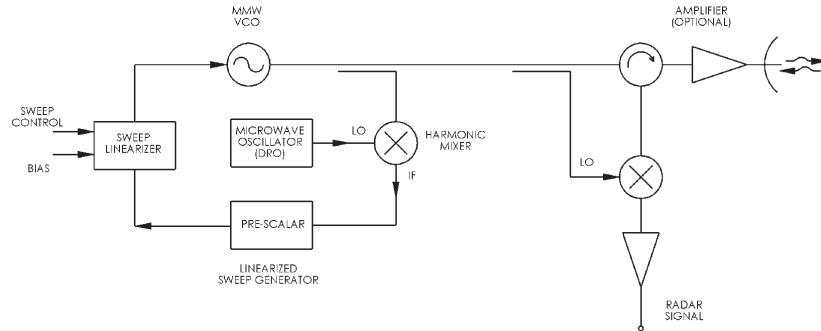

**UPCONVERTER SIGNAL SCHEME**

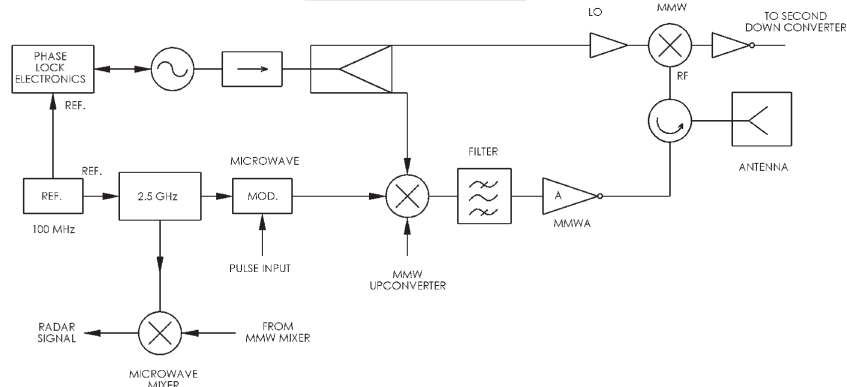

## C. Millimeter Wave Radiometer & Radiometric Receivers

### RADIOMETERS & RADIOMETRIC RECEIVERS

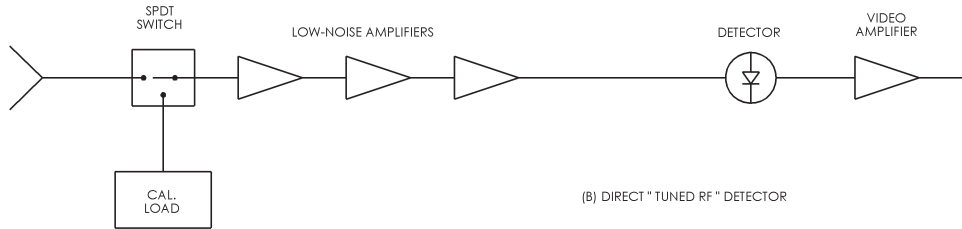
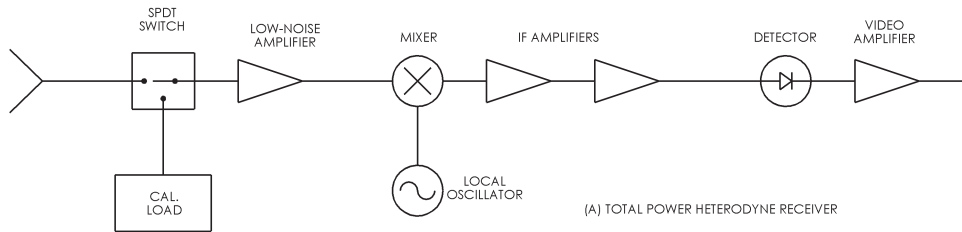

## D. Plasma Diagnostics and Material Measurement System

### PLASMA AND MATERIAL MEASUREMENT SYSTEM

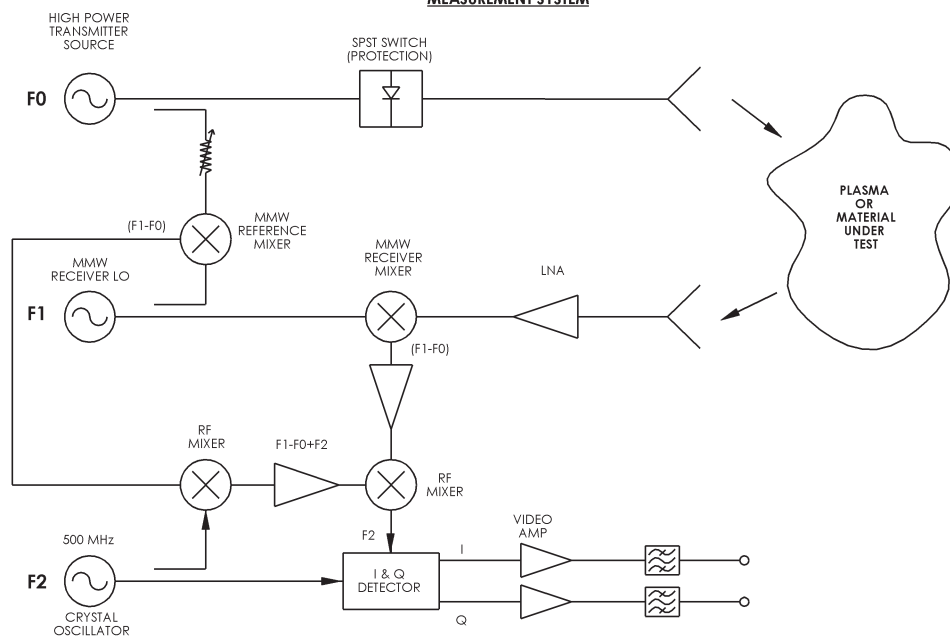

## E. Component Evaluation Test Set

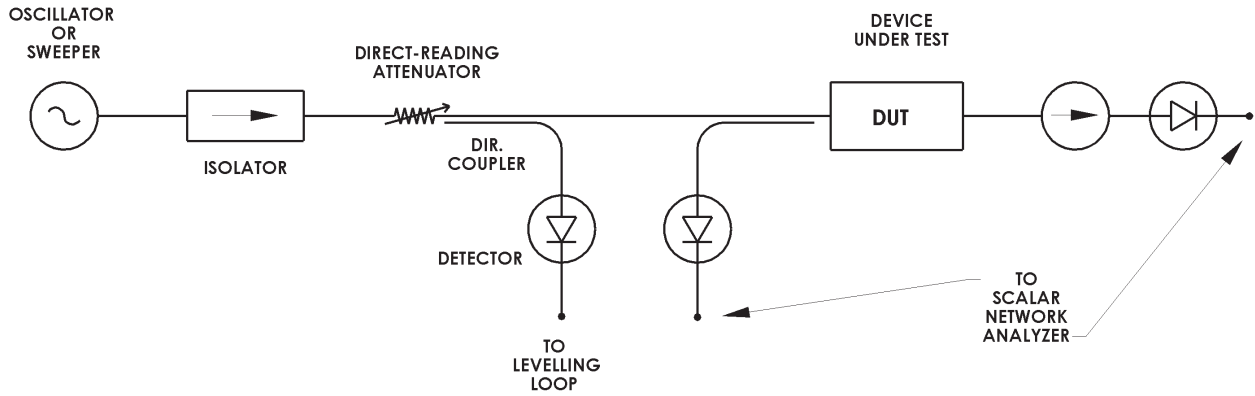

## F. Frequency-Extension Subsystem

### UPCONVERTER APPROACH

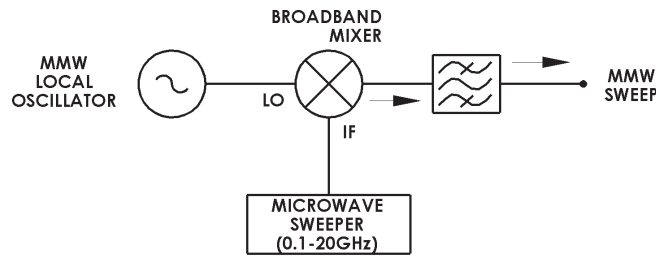

### MULTIPLIER APPROACH

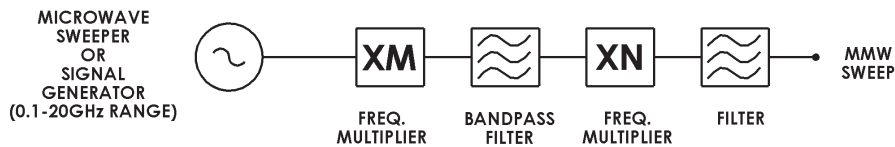



# Systems Products Capability

QuinStar produces a broad range of millimeter-wave systems and equipment for applications as diverse as **broadband communications** and **seeker front ends** to **collision warning sensors** and **radiometers**. QuinStar has the technical capabilities, facilities, design and development skills, and program management experience to execute major development and production programs and provide application-specific solutions.

- System Design, Development and Testing Experience
- Complete Receiver, Radar and Radiometer Products (Sensors)
- MMIC-Based Transceivers and Sensor Specific Antennas
- System Level Knowledge of Millimeter-Wave Applications
- Infrastructure to Support Major Programs

## Communication Products

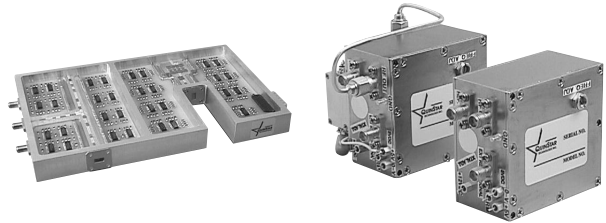

**Ka-Band Transceiver Module for Broadband Wireless Communication Front End**      **Ka-Band Phase Locked Oscillators**

- Broadband Communication Products
- Millimeter-Wave Radios
- Antennas

## Remote Sensing Products

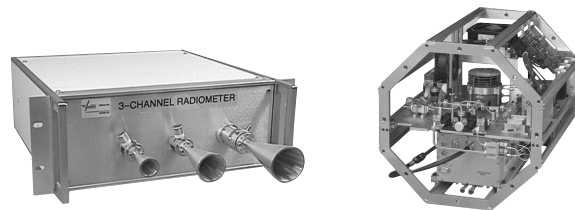

**3-Channel Radiometer Subsystem**      **W-Band Transceiver in Customer's Cloud Measurement Radar**

- Cloud Measurement Radar Front Ends
- Satellite-Based Monitoring Systems
- Molecular Spectroscopy
- Environmental Measurement Radiometers

## Sensor Products

- Automotive Collision Warning Sensors
- Traffic Monitoring Sensors
- Non-Contacting Sensors
- Instrumentation Radars
- Plasma Diagnostic Instruments
- Antenna Subsystems



**35 GHz Multichannel High Resolution Radar**

## Space-Related Products and Services

### Surveillance and EW Products

- Broadband Sensitive Receivers
- EW and Direction Finding Instruments
- Special Antenna Subsystems

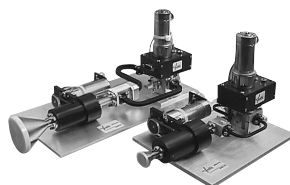

**Ka- and W-Band Multipolarization Remotely-Controlled Antenna Measurement Subsystem**

- Space-Qualified Components
- Subsystems for Space Instruments
- Spaceborne Receivers and Transmitters

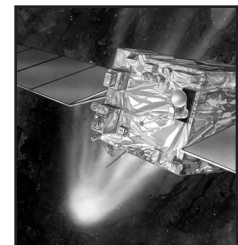

**Submillimeter-Wave Receiver LO**



## Sensor Products

QuinStar offers Millimeter-Wave Sensor System Products in the 18-140 region. A wide range of fully developed products is available with a variety of useful options and accessories.

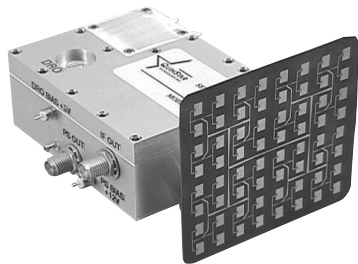

**Ultra-Linear 35 GHz FMCW Transceiver Module with Integral Printed Circuit Antenna**

These products range in complexity from specialized antennas and transceiver front ends to complete turnkey systems including pedestal-positioning software and associated peripherals. QuinStar's Sensor Products are designed and manufactured to provide a reliable, cost effective solution that meets the customers' application-specific requirements. In addition, QuinStar can provide specialized engineering, measurement and evaluation, and technical field support.

For programs with large volume production potential, QuinStar offers design capabilities, manufacturing experience and production facilities to provide a low-cost, application-specific solution. The insertion of newly developed MMICs and other novel products result in optimal millimeter-wave sensors that can satisfy virtually any requirement from accurate motion sensing and ranging to seeker front ends, cloud radars and automobile collision warning systems.

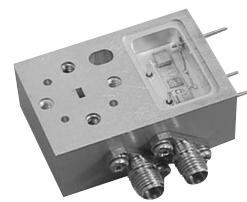

**76.5 FMCW Transceiver for Vehical Radar Application**

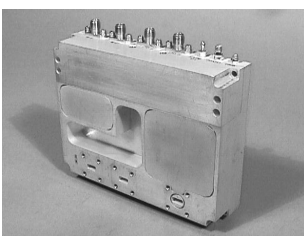
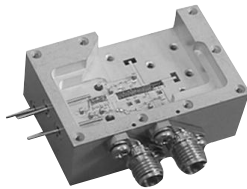

**77 GHz Automobile Radar Front End**

## Space Systems Capability

QuinStar has significant experience and capability in millimeter-wave systems for space application. Critical components and assemblies have been, and continue to be, developed by QuinStar for various receivers and radiometers for millimeter-wave sensors and chemistry measurement systems supporting multiple flight programs. These incorporate Gunn oscillators, mixers, amplifiers, phase-locked sources and associated circuits. QuinStar can supply space-qualified components as well as major microwave and millimeter-wave subsystems. We have the infrastructure and experience to conclusively demonstrate the quality and reliability aspects of these products to satisfy virtually any flight application.

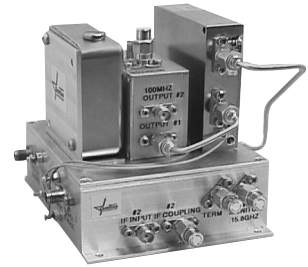

**Microwave Exciter Module for W-Band Radar**

QuinStar has an established, highly capable and dependable vendor base for electronic components, lower frequency parts and material associated with most millimeter-wave space systems. In addition, our employees have obtained the necessary training and certifications to perform on and comply with the program requirements of most Space Agencies. QuinStar's unique product development capability in combination with our facilities and experience offers low-risk and cost-competitive product solutions for Space Programs.

## Recent Experience in Space Programs

- Complete Millimeter-Wave Local Oscillators
- Components and Assemblies for Radiometric Measurement (EOS-MLS)
- Components for Environmental Sensors
- New Generation of Radiometers for Space-Based Instruments (JASON II)
- High Frequency Sources for Space Programs (MIRO)

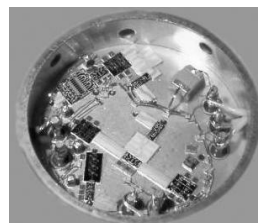

**Integrated MMW Radar Sensor Front End**



# Section 9

# Appendices & Technical Reference Manual

Product Title	Model No.	Page Number
<b>Appendices &amp; Technical Reference Material</b>		191
A- Rectangular Waveguide		192
B- Waveguide and Flange Dimensions (Round Flanges)		193
C- Blank Round Flange Dimensions		194
D- Waveguide and Flange Dimensions (pin-contact, threaded ring)		195
E- Blank Flange Dimensions (pin-contact, threaded ring)		195
F- WR-62 (Ku-band) Flange Blank and Waveguide Dimensions		196
G- Waveguide and Flange Dimensions (choke Flange)		196
H- Square Flange Waveguide Dimensions		197
I- Flange Blanks (Square)		197
J- Circular Waveguide Sizes		198
K- Circular Waveguide Sizes (Alternative Set)		199
L- VSWR, Return Loss, Reflection Coefficient Conversion Table Noise Figure to Noise Temperature Conversion Table		200
M- Conversion of microwatt, milliwatt and Watt to dBm		201
N- Effect of VSWR on Transmitted Power and Return Loss		202
Millimeter Products, Inc (MPI) Cross Reference		203
Reference Information		206
QuinStar Warranty Policy		208



**Appendix A**  
**Rectangular Waveguide**

Waveguide Band	Designation	Dimensions (inch)	Frequency (GHz)	Cut-off (GHz)	Theoretical Attenuation Lowest to Highest Frequency (dB/ft)	Historic Designation	New MIL Part Number
Ku	RG-91/U	0.622 x 0.311	12.4-18.0	9.486	.064 - .030	UG-419/U	M3922/53-4/005
	WR-62					UG-541/U	M3922/59-2/001
K	RG-53/U	0.420 x 0.170	18.0-26.5	14.047	.17-.11	UG-595/U	M3922/54-4/001
	WR-42					UG-596A/U	M3922/59-2/003
A	RG-96/U	0.280 x 0.140	26.5-40.0	21.081	0.22-0.15	UG-425/U	M3922/67-2/004
						UG-599/U	M3922/54-4/003
	WR-28	UG-600/U	M3922/59-2/005				
B	RG-97/U	0.224 x 0.112	33.0-50.0	26.342	0.31-0.21	UG-381/U	M3922/67-2/005
						UG-383/U	M3922/53-4/005
	WR-22	MPI-719	M3922/59-2/001				
U	WR-19	0.188 x 0.094	40.0-60.0	31.357	0.39-0.27	MPI-719T	
						UG-383/U-M	M3922/53-4/005
						MPI-710	M3922/59-2/001
V	RG-98/U	0.148 x 0.074	50.0-75.0	39.863	0.57-0.39	MPI-720T	
	WR-15					UG-385/U	M3922/67-2/008
E	RG-99/U	0.122 x 0.061	60.0-90.0	48.350	0.78-0.53	UG-387/U	M3922/67-2/009
W	WR-10	0.100 x 0.050	75.0-110.0	59.010	1.02-0.71	UG-387/U-M	M3922/67-2/010
F	RG-138/U	0.080 x 0.040	90.0-140.0	73.764	1.52-0.98	MPI-714	M3922/74-001
	WR-8					UG-387/U-M	N/A
D	RG-136/U	0.065 x 0.0325	110.0-170.0	90.786	2.12-1.35	MPI-716	M3922/74-002
	WR-6					UG-387/U-M	N/A
G	RG-135/U	0.051 x 0.0255	140.0-220.0	115.71	3.05-1.93	MPI-715	M3922/74-003
	WR-5					UG-387/U-M	N/A

Modified (-M) means waveguide opening has been reduced appropriately. Screw and pin pattern are unchanged.

## Appendix B Waveguide and Flange Dimensions (Round Flanges)

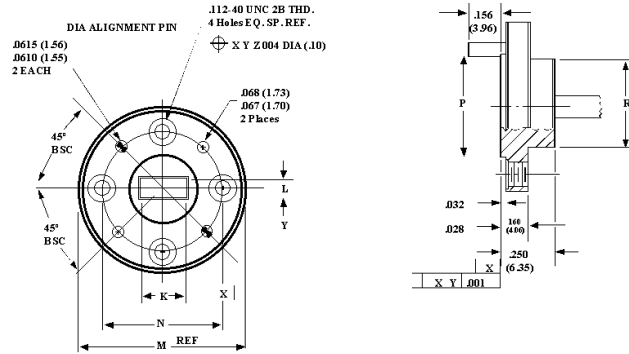

Waveguide Band	Frequency Band Band (GHz)	MIL Part Number M3922/67	EIA Waveguide Designation	Flange Designation	K ± .0015 (.04)	L ± .0015 (.04)	M ± .000/.002 (.05)	N BSC± .005	P ± .005 (.13)	R ± .005 (.13)
K	18.0 26.5	-004	WR-42	UG-425/U	.4200 (10.67)	.1700 (4.32)	1.125 (28.58)	.9375 (23.81)	.625 (15.88)	.625 (15.88)
Ka	26.5 40.0	-005	WR-28	UG-381/U	.2800 (7.11)	.1400 (3.56)	1.125 (28.58)	.9375 (23.81)	.500 (12.70)	.468 (11.89)
Q	33.0 50.0	-006	WR-22	UG-383/U	.2240 (5.69)	.1120 (2.84)	1.125 (28.58)	.9375 (23.81)	.500 (12.70)	.468 (11.89)
U	40.0 60.0	-007	WR-19	UG-383/U-M	.1880 (4.78)	.0940 (2.39)	1.125 (28.58)	.9375 (23.81)	.500 (12.70)	.468 (11.89)
V	50.0 75.0	-008	WR-15	UG-385/U	.1480 (3.76)	.0740 (1.88)	.750 (19.05)	.5625 (14.29)	.375 (9.53)	.312 (7.92)
E	60.0 90.0	-009	WR-12	UG-387/U	.1220 (3.10)	.0610 (1.55)	.750 (19.05)	.5625 (14.29)	.375 (9.53)	.312 (7.92)
W	75.0 110.0	-010	WR-10	UG-387/U-M	.1000 (2.54)	.0500 (1.27)	.750 (19.05)	.5625 (14.29)	.375 (9.53)	.312 (7.92)
F	90.0 140.0	N/A	WR-8	UG-387/U-M	.0800 (2.03)	.0400 (1.02)	.750 (19.05)	.5625 (14.29)	.375 (9.53)	.312 (7.92)
D	110.0 170.0	N/A	WR-6	UG-387/U-M	.0650 (1.65)	.0325 (.83)	.750 (19.05)	.5625 (14.29)	.375 (9.53)	.312 (7.92)
G	140.0 220.0	N/A	WR-5	UG-387/U-M	.0510 (1.30)	.0255 (.65)	.750 (19.05)	.5625 (14.29)	.375 (9.53)	.312 (7.92)

## Appendix C Blank Round Flange Dimensions

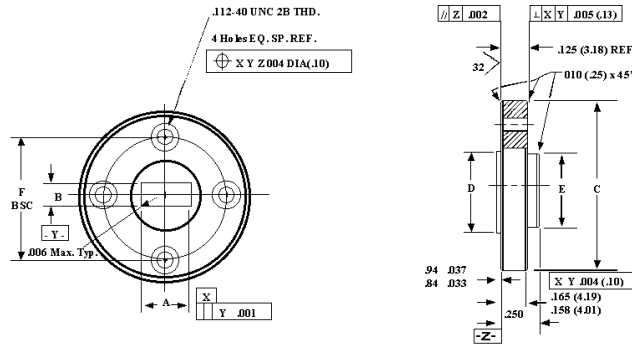

Band	Frequency Band (GHz)	MIL Part Number M3922/67	A ±.002/-0.000 (.05)	B ±.002/-0.000 (.05)	C ±.000/-0.002 (.05)	D ± .005 (.13)	E ± .005 (.13)	F BSC	Flange Designation
K	18.0 26.5	-004	.502 (12.75)	.252 (6.40)	1.125 (28.58)	.625 (15.88)	.625 (15.88)	.312 (7.92)	UC-425/U
Ka	26.5 40.0	-005	.362 (9.19)	.222 (5.64)	1.125 (28.58)	.500 (12.70)	.468 (11.89)	.9375 (23.81)	UC-381/U
Q	33.0 50.0	-006	.306 (7.77)	.194 (4.93)	1.125 (28.58)	.500 (12.70)	.468 (11.89)	.9375 (23.81)	UC-383/U
U	40.0 60.0	-007	.270 (6.86)	.167 (4.47)	1.125 (28.58)	.500 (12.70)	.468 (11.89)	.5625 (14.29)	UC-383/U-M
V	50.0 75.0	-008	.230 (5.84)	.156 (3.96)	.750 (19.05)	.375 (9.53)	.312 (7.92)	.5625 (14.29)	UC-385/U
E	60.0 90.0	-009	.204 (5.18)	.143 (3.63)	.750 (19.05)	.375 (9.53)	.312 (7.92)	.5625 (14.29)	UC-387/U
W	75.0 110.0	-010	.182 (4.62)	.132 (3.35)	.750 (19.05)	.375 (9.53)	.312 (7.92)	.5625 (14.29)	UC-387/U-M
F	90.0 140.0	N/A	.141 (3.58)	.101 (2.56)	.750 (19.05)	.375 (9.53)	.312 (7.92)	.5625 (14.29)	UC-387/U-M
D	110.0 170.0	N/A	.126 (3.20)	.094 (2.39)	.750 (19.05)	.375 (9.53)	.312 (7.92)	.5625 (14.29)	UC/387/U-M
C	140.0 220.0	N/A	.112 (2.84)	.089 (2.21)	.750 (19.05)	.375 (9.53)	.312 (7.92)	.9375 (23.81)	UC-387/U-M

## Appendix D Waveguide and Flange Dimensions (pin-contact, threaded ring)

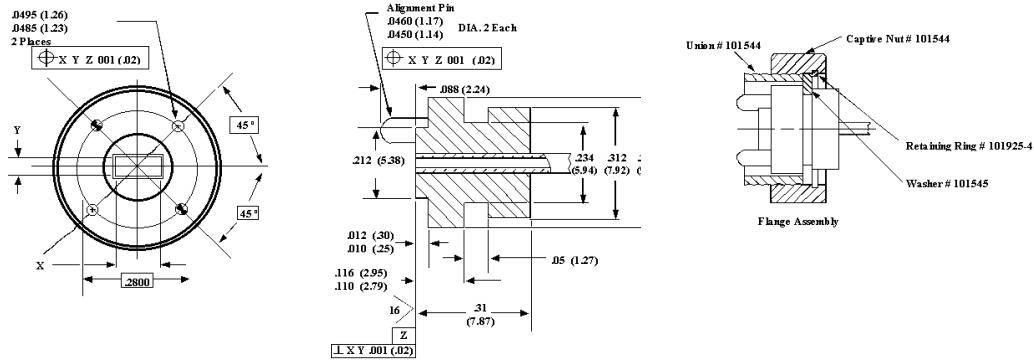

Band	Frequency Band (GHz)	MIL Part Number M3922/74	C inch (mm)	D inch (mm)	EIA Waveguide Designation
F	90.0-140.0	-001	.0800-(2.03)	.0400-(1.02)	WR8
D	110.0-170.0	-002	.0650-(1.63)	.0325-(.83)	WR7
G	140.0-220.0	-003	.0510-(1.30)	.0255-(.65)	WR5
H	180-260.50	-004	.430-(1.09)	.0215-(.55)	WR4
J	220.0-325.0	-005	.0340-(.86)	.0170-(.43)	WR3

## Appendix E Blank Flange Dimensions (pin-contact, threaded ring)

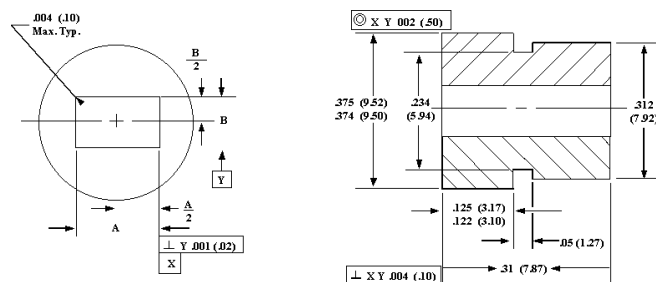

Band	Frequency Band (GHz)	A inch (mm)	B inch (mm)	EIA Waveguide Designation
F	90.0-140.0	.143-(3.63)	.103-(2.62)	WR8
D	110.0-170.0	.128-(3.25)	.098-(2.49)	WR7
G	140.0-220.0	.115-(2.92)	.089-(2.26)	WR5
H	170.0-260.5	.430-(1.09)	.0845-(2.15)	WR4
J	220.0-325.0	.106-(2.69)	.080-(2.03)	WR3

## Appendix F WR-62 (Ku-band) Flange Blank and Waveguide Dimensions

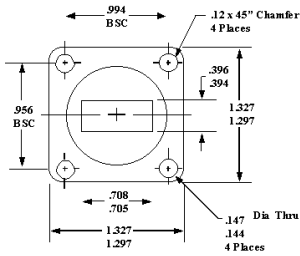

Flange Blank

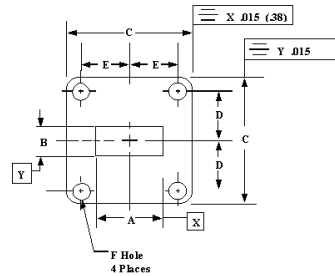
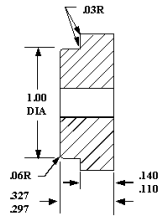

Finished Waveguide & Flange

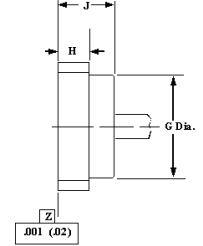

Band mm(mm)	Frequency Band (GHz) (.38)	MIL Part Number M3922/53	A inch (15.8) (.05)	B inch (.79) (.05)	C .015 (.38)	D BSC (12.14)	E BSC (12.62)	F ±.003 (3.66)	G ±.015 (25.40)	H ±.015 (3.18)	J ±.015 (7.95)	Flange Bank
Ku	12.4- 18.0	-4/005	.622 ± .002 (15.8) (.05)	.311 ± .002 (.79) (.05)	1.312 (33.32)	4.78 (12.14)	.497 (12.62)	.144 (3.66)	1.000 (25.40)	.125 (3.18)	.313 (7.95)	UC-419/U

All dimensions in inch (mm)

## Appendix G Waveguide and Flange Dimensions (Choke Flange)

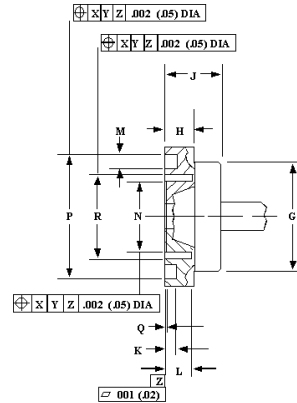
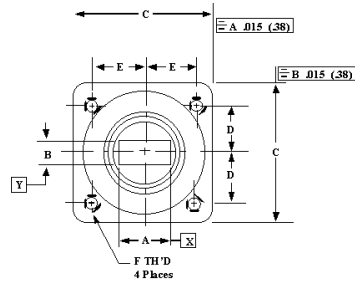

Band	Frequency Band (GHz)	MIL Part Number M3922/59	Flange Desig.	A	B	C .015 (.38)	D BSC	E BSC	F	G ±.015 (.38)	H ±.015 (.38)	J ±.015 (.38)	K ±.002 (.05)	L ±.002 (.05)	M ±.002 (.05)	N ±.002 (.05)	P ±.002 (.05)	Q ±.001 (.03)	R ±.002 (.05)
Ku	12.4 18.0	-2/001	UC541	.622±.002 (15.8)(.05)	.311±.002 (7.9)(0.05)	1.312 (33.32)	.478 (12.14)	.497 (12.62)	.138-32 UNC-2B	1.000 (25.40)	.188 (4.78)	.375 (9.53)	.113 (2.87)	.190 (4.83)	1.58 (4.01)	.710 (18.03)	1.208 (30.68)	.0075 (.19)	.828 (21.03)
K	18.0 26.5	-2/003	UC596	.420±.002 (10.67)(.05)	-.170±.002 (4.32)(.05)	.875 (22.23)	.335 (8.51)	.320 (8.13)	.112-40 UNC-2B	.625 (15.88)	.156 (3.96)	.285 (7.24)	0.42 (1.07)	.129 (3.28)	0.87 (2.21)	.472 (11.99)	.761 (19.33)	.005 (.13)	.536 (13.61)
Ka	26.5 40.0	-2/005	UG600	.280±.0014 (7.11)(.04)	.140±.0014 (3.56)(.04)	.750 (19.05)	.265 (6.73)	.250 (6.35)	.112-40 UNC-2B	.500 (12.70)	.109 (2.77)	.210 (5.33)	.050 (1.27)	.086 (2.18)	.096 (2.44)	.321 (8.15)	.596 (15.14)	.003 (.08)	.372 (9.45)

All dimensions in inch (mm)

## Appendix H Square Flange and Waveguide Dimensions

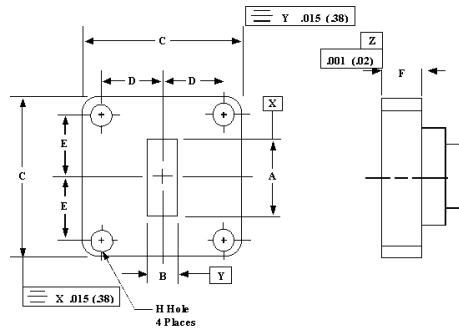

Band	Frequency Band (GHz)	MIL Part Number M3922/54-4	A ±.0015 (.04)	B ±.0015 (.04)	C	D BSC	E BSC	F	H	Flange
K	18.0 26.5	-001	.4200 (10.67)	.1700 (4.32)	.875±.015 (22.22)(.38)	.335 (8.51)	.320 (8.13)	.156±.015 (3.96)(.38)	.116±.002 (2.95)(.05)	UG-595/U
Ka	26.5 40.0	-003	.2800 (7.11)	.1400 (3.56)	.750±.005 (19.05)(1.3)	.265 (6.75)	.250 (6.35)	.109±.00 (2.77)(.38)	.116±.002 (2.95)(.05)	UG-599/U
Q	33.0 50.0	N/A	.2240 (5.69)	.1120 (2.84)	.750±.005 (19.05)(1.3)	.265 (6.75)	.250 (6.35)	.156±.005 (3.96)(.38)	.116±.002 (2.95)(.05)	(UG-599/UM)
Q	33.0 50.0	N/A	.2240 (5.69)	.1120 (2.84)	.750±.005 (19.05)(1.3)	.265 (6.75)	.250 (6.35)	.156±.005 (3.96)(.38)	.112-40 UNC-2B	
U	40.0 60.0	N/A	.1880 (4.78)	.0940 (2.39)	.750±.005 (19.05)(1.3)	.265 (6.75)	.250 (6.35)	.187±.005 (4.75)(.38)	.116±.002 (2.95)(.05)	
U	40.0 60.0	N/A	.1880 (4.78)	.0940 (2.39)	.750±.005 (19.05)(1.3)	.265 (6.75)	.250 (6.35)	.187±.005 (4.75)(.38)	.112-40 UNC-2B	

All dimensions in inch (mm)

## Appendix I Flange Blanks

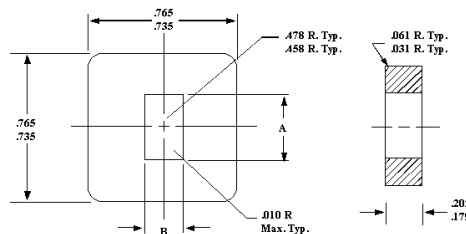

Flange Designation	A	B	C	D BSC	E BSC
UG 599A	.364 .362	.224 .222	.755 .745	.530	.500
UG 595K	.505 .503	.255 .253	.890 .860	.670	.640

## Appendix J Circular Waveguide Sizes

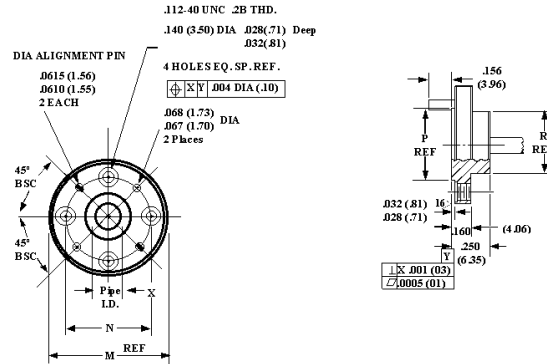

Band	Internal Diameter (inch)	Frequency Band
Ku-1	.660	12.4 - 14.6
Ku-2	.550	14.6 - 17.5
K-1	.470	17.5 - 20.5
K-2	.396	20.5 - 24.5
K-3	.328	24.5 - 26.5
A-0	.328	26 - 28.5
A-1	.281	28.5 - 33
A-2	.250	33 - 38.5
A-3	.219	38.5 - 43
B-0	.250	33 - 38.5
B-1	.219	38.5 - 43
B-2	.188	43 - 50
U-0	.219	38.5 - 43
U-1	.188	43 - 50
U-2	.165	50 - 58
V-0	.165	50 - 58
V-1	.141	58 - 68
V-2	.125	68 - 77
E-0	.141	58 - 68
E-1	.125	68 - 77
E-2	.110	77 - 87
E-3	.094	87 - 100
W-0	.110	77 - 87
W-1	.094	87 - 100
W-2	.082	100 - 112
F-0	.094	87 - 100
F-1	.082	100 - 112
F-2	.075	112 - 125
F-3	.067	125 - 140
D-0	.082	100 - 112
D-1	.075	112 - 125
D-2	.067	125 - 140
D-3	.059	140 - 160
G-0	.067	125 - 140
G-1	.059	140 - 220

Band	M +.000/.002 (.05)	N BSC	P +.005 (.13)	R +.005 (.13)	Flange Designation
Ku	1.44 (36.58)	1.250 (28.6)	.967 (24.6)	.967 (24.6)	
K	1.125 (28.58)	.9375 (23.8)	.625 (15.88)	.625 (15.88)	UG-425/U
Ka	1.125 (28.58)	.9375 (23.81)	.500 (12.70)	.468 (11.89)	UG-381/U
Q	1.125 (28.58)	.9375 (23.81)	.500 (12.70)	.468 (11.89)	UG-383/U
U	1.125 (28.58)	.9375 (23.81)	.500 (12.70)	.468 (11.89)	UG-385/U-M
V	.750 (19.05)	.5625 (14.29)	.375 (9.53)	.312 (7.92)	UG-387/U
E	.750 (19.50)	.5625 (14.29)	.375 (9.53)	.312 (7.92)	UG-387/U-M
W	.750 (19.50)	.5625 (14.29)	.375 (9.53)	.312 (7.92)	UG-387/U-M
F	.750 (19.50)	.5625 (14.29)	.375 (9.53)	.312 (7.92)	UG-387/U-M
D	.750 (19.50)	.5625 (14.29)	.375 (9.53)	.312 (7.92)	UG-387/U-M
G	.750 (19.50)	.5625 (14.29)	.375 (9.53)	.312 (7.92)	UG-387/U-M

All dimensions in inch (mm)



**Appendix K**  
**Circular Waveguide Sizes (Alternative Set)**

Frequency Band	Frequency Range, GHz		Circular Waveguide Diameter, Inches(mm)
K	LOW	17-22	0.500(12.7)
	MID	21-27	0.396(10.1)
	HIGH	25-33	0.328(8.3)
Ka	LOW	25-33	0.328(8.3)
	HIGH	33-44	0.250(6.4)
Q	LOW	33-44	0.250(6.4)
	MID	38-50	0.219(5.6)
	HIGH	43-58	0.188(4.8)
U	LOW	38-50	0.219(5.6)
	MID	43-58	0.188(4.8)
	HIGH	58-77	0.141(3.6)
V	LOW	43-58	0.188(4.8)
	HIGH	58-77	0.141(3.6)
E	LOW	58-77	0.141(3.6)
	HIGH	75-100	0.109(2.8)
W	LOW	75-100	0.109(2.8)
	HIGH	88-116	0.094(2.4)
F	LOW	88-116	0.094(2.4)
	HIGH	110-146	0.075(1.9)
D	LOW	110-146	0.075(1.9)
	HIGH	140-185	0.059(1.5)
G	LOW	140-185	0.059(1.5)
	HIGH	183-240	0.046(1.2)



Appendix L

VSWR, Return Loss, Reflection Coefficient Conversion Table

Noise Figure to Noise Temperature Conversion Table

VSWR (xxx:1)	Return Loss (dB)	Reflection Coefficient
1.00	Infinity	0.000
1.01	46.06	0.005
1.02	40.09	0.010
1.03	36.61	0.015
1.04	34.15	0.020
1.05	32.26	0.024
1.06	30.71	0.029
1.07	29.42	0.034
1.08	28.30	0.038
1.09	27.32	0.043
1.10	26.44	0.048
1.20	20.83	0.091
1.30	17.69	0.130
1.40	15.56	0.167
1.50	13.98	0.200
1.60	12.74	0.231
1.70	11.73	0.259
1.80	10.88	0.286
1.90	10.16	0.310
2.00	9.54	0.333
2.50	7.36	0.429
3.00	6.02	0.500
3.50	5.11	0.556
4.00	4.44	0.600
4.50	3.93	0.636
5.00	3.52	0.667
6.00	2.92	0.714
8.00	2.18	0.778
10.00	1.74	0.818
100.00	0.17	0.980
Infinity	0.00	1.000

Noise Figure (dB)	Noise Temperature (K)
1.00	76
1.20	94
1.40	112
1.60	131
1.80	152
2.00	173
2.20	195
2.40	218
2.60	242
2.80	267
3.00	294
3.20	321
3.40	350
3.60	381
3.80	413
4.00	446
4.20	481
4.40	517
4.60	556
4.80	596
5.00	638
5.20	682
5.40	728
5.60	776
5.80	827
6.00	879
6.20	935
6.40	993
6.60	1053
6.80	1117
7.00	1184
7.20	1253
7.40	1326
7.60	1403
7.80	1483
8.00	1566
8.20	1654
8.40	1746
8.60	1842
8.80	1943
9.00	2048
9.20	2159
9.40	2274
9.60	2395
9.80	2522
10.00	2655



Appendix M

Conversion of uW, mW and W to dBm

Microwatt	
uW	dBm
1	-30.0
2	-27.0
3	-25.2
4	-24.0
5	-23.0
6	-22.2
7	-21.5
8	-21.0
9	-20.5
10	-20.0
20	-17.0
30	-15.2
40	-14.0
50	-13.0
60	-12.2
70	-11.5
80	-11.0
90	-10.5
100	-10.0
200	-7.0
300	-5.2
400	-4.0
500	-3.0
600	-2.2
700	-1.5
800	-1.0
900	-0.5
1000	0.0

Milliwatt	
mW	dBm
1	0.0
2	3.0
3	4.8
4	6.0
5	7.0
6	7.8
7	8.5
8	9.0
9	9.5
10	10.0
20	13.0
30	14.8
40	16.0
50	17.0
60	17.8
70	18.5
80	19.0
90	19.5
100	20.0
200	23.0
300	24.8
400	26.0
500	27.0
600	27.8
700	28.5
800	29.0
900	29.5
1000	30.0

Watt	
W	dBm
1	30.0
2	33.0
3	34.8
4	36.0
5	37.0
6	37.8
7	38.5
8	39.0
9	39.5
10	40.0
20	43.0
30	44.8
40	46.0
50	47.0
60	47.8
70	48.5
80	49.0
90	49.5
100	50.0
200	53.0
300	54.8
400	56.0
500	57.0
600	57.8
700	58.5
800	59.0
900	59.5
1000	60.0



**Appendix N**  
**Effect of VSWR on Transmitted Power and Return Loss**

VSWR	VSWR, dB	Return Loss, dB	Transmission Loss, dB	Power Transmission, %	Power Reflection, %	VSWR	VSWR, dB	Return Loss, dB	Transmission Loss, dB	Power Transmission, %	Power Reflection, %
1	0.0		0.000	100.0	0.0	1.52	3.6	13.7	0.189	95.7	4.3
1.01	0.1	46.1	0.000	100.0	0.0	1.54	3.8	13.4	0.201	95.5	4.5
1.02	0.2	40.1	0.000	100.0	0.0	1.56	3.9	13.2	0.213	95.2	4.8
1.03	0.3	36.6	0.001	100.0	0.0	1.58	4.0	13.0	0.225	94.9	5.1
1.04	0.3	34.2	0.002	100.0	0.0	1.6	4.1	12.7	0.238	94.7	5.3
1.05	0.4	32.3	0.003	99.9	0.1	1.62	4.2	12.5	0.250	94.4	5.6
1.06	0.5	30.7	0.004	99.9	0.1	1.64	4.3	12.3	0.263	94.1	5.9
1.07	0.6	29.4	0.005	99.9	0.1	1.66	4.4	12.1	0.276	93.8	6.2
1.08	0.7	28.3	0.006	99.9	0.1	1.68	4.5	11.9	0.289	93.6	6.4
1.09	0.7	27.3	0.008	99.8	0.2	1.7	4.6	11.7	0.302	93.3	6.7
1.1	0.8	26.4	0.010	99.8	0.2	1.72	4.7	11.5	0.315	93.0	7.0
1.11	0.9	25.7	0.012	99.7	0.3	1.74	4.8	11.4	0.329	92.7	7.3
1.12	1.0	24.9	0.014	99.7	0.3	1.76	4.9	11.2	0.342	92.4	7.6
1.13	1.1	24.3	0.016	99.6	0.4	1.78	5.0	11.0	0.356	92.1	7.9
1.14	1.1	23.7	0.019	99.6	0.4	1.8	5.1	10.9	0.370	91.8	8.2
1.15	1.2	23.1	0.021	99.5	0.5	1.82	5.2	10.7	0.384	91.5	8.5
1.16	1.3	22.6	0.024	99.5	0.5	1.84	5.3	10.6	0.398	91.3	8.7
1.17	1.4	22.1	0.027	99.4	0.6	1.86	5.4	10.4	0.412	91.0	9.0
1.18	1.4	21.7	0.030	99.3	0.7	1.88	5.5	10.3	0.426	90.7	9.3
1.19	1.5	21.2	0.033	99.2	0.8	1.9	5.6	10.2	0.440	90.4	9.6
1.2	1.6	20.8	0.036	99.2	0.8	1.92	5.7	10.0	0.454	90.1	9.9
1.21	1.7	20.4	0.039	99.1	0.9	1.94	5.8	9.9	0.468	89.8	10.2
1.22	1.7	20.1	0.043	99.0	1.0	1.96	5.8	9.8	0.483	89.5	10.5
1.23	1.8	19.7	0.046	98.9	1.1	1.98	5.9	9.7	0.497	89.2	10.8
1.24	1.9	19.4	0.050	98.9	1.1	2	6.0	9.5	0.512	88.9	11.1
1.25	1.9	19.1	0.054	98.8	1.2	2.5	8.0	7.4	0.881	81.6	18.4
1.26	2.0	18.8	0.058	98.7	1.3	3	9.5	6.0	1.249	75.0	25.0
1.27	2.1	18.5	0.062	98.6	1.4	3.5	10.9	5.1	1.603	69.1	30.9
1.28	2.1	18.2	0.066	98.5	1.5	4	12.0	4.4	1.938	64.0	36.0
1.29	2.2	17.9	0.070	98.4	1.6	4.5	13.1	3.9	2.255	59.5	40.5
1.3	2.3	17.7	0.075	98.3	1.7	5	14.0	3.5	2.553	55.6	44.4
1.32	2.4	17.2	0.083	98.1	1.9	5.5	14.8	3.2	2.834	52.1	47.9
1.34	2.5	16.8	0.093	97.9	2.1	6	15.6	2.9	3.100	49.0	51.0
1.36	2.7	16.3	0.102	97.7	2.3	6.5	16.3	2.7	3.351	46.2	53.8
1.38	2.8	15.9	0.112	97.5	2.5	7	16.9	2.5	3.590	43.8	56.3
1.4	2.9	15.6	0.122	97.2	2.8	7.5	17.5	2.3	3.817	41.5	58.5
1.42	3.0	15.2	0.133	97.0	3.0	8	18.1	2.2	4.033	39.5	60.5
1.44	3.2	14.9	0.144	96.7	3.3	8.5	18.6	2.1	4.240	37.7	62.3
1.46	3.3	14.6	0.155	96.5	3.5	9	19.1	1.9	4.437	36.0	64.0
1.48	3.4	14.3	0.166	96.3	3.7	9.5	19.6	1.8	4.626	34.5	65.5
1.5	3.5	14.0	0.177	96.0	4.0	10	20.0	1.7	4.807	33.1	66.9



# Millimeter Products, Inc. Cross Reference

MPI Model Number	Description	QuinStar Model Number	Page No.
115	Full Band Faraday Isolator	QIF	84, 86
172	Gen Purpose Junction Isolator	QJI/QJE	82
173	Gen Purpose Junction Circulator	QJY/QJF	82
178	Precision Junction Isolator	QJI	82
179	Precision Junction Circulator	QJY	82
222	Cassegrain Ant. Lgtwt.	QRC	162
223	Cassegrain Ant. Fbrgls.	QRC	162
258	Horn Lens Antenna	QLA	160
261	Standard Gain Horn	QWH	152
262	Conical Horn Antennas	QWH, QRR	155
263	Wide Angle Scalar Feed Horn	QSW	157
264	Sectorial Horn Antenna	QSF	158
268	Scalar Feed Horn	QSH	157
281	Orthomode Transducer	QWO	164
282	Fixed Circular Polarizer	QWL	166
283	Switchable Polarizer	QWQ	166
284	Tapered Mode Transition	QWC	168
330	Mode Transition TE01 to TE10	QMT	169
340	Mode Filter TE01	QMF	171
355	TE01 Rotary Joints	QRJ	177
365	Termination TE01	QTC	174
370	Flanged Circular W/G	QCL-F	175
371	Unflanged Circular W/G	QCL-U	175
380	TE01 Circular W/G Flange	QCF	175
410	W/G to Coax Adapters	QWA	130
450	High Pass Filter	QFH	115
460	Band Pass Filter	QFB	113
510	Direct Reading Attenuator	QAD	139
511	Programmable Rotary Attenuator	QPA	142
520	Dial Driven Uncalibrated Atten.	QDA	137
521	Fixed Attenuator	QAF	135
522	Dial Driven Calibrated Attenuator	QDA	137
523	Micrometer Type Level Set Atten.	QAL	133
525	Dial Driven Uncalibrated Phase Shifter	QDP	137
526	Dial Driven Calibrated Phase Shifter	QDP	137
527	Micrometer Type Phase Shifter	QAS	135



# Millimeter Products, Inc. Cross Reference

MPI Model Number	Description	QuinStar Model Number	Page No.
528/	Direct Reading Phase Shifter	QPS	139
529	Motorized Phase Shifter	QPA	144
530	Manual W/G Switches	QWM	132
535	Electromech. W/G Switches	QWZ	133
551	Direct Reading Freq Meter	QEF	139
555	Bi-directional W/G Coupler	QBC	99
559	Broadband H Plane Directional Coupler	QDC	101
560	Broadband E Plane Directional Coupler	QDC	101
561	Broadband Split Block Directional Coupler	QJG/QJR	95, 97
564	Cross Guide Directional Coupler-4 port	QJC	103
565	Cross Guide Coupler 3 Port/Termination	QJC	103
566	Crossed Guide W/G Coupler	QJX	105
580	Termination Low Power	QWN	119
581	Medium Power Load Termination	QTG	122
582	High Power Termination	QTH	122
585	Sliding Match Termination	QWG	125
590	Adjustable W/G Short Circuit	QAT	125
600	Single Hybrid Ring Power Divider	QHR	111
605	3 dB Short Slot Hybrid 90 Deg.	QSP	109
610	Triple Hybrid Ring Power Divider	QHR	111
620	E/H PlaneTuner	QWU	125
640	E Plane W/G Tee	QUH	118
650	H Plane W/G Tee	QUH	118
660	90 Degree E Plane Bend	QWB	124
661	30 Degree E Plane Bend	QWB	124
662	60 Degree E Plane Bend	QWB	124
665	45 Degree E Plane Bend	QWB	124
670	90 Degree H Plane Bend	QWB	124
671	30 Degree H Plane Bend	QWB	124
672	45 Degree H Plane Bend	QWB	124
675	60 Degree H Plane Bend	QWB	124
680	45 Degree Twist RH/LH	QWT	124
681	90 Degree Twist RH/LH	QWT	124
688	Flange Adapter	QFA	126
690	Flanged Waveguide Sections	QWS	119
691	Unflanged Raw W/G		119



# Millimeter Products, Inc. Cross Reference

MPI Model Number	Description	QuinStar Model Number	Page No.
692	Tapered Transitions	QWP	119
695	W/G Stand		127
700	Precision Drill Jig	QDJ	127
705	W/G Pressurizing Unit	QPU	129
712	Bulkhead W/G Adapter	QBA	126
750	W/G Flanges	QFF	126
752	.062 Diameter SS Pins 100 per bag	QDP	127
754	4-40 Captivated Screw 50 per bag	QFS	127
830	Mech. Tunable Gunn Oscillator	QTM	62
840	Varactor Tunable Gunn Oscillator	QTV	64
900	Pin Diode Attenuator Narrow Band	QSA	88
905	Pin Diode Attenuator Full Band	QSA	88
910	Pin Diode Switch Narrow Band Gen Purpose	QSS	90
911	Pin Diode Switch Narrow Band High Speed	QSS	90
912	Pin Diode Switch SPDT	QSD	90
915	Pin Diode Switch Full Band Gen Purpose	QSS	90
920	Harmonic Mixer	QMH	45
922	Spectrum Analyzer Mixer (with diplexer)	QMA	47
932-936	Passive Multiplier X2	QPM	74
938	Broadband Passive Multipliers	QPM	74
950	Broadband Detector	QEA	41
957	Phase-Locked Oscillator	QPL	71
960	Balanced Mixer	QMB	51
970	Balanced Mixer Wide Band	QMB	51
980	Upconverter , DSB	QMU	53
985	Upconverer SSB	QMU	53
990	Balanced Phase Detector	QEP	43

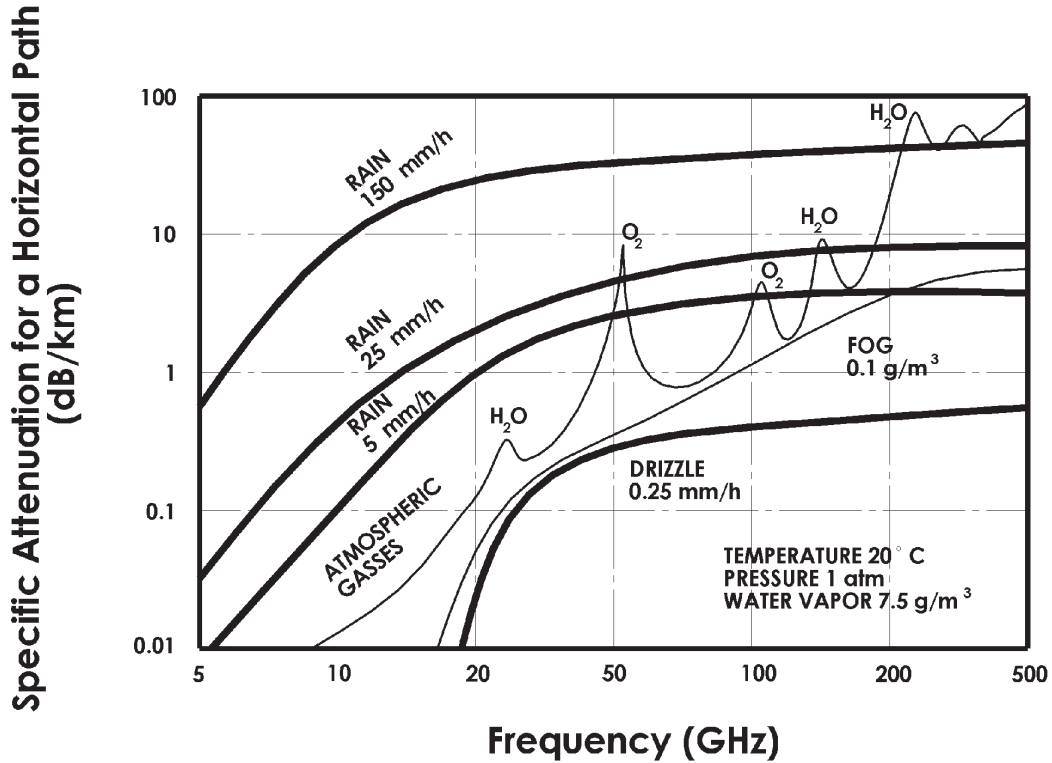

### Useful Web Sites for Millimeter Wave Applications and Resources

Frequency Allocations: US Federal Communication Commission- [www.fcc.gov](http://www.fcc.gov)  
 Technical Information: [www.nist.gov](http://www.nist.gov), [www.noaa.gov](http://www.noaa.gov), [www.fcc.gov/oet](http://www.fcc.gov/oet)  
 Radio Astronomy: [www.nrao.edu](http://www.nrao.edu)  
 Space Programs: [www.nasa.gov](http://www.nasa.gov), [www.jpl.nasa.gov](http://www.jpl.nasa.gov), [www.esa.int](http://www.esa.int)



# Significant Millimeter Wave Frequencies for Scientific and Industrial Applications

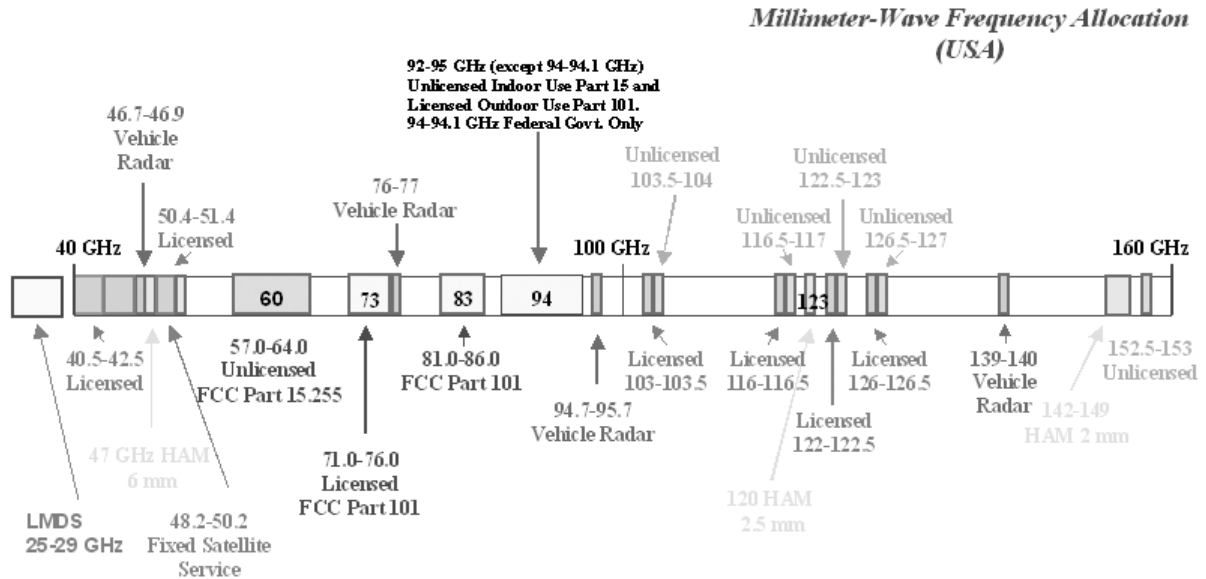

- Radars and Sensors 24.125, 35, 47, 76.5, 94, 140 GHz
- Meteorological Observations and Remote Sensing: Passive- 21-24, 31-34, 36.5-37.2, 52.6-59.3, 85.5-89, 115-122, 150-158, 164-168, 174-192 GHz, Active- 94 GHz
- Plasma Diagnostics: 35-140 GHz, and higher bands
- Covert Communications: 59-61 GHz
- Radio Astronomy: 22.2 (H<sub>2</sub>O), 23.7 (NH<sub>3</sub>), 42.5 (SiO), 88.6-90.6 (HCN), 109.7-115(CO), 220 (CO) GHz.



QuinStar warrants to you and your customers that on the date Products are delivered, they shall meet applicable specifications, be free from defects in material and manufacture and, to the extent not manufactured to your designs, be merchantable.

THIS WARRANTY SHALL APPLY ONLY TO DEFECTS THAT APPEAR WITHIN ONE YEAR FROM DATE THE PRODUCTS ARE DELIVERED. You must notify QuinStar of any such defects within 60 days after discovery of the defect, but in any event not more than 12 months after the date the Products are delivered.

New replacement Products, reconditioned replacement Products and repaired Products are warranted as new for the longer of the remainder of the original warranty period or 90 days from the date of shipment of the repaired or replaced Product.

This warranty does not cover defects caused by abuse, mishandling, accident, improper installation or application, the malfunction of another component or part of any device in which the Product is installed with which the Product interfaces, or extend to products which have been modified or repaired by anyone except QuinStar or its authorized service representative, or whose serial numbers or identification marks have been altered or removed.

QUINSTAR MAKES NO OTHER WARRANTIES OTHER THAN THOSE EXPRESSLY STATED HEREIN, INCLUDING THE IMPLIED WARRANTIES OF FITNESS FOR A PARTICULAR PURPOSE, IMPLIED WARRANTIES ARISING FROM A COURSE OF DEALING OR USAGE OF TRADE, AND IMPLIED WARRANTIES AGAINST PATENT, COPYRIGHT OR TRADEMARK INFRINGEMENT. IF APPLICABLE LAW DOES NOT PERMIT QUINSTAR TO DISCLAIM IMPLIED WARRANTIES, ANY WARRANTIES IMPLIED BY LAW ARE LIMITED TO THE TERM OF THE EXPRESS WARRANTY GIVEN HEREIN.

TO THE FULLEST EXTENT ALLOWED BY LAW, QUINSTAR SHALL NOT BE LIABLE FOR INDIRECT, INCIDENTAL, SPECIAL OR CONSEQUENTIAL DAMAGES HEREUNDER. QUINSTAR'S MAXIMUM AGGREGATE LIABILITY FOR ANY AND ALL OTHER DAMAGES FOR WHICH LIABILITY IS NOT DISCLAIMED OR OTHERWISE LIMITED, SHALL NOT EXCEED THE PRICE YOU HAVE PAID FOR THE PRODUCT WHICH IS SUBJECT TO THE DAMAGE CLAIM.

Your SOLE AND EXCLUSIVE REMEDY under this warranty is REPAIR OR REPLACEMENT at QuinStar's option and such repair or replacement shall satisfy QuinStar's warranty obligation to you, whether in contract, tort, negligence, strict liability or otherwise.

Prior to returning a Product for warranty adjustment, you shall request a return authorization number from QuinStar. The return authorization number shall be placed conspicuously on the outer package shipping label. Returned Products shall be accompanied by a written description of the reasons for the return, the circumstances under which the defect became apparent and the date the defect was discovered. Return Products to QuinStar's facility shipping charges prepaid. QuinStar shall reimburse you for shipping costs if the returned Products are found to be defective and such are covered by this warranty.

If a returned Product is found not to be defective, QuinStar shall ship the Product back to you and shall invoice you for the costs of testing and return shipment.

If a returned Product is found to contain a defect which is not covered by this warranty, QuinStar shall provide a written quotation showing the estimated cost of repair or the price of the replacement. In the event that you do not provide instructions as to disposition of the Product within 30 days from receipt of such estimate or quotation, QuinStar shall ship the Product back to you and shall invoice you for the costs of testing and return shipment.

If a returned Product is found to be defective and such defect is covered by this warranty, QuinStar shall at its option and at no charge to you, repair or replace the Product or offer you the choice of a refund or credit in the amount of the purchase price paid for the Product. Following such repair or replacement, QuinStar shall ship the Product back to you at QuinStar's expense.

At your request, QuinStar shall provide a written failure analysis and corrective action report with respect to each defect corrected under the terms of this warranty.