

STATION PROTECTION AND GROUNDS IDENTIFICATION, SELECTION, AND INSTALLATION

	CONTENTS	PAGE
1.	GENERAL	1
2.	LOCATION OF PROTECTORS	2
3.	SELECTING PROTECTORS, PROTECTOR MOUNTINGS, AND CLOSURES	4
	PROTECTORS	4
	CUSTOMER SERVICE CLOSURES	20
	PROTECTOR MOUNTING POST (PMP)	24
4.	INSTALLING PROTECTORS	26
5.	FUSED PROTECTORS	28
6.	GROUNDING AND BONDING	30
7.	SIGNALING GROUND	38
8.	COIN STATION GROUND	43
9.	LOCATING AND INSTALLING GROUND RODS	43
10.	INSTALLING SNEAK CURRENT FUSES	46
11.	EXPOSED DROP WIRES CONNECTED TO UN- EXPOSED CABLE	49
12.	118B PROTECTOR	51
13.	CONVERTING PROTECTORS	54
14.	MAINTENANCE	55
15.	SUPERSEDED ITEMS	56
1.	GENERAL	

(including coin telephones) and provides information for identification, selection, and installation of station protectors. It identifies signaling grounds and describes bonding procedures.

- 1.02 This practice is reissued to add reference to:
- UL* Listed 125EB-1 and 125EB-2 protectors
 - UL Listed 125EC-type protectors
 - B2 customer service closure
 - 200 series NIU (network interface unit)
 - C2 marina and RV closure.

Revision arrows are used to identify these changes.

1.03 Illustrations of superseded hardware that are rated DA (Discontinued Availability) are retained in this practice for reference.

1.04 Cable, wire, strand, etc., which are subject to disturbance by lightning, possible contact or induction from electric circuits in excess of 300 volts to ground, or ground potential rises from nearby power generating stations or substations are called *exposed* cable, wire, or strand.

1.05 Cable, wire, strand, etc., which are not subject to disturbances by lightning, possible contact or induction from electric circuits in excess of 300 volts to ground, or ground potential rises from nearby power generating stations, substations, or higher voltage industrial transformers are called *unexposed* cable, wire, or strand.

1.06 In nonlightning areas, the exposure status of cable or wire is based only on power exposure. In lightning areas, protection is required regardless of power exposure.

1.07 Electrically isolated sections of aerial cable are considered as open wire, for the purpose of determining the type of protectors required, unless

*Registered trademark of Underwriters Laboratories, Inc.

1.01 This practice covers the requirements for protection and grounding of subscriber stations

the cable is effectively grounded to a multigrounded neutral of a power system.

1.08 Station protectors are used in areas where telephone plant is considered exposed as outlined in paragraph 1.04. Station protectors are designed to provide safety to customers and telephone company personnel and to limit damage to telephone equipment from abnormally high voltages. Protector units limit the magnitude of a foreign voltage at the station by arcing to ground and by shorting permanently to ground when there is excessive follow-through current.

1.09 Nearby lightning strokes can develop large potential (voltage) differences between telephone wiring, power wiring, water pipes, and building steel. It is important that the customer or owner of the premises ensures that the power is properly grounded, and the metallic water pipes and building steel are bonded to the power ground. The station protector ground should be connected to the power ground. Situations resulting in separate power and telephone grounds require that the separate grounds be bonded using a No. 6 AWG copper conductor. A situation such as this might occur when the power ground is inaccessible at the premises. The technician grounds the station protector to a telephone ground rod and bonds the ground rod to the water pipe. When the customer provides access to the power ground, the telephone company will return to bond the power and telephone grounds. This situation is shown in Fig. 1 and covered in Part 6. Telephone grounding and bonding conductors should be as short and straight as possible.

1.10 When installing protectors at mobile home locations, refer to Practice 461-220-100.

1.11 Stations requiring special protective measures are:

- Stations located at power substations or generating stations.
- Stations located in hazardous atmospheres containing explosive vapors, gas, or dust (Practice 502-415-100).
- Stations connected to privately-owned circuits or facilities. Interfaces required for connecting to these stations are covered in other

practices and will be coded on the service orders. If they are not, consult your supervisor.

1.12 Where stations are served by open wire, rural wire, or aerial service wire run on the same poles with primary power conductors, **a fusible link, consisting of a 2-foot minimum length of block wire**, must be installed at the pole serving the station as outlined in Practice 462-525-150; otherwise, a fused protector must be used.

1.13 Stations served by rural wire or aerial service wire that is run on jointly used poles, supporting power distribution circuits having voltages of more than 2900 volts to ground or more than 5000 volts between conductors and include a multigrounded neutral wire, may require a 118B protector. Refer to Practice 462-525-150 and Part 12 of this practice for requirements. The 118B protector is designed to protect telephone circuits in the event of a contact between higher voltage power wires and telephone wires.

2. LOCATION OF PROTECTORS

2.01 Plan station installations so the station protectors can be grounded to the power ground, using the shortest possible length of ground wire run in the most direct route. **Protectors should be mounted outside whenever possible.** Fuseless station protectors installed indoors should be located near the protector ground source so the ground wire can be as short as possible. Fuse-type protectors installed indoors must be located as close as practical to the point of entrance of the drop wire.

2.02 To minimize the possibility of damage or immersion, place the protector in an accessible location. Do not place protectors on the fronts of buildings where appearance is a significant factor, in living quarters, or where a ladder is necessary for installation and maintenance. Protectors installed indoors without covers must not be located where inadvertent contact by a customer is likely. Mount protectors in a dry, well-ventilated location. Mount protectors underneath buildings only as a last resort.

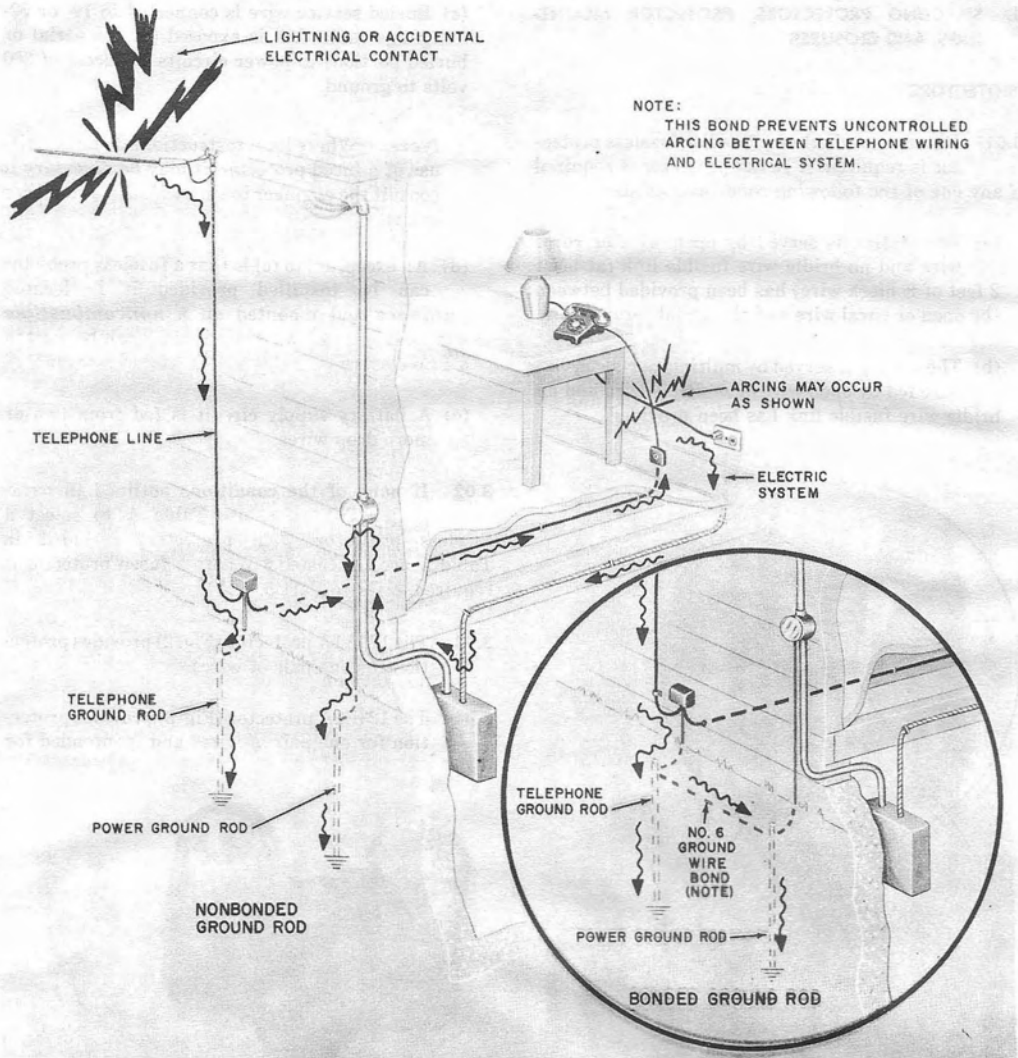

Fig. 1—How Bonding Reduces Differences of Potential Between Telephone Wiring and Electrical Systems That Are Grounded to Separate Electrodes

3. SELECTING PROTECTORS, PROTECTOR MOUNTINGS, AND CLOSURES

PROTECTORS

3.01 Determine whether a fused or fuseless protector is required. A *fused* protector is required if any one of the following conditions exists:

- (a) The station is served by open wire or rural wire and no bridle wire fusible link (at least 2 feet of E block wire) has been provided between the open or rural wire and the aerial service wire.
- (b) The station is served by multiple aerial service wire fed by open wire or multiple wire and no bridle wire fusible link has been provided.

(c) Buried service wire is connected to 19- or 22-gauge cable that is exposed (in the aerial or buried portion) to power circuits in excess of 300 volts to ground.

Note: Where local instructions do not specify use of a fused protector, it may be necessary to consult the engineer to verify if such a condition exists.

(d) An exception to (c) is that a fuseless protector can be installed provided it is located *outdoors* and mounted on a *noncombustible surface*. A 9A1A-5 terminal block can be used in a PC6 closure.

(e) A battery supply circuit is fed from two or more drop wires.

3.02 If none of the conditions outlined in paragraph 3.01 exist, use Table A to select a fuseless protector. All protectors included in Table A are UL Listed. Where a fused protector is required, refer to Part 5.

3.03 The 123A1A protector (Fig. 2) provides protection for one pair of wires.

3.04 The 123E2A protector (Fig. 3) provides protection for one pair of wires and is intended for

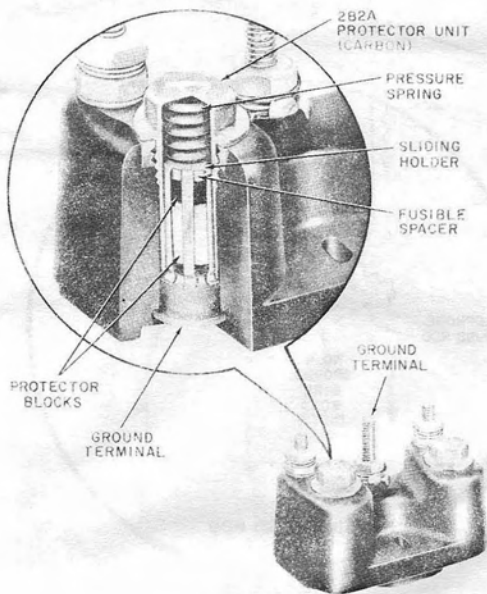

Fig. 2—123A1A Protector

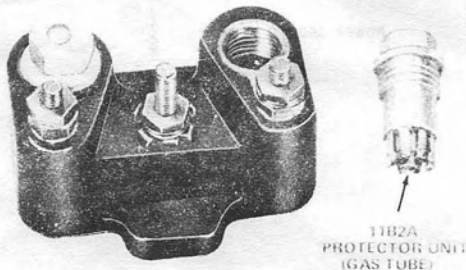

Fig. 3—123E2A Protector

♦TABLE A♦				
FUSELESS PROTECTOR SELECTION				
NUMBER OF PAIRS PROTECTED	PROTECTOR	TYPE PROTECTOR UNIT USED	USE	
			INDOOR	OUTDOOR
1	123A1A	2B2A	Yes*	Yes†
1	123E2A	11B2A	Yes*	Yes†
1	125EB-1	125E	Yes	Yes†
2	125EB-2	125E	Yes	Yes†
1	125EC-1	125E	Yes	Yes‡
2	125EC-2	125E	Yes	Yes‡
3	125EC-3	125E	Yes	Yes‡
4	125EC-4	125E	Yes	Yes‡
5	125EC-5	125E	Yes	Yes‡
6	125EC-6	125E	Yes	Yes‡
2	128A1A-2	2B2A	Yes*	Yes†
2	128E2A-2	11B2A	Yes*	Yes†
1-5	9A1A-5 or 9E1A-5	2B2A or 11A2A	No	§
1-6	116C or 116E	2A1A or 11A2A	No	Yes
1-6	117B	2A1A	Yes	No
1-5	142A1A or 142E1A	2A1A or 11A2A	No	Yes†

* Use 150B cover.
† Provides a B2, C, or D customer service closure.
‡ Provides a C customer service closure.
§ Used in 85-type closure.

use at stations served by cable or multiple wire having a high level of lightning activity. The protector should be grounded with a No. 12 ground wire (Table B).

TABLE B	
GROUND WIRE CAPACITY	
GROUND WIRE SIZE	MAXIMUM NUMBER OF PROTECTED CIRCUITS
No. 12	2
No. 10	6
No. 6	7 or more

Note: The ground wire between protectors shall be the same size as the ground wire between the protector and the grounding electrode.

3.05 ♦The 125EB-1 and 125EB-2 protectors (and two 125E protectors mounted on a B1 adapter) are UL Listed protectors only when assembled and installed as shown in this practice.

3.06 The 125EB-1 protector provides protection for one pair of wires and is intended for use at stations served by cable or multiple wire. The 125EB-1 protector is equipped with a sealed 125E protector module and a B1 adapter. The 125E protector module is equipped with two 201A gas tubes and a fail-safe shorting mechanism. The B1 adapter has the same mounting footprint as the 123E-type protector and will provide mounting for one or two 125E protector modules. The 125EB-1 protector should be grounded with a No. 12 ground wire (Table B).

3.07 The 125EB-2 protector provides protection for two pairs of wires and is intended for use at stations served by cable or multiple wire. The 125EB-2 protector is equipped with two sealed 125E

protector modules and a B1 adapter. The 125EB-2 protector should be grounded with a No. 12 ground wire (Table B). The 125-type protector is shown in Fig. 4.

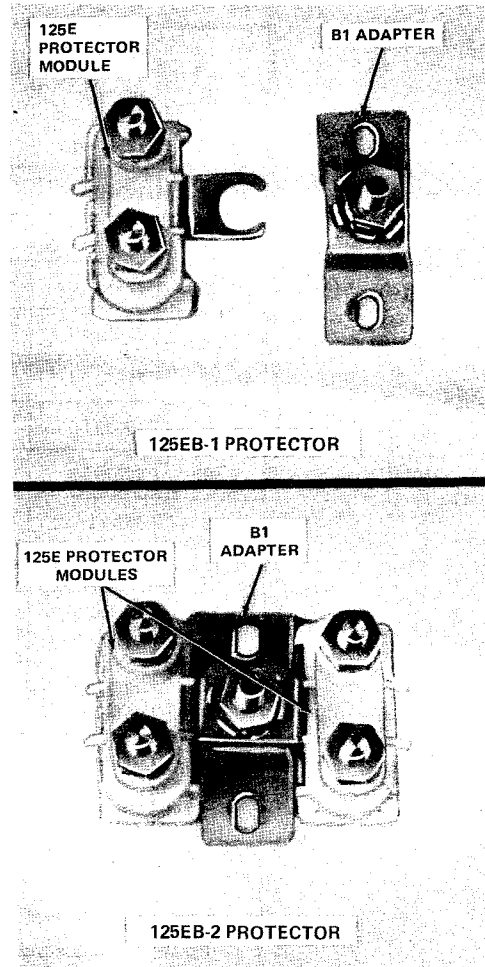

♦Fig. 4—125EB-Type Protector♦

3.08 The 125EC-type protector provides protection from one to six pairs of wires and is intended for use at stations served by cable, multiple wire, 5-pair buried cable, and 6-pair aerial drop wire. The 125EC-type protector may be changed by adding or removing 125E protectors from 125EC-1 through

125EC-6 protectors. For example, the 125EC-4 protector (Fig. 5) is a C1 adapter with four 125E protectors mounted on a C customer closure. The 125EC-type protectors must be grounded with a No. 10 ground wire (Table B).♦

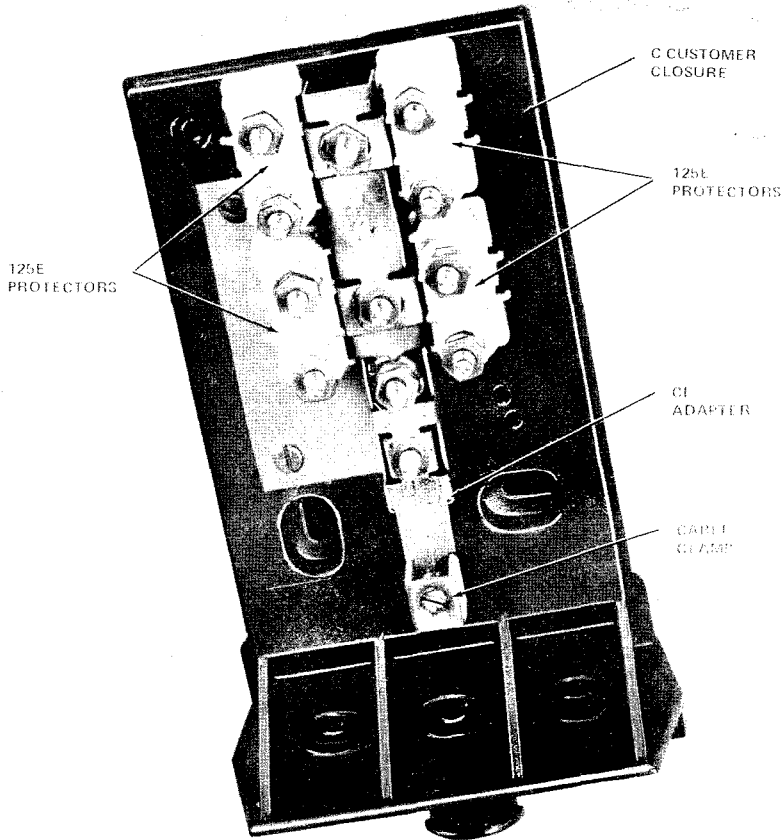

♦Fig. 5—125EC-4 Protector♦

3.09 The 128A1A-2 protector (Fig. 6) provides protection for two pairs of wires. The protector should be grounded with a No. 12 ground wire (Table B).

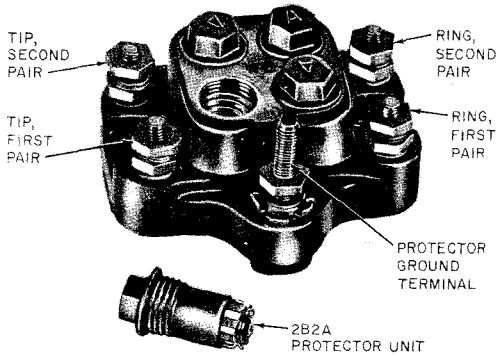

Fig. 6—128A1A-2 Protector

3.10 The 128E2A-2 protector (Fig. 7) provides protection for two pairs of wires. The protector should be grounded with a No. 12 ground wire (Table B) and may be used anywhere the 128A1A-2 protector is used.

3.11 The 11A2A protector unit can be used as a direct field replacement for the 2A1A protector units in protectors and protected cable terminals, terminal blocks, and connecting blocks. The 11B2A can be used as a field replacement for 2B2A protector units in 123- and 128-type protectors. The top of the cap is painted white to identify it as satisfactory for use on customer premises.

3.12 The 9A1A-type terminal block replaces the 6A3A (DA) terminal block.

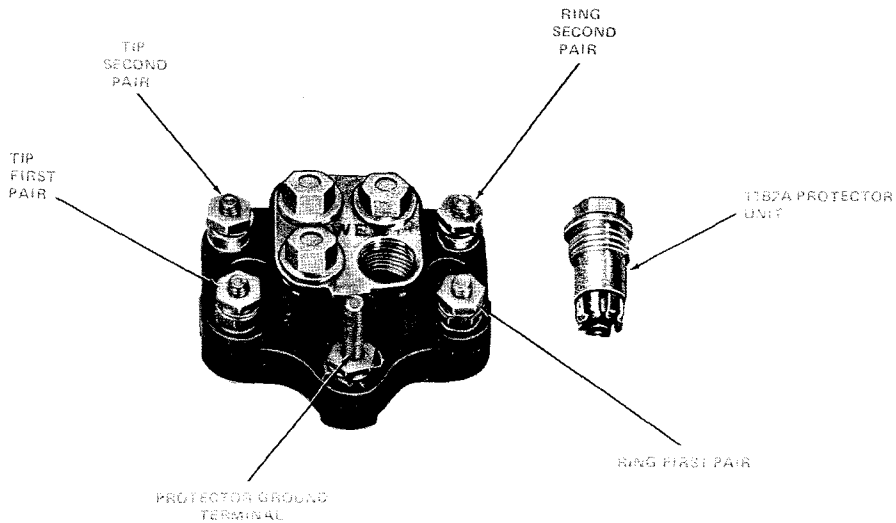

Fig. 7—128E2A-2 Protector

3.13 The 116C and 116E protectors (Fig. 8) are housed in metal containers with hinged metal covers. The No. 10 ground wire (Table B) is used to ground the 116C and 116E protectors. The 116C and 116E protectors are designed for outdoor or indoor use and generally used with 6-pair multiple aerial service wire.

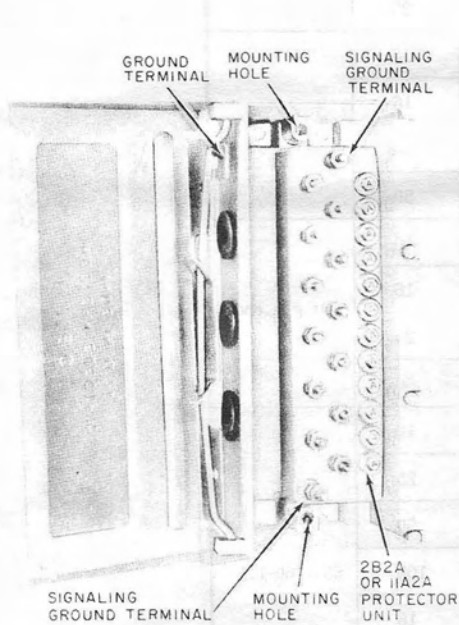

Fig. 8—116C or 116E Protector

3.14 The 117B protector (Fig. 9) should be grounded with a No. 10 ground wire (Table B). The 117B protector is designed for indoor use and generally used with 6-pair multiple aerial service wire.

3.15 Cable terminals, connecting blocks, protectors, or terminal blocks designed to protect ten or more pairs of wires, are used at apartment complexes, commercial, or industrial locations. These large capacity protectors are referred to as

multipaired protectors. Multipaired protectors (Table C) used for station protection are equipped with:

- 2A1A or 11A2A protector units
- A ground clamp for grounding to an approved ground electrode.

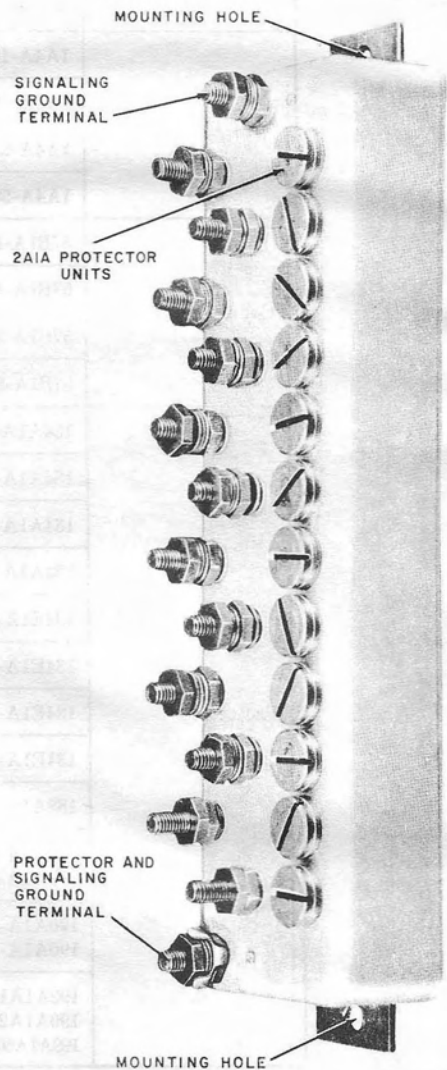

Fig. 9—117B Protector

TABLE C4			
MULTIPAIR STATION PROTECTORS			
TYPE PROTECTOR		PAIRS PROTECTED	REFERENCE PRACTICE
Cable Terminals	NH-16	16	631-210-101
	NH-25	25	
Terminal Blocks	1A4A-10	10	631-440-211
	1A4A-16	16	
	1A4A-25	25	
	1A4A-50	50	
Connecting Blocks	57B1A-10	10	461-603-100
	57B1A-16	16	
	57B1A-25	25	
	57B1A-50	50	
Protectors	134A1A-16	16	631-460-111
	134A1A-25	25	
	134A1A-50	50	
	134A1A-100	100	
	134E1A-16	16	
	134E1A-25	25	
	134E1A-50	50	
	134E1A-100	100	631-460-113
	188A1A-100	100	
	189A1A-50	50	631-460-114
	189A1A-100	100	
	190A1A-50	50	631-460-115
190A1A-100	100		
199A1A10-25	25	631-470-204	
199A1A25-50	50		
199A1A50-100	100		

3.16 The NH16 and NH25 cable terminals are installed in metal housings. The metal housings are equipped with a ground clamp and the cable terminals must be bonded (grounded) to an acceptable ground (Table B).

3.17 The NH16 cable terminal (Fig. 10) may be strand-, pole-, or wall-mounted. Where the NH16 cable terminal is wall-mounted on the premises of a customer, it must be bonded (grounded) to an acceptable ground (Table D).

3.18 The NH25 cable terminal (Fig. 11) may be pole- or wall-mounted. Where the NH25 cable terminal is wall-mounted on the premise of a customer, it must be bonded (grounded) to an acceptable ground (Table D).

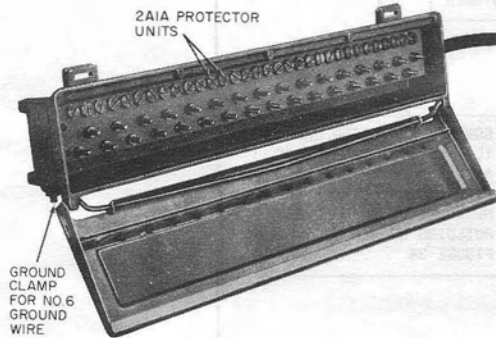

Fig. 10—NH16 Cable Terminal

terminal is wall-mounted on the premise of a customer, it must be bonded (grounded) to an acceptable ground (Table D).

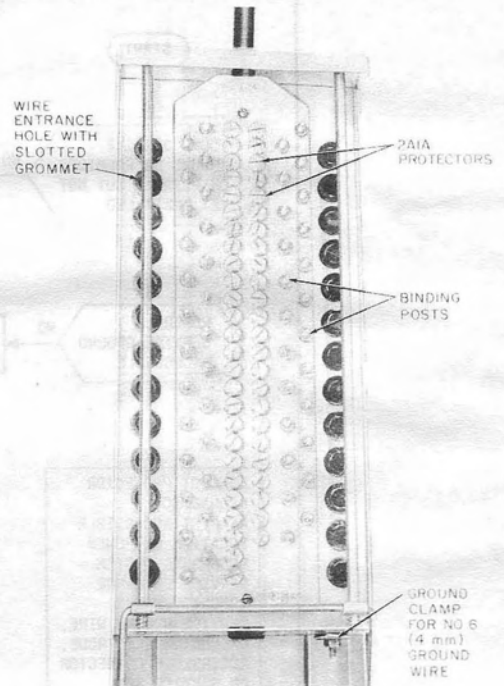
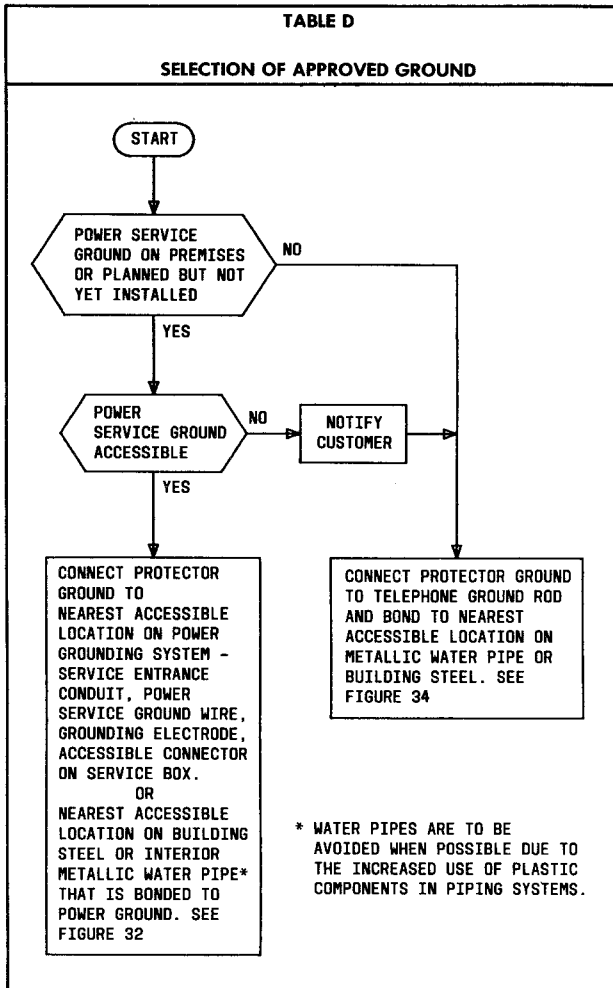

Fig. 11—NH25 Cable Terminal



3.19 The 1A4A-type terminal blocks (Fig. 12) are available in 10-, 16-, 25-, and 50-pair sizes (Table C). The terminal blocks may be mounted in cable terminal boxes or cable terminal sections. The

ground clamp permits the connection of a protector ground. The 1A4A-type terminal blocks should be grounded with a No. 6 ground wire (Table B).

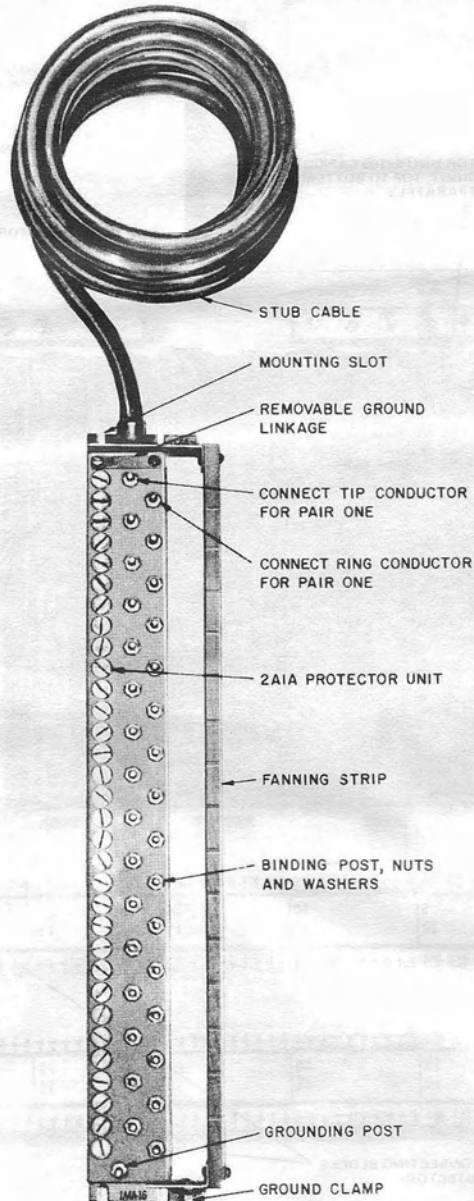

Fig. 12—1A4A-16 Terminal Block

3.20 The 188-type modular protector (Fig. 13) is a combination protector and terminating field intended for use with the 88-type connection hardware. It provides electrical protection at building

entrance terminals for 100 exposed feeder cable pairs by using 3B- or 4B-type protector units. The protector units must be ordered separately.

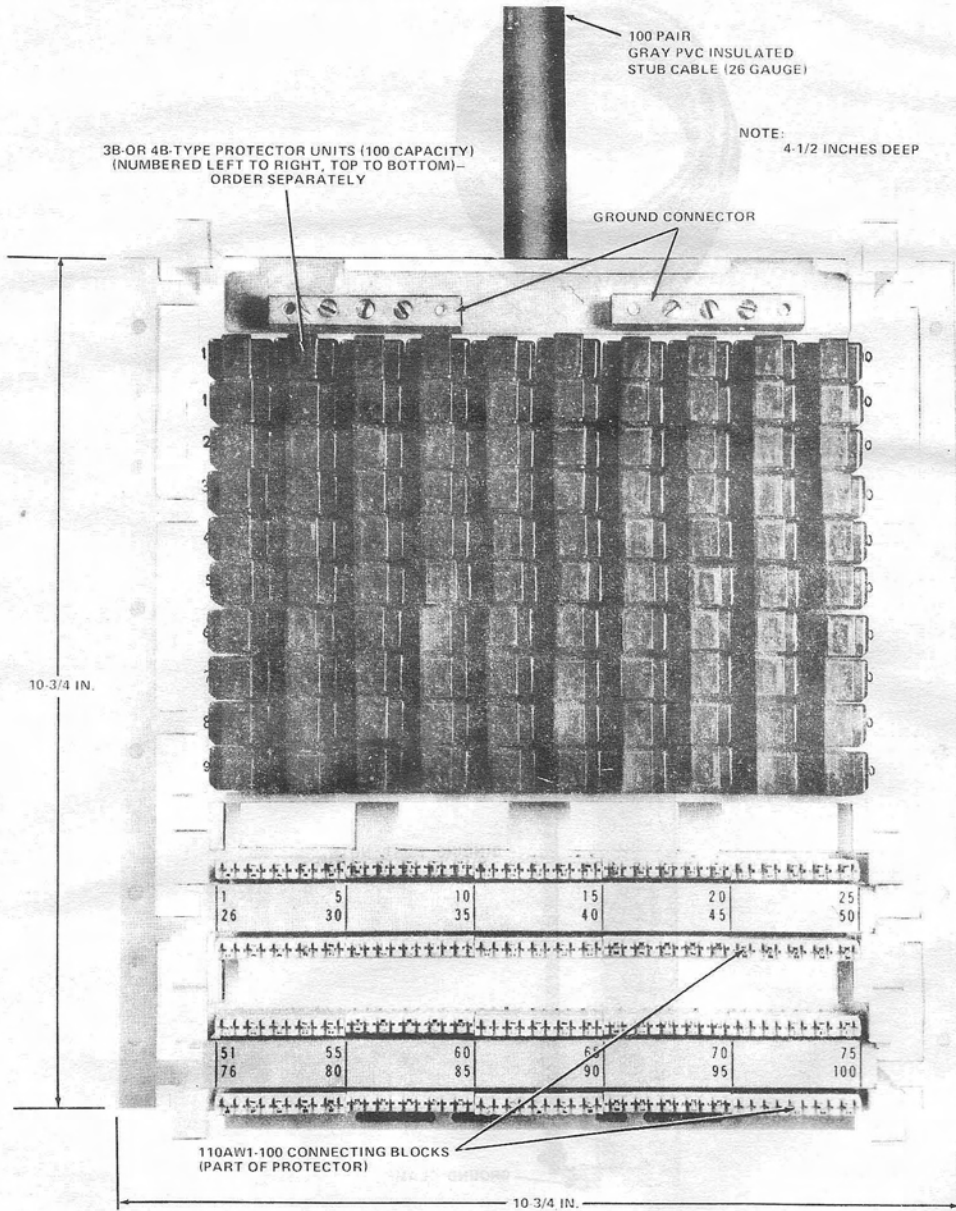

Fig. 13—188-Type Modular Protector

3.21 A 3-wire ground connector is provided on each side of the 188-type modular protector for strapping protectors together and for running a No. 6 ground wire to an approved ground as listed in Table D.

3.22 The 189-type modular protector (Fig. 14) is a combination protector and terminating field intended for use with the 66-type quick-connect hardware. It provides electrical protection at building entrance terminals for 25, 50, and 100 exposed feeder

100 PAIR GRAY PVC INSULATED FUSIBLE
STUB CABLE (26 GAUGE) (SWIVEL FOR
TOP OR BOTTOM ENTRY)

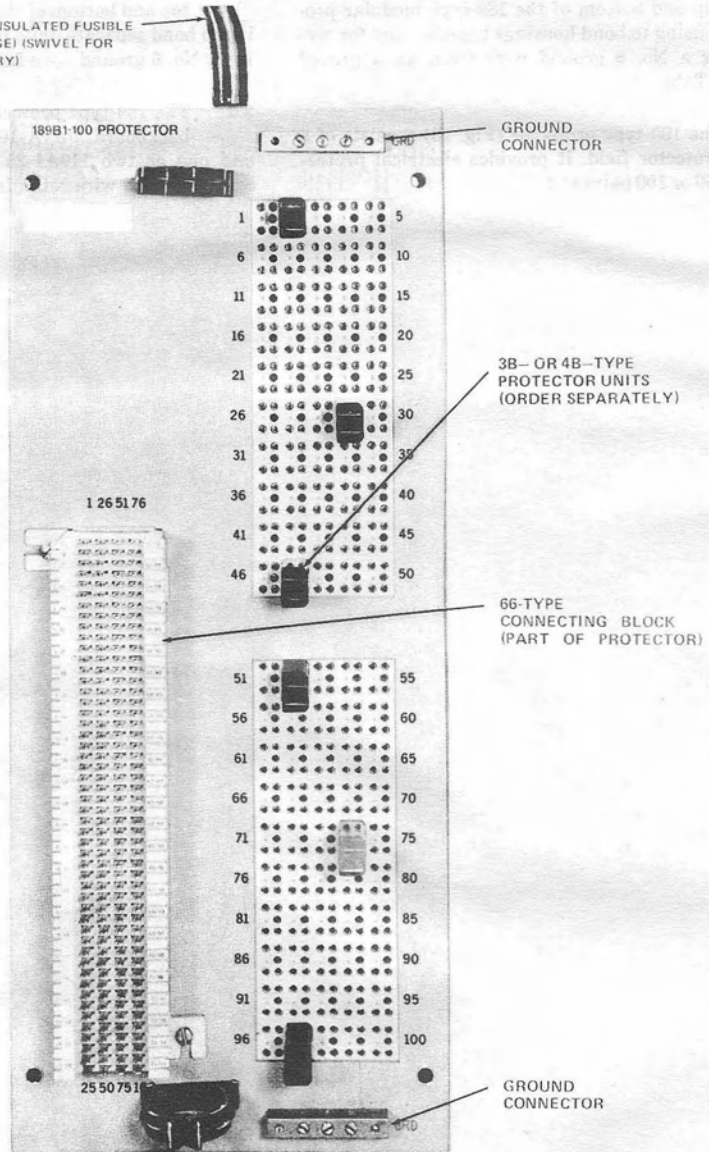

Fig. 14—189-Type Modular Protector

cable pairs by using 3B- or 4B-type protector units. The 3B1A protector units must be ordered separately.

3.23 A 3-wire ground connector is provided at the top and bottom of the 189-type modular protector housing to bond housings together and for terminating a No. 6 ground wire from an approved ground (Table D).

3.24 The 190-type protector (Fig. 15) consists of a protector field. It provides electrical protection for 50 or 100 pairs at building entrance terminals

by using 3B- or 4B-type protectors. The protector units must be ordered separately.

3.25 A 3-wire ground connector is provided at the top and bottom of the 190-type protector housing to bond separate units together and for terminating a No. 6 ground wire from an approved ground.

3.26 The 199-type protector consists of a metallic backboard, 9A1A-10 or -25 terminal blocks, and one or two 119A1-25 connecting blocks. It is equipped with wire retaining rings and a 2A ground

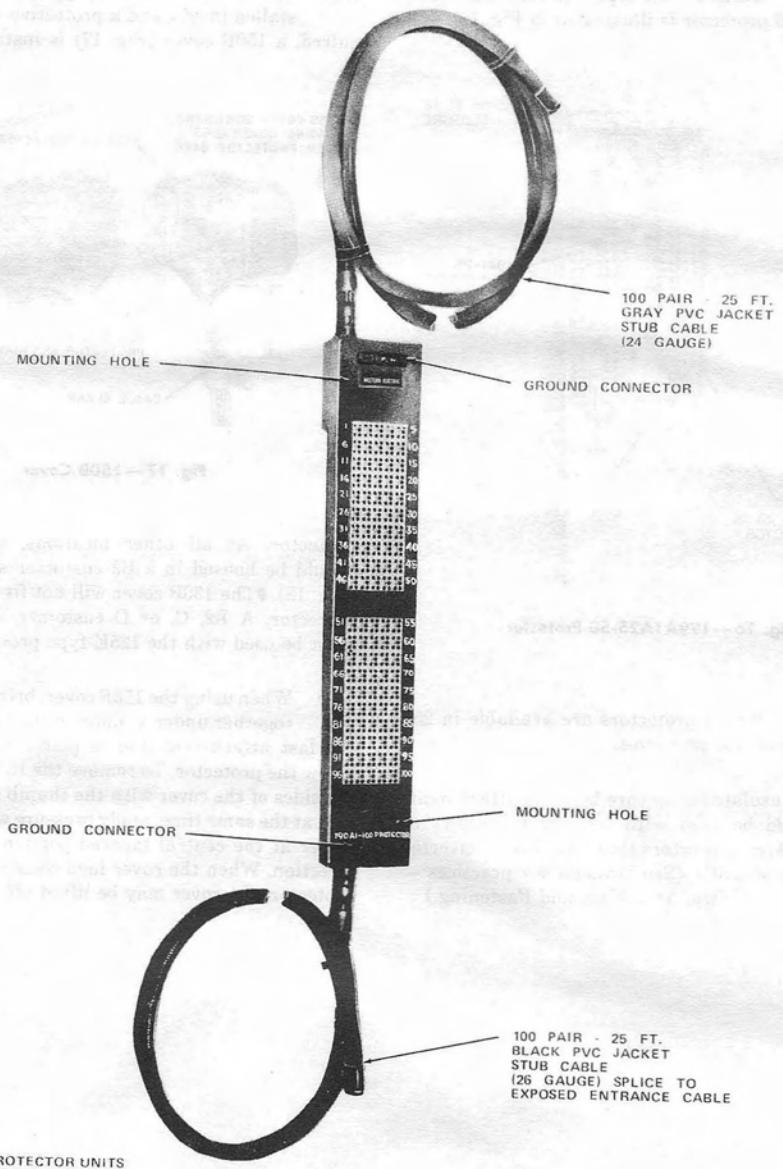

NOTE:
 USES 3B1A PROTECTOR UNITS
 (3B3A FOR SPECIAL CIRCUITS)

Fig. 15—190A1-100 Protector

strip and utilizes 2A-type protectors. The 199A1A25-50 protector is illustrated in Fig. 16.

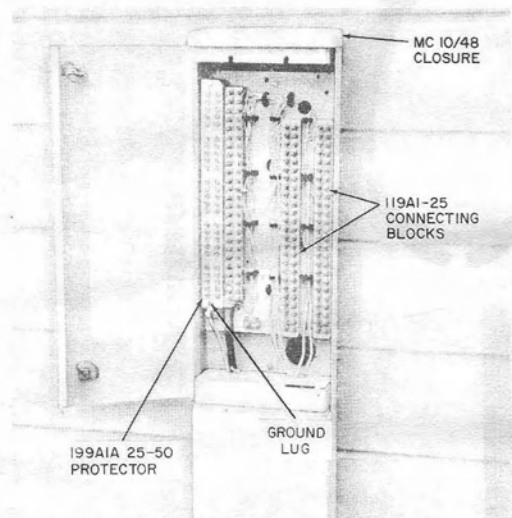

Fig. 16—199A1A25-50 Protector

3.27 The 199-type protectors are available in 25-, 50-, and 100-pair sizes.

3.28 Noninsulated drop wire building attachments should be used with fuseless protectors or with fused-type protectors that have been converted to fuseless operation. (See Division 462 practices — Drop and Block Wire, Attaching, and Fastening.)

3.29 Where the 123- or 128-type protectors are installed inside, and a protective covering is required, a 150B cover (Fig. 17) is installed over the

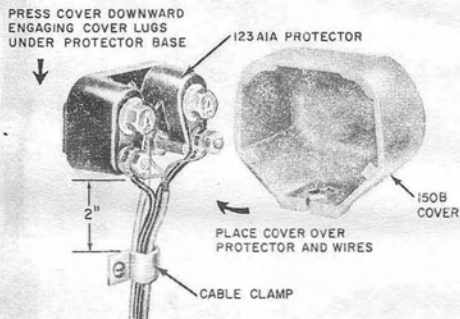
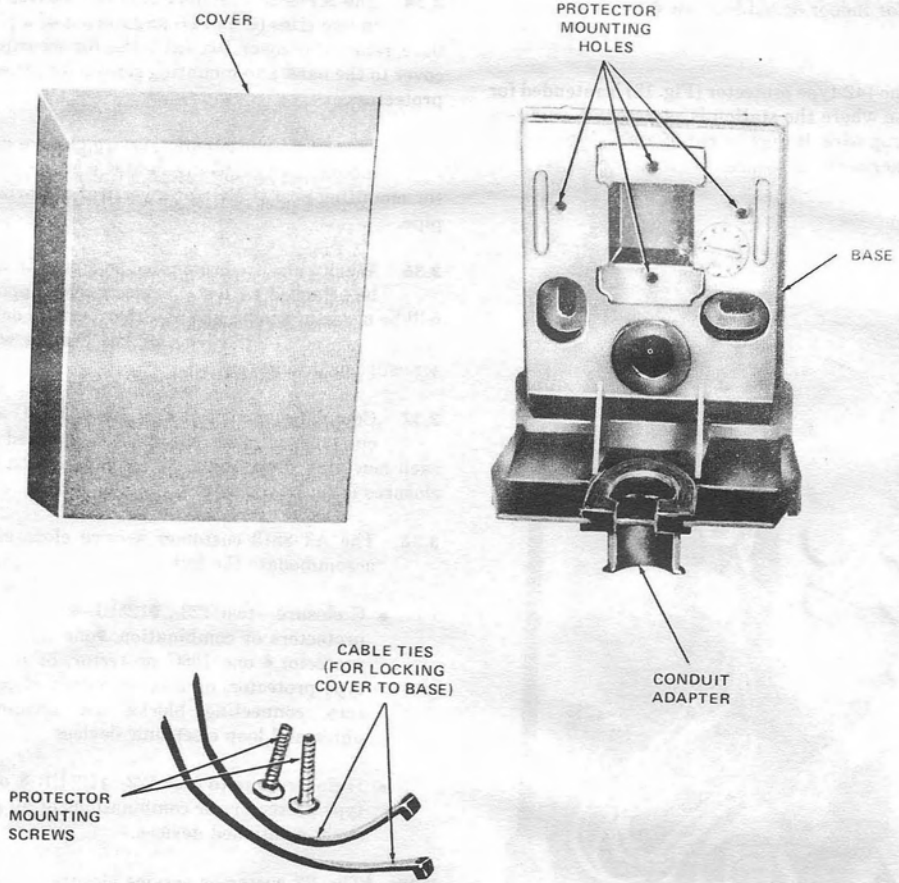

Fig. 17—150B Cover

protector. At all other locations, the protectors should be housed in a B2 customer service closure (Fig. 18). ♦The 150B cover will not fit the 125E-type protector. A B2, C, or D customer service closure must be used with the 125E-type protector.♦

3.30 When using the 150B cover, bring all the wires together under a common clamp. The clamp is the last attachment and is placed about 2 inches below the protector. To remove the 150B cover, grasp the sides of the cover with the thumb and forefinger and, at the same time, apply pressure with the middle finger at the central tapered portion in an upward direction. When the cover lugs clear the base of the protector, the cover may be lifted off.



♦Fig. 18—B2 Customer Service Closure♦

3.31 The 125EB-1 and 125EB-2 protectors may be surface mounted for indoor use where no protective covering is required or mounted in a B or B2 customer service closure for indoor or outdoor use. The 125EC-1 through 125EC-6 protectors may be surface mounted for indoor use where no protective covering is required or mounted in a C customer service closure for indoor or outdoor use.

3.32 The 142-type protector (Fig. 19) is intended for use where the station is served by 5-pair service or drop wire. It may be mounted in either a C or D customer service closure.

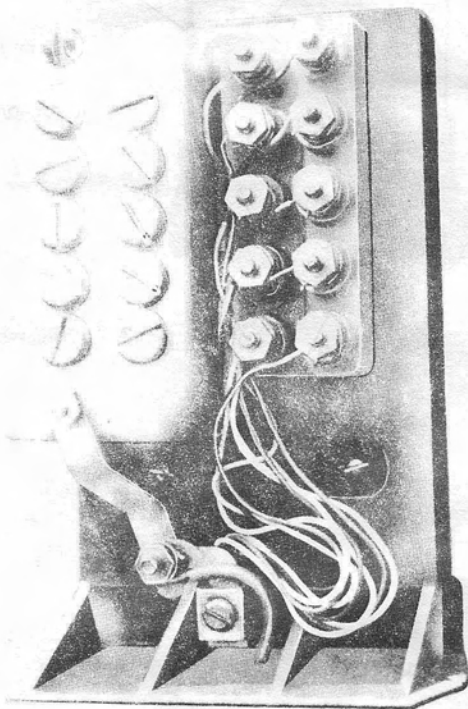

Fig. 19—142-Type Protector in C Customer Service Closure

CUSTOMER SERVICE CLOSURES

3.33 The AT-8813 (C and D) customer service closures are used as exterior protective housings for protectors, connecting blocks, and various other telephone company devices.

3.34 The AT-8813 customer service closures come in two sizes (C and D) and consist of a plastic base, removable cover, two cable ties for securing the cover to the base, and mounting screws for attaching protectors.

3.35 The AT-8813 customer service closure can be mounted on any suitable flat surface, protector mounting post (PMP), or a vertical or horizontal pipe.

3.36 When a closure is mounted on a pipe, it should be attached with a C lashed cable support. It will be necessary to break out either vertical or horizontal openings in the back of the closure with a screwdriver or similar tool.

3.37 Complete instructions for installing C and D customer service closures are packed with each new unit. More complete information on these closures is contained in Practice 462-242-101.

3.38 The AT-8813 customer service closures will accommodate the following:

- C closure—two 123-, 125EB-1, or 128-type protectors or combination, one 125EC-type protector, one 106C protector, or one 142-type protector, or a combination of protectors, connecting blocks, 1A termination units, and loop electronic devices
- D closure—up to four 123-, 125EB-1, or 128-type protectors or combinations of all previously mentioned devices.

3.39 The B2 customer service closure is used as exterior protective housing for protectors, connecting blocks, and various other telephone company devices.

3.40 The B2 customer service closure can be mounted on any suitable flat surface, protector mounting post, or a vertical or horizontal pipe.

3.41 The B2 customer service closure will accommodate a UL Listed single 123- or 128-type protector or a 125EB-1 or 125EB-2 protector. Typical installations are shown in Fig. 20 and 21.

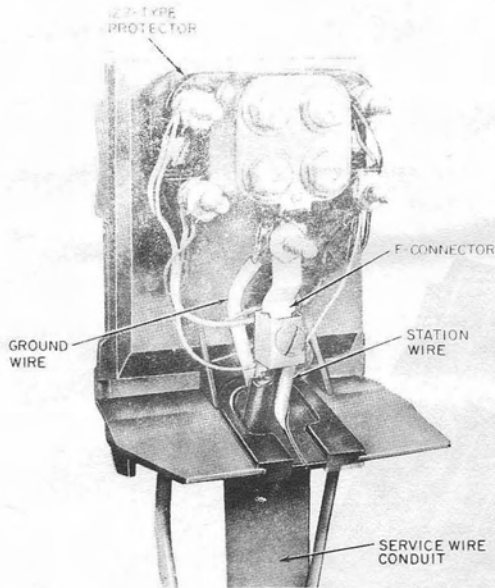

◆Fig. 20—128-Type Protector Installation Using B2 Customer Service Closure◆

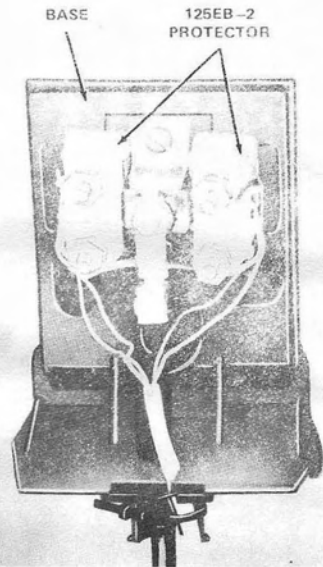

◆Fig. 21—125EB-2 Installed in B2 Customer Service Closure◆

3.42 When a closure is mounted on a pipe, it should be attached with a C lashed cable support (Fig. 22). It will be necessary to break out either vertical or horizontal openings in the back of the closure with a screwdriver or similar tool.

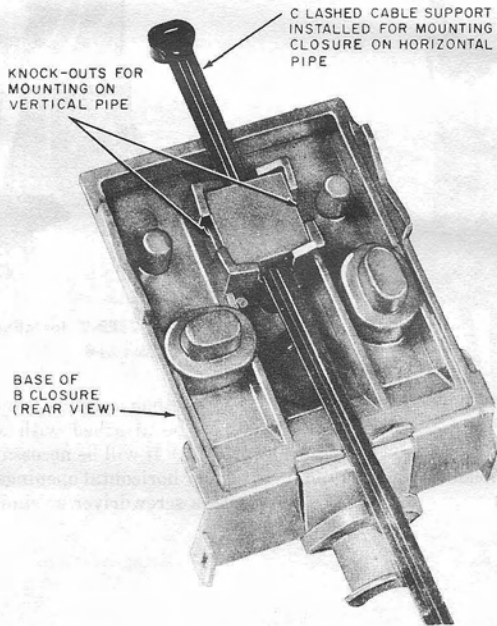
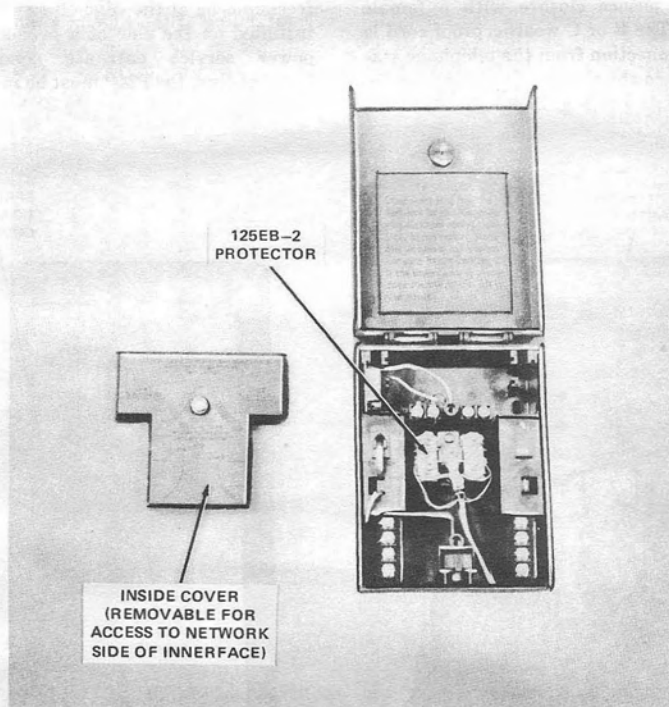

Fig. 22—Installation of C Lashed Cable Support on B2 Customer Service Closure

3.43 The 200 series NIU (network interface unit) is used for outside mounting on a wall or protector mounting post. When equipped with a 125EB-1 or 125EB-2 protector, it provides station protection for one or two pairs of wires. A 125EB-2 protector is shown installed in Fig. 23. See Practice 462-005-165

for detailed information on the 200 series NIU.

3.44 The C2 marina and RV (recreational vehicle closure) is used to provide telephone service to boats, marinas, and RVs.



◆Fig. 23— 125EB-2 Protector Installed in 200 Series NIU◆

3.45 An RV is a unit mounted on a chassis designed for travel, camping, semipermanent home, vacationing, and other outdoor use. Wiring methods cover travel trailers, truck-mounted campers, camping trailers, motor homes, vans converted to campers, and boats docked at marinas.

3.46 The C2 marina and RV closure is a modified C customer service closure with a female weatherproof jack. The B or C weatherproof cord is used to make the connection from the telephone station to the protector in the closure. The 125EB-1 protector installed is shown in Fig. 24.

PROTECTOR MOUNTING POST (PMP)

3.47 The protector mounting posts (PMP-38 [Fig. 25] and PMP-50) are designed to mount a 123-, 125E-, or 128-type protector, or a B2, C, or D customer service closure, or network interface unit, where protectors are served by buried service wire. The PMP is available in 38-inch and 50-inch sizes to suit various conditions. It can be installed freestanding at the edge of a mobile home or can be installed on the side of a permanent building or a power service entrance conduit. When used freestanding, the PMP must be in the ground a minimum of 12 inches. *The PMP is not a ground rod.*

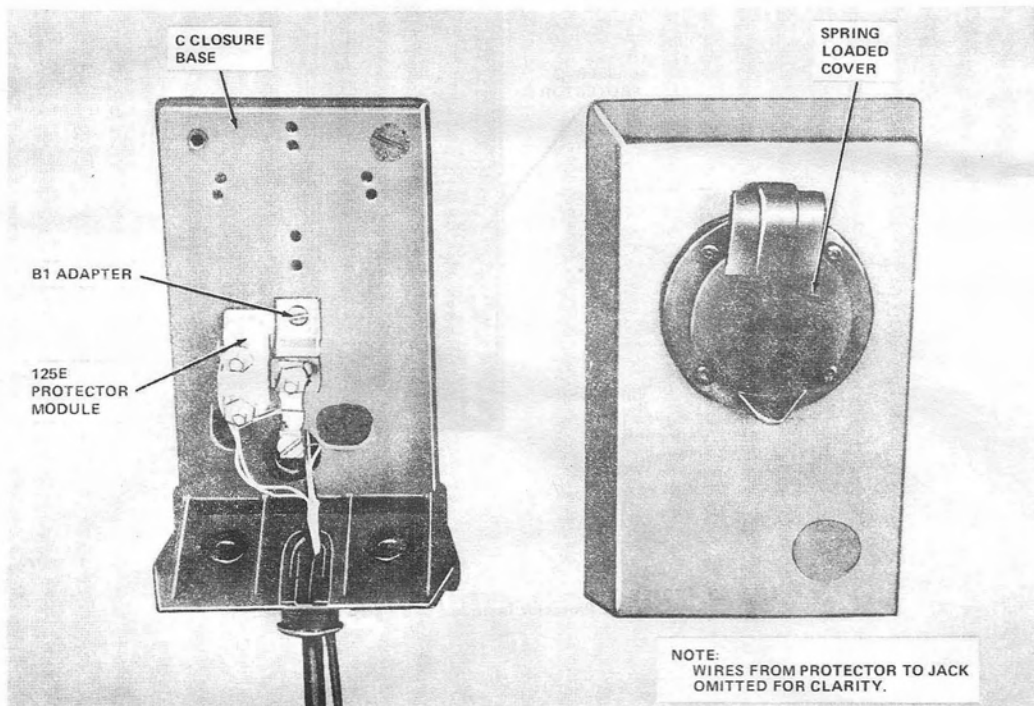
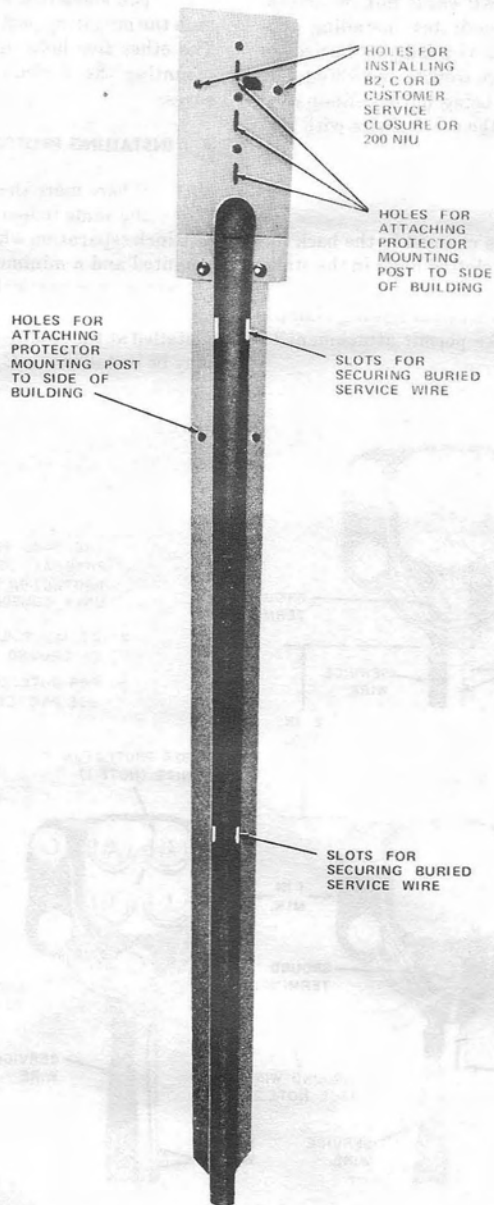

Fig. 24—125EB-1 Protector Installed in C2 Marina and RV Closure



◆Fig. 25—Protector Mounting Post (PMP)◆

3.48 Because the mounting plate is riveted to the stake portion, the PMP *shall not* be driven into the ground. This necessitates installing the mounting post as the service wire is being buried so it can be placed in the open trench. Installing the PMP as the service wire is being buried eliminates the possibility of damaging the service wire with the stake.

3.49 The PMP has an open channel in the back for the service wire. The slotted holes in the stake permit the service wire to be fastened in the channel by using plastic cable ties or metal sealing clamps. The round holes in the stake permit attachment to structures where required.

3.50 The mounting plate at the top of the PMP has two elongated holes which can be used to attach the mounting post to structures where required. The other five holes in the mounting plate are for mounting the various protector mountings or closures.

4. INSTALLING PROTECTORS

4.01 Where more than one protector is installed at the same indoor location, provide a minimum of 1-inch separation when protectors are horizontally mounted and a minimum of 2-inch separation when protectors are vertically mounted (Fig. 26). When more than one 123-, 125E-, or 128-type protector is installed at the same outdoor location, the protectors may be installed in a C or D customer service closure.

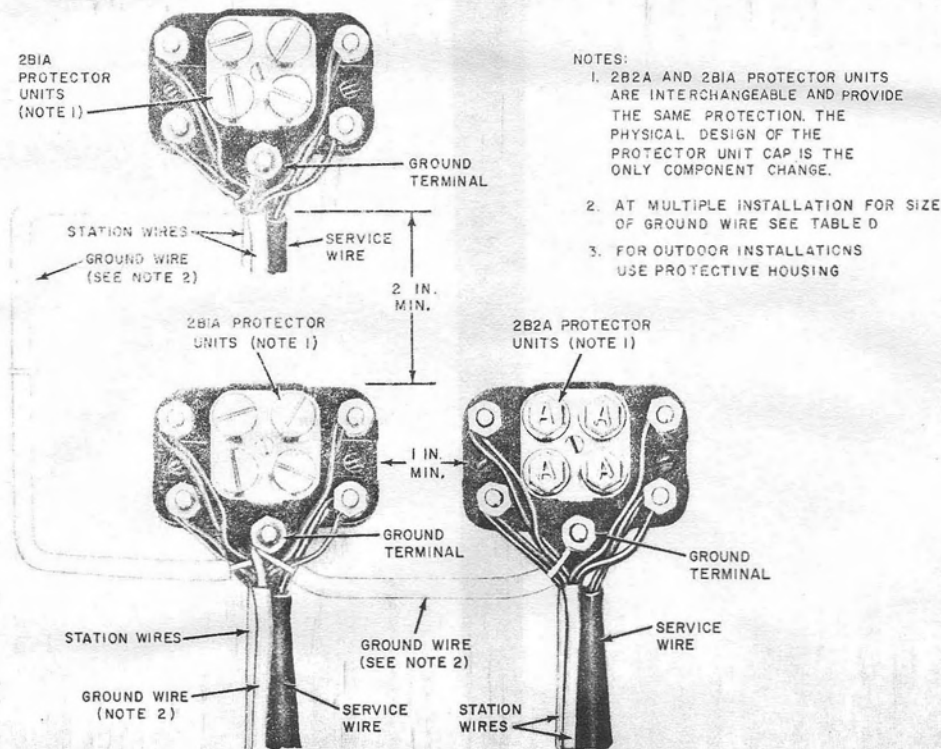

NOTES:

1. 2B2A AND 2B1A PROTECTOR UNITS ARE INTERCHANGEABLE AND PROVIDE THE SAME PROTECTION. THE PHYSICAL DESIGN OF THE PROTECTOR UNIT CAP IS THE ONLY COMPONENT CHANGE.
2. AT MULTIPLE INSTALLATION FOR SIZE OF GROUND WIRE SEE TABLE D
3. FOR OUTDOOR INSTALLATIONS USE PROTECTIVE HOUSING

Fig. 26—Installing Protectors in Multiple

4.02 Where the 150B cover is to be used with 123- or 128-type protectors, mount the protectors in an upright position (ground terminal in down position) to permit proper installation of the cover. **Do not use the 150B cover outdoors.**

4.03 Terminate line input (i.e., aerial drop or buried service wire) and station wires on the protector with the ring conductors (single tracer or red wires) connected to the right-hand terminals of the protector. Unused station wire conductors should be looped back and coiled around the station wire jacket or stored in such a manner as to prevent them from coming into contact with protector terminals or bare wires.

4.04 The 123-, 125E-, and 128-type protectors have two nuts on each line terminal. Terminate line wires under the bottom washer and nut on the 123- and 128-type protectors, and between the bottom nut and washer on the 125E-type protectors. After tightening the bottom nuts, place station wiring under the top nuts. Use washers between wires when more than one wire is placed under a nut. Use caution when terminating station wires on the protector terminals as the wire may catch in the threads of the terminal and be cut or broken when nuts are tightened. Older 123- and 128-type protectors have one nut on each line terminal.

4.05 Make sure all nuts are tight.

4.06 The 123-, 125E-, and 128-type protectors can be installed on metallic cold water pipes using a 114A bracket (Fig. 27).

4.07 Where a metallic cold water pipe is used as the ground electrode, the 123-, 125E-, and 128-type protectors can be installed directly on the water pipe.

4.08 The 114A bracket can also be used to install the 123-, 125E-, or 128-type protectors directly on power service entrance conduit.

4.09 Use the 150B cover to protect the 123- and 128-type protectors that are installed indoors on a 114A bracket.

4.10 To install the 114A bracket:

- (1) Place a B station ground clamp through slots in the bracket. Select horizontal or vertical slots in the bracket, whichever will permit mounting the bracket in an upright position.
- (2) Attach the B station ground clamp to an acceptable metallic cold water pipe or to the power service entrance conduit.
- (3) Mount the 123-, 125E-, or 128-type protector on the 114A bracket, using the two No. 8-32 self-tapping screws furnished with the bracket.

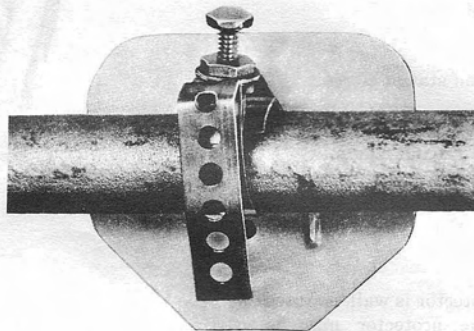

FORM E-3013B OMITTED FOR CLARITY

Fig. 27—114A Bracket Installed on Water Pipe or Power Entrance Conduit

(4) Connect the 2-inch length of copper wire (attached to the bracket) *under the pronged washer of the protector ground terminal* (Fig. 28).

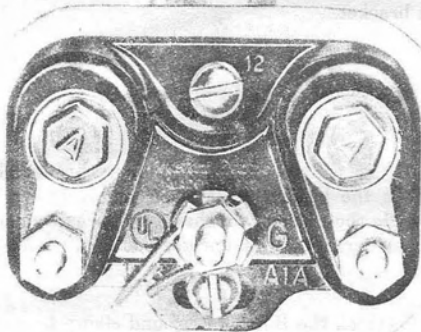

Fig. 28—Ground Wire of 114A Bracket Connected to Protector Ground Terminal

(5) Connect service wire and station wires.

(6) Install Form E-3013B. This form may be placed on the B station ground clamp.

(7) Use the 150B cover to protect the 123- and 128-type protectors that are installed indoors.

4.11 The 116C or 116E protector is wall-mounted with two screws. The protector may be mounted horizontally or vertically. When mounted horizontally, the protector should be positioned so the cover drops down.

4.12 The 117B protector is wall-mounted with two screws and may be mounted in the horizontal or vertical position.

4.13 Multipair protectors are generally placed at the time cable facilities are installed or are installed as specified by detailed plans. When multipair protectors are to be otherwise installed, reference should be made to the practice pertaining to the particular protector being installed (Table C).

5. FUSED PROTECTORS

5.01 The 106C protector (Fig. 29) has five binding posts, two 2B2A protector units, and two 11C fuses (Fig. 30).

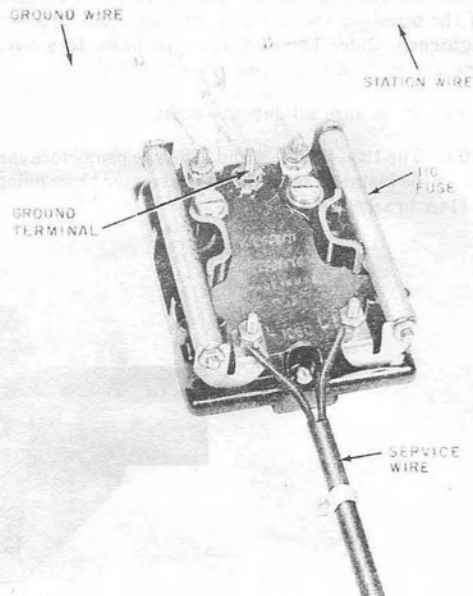

Fig. 29—106C Protector

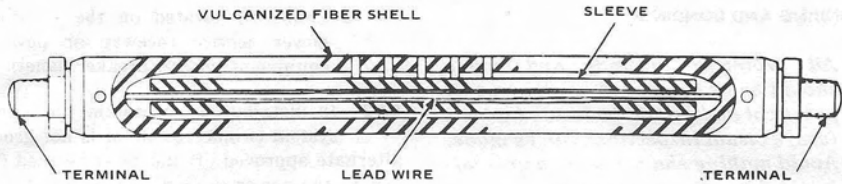

Fig. 30—11-Type Station Line Fuse

5.02 Where it is necessary to protect more than one pair of wires with fused-type protectors, additional 106C protectors must be used.

5.03 Where the 106C protector is installed indoors, it must be mounted where the drop or buried service wire enters the building, keeping the length of drop or buried service wire within the building to a minimum.

5.04 Where aerial service wire is supplied to fused protectors by open rural or urban wiring, insulated building attachments must be used for attaching aerial service wires to combustible surfaces. Also, under the same conditions, insulated tubing must be used where aerial service wires are fed through combustible walls.

5.05 When the 106C protector is installed outdoors, use a C customer service closure (Fig. 31). Where this combination is used to terminate buried service wire, mount the protector upside down in the closure so the ground terminal is at the bottom. This will facilitate the use of the F connector. The conductors of the buried service wire must be connected to the line terminals (marked L) at the top of the protector, while the station wiring must be connected to the bottom terminals (marked I). Where a 106C protector is installed indoors and buried service wire is terminated, make connection and ground the shield without the C customer closure.

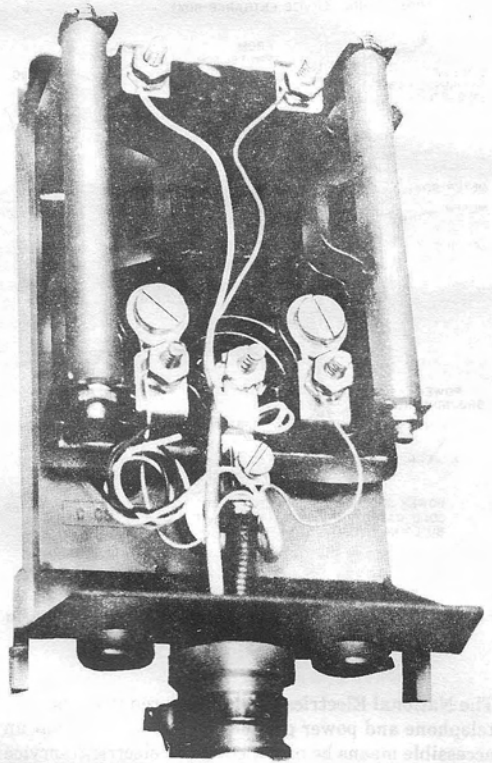

Fig. 31—106C Protector in C Customer Service Closure With Buried Service Wire

6. GROUNDING AND BONDING



All protector grounds and bonds should be as short and as straight as practical and should be located where future visual inspections can be made. Avoid making sharp bends in grounding and bonding conductors.

6.01 The first choice for approved ground is some part of the power grounding system (Fig. 32).

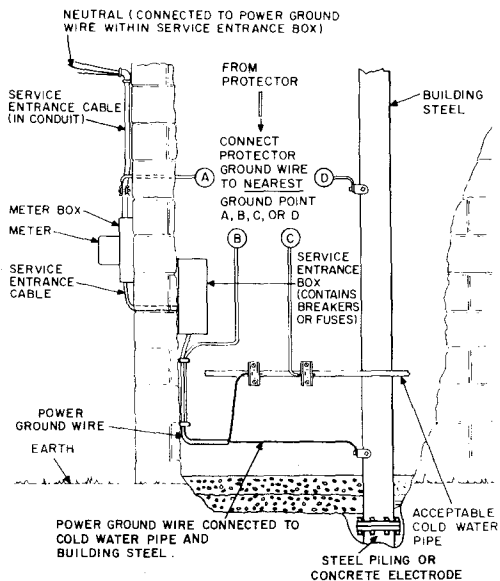

Fig. 32—Acceptable Protector Grounding Connections to the Power Ground

The National Electrical Code* now requires that the telephone and power grounds be bonded and that an accessible means be provided at the electrical service for bonding other systems, such as telephone, to the power. This means may consist of an accessible:

- Metallic service entrance conduit
- Power grounding conductor

- Connector located on the exterior of the power service raceway or power service equipment (circuit breaker panel).

6.02 In installations where the power grounding system is inaccessible or is not grounded, an alternate approved ground must be used (Table D). Where the power ground is inaccessible, it usually will be impossible to determine whether the power and telephone grounds are bonded together. In both cases the customer must be notified that an unsafe condition may exist and requested to have the power ground made accessible or installed so that the protector can be grounded to the electric power grounding system. A suggested form letter (Fig. 33) may be used to notify the customers.

6.03 The telephone technician is not expected to determine whether the power ground is properly installed. However, if it is found obviously defective, such as the ground wire broken or disconnected, do not use it as approved ground, but use one of the alternate choices in Table D. The condition of the power ground should be reported to the customer.

6.04 Do not connect station protector ground wires to:

- Gas pipes
- Electrical service branch circuit conduit
- Armor of BX cable
- Interior of any electrical box
- Aluminum conduit
- Plastic pipe.

6.05 When connecting the protector ground to a metallic water pipe, always verify that the pipe is continuously metallic to the point where the power ground is connected to it. Make sure there are no intervening plastic sections or fittings. Because of increased use of plastic components, the use of water pipes for grounding should be avoided, if possible.

6.06 Grounding or bonding connections may be made to aluminum power ground wire with the B aluminum connector. Because of possible corrosion, this connector should not be:

- Used to join two copper conductors
- Used within 1/2 mile of the seacoast
- Buried.

* Registered trademark of the National Fire Protection Association.

TELEPHONE COMPANY
CONNECTION OF THE TELEPHONE GROUND

Dear Customer:

While we have installed your telephone system, we have been unable to connect the telephone ground to your electric power grounding system as recommended by the National Electrical Code because it was not accessible to us.

This condition may be hazardous and should be corrected by a qualified individual. When the power ground has been made accessible, please notify us on 611 (INSERT REPAIR NUMBER) and we will return to connect the telephone ground to your electric power grounding system in accordance with the National Electrical Code.

Telephone Company Representative

Date

Fig. 33—Suggested Information to be Supplied to Customer Upon Completion of Installation/Repair Visit—Unable to Ground Protector to Power Ground

6.07 Separate power and telephone ground must be bonded together to minimize potential (voltage) differences between them (Fig. 1).

6.08 Telephone service may be installed where a power ground is not provided or is inaccessible. However, the customer should be informed immediately of the need for a power ground and requested to notify the telephone company when the ground has been provided. The procedure for completing the exchange of information shall be covered by local instructions as shown in Fig. 33. Station protectors installed where there is no power, or the

power ground is inaccessible, should be grounded as shown in Fig. 34.



Caution should be exercised on visits (installation or repair) to locations where structures are under construction or are being remodeled. At these locations, temporary power and water pipe arrangements are often encountered. Therefore, it is very important to select a ground electrode of a permanent nature. Also, ground wire runs should be made in such a manner that they will not be removed, changed, broken, or present a hazard.

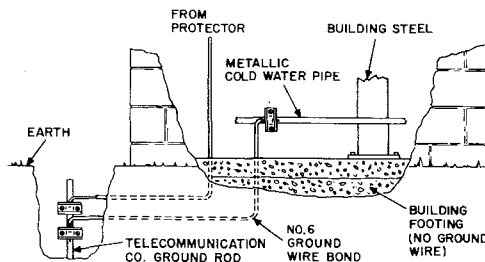

Fig. 34—Acceptable Protector Grounding Connections When Power Service Is Not Grounded, Power Service Grounds Not Accessible, or There Is No Power at Premises

6.09 See Table E for ground clamp selection. See Table F and Fig. 35, 36, and 37 for wire connectors. Connections to building steel may be made by using a B, C, or D insulator support (Fig. 38).

6.10 If the power ground wire is enclosed in metallic armor or conduit, the metallic armor or conduit may be considered as the grounding conductor when making connections.

6.11 The power service entrance conduit is the conduit through which the power service conduc-

tors feeding the premises enter the box containing the main breaker or fuse. Branch service conduit is the conduit through which electrical wiring leaves the breaker box to feed lighting, appliance, and receptacle circuits in the building. Branch service conduit is not an approved protector ground.

6.12 Where protectors are located so that running wire to a water pipe results in a shorter length of wire than if run to the power ground, the water pipe may be used **provided the water pipe is bonded to the power ground.**

TABLE E				
GROUND CLAMPS				
GROUND CLAMP	WIRE SIZE	GROUND ELECTRODE (SIZE IN INCHES)	USE	
B Station Ground Clamp	6-3/4 In. 12-1/2 In.	No. 12 or No. 10	3/8 — 1-3/4 1-7/8 — 3	Connect protector ground to water pipe or power service entrance conduit or mount 114A bracket
L Ground Clamp		No. 6	1 — 3	Connect protector ground or bond to water pipe or power service entrance conduit
C Ground Clamp		No. 6, 10, or 12	1/2 — 1	Connect protector ground or bond to ground rod or water pipe

TABLE F		
WIRE CONNECTIONS		
CONNECTOR	CONDUCTOR SIZE (AWG)	USE
H Connector	No. 12 thru 4 and 8 thru 1/0	Connect or bond ground wire to armored power ground wire or power ground wire
B Aluminum Connector AT-8984	No. 6 thru 12 copper to No. 1/0 thru 8 aluminum	Connect No. 6 thru 12 AWG copper ground wire to aluminum power ground wire for bonding

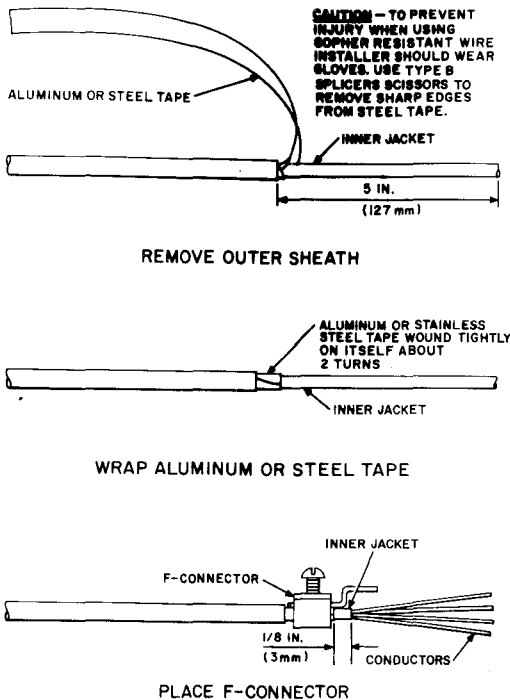

Fig. 35—Preparing 2-Pair Service Wire for Bonding of Metal Shield

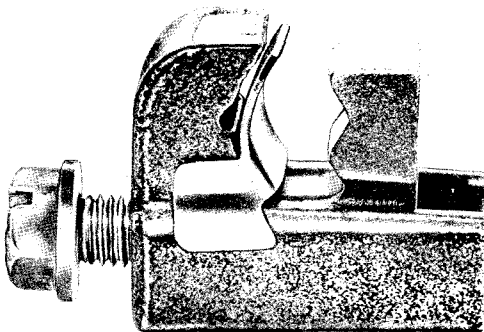

Fig. 36—H Connector

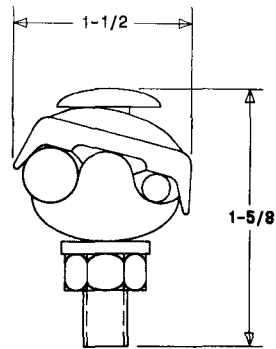
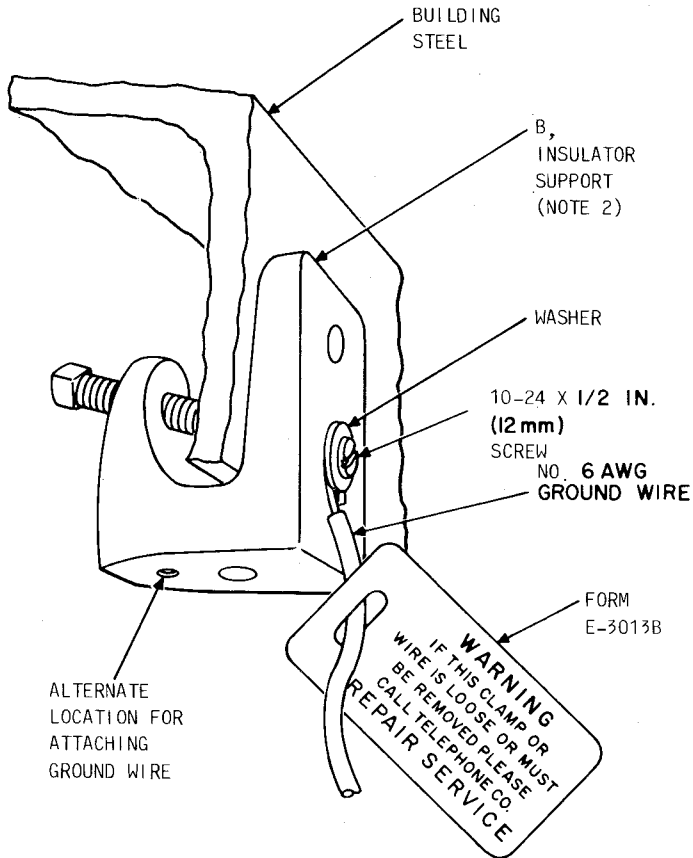

Fig. 37—B Aluminum Connector

6.13 Protectors located remotely from the power service may be grounded to metallic water pipe or to building steel *provided the water pipe or building steel is bonded to the power service ground.*

6.14 When installing a protector directly on a metallic water pipe or when connecting the protector ground wire to a water pipe, be sure there are no insulating joints, plastic sections, or plastic water meters in the water pipe on which the protector is to be mounted or the ground wire is to be connected. Avoid water pipes having meters, pumps, or valves that may be removed for maintenance. *Where such pipes must be used, install a bond (of No. 6 ground wire) around the meter, pump, or valve, so the continuity to ground will not be broken.* When these requirements are in doubt or conditions cannot be met, an alternate ground source must be provided (Table D).

6.15 Where it is necessary to multiple protector ground terminals, select the proper size ground wire for the number of protectors to be installed, including anticipated growth (Table B). Where more than one protector is installed, use the same size ground wire between protectors as used between the protector and the grounding electrode.



INSTALL AS FOLLOWS:

PLACE BOLT THROUGH INSULATOR SUPPORT, INSTALL BOTTOM NUT AND TIGHTEN. ATTACH INSULATOR SUPPORT TO BUILDING STEEL. PLACE WASHERS AND TOP NUT ON BOLT, REMOVE INSULATION FROM GROUND WIRE AND BEND BARE CONDUCTOR AROUND BOLT BETWEEN WASHERS. TIGHTEN TOP NUT.

NOTES:

1. BOLT, NUTS, AND WASHERS ARE NOT PROVIDED WITH INSULATOR SUPPORT.
2. THE B INSULATOR SUPPORT WILL ACCOMMODATE METAL FLANGES UP TO 1/2 INCH (12 mm)

Fig. 38—Grounding to Building Steel

- 6.16 A continuous length of ground wire should be used for a protector ground.
- 6.17 Refer to Practice 461-200-205 for sleeves for splicing ground wire and sleeve pressing tools required.
- 6.18 Form E-3013B (Fig. 39) should be placed at all ground wire terminations to warn people not

to disturb clamps or wire.

- 6.19 The B station ground clamp (Fig. 40) is installed as follows:

- (1) Clean pipe thoroughly with emery cloth.
- (2) Back off locknut to head of setscrew.
- (3) Back off setscrew until it does not protrude through the soldered nut.
- (4) Place Form E-3013B on strap. Bend strap around pipe and place strap on the rivet using hole in strap that provides the least slack.
- (5) Bend strap sharply at next hole beyond rivet.
- (6) Tighten setscrew. If the setscrew is tightened excessively, the clamp will break or setscrew will slip off center and copper pipe may be dented. When fastening clamp to copper pipe, avoid making a dent in the pipe that is more than barely perceptible.

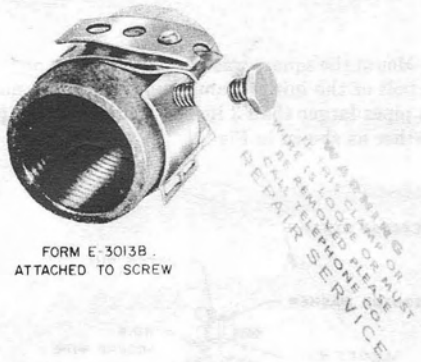
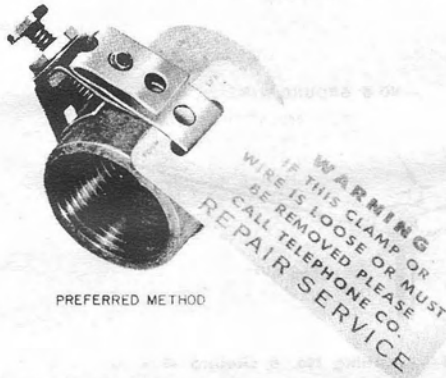

Fig. 39—Form E-3013B Attached to B Station Ground Clamp

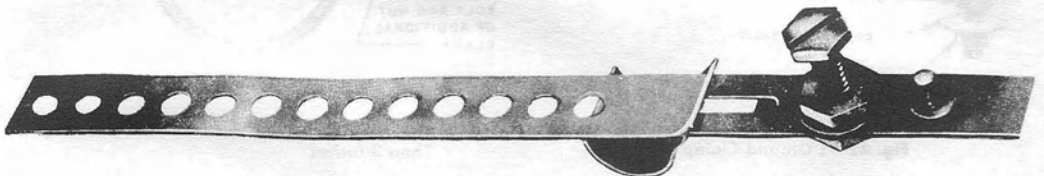

Fig. 40—B Station Ground Clamp

- (7) Place ground wire under the washer and tighten locknut (Fig. 41).

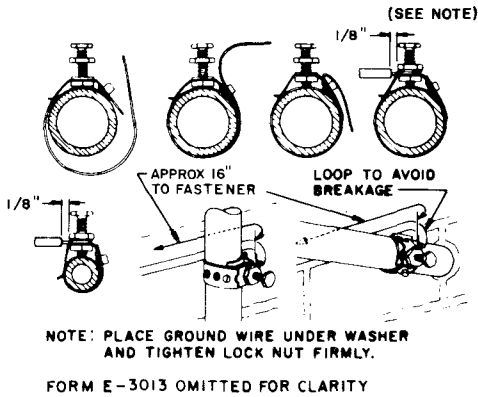

Fig. 41—Installing B Station Ground Clamp

6.20 The L ground clamp (Fig. 42) is used to terminate No. 6 ground wire. It is installed as follows:

- (1) Clean pipe thoroughly.
- (2) Remove approximately 1 inch of insulation from the ground wire and clean conductor.
- (3) Remove the lower nut and the square washer from the bolt of the ground clamp.

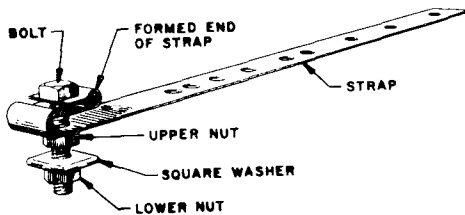

Fig. 42—L Ground Clamp

- (4) Insert the ground wire conductor into the smaller loop of the ground clamp and secure it by tightening the upper nut on the bolt and attach Form E-3013B (ground wire tag).

- (5) Bend the strap around the pipe and engage the bolt with the farthest possible hole from the end of the strap (Fig. 43).

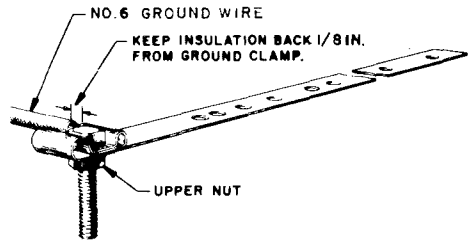

Fig. 43—Attaching No. 6 Ground Wire to L Ground Clamp

- (6) Mount the square washer and lower nut on the bolt of the initial clamp and tighten the nut. (On pipes larger than 3 inches, fasten two straps together as shown in Fig. 44)

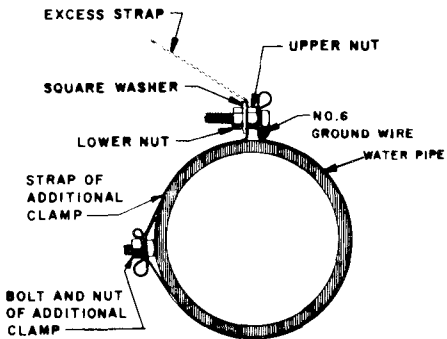

Fig. 44—Attaching L Ground Clamps to Pipes Larger Than 3 Inches

(7) Break off excess strap at the square washer and cut off excess length of bolt if it interferes with the installation of the clamp or projects in a hazardous manner (Fig. 45). (See Fig. 46 for typical installations of L ground clamp.)

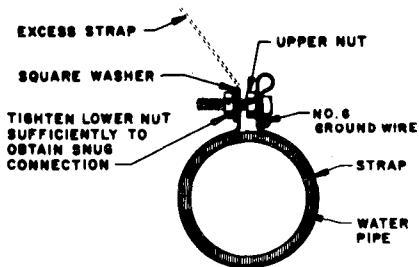

Fig. 45—Attaching L Ground Clamp to 3-Inch and Smaller Pipe

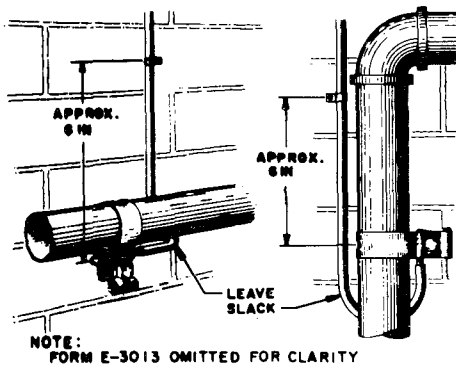

Fig. 46—Typical Installation—L Ground Clamp

(8) Attach Form E-3013B.

6.21 The C ground clamp (Fig. 47) is installed as follows:

(1) Clean pipe, conduit, or ground rod thoroughly.

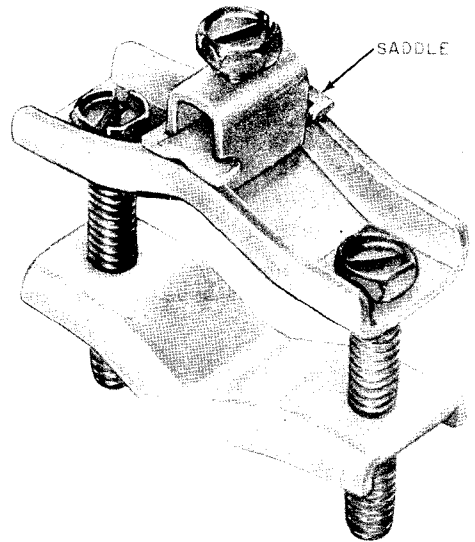

Fig. 47—C Ground Clamp

(2) Remove approximately 1 inch of insulation from ground wire and clean conductor.

(3) Insert bare end of ground wire under the clamp saddle. Do not place wire directly on the screw.

(4) Tighten the upper screw snugly.

(5) Place clamp over ground electrode.

(6) Place Form E-3013B over machine screw.

(7) Tighten both mounting screws firmly.

6.22 Locate ground clamps at accessible points where they will not be subject to excessive movement, vibration, or damage. Where a pipe is not firmly secured or is subject to vibration, tape the ground wire to the pipe in close proximity to the ground clamp.

6.23 The shield or armor of a small diameter cable, service wire, or underground wire is connected to the ground terminal of a station protector using an F connector. The F connector has a spade tip which can be placed under the pronged washer of the protector ground terminal. The method for installing the connector on the shield of buried service wire (BSW) and connecting service wire to a protector is shown in Fig. 35 and 48.

7. SIGNALING GROUND

7.01 Where a signaling ground is required, the protector ground should be used as a first choice.

At unexposed stations where there is no protector and telephone apparatus is connected to a telephone company-provided power unit (operated from a commercial power source), the signaling ground should be connected to the power unit ground or to a ground that is bonded to the commercial power ground (Table D). Where there is no protector and the telephone apparatus is not associated with commercial power, any ground suitable for a protector ground should be used (Table D). The shield of a buried service wire or cable may also be used.

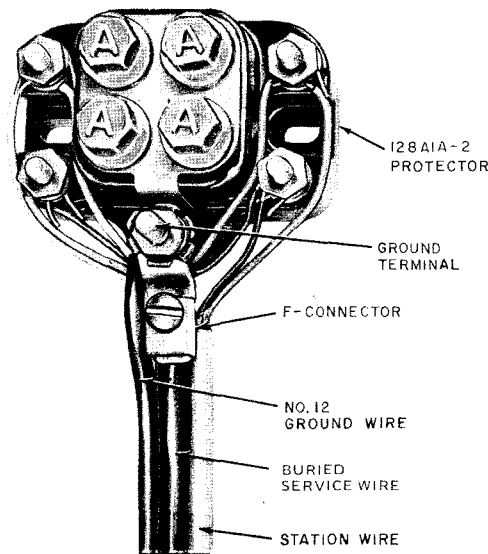

Fig. 48—Service Wire on Protector

7.02 Ground strips (Table G) are available to provide signal ground terminals (or binding posts) in cable closures, cable terminals, cable terminal sections, or terminal boxes. Where the ground strips are mounted in terminals or on surfaces that are not grounded to a cable sheath or by a separate ground wire, it is necessary to install a No. 12 ground

wire from the ground strip to an acceptable ground electrode (Table D).

7.03 The 2A ground strip (Fig. 49) consists of a brass plate with two binding posts. The plate

TABLE G				
GROUND STRIPS				
TYPE	BINDING POSTS	TERMINALS	WIRE CAPACITY (QUANTITY)	USED WITH
2A	2	—	14	199-type protector
2B	2	—	14	30- and 31-type connecting blocks
4A	2	11	11	102B adapters when installed with connecting blocks
4B	2	16	16	102C adapters when installed with connecting blocks
4C	2	26	26	102D adapters when installed with connecting blocks
5A	2	—	10	10- and 16-pair NC, NF, and NH cable terminals
6A	2	—	10	26-pair NC, NF, and NH cable terminals

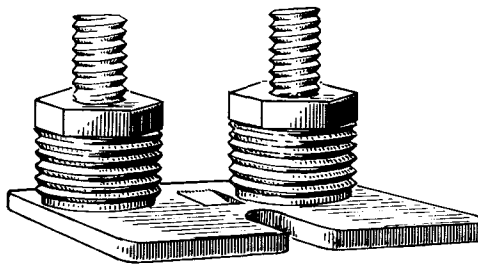

Fig. 49—2A Ground Strip

has a U-shaped slot for a mounting screw and a depressed tab which prevents the ground strip from turning after it is installed. The 2A ground strip has

a capacity of 14 wires. The 2A ground strip installed in a 199A1A50-100 protector is illustrated in Fig. 50.

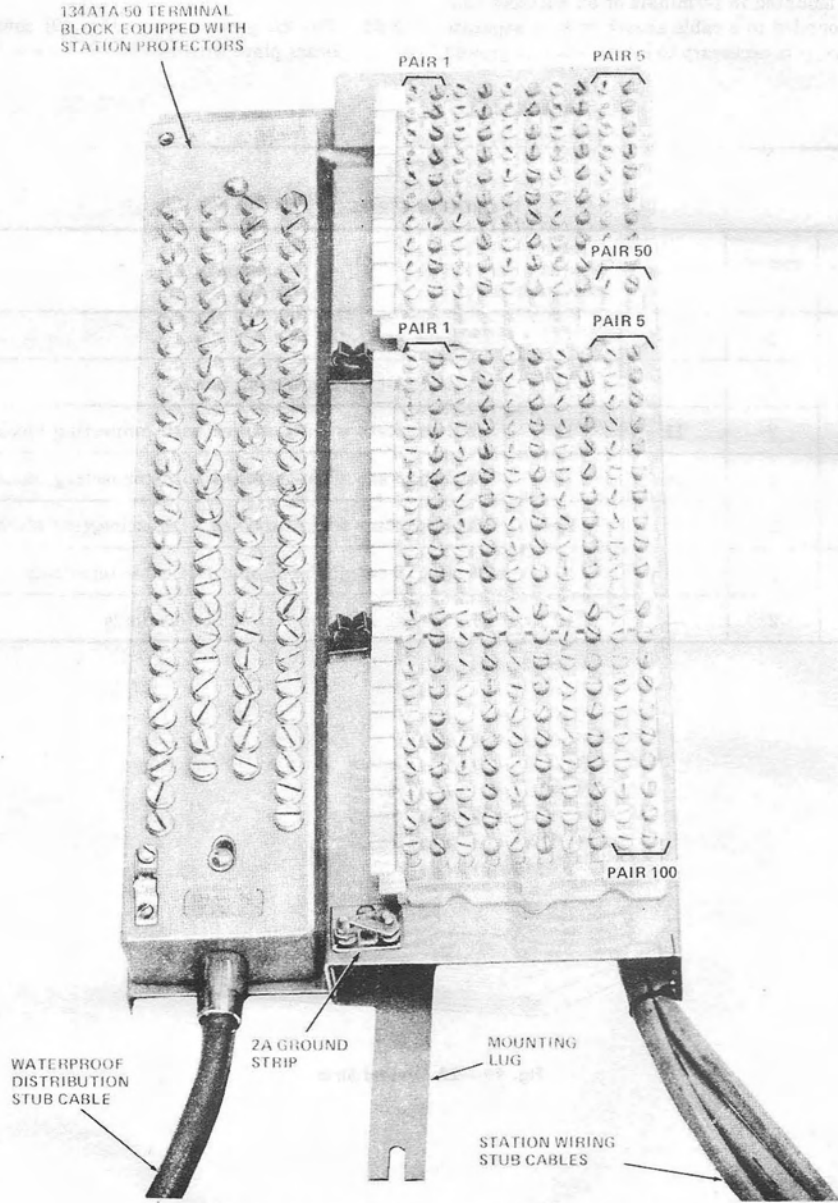

Fig. 50.—2A Ground Strip Installed on 199-Type Protector

7.04 The 2B ground strip (Fig. 51) consists of an assembly of the 2A ground strip and a mounting bracket (Table G). See Fig. 52 for a typical installation of the 2B ground strip.

7.05 The 4-type ground strips are angular-metal brackets equipped with terminal screws and

two binding posts. They are used with 102-type adapters when installed with connecting blocks (Table G). See Fig. 53, 54, and 55 for typical 4-type ground-strip installations.

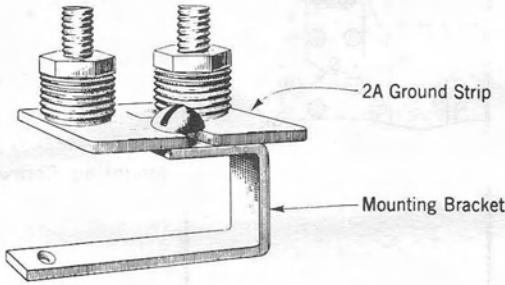

Fig. 51—2B Ground Strip

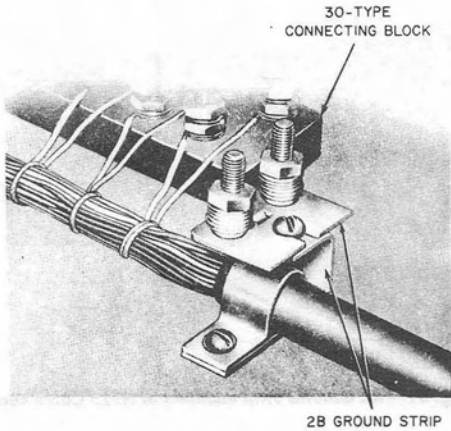

Fig. 52—Typical Installation of 2B Ground Strip

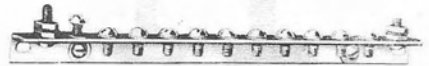

Fig. 54—4A Ground Strip

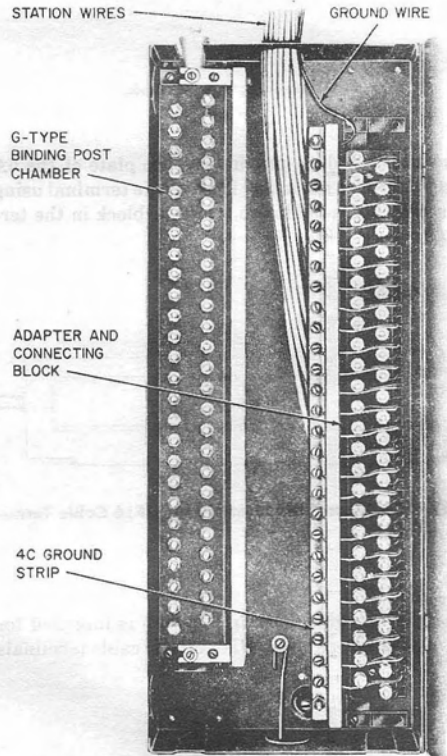

Fig. 55—Typical Installation of 4C Ground Strip

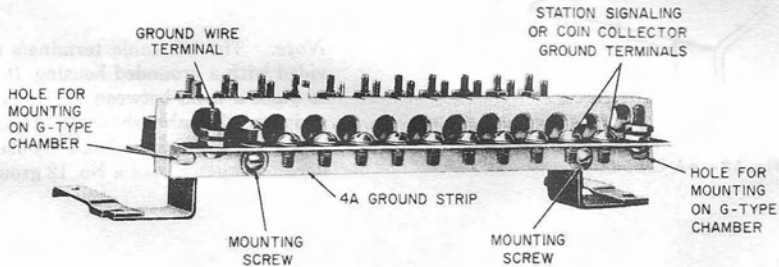

Fig. 53—Typical Installation of 4A Ground Strip

7.06 The 5A ground strip (Fig. 56) is intended for use in 10- and 16-pair NC, NF, and NH cable

and is mounted in the same manner as the 5A strip (Fig. 59).

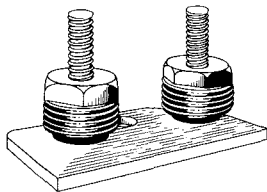

Fig. 56—5A Ground Strip

terminals. A hole is provided in the plate of the 5A ground strip for mounting it in a cable terminal using the screw which holds the terminal block in the terminal housing (Fig. 57).

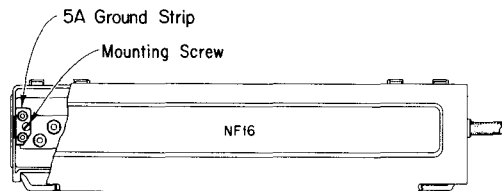

Fig. 57—5A Ground Strip Installed in NF16 Cable Terminal

7.07 The 6A ground strip (Fig. 58) is intended for use in 25-pair NC, NF, and NH cable terminals

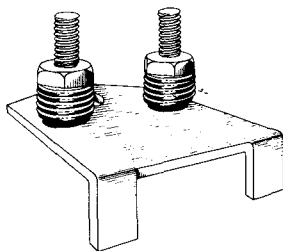

Fig. 58—6A Ground Strip

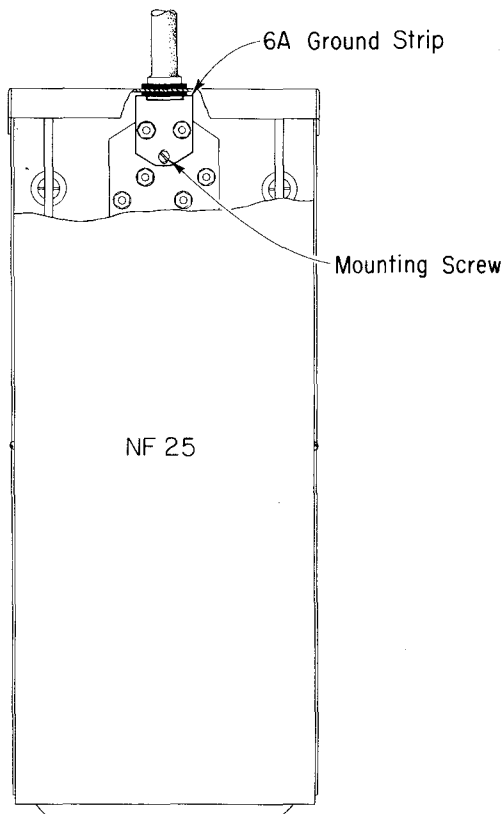

Fig. 59—6A Ground Strip Installed in NF25 Cable Terminal

Note: The NF cable terminals are not provided with a grounded housing. It is necessary to place a bond between the 5A or 6A ground strip and the cable sheath (or to an acceptable ground as outlined in Table D) using a ground wire no smaller than a No. 12 ground wire.

8. COIN STATION GROUND

- 8.01 The protector ground should be used as first choice for a coin-station ground.
- 8.02 At unexposed coin stations where there is no protector, any ground that is suitable for a protector ground may be used as a coin ground (Table D).
- 8.03 Outdoor coin telephones are installed on metal shelves, metal mountings, or in metal booths. If the associated protector ground terminal is not already bonded to the shelf, mounting, or booth, this bond must be made using a No. 12 ground wire.
- 8.04 When a coin telephone is installed outdoors, a ground rod for protector grounding must be installed unless:
- (1) At least 10 feet of buried metallic conduit is connected to the coin shelf, mounting, or booth
 - (2) The power ground rod of a power system is bonded to the coin shelf, mounting, or booth with a ground wire no smaller than a No. 6 ground wire
 - (3) An acceptable metal water pipe is bonded to the coin shelf, mounting, or booth with a ground wire no smaller than a No. 6 ground wire.



The grounding conductor (third wire of an electrical wiring system) must never be used as the protector ground.

9. LOCATING AND INSTALLING GROUND RODS

- 9.01 **DANGER:** Avoid personal injury by protecting eyes and hands when driving ground rods. Wear safety glasses and rubber gloves with leather protectors. Rubber gloves with leather protectors must be worn when driving a ground rod. Avoid bodily contact with the ground rod during this operation. On completion of driving a ground rod, a voltage tester, e.g., 188A test set (Stop Lite) or B-voltage tester, **must** be used to verify that no voltage condition exists on the ground rod. (Rubber gloves must be worn to test ground when B-voltage tester is used.) If voltage is detected, **do not proceed** until the supervisor is notified and the condition corrected.



Check with property owner or manager regarding the location of any underground electric power cable, water, gas, or fuel tank installations before driving a ground rod.

9.02 Locate and install ground rods as follows:

- (a) Where least likely to be damaged or tampered with
- (b) As near as practical to masonry walls in earth-floor basements
- (c) Approximately 12 inches from outside walls (Fig. 60)

- (d) Approximately 2 feet from base of wooden poles or posts where conditions permit
- (e) At least 6 feet from power or lightning protection ground rods.

9.03 Drive ground rods until the top of the rod is approximately 3 inches below ground level. Increase depth where digging is likely. Use the AT-8911 B trenching tool (a folding shovel), or other suitable shovel, to excavate ground to obtain the 3-inch depth.

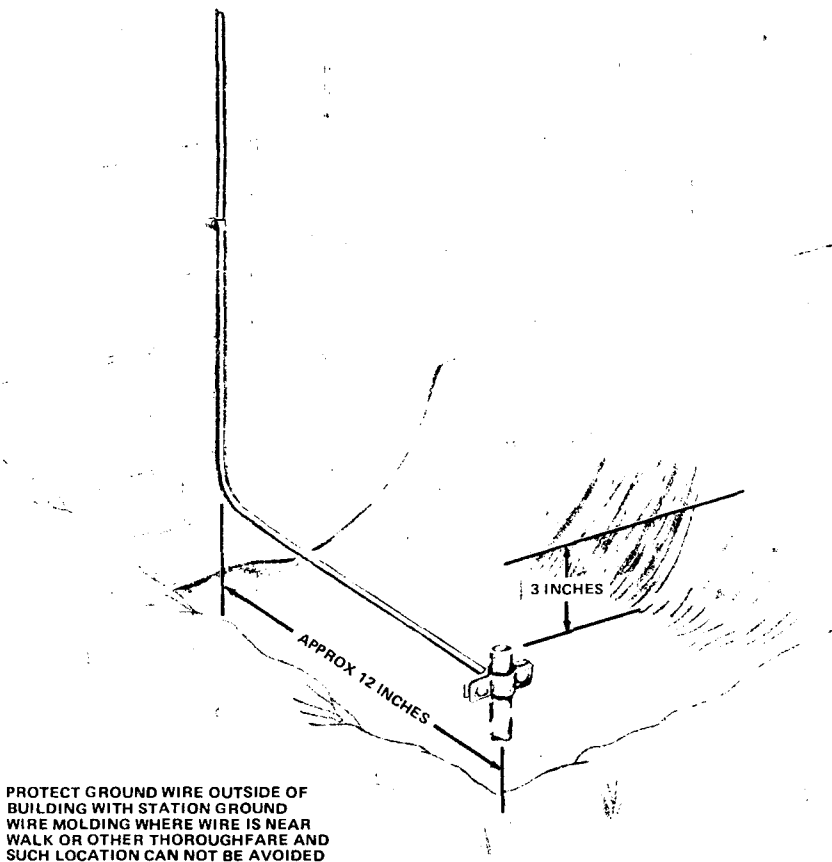

Fig. 60—E Ground Rod Installed Near Wall

9.04 Avoid making ground wire runs where the wire may be damaged or tampered with. If such locations cannot be avoided, protect the ground wire with station ground wire molding.

9.05 Use a C ground clamp for installing ground wire to E ground rod.

9.06 When two or more protectors requiring ground rods are installed at the same location, proceed as follows:

- (a) If a power ground rod is not available, install a ground rod for each protector. Bond all protectors together. Select wire connectors from Table F. No more than three ground rods need be placed. Space ground rods at least 6 feet apart (Fig. 61).

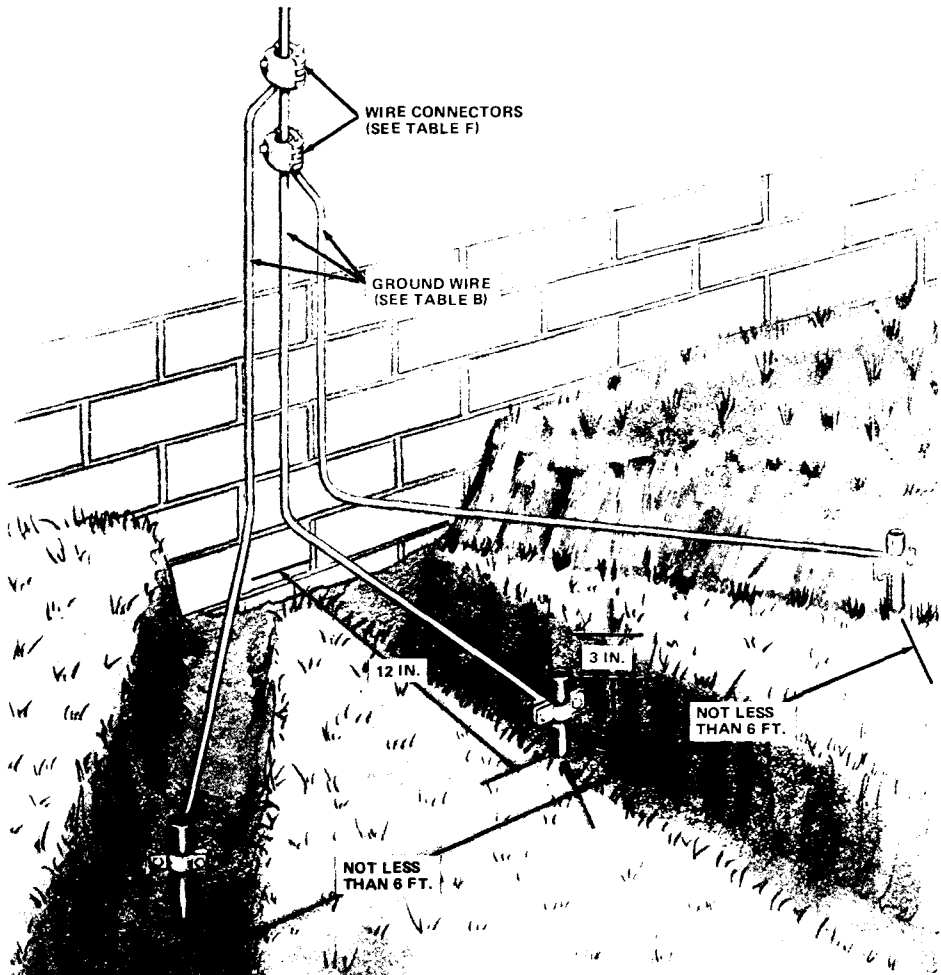

Fig. 61—Three Ground Rods

(b) If a power ground rod is available, one telephone ground rod is sufficient. Bond all protectors together and bond telephone ground rod to power ground rod.

Note: Use the proper size station ground wire as listed in Table B.



Telephone and power grounding systems must be bonded together to prevent arcing and shock hazard between telephone and power wiring during lightning or power cross conditions.

9.07 Multiple station protectors, such as the 116 or 117 type, should not be connected to a single telephone ground rod unless the rod is bonded to the power system ground rod. If a power system ground rod is not available, a multiple station protector may be connected to an array of three telephone ground rods, spaced at least 6 feet apart, and bonded together with No. 6 ground wire (Fig. 61).

9.08 Always bond ground rods using a No. 6 ground wire.

10. INSTALLING SNEAK CURRENT FUSES

10.01 Sneak current is foreign current caused by a "cross" with or induction from power conductors. The sneak current is too low to burn open fusible links of wire or cable and of insufficient voltage to arc over protector blocks or protector units.

10.02 Sneak current protection is provided by the use of heat coils or 60A and 60D fuses in a variety of mountings.

10.03 The 60A and 60D fuses (Fig. 62) are rated 0.350 ampere and differ only in arrangement

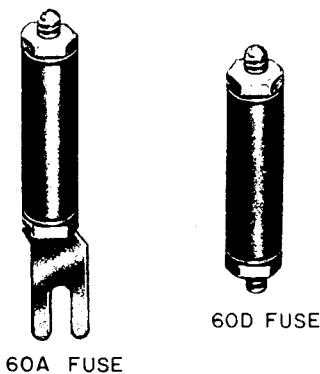

Fig. 62—60A and 60D Fuses

for mounting. The 60A fuse has a spade terminal and is used with the 94A protector mounting (Fig. 63).

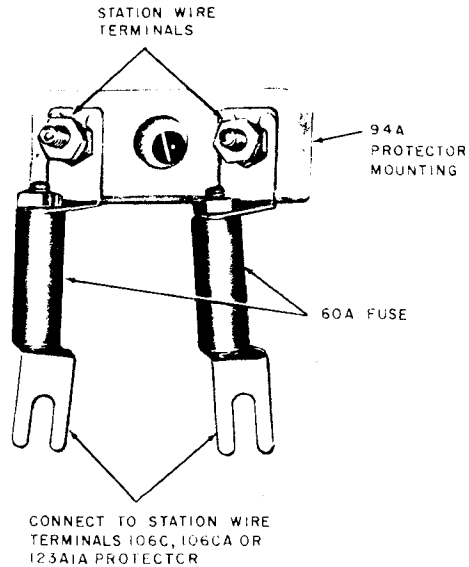

Fig. 63—60A Fuses Connected to 94A Protector Mounting

The 60D fuse is mounted in a 1094A protector (Fig. 64), or 191A1-20 protector (Fig. 65).

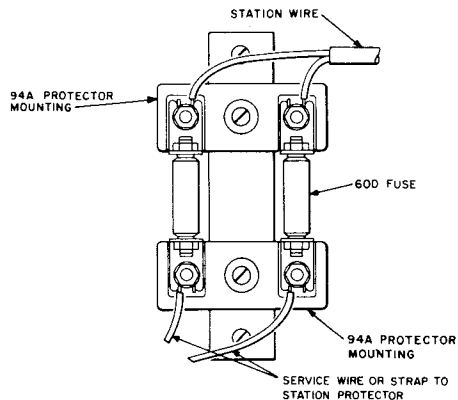

Fig. 64—1094A Protector

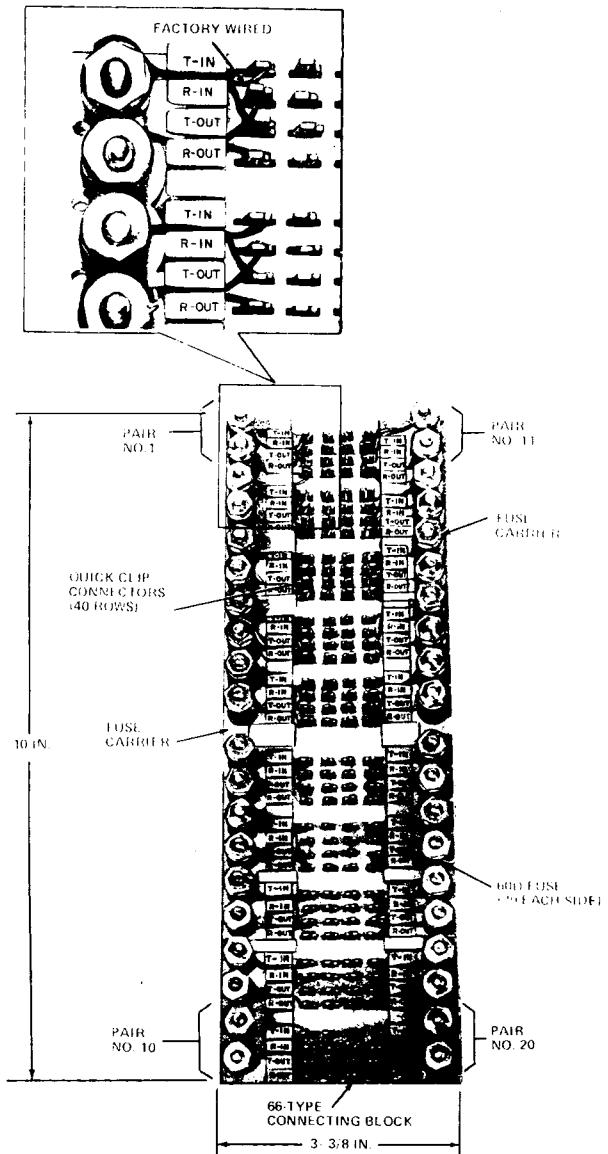

Fig. 65—191A1-20 Protector

10.04 1094A Protector: The 1094A protector (Fig. 64) consists of a metal base with two No. 94A protector mountings and two 60D fuses.

10.05 191A1-20 Protector: The 191A1-20 protector (Fig. 65) is a combination protector and terminating field intended for use with 66-type quick-connect hardware.

10.06 The base of the 191A1-20 protector is identical to the 66-type connecting block allowing the protector to be mounted on an 89B bracket.

10.07 A wiring diagram of the 191A1-20 protector is shown in Fig. 66. Pairs requiring sneak

10.08 Replacing a fuse in the 191A1-20 protector is shown in Fig. 67 and 68.

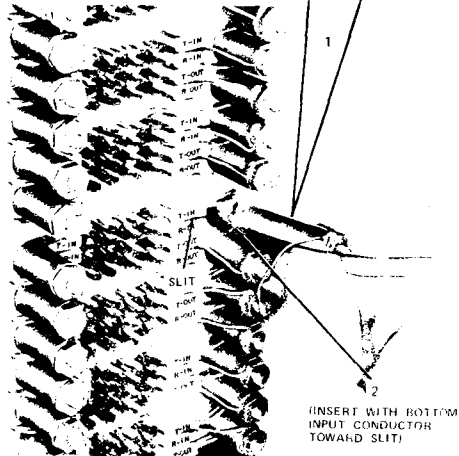
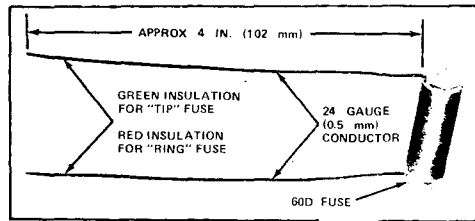

Fig. 67—Replacing Fuse

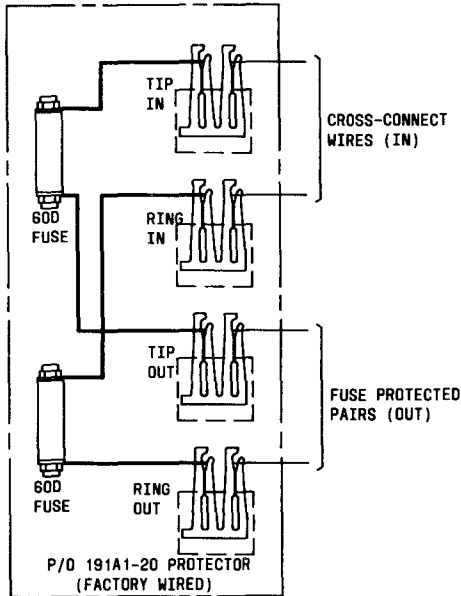

Fig. 66—191A1-20 Protector—Wiring Diagram

current protection are cross-connected to the 191A1-20 protector as indicated (TIP IN, RING IN). Factory wiring is provided through the fuses to TIP OUT and RING OUT connectors.

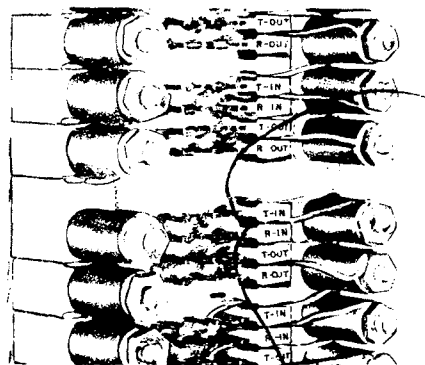

Fig. 68—Fuse Replaced

11. EXPOSED DROP WIRES CONNECTED TO UNEXPOSED CABLE

11.01 Drop wires connected to an unexposed cable terminal and extending into an exposed area expose both the subscriber station and the distribution cable. To avoid changing the status of the unexposed cable, protectors are required at the junction of the drop wire and the cable.



It is extremely important that telephone technicians be informed of locations where protectors are required. If service orders do not specify protection required or the cable terminals are not specifically identified, local instructions must provide this information. Where there is any doubt on the part of the telephone technicians, all drop wire must be treated as exposed.

11.02 Where an exposed drop wire is to be connected to an unexposed pair of 19- or 22-gauge cable, a fusible link of bridle wire is required between the cable pair and the drop wire in addition to the protector. In addition, a fusible link is required between the exposed section and a fuseless station protector. Otherwise, a fused protector must be used.

11.03 Typical wall and pole installations, using protectors for cable protection, are shown in Fig. 69, 70, 71, 72, and 73.

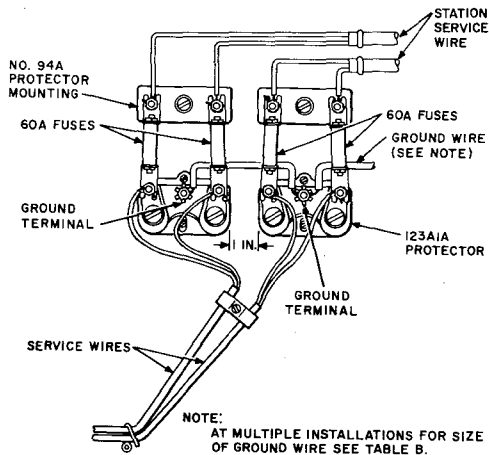

Fig. 69—Fuseless Protectors

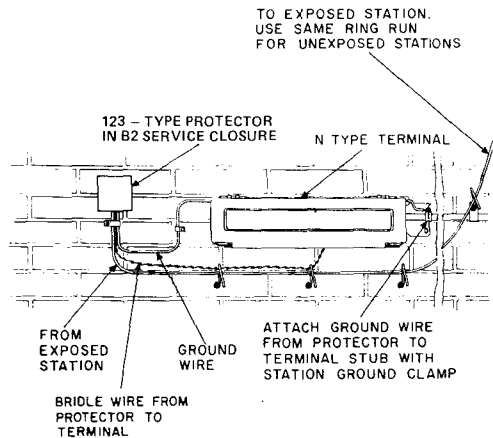

Fig. 70—N-Type Terminal, Wall Installation

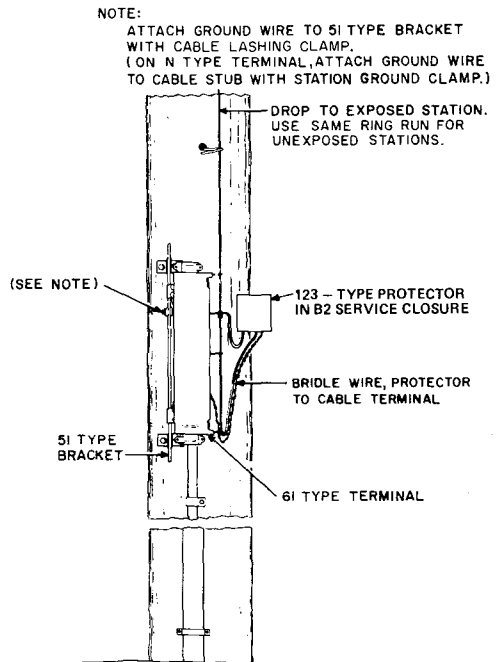

Fig. 71—N- or 61-Type Terminal, Pole Installation

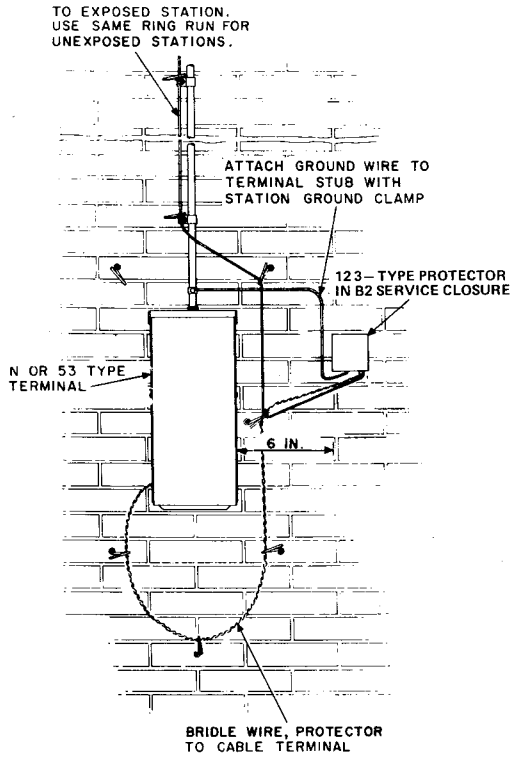

Fig. 72—N- or 53-Type Terminal, Wall Installation

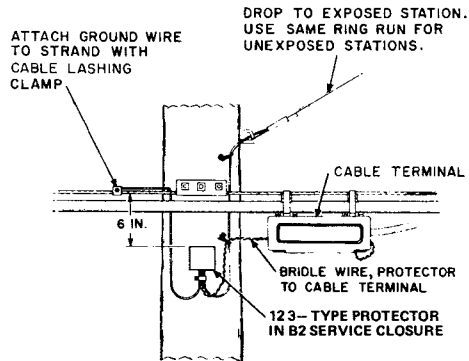

Fig. 73—N-Type Terminal, Strand Mounted

12. 118B PROTECTOR

12.01 The 118B protector (Fig. 74), which supersedes the 99C protector, is designed to protect telephone circuits in the event of an accidental contact between power wires (of the MGN-type and

carrying over 2900 volts) and telephone wires. Three 14-gauge insulated wire leads extend from the bottom of the protector. One lead is connected to ground (of the MGN power) and two leads are connected to the telephone line wires.

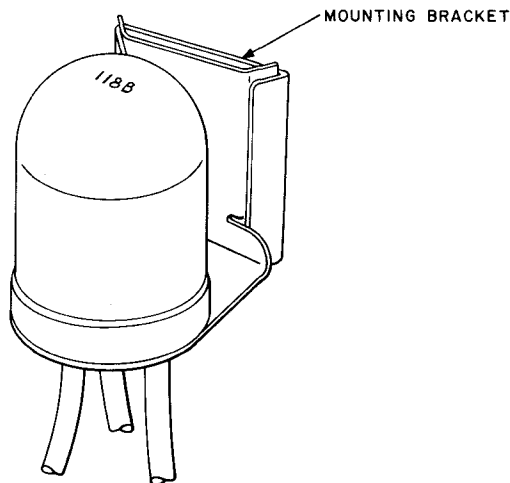

Fig. 74—118B Protector

12.02 The 118B protectors are connected to drop wires (Fig. 75) or rural wires (Fig. 76) as specified by detailed plans or telephone company engineering or supervisory instructions. The 118B protector provides protection for a single drop wire or rural wire. The length of a drop wire or rural wire run may dictate the installation of additional protectors on the same drop wire or rural wire.

12.03 Drop wires and rural wires placed on higher voltage (over 2900 volts) joint-use poles do not require a 118B protector:

- Where wire runs (including branch runs) are 1000 feet or less in length
- Where wire runs are attached directly below aerial cables supported by effectively grounded strands.

12.04 Refer to Practice 462-525-150 for additional information and illustrations for installing the 118B protector on rural wire.

12.05 Do not remove 118B protectors from dead circuits on joint-use poles.

12.06 ***DANGER: The power vertical grounding conductor shall be tested with a 188A test set (Stop Lite) or a B-voltage tester as described in Practice 081-705-102 or 081-705-101, respectively, before making the following connection.*** It is preferable to connect the ground wire of the 118B protector to a power vertical grounding conductor that is connected to both the power system multigrounded neutral wire and to a ground electrode. Grounding conductors on transformer poles which meet this requirement are satisfactory. ***Grounding conductors from power lightning arresters shall not be used unless they are connected to the power neutral wire.*** Where local instructions and the power company permit, the connection between the ground lead of the 118B protector and the vertical grounding conductor may be made by telephone company personnel.

12.07 Where the power company has installed an aluminum vertical grounding conductor, do not use an H connector due to the likelihood of corrosive chemical reaction between copper and aluminum. Make the grounding connection to an aluminum vertical grounding conductor with a B aluminum connector.

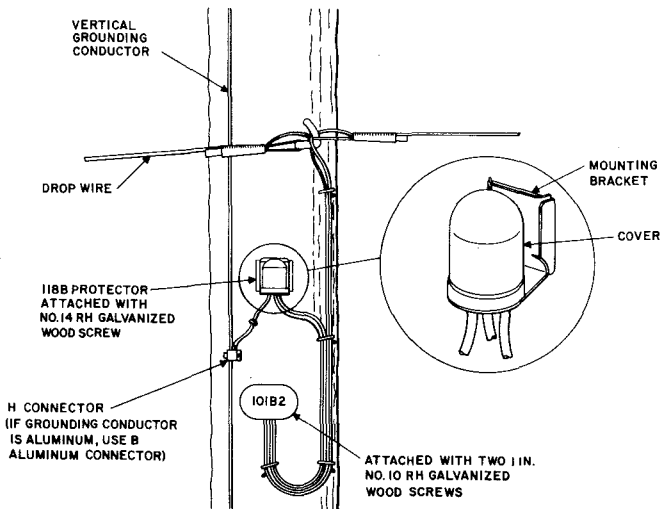

Fig. 75—118B Protector Connected to Drop Wire

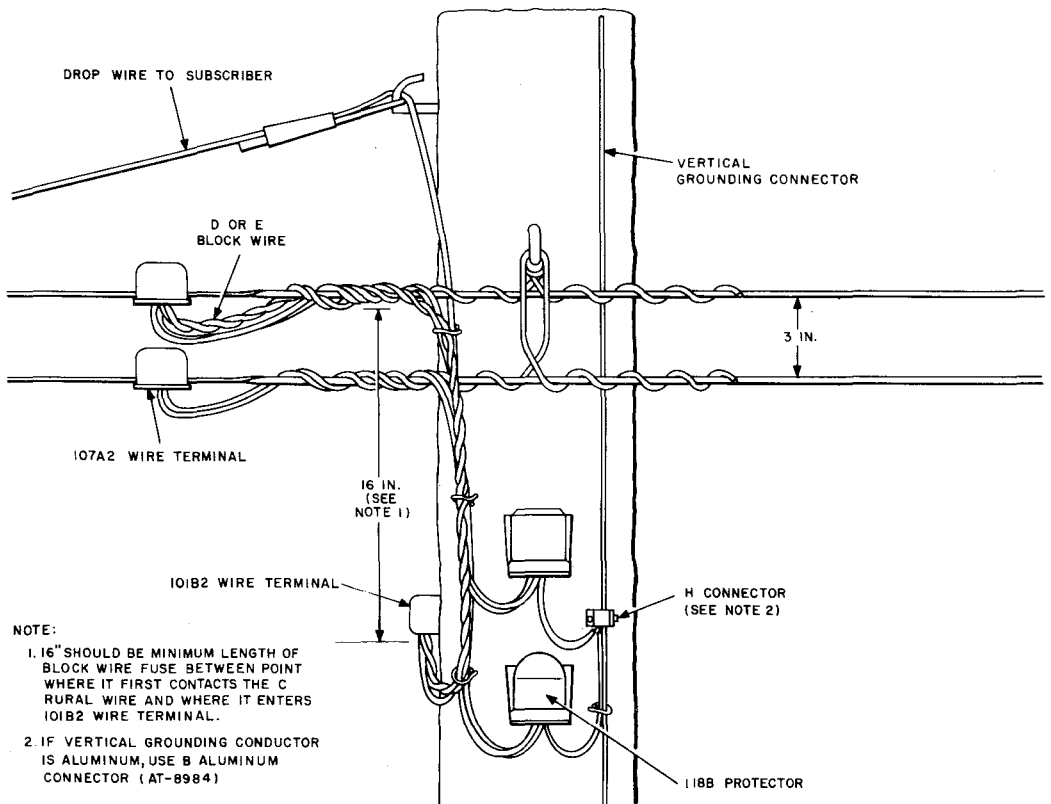

Fig. 76—118B Protector Connected to Rural Wires

12.08 When a 118B protector is to be installed at locations where there are no power system vertical grounding conductors, install a ground rod at the base of the pole and run a No. 6 ground wire from the ground rod to the top of the telephone space and leave coiled at that point an additional length (usually about 6 feet) sufficient to reach the power neutral wire. **Power company personnel shall make the connection to the power neutral wire.** Report all such installations to the supervisor immediately so arrangements may be made to have the grounding conductor connected to the power neutral as soon as practical.

12.09 DANGER: Avoid personal injury by protecting eyes and hands when driving ground rods. Wear safety glasses and rubber gloves with leather protectors. Do not perform any work in the power company space on the pole. To install a ground rod and vertical grounding conductor:

- (a) Drive an E ground rod about 2 feet from the base of the pole with the top of the rod at least 3 inches below ground level. The AT-8911B trenching tool (a folding shovel) or equivalent should be used. The ground rod should be located

so the grounding conductor may be run on the side of the pole reserved for power company attachments.

- (b) Connect the vertical grounding conductor (No. 6 ground wire) directly to the ground rod with a C ground clamp.
- (c) Fasten the grounding conductor to the pole at 18-inch intervals with 1-1/4 inch B staples.
- (d) Where ground wire molding is used, fasten it to the pole with cable straps and strap nails at 4-foot intervals.

12.10 The 118B protector is self-cleaning and generally should require no maintenance. It is possible, however, that an operation will cause the cover to be blown off or to rupture. When working on drop wires or rural wires connected to such a damaged protector, notify the supervisor or proceed according to local instructions.

13. CONVERTING PROTECTORS

13.01 *Caution: When converting station protectors on SSM (special safeguarding measures) and/or SSP (special service protection) lines, arrangements must be made to have the special lines taken out of service before doing any work on the protector, since this work could readily cause service interruptions.* Fused protectors at stations not subject to conditions, as outlined in paragraph 3.01, should be converted to fuseless operation or replaced by the 123- or 128-type protectors.

13.02 The 98A (DA) protector can be converted to fuseless operation by adding two 121A adapters and two 213A connectors (Fig. 77) as follows:

- (1) Disconnect line wires.
- (2) Remove cap and protector blocks.
- (3) Insert the 121A adapters all the way into the protector well with the flat side against the ground electrode.
- (4) Check for ground at all protector terminals.
With the protector blocks removed, the adapter should provide solid ground to the terminals.

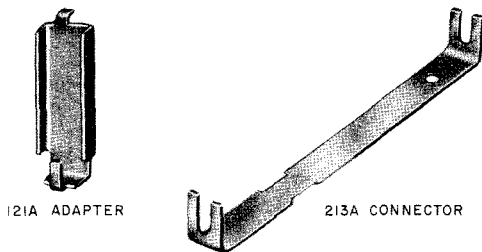

Fig. 77—121A Adapter and 213A Connector

Note: A check for ground may be made using the 1013A hand test set. With the TALK/MON switch of the test set in the TALK position, connect one cord clip to the ring side of the (working) line wire and, with the other cord clip, tap each line terminal of the protector. A pronounced click will be heard in the test set receiver when protector terminals are grounded.

- (5) Remove adapters from protector well and assemble each adapter with a No. 26 and a No. 27 protector block.
 - (6) Install assemblies in protector well. Check for grounds; line terminals should not be grounded.
 - (7) Where requirements of Steps (4) and (6) are not met, discard adapters and replace with other adapters. If requirements cannot be met on the second attempt, do not try to convert the protector; install a 123-, 125E-, or 128-type protector instead. Do not attempt to bend or adjust the adapter tabs or protector block springs.
 - (8) Reinstall cap.
 - (9) Connect line wires, using care not to reverse tip and ring.
- Note:** The line wire may be moved to the station side of the protector if it is of sufficient length. If not, proceed to next step.
- (10) Loosen nuts on 11C fuses.
 - (11) Insert 213A connectors over each fuse with end inside fuse clips. In cases where fuses have shrunk slightly, one or both connector ends

may be placed outside of fuse clips. Some bowing of the connectors is not considered objectionable.

(12) Tighten nuts on fuses (Fig. 78).

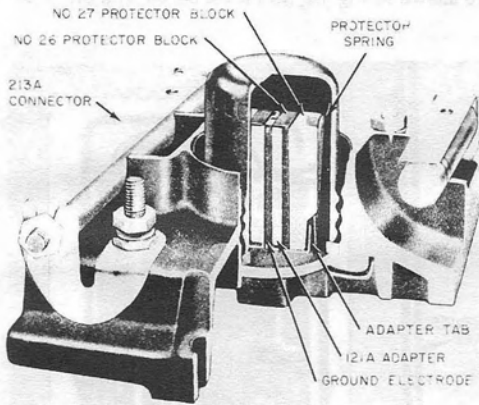

Fig. 78—Converted 98A (DA) Protector

13.03 The 106C protector may be converted to fuseless operation by connecting the aerial or buried drop input line wires directly to the station side of the protector, provided the line wires are of sufficient length. The fuses may then be removed (Fig. 79). Where the input line wires are too short to

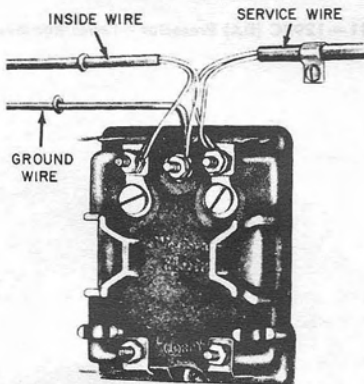

Fig. 79—Alternate Method of Converting 106C Protector

reach the station side of the protector, install two 213A connectors as described in paragraph 13.02(11). The 106C protector is equipped with 2B2A protector units and adapters are not required (Fig. 80).

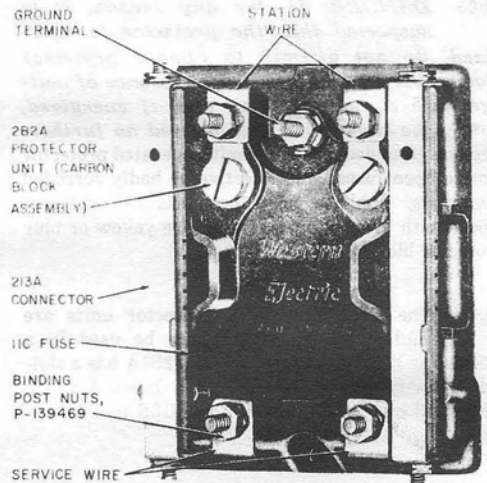

Fig. 80—Converted 106C Protector

13.04 The 106A (DA) protector cannot be converted to fuseless operation because of insufficient current-carrying capacity.

14. MAINTENANCE

14.01 When making station visits, inspect the telephone grounding system. If the protector is not grounded in accordance with Table D, change the ground conductor. **Make sure the protector ground and power service ground are bonded together.** If the protector and power are grounded to separate ground rods, make sure the ground rods are bonded together. If there is no power on the premises, ensure that the telephone ground is bonded to metallic water pipe.

14.02 Inspect the telephone ground wire, ground clamps, and connectors for broken or disconnected wires or loose connections. Replace hardware if defective, damaged, or badly corroded. Make sure the ground wire tag (Form E-3013B) is in place.

Note: It is not necessary to replace No. 14 (DA) ground wire in existing installations unless it is defective or used to ground more than one station protector.

14.03 DANGER: *If, for any reason, it is suspected that the protector is energized, do not attempt to remove protector blocks. Verify the presence or absence of voltage with a voltage tester and, if energized, notify the supervisor and proceed no further.* Replace grounded protector units, operated protector blocks, open fuses, and defective or badly corroded protectors. Replace protector units or protector blocks with proper types. Do not use yellow or blue protector blocks.

14.04 The 2B1A and 2B2A protector units are equivalent and either may be used in a 123A1A or 128A1A-2 protector. The 2B1A has a slotted, screw-type cap while the 2B2A has a 3/8-inch hexagonal cap which requires the 216B tool for removal.

14.05 The 123B1A (DA) protector uses two 6B1A (gas tube) protector units in parallel with two 2B2A (carbon) protector units. When replacing protector units in the 123B1A protector, be sure to install the 2B2A protector units in the wells marked "CARBON ONLY."

14.06 The 111A (DA) protector uses 2A1A protector units instead of the 2B1A or 2B2A protector units.

15. SUPERSEDED ITEMS

15.01 Illustrations of superseded protectors, mountings, connecting blocks, and brackets are shown in Fig. 81, 82, 83, 84, 85, 86, and 87.

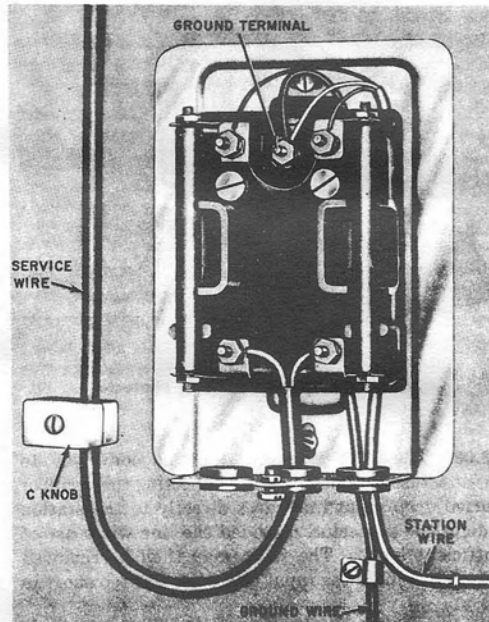

Fig. 81—1293C (DA) Protector—Cover Removed

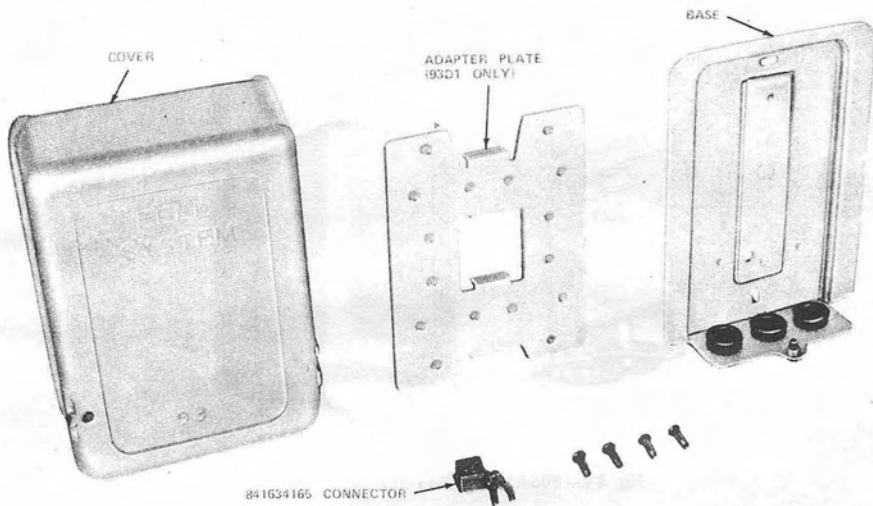

Fig. 82—93C (DA) and 93D (DA) Protector Mounting

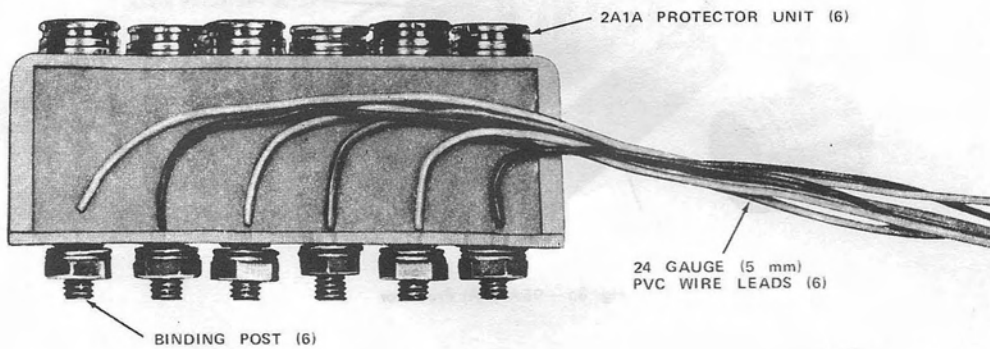

Fig. 83—6A3A (DA) Terminal Block

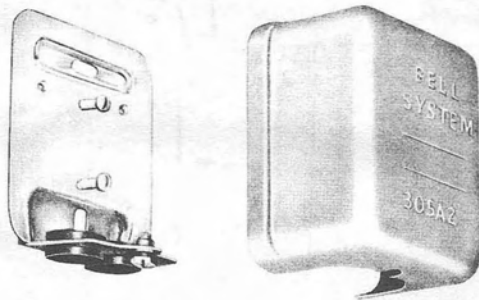

Fig. 84—305A2 (DA) Protector Mounting

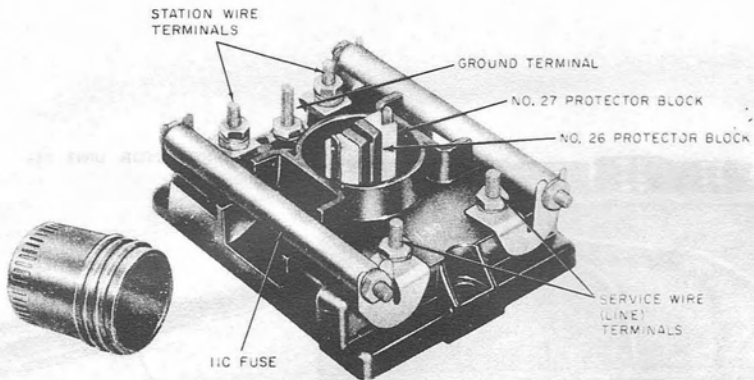

Fig. 85—98A (DA) Protector

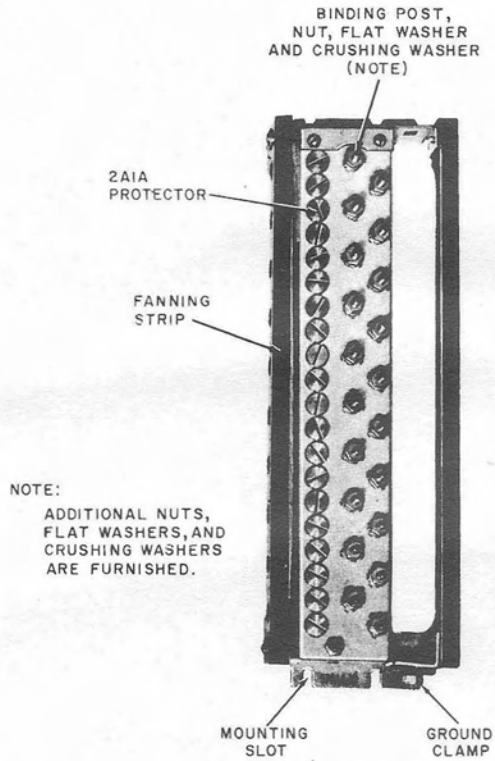

Fig. 86—57B1A-10 (DA) Connecting Block

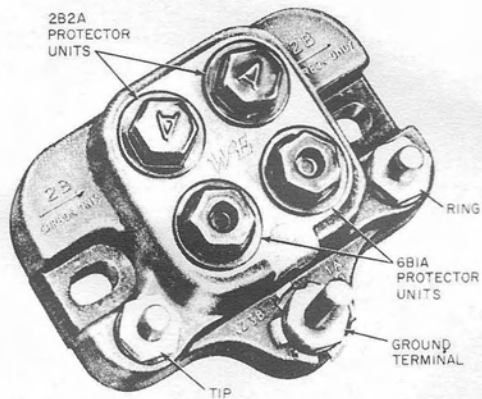

Fig. 87—123B1A (DA) Protector