

## DROP AND BLOCK WIRING FASTENING AND EQUIPPING DROP WIRE RUNS TO BUILDINGS

CONTENTS	PAGE	1. GENERAL
1. GENERAL . . . . .	1	1.01 This section covers the methods and materials required to fasten and equip drop wire runs to buildings.
2. RULES . . . . .	2	
3. TYPICAL FIRST ATTACHMENTS TO BUILDINGS AND STEEL STRUCTURES . . . . .	2	1.02 This section is reissued to:
4. FIRST ATTACHMENTS ON LOW BUILDINGS . . . . .	10	<ul style="list-style-type: none"> <li>● Add nylon cable tie that supersedes the SC wire clip for use in fastening drop wire drip loops</li> </ul>
5. PRECAUTIONS . . . . .	10	<ul style="list-style-type: none"> <li>● Include drop and block wire attaching and fastening information formerly contained in Section 460-300-123.</li> </ul>
6. CLEARANCE FIXTURES AND METHODS OF ATTACHMENT . . . . .	12	Revision arrows are used to emphasize significant changes.
7. INTERMEDIATE ATTACHMENTS ON BUILDINGS . . . . .	14	1.03 The attachments to be used in any installation depend on a number of factors such as:
8. SPACING OF ATTACHMENTS . . . . .	19	<ul style="list-style-type: none"> <li>● Loading areas</li> <li>● Number of drops to be placed</li> <li>● Angle at which drop approaches building</li> <li>● Insulated or noninsulated attachments.</li> </ul>
9. INTERMEDIATE ATTACHMENT INSIDE BUILDINGS . . . . .	20	
10. ATTACHING TO STEEL STRUCTURES . . . . .	20	1.04 Drop wire attachments for use on all types of walls in heavy loading areas are listed in Section 462-350-212.
11. AERIAL BLOCK WIRE SPANS . . . . .	20	1.05 Drop wire attachments for use on all types of walls in medium and light loading areas are listed in Section 462-350-211.
12. EQUIPPING AND INSTALLING W LEADER BRACKET . . . . .	20	1.06 To obtain secure attachments and to avoid damage to building surfaces, it is essential that the size of fasteners and the placement of the fasteners as indicated in Tables A, B, C, D, and F be
13. LAST ATTACHMENT . . . . .	20	
14. BUILDING ENTRANCE HOLES FOR DROP AND BLOCK WIRES . . . . .	20	

**NOTICE**

Not for use or disclosure outside the  
Bell System except under written agreement

followed. Of particular importance are the clearances and lead holes for fasteners.

**1.07 Warning:** *Foreign voltage can be present on buildings covered with metal siding. Test siding with the 188A test set or similar test equipment before starting any work. Refer to Section 081-705-102 for use of the 188A test set.* When attaching galvanized attachments on buildings with aluminum siding in highly corrosive areas (industrial and marine), apply a coating of KS-14681 L1 antirust compound to aluminum siding at the point of contact to prevent corrosive action.

## 2. RULES

**2.01** In planning drop wire runs to buildings, locate the first attachment so:

- (a) The drop wire span will have the required clearance from light or power wires, trolley wires, other foreign wires, and metallic objects.
- (b) Tree interference is avoided, keeping in mind the future growth of existing trees. It is preferable to make a longer wire run on the building if, by so doing, the trees can be cleared.
- (c) The drop span can be placed with adequate sag.
- (d) When two or more drop wires to a building are involved, preferably attached at the same point, the locations of the initial and subsequent attachments should provide satisfactory wire runs in the span and on the building.
- (e) The drop wire will make a direct vertical run to the last attachment, provided the drop wire in the span:
  - (1) Has adequate clearance from trees
  - (2) Would not be objectionable if it crosses adjacent property
  - (3) Would not cross portions of vacant lots on which buildings are likely to be erected.
- (f) Ice and snow falling from the roof will not strike the drop wire. Make the first attachment as high and as near the eaves as practicable.
- (g) Fasteners will be placed a minimum of 10 inches from a corner or top of a wall, except in turning corners.

**2.02** ♦The G drop wire clamp (AT-8929) must be used in corrosive environments.♦

## 3. TYPICAL FIRST ATTACHMENTS TO BUILDINGS AND STEEL STRUCTURES

**3.01** Typical first attachments to buildings and steel structures are shown in Fig. 1 through 15. Tables A, B, C, and D list fastening devices of first attachments used on various surfaces.

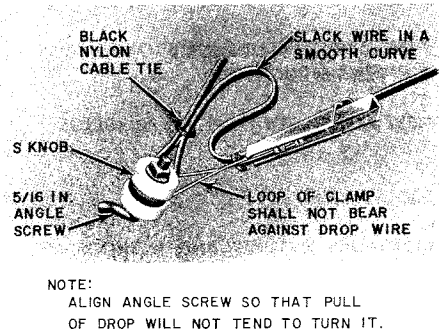

**Fig. 1**—♦First Attachment—Angle Screw Drop Wire Run in Horizontal Direction on Building (Right)♦

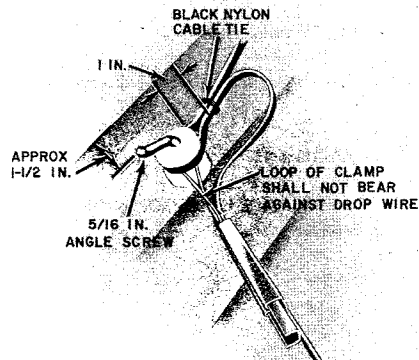

**Fig. 2**—♦First Attachment—Angle Screw Drop Wire Run in Horizontal Direction on Building (Left)♦

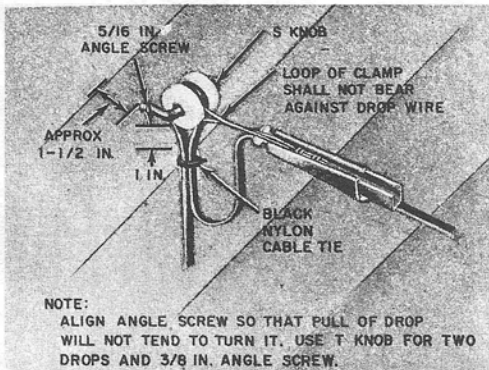

Fig. 3—First Attachment—Angle Screw Drop Wire Run in Vertical Direction on Building (Single)

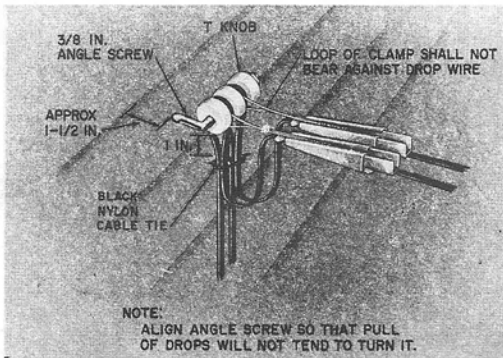

Fig. 4—First Attachment—Angle Screw Drop Wire Run in Vertical Direction on Building (Double)

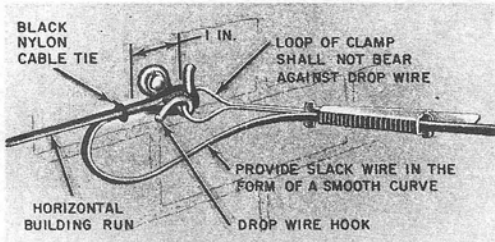

Fig. 5—First Attachment—Drop Wire Hook

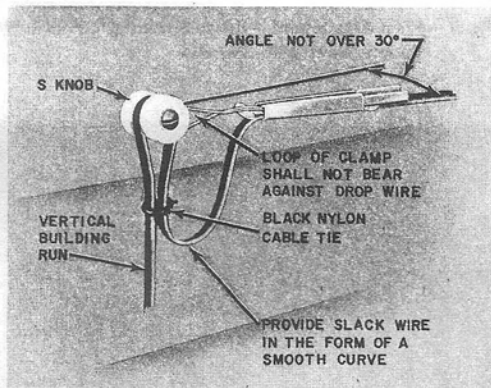

Fig. 6—First Attachment—S Knob

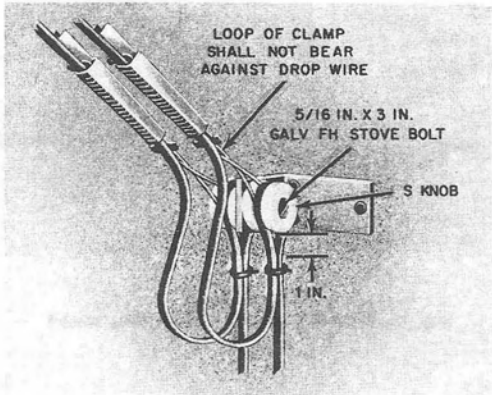

Fig. 7—First Attachment—House Bracket (Vertical Run, Double Wire) With S Knob

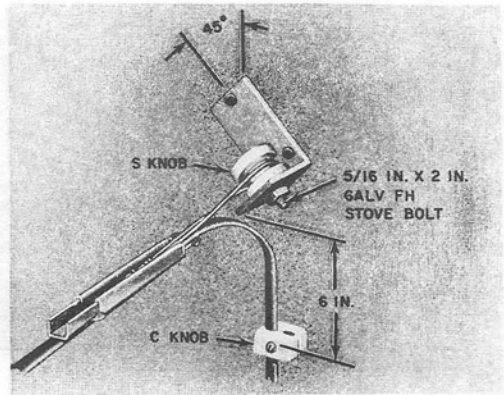

Fig. 9—First Attachment—House Bracket (Vertical Run, Single Wire) With S Knob

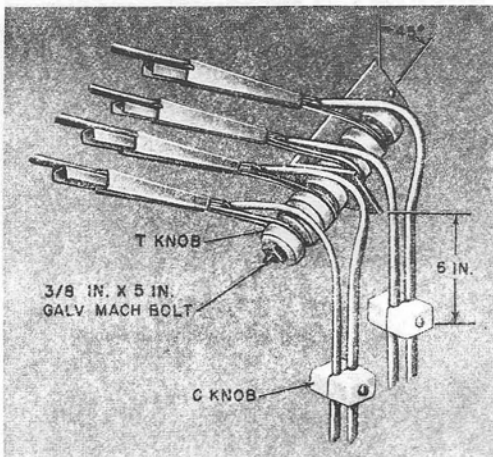

Fig. 8—First Attachment—House Bracket (Vertical Run, Four Wire) With T Knob

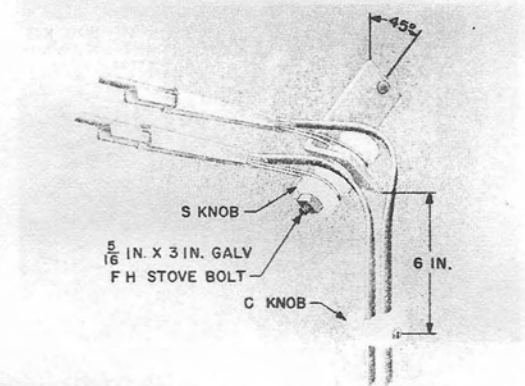

Fig. 10—First Attachment—House Bracket (Vertical Run, Double Wire) With S Knob

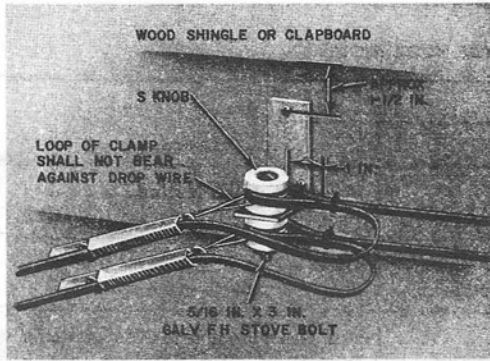
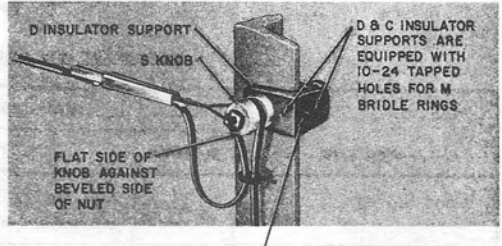

Fig. 11—First Attachment—House Bracket (Horizontal Run, Double Wire) With S Knob



D INSULATOR SUPPORT IS PROVIDED WITH 3/8 IN. CLEAR HOLE. S KNOB MAY BE ATTACHED WHEN REQUIRED. C INSULATOR SUPPORT IS PROVIDED WITH 1/2 IN. TAPPED HOLE. T KNOB MAY BE ATTACHED WHEN REQUIRED

Fig. 14—First Attachment—D or C Insulator Support

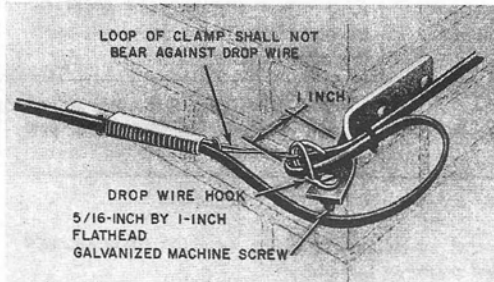
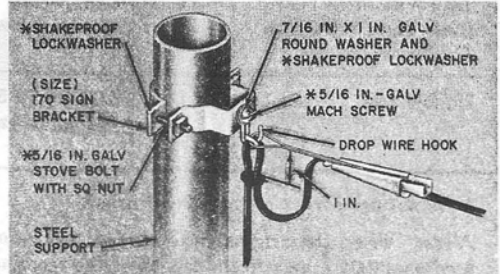

Fig. 12—First Attachment—Corner Bracket With Drop Wire Hook



\*THESE ITEMS ARE FURNISHED WITH THE SIGN BRACKET

TYPE	SIZE	DIAMETER OF SUPPORT INCHES
170	2	1-7/8 TO 3
170	3	3 TO 4
170	4	4 TO 5

Fig. 15—First Attachment—Sign Bracket, 170-Type

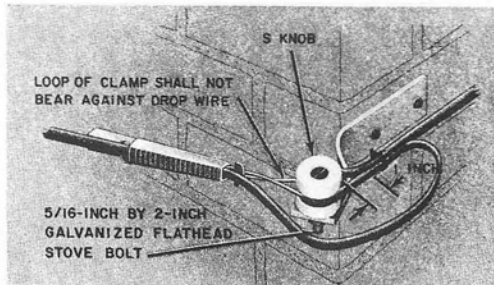

Fig. 13—First Attachment—Corner Bracket With S Knob

TABLE A

## FASTENERS FOR DROP WIRE HOOK (NOTE)

WALL TYPE	FASTENERS		REMARKS
	QUANTITY	TYPE	
Wood Siding	1	2-in. No. 18 RH galvanized wood screw	Place screw in studding.
Stucco on Wood	1	2-in No. 18 RH galvanized wood screw	Place screw in studding and drill clearance hole to avoid splitting.
Rigid Composition Shingles	1	2-in No. 18 RH galvanized wood screw	Drill clearance hole to avoid splitting shingle.
Masonry or Substantial Brick Veneer*	1	5/16-in. by 1-3/4-in. B drive anchor	Locate anchor in center of brick. Second drop wire hook should be located in separate brick.
Thin Wall Brick Veneer (Less Than 3-3/4 Inch Thickness)	1	6-in. No. 18 RH galvanized wood screw	Pass screw through the seam between bricks. Penetrate wood backing approximately 1 inch.
Hollow Tile	1	5/16-in. by 5-in. RH galvanized toggle bolt	Place 7/16 in. by 2-in. galvanized square washer between wall and drop wire hook.

\* Do not use corner or top row of bricks.

**Note:** When the original wall surface has been covered by either aluminum or vinyl covering, add approximately 1 inch to the length of the recommended screw or fastener.

TABLE B

## FASTENERS FOR S AND T KNOBS (NOTE)

WALL TYPE	ATTACHMENT KNOB	FASTENERS		REMARKS
		QUANTITY	TYPE	
Wood Siding	S	1	2-1/2 in. No. 18 FH galvanized wood screw	Place screw in studding.
	T	1	3-1/2 in. No. 18 FH galvanized wood screw	
Stucco on Wood	S	1	3-in. No. 18 FH galvanized wood screw	Use 3-1/2 in. If necessary to penetrate studding. Use 4-1/2 in.
	T	1	3-1/2 in. No. 18 FH in.	
Rigid Composition Shingles	S	1	3-1/2 in. No. 18 FH galvanized wood screw	Drill clearance hole to avoid splitting shingle. Place screw in studding.
	T	1	4-1/2 in. No. 18 FH galvanized wood screw	
Thin Wall Brick Veneer (Less Than 3-3/4 Inch Thickness)	S	1	7-in. No. 18 FH galvanized wood screw	Pass screw through the seam between bricks. Penetrate wood backing approximately 1 inch.
	T	1	7-in. No. 18 FH galvanized wood screw	
Hollow Wall	S	1	5/16 in. by 5 in. RH galvanized toggle bolt	Place flat side of S knob against bolt head.
	T	1	5/16 in. by 6 in. FH galvanized toggle bolt	

**Note:** When the original wall surface has been covered by either aluminum or vinyl covering, add approximately 1 inch to the length of the recommended screw or fastener.

TABLE C

## FASTENERS FOR HOUSE BRACKETS (NOTE)

WALL TYPE	FASTENERS		REMARKS
	QUANTITY	TYPE	
Wood Siding	3	2-in. No. 14 RH galvanized wood screw	Place screw in studding.
Stucco on Wood	3	2-1/2-in No. 14 RH galvanized wood screw	Place screw in studding.
Rigid Composition Shingles	3	3-in No. 14 RH galvanized wood screw	Drill clearance hole to avoid splitting shingle. Place screw in studding.
Masonry or Substantial Brick Veneer	2	5/16 in. by 1-1/4 in. B drive anchor	Place drive anchor in center of a brick. Use proper drill.
Thin Wall Brick Veneer (Less Than 3-3/4 Inch Thickness)	2	6-in. No. 14 RH galvanized wood screw	Pass screw through the seam between bricks. Penetrate wood backing approximately 1 inch. Screw should be placed in studding where possible.
Hollow Wall	2	1/4 in. by 3 in. or 4 in. RH galvanized toggle bolt	

**Note:** When the original wall surface has been covered by either aluminum or vinyl covering, add approximately 1 inch to the length of the recommended screw or fastener.



TABLE D

## FASTENERS FOR CORNER BRACKETS (NOTE)

WALL TYPE	FASTENERS		REMARKS
	QUANTITY	TYPE	
Wood Siding	2	2-in. No. 14 RH galvanized wood screw	Place screw in studding.
Stucco on Wood	2	2-1/2 in No. 14 RH galvanized wood screw	Place screw in studding.
Rigid Composition Shingles	2	3-in No. 14 RH galvanized wood screw	Drill clearance hole to avoid splitting shingle. Place screw in studding.
Masonry or Substantial Brick Veneer	2	5/16 in. by 1-1/4 in. B drive anchor	Place drive anchor in center of a brick. Use proper drill.
Thin Wall Brick Veneer (Less Than 3-3/4 Inch Thickness)	2	6-in. No. 14 RH galvanized wood screw	Pass screw through the seam (drill hole) between bricks. Penetrate wood backing approximately 1 inch.
Hollow Wall	2	1/4 in. by 3 in. or 4 in. RH galvanized toggle bolt	

**Note:** When the original wall surface has been covered by either aluminum or vinyl covering, add approximately 1 inch to the length of the recommended screw or fastener.

3.02 Table E lists equipping information for first attachments.

#### 4. FIRST ATTACHMENTS ON LOW BUILDINGS

4.01 Parts 5 and 6 provide additional information on typical first attachments on low buildings, using house fixtures provided by customers to obtain necessary ground clearance for drop wire.

4.02 Where house clearance fixtures are required but have not been provided, or where joint use of a fixture is impracticable, refer the matter to your supervisor.

4.03 Where clearance fixtures are provided but the required minimum ground clearance for drops cannot be obtained, refer the matter to your supervisor.

4.04 When a house is covered with aluminum or vinyl siding, the attachment must be made close to (but not in) the vertical joint or lap between two pieces.

#### 5. PRECAUTIONS

5.01 **Warning:** *Foreign voltage can be present on buildings covered with metal siding. Test siding with the 188A test set or similar test equipment before starting any work. Refer to Section 081-705-102 for use of the 188A test set.*

5.02 Observe the following precautions when planning an attachment to a subscriber-owned clearance fixture.

- (a) Wear safety glasses when drilling or hammering.
- (b) Avoid climbing on roofs of subscriber premises.
- (c) Before making an attachment, inspect fixtures. Do not make an attachment if there is any doubt as to the strength or firmness of the fixture.
- (d) To avoid body contact on joint-use fixtures, observe the location of the power service drops. Wear insulating gloves when making an attachment to the fixture. Obtain a separation of at least 12 inches between telephone and power wires.
- (e) Apply a coating of KS-14681 L1 antirust compound to prevent corrosive action when bare aluminum is exposed by drilling or cutting.
- (f) Any holes made in aluminum or vinyl siding must be sealed with a caulking compound.
- (g) Use G drop wire clamps (AT-8929) in corrosive environments.

TABLE E

## EQUIPPING DROP WIRE ATTACHMENTS WITH S KNOB, T KNOB, OR DROP WIRE HOOK (NOTE)

ATTACHMENTS		EQUIPPED WITH			HARDWARE	REMARKS
		S KNOB	T KNOB	DROP WIRE HOOK		
Angle Screw	5/16 in.	1			Nut furnished	Place flat side of knob against beveled side of nut.
	3/8 in.		1			
House Bracket		1			5/16 in. by 2 in. FH galvanized stove bolt	Place flat side of first knob against house bracket.
		2*			5/16 in. by 3 in. FH galvanized stove bolt	Place flat side of second knob against beveled side of nut.
			1		3/8 in. by 3 in. galvanized machine bolt	Place flat side of first knob against bolt head.
			2*		3/8 in. by 5 in. galvanized machine bolt	Place flat side of second knob against nut.
				1	5/16 in. by 1 in. FH galvanized machine screw	Obtained locally.
Corner Bracket		1			5/16 in. by 2 in. FH galvanized stove bolt	Place flat side of knob against corner bracket.
		2*			5/16 in. by 3 in. FH galvanized stove bolt	Place flat side of top knob against bolt head and place nut against flat side of lower knob.
			1		3/8 in. by 3 in. galvanized machine bolt	Place flat side of knob against bolt head.
				1	5/16 in. by 1 in. FH galvanized machine screw	Obtained locally
Insulator Supports	D	1			5/16 in. by 2 in. FH galvanized stove bolt	Place flat side of knob against beveled side of nut.
	C		1		3/8 in. by 3 in. galvanized machine bolt	
	D			1	5/16 in. by 1 in. FH galvanized machine screw	Obtained locally.
	C					
Sign Bracket, 170-Type				1	5/16 in. by 3/4 in. RH galvanized machine screw	Machine screw and lock washers furnished. Obtain 7/16 in. by 1 in. galvanized round washer locally.

**Note:** When the original wall surface has been covered by either aluminum or vinyl covering, add approximately 1 inch to the length of the recommended screw or fastener.

\* Locate one knob above and one knob below bracket.

**6. CLEARANCE FIXTURES AND METHODS OF ATTACHMENT**

6.01 Figures 16 through 21 show types of clearance fixtures commonly provided by subscribers and the recommended methods of making drop wire attachments. Where other types of fixtures are provided and different methods of drop wire attachments are required, local instructions should be issued.

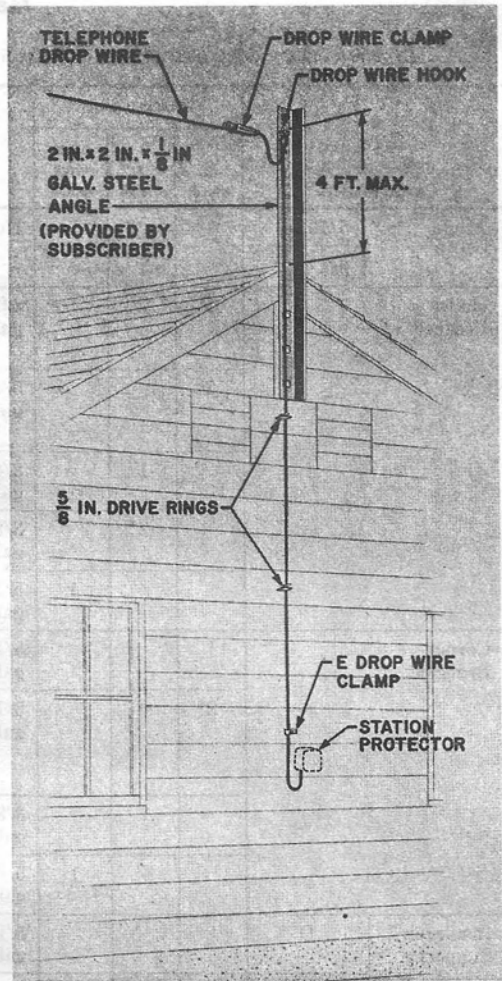
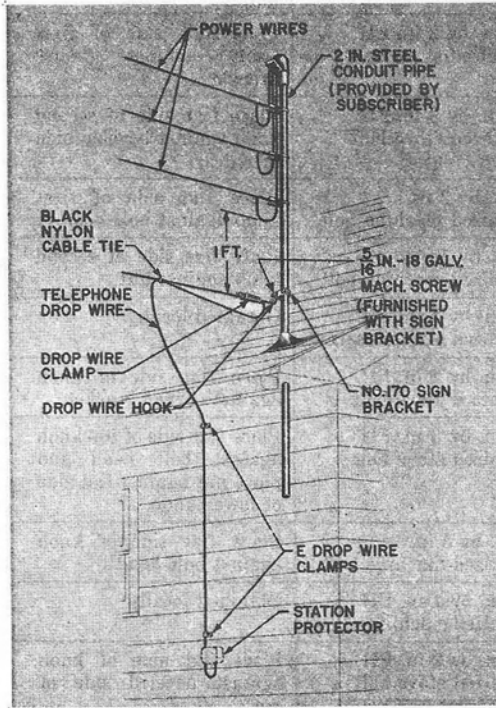

Fig. 16—Drop Wire Attachment to Power Fixture

Fig. 17—Drop Wire Attached to 2-Inch Angle Iron

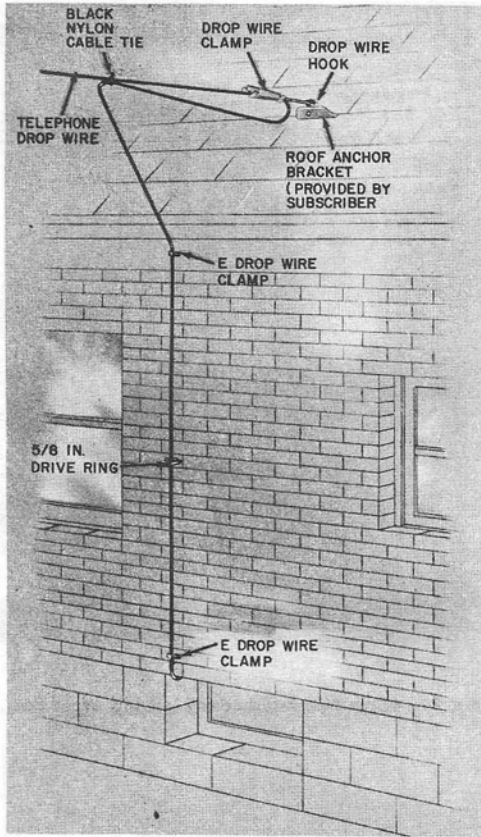

Fig. 18—Drop Wire Attached to Roof Anchor Bracket

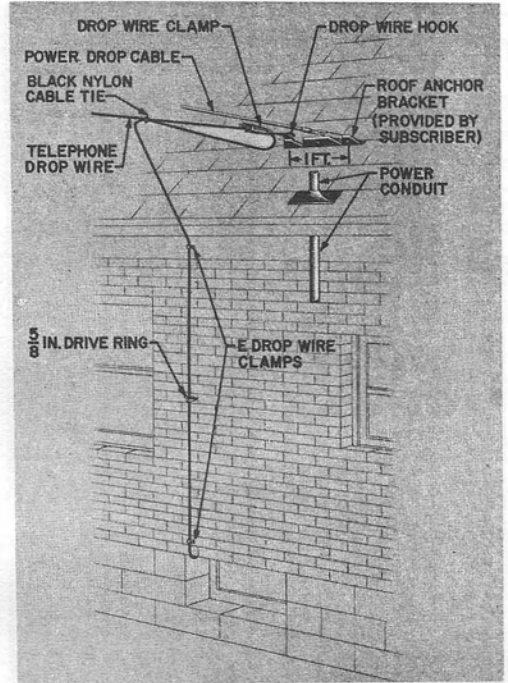

Fig. 19—Drop Wire and Power Cable Attached to Roof Anchor Bracket

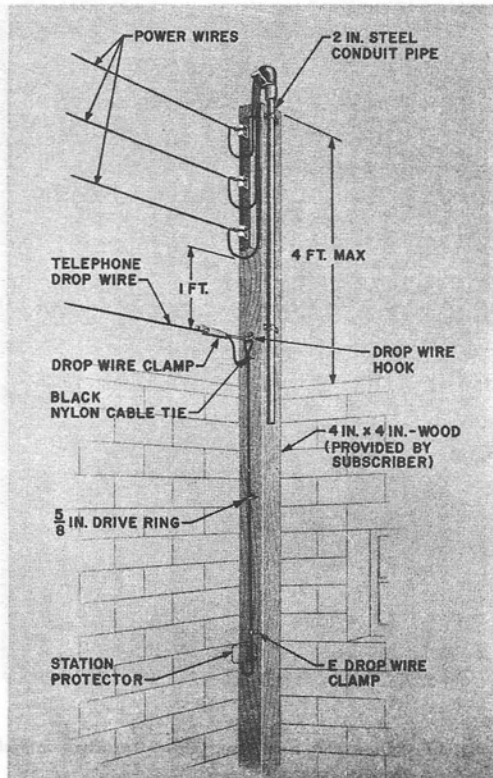

Fig. 20—Drop Wire Attached to Subscriber Pole

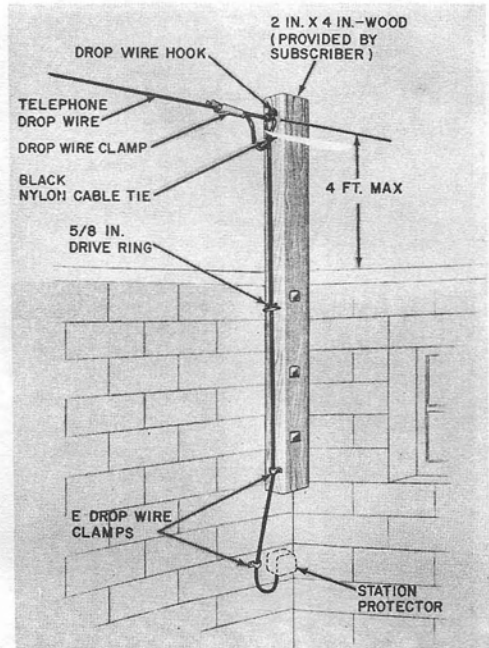

Fig. 21—Drop Wire Attached to 2- x 4-Inch Wood Beam

## 7. INTERMEDIATE ATTACHMENTS ON BUILDINGS

**7.01** Intermediate attachments on buildings are shown in Tables F, G, and H and in Fig. 22 through 30. Plan the wire run so the locations of the point of entrance and the location of the station protectors (where the latter are required) will conform to the rules covered in Section 462-005-100.

**7.02** Do not use block wire as any part of the connection between exposed plant and the protectors except when used as the bridle fuse wire, on

stations served from open wire, C rural wire, or 19-gauge multiple line wire with a 123- or 128-type protector. Block wire may be used on the station side of the protector.

**7.03** Make all vertical or horizontal attachments on buildings in a straight line.

**7.04** Wire loops, drive rings, or insulated screw eyes may be used for drop wire attachments at inside corners or for a change of direction. Drop wire hooks may also be used for this purpose.

♦TABLE F♦

## FASTENERS FOR INTERMEDIATE ATTACHMENTS ON DROP AND BLOCK WIRE

ATTACHMENT		FASTENER			TYPE OF CONSTRUCTION		REMARKS
		QUAN	TYPE				
C Wire Loops	No. 1/2 No. 5/8 No. 7/8 No. 1-1/4	1	B Masonry Fastener	No. 3	Concrete		Fasteners for hand-type drive tools
				No. 4	Mortar		
				No. 5	Cinder	Block	
					Cement		
Drive Rings	1/2 in.	1	3/16 in. x 5/8 in. D Drive Anchor		Masonry or substantial brick veneer	Do not place drive rings lower than 6 feet	
	5/8 in. and 7/8 in.	1	1/4 in. x 1 in. D Drive Anchor				
	5/8 in. L* 7/8 in. L* 1-1/4 in. 1-1/4 in. L*	1	1/4 in. x 1 in. D Drive Anchor				
C Bridle Rings	7/8 in.	1	No. 12 D Plastic Anchor		Masonry or substantial brick veneer		
	1-1/4 in. 1-5/8 in.	1	No. 16 D Plastic Anchor				
	3 in.						
B, K, or M Bridle Rings		1	B beam clip insulator support		Angle irons, I beams, etc		
C Knob (used only where fused protectors are required)		1	2-1/2 in. No. 10 RH galvanized wood screw		Exposed woodwork (outdoors)		Locate screw approxi- mately 1 in. above bottom shingle or clapboard.
		1	2 in. No. 8 RH blued wood screw		Exposed woodwork (indoors)		
		1	3 in. No. 10 RH galvanized wood screw		Stucco on wood		
E Drop Wire Clamp		1	D Masonry Fastener	No. 3	Concrete		Fasteners for hand-type drive tools
				No. 4	Mortar		
				No. 5	Cinder	Block	
					Cement		
				1	3/16 in. x 1 in. B Plastic Anchor		
1	1 in. No. 8 RH galvanized wood screw		Wood siding or shingle and Metallic siding on wood		Locate screw approxi- mately 1 in. above bottom shingle or clapboard.		
1	3/16 in. x 3 in. toggle bolt		Hollow wall				
B Siding Clip (Fig. 27 through 30)		1			Aluminum siding		

\* The L type is equipped with longer shank.

♦TABLE G♦

## CAPACITY OF WIRE LOOPS, DRIVE RINGS, AND BRIDLE RINGS FOR DROP AND BLOCK WIRE

TYPE OF RING OR INSULATED SCREW EYE	SIZE	MAXIMUM NUMBER OF WIRES		
		NP, C, OR ASW DROP WIRE	BLOCK WIRE	MULTIPLE DROP WIRE
Drive Rings	1/2	2	3	0
	5/8 and 5/8 L*	6	9	1
	7/8 and 7/8 L*	16	22	2
	1-1/4 and 1-1/4 L*	30	40	5
C Wire Loops†	No. 1/2	2	3	0
	No. 5/8	6	9	1
	No. 7/8	16	22	2
	No. 1-1/4	30	40	5
C Bridle Rings	7/8	6	9	1
	1-1/4	16	22	2
	1-5/8	30	40	5
	3	100	140	16
B, K, or M Bridle Rings	1-1/4	16	22	2
Insulated Screw Eyes	5/8 S and L*	4		0
	1 S and L*	10		1

\* L represents longer shank.

† Install with suitable B masonry fasteners.

TABLE H

## SIZES OF BUILDING ENTRANCE HOLES FOR DROP AND BLOCK WIRES AND PLASTIC TUBES

TYPE	CONDUCTOR PAIRS, QUANTITY						
	D Block (Bridle)				2	3	4
NP, C, or ASW Drop Wire	1	2	3	1	2	3	4
	PLASTIC TUBE REQUIRED			TUBE NOT REQUIRED			
Tube Size, Inch	3/8	1/2	5/8				
Entrance Hole Size, Inch	1/2	5/8	3/4	3/8	1/2	5/8	3/4

**Note:** When porcelain tubes are used, the size of the hole must be increased.



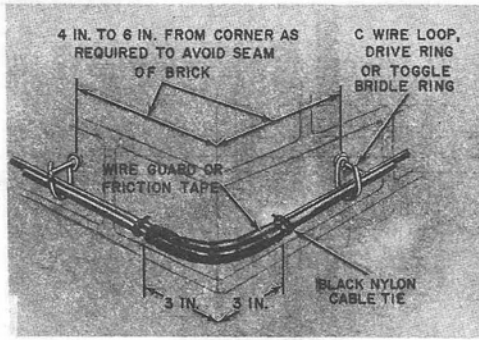

Fig. 22—Spacing Attachments at Outside Corner of Building

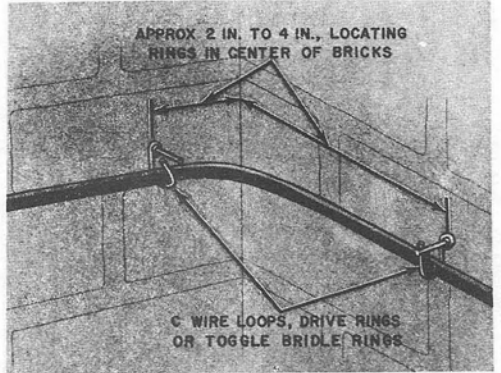

Fig. 24—Spacing Attachments at Inside Corner of Building

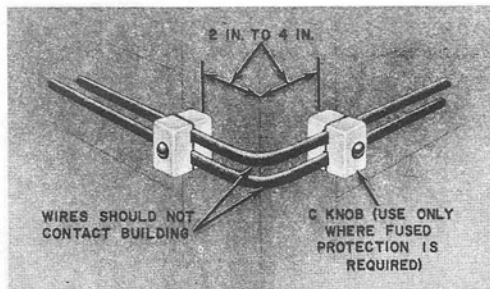

Fig. 23—Spacing C Knobs on Outside Corner of Building

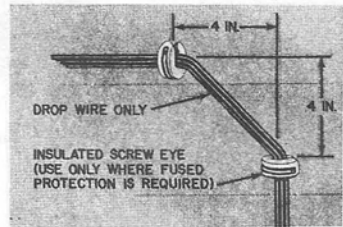

Fig. 25—Spacing Insulated Screw Eye When Changing Direction of Wire Run

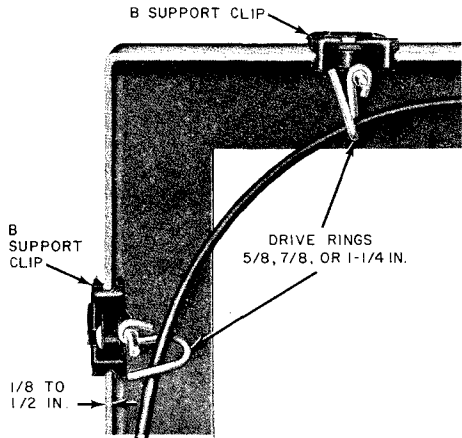

Fig. 26 — B Beam Clips

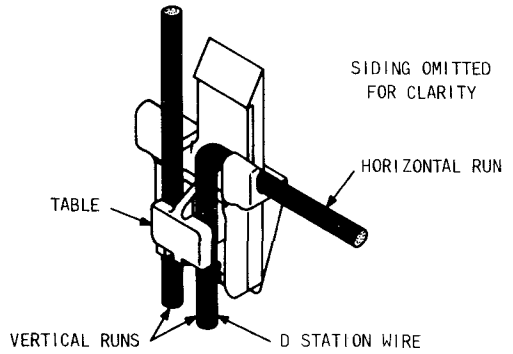

Fig. 28 — B Siding Clip With Two D Station Wires

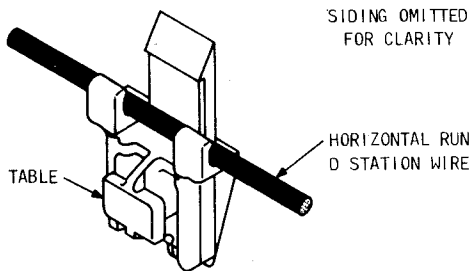

Fig. 27 — B Siding Clip With D Station Wire

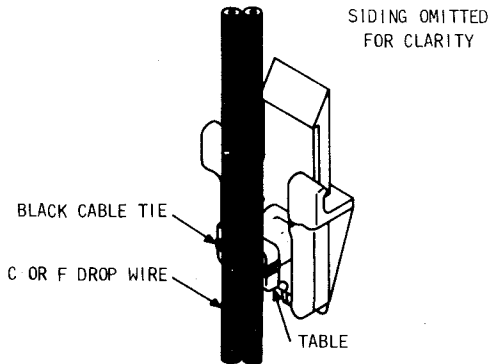
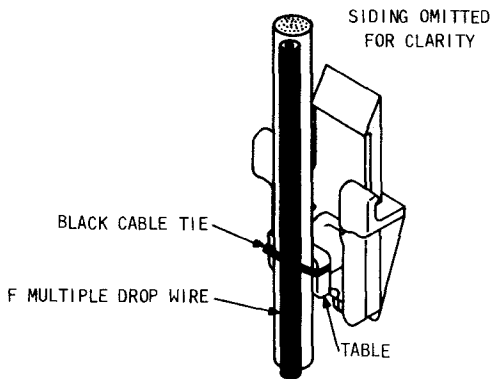

Fig. 29 — B Siding Clip With Cord Drop Wire



**Fig. 30 — Siding Clip With F Multiple Drop Wire**

**7.05** Drop wires or E block wires extending from unexposed plant must be supported with the following attachments:

- (a) Drive rings on wood frame building (placed not lower than 6 feet)
- (b) C wire loops and a suitable B masonry fastener on masonry surfaces
- (c) Toggle bridle rings on hollow surfaces
- (d) Bridle rings as a substitute for drive rings when:
  - (1) Drive rings are likely to split woodwork
  - (2) An intermediate support is needed for greater wire carrying capacity
  - (3) Where runs are lower than 6 feet.

**7.06** Drive rings equipped with a D drive anchor or C bridle rings equipped with a D plastic anchor may be used on masonry surfaces if they can be used in situations to better advantage than C wire loops.

**7.07** Exposed drop wire runs that require fused protection and that are to be attached to a flammable surface should be supported with:

- (a) Insulated screw eyes
- (b) C knob, if not more than two wires are to be placed.

## 8. SPACING OF ATTACHMENTS

**8.01** Space drop wire attachments 4 feet apart or less on horizontal runs and 12 feet apart or less on vertical runs.

**8.02** Space block wire attachments 4 feet apart or less on horizontal runs and 8 feet apart or less on vertical runs.

**8.03** Space attachments 16 inches apart on runs between the point of entrance and the protector or connecting block. Spacing will vary at corners with the type of attachment used.

**8.04** Locate attachments so fasteners will not be placed closer than 10 inches to the top of a wall. The best fastening area is near a corner where a double stud can be hit.

**8.05** Place additional attachments as required to keep exposed wires terminated at fused-type protectors from touching flammable surfaces.

**8.06** Where windows are available for making attachments on vertical runs, place an attachment at each floor.

**8.07** When establishing a wire run on a building wall where cable has been placed, the wire run should, in general, parallel the cable run.

**8.08** When paralleling cable is attached to a building wall by cable clamps, place rings in every third cable clamp where clamps are 17 inches apart and in every other cable clamp where clamps are 26 inches apart.

**8.09** When paralleling cable is placed on a strand, place separate cable rings for block wires and space them at double the spacing of the cable rings.

**9. INTERMEDIATE ATTACHMENT INSIDE BUILDINGS**

- 9.01 Drop wire runs between the point of entrance and the station protector must be kept as short as practicable. This run should be made vertically whenever possible.
- 9.02 Exposed runs that require fused protection and attach to flammable surfaces should be supported with insulated attachments.
- 9.03 Where drop or block wires are extended from unexposed plant, or where block wire is extended from the station side of a fuseless protector, the method of fastening between the point of entrance and the connecting block or subscriber set is the same as for fastening station wire.

**10. ATTACHING TO STEEL STRUCTURES**

- 10.01 Manufacturing buildings, warehouses, piers, etc, require special means of attaching.
- 10.02 The B beam clip (Fig. 26) equipped with either a drive ring or the B, K, or M bridle ring is used to support wire runs on I beams, angle irons, etc, on beam thickness of 1/8 inch to 1/2 inch.
- 10.03 The B, C, or D insulator supports equipped with C or T knobs, bridle rings, or a one-bolt clamp can be used in various applications to attach to I beams, angle irons, etc.
- 10.04 The B insulator support will accommodate B or M bridle rings only. It can be attached to steel structures up to 3/4 inch in thickness.
- 10.05 The D insulator support will accommodate S knobs or B, K, or M bridle rings. It can be attached to steel structures up to 3/4 inch in thickness.

**11. AERIAL BLOCK WIRE SPANS**

- 11.01 Block wire must not be used in aerial spans that will introduce an exposure.
- 11.02 Where an aerial span crosses a driveway or private property, provide proper clearances.
- 11.03 Where the span is 5 feet or less, bridle wire may be run without special supports. Where appearance is not essential and the run is out of reach, this distance may be increased to 12 feet.

11.04 Where only a few bridle wires will be run and the span is 35 feet or less in length, provide drop wire hooks and clamps to support the run.

11.05 Where the span is more than 35 feet in length, use either drop wire attached at each end on drop wire hooks or bridle wire supported on a 2200-pound strand.

11.06 Where the span exceeds lengths specified in paragraph 11.03 or 11.04, bridle wire may be run in 1-1/2 inch No. 22 cable rings attached to a 2200-pound strand. Space cable rings 3 feet apart. Place a drag line in the rings of the crossing span at the time they are attached. The drag line must always be replaced after it has been used for pulling wires across the aerial block wire span.

11.07 Fasten a 1/2-inch wall strap to the wooden building with two 3/8- by 4-inch coach screws installed in studding. Bore 1/4-inch lead holes for drive screws.

**12. EQUIPPING AND INSTALLING W LEADER BRACKET**

12.01 The W leader bracket is a metal strap designed to be installed over small obstructions such as pipes, rain spouts, etc, on walls. The bracket will clear obstructions extending 5 inches from wall surfaces. The W leader bracket has a single-tapped hole in the center for equipping it with a B, K, or M bridle ring.

**13. LAST ATTACHMENT**

- 13.01 The last attachment (Fig. 31 and 32) should be located within 18 inches of the building entrance hole.
- 13.02 Use the C knob on exposed wires that pass through a flammable surface. The E drop wire clamp is used on unexposed wires.

**14. BUILDING ENTRANCE HOLES FOR DROP AND BLOCK WIRES**

14.01 Use plastic tubes at building entrance holes for drop wire where fused protection is required and the wire passes through a flammable surface. Cut plastic tubes with a hack saw or diagonal pliers. Do not use split tubes at entrance holes.

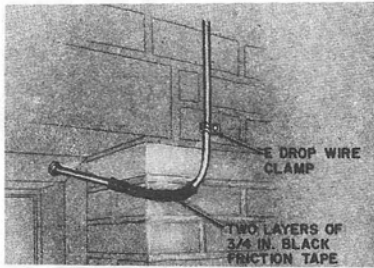

Fig. 31 — Last Attachment, Building Entrance Slopes Upward From Outside

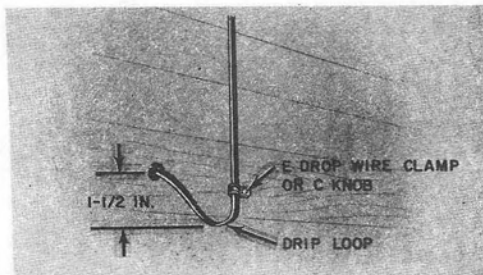

Fig. 32 — Last Attachment, Building Entrance Hole Does Not Slope Upward From Outside

14.02 The B entrance plug is intended primarily for use with E block or with NP, C, or ASW drop wires and is furnished in 1/2- and 3/4-inch diameter sizes. This plug may be used:

- (a) To seal unused entrance holes in buildings to prevent the entrance of rain, wind, insects, etc
- (b) To mechanically protect wire against abrasion
- (c) In place of a plastic tube at the building entrance hole on stations not requiring fused protection.

14.03 The B entrance plug may be added to existing drop wire by separating the partial split provided on the inside surface of the plug.

14.04 When drilling building entrance holes, the following methods should be used:

- (a) Drill holes away from the side where appearance is most important.
- (b) Slope holes upward from outside.
- (c) Use seams when drilling through masonry.
- (d) Exercise care to avoid splintering wood or cracking masonry or brick.
- (e) Drill clearance holes on all types of shingle siding.

14.05 Sizes of building entrance holes for wires and plastic tubes are shown in Table H.