



JULY 1992

ISSUE 6

AMERITECH
BELL GROUP

PRODUCT CATALOG

AMERITECH BELL GROUP PRODUCT CATALOG ENHANCEMENTS

New APROMS Touchtone Ordering Format

Added Product Pictures

Expanded Data/Voice Section

Improved Material Groupings

Over 2000 Long Descriptions

Pattern Account Cross References

**ILLINOIS BELL
INDIANA BELL
MICHIGAN BELL
OHIO BELL
WISCONSIN BELL
AMERITECH SERVICES**

CONFIDENTIAL

Solely for use by employees of Ameritech companies who have a need to know. Not to be disclosed to or used by any other person without prior authorization.

INDEX

<u>PREFACE</u>	<u>PAGE</u>
1.0 General - Format and Information.....	1
2.0 Emergency Orders.....	3
3.0 Catalog Distribution/Replacement.....	4
4.0 Catalog Sections.....	5
5.0 Catalog Headings.....	6
6.0 Alphabetical Listing of Selling Units.....	8
7.0 Authority Numbers.....	9
8.0 Material Usage Codes (MU) - Stock Items Only.....	10
9.0 Pattern Account Codes (PA) - Stock Items Only.....	11
10.0 Ordering Stock Material – Other Than Through Touch-Tone Order Entry.....	13
11.0 Ordering Non-Stock Material.....	19
12.0 Ordering Tools.....	24
13.0 Claims/Warranties.....	26
14.0 Returned Material.....	27
15.0 Transportation, Pickup and Delivery.....	29
16.0 Material Management Responsibilities.....	31

TOUCH-TONE ORDER ENTRY

AMERITECH PROCUREMENT MANAGEMENT SYSTEM

(APROMS)

1.0 General.....	32
2.0 Computer Controls.....	33
3.0 Time-Out Feature.....	33
4.0 Use of Star (*) and Pound (#) Keys.....	33
5.0 Polarity Guards.....	34
6.0 Placing Orders Via TTDT.....	34
7.0 Keying Errors – Delete Entries.....	38
8.0 Last Prompt Repeated.....	38
9.0 Help.....	38

CONFIDENTIAL

Subject to restrictions on first page.

TOUCH-TONE ORDER ENTRY
AMERITECH PROCUREMENT MANAGEMENT SYSTEM
(APROMS) (Continued)

10.0	Announcements.....	38
11.0	Transfer Order To Service Desk.....	38
12.0	Order Canceling.....	39
13.0	Computer Voice Responses.....	39
14.0	Instructional Phrases.....	41
15.0	Alpha Representation Using The Touch-Tone Keypad.....	42

CONFIDENTIAL

Subject to restrictions on first page.

1.0 GENERAL - FORMAT AND INFORMATION

The Ameritech Bell Group Product Catalog is published by Ameritech Services for the use of Illinois Bell, Indiana Bell, Michigan Bell, Ohio Bell and Wisconsin Bell personnel who have responsibility for product ordering.

The preface and ordering information format is broken down by company in each section. For example, if you are in Illinois and have a question concerning Authority Numbers, you would first refer to Section 7.0, Authority Numbers, and then look for the specific Illinois instructions. Likewise, if you are in Michigan and have a concern regarding Emergency Orders, you would first look under Section 2.0, Emergency Orders, and then look for the Michigan instructions contained in that section.

Included in this catalog are items that are available from stock through the Ameritech Distribution Center (ADC) and non-stock items that are available from approved suppliers.

All of the items listed in this catalog may not be available to order for your respective state. If you require an item that is not authorized for your state to order, contact your local staff.

Following are the appropriate telephone numbers to access APROMS (touch-tone ordering system) and additional services for your state.

ILLINOIS

Customer Service Center	8:00 AM - 4:30 PM
Touch-Tone Order Entry	(312) 467-1848
Stock/Non-Stock/Transportation	
Order Placement Via Telephone	(312) 558-6880
Customer Inquiries/Assistance	(312) 558-3594
Cable and Major Apparatus	(708) 450-2493
Telephone Orders	
Fax	(312) 558-3468
All Mail In Requisitions (AM532)	
Forward to:	Customer Service Center
(except for fiber optic cable	225 W. Randolph, HQ-10H
and major apparatus, see	Chicago, IL 60606
Section 10.0 Page 13 for	
Cable & Major Apparatus	
Details)	

CONFIDENTIAL

Subject to restrictions on first page.

1.0 GENERAL - FORMAT AND INFORMATION (CONTINUED)

INDIANA

Customer Service Center	7:30 AM - 5:00 PM
240 N. Meridian, Rm 110, Indianapolis, IN 46204	
Touch-Tone Order Entry	556-4159
Order Placement	
Stock	(317) 265-3411
Non-Stock	(317) 265-3468
Claims	(317) 265-3243
Cable Orders	(317) 265-3379

MICHIGAN

Customer Service Center	7:30 AM - 5:00 PM
Main Number	(313) 523-0800
Touch-Tone Order Entry	(313) 523-1460

OHIO

Customer Service Center	7:00 AM - 4:30 PM
Main Number	(216) 441-7730
Touch-Tone Order Entry	(312) 467-1848

WISCONSIN

Customer Service Center	7:00 AM - 4:30 PM
Main Number	(414) 523-7900
Touch-Tone Order Entry	(414) 797-9338

AMERITECH SERVICES

Customer Service Center	7:15 AM - 5:00 PM
Stock/Non-Stock/Transportation	
Order Placement	(708) 248-2532
Order Inquiries/Assistance	(708) 248-2532
FAX	(708) 248-3735
All Mail In Requisitions Forward to:	Order Administration 2000 W. Ameritech Center Dr. Loc. 3A33 Hoffman Estates, IL 60196-1025

CONFIDENTIAL

Subject to restrictions on first page.

2.0 EMERGENCY ORDERS

Following are the emergency telephone numbers to be used for emergency orders for material:

ILLINOIS

Business Hours (8:00 AM to 4:30 PM)	(312) 558-3594
Cable (7:00 AM to 3:30 PM)	(708) 450-2493
After Hours IBT Night Plant Supt. (After 4:30 PM Monday Through Friday)	(312) 727-2771

INDIANA

Business Hours (7:30 AM to 5:00 PM) Non-stock	(317) 265-3468
Business Hours (7:30 AM to 5:00 PM) Stock	(317) 265-3411
Cable	(317) 265-3379
After Hours (Indiana Control Center)	(317) 265-4888

MICHIGAN

Business Hours	Stock	(313) 523-0431
	Non-Stock	(313) 523-0474
	After Hours	(313) 523-1419
	Weekends	(313) 523-1428

OHIO

Business Hours (7:00 AM to 4:30 PM)	(216) 441-7730
After Hours (Bell Boy Number)	(216) 432-1583

WISCONSIN

Business Hours	(414) 523-7901
Cable	(414) 523-7924
After Hours - CRSAB (Centralized Repair Service Answering Bureau)	(414) 535-5068

AMERITECH SERVICES

No Emergency Orders Accepted on Expense Items

CONFIDENTIAL

Subject to restrictions on first page.

3.0 CATALOG DISTRIBUTION/REPLACEMENT

Requests for and changes to your current distribution of the Ameritech Bell Group Product Catalog should be submitted to your local Ameritech Services Customer Service Centers. Contact numbers are as follows:

<u>AMERITECH SERVICES</u>	(708) 248-2536
<u>ILLINOIS</u>	(312) 558-3594
<u>INDIANA</u>	(317) 265-7004
<u>MICHIGAN</u>	(313) 523-0423
<u>OHIO</u>	(216) 441-7725
<u>WISCONSIN</u>	(414) 523-7900

CONFIDENTIAL

4.0 CATALOG SECTIONS

This Product Catalog has all items listed alphabetically by sections. Following is a breakdown of the sections and the major material components of each section. The sections are listed in the order they appear in the catalog.

<u>SECTION</u>	<u>MATERIAL</u>
1 - Distribution Services	Cable & Wire General Hardware Optical Cable & Wire Outside Plant Public Communications Equipment (Coin)
2 - Network Services	C.O. Power Apparatus & Support C.O. Switching Apparatus & Support C.O. Transmission Apparatus & Support
3 - Tools	Static Control Products Test Equipment Tools Wearing Apparel
4 - Building/Janitorial	General Building & Janitorial
5 - Automotive	Miscellaneous Auto Parts
6 - Forms/Office Supplies	First Aid & Medical Supplies Forms Office Supplies
7 - General	Customer Premises Equipment Packing Material
8 - Data/Voice	Headsets LAN Equipment Modems Computer Hardware & Software

CONFIDENTIAL

Subject to restrictions on first page.

5.0 CATALOG HEADINGS

Within each designated section, all items are listed in alphabetical order. Following is an explanation of the Column Headings associated with each item listing.

Product Identifier (PID): A unique nine-digit number to identify a product item. This number should be used to identify non-stock items only when ordering through Ameritech Services.

Description: Contains the correct nomenclature, using the noun description, i.e., "Connecting Block" is "Block Connecting." This column may also refer to the Bell System Practice where further information can be obtained.

NOTE: Bell System Practice (BSP) numbers listed in this catalog are those that were issued with the original items. Revisions to local state practices or the new Ameritech Practice numbers will be included as that information becomes available.

Item Number: The number listed in the seven-digit number for the stock item. This number should be used for ordering stock items only.

Sell Unit: Ordering unit (ea. = each). Refer to list of standard abbreviations (Section 6.0).

Ordering Multiple: A numeric field to indicate the quantity multiple by which the stock item is sold to the customer. Please consult your Customer Service Center if you have a question concerning a specific item.

Availability: This column indicates what Ameritech Bell operating companies are currently authorized to order a particular stock item. A two-digit numerical Pattern Account (PA) Code (see Preface 9.0) under a state designation indicates that a state is authorized to order that item. If the corresponding space for a state is blank, it indicates the stock item is not currently authorized for ordering.

NOTE: The Availability column is for stock material only. If you require an item that is not authorized for ordering in your company, please consult your local staff.

NON-STOCK ITEMS

Minimum Order Quantity: This number indicates the minimum number of items the supplier will ship (non-stock material only).

Sell Unit: Ordering unit (ea. = each). Refer to list of standard abbreviations (Section 6.0).

Standard Package: Indicates the quantity multiple in which the item is sold (non-stock material only).

CONFIDENTIAL

5.0 CATALOG HEADINGS (CONTINUED)

Lead Time (Weeks): The lead time is the average number of weeks from receipt of the order by the Supplier to delivery to your location (non-stock material only).

NOTE 1: Due to proprietary information consideration, item price information has not been included. If specific price information is required, please contact your local Customer Service Center.

NOTE 2: The maximum ordering quantity of an item that can be ordered is not identified in the catalog due to variations for each state. The maximum allowed for your state will be identified to you by CISCOE at the time your order is placed.

CONFIDENTIAL

Subject to restrictions on first page.

6.0 ALPHABETICAL LISTING OF SELLING UNITS

This attachment is designed as a guide to be used in ordering materials. This list is not to be considered all-inclusive, but reflects known abbreviations utilized at this time.

ORDERING DENOMINATION	ABBREVIATION	ORDERING DENOMINATION	ABBREVIATION
Bags	BG	Kits	KT
Bale	BA	Liters	LT
Balls	AA	Lot	LO
Barrels	BR	Month	MO
Bars	BI	Meters	MR
Binders	BN	Ounces	OZ
Books	BK	Packages	PK
Bottles	BO	Pads	PD
Boxes	BX	Pages	PG
Bundles	BD	Pails	PA
Cans	CN	Pair	PR
Cards	CG	Pallets	PL
Cartons	CT	Pieces	PC
Cases	CA	Pints	PT
Coil	CX	Pounds	LB
Cone	CJ	Quarts	QT
Containers	CH	Quires	QR
Cylinders	CL	Reams	RM
Dozen	DZ	Reels	RE
Drums	DR	Rolls	RL
Each	EA	Sets	ST
Envelopes	EV	Sheets	SH
Feet	FT	Skeins	SW
Gallons	GA	Skids	SV
Gross	GS	Spools	SO
Half Gallons	GH	Stick	SX
Half Pints	PV	Strips	SR
Inches	IN	Tons	TN
Jars	JR	Tubes	TB
Jug	JU	Yards	YD

CONFIDENTIAL

Subject to restrictions on first page.

**9.0 REGIONAL STANDARD PATTERN ACCOUNT CODES (PA) -
STOCK ITEMS ONLY**

Pattern Account Code numbers are assigned to material groups as a joint function of the Operating Company Comptrollers and Purchasing Procurement.

The term "Pattern Accounting" refers to the use of predetermined accounting procedures and provides for the Mechanical Selection of Accounts, Account Codes, or Function Codes. Under the plan, a two-digit Pattern Account Code number is assigned to material item(s) of the same general category.

Following is a summary of Pattern Account Codes:

- 01 - OCE Retirement Unit-Data
- 02 - Telephone and Misc.-Reti-Units
- 03 - OCE-Repair & Expense-Data
- 04 - Tel. & Misc.-Other Costs-Voice
- 05 - OCE-Repair & Expense-Voice
- 07 - Non-Metallic Cable-Exempt
- 08 - Metallic Cable Supplies-Exempt
- 09 - COE Maint./Matl. Rearrangement
- 10 - Electronic Switch Components
- 11 - OCS Radio Repair Eqpt.
- 12 - Expense Tool
- 13 - Capital Tool
- 14 - Poles Material-Exempt
- 15 - Plant Supplies Nonexempt
- 16 - Aerial Wire Supplies-Exempt
- 17 - Misc. Tool Expense
- 18 - Station Connection Material-Exempt
- 21 - Optical Fiber Material-Exempt
- 25 - Line-Backer Sets
- 26 - Tool Maintenance Material
- 30 - DDS Equipment
- 31 - House Services & Misc. Non-Office Supplies
- 32 - Packing Material
- 33 - Sta. & Office Supplies
- 34 - First Aid Supplies
- 35 - Conduit Supplies-Exempt
- 39 - Channel Termination Equipment
- 48 - Building Repairs
- 50 - Station Conn. Mat'l Drop Wire
- 53 - Public Repair Items-Coinless
- 54 - Public Repair-Others
- 55 - Coin-Operated

CONFIDENTIAL

Subject to restrictions on first page.

**9.0 REGIONAL STANDARD PATTERN ACCOUNT CODES (PA) -
STOCK ITEMS ONLY (CONTINUED)**

- 56 - Coinless
- 57 - Booths/Shelves-Other
- 58 - Minor and Non-Recoverable Mat'l
- 59 - Public-Repair Items-Including Coin
- 61 - Sales Equipment-Handicap. Equip.
- 64 - Furniture & Office Equipment
- 65 - Central Office Parts
- 71 - Motor Vehicles Parts/Supplies
- 72 - Motor Vehicles Lubrications
- 73 - Motor Vehicles Ordinary Repair
- 74 - Tires
- 75 - CO Capital Items

CONFIDENTIAL

Subject to restrictions on first page.

10.0 ORDERING STOCK MATERIAL - OTHER THAN THROUGH TOUCH-TONE ORDER ENTRY

Stock Items should be ordered through the touch-tone ordering system (APROMS). Some states do, however, have alternative ordering procedures.

ILLINOIS

Stock Items may be ordered by telephone (312-558-6880). Please provide following information as requested by order taker.

1. Authority Number
2. Ship To Address: Street, Town, or Chicago District, Room, Floor, Truck Route
3. Material Usage Number
4. Customer (Company or Subscriber's Name) (Order By)
5. Originator or Control Center Phone Number
6. Responsibility Code Charged
7. Geographical Location (A seven-digit number)
8. Estimate-KCX-KC
9. Stock Item Number
10. Quantity
11. Servicing Information (When ordering items with specific phrase address information, furnish it directly following the item involved.)
12. Do Not Sub
13. Field Reporting Code - Job Function Code

Cable

All cable and major apparatus material must be ordered through cable management.

- Assistant Manager (708) 450-2490/2491
- Non-Stock Cable (708) 450-2492
- Stock Cable & Claims (708) 450-2493
- Major Apparatus (708) 450-2497

Forward all requisitions (AM532) for non-stock cable, fiber optic cable, and major apparatus material to:

Cable Manager
303 W. Lake
Northlake, IL 60164

CONFIDENTIAL

Subject to restrictions on first page.

10.0 ORDERING STOCK MATERIAL - OTHER THAN THROUGH TOUCH-TONE ORDER ENTRY (CONTINUED)

INDIANA

Call In Order Placement - (317) 265-3411

Order Schedule - Telephone orders may be placed from 7:30 AM to 5:00 PM Monday through Friday. Telephone orders shall be placed by forces that cannot touch-tone in their orders, i.e., over basic max, variable ship address or that require specific accounting (MU 20). A confirming MU 20 ordered with the appropriate approvals should be forwarded to the order desk to support the call in order. "Confirming order to _____" should be entered on the order to avoid a duplicate shipment.

Step by Step Procedures - To expedite placing your order, the following information in this sequence shall be given to the order clerk.

1. Identify the order to the order taker as:
 - A. Emergency Order
 - B. Variable Ship Order - (Delivery address different than that authorized on your authority number).
 - C. Over Basic Maximum Order - (Quantity requirements greater than what is allowed on your authority number).
 - D. MU 20 Order - (Refer to following MU 20 Information).

NOTE: ORDERS that do not apply to the above situations should be placed through the touch-tone ordering system CISCOE. Requests for training should be directed to (317) 265-7581.

2. Name and telephone number
3. Authority number.
4. Material usage number (MU).
5. Special requisition phrase number instruction.
6. Item number.
7. Special item phrase number when required "Do not sub next item."
8. Quantity.
9. Repeat steps 6, 7, and 8 until order is complete.

Mail-in Requisition - Stock Items should be ordered through the touch-tone ordering system, APROMS, whenever possible. Orders with special requirements, over Basic Maximum, Variable Ship, and MU 20, may be mailed to:

Ameritech Services - Customer Service Center
240 N. Meridian, Rm110
Indianapolis, IN 46204

Orders for Stock Cable **MUST** be placed using MACS.

CONFIDENTIAL

10.0 ORDERING STOCK MATERIAL - OTHER THAN THROUGH TOUCH-TONE ORDER ENTRY (CONTINUED)

If is necessary to have next day delivery for cable, a telephone order may be placed by calling the Cable Manager on (317) 265-3383 or (317) 265-3374.

Instructions for Completing Form AM532-1 - The following numbered instructions correspond to those on Form AM532-1. Please complete this form in its entirety.

1. Date Prepared - Enter current date.
2. Date Required - Enter date material is needed at the job site.
3. Ship to: Variable shipping address - to be completed only if the shipping address differs from that assigned to the authority number being used. If shown, it must be complete, including zip code.
4. Special Instructions - Enter special instructions as required - Can be used for FUTURE SHIP DATE - complete only when future non-standard shipping interval is required.
5. Authority number - Enter your assigned stock ordering authority number, or the authority number of person authorizing order. If you do not have an authority number assigned, or are ordering over basic maximum, leave blank.
6. Material Usage Number (MU) - Enter the MU number to be charged with items being ordered.
7. Geo Code, RCO, RCC - to be completed only if MU 20 is reported or specific accounting is required.
8. Job/Auth/Est - This information is for identification purposes.
9. Func/Field Acct - to be completed only if MU 20 is reported.
10. Product ID No. - Enter the item number as shown in the Ameritech Bell Group Product Catalog.
11. Quantity - Enter Quantity needed.
12. Unit - Enter ordering unit.
13. Description - Needed for Specific Accounting, MU 20 orders.
14. Ordered by and Telephone number - Enter the name and telephone number of person preparing the order or person to contact for inquiries regarding the order.
15. Final Approval - Obtain required management approval. Social Security number is not required.

CONFIDENTIAL

Subject to restrictions on first page.

10.0 ORDERING STOCK MATERIAL - OTHER THAN THROUGH TOUCH-TONE ORDER ENTRY (CONTINUED)

MICHIGAN

In addition to order via APROMS touch-tone ordering system (see APROMS section for instructions) material may be ordered via Form AM532. This form must be used when the following conditions apply:

1. No Authority Number
2. Authority Number's Material Usage Codes not authorized to order that type of material.
3. Pattern Account is controlled (meaning that type of product requires a hard copy flow and individual purchase approval as established by MBT personnel for local control and automatic APROMS touch-tone ordering is prohibited).

NOTE: All AM532 orders for stock material must be prepared, approved, and all individual local Michigan Bell procedures for certain types of products must also be met. For example, certain cable orders must go through the Cable Manager's Office; Capital Tool Orders through the Capital Tool Coordinator; Official Communications Orders through Asset Assurance Staff; etc. Please forward all other requisitions to:

Ameritech Services Customer Service Center
35275 Industrial Rd.
Livonia, Michigan 48150

OHIO

The use of APROMS/Touch-Tone is the preferred method for the ordering of stock material and expense tools. See APROMS section for instruction. When CISCOE/Touch-Tone is not possible, Form AM532-1 should be used. The Authority Number, MU Number, RCO, RCC, Geographic Location, and Account or Function Code must be completed. Final approval in accordance with CPPM 1.003 is **MANDATORY**. Send requisition to:

Ameritech Services Customer Service Center
1st Floor
7305 Fleet Ave.
Cleveland, OH 44105

CONFIDENTIAL

Subject to restrictions on first page.

10.0 ORDERING STOCK MATERIAL - OTHER THAN THROUGH TOUCH-TONE ORDER ENTRY (CONTINUED)

WISCONSIN

Stock items should be ordered as follows:

1. User groups ordering material stocked at Curtis Road/Eau Claire should use the appropriate "Want Slip."
2. Tools - (Capital and Expense) should be ordered on Form AM532-1.
3. Material requiring special accounting, or if the orderer does not have an authority number to order, should be entered on Form AM532-1 showing MU 20 and true accounting.
4. All Data and Teletypewriter stock parts and complete stations that are stock should be ordered on Form AM532-1 using MU 57 or 58, whichever is appropriate.

Following are the procedures to be used when ordering stock material from Curtis Road/Eau Claire:

A Form or "Want Slip" must be filled out to order material from Curtis Road. These Forms or "Want Slips" should be faxed to Curtis Road and the material requested will be received at the report location the next business day. There is one form or "Want Slip" per user group and also one "Want Slip" common to all user groups. The "Want Slips" to be used are as follows:

FORM

USER GROUP

M461-1 Line Material Supply Order	Construction (Lineman)
M462-1 Cable Material Supply Order	Construction (Cable)
M3179-1 Miscellaneous Material Supply Order	All User Groups
M3179-2 OCS/I&M Material Supply Order	OCS & I&M
M3179-2 Coin	

NOTE: These Forms (Want Slips) have about 100 most commonly used items preprinted on them. Other stock items are listed in the catalog.

CONFIDENTIAL

Subject to restrictions on first page.

**10.0 ORDERING STOCK MATERIAL - OTHER THAN THROUGH
TOUCH-TONE ORDER ENTRY (CONTINUED)**

AMERITECH SERVICES

Stock items may be ordered by telephone (708) 248-2532, mail-in or fax. Please provide information as requested by order taker.

1. Requisition Number will be produced by machine
2. Authority Number
3. Building Location of Ship To Address
4. Floor Location (to be typed over Title line)
5. Name of Customer to Receive Material
6. Phone Number of Originator
7. Main/Func/Sub
8. Organization Number to be Charged and Building Location
9. Item Address or PID Number of Item Being Ordered (this number should be typed in the Item Number field)
10. Quantity
11. Any remarks that correspond to the order being placed should be typed in the Order Remarks section, on the lines titled "RDC"

CONFIDENTIAL

Subject to restrictions on first page.

11.0 ORDERING NON-STOCK MATERIAL

Following are the procedures for ordering non-stock material. If you have questions that cannot be answered by reading your company's specific instructions, please call your local Customer Service Center.

ILLINOIS (With Authority Number)

When placing an order verbally please provide order information in the sequence depicted below. (Call-In Orders (312) 558-6880; Mail-In, use Form AM532.) Mail to:

Customer Service Center
225 W. Randolph, HQ-10H
Chicago, IL 60606

1. Authority Number (If assigned)
2. Ship To (A company location and the name of the person to whom material is being shipped)
 - A. Address
 - B. Room/Floor
 - C. City/Town
 - D. Zip Code
3. Material Usage (MU) (If assigned)
4. Ordered by (Name)
 - A. Telephone Number
 - B. Coordinator's Telephone Number
5. Responsibility Code Charged (A seven-digit number) (Only if different from RCO)
6. Approximate Total Cost
7. Field Reporting Code or Job Function Code
8. Geographical Location (A seven-digit number)
9. Estimate, KCX/KC Number
10. Product Identifier (PID) if required
11. Description
12. District Manager's Name (Must be District Level or above)
 - A. Title
 - B. Address
 - C. Room/Floor
 - D. City/Town
 - E. Zip Code
13. Quantity
14. Unit
15. Date Wanted
16. Environmental Code (When Required)
17. Motor Vehicle Code (When Required)

Any questions concerning these procedures may be referred to the Customer Service Center at (312) 558-3594.

CONFIDENTIAL

Subject to restrictions on first page.

11.0 ORDERING NON-STOCK MATERIAL (CONTINUED)

ILLINOIS (No Authority Number)

When placing an order verbally please provide order information in the sequence depicted below. (Call-In Orders (312) 558-6880; Mail-In, use Form AM532.) Mail to:

Customer Service Center
225 W. Randolph, HQ-10H
Chicago, IL 60606

1. Authority Number (If assigned)
2. Ordered by (Name)
 - A. Telephone Number
 - B. Coordinator's Telephone Number
3. Responsibility Code Originating (A seven-digit number)
4. Responsibility Code Charged (A seven-digit number) (Only if different from RCO)
5. Approximate Total Cost
6. Field Reporting Code or Job Function Code
7. Geographical Location (A seven-digit number)
8. Estimate, KCX/KC Number
9. District Manager's Name (Must be District Level or above)
 - A. Title
 - B. Address
 - C. Room/Floor
 - D. City/Town
 - E. Zip Code
10. Ship to (A company location and the name of person to whom material is being shipped)
 - A. Address
 - B. Room/Floor
 - C. City/Town
 - D. Zip Code
11. Product Identifier (PID) if required
12. Description
13. Quantity
14. Unit
15. Date Wanted
16. Environmental Code (When Required)
17. Motor Vehicle Code (When Required)

Any questions concerning these procedures may be referred to the Customer Service Center at (312) 558-3594.

CONFIDENTIAL

Subject to restrictions on first page.

11.0 ORDERING NON-STOCK MATERIAL (CONTINUED)

INDIANA

Request for materials, Form AM532-1 is used to order non-stock material and supplies.

Form AM532-1 preparation: Information must be supplied for the following.

1. Date prepared - Enter current date.
2. Date Required - Enter date material is needed on job site.
3. Ship to: Enter the location material is to be delivered to.
4. Special instructions - Enter any special notes about the order.
5. Mail shipping papers to - To be completed if order acknowledgement needs "directed to" address other than "Ship to".
6. Authority and MU - Not applicable when ordering non-stock items.
7. Geo Code - Enter code of delivery address to be delivered.
8. RCO - Responsibility Code Originating.
9. RCC - Responsibility Code Charged.
10. Job/Auth/Est - Required if applicable.
11. Func/Field Code - Required for all items.
12. Product ID No. - Nine (9) digit PID number found in Ameritech Bell Group Product Catalog.
13. Quantity - Quantity needed.
14. Unit - Ordering unit.
15. Description - complete description of item (include size, manufacturer part number, manufacturer name, etc.)
16. MIC - N/A.
17. CPR - N/A.
18. Unit Cost/Total Cost - Estimate needed for budgetary approval.
19. Dist Level Supv and Address - Not Required (this is not an approval signature line).
20. Ordered by - Enter name and telephone of person preparing the order or person to contact for inquiries regarding the order.
21. Estimated Cost/Grand Total - needed for proper level of approval.
22. Preliminary Approval/Final Approval - Obtain proper required management approval. Social Security number is not required.
23. Budget Approved - N/A.
24. Suggested Supplier - Useful for informational purpose, but does not guarantee the suggested supplier will be contacted.
25. G/L Verification - N/A.

Any questions pertaining to the preparation of this form should be referred to the Customer Service Center on (317) 265-3468.

Forwarding: Forward all requisitions for non-stock material and supplies to:

Ameritech Services Customer Service Center
240 N. Meridian St. Room 110
Indianapolis, Indiana 46204

- Non-stock cable should be ordered through MACS
- To order capital tools, refer to Section 12.0

CONFIDENTIAL

Subject to restrictions on first page.

11.0 ORDERING NON-STOCK MATERIAL (CONTINUED)

MICHIGAN

All non-stock material may be ordered on a Requisition Form AM532. All AM532 requisition orders must be prepared, approved, and all individual local Michigan Bell procedures established for certain types of products must also be met. For example: certain Cable Orders must go through the Cable Manager's Office; Capital Tool Orders through the Capital Tool Coordinator; Official Communication Orders through the Asset Assurance Staff; etc.

Please forward all other Requisitions to:

Ameritech Services Customer Service Center
35275 Industrial Rd.
Livonia, Michigan 48150

OHIO

Non-stock items must be ordered on Requisition, Form AM532-1. Mandatory information required is complete Ship To address, Authority Number, MU Number, RCO, RCC, Geographic Code (Area) and correct Account Code or Function Code for material being ordered. Telephone Company Requisition must have Final Approval in accordance with CPPM 1.003.

Forwarding: Send Requisitions to:

Ameritech Services Customer Service Center
1st Floor
7305 Fleet Avenue
Cleveland, OH 44105

WISCONSIN

All user groups should use Form AM532-1 when ordering non-stock material. All required information must be filled out correctly and proper approval is required. Questions concerning Form AM532-1, approval levels or any other matters concerning non-stock ordering may be referred to the Wisconsin Customer Service Center. For assistance, call (414) 523-7901. Mail Completed forms to:

Customer Service Center
N17 W24300 Riverwood Drive, Floor 1
Waukesha, WI 53188

For urgent or rush orders, fax completed forms to (414) 523-7904.

CONFIDENTIAL

11.0 ORDERING NON-STOCK MATERIAL (CONTINUED)

AMERITECH SERVICES

When placing an order verbally, please provide order information in the sequence listed below. Call-in orders - (708) 248-2532; Mail-in - Use Form AM532. Mail to:

Order Administration
2000 W. Ameritech Center Dr.
Loc. 3A33C
Hoffman Estates, IL 60196-1025

1. Running Order Number (if applicable)
2. Authority Number
3. Building Location
4. Floor Location (to be typed in Address Line 2)
5. Name of Customer to Receive Material
6. Phone Number of Person Originating Order
7. Main/Func/Sub
8. Organization Number to be Charged and Building Location Code
9. Approximate Cost of Entire Order
10. Record Only? (for use when processing invoices and when a hard copy purchase order is not required by the vendor)
11. Non-Stock PID (to be put in Item field, if applicable)
12. Description of Item and Any Non-Stock Catalog Numbers (any other information that may be necessary to process the item can be placed in the Description fields and the Item Remarks fields that follow)
13. Quantity
14. Unit
15. Date Wanted

If ordering through the mail or FAX, all the above information should be provided on your mail-in order form.

CONFIDENTIAL

Subject to restrictions on first page.

12.0 ORDERING TOOLS

Following are state-by-state instructions for the ordering of tools:

ILLINOIS

Capital Tools - Form AM532 must be prepared and submitted to:

Capital Tool Administrator
225 W. Randolph, HQ-8C
Chicago, IL 60606

No orders for Capital Tools will be accepted via telephone by the Customer Service Center.

Expense Tools - These tools may be ordered through the order placement number (312-558-6880) or via touch-tone transmission.

INDIANA

Stock Expense Tools - May be ordered through CISCOE or submitted on Form AM532-1 (Refer to Section 10.0 for ordering stock material.)

Non-Stock Expense Tools - May be ordered on Form AM532-1. (Refer to Section 11.0 for ordering non-stock material.)

Major Expense and Capital Tools - May be ordered on Form AM532-1 and submitted to:

Capital Tool Administrator
2941 Shelby, Room 100
Indianapolis, IN

Refer to the Outside Plant Tool Handbook for identification of major expense and capital tools. Copies of the handbook may be obtained by contacting (317) 265-8678.

MICHIGAN

Stock Expense Tools - These tools may be ordered via touch-tone transmission or by the Customer Service Center via Form AM532. All departments except those people using C.O. Authority numbers are issued special expense Tool Authority numbers which must be used to order expense tools.

Non-Stock Expense Tools - Must be ordered on Form AM532 like any other non-stock item.

CONFIDENTIAL

12.0 ORDERING TOOLS (CONTINUED)

OHIO

Capital Tools - Stock and non-stock must be ordered on Telephone Company Requisition Form AM532-1. Mandatory information required includes Ship To Address, Authority Number, MU Number, RCO, RCC, Geographic Code (Area), and correct Account Code or Function Code for material being ordered.

Stock Expense Tools - Are ordered via touch-tone transmission

Non-Stock Expense Tools - Must be ordered on Requisition Form AM532-1. Mandatory information required is complete Ship To Address, Authority Number, MU Number, RCO, RCC, Geographic Code (Area) and correct Account Code or Function Code for material being ordered. Telephone Company Requisition must have Final Approval in accordance with CPPM 1.003.

WISCONSIN

Distribution Services and Network Switched Service Departments are issued authority numbers to those authorized to order tools and should order as outlined below.

- Stock and non-stock tools and storeroom equipment are to be ordered on Form AM 532-1. The tool using number and proper MU is contained in the authority record issued to the orderer. Charges are automatically made to the Tool Using Area and RC of the orderer.
- The proper approval must be obtained before sending the request to the Customer Service Center.
- Other departments, because of the infrequency of tool ordering, have not been issued tool authorities. Form AM532-1 should be used in these infrequent tool ordering instances.
- All approved tool requisitions are to be sent to:

Customer Service Center
N17 W24300 Riverwood Drive, Floor 1
Waukesha, WI 53188

Fax forms to (414) 523-7904. For assistance, call (414) 523-7901.

Capital Tools - Stock and non-stock must be ordered using Form AM532-1. All requests must go through the organization Corporate Capital Tool Administrator before being submitted to the Customer Service Center.

CONFIDENTIAL

Subject to restrictions on first page.

13.0 CLAIMS/WARRANTIES

Unsatisfactory Shipments/Material

- not received
- shortage
- over shipment
- duplicate shipment
- wrong item
- defective item
- damaged item

Should be reported to your Customer Services Claim Representative in your state at the following numbers:

<u>ILLINOIS</u>	(312) 558-3594 (708) 450-2493 Cable/Major Outside Plant
<u>INDIANA</u>	(317) 265-3243
<u>MICHIGAN</u>	(313) 265-0431
<u>OHIO</u>	(216) 441-7730
<u>WISCONSIN</u>	(414) 523-7925
<u>AMERITECH SERVICES</u>	(708) 248-2533

NOTE: Items ordered incorrectly by user are not covered by claims processes. They should be returned via MP74-1. See Section 14.0 (Returned Material) for details.

ENGINEERING COMPLAINTS:

Engineering Complaints should be sent through your local AOC Technical Staff Organization.

CONFIDENTIAL

Subject to restrictions on first page.

14.0 RETURNED MATERIAL

The MP74-1 Return Material Notice (RMN) and associated forms MP74-2 and MP74-3 are used to return material to Ameritech Services and to ensure proper credit processing to specific amounts and/or organizations.

In general, the RMN (MP74-1) is used for the following functions:

- Salvageable Scrap and Retirement
- Disposition of some Capital and Expense Tools
- Return of ADC Stocked items in ADC "sell" units as listed in catalog
- Return of Engineering Complaint material

Return of the following items is not permitted:

- Partial cases or containers
- Hazardous/ORM-D materials in damaged or leaking containers
- Hazardous materials not accompanied by properly prepared shipping papers
- Items that are past or approaching (within 3 months) of a use by or expiration date
- Non-stock disposition
- Items discontinued from ADC stock

Please call your local Customer Service Center to obtain RMN numbers, and for assistance in forms preparation, distribution, and application usage.

NOTE: In Illinois use Form 299 for return of cable and major apparatus material.

Service Repair and Return Procedures for Non-Stock Material

Please call your local Ameritech Services Customer Service Center to place an order or to obtain assistance.

Prepare Form PM 429, Repair and Return Tag & Label, referencing the Purchase Order number provided by the Customer Service Center.

To expedite your call-in orders(s) please have the following information available:

Name
Address
Telephone Number
Responsibility Code
Geographical Location Code
Quantity
Equipment Name (complete description)
Manufacturer
Model Number
Serial Number
Vendor Name (Repair Vendor if known)
Problem - Detailed information of what's wrong with the equipment

CONFIDENTIAL

Subject to restrictions on first page.

14.0 RETURNED MATERIAL (CONTINUED)

RMN and SR&R Numbers

If any additional information concerning Returned Material or Service Repair and Return is needed, please call your local Customer Service Center at the following numbers:

NOTE: In Michigan the Customer Service Center will prepare all associated paperwork.

<u>ILLINOIS</u>	(312) 558-6880	
<u>INDIANA</u>	(317) 265-7404	
<u>MICHIGAN</u>	(313) 523-0431	(RMN)
	(313) 523-0800	(Order Placement)
	(708) 248-3712	(Receipting and Order Inquiry)
<u>OHIO</u>	(216) 441-7730	
<u>WISCONSIN</u>	(414) 523-7925	(RMN)
	(414) 523-7900	(SR&R)

CONFIDENTIAL

Subject to restrictions on first page.

15.0 TRANSPORTATION, PICKUP AND DELIVERY

ILLINOIS

Transportation Orders

When placing transportation orders, please call (312) 558-6880 and provide information in the sequence requested by the order taker.

Phase 1 (From)

Hazardous Material (Yes or No)
Geographical Location (7-digit pickup address)
Responsibility Code Originating (Area) (7-digit number)
Estimate Order Number or KCX (When applicable)
Order Remarks
Total Weight (Approximate)
Unit (Lbs.)
Contact Name
Originator's Telephone (Number)
Company Name
Name/Dept (Of person requesting service)
Address (Where material is to be picked up from/moved)
Room/Floor (Always necessary)
Town/District (If Chicago-must use District)
State
Zip Code
Date
Time Wanted (Appointment time for building cable moves)

Phase 2 (To)

Company Name
Name (Of person/place material is to be moved to. Please specify if pickup is being returned to the transship location at Northlake or Springfield.)
Address (Of place material is to be moved to)
Room/Floor (Always necessary)
Town/District
State
Zip Code
Date
Time (Appointment time for building cable moves)
Quantity (Number of cartons, reels, packages, etc.)
Unit
Code/Account (Move/Pickup to be charged to)
Item Description

Chicago and suburban call	(312) 727-4093
State moves call	(217) 789-5720
KCX rerouting call	(312) 558-3591

CONFIDENTIAL

Subject to restrictions on first page.

15.0 TRANSPORTATION, PICKUP AND DELIVERY (CONTINUED)

INDIANA

For Transportation services call the following numbers:

Indianapolis	(317) 265-3244
Hammond	(219) 977-5994

MICHIGAN

For Transportation services call the following numbers:

Livonia (Detroit Metro)	(313) 523-1419
Bay City	(517) 895-5414
Comstock Park	(616) 784-8841
Traverse City	(616) 941-2994

OHIO

For Transportation services call the following numbers:

216 Area	(216) 349-4758
419 Area	(419) 535-6840
513 Area	(513) 233-5503
614 Area	(614) 575-3302
	or
	(614) 575-3303

WISCONSIN

For Transportation services call the following numbers:

Milwaukee	(414) 678-4201
Eau Claire	(715) 839-5577
Emergency off hours	(414) 535-5068

CONFIDENTIAL

Subject to restrictions on first page.

16.0 MATERIAL MANAGEMENT RESPONSIBILITIES

It is the responsibility of the Ameritech Services Material Management Organization to distribute and pick up material in your state. Material Management contacts are as follows:

ILLINOIS

Northlake (Transship) (708) 450-2440
Springfield (Transship) (217) 529-0275

INDIANA

Indianapolis (Transship) (317) 265-3421
Hammond (Transship) (219) 977-5994

MICHIGAN

Livonia (313) 532-1419
Bay City (517) 895-5414
Comstock Park (616) 784-8841
Traverse City (616) 941-2994

OHIO

216 Area (216) 349-4758
419 Area (419) 535-6840
513 Area (513) 233-5503
614 Area (614) 575-3302
or
(614) 575-3303

WISCONSIN

Milwaukee (414) 678-4201
Eau Claire (715) 839-5577

CONFIDENTIAL

Subject to restrictions on first page.

AMERITECH PROCUREMENT MANAGEMENT SYSTEM

(Effective July 1, 1992)

APROMS

Touch-Tone Digital Transmission (TTDT) Instructions

1.0 GENERAL

This section describes how to order both stock and non-stock material through the Ameritech Procurement Management System (APROMS) using Touch-Tone Digital Transmission (TTDT).

APROMS is a purchasing order entry system used and supported by Ameritech Services, Incorporated. TTDT, a feature of the APROMS system, permits authorized employees, using a standard Touch-tone telephone set, to order material without the assistance of the Customer Service Desk. The telephone set must be equipped with twelve touch-tone keys to provide for transmitting zero through nine plus star (*) and pound (#) sign tones.

TTDT orders may be placed on a twenty-four hour basis.

When you call the TTDT access telephone number, a digitized voice will answer and request your authority number and customer ID number IF your authority number is duplicated within the Ameritech region, materials usage (MU) number, customer requisition number, item number or product identifier number (PID), and quantity information. After you have finished ordering, you will be given a system generated Ameritech Services requisition number and instructed to use that number for reference. During the order entry process, you will be given the option of hearing the item description. The system will also tell you about back-order conditions, excessive order quantities, unauthorized or incorrect entries, and identification of non-stock items. You will also have the option of obtaining an item's price.

With proper authority, all items identified by seven-digit item numbers and a limited number of non-stock items identified by nine-digit product identifier (PID) numbers may be ordered via TTDT. **The only stock item exceptions are capital tools and orders which use a MU code of 20.**

NOTE: MU 20 orders require specific accounting. Such orders must be placed with the Customer Service Desk - by phone call or hard copy.

CONFIDENTIAL

Subject to restrictions on first page.

2.0 COMPUTER CONTROLS

Each authority number is an assigned number and has assigned material usage and quantity controls. Material usage number(s) and the authority address are shown on your authority card.

The computer checks the following:

- Who can order or obtain pricing information by checking authority number
- What can be ordered by checking material usage number
- How much can be ordered by checking quantity controls
- Where an item can be shipped by checking the group number

The Ameritech Services Customer Service Desk should be contacted if computer controls consistently interfere with obtaining adequate quantities and/or types of material.

3.0 TIME-OUT FEATURE

The TDDT system has a time-out feature which functions after 30 seconds. The computer will audibly request that you continue ordering. If you fail to do so after three separate 30 second prompts, the system will disconnect from the line and your order will not be processed.

Therefore, before calling the APROMS TDDT system, prepare a list of item numbers or product identifiers (PIDS) and the quantities you intend to order. Having a list of items ready will make it possible to enter information promptly and avoid time-out problems.

The time-out feature will also function if you forget to register entries with the pound (#) sign as explained in the next section 4.0.

4.0 USE OF STAR (*) AND POUND (#) KEYS

A 12 button Touch-tone phone equipped with the Star (*) and Pound (#) keys must be used when placing TDDT orders to APROMS.

You must press the Star (*) key before each numbered command (e.g., *3# - delete last item; *4# - repeat last prompt, etc.). The star commands are explained in greater detail in later sections of this instruction.

EVERY entry **MUST** be registered with the pound (#) key. If the system does not receive the pound (#) tone, it will cause the time-out feature to function as described in section 3.0 of this instruction and your order will not be processed.

CONFIDENTIAL

Subject to restrictions on first page.

5.0 POLARITY GUARDS

Certain types of central office equipment reverse battery and ground. This condition makes it impossible to transmit touch-tone frequencies over telephone lines to the computer. This problem can be corrected by arranging to have a polarity guard installed in the telephone set used for material ordering purposes.

6.0 PLACING ORDERS VIA TTDT

Key in the touch-tone access telephone number specified for your company. You will be answered by the APROMS digitized voice and hear the following statement:

"WELCOME TO THE AMERITECH REGIONAL ORDER ENTRY SYSTEM.
PLEASE ENTER YOUR AUTHORITY NUMBER."

Key the seven digits of your authority number followed by the pound (#) sign.

NOTE: If your authority number is not accepted, you will hear the following response:

"THAT IS AN UNACCEPTABLE AUTHORITY NUMBER. PLEASE
ENTER YOUR AUTHORITY NUMBER."

After ten unsuccessful attempts to enter a valid authority number, the system will respond as follows:

"YOUR ORDER HAS BEEN DELETED. THANK YOU FOR USING THE
AMERITECH REGIONAL ORDER ENTRY SYSTEM."

If this happens, make sure you are entering the proper number or are not making a keying error. If assistance is needed, please call your ASI Customer Service Desk.

Whether you are entering an authority number, MU, item number, PID, Bell location code or phrase code, you will be allowed ten attempts to enter valid data before being disconnected. The error counter is reset to zero once valid input is acceptable.

When your authority number is accepted, you **MAY** hear the following prompt:

"ENTER YOUR CUSTOMER ID."

This prompt will only occur if your particular authority number is duplicated within any of the other Ameritech operating companies. If there is no duplication, this prompt will be bypassed. If you receive this prompt, enter the appropriate one-digit customer ID number followed by the pound (#) sign. Listed below are the appropriate Customer ID codes by state:

1 = Illinois, 2 = Indiana, 3 = Michigan, 4 = Ohio, 5 = Wisconsin, 6 = ASI

CONFIDENTIAL

Subject to restrictions on first page.

6.0 PLACING ORDERS VIA TTDT (CONTINUED)

When your authority number and, if required, customer ID are accepted, you will hear the following prompt:

"DO YOU WANT TO PLACE AN ORDER? IF YES ENTER ONE, IF NO ENTER TWO."

If you are not placing an order and choose option two, you may perform the following functions by entering the appropriate key:

"TO OBTAIN AN ITEM'S PRICE, ENTER ONE."
"TO REVIEW AN EXISTING ORDER, ENTER TWO."
"TO LISTEN TO ANNOUNCEMENTS, ENTER SIX."
"TO EXIT AND RETURN TO THE ORDER ENTRY PROCESS, ENTER NINE."

OPTION 1

If you choose option one (i.e., Enter One), "TO OBTAIN AN ITEM'S PRICE," the system will prompt you as follows:

"ENTER AN ITEM NUMBER."

Key in the desired item number or PID and the system will respond with the item's price. After receiving the item's price, the system will again ask "ENTER AN ITEM NUMBER." Enter an additional item number if so desired. If no other item prices are required, key in a pound (#) sign. The system will again give you the options listed above (i.e., OBTAIN PRICE, REVIEW AN ORDER, LISTEN TO ANNOUNCEMENTS, or EXIT).

OPTION 2

If you choose option two (i.e., Enter Two), "TO REVIEW AN EXISTING ORDER," the system will prompt you as follows:

"ENTER A REQUISITION NUMBER."
"DO YOU WANT TO HEAR THE ITEM'S DESCRIPTION? ENTER ONE FOR YES, TWO FOR NO."

Once the requested information is entered, the system will respond with information regarding a previously placed order. The information provided will be in the following sequence: Line number, item number, item's description (if desired), quantity ordered, unit of measure, date entered, and item's status. After receiving this information, the system will again request for an additional requisition number. If no other requisition numbers are required, key in the pound (#) sign. The system will again give you the options listed above (i.e., OBTAIN PRICE, REVIEW AN ORDER, LISTEN TO ANNOUNCEMENTS, or EXIT).

CONFIDENTIAL

Subject to restrictions on first page.

6.0 PLACING ORDERS VIA TTDT (CONTINUED)

OPTION 3

If you choose option three (i.e., Enter Six), "TO LISTEN TO ANNOUNCEMENTS," the system will respond with any announcements that reside within the system. After receiving this information, the system will again give you the options listed above (i.e., OBTAIN PRICE, REVIEW AN ORDER, LISTEN TO ANNOUNCEMENTS, or EXIT).

OPTION 4

If you choose option four (i.e., Enter Nine), the system will respond:

"DO YOU WANT TO PLACE AN ORDER? IF YES ENTER ONE, IF NO ENTER TWO."

If you are placing an order, the next system prompt will be:

"PLEASE ENTER THE TWO DIGIT MATERIAL USAGE NUMBER."

Now, key a two-digit material usage (MU) number and the pound (#) sign. Example: 01# for MU 01, 25# for MU 25, etc. When an acceptable MU number is entered, you will hear the next requested prompt as follows:

"ENTER A REQUISITION NUMBER."

Key in the requisition number and a pound (#) sign, or key a pound (#) sign only. In either case, APROMS will generate a requisition number at the end of the order entry process that must be used for reference purposes. If you enter a requisition number, the number will be used as the "Customer Reference Number" on the stock shipping manifest. Please note the requisition number can be alpha-numeric. Please see Section 15.0 to obtain the alpha representation sequence. For example, customer requisition number A12345 would be entered in the following sequence: *2112345.

The next system prompt will be:

"DO YOU WANT TO HEAR THE ITEM DESCRIPTION? ENTER ONE FOR YES; TWO FOR NO."

Key 1# if you wish to hear the descriptions of the items you are ordering.
Key 2# if you DO NOT wish to hear the descriptions.

The next prompt will be for the first item number:

"ENTER AN ITEM NUMBER."

CONFIDENTIAL

6.0 PLACING ORDERS VIA TTDT (CONTINUED)

If you wish to use a Bell location code, enter the appropriate seven-digit code in response to the first item number prompt.

If you wish to use an order level phrase code, follow the instructions provided in Section 14.0.

Otherwise, key the first item number (either a seven-digit item number OR a nine-digit product identifier PID) and a pound (#) sign. For example: 1185041# or 400527016#.

If you had requested to hear the item descriptions, you will hear:

"THAT ITEM IS _____ (A description of the item)." If the item is not stocked by Ameritech Services, you will hear the message "THIS IS A NON-STOCK ITEM."

The next system prompt will be:

"ENTER A QUANTITY."

Key the quantity you want to order and a pound (#) sign. If you do not order in standard package multiples, the system will notify you and adjust your order accordingly. (If the standard package quantity for the item you order is six, and you order five, you will be told by the system your order quantity will be changed to six. If the quantity you enter exceeds the maximum allowable order quantity, you will be told you have exceeded the maximum quantity and your order quantity will be reduced to the maximum allowable order quantity.) After you enter your order quantity, the standard response is:

"YOU ORDERED _____ (Quantity, Unit)."

Example: "YOU ORDERED FIVE HUNDRED FEET."

After entering an item as explained above, continue entering items. After each item ordered, the system will continue to prompt you for an item number (i.e., "ENTER AN ITEM NUMBER.").

When the system again requests the next item number after you have entered the last item desired, there are two options available:

- 1) If you wish to place another order, key star, one, pound sign (*#), OR star, star, 6673, and pound sign (**6673#).
- 2) If you have finished ordering, key star, nine, and pound (#) sign (*9#) OR star, star, and pound (#) sign (**#).

In both cases, the system response will be:

"YOUR ORDER NUMBER IS _____ . USE THIS NUMBER WHEN REFERRING TO YOUR ORDER."

CONFIDENTIAL

Subject to restrictions on first page.

6.0 PLACING ORDERS VIA TTDT (CONTINUED)

If you had previously keyed *1# or **6673#, you will hear the prompt for an authority number to begin your next order. Otherwise the system will say:

"THANK YOU FOR USING THE AMERITECH REGIONAL ORDER ENTRY SYSTEM."

NOTE: IT IS IMPORTANT THAT YOU END EVERY ORDERING SESSION WITH *9# OR **# OR YOUR ORDER WILL NOT BE PROCESSED!

7.0 KEYING ERRORS - DELETE ENTRIES

If you want to delete an entry, simply key *3#. All information back to the previous pound (#) sign will be deleted. You will hear:

"THAT ENTRY HAS BEEN DELETED" OR "THERE ARE NO ENTRIES TO DELETE."

8.0 LAST PROMPT REPEATED

If you want the last prompt repeated, key *4#.

9.0 HELP

To obtain the HELP menu, key *5#.

10.0 ANNOUNCEMENTS

If you want to listen to available announcements, key *6#.

11.0 TRANSFER ORDER TO SERVICE DESK

If you want your order transferred to the Customer Service Center, key *0#. If you have entered at least one item, the requisition will be saved and you will be given the requisition number. You will then be furnished with the following prompts:

"YOUR CALL WILL BE TRANSFERRED. DO YOU WISH TO BE TRANSFERRED TO THE ORDERBOARD? ENTER A ONE THEN POUND (#) SIGN TO TRANSFER YOUR CALL. ENTER A TWO THEN POUND (#) SIGN TO CONTINUE YOUR ORDER."

If one and a pound (#) sign are entered, you will hear:

"YOU WILL BE TRANSFERRED TO THE CUSTOMER SERVICE DESK. PLEASE WAIT AND AN OPERATOR WILL BE RIGHT WITH YOU."

If you key #2, you will be returned to the prompt you heard just before you keyed in *0#.

CONFIDENTIAL

Subject to restrictions on first page.

12.0 ORDER CANCELING

If you want to cancel the entire order, key *7# or hang up.

13.0 COMPUTER VOICE RESPONSES

Voice responses or statements have been programmed into the system to assist you while placing TTDT orders. They are self-explanatory or tell what you must do to enter your order correctly. Some examples of such responses are listed below:

"THAT IS AN INVALID REQUISITION NUMBER."

The requisition number you enter must conform to your state's defined requisition number length and range.

"THAT IS AN INVALID ITEM NUMBER."

This statement means you entered the wrong item number or product identifier (PID) and the system cannot accept it. You can check the number and re-enter it correctly or continue with the next item to be ordered. You will also hear this message if the Bell Location code or phrase code you enter is invalid or entered in the wrong sequence.

"THAT ITEM IS ON BACK-ORDER."

This statement is provided for your information. All back-orders are held and will be shipped when the items become available. Knowing in advance that an item is on back-order gives you the opportunity to make substitutions. The delete feature (*3#) described in Section 7.0 should be used to cancel a back-order if you do not want it held.

"YOU HAVE EXCEEDED THE MAXIMUM ITEM QUANTITY ALLOWED FOR THAT ITEM. YOU ORDERED _____. THE QUANTITY WILL BE CHANGED TO _____."

If you exceed quantity limitations on your authority number or on the item itself, you will hear this statement. The system will reduce the quantity ordered to a predetermined maximum amount.

"THAT IS AN INCORRECT MATERIAL USAGE NUMBER."

When an MU is requested by the system, the user's response must be a valid MU on his/her authority card. Questions regarding MU assignments may be directed to the appropriate staff.

"YOU ARE NOT AUTHORIZED TO ORDER THAT ITEM."

Data in the item record is not compatible with the material usage codes in your authority record. Call the Customer Service Desk if the item you wish to order is necessary for your work.

CONFIDENTIAL

Subject to restrictions on first page.

13.0 COMPUTER VOICE RESPONSES (CONTINUED)

"THAT BELL LOCATION IS OK."

When you enter a valid Bell Location Code following the prompt for the FIRST item, you will hear the above response. If you attempt to enter a Bell Location Code after the first item has been ordered, the system will respond with the message "THAT IS AN INVALID ITEM NUMBER."

"YOU ARE NOT AUTHORIZED TO USE A BELL LOCATION CODE."

If you hear the above referenced statement, your authority number does not allow the changing of shipping addresses. Please contact your Customer Service Desk for assistance.

"INVALID QUANTITY. PLEASE ENTER A QUANTITY."

This response is given if a zero quantity is entered or the tones cannot be processed by the system. Enter the quantity again.

"LAST ENTRY DELETED."

You will hear the above referenced statement after using the delete feature (*3#) that is explained in Section 7.0. This statement verifies that the item actually has been deleted.

"DO NOT EXCEED THIRTY SECONDS BETWEEN ENTRIES."

If you do not respond to a system generated prompt within approximately 30 seconds, the system will respond with the above referenced prompt. If after hearing this prompt you do not respond with an entry within approximately 40 seconds, the system will end the transaction, the order will NOT be processed, and the system will respond with the following statement:

"THANK YOU FOR USING THE AMERITECH REGIONAL ORDER ENTRY SYSTEM."

CONFIDENTIAL

Subject to restrictions on first page.

14.0 REGIONAL STANDARD INSTRUCTIONAL PHRASES

Phrase codes may be transmitted via Touch-tone telephones and will result in instructions being printed on the manifest.

Be sure to register each phrase with a pound (#) sign. Please refer to the **REGIONAL STANDARD INSTRUCTIONAL PHRASES** listed below.

Phrase codes are divided into the following two categories:

- A Requisition Phrase that applies to the entire order and must precede the first item of the order (example: Street Address, Room or Floor, Continuing Property or Motor Vehicle Number, Do Not Sub Order, etc.)
- An Item Phrase which applies to a specific item (example: Coil Size) within the order **MUST** follow the affected item. The "Do not sub next item" phrase must precede the item. All other item phrase codes would normally be entered after the item affected.

The following numerical phrases may be transmitted via Touch-tone telephones and will result in system printed instructions on the Customer Manifest. **The notation (R) after the phrase description indicates the phrase is a requisition phrase and the notation (I) after the phrase description indicates an item phrase.**

<u>PHRASE DESCRIPTION</u>	<u>ITEM (PHRASE) NUMBER</u>
Ship in One Length (I)	2020149
Save All Copies (R)	2020198
Rush Request One Day Interval	2020313
Cancel All Back-orders (R)	2022012
Reel Type Reel Number (I)	2022236
Audit Number (I)	2022244
Environment Code (R)	2023804
The Continued Property Record Is (R)	2023820
Geographic Location Override (R)	2023861
Do Not Sub The Next Item (I)	3023978
Ship on 310 Reel (I)	2023986
Order By APROMS Touchtone (R)	2024000
Ship in 500 Ft. Coils (I)	2024067
Ship in 300 Ft. Coils (I)	2024018
Ship in 250 Ft. Coils (I)	2024026
Ship in 200 Ft. Coils (I)	2024091
Ship in 150 Ft. Coils (I)	2024034
Ship in 100 Ft. Coils (I)	2024042
Ship in 50 Ft. Coils (I)	2024059
Confirming for Billing Only (R)	2024083
Date Wanted (R/I)	2024109
Do Not Sub This Requisition (R)	2024117
Room Number (R)	2024141
Floor Number (R)	2024158

CONFIDENTIAL

Subject to restrictions on first page.

15.0 ALPHA REPRESENTATION USING THE TOUCH-TONE KEYPAD

Listed below are the numeric touch-tone keypad sequences needed to represent alpha characters. PLEASE NOTE THAT EACH ALPHA CHARACTER MUST BE PRECEDED BY THE STAR (*) SIGN! Example: A = *21, B = *22, X = *92, etc.

<u>Letter</u>	<u>Key Sequence</u>	<u>Letter</u>	<u>Key Sequence</u>
A	*21	N	*62
B	*22	O	*63
C	*23	P	*71
D	*31	Q	*72
E	*32	R	*73
F	*33	S	*74
G	*41	T	*81
H	*42	U	*82
I	*43	V	*83
J	*51	W	*91
K	*52	X	*92
L	*53	Y	*93
M	*61	Z	*94

16.0 CUSTOMER SERVICE CENTERS

If you have any questions, comments and/or require assistance regarding the order entry process, please contact the Customer Service Center designated for your state. Listed below are the Customer Service Center telephone numbers:

ILLINOIS	(312) 558-3594
INDIANA	(317) 265-3411
MICHIGAN	(313) 523-0800
OHIO	(216) 441-7730
WISCONSIN	(414) 523-7900
AMERITECH SERVICES	(708) 248-2535

CONFIDENTIAL

Subject to restrictions on first page.

**ALPHABETICAL
INDEX**

ITEM	SECT	PAGE	ITEM	SECT	PAGE	ITEM	SECT	PAGE
A			APERTUS/LEE-DATA			BAR	2	4
			MAINTENANCE-			BAR	3	4-5
			SPARES	8	1-9	BAR		
			APPARATUS			BOND	1	11
			BLANK	7	1	BAR		
ABRASIVE	1	1	APPARATUS			CHANNEL	1	11
ACTIVATOR	1	1	MOUNTING	7	1	BAR		
ACTUATOR	2	1	APRON	3	1-2	CODE-EQUIPMENT	8	10-11
ADAPTER	1	1-3	ARM			BASE	1	11-12
ADAPTER	2	1	EXTENSION	1	7	BASE	2	4
ADAPTER	3	1	ARM			BASE	7	2
ADAPTER	4	1	IDLER	5	1	BASE		
ADAPTER	7	1	ARM			KEYBOARD	7	2
ADAPTER			PITMAN	5	1	BASKET	4	2
BRIDGING	2	1-2	ARRESTOR	2	2	BATTERY	2	5
ADAPTER			ASSEMBLY	1	7	BATTERY	3	5-8
BRIDGING	7	1	ASSEMBLY	2	2-3	BATTERY	4	2-3
ADAPTER			ASSEMBLY	3	2	BATTERY	5	1-2
SUPER-MODULE	1	3	ASSEMBLY	7	1	BATTERY	6	2-3
ADDITIVE	5	1	ASSEMBLY			BATTERY		
ADDITIVE			BRACKET	2	3	FILLER	2	5
DIESEL	5	1	ASSEMBLY			BATTERY		
ADHESIVE	1	3	CABLE	1	7-8	PACK	7	2
ADJUSTER	2	2	ASSEMBLY			BATTERY		
ALCOHOL	4	1	CABLE	2	3-4	RECHARGEABLE	3	8
ALERT	2	2	ATTENUATOR	1	8	BATTERY		
ALL	6	1	ATTENUATOR	2	4	SHELF	7	2
ALTERNATOR	5	1	AUGER	3	2	BATTING	1	12
AMPLIFIER	2	2	AXE	3	2	BAY	2	5
AMPLIFIER	3	1				BAY-AND		
ANALOG	3	1	B			ASSOCIATED-		
ANCHOR	1	3	BACKBOARD	1	8-10	HARDWARE	2	5-6
ANCHOR			BACKBOX	7	2	BEAM		
CAULKING	1	3	BACKPLANE	7	2	SEALED	5	2
ANCHOR			BACKPLATE			BEARING		
EXPANSION	1	3	STIFFNER	2	4	WHEEL	5	2
ANCHOR			BAFFLE	2	4	BELT	2	6
GUY	1	3-4	BAG	1	11	BELT	3	8
ANCHOR			BAG	3	2-4	BELT	5	2-4
HELIX	1	4	BAG	4	1	BELT	7	2
ANCHOR			BAG	6	1	BELT		
MASONRY	1	4	POLY	4	1-2	BODY	3	8
ANCHOR			BAG			BELT		
NO-WRENCH	1	5	TENT	3	4	BODY-D	3	9
ANCHOR			TONER	6	1	BELT		
PLASTIC	1	5	BALCONY			BODY-E	3	9
ANCHOR			CABINET	1	11	BELT		
ROD	1	5	BALCONY			BODY-F	3	9-10
ANCHOR			TERMINAL	1	11	BEND	1	12
SCREW	1	5-6	BALL			BINDER	6	3-5
ANCHOR			BEARING	2	4	BINDER		
SCREW-WALL	1	6	BALL			CLAMP	2	6
ANCHOR			JOINT	5	1	BIT	3	10-11
SCREW-WOOD	1	6	BALLAST	4	2	BIT		
ANCHOR			BALLPOINT			AUGER	3	11
SHIELD	1	6	PEN	6	1	BIT		
ANCHOR			BAND			CONSTRUCTION	3	11
STEEL-B	1	6-7	RUBBER	6	1-2	CONSTRUCTION-HC	3	11
ANCHOR			BANDAGE			BIT		
TOGLER	1	7	RUBBER	1	11	CONSTRUCTION-SC	3	11-12
ANGLE						BIT		
GUARD	2	2				EXTENSION-D	3	12
ANNOUNCER	2	2				BIT		
ANTIFREEZE	5	1				EXTENSION-E	3	12

ITEM	SECT	PAGE	ITEM	SECT	PAGE	ITEM	SECT	PAGE
BIT (CONT.)			BOLT (CONT.)			BRAKE (CONT.)		
BIT			BOLT			BRAKE		
POWER	3	12	GUY-S	1	20-21	PAD	5	5
BIT			BOLT			BRAKE		
POWER-B	3	12-13	MACHINE	1	21	SHOE	5	5
BIT			BOLT			BREAKER	2	9
POWER-C	3	13	SUSPENSION-CABLE-A1	21-22		BREAKER		
BIT			BOLT			CIRCUIT	2	10
WIREWRAP	3	13	SUSPENSION-CABLE-B1	22		BRIDGE	2	10
BLADDER	1	12	BOLT			BRIDGE		
BLADE	3	13-14	SUSPENSION-CABLE-C1	22		LIFTER	1	27
BLADE	6	5	BOLT			BRIEFCASE	1	27
BLADE			TOGGLE	1	22-23	BROCHURE	7	3
WIPER	5	4-5	BOND	3	15	BROMICIDE	4	3
BLANK			BOND			BROOM	3	17
APPARATUS	7	2	RIBBON	1	23	BROOM	4	3-4
BLANKET	3	14	BOOK	6	6	BRUSH	2	10
BLEACH	4	3	BOOK			BRUSH	3	17-18
BLOCK	1	13	MEMO	6	6	BRUSH	4	4
BLOCK	3	15	BOOK			BRUSH	6	7
BLOCK	7	2	STENO	6	6	BRUSH		
BLOCK			BOOKENDS	6	6-7	VARNISH	3	18
CONNECTING	1	13-15	BOOT	3	16	BUBBLE		
BLOCK			BOOT			PACK	7	3
CONNECTING	7	2	HOOK	3	16	BUCKET	4	5
BLOCK			BOOT			BUCKET		
CONNECTOR	1	15-17	RUBBER	3	16	CANVAS	3	18-19
BLOCK			BOOT			BUCKET		
CONNECTOR	2	6-7	STORMKING	3	16-17	SOAP	3	19
BLOCK			BOTTLE	4	3	BUCKLE	3	19
CONNECTORIZED	2	7-9	BOWL			BUILDOUT	1	27-28
BLOCK			CLEANER	4	3	BULB	2	10
FUSE	2	7-8	BOX	1	23	BULB	4	5
BLOCK			BOX	3	17	BULB	5	5
PROTECTOR	2	8	BOX	6	7	BULB	6	7
BLOCK			BOX	7	3	BULB		
SNATCH-ROPE	3	15	APPARATUS	1	23	ASPIRATOR	3	19
BLOCK			BOX			BULB		
TACKLE	3	15	OUTLET	1	23-24	RUBBER	2	10
BLOCK			BOX			BURNISHER	3	19
TERM-			SEALANT	1	24	BUS		
CONNECTORIZED	1	19	BOX			BAR	2	10
BLOCK			STORAGE	6	7	BUS		
TERMINAL	1	17-19	BOX			DUCT	2	10-11
BLOCK			TERMINAL	1	24	BUSHING	1	28-29
TERMINAL	2	8	BRACE	1	24	BUSHING		
BLOTTER	6	6	BRACE	2	9	VARIABLE	1	29
BLOWER	2	9	BRACE	4	3	BUZZER	7	3
BLOWER	3	15	BRACE					
BOARD	1	19	RATCHET	3	17			
BOARD	2	9	BRACKET	1	24-27	CABINET	1	29-30
BOARD	7	2-3	BRACKET	2	9	CABINET	2	11
BOARD			BRACKET	3	17	CABINET	7	3-4
CUTTING	6	6	BRACKET	5	5	CABINET		
BOARD			BRACKET	7	3	CROSS-CONNECT	1	30-33
MEMORY	7	3	BRACKET			CABINET		
BOARD			ASSEMBLY	2	9	DATA	8	11
PARTICLE	1	19	BRACKET			CABLE	1	33-34
BOARD			MOUNTING	2	9	CABLE	2	11-13
TEST	3	15	BRAID			CABLE	3	19-20
BOLT	1	19-20	BONDING	1	27	CABLE	7	4
BOLT			BRAKE			CABLE		
CARRIAGE	1	20	FLUID	5	5	AIR-EQUIPMENT	1	34
BOLT								
GUY-B	1	20						

C

ITEM	SECT	PAGE	ITEM	SECT	PAGE	ITEM	SECT	PAGE
CABLE (CONT.)			CAP (CONT.)			CASE (CONT.)		
CABLE			CAP			CASE	3	22-23
CLAMP	1	34	BASEBALL-INDIANA	3	21	CASE	4	5
CABLE			CAP			CASE	6	9
CLIP	1	34	BASEBALL-MICHIGAN	3	21	CASE	7	6
CABLE			CAP			CASE		
CONNECTOR	1	34-36	BASEBALL-OHIO	3	21	APPARATUS	2	16
CABLE			CAP			CASE		
CONNECTOR	2	13-14	BASEBALL-WISCONSIN	3	21-22	ATTACHE	6	9
CABLE			CAP			CASE		
CONNECTOR	3	20	CABLE	1	46-47	CARRYING	2	16
CABLE			CAP			CASE		
COUPLER	1	36	COLLARED	1	47	CARRYING	3	23-25
CABLE			CAP			CASE		
CRIMPING	3	20	DISTRIBUTOR	5	5-6	COIL	1	51-57
CABLE			CAP			CASE		
CROSS-CONNECT	1	36	FLAT	1	47	COIL-662	1	57-60
CABLE			CAP			CASE		
DATA	2	14	FLAT-END	1	47	COIL-902	1	60-63
CABLE			CAP			CASE		
DPII	1	36-37	GAS	5	6	CS902	1	63-67
CABLE			CAP			CASE		
EXCHANGE	1	37-43	MULTIPLE	1	47-48	LOAD-COIL	1	67-68
CABLE			CAP			CASE		
GUARD	1	43	OIL	5	6	REPEATER	1	68
CABLE			CAP			CASE		
HOOK	1	43	PLASTIC	1	48	REPEATER	2	16
CABLE			CAP			CASE		
INTERCONNECT	1	43-44	POST-BINDING	1	48-49	SPLICE	1	69-70
CABLE			CAP			CASE		
INTERFACE	7	4	PUDDLE	1	49	TOOL	3	25-26
CABLE			CAP			CASK		
PLENUM	1	44	RADIATOR	5	6	WATER	3	26
CABLE			CAP			CASTER		
RACK	1	44	TERMINAL	1	49-50	6	6	9
CABLE			CAP			CAULK		
STRAP	1	44	VALVED-END	1	50-51	FIRE-BARRIER	7	6
CABLE			CAPACITOR	2	14-15	CEMENT		
STUB	1	44	CAPACITOR	4	5	1	1	70
CABLE			CAPSTAN	2	15	CEMENT		
TAG	1	44	CARD	2	15-16	4	4	5
CABLE			CARD	6	8	CEMENT		
TERMINAL	1	44	CARD	7	4-5	6	6	9-10
CABLE			CARD			CEMENT		
TIE	1	44	DESIGNATION	3	22	SOLVENT	1	70
CABLE			CARD			CHAIN		
WIRE-INSIDE	1	44-45	DESIGNATION	6	8	3	3	26-27
CAGE			CARD			CHAIRMAT		
CARD	2	14	FILE	2	16	6	6	10
CALCIUM			CARD			CHALK		
CHLORIDE	4	5	INDEX	6	8-9	6	6	10
CALENDAR			CARD			CHALK		
5	5	5	FILE	6	8	MARKING	1	70
CALIPER			CARD			CHAMOIS		
5	5	5	INDEX	6	8-9	4	4	5
CALLER			CARD			CHANNEL		
ID	8	11	MEMORY	6	9	1	1	70
CAM			CARD			CHANNEL		
2	2	14	ROLODEX	6	9	2	2	16
CAN			CARD			CHANNEL		
SAFETY	3	20-21	TEST	3	22	SERVICE-UNIT	2	16
CAN			CARRIER	3	22	CHANNEL		
WASTE	4	5	CARTON	6	9	SERVICE-UNIT	7	6
CAP			CARTON	7	5	CHARGER		
1	1	45-46	CARTRIDGE	7	5-6	7	7	6
CAP			CASE	2	16	CHARGER		
2	2	14				BATTERY	3	27
CAP						CHARGER		
3	3	21				BATTERY	4	5
CAP						CHART		
BASEBALL-ILLINOIS	3	21				2	2	16
						CHASSIS		
						2	2	17
						CHASSIS		
						7	7	6
						CHEESE		
						CLOTH	4	5
						CHEMICAL		
						CRC	1	70

ITEM	SECT	PAGE	ITEM	SECT	PAGE	ITEM	SECT	PAGE
CHEMICAL (CONT.)			CLIP (CONT.)			COMPRESSION		
CHEMICAL			CLIP			SPRING	2	18
WATER-TREATMENT	4	5	CORD	1	77	COMPUTER	7	7
CHIP	2	17	CLIP			COMPUTER		
CHIP			MASONRY	1	77	PAPER	6	11
INTEL	7	6	CLIP			CONCAP	1	89
CHIP			PAPER	6	11	CONCENTRATE	1	89
MEMORY	7	7	CLIP-IT'S			CONDENSER	2	18
CHISEL	3	28	CUSTOM	6	11	CONDENSOR	5	8
CHOCK			CLIP-IT'S			CONDITIONER	5	8
WHEEL	3	28	INTERCOM	6	11	CONDUCTOR	2	18
CHUCK	3	28-29	CLIPBOARD	6	11	CONDUIT	1	89-90
CIRCUIT	2	17	CLOCK	2	17	CONE	3	33
CIRCUIT			CLOCK	6	11	CONNECTING		
PACK	2	17	CLOSURE	1	77-81	BLOCK	1	90
CIRCUIT			CLOSURE			CONNECTOR	1	90-92
PACK	7	7	AERIAL	1	81	CONNECTOR	2	18-21
CLAMP	1	70-72	CLOSURE			CONNECTOR	3	33
CLAMP	2	17	BUILDING	1	81	CONNECTOR	4	10
CLAMP	3	29	CLOSURE			CONNECTOR	7	7
CLAMP	6	10	CABLE	1	81-82	CONNECTOR		
CLAMP			CLOSURE			ADAPTER	1	92
CABLE	1	72-73	FIBER-OPTIC-SPLICE	1	82-85	CONNECTOR		
CLAMP			CLOSURE			CABLE	1	93
CHECK-VALVE	1	73	SPLICE	1	85-86	CONNECTOR		
CLAMP			CLOSURE			COUPLING	1	93
GROUND	1	73-74	VAULT&RISER	1	86-87	CONNECTOR		
CLAMP			CLOSURE			COUPLING	2	21
HOSE	5	7	WIRE	1	87	CONNECTOR		
CLAMP			CLOSURE			MODULE	1	93
MUFFLER	5	7	XAGA	1	87-88	CONNECTOR		
CLAMP			CLOTH	2	17	PICABOND	1	93-94
STAINLESS-STEEL	1	74	CLOTH	4	8-9	CONNECTOR		
CLAMP			ABRASIVE	3	32	PLUG	1	94
WIRE	1	74-75	CLOTH			CONNECTOR		
CLEANER	2	17	CLEANING	4	9-10	RECEPTACLE	1	94
CLEANER	4	5-7	CLOTH			CONNECTOR		
CLEANER	5	7	EMERY	3	32	SCOTCHLOK	1	94-95
CLEANER	6	10	CLOTH			CONNECTOR		
CLEANER			WIPING	3	32	STRAND	1	95-96
FILLED-CABLE	1	75	COATING	3	33	CONSOLE	2	21
CLEANER			COIL			CONSOLE	7	7
GLASS	4	7	HEAT	2	17	CONTACTOR	2	21
CLEANER			COIL			CONTAINER	1	96
HAND	4	7-8	IGNITION	5	7	CONTAINER	4	10
CLEANER			COIL			CONTAINER		
MS	4	8	PICK-UP	5	8	TAG-POLE	3	33
CLEANING			COIL			CONTROLLER	2	21
FLUID	4	8	REPEATING	2	17-18	CONTROLLER	7	7-8
CLEANING			COIN	1	88	CONVERTER	2	21-22
UNIT	7	7	COMPENSATOR	2	18	COPROCESSOR	7	8
CLEANSER	4	8	COMPOUND	1	88	CORD	1	96
CLIMBER			COMPOUND			CORD	2	22
EQUIPMENT	3	29-30	BLOCKING	1	88-89	CORD	3	33-35
CLIP	1	75-76	COMPOUND			CORD	4	10
CLIP	2	17	CAULKING	1	89	CORD	7	8-10
CLIP	3	31-32	COMPOUND			CORD		
CLIP	4	8	CHAULKING	1	89	CABLE	3	36
CLIP	6	10-11	COMPOUND			CORD		
CLIP	7	7	PLUG	1	89	CROSS-CONNECT	2	22-23
CLIP			COMPOUND			CORD		
BRIDGING	1	76	SEAL	1	89	DATA	8	11-12
CLIP			COMPOUND			CORD		
CABLE	1	76-77	SWEEPING	4	10	EXTENSION	7	10-11

ITEM	SECT	PAGE	ITEM	SECT	PAGE	ITEM	SECT	PAGE
CORD (CONT.)			COVERALL (CONT.)			DISK	2	24
CORD			COVERALL			DISK	7	13
PATCH	7	11	DISPOSABLE-SHIRT	3	42	DISKETTE	6	14
CORD			CREAM			DISPENSER	3	45
REEL	7	11	HAND	4	11	DISPENSER	4	12
CORD			CRIMPER	3	42	DISPENSER		
RUBBER	1	96	CROSSARM	1	101	TAPE	6	14-15
CORD			CUFFETTES	6	12	DISPLAY	2	24
SEALING	1	96	CUP	6	13	DISPLAY	7	13
CORD			CUP	7	12	DISPLAY		
SHIELDED	1	96	CUP			COLOR	7	13
CORD			DRINKING	4	11	DISTANCE		
SHIELDED	3	36	CUTTER	3	42-43	MEASURING	3	45
CORD			CYLINDER	3	43-44	DISTRIBUTING		
SHIELDED	7	11	CYLINDER			RING	1	104
CORD			ASSEMBLY	5	8	DISTRIBUTOR		
SOLDERING	3	36-37				CAP	5	8
CORD						DOCUMENT	6	15-16
TEST	3	37-41				DOCUMENT		
CORD						DOOR-HANGER	1	104
TEST	7	11				DOLLY	4	12
CORD						DOOR	1	104
TIP	3	41				DOOR		
CORDAGE	4	10				EASE-STICK	4	12
CORDAGE	7	11				DOOR		
CORK						HANGER-DOCUMENT	1	104
RUBBER	2	23				DRAIN		
CORRECTION						OPENER	4	12-13
FLUID	6	11				DRESSER		
CORRECTION						CABLE	3	45
TAPE	6	11				DRESSING	4	13
COTTON						DRI		
SWAB	4	10				WICK	3	45
COUPLER	1	96				DRIFT	3	45
COUPLER	3	41-42				DRILL	3	45-46
COUPLER	7	11				DRILL		
COUPLING	1	96-97				EXTENSION	3	46
COUPLING	2	23				DRILL		
COUPLING						MASONRY	3	46-47
ENLARGING	1	97				DRILL		
COVER	1	97-100				MASONRY-B	3	47
COVER	2	23				DRILL		
COVER	3	42				MASONRY-L	3	47-48
COVER	6	11-12				DRILL		
COVER	7	11				SURFACE-TREATED	3	48
COVER						DRIVE	7	13-14
ACETATE	6	12				DRIVER		
COVER						HEX-SET	3	48
FIRE-RETARDANT	1	100-101				DRIVER		
COVER						NUT	3	48-49
KEY	7	11-12				DRIVER		
COVER						POST	3	49
PRESSBOARD	6	12				DRIVER		
COVER						SOCKET	3	49
REPORT	6	12				DROP		
COVER						CLOTH	4	13
TOILET-SEAT	4	10-11				DRUM	7	14
COVER						DRUM		
TRANSPARENT	6	12				ASSEMBLY	6	16
COVER						DRY		
TYPEWRITER	6	12				INK	6	16
COVERALL	3	42				DRYER		
COVERALL						AIR	1	104
DISPOSABLE-PANTS	3	42				DRYER		
						AIR-PARTS	1	104

D

ITEM	SECT	PAGE	ITEM	SECT	PAGE	ITEM	SECT	PAGE
DUCT	1	104				FILTER (CONT.)		
DUCT	2	24				FILTER		
DUCT						COOLANT	5	10
BUS	2	24				FILTER		
DUCT						FAULT	2	27-28
CABLE	1	104-105				FILTER		
DUCTLINER	1	105				FUEL	5	10-11
DUST						FILTER		
MOP-FRAME	4	13				OIL	5	11-12
DUST						FILTER		
PAN	4	13				TRANSMISSION	5	12-13
DUSTER	3	49				FILTER		
DUSTER	4	13				WATER	5	13
						FINDER	3	52
						FINDER		
						LIST	6	19
						FINGER		
						RUBBER	6	19-20
						FINISH		
						FLOOR	4	15
						FIRE		
						BARRIER	1	111-112
						FIRE		
						EXTINGUISHER	4	15
						FIRMWARE	7	15
						FITTING	1	112
						FITTING	2	28
						FIXTURE		
						GUY	1	112
						FLAG	1	112
						FLAG	4	15
						FLAG		
						MARKER	1	112
						FLAG		
						WARNING	3	52
						FLARE		
						FUSE	3	52
						FLASHER		
						SIGNAL	5	13
						FLASHLIGHT	3	52-53
						FLEXPORT	1	112
						FLINT	3	53
						FLOAT	2	28
						FLOODLIGHT	3	53
						FLUID		
						AUTO-TRANS	5	13
						FLUID		
						BRAKE	5	13
						FLUID		
						CLEANING	4	15
						FLUID		
						CORRECTION	6	20-21
						FLUID		
						POWER-STEERING	5	13
						FLUID		
						STARTING	5	13
						FLUID		
						WASHING	4	15
						FLUID		
						WINDSHIELD-WASH	5	13
						FOIL		
						ALUMINUM	1	112
						FOLDER	6	21
						FOLDER		
						FILE	6	21-22

E

F

ITEM	SECT	PAGE	ITEM	SECT	PAGE	ITEM	SECT	PAGE
FOLDER (CONT.)			GLOVE (CONT.)			GUARD (CONT.)		
FOLDER			GLOVE			GUARD		
HANGING	6	22-23	FINGERLESS	3	56	RAIL-COVER	2	41
FOLDER			GLOVE			GUARD		
POCKET-PORTFOLIO	6	23	HOUSEHOLD	4	16	SPLASH	5	15
FOLDER			GLOVE			GUARD		
2-POCKET	6	21	INSULATING	3	56-57	TREE	1	117
FOOT			GLOVE			GUARD		
STOOL	3	53	LATEX	3	57	WIRE	1	117
FOOT-EZE	6	23	GLOVE			GUIDE	1	117
FORM	6	23-104	LEATHER	3	57	GUIDE	6	105
FRAME	1	112-113	GLOVE			GUIDE		
FRAME	2	28	LINEMAN	3	58	CABLE	1	118
FRAME	3	53	GLOVE			GUIDE		
FRAME	6	104	LINER	3	58	FILE-CARD	6	105
FRAME			GLOVE			GUIDE		
CALENDER	6	104	PROTECTIVE	3	58	USER	7	15
FRAME			GLOVE			GUN	3	61
DUST-MOP	4	15	RUBBER	3	58	GUN		
FRAME			GLOVE			INJECTION	3	61-62
SELF-STRIP	1	113	WHIZARD	3	58-59			
FREON	2	28	GLOVE					
FREON	5	13-14	WOLVERINE	3	59			
FRESHENER			GLUE	4	16			
AIR	4	15	GLUE	6	105			
FUEL			GOGGLE	3	59			
PUMP	5	14	GREASE	4	16			
FUNNEL	4	15-16	GREASE	5	14-15			
FURNACE	3	53-54	GRIP	3	59			
FUSE	2	28-40	GRIP					
FUSE	5	14	CABLE-PLACING	3	59-60			
FUSE	7	15	GRIP					
FUSER	6	104-105	CABLE-SPLIT	3	60			
FUSER	7	15	GRIP					
			FLEXIBLE	3	60			
			GRIP					
			KIT	1	114			
			GRIP					
			STRAND	1	114			
			GROMMET	1	114-115			
			GROMMET					
			AND-GRIP	1	115			
			GROMMET					
			KIT	1	115-116			
			GROMMETS	3	60			
			GROUND					
			CLAMP	1	116			
			GROUND					
			LEAD	1	116			
			GROUND					
			LUG	1	116			
			GROUND					
			ROD	1	116			
			GROUND					
			STRIP	1	116			
			GROUND					
			WIRE	1	116			
			GUARD	1	116			
			GUARD	2	40-41			
			GUARD	3	60-61			
			GUARD					
			CABLE	1	116-117			
			GUARD					
			RAIL-ASSEMBLY	2	41			

G

H

ITEM	SECT	PAGE	ITEM	SECT	PAGE	ITEM	SECT	PAGE
KNOB			LEAD (CONT.)			LUBRICANT	1	134
PORCELAIN	1	131	LEAD			LUBRICANT	2	47
KTU	7	19	PENCIL	6	111-112	LUBRICANT	3	81
			LEAD			LUBRICANT	4	22
			SLEEVE	1	133	LUBRICANT	5	17
			LEADERGARD	1	133	LUBRICANT	6	112
			LEADS	3	78-79	LUG	2	47
			LEE			LUG		
			DATA	7	19	GROUND	1	134
			LEG			LUG		
			IRONS	3	79	TERMINAL	1	134
			LENS					
			INDICATOR	2	47			
			LETTER					
			OPENER	6	112			
			LETTERHEAD	6	112			
			LETTERING					
			NUMERICAL	6	112			
			LEVEL	3	79			
			LID	1	133			
			LID	4	21			
			LIFTER	3	79			
			LIFTER					
			BRIDGE	1	133			
			LIGHT	3	79			
			LIGHT	4	21			
			LIGHT					
			HARDHAT	3	80			
			LIGHT					
			POLE	1	133			
			LIGHTER	3	80			
			LINE	3	80			
			LINE					
			CONTROLLER	7	19			
			LINER	4	21-22			
			LINER					
			CAP-SAFETY	3	80			
			LINK	6	112			
			LINK					
			CONNECTOR	3	80-81			
			LINK					
			LEAD	4	22			
			LINK					
			REIN	1	133			
			LITE					
			TRUCK	5	17			
			LOCATOR					
			CABLE	3	81			
			LOG					
			BINDING-POST	1	133-134			
			LOG					
			DRIVERS	6	112			
			LOGIC					
			DISPLAY	7	19			
			LOOP					
			CONVERSION	2	47			
			LOOP					
			DETECTOR	7	19			
			LOOP					
			WIRE	1	134			
			LOTION					
			HAND	4	22			
			LP					
			GAS	3	81			

L

M

ITEM	SECT	PAGE
MODEM (CONT.)		
MODEM		
2400/09600-BPS	8	26
MODEM		
2400/19200-BPS	8	26
MODEM		
300/01200-BPS	8	20-21
MODEM		
300/01800-BPS	8	21
MODEM		
300/02400-BPS	8	22-23,26
MODEM		
300/04800-BPS	8	23-24
MODEM		
300/19200-BPS	8	24-25
MODEM		
4800-BPS	8	28
MODEM		
4800/09600-BPS	8	26-28
MODEM		
4800/9600/19200-BPS	8	28
MODEM		
56 KBPS/64 KBPS	8	28
MODULE		
	1	137
MODULE		
	2	48-49
MODULE		
	3	83
MODULE		
	7	21-22
MODULE		
DISTRIBUTOR	5	18
MOISTENER		
	6	116
MOLLY		
LUBE	5	18
MONITOR		
	7	22
MOP		
	4	22-23
MOTOR		
	2	49
MOTOR		
	7	22-23
MOTOR		
ELECTRIC	4	23
MOUNT		
SET	1	137
MOUNTING		
	1	137
MOUNTING		
	2	49-50
MOUNTING		
APPARATUS	1	137
MOUNTING		
APPARATUS	2	50
MOUNTING		
APPARATUS	7	23
MOUNTING		
DATA	7	23-24
MOUNTING		
JACK	7	24
MOUNTING		
PLATE	7	24
MOUNTING		
ROD	7	24
MOUSE		
	7	24
MUFFLER		
	5	18
MUFFLER		
CLAMP	5	18
MUFFLER		
HANGER	5	18
MULTIPLEXER		
	7	24
MUSLIN		
	1	138

ITEM	SECT	PAGE
N		
NAIL		
	1	138
NAIL		
WIRE	1	138
NAMEPLATE		
	6	116
NAPKIN		
	4	23
NAPKIN		
PAPER	4	23
NAPKIN		
SANITARY	4	23-24
NETWORK		
	2	50
NETWORK		
INTERFACE	1	138
NIPPLE		
	1	138
NIPPLE		
PREWIRE	4	24
NODE		
	2	50
NOTARY		
SEAL	6	116
NOTES		
POST-IT	6	116-117
NOZZLE		
	4	24
NUMBER		
INDEX	6	117
NUT		
	1	139
NUT		
	2	50
NUT		
DRIVER	3	83
NUT		
HEX	1	139
O		
O-RING		
	2	51
OIL		
	1	139
OIL		
	2	50-51
OIL		
	3	83
OIL		
	5	18-19
OIL		
CAP	5	19
OIL		
DRY	4	24
OIL		
HOUSEHOLD	4	24
OIL		
MACHINE	6	117
OIL		
NEATSFOOT	3	83
OIL		
ZORB	4	24
OILER		
	3	83
OPENER		
LETTER	6	117-118
ORANGE		
STICK	3	83
ORGANIZER		
	2	51
ORGANIZER		
	6	118
ORGANIZER		
POWER	4	24

ITEM	SECT	PAGE
OSCILLATOR		
	2	51
OUTLET		
	4	24
P		
P-NUMBERED		
PARTS	1	188-189
P-NUMBERED		
PARTS	2	60-80
P-NUMBERED		
PARTS	3	95
PACK		
BATTERY	2	51
PACK		
BATTERY	3	83-84
PACK		
BATTERY	7	24
PACK		
CIRCUIT	1	139-140
PACK		
CIRCUIT	2	51-53
PACK		
CIRCUIT	7	25
PACKET		
	2	53
PACKING		
MATERIAL-&		
EQUIPMENT	7	25-28
PACKS		
	2	53
PAD		
	1	140
PAD		
	2	54
PAD		
	3	84
PAD		
	4	24
PAD		
	7	28
PAD		
CLEANING	4	24-25
PAD		
CROSS-CONNECT	1	140
PAD		
DISC-BRAKE	5	19-20
PAD		
FLOOR	4	25
PAD		
MOUSE	7	28
PAD		
PAPER	6	118-119
PAD		
STAMP	6	119
PADLOCK		
	3	84-85
PADLOCK		
KEY	3	85
PAGECOM		
	7	28
PAIL		
	3	85
PAIL		
	4	25
PAINT		
	1	140
PAINT		
	4	25-26
PAINT		
	5	20
PAN		
DUST	3	85
PAN		
DUST	4	26
PANEL		
	1	140
PANEL		
	2	54-55
PANEL		
	7	28-29

ITEM	SECT	PAGE	ITEM	SECT	PAGE	ITEM	SECT	PAGE
PANEL (CONT.)			PAPER (CONT.)			PLATE (CONT.)		
PANEL			PAPER			PLATE		
BLANK	1	140	TOWEL	4	26	END	1	142-143
PANEL			PASTE			PLATE		
FUSE	2	55-56	SPACKLE	1	141	END-FR	1	143-144
PANEL			PASTER	1	141	PLATE		
PROTECTOR	1	140-141	PATCH			FACE	1	144
PAPER	6	119-120	CORD	2	56	PLATE		
PAPER			PATCH			FACE	7	29-30
ABRASIVE	3	85	CORD	3	85	PLATE		
PAPER			PCB	7	29	MOUNTING	1	144-145
ADDING-MACHINE	6	120-121	PCV VALVE	5	20	PLATE		
PAPER			PEDESTAL	1	141	MOUNTING	2	56
BOND	6	121	PEDESTAL	2	56	PLATE		
PAPER			PEDESTAL	7	29	NUMBER	2	56-57
CALCULATOR	6	121	PEN	6	130-134	PLATFORM	1	145
PAPER			PEN			PLATFORM	3	86
CARBON	6	121	BALLPOINT	6	134-135	PLIERS	3	86-88
PAPER			PEN			PLOTTER	3	88
CHART	6	121	PLOTTER	6	135-137	PLOTTER	7	30
PAPER			PENCIL	6	137-140	PLUG	1	145
CLEANING	2	56	PENLIGHT	3	85-86	PLUG	2	57-58
PAPER			PERSONAL			PLUG	3	88
CLEANING	6	121	COMPUTER	8	30	PLUG	4	27
PAPER			PERSONAL			PLUG	7	30
CLIP	6	121	COMPUTER-			PLUG		
PAPER			EQUIPMENT	8	30-32	COLLARED	1	145
COMPUTER	6	121-126	PETROLEUM			PLUG		
PAPER			SPIRITS	4	26	CONDUIT	1	145-146
COPIER	6	126-128	PHONE			PLUG		
PAPER			BEAM	7	29	GLOW	5	21
CROSS-SECTION	6	128	PHONE			PLUG		
PAPER			DESK	7	29	SIGNAL	2	58-59
DRAWING	6	128	PHOTOCONDUCTOR	7	29	PLUG		
PAPER			PHOTOGRAPHIC			SPARK	5	21-22
DRY-SILVER	6	128	SUPPLIES	6	140	PLUG		
PAPER			PICK-UP			TAPERED	1	146
EASEL	6	128	COIL	5	20	PLUG-IN	2	59
PAPER			PIN	1	141	PLUNGER	4	27
EMERY	3	85	PIN	2	56	POCKET	3	89
PAPER			PIN	5	20	POCKET		
FASTENER	6	128	PIN			FILE	6	140-141
PAPER			EXTENSION	3	86	POCKET		
FAX	6	128-129	PIN			SECRETARY	6	141
PAPER			INSULATOR	1	141	POINT		
GRAPH	6	129	PIN			DRILL	3	89
PAPER			PUSH	6	140	POINT		
INDEX	6	129	PIPE			IGNITION	5	22
PAPER			EXHAUST	5	20	POINT		
MEMO	6	129	PIPE			MODULE	5	22-23
PAPER			EXTENSION	5	20	POINT		
PLOTTER	6	129	PIPE			TEST	3	89
PAPER			STEEL	1	141-142	POINTER	6	141
PUNCH	6	129	PIPE			POLE	3	89
PAPER			TAIL	5	20-21	POLE		
ROLL	6	129	PLANK	1	142	LIGHT	1	146
PAPER			PLANK	3	86	POLE		
SAND	3	85	PLANNER	6	140	TAG	1	146
PAPER			PLAQUE			POLE		
SHEET	6	130	SAFETY	6	140	WOODEN-UTILITY	1	146-147
PAPER			PLATE	1	142	POLISH	4	27
TELETYPE	6	130	PLATE	2	56	PORT	2	59
PAPER			PLATE	4	26-27	PORT		
TOILET	4	26	PLATE	7	29	CABLE	1	147

ITEM	SECT	PAGE	ITEM	SECT	PAGE	ITEM	SECT	PAGE
PORT (CONT.)			PUMP (CONT.)			RELEASER	3	97
PORT			PUMP			RELUCTOR	5	24
EXPANSION	7	30	WATER	5	23	REMOTE		
POST	1	147-148	PUNCH	3	94	ACCESS	2	105
POST	6	141	PUNCH	6	141	REMOVER		
POST			PUTTY			SPOT-&-STAIN	4	28
FUSE	2	59	WOOD	4	27	REMOVER		
POST						STAPLE	6	143
MOUNTING	1	148				REPEATER	2	105
POT						REPELLANT	3	97-98
SOLDER	3	89				REPELLENT	3	98
POUCH	3	89-91				RESISTOR	2	105-106
POWER						RESPIRATOR	3	98
BULK	2	59				REST		
POWER						SHOULDER	7	31-32
STEERING-FLUID	5	23				RESTRAINER	2	106
POWER						RETAINER	1	190
SUPPLY	2	59				RETAINER	2	106
POWER						RETAINER	3	98
UNIT	2	59				RETAINER		
POWER						WIRE	2	106
UNIT	4	27				RHEOSTAT	2	106
PRESSER	3	91-92				RIBBON	6	143-146
PRESSURIZATION						RIBBON		
AIR-CABLE-						BONDING	1	190
EQUIPMENT	1	148-161				RIBBON		
PRESSURIZATION						PRINTER	6	146-147
AIR-DRYER	1	161				RIBBON		
PRESSURIZATION						TYPEWRITER	6	147
AIR-DRYER-PARTS	1	162-167				RIG		
PRIMER	5	23				SPLICING-		
PRINTED						COMPONENTS	3	98-99
CIRCUIT-BOARD	7	30				RING	3	99
PRINTER						RING	6	147-148
EQUIPMENT	8	32-33				RING		
PRINTHEAD	7	30				BINDER	6	148
PRINTWHEEL	7	30				RING		
PROBE	3	92-93				BRIDLE	1	190-191
PROCESSOR	7	30-31				RING		
PROTECTION						CABLE	1	191
EAR	3	93				RING		
PROTECTOR	1	167-169				DISTRIBUTING	1	191
PROTECTOR	2	59				RING		
PROTECTOR	3	93				DRIVE	1	191
PROTECTOR	6	141				RING		
PROTECTOR						KEY	3	99
BATTERY-TERMINAL	5	23				RING		
PROTECTOR						MOUNTING	1	191-192
SURGE	7	31				RING		
PROTECTOR						RETAINING	1	192
VINYL	6	141				RINGBACK	2	106
PRUNER	3	94				RINGER	1	192
PUBLIC COMMUNICATION						RINGER	7	32
EQUIPMENT	1	169-188				RINGING		
PULLER	3	94				SUPPLY	2	106
PULLEY	2	59				RINGS	2	106
PULLEY	7	31				ROBO		
PUMICE	4	27				TOOLS	3	99
PUMP	4	27				ROD	3	99
PUMP	7	31				ROD		
PUMP						GROUND	1	192
FUEL	5	23				ROD		
PUMP						GUY	1	192
WASHER	5	23				ROD		
						PLUG	1	192

R

ITEM	SECT	PAGE	ITEM	SECT	PAGE	ITEM	SECT	PAGE
ROD (CONT.)			SEALANT	1	196	SHELTER		
ROD			SEALANT			AERIAL	3	107
TIE-IN	5	24	DUCT	1	196	SHIELD	1	199
ROD			SEALED			SHIELD	2	110
TIE-OUT	5	24	BEAM	5	25	SHIELD	6	149
ROLLER	2	106	SEAT	3	103	SHIELD		
ROLLPIN	3	99	SECTION			ERASING	6	149
ROPE	3	99-100	TERMINAL	1	196-197	SHIELD		
ROPE			SELECTOR	2	107	MANHOLE	1	199
MANILA	3	100	SENSOR	7	32	SHOCKS		
ROPE			SENSOR			FRONT	5	25-26
PLASTIC	3	100	FERROD	2	107	SHOCKS		
ROTOR	3	100	SENSOR			FRONT-GAS	5	26
ROTOR	5	24-25	MOISTURE	1	197	SHOCKS		
RUBBER			SEPARATOR	2	107	REAR	5	26
BAND	6	148	SEPARATOR	6	148	SHOCKS		
RULE	3	100-101	SEPARATOR			REAR-GAS	5	26
RULER	6	148	CABLE	1	197	SHOE		
RUSTPROOF	5	25	SET	3	103-104	BENDING	3	107
			SET			SHOE		
			DATA	2	107	SHOE		
			SET			SHOE		
			DATA	7	32-33	SHOE		
			SET			TEST	3	108
			HAND	3	104	SHOULDER		
			SET			REST	1	199
			JUMPER	2	107	SHOVEL	3	108
			SET			SHURWIPE	4	28
			MANHOLE	1	197	SIDE		
			SET			SKIRT	2	110
			PLUG	2	107	SIGN	2	110
			SET			SIGN	4	28
			SUBSCRIBER	2	107	SIGN	7	34
			SET			SIGN		
			TELEPHONE	7	33	CABLE	1	199-200
			SET			SIGN		
			TELEPHONE-HAND	7	33	CONSTRUCTION	1	200
			SET			SIGN		
			TEST	2	107	ROAD	7	34-36
			SET			SIGN		
			TEST	3	104-107	ROAD-ACCESSORIES	7	36
			SET-OF-GEARS	7	33	SIGN		
			SHAFT			SAFETY	7	36-37
			MAIN	2	107	SIGN-BURIED-CABLE		
			SHANK	3	107	WARNING	1	200-201
			SHARPENER	3	107	SIGNS-&-ACCESSORIES		
			SHARPENER	6	148	FLEX-MAST	3	108-109
			SHEARS	3	107	SIGNS-&-ACCESSORIES		
			SHEARS	6	148	WINDMASTER	3	109
			SHEATH			SILICONE	1	201
			REPAIR	1	197	SILICONE		
			SHEAVE			FOAM	7	37
			SUPPORT	1	197	SILICONE		
			SHEET			SPRAY	4	28
			INDEX	6	149	SIMULATOR	3	109-110
			SHELF	1	197-199	SLATE		
			SHELF	2	108-109	MAGIC	6	149
			SHELF	7	33-34	SLEEVE	1	201
			SHELF			SLEEVE	2	110
			BATTERY	4	28	SLEEVE		
			SHELF			FUNNEL	2	110-111
			MOUNTING	2	109-110	SLEEVE		
			SHELF			IRON-SOLDERING	3	110
			REPEATER	1	199	SLEEVE		
						LEAD	1	201-202

S

ITEM	SECT	PAGE	ITEM	SECT	PAGE	ITEM	SECT	PAGE
SLEEVE (CONT.)			SPLITTER (CONT.)			STOOL		
SLEEVE			SPLITTER	3	113	FOOT	3	117
REPAIR	1	202-203	SPONGE	4	30	STOPPER		
SLEEVE			SPOOL	1	206	RUBBER	1	207
SERVING	1	203	SPOON	4	30	STRAIGHTENER		
SLEEVE			SPOTLIGHT	5	27	PIN	3	117
VAULT	1	203-204	SPRAY	2	111	STRAND		
SLEEVE			SPRAY	4	30	GALVANIZED	1	207-208
WIREWRAP	3	110	SPRAY			STRANDLINK		
SLEEVING	1	204	PLASTIC	4	31	REDUCER	1	208
SLIDER			SPRAY			STRANDWISE	1	208
TAPER-BOOT	1	204	RESTORATION	1	206	STRAP	1	208-209
SLING	3	110	SPRAY			STRAP	2	111
SLITTER	3	110-111	WASP	3	113	STRAP	3	117-118
SMOCK	6	149	SPRAYER	3	113	STRAP	4	31
SNAP	3	111	SPREADER	3	114	STRAP	6	150
SNIP	3	111	SPRING	1	206	STRAP		
SOAP	4	28-29	SPRING	2	111	CABLE	1	209
SOAP			SPRING	3	114	STRAP		
BUCKET	3	111	SPRING	7	37	GUARD	1	209-210
SOCKET	2	111	SPRING			STRAP		
SOCKET	3	111	HOLDER	2	111	JUMPER	1	210
SOCKET			SQUEEGEE	4	31	STRIP	1	210
LAMP	2	111	STAKE	1	206	STRIP	6	150
SOCKET			STAKE			STRIP		
1/2IN DRIVE	3	111-112	HARDWARE	1	206	ADHESIVE	2	111
SOCKET			STAMP	6	149	STRIP		
3/8-INCH-DRIVE	3	112	STAND	2	111	DESIGNATION	1	210
SOCKET			STAND	7	37	STRIP		
3/8IN DRIVE	3	112	STAND			DESIGNATION	2	112
SOCKET			CALENDAR	6	149	STRIP		
5/8IN DRIVE	3	112-113	STAND			FANNING	1	210
SODA			PRINTER	6	149	STRIP		
BICARB	4	29	STAPLE	1	206-207	FANNING	2	112
SOFTWARE	2	111	STAPLE	3	114	STRIP		
SOFTWARE	7	37	STAPLE	6	149-150	GROUND	1	211
SOFTWARE	8	35-38	STAPLE			STRIP		
SOLDER	1	204	REMOVER	6	150	POWER	7	37
SOLDER	3	113	STAPLER	3	114	STRIP		
SOLDERING			STAPLER	6	150	TERMINAL	2	112
IRON	3	113	STARTER	4	31	STRIPPER	3	119
SOLENOID			STARTER	5	27-28	STRIPPER	4	31
STARTER	5	27	STARTING			STUB		
SOLUTION	1	204	FLUID	5	28	CABLE	1	211-212
SOLUTION	4	30	STATIC			STUB		
SOLVENT	4	30	CONTROL	3	114-117	TERMINAL	1	212
SOLVENT			STATION			SUMP MANHOLE	3	119
CABLE-CLEANER	1	205	DATA	2	111	SUPPLIES		
SOLVENT			STATION			MEDICAL	7	37
CEMENT	1	205	TERMINATION	2	111	SUPPLY		
SPACER	1	205	STEARINE	1	207	POWER	2	112-113
SPACER			STEM			SUPPLY		
CABLE	1	205	TORCH	3	117	POWER	3	119
SPARK			STEP			SUPPLY		
PLUG	5	27	MANHOLE	1	207	POWER	7	37-38
SPEAKER	2	111	STEP			SUPPLY		
SPIRITS			POLE	1	207	RINGING	2	113
PETROLEUM	4	30	STICK	3	117	SUPPORT	1	213
SPLICE	1	205-206	STICKER			SUPPORT	3	119-120
SPLICE			WARNING	1	207	SUPPORT		
CASE	1	206	STITCHER			CABLE	1	213
SPLICE			WIRE	6	150	SUPPORT		
DROP-WIRE	1	206	STONE			INSULATOR	1	213
SPLITTER	1	206	HONING	3	117	SUPPORT		
						WIRE	1	213

ITEM	SECT	PAGE	ITEM	SECT	PAGE	ITEM	SECT	PAGE
SUPPRESSOR	7	38	TAPE (CONT.)			TERMINAL (CONT.)		
SUSPENDERS	3	120	TAPE			TERMINAL		
SUSPENSION	3	120	MEASURE	3	120-121	SOLDERLESS	1	221
SWAB	2	113	TAPE			TERMINAL		
SWAB	4	31	PICS	7	38-39	STRIP	2	115
SWAB	7	38	TAPE			TERMINAL		
SWEATBAND	3	120	PULLING	1	216	WIRE	1	221-222
SWEEEPING			TAPE			TERMINAL		
COMPOUND	4	31	SEALING	1	216-217	X-TYPE	8	55
SWITCH	2	113-114	TAPE			TERMINATION	1	222
SWITCH	3	120	TRANSPARENT	6	156	TERMINATION	2	115
SWITCH	7	38	TAPE			TERMINATION	3	123
SWIVEL	3	120	TRANSPORT	2	114	TERMINATION		
SYNTHESIZER	2	114	TAPE			ASSEMBLY	2	115
SYRINGE	2	114	VINYL	1	217	TERMINATION		
SYSTEM	1	213	TAPEWRITER			BLOCK	2	115
SYSTEM			DYMO	6	156	TERMINATION		
POWER	2	114	TARPAULIN	3	121	TEST	2	115
			TEE	1	217	TERMSEAL	1	222
			TELEPHONE			TEST		
			EQUIPMENT-ISDN	8	38-39	PROBE	3	123
			TELEPHONE			TEST		
			EQUIPMENT-MOBILE	8	39	SET	2	115
			TELEPHONE			TEST		
			SET	8	39-42	SET	3	123
			TELEPHONE-			TESTER	1	222
			MERIDIAN	8	42-43	TESTER	3	123-124
			TELEPHONE-			THERMAL	2	115
			MISCELLANEOUS	8	43-50	THERMOMETER	3	124
			TELEPHONE-SYSTEM			THERMOSTAT	1	222
			CENTRAMAX	8	50	THERMOSTAT	5	28
			TELEPHONE-SYSTEM			THUMB		
			DAVID	8	50-51	TACK	6	157
			TELEPHONE-SYSTEM			TIE		
			EMERGENCY - 911	8	51-53	CABLE	1	222-224
			TELEPHONE-SYSTEM			TIE		
			NORSTAR	8	53	TWIST	3	124
			TELEPHONE-SYSTEM			TIE		
			PAGING/HARRIS	8	54	WRAP	1	224
			TELEPRINTER	7	39	TILE	4	31
			TELETYPE			TIMER	2	115
			PAPER	6	156	TIP	3	124-125
			TEMPLATE	2	114	TIRE		
			TEMPLATE	6	156-157	AUTO	5	28-29
			TEMPLATE	7	39	TISSUE	3	125
			TENT	3	121-123	TISSUE	4	31-32
			TENTCARD			TISSUE	6	157
			TRAINING	6	157	TOILET		
			TERMINAL	2	114-115	PAPER	4	32
			TERMINAL	8	54-55	TOILET		
			TERMINAL			SEAT-COVER	4	32
			AERIAL-POLE-MOUNT	1	217-218	TONE	2	115
			TERMINAL			TONER	6	157-158
			AERIAL-STRAND	1	218-219	TOOL	3	125-127
			TERMINAL			TOOL		
			BET	1	219-220	CASE	3	127
			TERMINAL			TOOL		
			BET/NI	1	220-221	CORING	3	127
			TERMINAL			TOOL		
			BLOCK	1	221	CRIMPING	3	127-128
			TERMINAL			TOOL		
			CABLE	1	221	NUMBERED	3	129-134
			TERMINAL			TOOL		
			CROSS-CONNECT	1	221	POUCH	3	134

T

TAB	6	150-151
TAB		
INDEX	6	151-152
TABLE	7	38
TACK		
MAP	6	152
TACK		
THUMB	6	152-153
TAG	1	213-214
TAG	6	153
TAG		
CABLE	1	214
TAG		
IDENTIFICATION	1	214
TAG		
POLE	1	214-215
TAIL		
PIPE	5	28
TAMPONS	4	31
TAPE	1	215-216
TAPE	2	114
TAPE	6	153
TAPE	7	38
TAPE		
CORRECTION	6	153-154
TAPE		
DISPENSER	6	154
TAPE		
DYMO	6	154-155
TAPE		
EMBOSSSED	6	155
TAPE		
ERASER	6	155
TAPE		
FILAMENT	6	155
TAPE		
FRICTION	1	216
TAPE		
KO-REC-TYPE	6	155
TAPE		
LIFT-OFF	6	155-156
TAPE		
MASKING	6	156

ITEM	SECT	PAGE	ITEM	SECT	PAGE	ITEM	SECT	PAGE
WIRE (CONT.)								
WIRE								
STATION	1	231						
WIRELINK	1	232						
WIRES								
IGNITION	5	30-31						
WIREWISE	1	232						
WOOL	7	50						
WOOL								
STEEL	1	232						
WRAP	1	232						
WRAP								
SPLICE	1	232-233						
WRAP								
THERMAL	1	233						
WRENCH	3	138-140						
WRINGER	4	34						
WRISTREST	6	160						

X

XEROX								
PAPER	6	160						

NOTES

DISTRIBUTION SERVICES

NETWORK SERVICES

TOOLS

BUILDING JANITORIAL

AUTOMOTIVE

FORMS/OFFICE SUPPLIES

GENERAL

DATA VOICE

PRODUCT IDENTIFIER		DESCRIPTION					
ITEM NUMBER	ORD. MULT.	SELL UNIT	STD. PKG. STOCK AVAILABILITY / PA	LEAD TIME	MIN. ORD.	A	C
ABRASIVE							
900361486 ABRASIVE FLEXIBLE 5IN X 1/2IN							
N		EA	25	2	25		
82-001.							
900451089 ABRASIVE SHEATH 4435 1IN X 25YD							
5123935	1	RO	IL IN MI OH WI 08 08 08 08 08				
A flexible 80 grit, non-conductive aluminum oxide strip used to clean and rough up cable sheath.							
ACTIVATOR							
260438262 ACTIVATOR 1/2 TAP F-560209							
N		EA	1	4	1		
For RLS Self Strip Block.							
260446703 ACTIVATOR HALF-TAP RLS50							
N							
For use with Reliance self-strip cross-connect boxes.							
260441506 ACTIVATOR RLS REPLACEMENT							
N		EA	1	4	10		
For Reliable self-strip cabinets.							
ADAPTER							
105034482 ADAPTER 1A1							
N		EA	1	3	1		
300049152 ADAPTER 4							
N		EA	1	3	1		
100000447 ADAPTER 133E							
1100222	1	EA	IL IN MI OH WI 08 08 08				
To install splice cases and sheath mounted terminals on entering cables of smaller diameter than the case cavity, BSP 633-400-200. DISCONTINUE, ORDER NON STOCK UPON STOCK DEPLETION							
100000611 ADAPTER 152A							
1100404	1	EA	IL IN MI OH WI 18 18 18 18				
Intended for use in mounting a 66E3-25 connecting block in conjunction with over or under floor duct systems.							
100000686 ADAPTER 161A							
1100529	2000	EA	IL IN MI OH WI 18 18 18 18				
Designed to fit over the terminals of 66 type blocks for the purpose of attaching spade tip ended cords.							
101334407 ADAPTER 183A 2							
1100602	1	EA	IL IN MI OH WI 18 18 18 18 18				
Used on 66-type connecting block when additional terminals are required. 2 terminal variety, quick clip, BSP 518-300-100.							

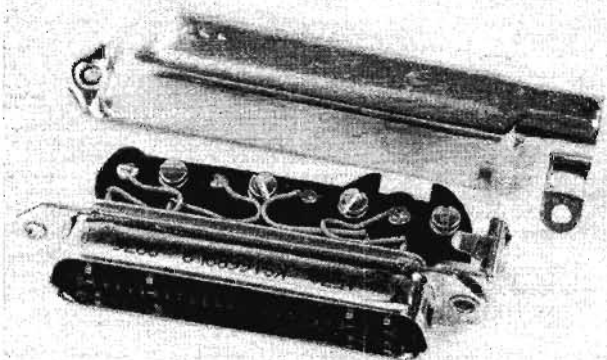
PRODUCT IDENTIFIER		DESCRIPTION					
ITEM NUMBER	ORD. MULT.	SELL UNIT	STD. PKG. STOCK AVAILABILITY / PA	LEAD TIME	MIN. ORD.	A	C
101539831 ADAPTER 183B 2							
5227728	1	EA	IL IN MI OH WI 18 18 18 18 18				
For pair multiplying on 5A1 type terminal block, BSP 465-265-201.							
102930906 ADAPTER 280B1							
N		EA	1	1	1		
Consists of a molded plastic PVC compound. Taped plug and a flexible bond clamp arrangement. Used by Aerial Plant, replaces Adapter 170B1. NOW AVAILABLE THROUGH TOUCH-TONE ORDER ENTRY.							
102930914 ADAPTER 280C1							
N		EA	1	1	1		
Used with 18C type closures. NOW AVAILABLE THROUGH TOUCH-TONE ORDER ENTRY.							
280008806 ADAPTER 322							
1921478	1	EA	IL IN MI OH WI 18 18 18 18 18				
300033537 ADAPTER 350 SIECOR							
5107896	1	EA	IL IN MI OH WI 18				
100000629 ADAPTER 153A							
1131094	1	EA	IL IN MI OH WI 18 18 18 18 18				
Uses a CK16689 L6 plug and a CK16690 L4 connector, respectively, with a terminal block. Provides a means to connect to connector cables or bridging adapters, BSP 461-200-182.							
							
1131094							
102945524 ADAPTER 153AM 2							
N		EA	1	3	1		
A six position four contact jack wired to a CK16689 L24 plug for connecting single line modular telephones to 25 pair connector cable, BSP 461-200-102.							
103065785 ADAPTER 153AM 3							
1162354	1	EA	IL IN MI OH WI 18 18 18 18 18				
Consists of a CK16689 L24 plug wired to a 6 position, 6 contact, miniature modular jack. Used to connect standard modular cord to a 25B connector cable, BSP 461-200-102.							
100000637 ADAPTER 153B							
N		EA	1	2	1		

ADAPTER

PRODUCT IDENTIFIER DESCRIPTION

ITEM	ORD.	SELL	STD. PKG.	LEAD TIME	MIN.	A
NUMBER	MULT.	UNIT	STOCK AVAILABILITY / PA		ORD.	C

102945540 ADAPTER 153BM 2
 1164053 1 EA IL IN MI OH WI
 18
 DISCONTINUE, ORDER NON STOCK UPON STOCK DEPLETION

103065801 ADAPTER 153BM 3
 1128835 1 EA IL IN MI OH WI
 18 18
 Replaces Adapter 153 RM 1. Used to connect 6 conductor modular plug to cable plug. DISCONTINUE, ORDER NON STOCK UPON STOCK DEPLETION

101726362 ADAPTER 153C
 1168971 1 EA IL IN MI OH WI
 18 18 18 18 18
 These adapters are arranged for 2 line pickup and lead control, BSP 461-200-120.

101726370 ADAPTER 153D
 1169938 1 EA IL IN MI OH WI
 18 18 18 18 18
 Used to plug customer provided modems into 50 pin interface. Used with 2-line pick-up and A lead control, BSP 461-200-102.

102605136 ADAPTER 258A
 N EA 1 2 1
 Provides six 8 position modular jacks wired to a 50 contact plug, used to adapt a 25pr connector cable, or 66 type block. For DCTS installation. NOW AVAILABLE THROUGH TOUCH-TONE ORDER ENTRY.

102631413 ADAPTER 259A
 1120063 1 EA IL IN MI OH WI
 18 18 18 18 18
 An eight position modular jack from an electronic key telephone set to the first four pairs of a 25 pair amphenol connector, BSP 461-200-102.

102655560 ADAPTER 259B
 1120089 1 EA IL IN MI OH WI
 18 18 18 18 18
 An eight position modular jack wired to the second four pairs of a 25 pair amphenol connector, BSP 461-200-102.

103339396 ADAPTER 259C
 N EA 1 3 1
 Used to connect met sets to existing 25 pair connector cables for inservice conversion. BSP 461-200-102.

280071515 ADAPTER 45124-1A
 N EA 1 2 1
 Twenty-five pair cable is hooked into the side similar to a RJ21X and there are 12 four conductor modular type jacks mounted in the adapter.

280002015 ADAPTER 3 1/2 SQ X 4IN TEL 6IN
 N EA 1 2 1

280001967 ADAPTER 3 1/2 SQ X 4IN TEL 18IN
 N EA 1 2 1

PRODUCT IDENTIFIER DESCRIPTION

ITEM	ORD.	SELL	STD. PKG.	LEAD TIME	MIN.	A
NUMBER	MULT.	UNIT	STOCK AVAILABILITY / PA		ORD.	C

280023573 ADAPTER 3 1/4 SQ X 3 1/2IN IPS 6IN
 N EA 1 1 1

280001959 ADAPTER 3 1/4 SQ X 3 1/2IN RD
 N EA 1 2 1
 1PS 18

280001991 ADAPTER 3 1/4 SQ X 4IN TEL 6IN
 N EA 1 2 1

280023607 ADAPTER 4IN SQ X 4IN TEL 6IN
 N EA 1 1 1

280001983 ADAPTER 4IN SQ X 4IN TEL 18IN
 N EA 1 2 1

260440235 ADAPTER 4IN BELL TYPE - SMOOTH CORE
 N

260440243 ADAPTER 4IN FLARED - SMOOTH CORE
 N

280007832 ADAPTER 553150-1 MULTI-JACK
 N EA 1 4 1
 AMP, A1 lead common, allows tapping off 25-pair connectors to 5 modular jack interfaces.

280002049 ADAPTER BELL D
 N EA 1 2 1

401949599 ADAPTER BORE SPLT SQ 3 1/4 X 3 1/2IN
 N EA 24 1 24
 24 per package.

000260059 ADAPTER BR2580A
 1143198 1 EA IL IN MI OH WI
 18 18 18 18 18
 A six-out adapter, converts a 25 pair inside wiring cable to six 4 pair modular jack positions.

280007949 ADAPTER BRIDGING 554166-2 AMP
 N EA 1 3 1
 Kit with 4 pair modular jack.

996131363 ADAPTER BRIDGING CK19252 L3
 1100727 1 EA IL IN MI OH WI
 18 18 18 18 18
 A three way bridging adapter, equipped with 3 plugs, BSP 461-200-182.

002083038 ADAPTER BR-1A-2P IN-LINE
 1159152 1 EA IL IN MI OH WI
 18 18 18 18
 In-line adapter used to connect modular ended insidewire to telephone set line cords. May also be used as an RJ11C or RJ14C.

403878432 ADAPTER BR-1A-4C
 N EA 1 3 10

403384712 ADAPTER BR-1A-4P IN-LINE
 1226811 1 EA IL IN MI OH WI
 18 18 18 18
 A modular in-line adapter, double-ended receptacle which accepts either four or eight conductor modular line cords. Used to connect 2 under carpet 4 pair flat cables.

DISTRIBUTION SERVICES
 NETWORK SERVICES
 TOOLS
 BUILDING JANITORIAL
 AUTOMOTIVE
 FORMS/OFFICE SUPPLIES
 GENERAL
 DATA VOICE

DISTRIBUTION SERVICES

PRODUCT IDENTIFIER		DESCRIPTION					
ITEM NUMBER	ORD. MULT.	SELL UNIT	STD. PKG. STOCK AVAILABILITY / PA	LEAD TIME	MIN. ORD.	A C	
260328240 ADAPTER CHANNEL ACCESS TEST CI TP96							
1946087	1	EA	IL IN MI OH WI 18 18 18 18 18				
260357231 ADAPTER MODULAR BRIDGING KIT							
1952663	1	EA	IL IN MI OH WI 18				
P/N 554186-1 ACC# 093070-1066.							
260405832 ADAPTER PANEL PA-93-4B							
N		EA	1	4	1		
Homaco.							
300049251 ADAPTER SPLIT 3 1/2 X 4IN ROUND							
N		EA	1	2	1		
260354949 ADAPTER VIS-A-FLAME							
1952473	1	EA	IL IN MI OH WI 08 08 08 08				

ADAPTER SUPER MODULE

Adapter houses five single line module jacks wired to a 25 pair connector. Comes in 5 modules, one for each color group of the 25 pair cable.

002048031 ADAPTER SUPER MODULE V001 WHITE						
1143271	1	EA				
002048049 ADAPTER SUPER MODULE V002 RED						
1138248	1	EA	IL IN MI OH WI 18 18 18 18 18			
002048056 ADAPTER SUPER MODULE V003 BLACK						
1136952	1	EA	IL IN MI OH WI 18 18 18 18 18			
002048064 ADAPTER SUPER MODULE V004 YELLOW						
1441840	1	EA	IL IN MI OH WI 18 18 18 18 18			
002048072 ADAPTER SUPER MODULE V005 VIOLET						
1133371	1	EA	IL IN MI OH WI 18 18 18 18 18			
002048080 ADAPTER SUPER MODULE V006 WR						
N		EA	1	3	1	
002070126 ADAPTER SUPER MODULE V009 GREEN						
N		EA	1	3	1	

ADHESIVE

400485793 ADHESIVE 3M 847 5OZ TUBE						
1101337	1	TU				

ANCHOR

400826111 ANCHOR WALL GRIP 1/8IN DL						
2754226	1	EA				
Drive, Star.						

PRODUCT IDENTIFIER		DESCRIPTION					
ITEM NUMBER	ORD. MULT.	SELL UNIT	STD. PKG. STOCK AVAILABILITY / PA	LEAD TIME	MIN. ORD.	A C	
401488457 ANCHOR WELL NUT E632 3/4MS							
1102301	1	EA	IL IN MI OH WI 18 18				

ANCHOR CAULKING

401324678 ANCHOR CAULKING 10/24 3030						
N		EA	100	3	100	
NOW AVAILABLE THROUGH TOUCH-TONE ORDER ENTRY.						
995998283 ANCHOR CAULKING 1/4 20						
N		EA	100	1	100	
996782009 ANCHOR CAULKING 3/8 16						
N		EA	50	3	50	

ANCHOR EXPANSION

CA08698. TO BE USED WITH ROD GUY. BSP 621-415-200.						
401118278 ANCHOR EXPANSION B 6						
N		EA	12	4	12	
NOW AVAILABLE THROUGH TOUCH-TONE ORDER ENTRY.						
401118286 ANCHOR EXPANSION B 8						
1102038	1	EA	IL IN MI OH WI 14 14 14 14 14			
An expanding anchor used to anchor guy wires, for 5/8in rod.						
401118294 ANCHOR EXPANSION B 10						
1100875	1	EA	IL IN MI OH WI 14 14 14 14 14			
For 3/4in rod.						
401118302 ANCHOR EXPANSION B 12						
N		EA	2	8	2	
For 1in or 1 1/4in rod. NOW AVAILABLE THROUGH TOUCH-TONE ORDER ENTRY.						

ANCHOR GUY

260382908 ANCHOR GUY 10IN TWIN						
1962464	1	EA				
SOE helix/rod combination, 10IN twin helix, 3/4IN anchor rod, tripeye nut.						
260382890 ANCHOR GUY 12IN SINGLE						
1962472	1	EA	IL IN MI OH WI 14 14 14 14 14			
SOE helix/rod combination, 12IN single helix, 3/4IN anchor rod, tripeye nut.						
400003117 ANCHOR GUY B11 W/ROD CA07907						
1100834	1	EA	IL IN MI OH WI 14 14 14 14 14			
Screw type anchor used in rock free soil (Clay, Loam or Sand). Size 11 E/W 5/8in rod. BSP 621-415-201. DISCONTINUE UPON STOCK DEPLETION - REPLACED BY ANCHOR GUY 12IN SINGLE (1962472).						

NETWORK SERVICES

TOOLS

BUILDING JANITORIAL

AUTOMOTIVE

FORMS/OFFICE SUPPLIES

GENERAL

DATA VOICE

DISTRIBUTION SERVICES
 NETWORK SERVICES
 TOOLS
 BUILDING JANITORIAL
 AUTOMOTIVE
 FORMS/OFFICE SUPPLIES
 GENERAL
 DATA VOICE

ANCHOR GUY

PRODUCT IDENTIFIER		DESCRIPTION						
ITEM NUMBER	ORD. MULT.	SELL UNIT	STD. PKG.	LEAD TIME	MIN. ORD.	A	C	
			STOCK AVAILABILITY / PA					
400003125 ANCHOR GUY B13 W/ROD CA07907								
1100859	1	EA	IL	IN	MI	OH	WI	
			14	14	14	14	14	
Screw type anchor used in rock free soil (Clay, Loam or Sand). Size 13 E/W 3/4in rod. BSP 621-415-201. DISCONTINUE UPON STOCK DEPLETION - REPLACED BY ANCHOR GUY 12IN SINGLE (1962472).								
402361661 ANCHOR GUY C 1 W/ROD CA08891								
1193193	1	EA	IL	IN	MI	OH	WI	
			14	14	14	14	14	
Screw type anchor used in varying types of soil. Twin 10in, 1in rod, triple eye. BSP 621-415-204. DISCONTINUE UPON STOCK DEPLETION - REPLACED BY ANCHOR GUY 10IN TWIN (1962464).								
402361695 ANCHOR GUY C 4 W/ROD CA08891								
1171686	1	EA	IL	IN	MI	OH	WI	
			14	14	14	14	14	
Single 10in, 3/4in rod, twin eye. BSP 621-415-204. DISCONTINUE UPON STOCK DEPLETION - REPLACED BY ANCHOR GUY 10IN TWIN (1962464).								
260338165 ANCHOR GUY EARTH MANTA RAY-1								
1948000	1	EA	IL	IN	MI	OH	WI	
			14	14	14	14	14	
260338173 ANCHOR GUY TEMPORARY 88-DBU								
1948018	1	EA	IL	IN	MI	OH	WI	
			14	14	14	14	14	

ANCHOR HELIX

TO BE USED WITH ROD ANCHOR.

260382874 ANCHOR HELIX 10IN TWIN

1962480 1 EA
 SOE helix, for use with ROD ANCHOR 3/4IN (1962506) or ROD ANCHOR 1IN. 1 1/2IN core.



260382874

260382973 ANCHOR HELIX 10IN TWIN

N EA 1 8 1
 For use with ROD ANCHOR 3/4IN (1962506) or ROD ANCHOR 1IN. 1 3/8IN core. NOW AVAILABLE THROUGH TOUCH-TONE ORDER ENTRY.

PRODUCT IDENTIFIER		DESCRIPTION						
ITEM NUMBER	ORD. MULT.	SELL UNIT	STD. PKG.	LEAD TIME	MIN. ORD.	A	C	
			STOCK AVAILABILITY / PA					
260382866 ANCHOR HELIX 12IN SINGLE								
1962498	1	EA	IL	IN	MI	OH	WI	
			14	14	14	14	14	
SOE helix, for use with ROD ANCHOR 3/4IN (1962506) or ROD ANCHOR 1IN. 1 1/2IN core.								
								
1962498								
260382957 ANCHOR HELIX 12IN SINGLE								
N	EA	4	8	4				
For use with ROD ANCHOR 5/8IN. 1 3/8IN core. NOW AVAILABLE THROUGH TOUCH-TONE ORDER ENTRY.								
260327978 ANCHOR HELIX B 9 5/8IN CA07907								
1945659	1	EA	IL	IN	MI	OH	WI	
			14	14	14	14	14	
DISCONTINUE, ORDER NON STOCK UPON STOCK DEPLETION								
280080177 ANCHOR HELIX C 7 CA08891								
1936823	1	EA	IL	IN	MI	OH	WI	
			14	14	14	14	14	
DISCONTINUE, ORDER NON STOCK UPON STOCK DEPLETION								

ANCHOR MASONRY

260382148 ANCHOR MASONRY WEDGE 1/2IN X 2 3/4IN

1961359 1 EA
 A one piece masonry anchor used to support large cabinets and terminals to brick or concrete surfaces.

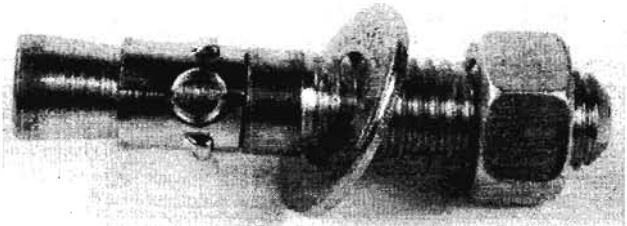

260382148

260388590 ANCHOR MASONRY WEDGE 1/4 X 2 1/4

1964288 1 EA
 IL IN MI OH WI
 18 18 18 18 18
 Star 3515-22000.

DISTRIBUTION SERVICES

NETWORK SERVICES

TOOLS

BUILDING JANITORIAL

AUTOMOTIVE

FORMS/OFFICE SUPPLIES

GENERAL

DATA VOICE

PRODUCT IDENTIFIER DESCRIPTION

ITEM NUMBER	ORD. MULT.	SELL UNIT	STD. PKG. STOCK AVAILABILITY / PA	LEAD TIME	MIN. ORD.	A C
-------------	------------	-----------	-----------------------------------	-----------	-----------	-----

260382155 ANCHOR MASONRY WEDGE 3/8IN X 2 1/8IN
 1961367 1 EA IL IN MI OH WI
 18 18 18 18 18
 A one piece masonry anchor used to support large cabinets and terminals to brick or concrete surfaces.

ANCHOR NO WRENCH

HAND INSTALLED GUY ROD.
260302278 ANCHOR NO WRENCH EARTH 4IN
 N EA 100 8 100
 3/4IN X 54IN, 2.2M, Tripleye.

401125687 ANCHOR NO WRENCH EARTH 4IN
 1100891 1 EA IL IN MI OH WI
 14 14 14 14 14
 3/4IN X 54IN, 2.2M, Singleye. 4 inch diameter integral type with 3/4IN rod for use with galvanized wire guys. BSP 621-415-201.



1100891

260302286 ANCHOR NO WRENCH EARTH 6IN
 N EA 100 8 100
 3/4IN X 66IN, Tripleye.

401324710 ANCHOR NO WRENCH EARTH 6IN
 N EA 20 8 20
 3/4IN X 66IN, Singleye. NOW AVAILABLE THROUGH TOUCH-TONE ORDER ENTRY.

260406376 ANCHOR NO WRENCH EARTH 8IN
 1969907 1 EA IL IN MI OH WI
 14 14
 1IN X 66IN 6M Tripleye.

401324702 ANCHOR NO WRENCH EARTH 8IN
 1161554 1 EA IL IN MI OH WI
 14 14
 1IN X 66IN 6M Singleye.

260406384 ANCHOR NO WRENCH EARTH 10IN
 1969915 1 EA IL IN MI OH WI
 14
 1 1/4IN X 66IN. 10M Tripleye.

260406392 ANCHOR NO WRENCH EXTENSION
 1969923 1 EA IL IN MI OH WI
 14
 1 1/4IN X 6FT. Tripleye.

ANCHOR PLASTIC

400003315 ANCHOR PLASTIC D10
 2780965 1 PK
 CA08181. A plastic anchor for use with wood screws when making attachments to masonry. Package of 8, BSP 080-720-113.

PRODUCT IDENTIFIER DESCRIPTION

ITEM NUMBER	ORD. MULT.	SELL UNIT	STD. PKG. STOCK AVAILABILITY / PA	LEAD TIME	MIN. ORD.	A C
-------------	------------	-----------	-----------------------------------	-----------	-----------	-----

400003323 ANCHOR PLASTIC D12
 2780981 1 PK IL IN MI OH WI
 18 18 18 18 18
 CA08181. A plastic anchor for use with wood screws when making attachments to masonry. Package of 8, BSP 080-720-113.

400003331 ANCHOR PLASTIC D16
 2781005 1 PK IL IN MI OH WI
 18 18 18 18 18
 CA08181. A plastic anchor for use with wood screws when making attachments to masonry. Package of 8, BSP 080-720-113.

260382684 ANCHOR PLASTIC SIZE 10
 1961706 1 PK IL IN MI OH WI
 18 18 18 18 18
 Star fastener 0610-07000, Package of 100.

260402797 ANCHOR PLASTIC SIZE 12
 1968487 1 PK IL IN MI OH WI
 18 18 18 18 18
 For use with wood screws when making attachments to masonry, Star 0612-10000, Package of 100.

260402789 ANCHOR PLASTIC SIZE 16
 1968479 1 PK IL IN MI OH WI
 18 18 18 18 18
 For use with wood screws when making attachments to masonry, Star 01616-13000, Package of 50.

ANCHOR ROD

260382882 ANCHOR ROD 3/4IN X 7FT TRIPLEYE
 1962506 1 EA
 SOE rod, for use with ANCHOR HELIX 12IN SINGLE (1962498) or ANCHOR HELIX 10IN TWIN (1962480).

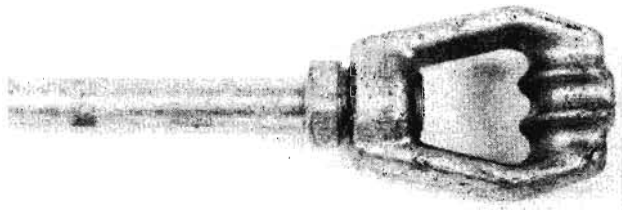

260382882

260382932 ANCHOR ROD 5/8IN X 7FT TRIPLEYE
 N EA 5 8 5
 NOW AVAILABLE THROUGH TOUCH-TONE ORDER ENTRY.

260382940 ANCHOR ROD 1IN X 7FT TRIPLEYE
 N EA 2 8 2
 NOW AVAILABLE THROUGH TOUCH-TONE ORDER ENTRY.

ANCHOR SCREW

900227810 ANCHOR SCREW LEAD 10-14 X 1 IN
 N EA 100 2 500
 Scruin.

DISTRIBUTION SERVICES

NETWORK SERVICES

TOOLS

BUILDING JANITORIAL

AUTOMOTIVE

FORMS/OFFICE SUPPLIES

GENERAL

DATA VOICE

ANCHOR SCREW

PRODUCT IDENTIFIER		DESCRIPTION				
ITEM NUMBER	ORD. MULT.	SELL UNIT	STD. PKG. STOCK AVAILABILITY / PA	LEAD TIME	MIN. ORD.	A C
400473641			ANCHOR SCREW LEAD 10-14 X 1 1/2IN			
N		EA	100	2	500	
NOW AVAILABLE THROUGH TOUCH-TONE ORDER ENTRY.						
400473559			ANCHOR SCREW LEAD 16-18 X 1 1/2IN			
N		EA	100	2	500	
401324686			ANCHOR SCREW MACHINE 10 X 24IN			
N		EA	100	2	500	
Tampin open bottom. NOW AVAILABLE THROUGH TOUCH-TONE ORDER ENTRY.						
401324694			ANCHOR SCREW MACHINE 20 X 1/4IN			
N		EA	100	2	500	
Tampin open bottom.						

ANCHOR SCREW WALL B

CA08180. Molly, for attaching various items of station apparatus to interior walls, BSP 080-720-115.

401899471			ANCHOR SCREW WALL B 1				
N		PK	50	8	50		
400003380			ANCHOR SCREW WALL B 4				
1102012	1	PK	IL 18	IN 18	MI 18	OH 18	WI 18
400003406			ANCHOR SCREW WALL B 6				
1102053	1	PK	IL 18	IN 18	MI 18	OH 18	WI 18
400003422			ANCHOR SCREW WALL B 8				
1100917	1	PK	IL 18	IN 18	MI 18	OH 18	WI 18

400407722			ANCHOR SCREW WALL B 10			
N		PK	50	8	50	
NOW AVAILABLE THROUGH TOUCH-TONE ORDER ENTRY.						
400003455			ANCHOR SCREW WALL B 11			
N		PK	25	8	25	
400003463			ANCHOR SCREW WALL B 12			
N		PK	25	8	25	
400003471			ANCHOR SCREW WALL B 13			
N		PK	25	8	25	
400003489			ANCHOR SCREW WALL B 14			
N		PK	25	8	25	

ANCHOR SCREW WOOD

401130638			ANCHOR SCREW WOOD 6- 8 X 3/4IN			
N		EA	100	3	100	
NOW AVAILABLE THROUGH TOUCH-TONE ORDER ENTRY.						
401261450			ANCHOR SCREW WOOD 6- 8 X 1 IN			
N		EA	100	3	100	

PRODUCT IDENTIFIER		DESCRIPTION				
ITEM NUMBER	ORD. MULT.	SELL UNIT	STD. PKG. STOCK AVAILABILITY / PA	LEAD TIME	MIN. ORD.	A C
400473542			ANCHOR SCREW WOOD 6- 8 X 1 1/2IN			
N		EA	100	3	100	
401130661			ANCHOR SCREW WOOD 6-18 X 1 IN			
N		EA	100	3	100	
401261441			ANCHOR SCREW WOOD 10-14 X 3/4IN			
N		EA	100	3	100	
997905567			ANCHOR SCREW WOOD 10-14 X 1 IN			
N		EA	100	3	100	
401130646			ANCHOR SCREW WOOD 10-14 X 1 1/2IN			
N		EA	100	3	100	
900227836			ANCHOR SCREW WOOD 16-18 X 1 1/2IN			
N		EA	100	3	100	

ANCHOR SHIELD

900210915			ANCHOR SHIELD EXPANSION			
1153643	1	EA	3/8in X 2in hole. Used to attach miscellaneous items to building walls.			

900210931			ANCHOR SHIELD EXPANSION DOUBLE				
1181297	1	EA	IL 08	IN 08	MI 08	OH 08	WI 08
3/8in X 2 1/8in double 7025-00000, 3/4in hole. Expanding type shield used to fasten outdoor booths to concrete and also to attach wall straps to buildings.							

400487625			ANCHOR SHIELD EXPANSION W/BOLT			
N		EA	25	2	125	
1/2in x 2 1/2in single loxin.						

400487609			ANCHOR SHIELD EXPANSION W/BOLT			
N		EA	50	1	50	
3/8in x 2 1/2in double.						

900227802			ANCHOR SHIELD EXPANSION W/BOLT 10081				
1101444	1	EA	IL 08	IN 08	MI 08	OH 08	WI 08
1/2in. x 2 1/2in. Masonry anchor for making attachments in masonry, BSP 080-720-114.							

401320775			ANCHOR SHIELD EXPANSION W/O BOLT			
N		EA	25	2	125	
1/2in x 2 1/2in.						

400487666			ANCHOR SHIELD EXPANSION W/O BOLT			
N		EA	50	3	50	
3/8in x 2 1/2in double.						

PRODUCT IDENTIFIER		DESCRIPTION				
ITEM NUMBER	ORD. MULT.	SELL UNIT	STD. PKG. STOCK AVAILABILITY / PA	LEAD TIME	MIN. ORD.	A C

ANCHOR STEEL B

CA08899. Used to attach telephone equipment to masonry structures, Box of 100.

402377865 ANCHOR STEEL B 1/4IN X 1 1/4IN
1952853 1 BX

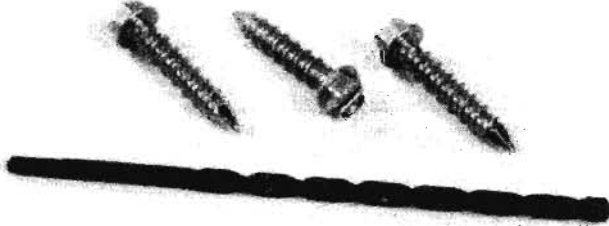

402377865

402377873 ANCHOR STEEL B 1/4IN X 1 3/4IN
5432567 1 BX IL IN MI OH WI
18 18 18 18 18

402377881 ANCHOR STEEL B 1/4IN X 2 1/4IN
1920967 1 BX IL IN MI OH WI
18 18 18 18 18

402377899 ANCHOR STEEL B 1/4IN X 2 3/4IN
1952838 1 BX IL IN MI OH WI
18 18 18 18 18

402377824 ANCHOR STEEL B 3/16IN X 1 1/4IN
1920959 1 BX IL IN MI OH WI
18 18 18 18 18

402377840 ANCHOR STEEL B 3/16IN X 2 1/4IN
1952846 1 BX IL IN MI OH WI
18 18 18 18 18

ANCHOR TOGGLER

002073864 ANCHOR TOGGLER TA 1/8 X 1/4
N BX 1 1 20

401748439 ANCHOR TOGGLER TB 3/8 X 1/2
N BX 1 1 20
For making permanent screw attachments in 3/8in to 1/2in plaster, drywall, brick, concrete and etc., package of 100.

401748447 ANCHOR TOGGLER TC 5/8 X 3/4
N BX 100 1 100
Box of 100.

ARM EXTENSION

400004149 ARM EXTENSION CABLE B CA06398
1102426 1 EA
A steel fixture for suspending aerial cable at a distance of 28in to 44in from the pole, BSP 627-220-202.

PRODUCT IDENTIFIER		DESCRIPTION				
ITEM NUMBER	ORD. MULT.	SELL UNIT	STD. PKG. STOCK AVAILABILITY / PA	LEAD TIME	MIN. ORD.	A C

400004156 ARM EXTENSION CABLE C CA06398
1102442 1 EA IL IN MI OH WI
14 14 14 14 14
A steel fixture for use where offsets of about 18in to 24in from the pole is required. BSP 627-220-202.

ASSEMBLY

280052788 ASSEMBLY BOOT TAPER TRMX C2298
N EA 1 4 20
NOW AVAILABLE THROUGH TOUCH-TONE ORDER ENTRY.

844017491 ASSEMBLY BRACKET & SNAP
1925917 1 EA IL IN MI OH WI
08 08 08 08
Used with Set Hand 1015B.

260412523 ASSEMBLY KIT 06010001
N EA 1 3 1
Upper/lower channel.

400474995 ASSEMBLY MAGNET CK20458 L11
2398123 1 EA IL IN MI OH WI
18 18 18 18 18
Package of 4.

260329511 ASSEMBLY PRETERMINATED JUMPER
N EA 12 2 12
4000D-72PTJ.

842705907 ASSEMBLY SCREW WASHER 842705907
5102707 1 EA IL IN MI OH WI
08

260432919 ASSEMBLY TOOL FIBER OPTIC 2501
N EA 1 3 1

ASSEMBLY CABLE

260427794 ASSEMBLY CABLE FDLC 06010018 22FT
1977694 1 EA
Tinned copper. 25pr Unshielded Cable.

260412366 ASSEMBLY CABLE FDLC 06-01-0002
N EA 1 3 1
050ft, 100 pair, 24 gauge, unshielded.

260412374 ASSEMBLY CABLE FDLC 06-01-0003
N EA 1 3 1
100ft, 100 pair, 24 gauge, unshielded.

260412382 ASSEMBLY CABLE FDLC 06-01-0004
N EA 1 3 1
150ft, 100 pair, 24 gauge, unshielded.

260411442 ASSEMBLY CABLE FDLC 06-01-0005
N EA 1 3 1
200ft.

260412390 ASSEMBLY CABLE FDLC 06-01-0006
N EA 1 3 1
250ft, 100 pair, 24 gauge, unshielded.

DISTRIBUTION SERVICES

NETWORK SERVICES

TOOLS

BUILDING JANITORIAL

AUTOMOTIVE

FORMS/OFFICE SUPPLIES

GENERAL

DATA VOICE

DISTRIBUTION SERVICES

NETWORK SERVICES

TOOLS

BUILDING JANITORIAL

AUTOMOTIVE

FORMS/OFFICE SUPPLIES

GENERAL

DATA VOICE

ASSEMBLY CABLE

PRODUCT IDENTIFIER		DESCRIPTION				
ITEM NUMBER	ORD. MULT.	SELL UNIT	STD. PKG. STOCK AVAILABILITY / PA	LEAD TIME	MIN. ORD.	A C
260412408 ASSEMBLY CABLE FDLC 06-01-0007						
N		EA	1	3	1	
300ft, 100 pair, 24 gauge, unshielded.						
260411392 ASSEMBLY CABLE FDLC 06-01-0008						
N		EA	1	3	1	
6'6in, 012 pair, 24 gauge.						
260412416 ASSEMBLY CABLE FDLC 06-01-0009						
N		EA	1	3	1	
030ft, 100 pair, 24 gauge, unshielded.						
260412440 ASSEMBLY CABLE FDLC 06-01-0014						
N		EA	1	3	1	
2' x 6in x 3', 1 conductor, 18 gauge, stranded, black.						
260412457 ASSEMBLY CABLE FDLC 06-01-0015						
N		EA	1	3	1	
2' x 6in x 12', 1 conductor, 18 gauge, stranded, black.						
260412465 ASSEMBLY CABLE FDLC 06-01-0016- 10						
N		EA	1	3	1	
Up to 10ft, 3 pair, 24 gauge, unshielded.						
260412473 ASSEMBLY CABLE FDLC 06-01-0016- 20						
N		EA	1	3	1	
Over 10' to 20', 3 pair, 24 gauge, unshielded.						
260412481 ASSEMBLY CABLE FDLC 06-01-0016- 30						
N		EA	1	3	1	
030ft, 003 pair, 24 gauge.						
260412499 ASSEMBLY CABLE FDLC 06-01-0017-100						
N		EA	1	3	1	
Over 100ft to 150ft.						
260412515 ASSEMBLY CABLE FDLC 06-01-0017-200						
N		EA	1	3	1	
Up to 200ft, 25 pair, 24 gauge, unshielded.						
105357925 ASSEMBLY CABLE ST-ST DUPLEX SM 2MT						
N		EA	1	6	1	
106450299 ASSEMBLY CABLE ST-ST DUPLEX SM 4MT						
N		EA	1	6	1	
106450273 ASSEMBLY CABLE ST-ST DUPLEX SM 5.5						
N		EA	1	6	1	
105357958 ASSEMBLY CABLE ST-ST DUPLEX SM 6MT						
N		EA	1	6	1	
106450257 ASSEMBLY CABLE ST-ST DUPLEX SM 6.5						
N		EA	1	6	1	
106450265 ASSEMBLY CABLE ST-ST DUPLEX SM 7MT						
N		EA	1	6	1	
260327986 ASSEMBLY CABLE TIE AND BASE						
N		EA	100	3	100	
100/bag, 792.						

PRODUCT IDENTIFIER		DESCRIPTION				
ITEM NUMBER	ORD. MULT.	SELL UNIT	STD. PKG. STOCK AVAILABILITY / PA	LEAD TIME	MIN. ORD.	A C

ATTENUATOR

260386586 ATTENUATOR 5 DB						
N		EA	1	4	1	
260386560 ATTENUATOR 10 DB						
N		EA	1	4	1	
260386552 ATTENUATOR 15 DB						
N		EA	1	4	1	
260963814 ATTENUATOR 20 DB BULKHEAD MODE						
N		EA	1	1	1	

260027313 ATTENUATOR 008-05
1215012 6 PK IL IN MI OH WI

260027321 ATTENUATOR 008-10
1215021 6 PK IL IN MI OH WI

260027339 ATTENUATOR 008-20
1215046 6 PK IL IN MI OH WI

260968987 ATTENUATOR AI05FMM13
N EA 1 3 1

260968953 ATTENUATOR AI05FMM85
N EA 1 3 1

260968995 ATTENUATOR AI10FMM13
N EA 1 3 1

260968961 ATTENUATOR AI10FMM85
N EA 1 3 1

260969001 ATTENUATOR AI15FMM13
N EA 1 3 1

260968979 ATTENUATOR AI15FMM85
N EA 1 3 1

260029731 ATTENUATOR LAI-05-N-SM 5DB
N EA 1 4 1
ST/PC single mode fixed. NOW AVAILABLE THROUGH TOUCH-TONE ORDER ENTRY.

260029749 ATTENUATOR LAI-10-N-SM 10DB
N EA 1 4 1
ST/PC single mode fixed.

260029756 ATTENUATOR LAI-15-N-SM 15DB
N EA 1 4 1
ST/PC single mode fixed.

260030176 ATTENUATOR SECR ATN008-15DB
N PK 1 3 1

DISTRIBUTION SERVICES

NETWORK SERVICES

TOOLS

BUILDING JANITORIAL

AUTOMOTIVE

FORMS/OFFICE SUPPLIES

GENERAL

DATA VOICE

PRODUCT IDENTIFIER		DESCRIPTION				
ITEM NUMBER	ORD. MULT.	SELL UNIT	STD. PKG. STOCK AVAILABILITY / PA	LEAD TIME	MIN. ORD.	A C

PRODUCT IDENTIFIER		DESCRIPTION				
ITEM NUMBER	ORD. MULT.	SELL UNIT	STD. PKG. STOCK AVAILABILITY / PA	LEAD TIME	MIN. ORD.	A C

BACKBOARD

401328471 BACKBOARD	19	1/2IN X 20IN X 5/8IN				
1105486	1	EA				
100006006 BACKBOARD	79 A	112108 METAL				
5103879	1	EA	IL IN MI OH WI			
			18 18 18 18			
Color coded, use with 66 type block.						
100006014 BACKBOARD	81	WOOD				
1155358	1	EA	IL IN MI OH WI			
			18 18 18 18			
For mounting five or less 58AP or 98A protectors, 12 1/2in X 25 1/2in, BSP 463-130-100.						
100006022 BACKBOARD	82 A	WOOD				
N	EA	1		3	1	
3/4in x 38 1/2in, for mounting in H202 Cable Terminal Sections, BSP 631-400-101, BSP 632-420-150, BSP 631-005-100.						
100006030 BACKBOARD	82 B	WOOD				
1218404	1	EA	IL IN MI OH WI			
			18 18			
Used with H and K-606 type cable terminal sections, BSP 631-400-101, BSP 632-420-150, BSP 631-005-100.						
100006055 BACKBOARD	82 D	WOOD				
N	EA	1		3	1	
Used with H type cable terminal sections and K-606 type cable terminal sections, BSP 631-400-101, BSP 632-420-150, BSP 631-005-100. DISCONTINUE, ORDER NON STOCK UPON STOCK DEPLETION						
100006063 BACKBOARD	82 E	WOOD				
N	EA	1		3	1	
BSP 631-005-100, BSP 631-400-101, BSP 632-420-150.						
100006071 BACKBOARD	82 F	WOOD				
N	EA	1		3	1	
BSP 631-005-100, BSP 631-400 101, BSP 632-420-150.						
100006089 BACKBOARD	82 G					
N	EA	1		3	1	
BSP 631-005-100, BSP 631-400 101, BSP 632-420-150.						
100006220 BACKBOARD	164 A	WOOD				
N	EA	1		3	1	
Used to mount G type hand set mountings, directory hanger, buzzer keys or push buttons, 3in x 4 1/2in, package of 120, BSP 463-130-100.						
100006261 BACKBOARD	168 D49	LIGHT OLIVEGRAY				
N	EA	1		1	1	
3 7/8in x 2in, plastic backboards for mounting 42A and 44A connecting blocks, for 1 connecting block, BSP 463-130-100.						

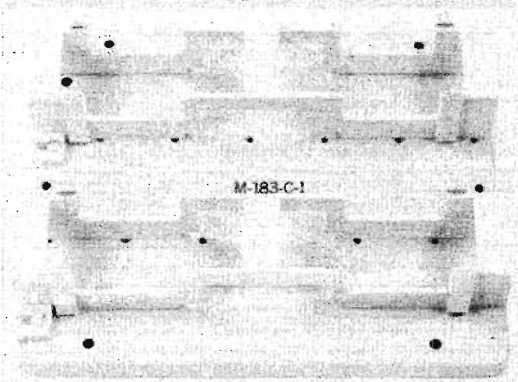
100006287 BACKBOARD	168 E49	LIGHT OLIVEGRAY				
N	PK	1		1	1	
3 7/8in X 5 1/2IN, for 2 or 3 connecting blocks, BSP 463-130-100.						
101412971 BACKBOARD	183 A2	8 1/2IN X 20IN				
1105429	1	EA	IL IN MI OH WI			
			08 08 08 08			
A green half module backboard equipped with four 89B brackets, BSP 463-130-100.						
101937902 BACKBOARD	183 A4	PURPLE ASSEMBLED				
N	EA	10		4	10	
101986446 BACKBOARD	183 A5	8 1/2IN X 20IN				
1174698	1	EA	IL IN MI OH WI			
			18 18 18 18			
A yellow half module backboard equipped with four 89 B brackets.						
101937910 BACKBOARD	183 B3					
N	EA	1		4	5	
A pink backboard for terminating cables to and from key equipment, BSP 463-130-100.						
101937928 BACKBOARD	183 B4	PURPLE ASSEMBLED				
N	EA	5		4	5	
101986453 BACKBOARD	183 B5	17 IN X 20IN				
N	EA	1		4	5	
A yellow full module backboard equipped with eight 89B brackets.						
103222790 BACKBOARD	183 C1	8 1/2IN X 10IN				
5427989	1	EA	IL IN MI OH WI			
			18 18 18 18			
A blue backboard equipped with two 89B brackets and two 66M connecting blocks.						
						
5427989						
103562021 BACKBOARD	183 C6	8 1/2IN X 10IN				
1196857	1	EA	IL IN MI OH WI			
			18 18 18 18			
A 1/4 size orange backboard used to mount network interface blocks or registration jacks.						
300040417 BACKBOARD	183 LX 1	8 1/2IN X 20IN				
1216333	1	EA	IL IN MI OH WI			
			18 18 18 18			
A blue backboard, replaces 183A1, order bracket MSO-1 for 66M blocks or BSO-1 for 66B blocks.						

BACKBOARD

PRODUCT IDENTIFIER		DESCRIPTION						
ITEM NUMBER	ORD. MULT.	SELL UNIT	STD. PKG. STOCK AVAILABILITY / PA	LEAD TIME	MIN. ORD.	A	C	
300040425 BACKBOARD 183 LX 2 8 1/2IN X 20IN								
1183558	1	EA	IL IN MI OH WI 18 18 18 18 18					
A green backboard, replaces 183AZ, order bracket MSO-1 for 66M blocks or BSO-1 for 66B blocks.								
300040441 BACKBOARD 183 LX 4 8 1/2IN X 20IN								
1139022	1	EA	IL IN MI OH WI 18 18 18 18					
A purple backboard, replaces 183B4, order bracket MSO-1 for 66M blocks or bracket BSO-1 for 66B blocks.								
300040458 BACKBOARD 183 LX 5 YELLOW								
N		EA	20	4	20			
A yellow backboard 8 1/2in X 20in; order Bracket MSO-1 for 66M Blocks or Bracket BSO-1 for 66B Blocks.								
300040466 BACKBOARD 183 LX13 8 1/2IN X 20IN								
1221168	1	EA	IL IN MI OH WI 18 18 18 18					
An orange backboard, order bracket MSO-1 for 66M blocks or bracket BSO-1 for 66B blocks.								
300040433 BACKBOARD 183 LX16 8 1/2IN X 20IN								
1193771	1	EA	IL IN MI OH WI 18 18 18 18					
A red backboard, replaces 183B, order bracket MSO-1 for 66M blocks or BSO-1 for 66B blocks.								
101564649 BACKBOARD 184 A1								
N		EA	1	1	1			
Pink metal board e/w two 66B4-25 connecting blocks and 6 P43X237 distributing rings. For closet wiring arrangements, BSP 463-130-100.								
101412997 BACKBOARD 184 B1 17 IN X 20IN								
N		EA	1	1	1			
A pink full module backboard equipped with four 66B4-25 connecting blocks and twelve distributing rings.								
101937936 BACKBOARD 184 B2								
N		EA	1	1	1			
Same as backboard 184B1 except that it is only 13.4 inches high and does not have distributing rings.								
102958550 BACKBOARD 184 C1								
N		EA	1	13	1			
101413003 BACKBOARD 185 A1 8 1/2IN X 20IN								
1105403	1	EA	IL IN MI OH WI 18 18 18 18 18					
A yellow, half module, backboard equipped with 6 distributing rings, BSP 463-130-100. DISCONTINUE, ORDER NON STOCK UPON STOCK DEPLETION								
102901139 BACKBOARD 187 A1 8 1/2IN X 20IN								
1301242	1	EA	IL IN MI OH WI 18 18 18 18 18					
A white, half module, backboard used in small key plans.								

PRODUCT IDENTIFIER		DESCRIPTION						
ITEM NUMBER	ORD. MULT.	SELL UNIT	STD. PKG. STOCK AVAILABILITY / PA	LEAD TIME	MIN. ORD.	A	C	
101937944 BACKBOARD 187 B1								
1186718	1	EA	IL IN MI OH WI 18 18 18 18 18					
300041712 BACKBOARD 187 LX2 WHITE								
1225854	1	EA	IL IN MI OH WI 18 18 18 18					
White backboard used with modular centralized installations. To provide area for horizontal travel of x-conn wiring.								
102689569 BACKBOARD 188 B1								
N		EA	1	1	1			
104031794 BACKBOARD 188 C2								
N		EA	4	1	1			
104032404 BACKBOARD 188 D2								
N		EA	1	1	1			
104223086 BACKBOARD 191 C 50 BLISTER PACK								
N		EA	1	2	1			
102428554 BACKBOARD 194 A								
N		EA	1	13	1			
102581089 BACKBOARD 196 A WHITE								
1216655	1	EA	IL IN MI OH WI 18 18 18 18					
Backboard equipped with sixteen distributing rings designed to be used with modular backboards, BSP 463-130-100.								
102673423 BACKBOARD 197 A LT OLIVE GRAY								
N		EA	5	1	5			
Intended for wall mounting of 121 type apparatus box, wood, BSP 463-130-100.								
102953817 BACKBOARD 198 A WHITE								
1123364	1	EA	IL IN MI OH WI 18 18 18 18 18					
For cross-connect wire where modular panels are stacked vertically. Steel panel 8 1/2in X 20in, BSP 463-130-100.								
023000466 BACKBOARD 31 3/4IN X 19 1/2IN								
1180976	1	EA	IL IN MI OH WI 18					
Fire retardent								
995940616 BACKBOARD CK05796 L7 BEIGE GRAY								
1128470	1	EA	IL IN MI OH WI 18 18 18 18					
Wooden backboard for mounting one 105B apparatus box, BSP 463-130-000.								
995940624 BACKBOARD CK05796 L8 BEIGE GRAY								
1134411	1	EA	IL IN MI OH WI 18 18 18 18 18					
Used for mounting two 105B apparatus boxes.								
995940632 BACKBOARD CK05796 L9 BEIGE GRAY								
1169110	1	EA	IL IN MI OH WI 04 04 04 04					
Used for mounting three 105B Apparatus Boxes.								

PRODUCT IDENTIFIER DESCRIPTION

ITEM NUMBER	ORD. MULT.	SELL UNIT	STD. PKG. STOCK AVAILABILITY / PA	LEAD TIME	MIN. ORD.	A C
-------------	------------	-----------	-----------------------------------	-----------	-----------	-----

280054370 BACKBOARD MOUNTING

1929620	1	EA	IL IN MI OH WI 58			
---------	---	----	----------------------	--	--	--

For SN1100 installations.

BAG

260422571 BAG ALUMINUM FOIL LINED 21 X 35 1/2IN

N		EA	100	2	100	
---	--	----	-----	---	-----	--

TBTPB2. NOW AVAILABLE THROUGH TOUCH-TONE ORDER ENTRY.

260422563 BAG ALUMINUM FOIL LINED 9 X 20IN

N		EA	100	2	100	
---	--	----	-----	---	-----	--

TBTPB1

260329875 BAG DOOR HANGER

1946699	1	PK	IL IN MI OH WI 18 18			
---------	---	----	-------------------------	--	--	--

Plastic bag with hole for hanging on door knobs. I&M Technicians will use to leave work invoices and instructional material.

400783627 BAG WIRE SCRAP 38

1106328	1	EA	IL IN MI OH WI 18 18 18 18 18			
---------	---	----	----------------------------------	--	--	--

Heavy Kraft paper bag intended to be used for scrap wire in Central Offices. Also used as insert in towel baskets.

BALCONY CABINET

400006193 BALCONY CABINET B CA07928

1147090	1	EA				
---------	---	----	--	--	--	--

BALCONY TERMINAL

400006219 BALCONY TERMINAL B CA07527

1106344	1	EA				
---------	---	----	--	--	--	--

Consists of a bolted assembly and a hinged wooden platform to sit on when working at an aerial terminal, BSP 631-300-213.

BANDAGE RUBBER

400006573 BANDAGE RUBBER CA06843

1134478	1	RO				
---------	---	----	--	--	--	--

Intended as a temporary wrapping for protecting incomplete cable splices against moisture, BSP 633-040-200.

BAR BOND

260365408 BAR BOND PST 18IN WITH EYELET

1955005	1	EA				
---------	---	----	--	--	--	--

PRODUCT IDENTIFIER DESCRIPTION

ITEM NUMBER	ORD. MULT.	SELL UNIT	STD. PKG. STOCK AVAILABILITY / PA	LEAD TIME	MIN. ORD.	A C
-------------	------------	-----------	-----------------------------------	-----------	-----------	-----

BAR CHANNEL

260324694 BAR CHANNEL CTB 9 AA

1944454	1	EA				
---------	---	----	--	--	--	--

Used for replacing lost or damaged bars in 2 type closure for 18.5in cover.

002076750 BAR CHANNEL CTB 10 A

1139568	1	EA	IL IN MI OH WI 08 08 08 08 08			
---------	---	----	----------------------------------	--	--	--

A bar used to bolt together both halves of a 2 type closure.

002076768 BAR CHANNEL CTB 11 B

1147959	1	EA	IL IN MI OH WI 08 08 08 08 08			
---------	---	----	----------------------------------	--	--	--

Used for replacing lost or damaged bars in 2 type closure for 36in cover.

002076776 BAR CHANNEL CTB 12 C

1174300	1	EA	IL IN MI OH WI 08 08 08 08 08			
---------	---	----	----------------------------------	--	--	--

Used for replacing lost or damaged bars in 2 type closure for 44.5in cover.

260324702 BAR CHANNEL CUB 9 AA

1944488	1	EA	IL IN MI OH WI 08 08 08 08			
---------	---	----	-------------------------------	--	--	--

Used for replacing lost or damaged bars in 2 type closure for 18.5in cover.

260324710 BAR CHANNEL CUB 10 A

1944496	1	EA	IL IN MI OH WI 08 08 08 08			
---------	---	----	-------------------------------	--	--	--

Used for replacing lost or damaged bars in 2 type closure for 27.5in cover.

260324728 BAR CHANNEL CUB 11 B

1944694	1	EA	IL IN MI OH WI 08 08 08 08			
---------	---	----	-------------------------------	--	--	--

Used for replacing lost or damaged bars in 2 type closure for 36in cover.

260324736 BAR CHANNEL CUB 12 C

1944470	1	EA	IL IN MI OH WI 08 08 08 08			
---------	---	----	-------------------------------	--	--	--

Used for replacing lost or damaged bars in 2 type closure for 44.5in cover.

BASE

260439286 BASE DUCT SPACER 1.5IN SMOOTH CORE

N

401972476 BASE PEDESTAL CA08812

N		EA	1	1	1	
---	--	----	---	---	---	--

Green base cover for ground mount. 836A and 36B RT.

103063988 BASE REPEATER CASE 81A1-1H

5269084	1	EA	IL IN MI OH WI 08 08			
---------	---	----	-------------------------	--	--	--

Used with T1 and T1 digital lines non-standard stub lengths.

DISTRIBUTION SERVICES
 NETWORK SERVICES
 TOOLS
 BUILDING JANITORIAL
 AUTOMOTIVE
 FORMS/OFFICE SUPPLIES
 GENERAL
 DATA VOICE

BASE

PRODUCT IDENTIFIER DESCRIPTION

ITEM NUMBER	ORD. MULT.	SELL UNIT	STD. PKG. STOCK AVAILABILITY / PA	LEAD TIME	MIN. ORD.	A C
-------------	------------	-----------	-----------------------------------	-----------	-----------	-----

103063996 BASE REPEATER CASE 81A1-2H 30FT
 N EA 1 4 1
 Base for repeater cases 818C & 819C repeaters. BSP 640-250-216.

103064002 BASE REPEATER CASE 81B1-1H
 5269142 1 EA IL IN MI OH WI
 08 08
 Equipped with filled quad screened stub, BSP 640-525-308.

BATTING

280053786 BATTING W/FOIL SKIN 2FT X 4FT X 4FT
 1929216 1 BD
 Mineral wool, 32 sq ft bundle, therma fiber safing with foil skin. DISCONTINUE, ORDER NON STOCK UPON STOCK DEPLETION

BEND

CA08546. PVC CONDUIT USED ON BUILDINGS OR POLES TO GUIDE RISER CABLES.

300045895 BEND 4IN 11 1/4 DEGREE 2FT RADIUS
 N EA 1 2 1

300054673 BEND 4IN 11 1/4 DEGREE 3FT RADIUS
 N EA 1 2 1

300053972 BEND 4IN 11 1/4 DEGREE 4FT RADIUS
 N EA 1 2 1

300049160 BEND 4IN 22 1/2 DEGREE 2FT RADIUS
 N EA 1 1

300054962 BEND 4IN 22 1/2 DEGREE 3FT RADIUS
 N EA 1 2 1
 CA08546.

280001678 BEND 4IN 22 1/2 DEGREE 4FT RADIUS
 N EA 1 2 1

300045903 BEND 4IN 22 1/2 DEGREE 4FT RADIUS
 N EA 1 2 1

300053980 BEND 4IN 22 1/2 DEGREE 6FT RADIUS
 N EA 1 1

300054822 BEND 4IN 30 DEGREE 2FT RADIUS
 N EA 1 2 1

300054871 BEND 4IN 30 DEGREE 3FT RADIUS
 N EA 1 2 1
 CA08546.

280023623 BEND 4IN 30 DEGREE 4FT RADIUS
 N EA 1 2 1

300054467 BEND 4IN 30 DEGREE 6FT RADIUS
 N EA 1 2 1

300054970 BEND 4IN 30 DEGREE 9FT RADIUS
 N EA 1 2 1

PRODUCT IDENTIFIER DESCRIPTION

ITEM NUMBER	ORD. MULT.	SELL UNIT	STD. PKG. STOCK AVAILABILITY / PA	LEAD TIME	MIN. ORD.	A C
-------------	------------	-----------	-----------------------------------	-----------	-----------	-----

401022512 BEND 4IN 30 DEGREE 12FT RADIUS
 N EA 1 2 1

300054723 BEND 4IN 30 DEGREE 15FT RADIUS
 N EA 1 2 1

300054764 BEND 4IN 45 DEGREE 2FT RADIUS
 N EA 1 2 1

280001710 BEND 4IN 45 DEGREE 4FT RADIUS
 N EA 1 2 1

300049178 BEND 4IN 45 DEGREE 4FT RADIUS
 N EA 1 2 1

300046000 BEND 4IN 45 DEGREE 6FT RADIUS
 N EA 1 2 1
 85045-00.

300053931 BEND 4IN 45 DEGREE 9FT RADIUS
 N EA 1 2 1

300045911 BEND 4IN 45 DEGREE 12FT RADIUS
 N EA 1 2 1

300045978 BEND 4IN 90 DEGREE 2FT RADIUS
 N EA 1 2 1

300045937 BEND 4IN 90 DEGREE 3FT RADIUS
 N EA 1 1 1

300045960 BEND 4IN 90 DEGREE 4FT RADIUS
 N EA 1 2 1

280001769 BEND 4IN 90 DEGREE 6FT RADIUS
 N EA 1 2 1

280001777 BEND 4IN 90 DEGREE 9FT RADIUS
 N EA 1 2 1

280001785 BEND 4IN 90 DEGREE 12FT RADIUS
 N EA 1 2 1

280001793 BEND 4IN 90 DEGREE 15FT RADIUS
 N EA 1 2 1

300045986 BEND 4IN 90 DEGREE 30IN RADIUS
 N EA 1 1 1

BLADDER

260344411 BLADDER FOR CLOSURE 2200UG 6/20
 1950444 1 EA

260344429 BLADDER FOR CLOSURE 2200UG 8/20
 1950477 1 EA IL IN MI OH WI
 08 08 08 08
 Use with Kit of Parts D181775 (1950519) for re-entry.

DISTRIBUTION SERVICES

NETWORK SERVICES

TOOLS

BUILDING JANITORIAL

AUTOMOTIVE

FORMS/OFFICE SUPPLIES

GENERAL

DATA VOICE

PRODUCT IDENTIFIER		DESCRIPTION					
ITEM NUMBER	ORD. MULT.	SELL UNIT	STD. PKG. STOCK AVAILABILITY / PA	LEAD TIME	MIN. ORD.	A	C
260344437 BLADDER FOR CLOSURE 2200UG 10/20							
1950485	1	EA	IL IN MI OH WI 08 08 08 08				
Use with Kit of Parts D181776 (1950527) for re-entry.							

PRODUCT IDENTIFIER		DESCRIPTION					
ITEM NUMBER	ORD. MULT.	SELL UNIT	STD. PKG. STOCK AVAILABILITY / PA	LEAD TIME	MIN. ORD.	A	C
103804894 BLOCK WIRE 110AW 1 100							
N		EA	1	1		1	
103804902 BLOCK WIRE 110AW 1 300							
N		EA	4	1		1	

BLOCK

260370242 BLOCK 1000BC LG BUILD-OUT							
1955955	1	EA					
280016049 BLOCK CABLE E							
N		EA	1	2		1	
280016056 BLOCK CABLE FRAME B							
N		EA	1	2		1	
081-410-108.							

260347992 BLOCK MODULAR HARDWARE 4310-48DPM							
1951699	1	KT	IL IN MI OH WI 08 08 08 08				
Modular hardware block assembly factory connected with 48in 4005 DPM module. Used in 3M interfaces to replace defective or damaged units.							

300014388 BLOCK MODULAR HARDWARE 4310-60M							
N		KT	1	2		1	
4 Assemblies per kit.							

260405923 BLOCK QUICK CONNECT H66M4-100							
N		EA	1	4		1	
Homaco.							

260447610 BLOCK RLS50 WITH 7FT STUB							
N							
Reliable Self-Strip, with raw ended stub.							

260447628 BLOCK RLS50 WITH 7FT STUB & 4005DPM'S							
N							
Reliable block with connectorized stub.							

260324660 BLOCK SELF STRIP 4-PAIR BUNCH 4322							
N		EA	1	3		1	

260328075 BLOCK SELF STRIP KIT 4320-15M							
N		KT	1	2		1	
With MS2 tail 4.							

260323605 BLOCK SELF STRIP KIT 4320-48DPM							
N		KT	1	2		1	
With 4005DPM tail, 4 assembly kit.							

280079708 BLOCK SELF STRIP KIT 4320-48M							
1951681	1	KT	IL IN MI OH WI 08 08 08 08				
Self strip block connected with 48in. tail to a 400Q-D Super Mini Module. Used in 3M interfaces where existing block has been damaged.							

300014412 BLOCK SPACER 4361							
N		EA	1	2		1	

BLOCK CONNECTING

100009323 BLOCK CONNECTING 42A 49							
1111401	1	EA					
A square 4 punching block equipped with cover. Used for connecting inside wire and station cord, BSP 461-610-100.							

100009349 BLOCK CONNECTING 44A							
1189316	1	EA	IL IN MI OH WI 18 18 18 18				

102231362 BLOCK CONNECTING 45R							
N		EA	1	3		1	
Connecting block designed to be used on special orders, will accept a four prong telephone plug.							

102434925 BLOCK CONNECTING 82B							
2626721	1	EA	IL IN MI OH WI 18 18 18 18 18				
Used to interconnect the 4A Speakerphone System, Transmitter 680A, Set Speaker Loud 108 and Unit power 85 B1, BSP 512-700-100.							

102596822 BLOCK CONNECTING 92A							
N		EA	1	3		1	

102813201 BLOCK CONNECTING 97A1							
1143479	1	EA	IL IN MI OH WI 18 18 18 18 18				
This item is used as the Telco-Customer interface point on a registered CPE data set.							

102813219 BLOCK CONNECTING 97A2							
1142232	1	EA	IL IN MI OH WI 18 18 18 18 18				

102813227 BLOCK CONNECTING 97A3							
1146993	1	EA	IL IN MI OH WI 18 18 18 18 18				

102813235 BLOCK CONNECTING 97A4							
1199323	1	EA	IL IN MI OH WI 18 18 18 18 18				

102813243 BLOCK CONNECTING 97A5							
1182170	1	EA	IL IN MI OH WI 18 18 18 18 18				

102813250 BLOCK CONNECTING 97A6							
1138370	1	EA	IL IN MI OH WI 18 18 18 18 18				

102813268 BLOCK CONNECTING 97A7							
1185728	1	EA	IL IN MI OH WI 18 18 18 18 18				

DISTRIBUTION SERVICES

NETWORK SERVICES

TOOLS

BUILDING JANITORIAL

AUTOMOTIVE

FORMS/OFFICE SUPPLIES

GENERAL

DATA VOICE

BLOCK CONNECTING

PRODUCT IDENTIFIER		DESCRIPTION						
ITEM NUMBER	ORD. MULT.	SELL UNIT	STD. PKG. STOCK AVAILABILITY / PA	LEAD TIME	MIN. ORD.	A C		
102813276 BLOCK CONNECTING 97A8								
1170464	1	EA	IL IN MI OH WI 18 18 18 18 18					
102813284 BLOCK CONNECTING 97A9								
1153452	1	EA	IL IN MI OH WI 18 18 18 18 18					
102818465 BLOCK CONNECTING 97B								
1220277	1	EA	IL IN MI OH WI 18 18 18 18 18					
This item is used as the Telco-Customer interface point on a registered CPE data set.								
103083200 BLOCK CONNECTING 102A								
1415042	1	EA	IL IN MI OH WI 18 18 18 18 18					
An 8 conductor modular connecting block may be flush mounted using 63B, 43B, or CK20502 L2 brackets, BSP 461-604-104.								
103104220 BLOCK CONNECTING 103A 246								
1152116	1	EA	IL IN MI OH WI 18 18 18 18 18					
An 8 conductor modular connecting block designed for surface mounting, BSP 461-604-104.								
103116943 BLOCK CONNECTING 104A 246 50								
1169748	1	EA	IL IN MI OH WI 18 18 18 18 18					
A surface mounted connect block equipped with two 8-position modular jacks, BSP 461-604-104.								
103985693 BLOCK CONNECTING 104B 246								
N		EA	1	3	1			
NOW AVAILABLE THROUGH TOUCH-TONE ORDER ENTRY.								
103985354 BLOCK CONNECTING 106AFD 246								
N		EA	1	3	1			
NOW AVAILABLE THROUGH TOUCH-TONE ORDER ENTRY.								
104373873 BLOCK CONNECTING 106BFD 246								
N		EA	1	3	1			
NOW AVAILABLE THROUGH TOUCH-TONE ORDER ENTRY.								
102430386 BLOCK CONNECTING 625A4 50								
1224881	1	EA	IL IN MI OH WI 18 18 18 18 18					
Used for conversion to modularity. A square 4 punching block equipped with a jack containing cover used for connecting inside wire and station cord, BSP 503-100-100.								
102430402 BLOCK CONNECTING 625B 246 50								
1151795	1	EA	IL IN MI OH WI 18 18 18 18 18					
For flush mounting in new installation of modular telephone sets. Includes 625F block, 43B Bracket, Face Plate and screws, BSP 503-100-100.								
260328190 BLOCK CONNECTING 625B4 4 52								
1946020	1	EA	IL IN MI OH WI 18 18 18					

PRODUCT IDENTIFIER		DESCRIPTION						
ITEM NUMBER	ORD. MULT.	SELL UNIT	STD. PKG. STOCK AVAILABILITY / PA	LEAD TIME	MIN. ORD.	A C		
102430436 BLOCK CONNECTING 625C 246 50								
1187799	1	EA	IL IN MI OH WI 18 18 18 18 18					
Used to convert existing 42A blocks to modular, BSP 503-100-100.								
105183370 BLOCK CONNECTING 625D 246 50								
1223511	1	EA	IL IN MI OH WI 18 18 18 18 18					
A duplex flush 6 conductor modular jack e/w window designation strip. Arranged to mount in a single outlet box. Used in hospital rooms requiring two lines, BSP 461-610-100.								
103335998 BLOCK CONNECTING 625D6 50								
N		EA	1	3	1			
102430451 BLOCK CONNECTING 625F 50								
1214684	1	EA	IL IN MI OH WI 18 18 18 18 18					
Intended for installations in conversion to modularity requiring flush type jacks or for replacement of a 548AJ jack, BSP 503-100-100.								
103552857 BLOCK CONNECTING 625S6 246 50								
1230458	1	EA	IL IN MI OH WI 18 18 18 18 18					
Consists of a terminal strip 625A6 Jack and a plastic cover, provides bridged connection of tip and ring for up to three lines to the registered equipment, BSP 461-610-100.								
300077245 BLOCK CONNECTING 625SA								
6513283	1	EA	IL IN MI OH WI 08 08					
E/W Maintenance Terminating Unit containing solid state electronic module to be used for testing COCOT lines.								
103627188 BLOCK CONNECTING 625SA 4 50								
1940577	1	EA	IL IN MI OH WI 18					
This is a fully enclosed 4 conductor (RJ11C) ivory connecting block with a swinger door.								
103323663 BLOCK CONNECTING 625TD 50								
1148258	1	EA	IL IN MI OH WI 18 18 18 18					
Standard network interface between customer premise wiring and telephone company network facilities, BSP 461-400-150.								
103654125 BLOCK CONNECTING 625TD 250								
N		EA	100	2	100			
103796595 BLOCK CONNECTING 630B PB IP								
1301267	1	EA	IL IN MI OH WI 18 18 18 18 18					
104225453 BLOCK CONNECTING 630BB								
N		EA	1	3	1			
102906062 BLOCK CONNECTING 635B								
2819128	1	EA	IL IN MI OH WI 18 18 18 18 18					
onsists of a 10 position terminal board mounted in a base pan and furnished with a cover. Intended for use in series with telephone line, BSP 461-610-100, BSP 463-400-130.								

PRODUCT IDENTIFIER		DESCRIPTION					
ITEM NUMBER	ORD. MULT.	SELL UNIT	STD. PKG. STOCK AVAILABILITY / PA	LEAD TIME	MIN. ORD.	A	C
260328182 BLOCK CONNECTING 725B 50							
1946012	1	EA	IL IN MI OH WI 18				
260328174 BLOCK CONNECTING 725B4 52							
1946004	1	EA	IL IN MI OH WI 18				
103555835 BLOCK CONNECTING 725F 50							
N		EA	1	3	1		
103559985 BLOCK CONNECTING 725FS 246 10518352							
N		EA	1	3	1		
103658571 BLOCK CONNECTING 742A 50							
1304642	1	EA	IL IN MI OH WI 18 18 18 18 18				
Provides bridging up to four inside wires to a short modular cord used to connect to standard network interface (SNI); BSP 461-400-151.							
260336607 BLOCK CONNECTING 022-100010							
N		EA	1	3	1		
An 8 conductor modular to screw terminal.							
103801247 BLOCK CONNECTING 110C-4							
N		EA	1	1	1		
402511091 BLOCK CONNECTING 4110M TELEPHONE							
8325449	1	EA	IL IN MI OH WI 18 18 18 18 18				
A 6 position modular telephone connecting block with a pressure sensitive adhesive backing for mounting, 10 per box.							
260423389 BLOCK CONNECTING 625AS4NSEE4-52							
1976951	1	EA	IL IN MI OH WI 18 18 18 18				
Same block as 625A4-50 PID 102430386 except this one has moisture & corrosion resistant modifications. To be used in locations with excessive moisture.							
260427786 BLOCK CONNECTING 625SA4NSEE-50							
1977686	1	EA	IL IN MI OH WI 18 18				
This block is similar to the Block Connecting 625SA4-50 (Item 1940577) but with corrosion & moisture resistant features.							
260301890 BLOCK CONNECTING SE625A28K							
1938928	1	EA	IL IN MI OH WI 18 18 18 18 18				
An 8 position modular jack designed to provide the customer interface RJ 48S.							
260301882 BLOCK CONNECTING SE625A28K-2							
1938910	1	EA	IL IN MI OH WI 18 18 18 18 18				
An 8 position modular jack equipped with shorting bars designed to provide customer interface RJ48X.							
260301874 BLOCK CONNECTING SE625A28NK							
1938902	1	EA	IL IN MI OH WI 18 18 18 18 18				
An 8 position modular jack designed to provide customer interface RJ48C.							

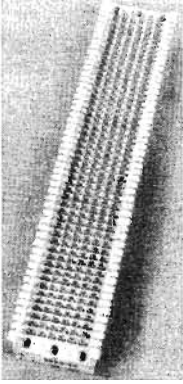
PRODUCT IDENTIFIER		DESCRIPTION					
ITEM NUMBER	ORD. MULT.	SELL UNIT	STD. PKG. STOCK AVAILABILITY / PA	LEAD TIME	MIN. ORD.	A	C
BLOCK CONNECTOR							
400011755 BLOCK CONNECTOR 30A CA06274							
1111245	1	EA					
							
400011755							
100009554 BLOCK CONNECTOR 57A2 10							
N		EA	18	8	1		
100009562 BLOCK CONNECTOR 57A2 16							
N		EA	18	15	1		
A fuseless protected block, associated with KS16191 cable terminal box. BSP 631-600-207.							
100009638 BLOCK CONNECTOR 57B1A-25 PAIR							
N		EA	18	8	1		
A fuseless protected connecting block for use with PIC Cable in building terminals. BSP 631-450-211.							
103258307 BLOCK CONNECTOR 66B3 6							
1160994	1	EA	IL IN MI OH WI 18 18 18 18				
For use on customer premises, to provide the demarcation point between the operating telephone company facilities and other common carrier equipment. BSP 461-604-102.							
100009893 BLOCK CONNECTOR 66B3 50							
1111948	1	EA	IL IN MI OH WI 18 18 18 18 18				
Has 100 horizontal rows, two double rows, 3 clips per terminal, for 300 and 500 type key service units, BSP 461-604-102.							
							
1111948							

DISTRIBUTION SERVICES

NETWORK SERVICES

TOOLS

BUILDING JANITORIAL

AUTOMOTIVE

FORMS/OFFICE SUPPLIES

GENERAL

DATA VOICE

DISTRIBUTION SERVICES

NETWORK SERVICES

TOOLS

BUILDING JANITORIAL

AUTOMOTIVE

FORMS/OFFICE SUPPLIES

GENERAL

DATA VOICE

BLOCK CONNECTOR

PRODUCT IDENTIFIER		DESCRIPTION					
ITEM NUMBER	ORD. MULT.	SELL UNIT	STD. PKG. STOCK AVAILABILITY / PA	LEAD TIME	MIN. ORD.	MI	A

101954618 BLOCK CONNECTOR 66B3 50C
 2715664 1 EA IL IN MI OH WI
 18 18 18 18 18
 Consists of a Block Connector 66B3-50 equipped with two CK16689 Plugs. BSP 461-605-102.

102658531 BLOCK CONNECTOR 66B4 3
 1144345 1 EA IL IN MI OH WI
 18 18 18 18 18
 Used for multiplying inside wire connections, less cover. BSP 461-604-102.

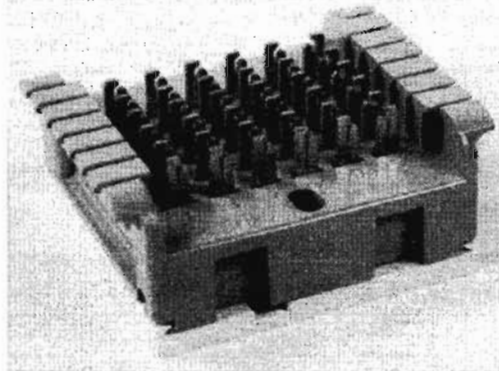

1144345

100009901 BLOCK CONNECTOR 66B4 25
 1111880 1 EA IL IN MI OH WI
 18 18 18 18 18
 50 horizontal rows, one terminal per row, 6 clips per terminal. Equipped with mounting bracket for 115A1 or 115B1 apparatus box. BSP 461-604-102.

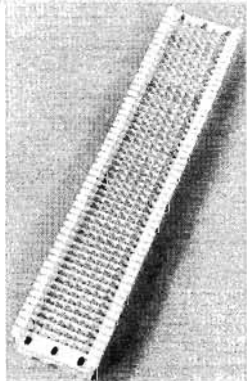

1111880

101954600 BLOCK CONNECTOR 66B4 25C
 1155267 1 EA IL IN MI OH WI
 18 18 18 18 18
 A 66B4 connecting block equipped with CK16689 Plug. BSP 461-616-140.

100009927 BLOCK CONNECTOR 66C1 16
 N EA 1 4 1

100009935 BLOCK CONNECTOR 66C2 16
 N EA 14 1 1

PRODUCT IDENTIFIER		DESCRIPTION					
ITEM NUMBER	ORD. MULT.	SELL UNIT	STD. PKG. STOCK AVAILABILITY / PA	LEAD TIME	MIN. ORD.	MI	A

100009968 BLOCK CONNECTOR 66E3 25
 1170399 1 EA IL IN MI OH WI
 18 18 18 18 18
 5 Horizontal banks, 10 terminals per bank. To terminate one plug ended telephone set to raw ended cable, BSP 461-604-103.

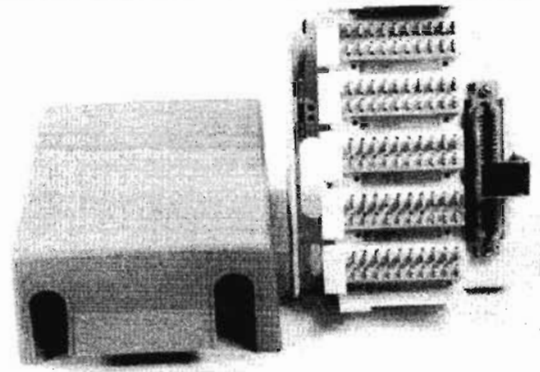

1170399

103161931 BLOCK CONNECTOR 66E9 25R
 1169276 1 EA IL IN MI OH WI
 18 18 18 18 18
 E/W a capacitor, diode, and 10 resistors. Used with horizon, one required per system when either or both loudspeaker paging and music on hold is provided, BSP 461-604-103.

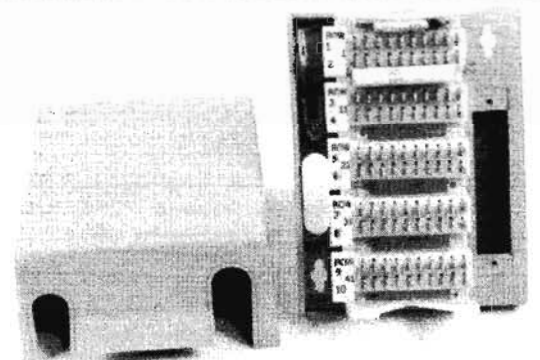

1169276

PRODUCT IDENTIFIER DESCRIPTION

ITEM NUMBER	ORD. MULT.	SELL UNIT	STD. PKG. STOCK AVAILABILITY / PA	LEAD TIME	MIN. ORD.	A C
-------------	------------	-----------	-----------------------------------	-----------	-----------	-----

101931269 BLOCK CONNECTOR 66M1 25

IL	IN	MI	OH	WI
18	18	18	18	18

A molded plastic block containing 100 quick connect terminals arranged in one column of 25 four clip terminals (10in long X 2 3/16in wide). BSP 461-604-102.

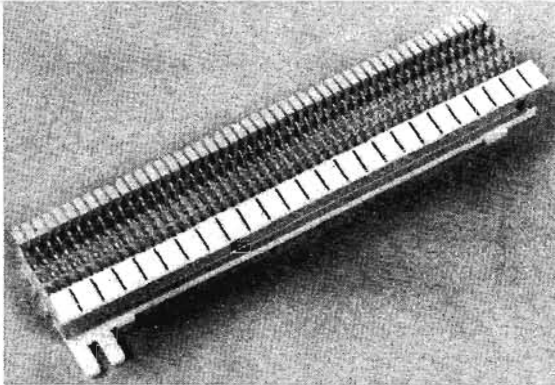

1103812

101238178 BLOCK CONNECTOR 66M1 50

IL	IN	MI	OH	WI
18	18	18	18	18

Consists of a molded fire retardant plastic block containing 100 quick-clip connectors of the 2 terminal variety, arranged in two columns of 50 clips. BSP 461-600-100.

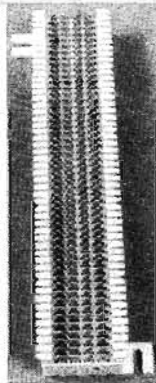

1111963

103666699 BLOCK CONNECTOR 89E1A128 099999

IL	IN	MI	OH	WI
18	18	18		

103751707 BLOCK CONNECTOR 89F1A100 099999

IL	IN	MI	OH	WI
18	18		18	

401490875 BLOCK CONNECTOR 145BK

IL	IN	MI	OH	WI
08	08			

A 6 pair unprotected terminal block used in SCA 4 and SCA 8 closures, BSP 631-601-901N.

402841167 BLOCK CONNECTOR D/E WIRE RMS 90

IL	IN	MI	OH	WI
18	18			18

Used in a terminal wire buried E when a second connect block is required.

PRODUCT IDENTIFIER DESCRIPTION

ITEM NUMBER	ORD. MULT.	SELL UNIT	STD. PKG. STOCK AVAILABILITY / PA	LEAD TIME	MIN. ORD.	A C
-------------	------------	-----------	-----------------------------------	-----------	-----------	-----

900229576 BLOCK CONNECTOR R66CB1 6

IL	IN	MI	OH	WI
18	18	18	18	18

6 PR punch-on. Placed next to station protector where more than 3 or 4 inside wires are required - consists of 12 rows, one terminal per row, and four clips per terminal.

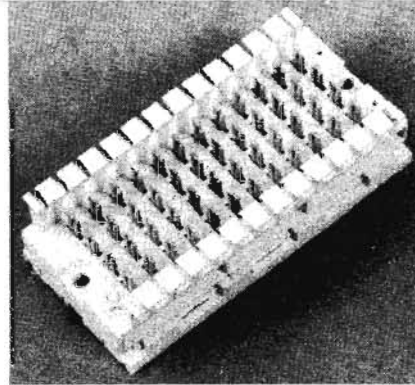

1310524

300050424 BLOCK CONNECTOR R66EB1 12

IL	IN	MI	OH	WI
18	18	18	18	18

12 PR punch-on. Used to terminate multiple inside wires.

BLOCK TERMINAL

100010875 BLOCK TERMINAL 1A4A 25 12FT

1112540 1 EA
A fuseless protected terminating block, similar to the NH-type cable terminal, used in outside plant. (Bing post type). BSP 631-440-211.

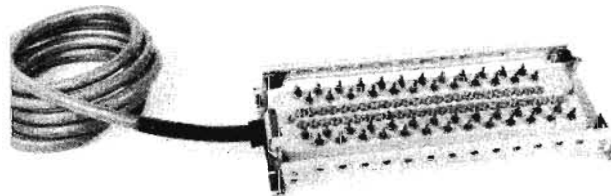

100010875

100010883 BLOCK TERMINAL 1A4A 50 12FT

IL	IN	MI	OH	WI
08	08	08	08	08

A fuseless protected terminating block, similar to the NH-type cable terminal, used in outside plant. (Bing post type). BSP 631-440-211.

102467495 BLOCK TERMINAL 1B5 RPT 5P1A4

IL	IN	MI	OH	WI
			08	08

Used to terminate between three and twenty-five pairs of wires.

100011329 BLOCK TERMINAL 2B1 100 12FT

N EA 1 6 1
All 2B1 Block Terminals are used to terminate either paper or plastic insulated conductor cables in buildings where the ready access principle is used. NOW AVAILABLE THROUGH TOUCH-TONE ORDER ENTRY.

DISTRIBUTION SERVICES

NETWORK SERVICES

TOOLS

BUILDING JANITORIAL

AUTOMOTIVE

FORMS/OFFICE SUPPLIES

GENERAL

DATA VOICE

DISTRIBUTION SERVICES

NETWORK SERVICES

TOOLS

BUILDING JANITORIAL

AUTOMOTIVE

FORMS/OFFICE SUPPLIES

GENERAL

DATA VOICE

BLOCK TERMINAL

PRODUCT IDENTIFIER		DESCRIPTION					
ITEM NUMBER	ORD. MULT.	SELL UNIT	STD. PKG. STOCK	PKG. AVAILABILITY / PA	LEAD TIME	MIN. ORD.	A C
100011337		BLOCK TERMINAL	2B1	100	25FT		
N		EA	1	6		1	
100011345		BLOCK TERMINAL	2B1	300	12FT		
N		EA	1	6		1	
100011352		BLOCK TERMINAL	2B1	300	25FT		
N		EA	1	6		1	
100011469		BLOCK TERMINAL	3A1A	3			
1185173	1	EA	IL 08	IN 08	MI 08	OH 08	WI 08

Used when required at 49 type terminals and buried closure where station protection is required. Equipped with 2A1A protector units and 3 pairs of binding posts. BSP 631-240-206.



1185173

PRODUCT IDENTIFIER		DESCRIPTION					
ITEM NUMBER	ORD. MULT.	SELL UNIT	STD. PKG. STOCK	PKG. AVAILABILITY / PA	LEAD TIME	MIN. ORD.	A C
100011477		BLOCK TERMINAL	3A2B	3			
1112508	1	EA	IL 08	IN 08	MI 08	OH 08	WI 08

Used when required at 49 type terminal. Contains 3 pairs of binding posts and six 2A1B protectors for protecting up to 3 pairs and for terminating drop and service wires, BSP 631-240-206.

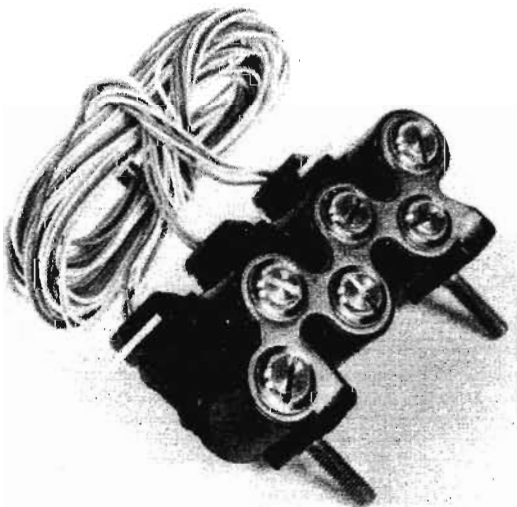

1112508

PRODUCT IDENTIFIER		DESCRIPTION					
ITEM NUMBER	ORD. MULT.	SELL UNIT	STD. PKG. STOCK	PKG. AVAILABILITY / PA	LEAD TIME	MIN. ORD.	A C
101431237		BLOCK TERMINAL	5A1	600	15FT		
N		EA	1	6		2	
All 5A1 Terminal Blocks are used to terminate cross connecting facility at building entrance points.							
101431252		BLOCK TERMINAL	5A1	600	30FT		
N		EA	1	6		2	
101431294		BLOCK TERMINAL	5A1	900	25FT		
N		EA	1	6		2	
101431302		BLOCK TERMINAL	5A1	900	30FT		
N		EA	1	1		1	
102217312		BLOCK TERMINAL	8A1	12			
N		EA	18	1		1	
Used to terminate cable in aerial closures. NOW AVAILABLE THROUGH TOUCH-TONE ORDER ENTRY.							

PRODUCT IDENTIFIER		DESCRIPTION					
ITEM NUMBER	ORD. MULT.	SELL UNIT	STD. PKG. STOCK	PKG. AVAILABILITY / PA	LEAD TIME	MIN. ORD.	A C
102467479		BLOCK TERMINAL	9A	15	RPT 5A4		
1225383	1	EA	IL 08	IN 08	MI 08	OH 08	WI 08
Used to terminate between three and twenty-five pairs of wires.							

PRODUCT IDENTIFIER		DESCRIPTION					
ITEM NUMBER	ORD. MULT.	SELL UNIT	STD. PKG. STOCK	PKG. AVAILABILITY / PA	LEAD TIME	MIN. ORD.	A C
102371259		BLOCK TERMINAL	9A110	RPT	10A4		
1191981	1	EA	IL 08	IN 08	MI 08	OH 08	WI 08
Terminate service wires of buried cable plant in PC6/48 cable closures.							

PRODUCT IDENTIFIER		DESCRIPTION					
ITEM NUMBER	ORD. MULT.	SELL UNIT	STD. PKG. STOCK	PKG. AVAILABILITY / PA	LEAD TIME	MIN. ORD.	A C
102311834		BLOCK TERMINAL	9A125	RPT	25A4		
1101212	1	EA	IL 08	IN 08	MI 08	OH 08	WI 08
25 pair terminal block used to terminate service wires of buried cable plant in PC6/48 cable & CAD 4, 8 & 12 closures. BSP 631-604-901N.							

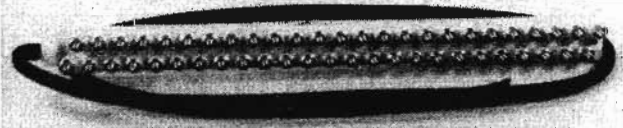

1101212

PRODUCT IDENTIFIER		DESCRIPTION					
ITEM NUMBER	ORD. MULT.	SELL UNIT	STD. PKG. STOCK	PKG. AVAILABILITY / PA	LEAD TIME	MIN. ORD.	A C
102467487		BLOCK TERMINAL	9A1A5	RPT	5PA4		
5117127	1	EA	IL 08	IN 08	MI 08	OH 08	WI 08
Six terminal blocks used to terminate between three and twenty-five pairs of wires.							

PRODUCT IDENTIFIER		DESCRIPTION					
ITEM NUMBER	ORD. MULT.	SELL UNIT	STD. PKG. STOCK	PKG. AVAILABILITY / PA	LEAD TIME	MIN. ORD.	A C
101984078		BLOCK TERMINAL	145-3				
1152199	1	EA	IL 08	IN 08	MI 08	OH 08	WI 08
Offset stud and post to facilitate installation of drop wires. Used in 49 type terminals and buried closures when requested, BSP 631-240-206.							

PRODUCT IDENTIFIER		DESCRIPTION					
ITEM NUMBER	ORD. MULT.	SELL UNIT	STD. PKG. STOCK	PKG. AVAILABILITY / PA	LEAD TIME	MIN. ORD.	A C
260344445		BLOCK TERMINAL	163-02				
1950311	1	EA	IL 08	IN 08	MI 08	OH 08	WI 08

PRODUCT IDENTIFIER		DESCRIPTION					
ITEM NUMBER	ORD. MULT.	SELL UNIT	STD. PKG. STOCK	PKG. AVAILABILITY / PA	LEAD TIME	MIN. ORD.	A C
103192712		BLOCK TERMINAL	9E1A-10	4			
N							

PRODUCT IDENTIFIER DESCRIPTION

ITEM NUMBER	ORD. MULT.	SELL UNIT	STD. PKG. STOCK AVAILABILITY / PA	LEAD TIME	MIN. ORD.	A C
-------------	------------	-----------	-----------------------------------	-----------	-----------	-----

103182648 BLOCK TERMINAL 9E1A-25 4
N

260395108 BLOCK TERMINAL PEDESTAL 5 PAIR

1976985 EA IL IN MI OH WI
08 08 08 08
Quiet front terminal block for buried pedestal applications. Used to connect customer service wire (drop) to the telephone network.

260395116 BLOCK TERMINAL PEDESTAL 10 PAIR

1976969 EA IL IN MI OH WI
08 08 08 08
Quiet front terminal block for buried pedestal applications. Used to connect customer service wire (drop) to the telephone network.

260434717 BLOCK TERMINAL PEDESTAL 12PR

1979989 1 EA IL IN MI OH WI
08 08 08
Quiet front terminal block for buried pedestal applications. Used to connect customer service wire (drop) to the telephone network.

260395132 BLOCK TERMINAL PEDESTAL 25 PAIR

1976977 EA IL IN MI OH WI
08 08 08 08 08
Quiet front terminal block for buried pedestal applications. Used to connect customer service wire (drop) to the telephone network.

401754338 BLOCK TERMINAL RGT 8 P1

N EA 1 8 10
Eight pair terminal used with GHC, CAD type closures with plastic sheath stubs. BSP 631-604-901N.

300050408 BLOCK TERMINAL RGT 12 18

N EA 1 8 10
Twelve pair terminal with 18in. plastic sheathed stub used with GHC, CAD type closures. BSP 631-604-901N.

401797725 BLOCK TERMINAL RGT 25 36

4194985 1 EA IL IN MI OH WI
08 08 08 08
A 25 pair terminal with 36in. plastic sheathed stub used with GHC, CAD type closures. BSP 631-604-901N.

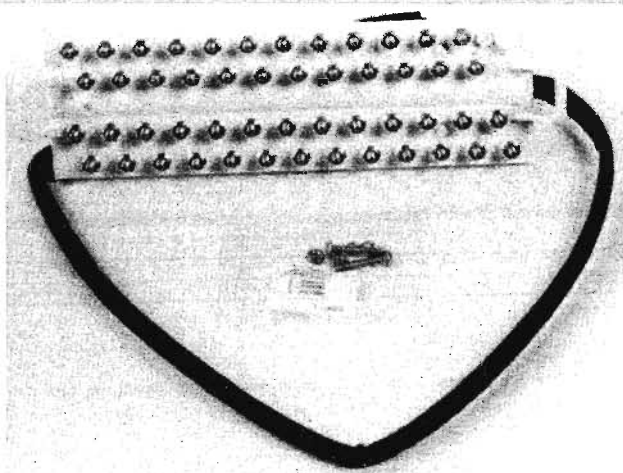

4194985

PRODUCT IDENTIFIER DESCRIPTION

ITEM NUMBER	ORD. MULT.	SELL UNIT	STD. PKG. STOCK AVAILABILITY / PA	LEAD TIME	MIN. ORD.	A C
-------------	------------	-----------	-----------------------------------	-----------	-----------	-----

002081792 BLOCK TERMINAL RGT 25A 48

1453142 1 EA IL IN MI OH WI
08 08 08
A 25 pair terminal with 48in. plastic sheathed stub used with GHC, CAD type closures. BSP 631-604-901N.

280093535 BLOCK TERMINAL RPT 6

N EA 1 8 10
A six pair terminal block used to terminate 6 pair cable in CAD type closures.

280029299 BLOCK TERMINAL TERMAX 5 PAIR

1922971 1 EA IL IN MI OH WI
08 08

BLOCK TERM CONNECTORIZED

260393566 BLOCK TERM CONNECTORIZED 400-0010-040

N EA 1 4 1

260360425 BLOCK TERM CONNECTORIZED 484-2064-043

1953844 1 EA IL IN MI OH WI
75

260437942 BLOCK TERM CONNECTORIZED 582-1004-345

N EA 1 4 1

BOARD

001031863 BOARD PARTICLE 3/4IN X 2FT X 4FT

5128587 1 EA

BOLT

280024928 BOLT ANCHOR EXPANSION 84099-02

N EA 1 2 1
Galvanized 1/2IN X 2 1/2IN. NOW AVAILABLE THROUGH TOUCH-TONE ORDER ENTRY.

280024886 BOLT CONNECTOR & NUT ASSEMBLY

N EA 1 2 15
Style 2 PB257. Used in the maintenance of batteries, and are the leaded bolts for the strappings on batteries.

900210493 BOLT HEX 1/2 13 X 1 1/2 W/NUT

N EA 100 4 300
Tap bolt, plain finish.

280051640 BOLT HEX HEAD 5/16 X 2IN

1926915 1 PK IL IN MI OH WI
18 18 18

300033867 BOLT LONG SB2375K 2 3/8IN

1331009 1 PK IL IN MI OH WI
08 08 08 08 08
Used with 2 type cover assembly only, package of 25.

DISTRIBUTION SERVICES

NETWORK SERVICES

TOOLS

BUILDING JANITORIAL

AUTOMOTIVE

FORMS/OFFICE SUPPLIES

GENERAL

DATA VOICE

DISTRIBUTION SERVICES
 NETWORK SERVICES
 TOOLS
 BUILDING JANITORIAL
 AUTOMOTIVE
 FORMS/OFFICE SUPPLIES
 GENERAL
 DATA VOICE

BOLT

PRODUCT IDENTIFIER DESCRIPTION

ITEM NUMBER	ORD. MULT.	SELL UNIT	STD. PKG. STOCK AVAILABILITY / PA	LEAD TIME	MIN. ORD.	A C
-------------	------------	-----------	-----------------------------------	-----------	-----------	-----

260406939 BOLT MANHOLE COVER 3 1/4IN LONG
 1971218 1 EA IL IN MI OH WI
 08 08 08 08 08
 With 5/8in x 11in thread.

300033826 BOLT SHORT SB1875K
 1330993 1 EA IL IN MI OH WI
 08 08 08 08 08
 Used with 2-type endplate and cover. This size used in all endplates and the center sections of the cover.

900211152 BOLT STOVE 1/4IN X 1 3/4IN
 1111518 1 BX IL IN MI OH WI
 08
 Round Head cadmium.

900307034 BOLT STOVE 1/4IN X 2IN
 5167940 1 EA IL IN MI OH WI
 08
 Round Head cadmium.

400013561 BOLT STOVE FLAT HEAD 5/16IN X 2IN
 1113506 25 EA IL IN MI OH WI
 18 18 18 18 18
 CA07337. Used for attaching S knobs to house or corner brackets. BSP 080-720-135.

400013579 BOLT STOVE FLAT HEAD 5/16IN X 3IN
 1113522 25 EA IL IN MI OH WI
 18 18 18 18 18
 CA07337. Used for attaching S knobs to house or corner brackets. BSP 080-720-135.

400013595 BOLT STUBBING 5/8IN X 24IN CA06400
 N EA 25 8 25

BOLT CARRIAGE

CA07096. GALVANIZED BOLT WITH ROUND OVAL HEAD AND SQUARE NUT, FOR FASTENING BRACES TO 4, 6 OR 10 PIN CROSSARMS.

400012589 BOLT CARRIAGE 1/2IN X 4 3/4IN
 1113100 1 EA

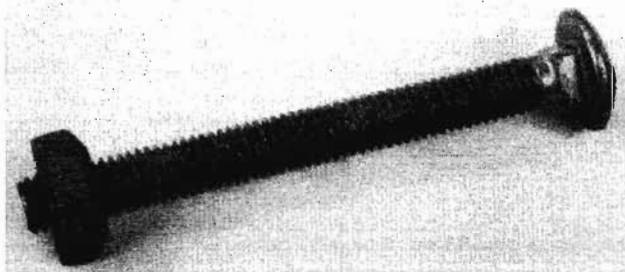

400012589

400012506 BOLT CARRIAGE 3/8IN X 3IN
 5166900 1 EA IL IN MI OH WI
 14 14

400012522 BOLT CARRIAGE 3/8IN X 4 1/2IN
 1113001 1 EA IL IN MI OH WI
 14 14 14 14 14

PRODUCT IDENTIFIER DESCRIPTION

ITEM NUMBER	ORD. MULT.	SELL UNIT	STD. PKG. STOCK AVAILABILITY / PA	LEAD TIME	MIN. ORD.	A C
-------------	------------	-----------	-----------------------------------	-----------	-----------	-----

400012514 BOLT CARRIAGE 3/8IN X 4IN
 1112987 1 EA IL IN MI OH WI
 14 14 14 14 14

400012530 BOLT CARRIAGE 3/8IN X 6IN
 1113027 1 EA IL IN MI OH WI
 14 14 14 14 14

400012548 BOLT CARRIAGE 3/8IN X 8IN
 1113043 1 EA IL IN MI OH WI
 14 14 14 14 14

400012555 BOLT CARRIAGE 3/8IN X 10IN
 1113068 1 EA IL IN MI OH WI
 14 14 14

400012563 BOLT CARRIAGE 3/8IN X 12IN
 1113084 1 EA IL IN MI OH WI
 14 14 14

400012605 BOLT CARRIAGE 5/8IN X 6IN
 1113126 1 EA IL IN MI OH WI
 14 14 14 14 14

BOLT GUY B

CA07081. FOR ATTACHING GUY AND SUSPENSION STRAND TO POLES. BSP 621-410-200.

400012852 BOLT GUY B 3/4IN X 12IN
 N EA 25 8 25

400012860 BOLT GUY B 3/4IN X 14IN
 N EA 25 8 25

400012787 BOLT GUY B 5/8IN X 8IN
 N EA 40 8 40

400012795 BOLT GUY B 5/8IN X 10IN
 N EA 35 8 35

400012803 BOLT GUY B 5/8IN X 12IN
 N EA 25 8 25

400012811 BOLT GUY B 5/8IN X 14IN
 N EA 25 8 25

400012928 BOLT GUY B 1IN X 6IN
 N EA 10 8 10

BOLT SUSPENSION CABLE A

PRODUCT IDENTIFIER		DESCRIPTION				
ITEM NUMBER	ORD. MULT.	SELL UNIT	STD. PKG. STOCK AVAILABILITY / PA	LEAD TIME	MIN. ORD.	A C

BOLT GUY S

CA07081. BOLT WITH CONTOURED EYE THAT KEEPS GUY STRAND FROM BENDING, KINKING OR SPREADING. FOR ATTACHING GUY AND SUSPENSION STRAND TO POLES. BSP 621-410-200.

400013272 BOLT GUY S 5/8IN X 10IN
1203539 1 EA



400013272

400013280 BOLT GUY S 5/8IN X 12IN
1113324 1 EA
IL IN MI OH WI
14 14 14 14 14

400013298 BOLT GUY S 5/8IN X 14IN
1167999 1 EA
IL IN MI OH WI
14 14 14 14 14

400013306 BOLT GUY S 5/8IN X 16IN
1227918 1 EA
IL IN MI OH WI
14 14 14 14 14

BOLT MACHINE

CA06207. NUTLESS. FOR USE IN CONSTRUCTION WORK.

400013462 BOLT MACHINE 1/2IN X 1 1/4IN
1113423 1 EA

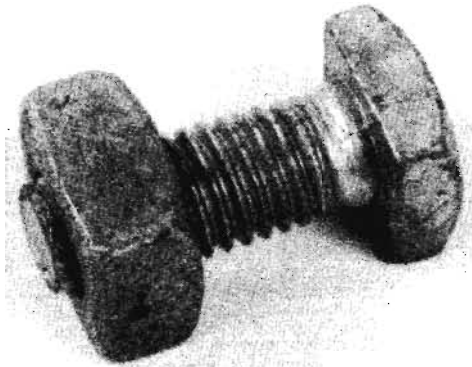

400013462

400013470 BOLT MACHINE 1/2IN X 1 3/4IN
1102152 1 EA
IL IN MI OH WI
14 14 14 14 14

400013488 BOLT MACHINE 1/2IN X 2 1/2IN
1180737 1 EA
IL IN MI OH WI
14 14 14 14 14

400013496 BOLT MACHINE 1/2IN X 4 1/2IN
1113449 1 EA
IL IN MI OH WI
14 14 14 14 14

PRODUCT IDENTIFIER		DESCRIPTION				
ITEM NUMBER	ORD. MULT.	SELL UNIT	STD. PKG. STOCK AVAILABILITY / PA	LEAD TIME	MIN. ORD.	A C

400013504 BOLT MACHINE 1/2IN X 6 IN
N EA 120 8 120
NOW AVAILABLE THROUGH TOUCH-TONE ORDER ENTRY.

400494886 BOLT MACHINE 3/8IN X 2 1/2IN
N EA 500 8 500

900192253 BOLT MACHINE 3/8IN X 2 1/2IN HEX
N EA 100 4 400

900113333 BOLT MACHINE 3/8IN X 2IN
1131110 1 EA
IL IN MI OH WI
08 08 08 08 08
CA06207. For use in construction work.

400013439 BOLT MACHINE 3/8IN X 3 IN
N EA 400 8 400

400013447 BOLT MACHINE 3/8IN X 5 IN
N EA 250 8 250

400013512 BOLT MACHINE 5/8IN X 5 1/2IN
N EA 80 8 80

400013520 BOLT MACHINE 5/8IN X 6 IN
1113480 1 EA
IL IN MI OH WI
14 14 14 14 14

BOLT SUSPENSION CABLE A

CA06645. GALVANIZED STEEL BOLT HAS SQUARE HEAD WITH TWO SQUARE NUTS, FOR MOUNTING CABLE SUSPENSION CLAMPS. BSP 627-220-200.

400013728 BOLT SUSPENSION CABLE A 3/4 X 10IN
1332775 1 EA

400013736 BOLT SUSPENSION CABLE A 3/4 X 12IN
1102178 1 EA
IL IN MI OH WI
08 08 08 08 08

400013744 BOLT SUSPENSION CABLE A 3/4 X 14IN
1101238 1 EA
IL IN MI OH WI
08 08 08 08 08

400013751 BOLT SUSPENSION CABLE A 3/4 X 16IN
1332783 1 EA
IL IN MI OH WI
08 08 08 08 08

400013769 BOLT SUSPENSION CABLE A 3/4 X 18IN
N EA 20 8 20

400013645 BOLT SUSPENSION CABLE A 5/8 X 8IN
1101253 1 EA
IL IN MI OH WI
08 08 08 08 08

400013652 BOLT SUSPENSION CABLE A 5/8 X 10IN
1102186 1 EA
IL IN MI OH WI
08 08 08 08 08

400013660 BOLT SUSPENSION CABLE A 5/8 X 12IN
1102194 1 EA
IL IN MI OH WI
08 08 08 08 08

DISTRIBUTION SERVICES

NETWORK SERVICES

TOOLS

BUILDING JANITORIAL

AUTOMOTIVE

FORMS/OFFICE SUPPLIES

GENERAL

DATA VOICE

BOLT SUSPENSION CABLE A

PRODUCT IDENTIFIER		DESCRIPTION						
ITEM NUMBER	ORD. MULT.	SELL UNIT	STD. PKG. STOCK AVAILABILITY / PA	LEAD TIME			MIN. ORD.	A C
400013678 BOLT SUSPENSION CABLE A 5/8 X 14IN								
1102210	1	EA	IL 08 IN 08 MI OH WI 08 08					
400013686 BOLT SUSPENSION CABLE A 5/8 X 16IN								
1102236	1	EA	IL 08 IN 08 MI OH WI 08 08					
400013694 BOLT SUSPENSION CABLE A 5/8 X 18IN								
1101261	1	EA	IL 08 IN 08 MI OH WI 08 08					

400013702 BOLT SUSPENSION CABLE A 5/8 X 20IN								
N		EA	25	8			25	
NOW AVAILABLE THROUGH TOUCH-TONE ORDER ENTRY.								
400013710 BOLT SUSPENSION CABLE A 5/8 X 22IN								
N		EA	25	8			25	
400314274 BOLT SUSPENSION CABLE A 5/8 X 24IN								
N		EA	25	8			25	
NOW AVAILABLE THROUGH TOUCH-TONE ORDER ENTRY.								
260441696 BOLT SUSPENSION CABLE A 5/8IN X 26IN								
N		EA	1	3			25	
J88-26.								
260441704 BOLT SUSPENSION CABLE A J88-28 5/8X28 IN								
N		EA	1	3			25	

BOLT SUSPENSION CABLE B								
CA06645. GALVANIZED STEEL BOLT THREADED AT BOTH ENDS WITH FOUR SQUARE NUTS, FOR MOUNTING CABLE SUSPENSION CLAMPS. BSP 627-220-200.								
400013850 BOLT SUSPENSION CABLE B 3/4 X 12IN								
N		EA	25	8			25	
400013868 BOLT SUSPENSION CABLE B 3/4 X 14IN								
N		EA	25	8			25	
400013876 BOLT SUSPENSION CABLE B 3/4 X 16IN								
N		EA	20	8			20	
400013884 BOLT SUSPENSION CABLE B 3/4 X 18IN								
N		EA	20	8			20	
400013892 BOLT SUSPENSION CABLE B 3/4 X 20IN								
N		EA	20	8			20	

400013777 BOLT SUSPENSION CABLE B 5/8 X 10IN								
1113563	1	EA	IL 08 IN 08 MI OH WI 08 08					



1113563

400013785 BOLT SUSPENSION CABLE B 5/8 X 12IN								
1203307	1	EA	IL 08 IN 08 MI OH WI 08 08					

PRODUCT IDENTIFIER		DESCRIPTION						
ITEM NUMBER	ORD. MULT.	SELL UNIT	STD. PKG. STOCK AVAILABILITY / PA	LEAD TIME			MIN. ORD.	A C
400013793 BOLT SUSPENSION CABLE B 5/8 X 14IN								
1134072	1	EA	IL 08 IN 08 MI OH WI 08 08					
400013801 BOLT SUSPENSION CABLE B 5/8 X 16IN								
1113621	1	EA	IL 08 IN 08 MI OH WI 08 08					
400013819 BOLT SUSPENSION CABLE B 5/8 X 18IN								
1113647	1	EA	IL 08 IN 08 MI OH WI 08 08					
400013827 BOLT SUSPENSION CABLE B 5/8 X 20IN								
1191338	1	EA	IL 08 IN 08 MI OH WI 08 08					

400013835 BOLT SUSPENSION CABLE B 5/8 X 22IN								
N		EA	25	8			25	
NOW AVAILABLE THROUGH TOUCH-TONE ORDER ENTRY.								

BOLT SUSPENSION CABLE C									
CA06645. GALVANIZED STEEL BOLT HAS ROUND HEAD WITH ONE SQUARE NUT, FOR MOUNTING CABLE SUSPENSION CLAMPS. BSP 627-220-200.									
400013900 BOLT SUSPENSION CABLE C 5/8 X 2 1/2									
1113761	1	EA							

BOLT TOGGLE									
400014197 BOLT TOGGLE SPRING 1/4IN X 3IN									
6279166	1	PK							
CA06734. Used in making attachments to hollow tile, blocks and etc, Package of 5, BSP 080-720-116.									

400014205 BOLT TOGGLE SPRING 1/4IN X 4IN								
1113860	1	PK	IL 18 IN 18 MI OH WI 18 18 18					
CA06734. Package of 5.								

400014155 BOLT TOGGLE SPRING 1/8IN X 3IN								
1113787	1	PK	IL 18 IN 18 MI OH WI 18 18 18					
CA06734. Package of 5.								

400014171 BOLT TOGGLE SPRING 3/16IN X 3IN								
N		PK	100	4			400	
CA06734. Package of 5.								

400014189 BOLT TOGGLE SPRING 3/16IN X 4IN								
N		PK	100	4			400	
CA06734. Package of 5.								

900280074 BOLT TOGGLE SPRING 3/16IN X 4IN								
1143156	1	EA	IL 18 IN 18 MI OH WI 18 18 18					
Flat head, package of 50.								

900211194 BOLT TOGGLE SPRING 5/16IN X 4IN								
1113886	1	PK	IL 18 IN 18 MI OH WI 18 18 18					
Round head.								

DISTRIBUTION SERVICES

NETWORK SERVICES

TOOLS

BUILDING JANITORIAL

AUTOMOTIVE

FORMS/OFFICE SUPPLIES

GENERAL

DATA VOICE

PRODUCT IDENTIFIER		DESCRIPTION				
ITEM NUMBER	ORD. MULT.	SELL UNIT	STD. PKG. STOCK AVAILABILITY / PA	LEAD TIME	MIN. ORD.	A C
001036193 BOLT TOGGLE SPRING 5/16IN X 5IN						
5168427	1	PK	IL IN MI OH WI 18 18 18 18 18			
Flat Head.						
400014221 BOLT TOGGLE SPRING 5/16IN X 6IN						
1113902	1	PK	IL IN MI OH WI 18 18 18 18 18			
CA06734. Package of 5.						

BOND RIBBON

401900022 BOND RIBBON SPLICE FBB 9/31						
N		EA	100	6	100	
DISCONTINUED - REPLACED BY BOND RIBBON SPLICE W/EYELET AND COVER, EM-2051 ULTRABOND #6						
401900030 BOND RIBBON SPLICE FBB 14/48						
N		EA	100	6	100	
A 14in double eyelet braided bond, package of 10. REPLACED BY 1951806						
400260337 BOND RIBBON SPLICE PLAIN 5LB						
1236828	1	SP	IL IN MI OH WI 08 08 08 08 08			
Used for bonding cable or cable and strand, CA06868 - BSP 638-300-200.						
260348891 BOND RIBBON SPLICE W/EYELET & COVER						
1951806	1	RO	IL IN MI OH WI 08 08 08 08 08			
A flexible braided bond with eyelets at 3in intervals and a plastic cover. Used for all cable bonding, 25ft per roll.						

BOX

300030244 BOX MOUNTING CAC 640MB-50 IVORY						
N		EA	1	2	1	
103800462 BOX SERVICE 810B						
1171637	1	EA	IL IN MI OH WI 18 18			
103552865 BOX STATION WIRE 800A						
N		EA	225	1	225	
Prewire termination box. Telco will provide outlet box, allows customer to install own jack, BSP 461-400-140. FORWARD TO BRACKET PREWIRE FSB. NOW AVAILABLE THROUGH TOUCH-TONE ORDER ENTRY.						
002076537 BOX TELEPHONE SERVICE SE 102B						
1145979	1	EA	IL IN MI OH WI 18 18 18			
Used to mount 625TD, 742A/B and 123, 128 protectors inside the customers dwelling when drywall or other wall finishes are present at time of prewire.						

BOX APPARATUS

997301072 BOX APPARATUS 105C						
1158600	1	EA				

PRODUCT IDENTIFIER		DESCRIPTION				
ITEM NUMBER	ORD. MULT.	SELL UNIT	STD. PKG. STOCK AVAILABILITY / PA	LEAD TIME	MIN. ORD.	A C
101605129 BOX APPARATUS 115C1						
2826305	1	EA	IL IN MI OH WI 18 18 18 18 18			
Used to provide facilities for mounting and housing 66B & 66M type Connecting Blocks, BSP 461-604-101.						

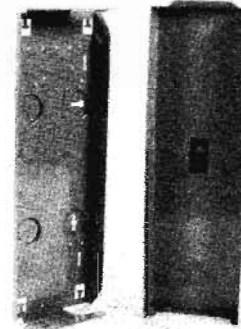

2826305

101605137 BOX APPARATUS 115D1						
1136655	1	EA	IL IN MI OH WI 18 18 18 18 18			
Used to provide facilities for mounting and housing 66B & 66M type connecting blocks, BSP 461-604-101.						

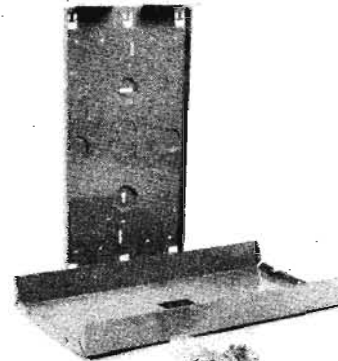

1136655

023000508 BOX APPARATUS 121C E/W 66B4 25-60						
1189175	1	EA	IL IN MI OH WI 18			
1816967 E/W 1-66.						

BOX OUTLET

401332515 BOX OUTLET 4CS 1/2IN						
5169565	1	EA				
Appleton with four 1/2in side knockouts an two 1/2in end knockouts. DISCONTINUE UPON STOCK DEPLETION						
986533659 BOX OUTLET 4SSL 1/2IN APPLETON						
5170001	1	EA	IL IN MI OH WI 18 18			
DISCONTINUE UPON STOCK DEPLETION						

DISTRIBUTION SERVICES

NETWORK SERVICES

TOOLS

BUILDING JANITORIAL

AUTOMOTIVE

FORMS/OFFICE SUPPLIES

GENERAL

DATA VOICE

DISTRIBUTION SERVICES

NETWORK SERVICES

TOOLS

BUILDING JANITORIAL

AUTOMOTIVE

FORMS/OFFICE SUPPLIES

GENERAL

DATA VOICE

BOX OUTLET

PRODUCT IDENTIFIER		DESCRIPTION						
ITEM NUMBER	ORD. MULT.	SELL UNIT	STD. PKG. STOCK AVAILABILITY / PA	LEAD TIME	MIN. ORD.	A	C	
996533832 BOX OUTLET 54151 1/2IN APPLETON								
5170068	1	EA	IL IN MI OH WI 18					
DISCONTINUE UPON STOCK DEPLETION								
401246350 BOX OUTLET B CA08732 L 3								
2609800	1	EA	IL IN MI OH WI 18 18 18 18 18					
Phenolic box used with B weatherproof jacks. Can be used on marine and recreational vehicle installations, BSP 461-220-101, BSP 461-630-100. Arrowhart WE16619.								

401885496 BOX OUTLET CK20375 P32092							
N		EA	1	6	1		
100849751 BOX OUTLET D95334							
N		EA	1	1	1		

BOX SEALANT

401788955 BOX SEALANT 4075							
5253203	1	EA	Use with 4000B connector. Box of 12.				
900405952 BOX SEALANT 4075S							
1196659	1	EA	IL IN MI OH WI 08 08 08 08 08	Provides moisture protection for module super mini 4000D. E/W inspection tool. Box of 12.			
300061082 BOX SEALANT 4077A							
1331025	1	EA	IL IN MI OH WI 08 08 08 08 08	Moisture proof for one 4005 DPM module. Case of 120.			

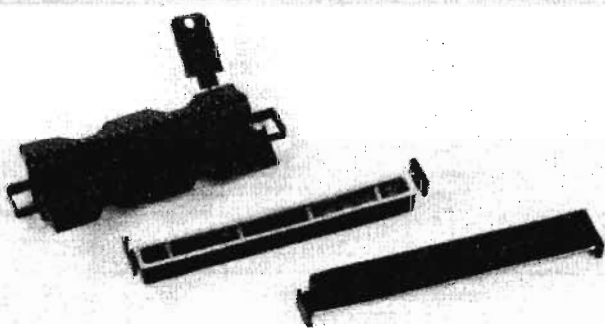

1331025

300015591 BOX SEALANT 4077B							
1306498	1	EA	IL IN MI OH WI 08 08 08 08 08	Moisture proof for one 4005 DPM plugged to one 4000 D super mini module. Case of 120.			
300015609 BOX SEALANT 4077C							
1306506	1	EA	IL IN MI OH WI 08 08 08 08 08	Moisture proof for two 4005 DPM modules. Case of 120.			

PRODUCT IDENTIFIER		DESCRIPTION						
ITEM NUMBER	ORD. MULT.	SELL UNIT	STD. PKG. STOCK AVAILABILITY / PA	LEAD TIME	MIN. ORD.	A	C	
300062387 BOX SEALANT 4077D								
1331017	1	EA	IL IN MI OH WI 08 08 08 08 08	Moisture proof for three 4005 DPM modules. Case of 120.				
260435631 BOX SEALANT 4077D-4W								
1980490		EA	IL IN MI OH WI	Moisture proofs for (2) 4005DPM/TR'S and (1) 4000-DT/TR modules.				

BOX TERMINAL

400016911 BOX TERMINAL CABLE HS 6							
1217570	1	EA	A metal 6 pair terminal used for housing a 30A connecting block and fanning strip. 5in X 3 3/4in X 1 5/8in, BSP 631-400-150.				

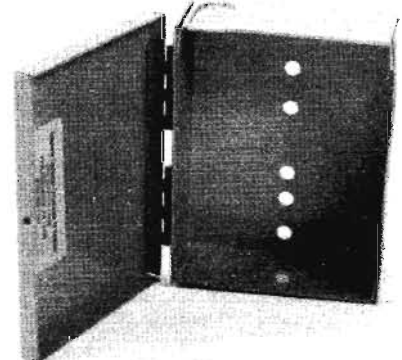

400016911

BRACE

400017000 BRACE CROSSARM 30IN CA03529							
1101287	1	EA	A 30in piece of galvanized steel used to brace crossarms on poles, package of 20, BSP 621-314-204.				
400016937 BRACE GUARDARM CA06177							
N		EA	25	8	25		

BRACKET

280023268 BRACKET 12-187 4IN							
1953349	1	EA	Manhole or pole mounted. DISCONTINUE, ORDER NON STOCK UPON STOCK DEPLETION				
280023300 BRACKET 12-188 8IN							
1953331	1	EA	IL IN MI OH WI 08 08 08 08 08	Manhole mounted.			

PRODUCT IDENTIFIER DESCRIPTION

ITEM NUMBER	ORD. MULT.	SELL UNIT	STD. PKG. STOCK AVAILABILITY / PA	LEAD TIME	MIN. ORD.	A C
-------------	------------	-----------	-----------------------------------	-----------	-----------	-----

100013655 BRACKET 45A

IL	IN	MI	OH	WI
08	08	08	08	08

Used for mounting on poles and horizontal or vertical mountings on walls or walls of cable terminals, BSP 631-210-202, BSP 461-619-101. Package of 50.

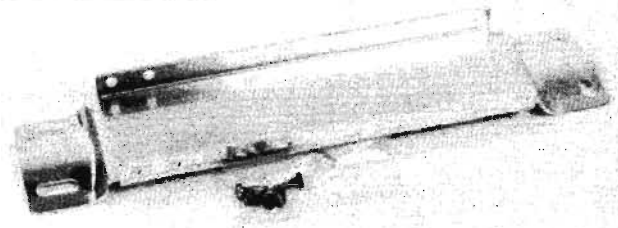

1162750

100013705 BRACKET 51B

IL	IN	MI	OH	WI
08	08	08	08	08

Used to support 1B or 2A splice case and 49, 61, TC, TC, TE, TF type terminals where strand is not provided, BSP 631-020-200. Package of 25.



1116285

101334167 BRACKET 89B

IL	IN	MI	OH	WI
18	18	18	18	18

Consists of molded fire retardant plastic. Designed to accommodate a 66M1-50 connecting block with snap-on, snap off latches, BSP 518-300-100.

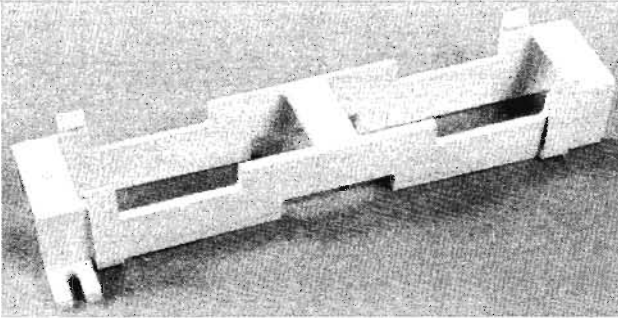

1116624

103628392 BRACKET 128A

N	EA	1	8	1

For use with #80 type C cabinets to locate mounting inserts and cable entrance openings in the concrete pad. NOW AVAILABLE THROUGH TOUCH-TONE ORDER ENTRY.

104164850 BRACKET 128C

IL	IN	MI	OH	WI
08	08	08	08	08

103756896 BRACKET 130A

N	EA	1	2	1

For use with #40 type A cabinets to locate mounting inserts and cable opening in the concrete pad.

PRODUCT IDENTIFIER DESCRIPTION

ITEM NUMBER	ORD. MULT.	SELL UNIT	STD. PKG. STOCK AVAILABILITY / PA	LEAD TIME	MIN. ORD.	A C
-------------	------------	-----------	-----------------------------------	-----------	-----------	-----

103756904 BRACKET 130B

IL	IN	MI	OH	WI
			18	18

103827416 BRACKET 131B POLE MOUNTING

IL	IN	MI	OH	WI
08	08	08	08	08

Mounting bracket for attaching 818 and 819 apparatus cases to poles.

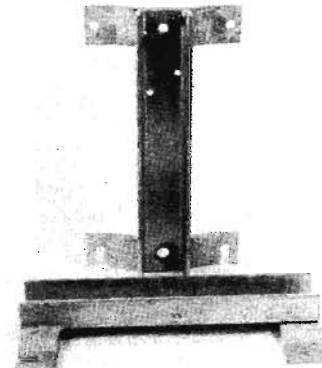

1920116

104436852 BRACKET 145A

N	EA	1	6	1

102431434 BRACKET 63B

IL	IN	MI	OH	WI
18	18	18	18	18

Designed for use in prewiring building during construction provides mechanical termination for station wire before wall is enclosed.

103756912 BRACKET 130C

N	EA	1	2	1

280029935 BRACKET ADJUSTABLE TERMAX C2368

IL	IN	MI	OH	WI
08				

300041720 BRACKET BSO-1 'B' STANDOFF MOUNTING

IL	IN	MI	OH	WI
08	08	08	08	08

For 'B' type Terminal Block.

400017778 BRACKET CAPACITOR B CA08177

IL	IN	MI	OH	WI
08				

10 per package.

401307244 BRACKET CK20502 L 2

IL	IN	MI	OH	WI
18	18	18	18	18

Bracket designed for recessed wall mounting of telephone jacks and connecting blocks, BSP 461-630-100.

DISTRIBUTION SERVICES

NETWORK SERVICES

TOOLS

BUILDING JANITORIAL

AUTOMOTIVE

FORMS/OFFICE SUPPLIES

GENERAL

DATA VOICE

DISTRIBUTION SERVICES

NETWORK SERVICES

TOOLS

BUILDING JANITORIAL

AUTOMOTIVE

FORMS/OFFICE SUPPLIES

GENERAL

DATA VOICE

BRACKET

PRODUCT IDENTIFIER		DESCRIPTION						
ITEM NUMBER	ORD. MULT.	SELL UNIT	STD. STOCK	PKG. AVAILABILITY	LEAD TIME / PA	MIN. ORD.	A C	

400017836 BRACKET CORNER L 46L232

1116962	1	EA	IL	IN	MI	OH	WI
			08	08	08	08	08

For use in drop and block wiring, long bracket, 5 5/8in clearance, package of 50, BSP 080-720-135.

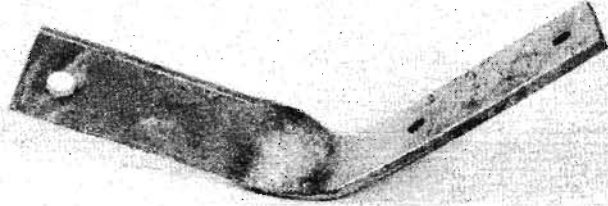

1116962

400017844 BRACKET CORNER S 46L232

1116988	1	EA	IL	IN	MI	OH	WI
			08	08	08	08	08

Used where the pole lead attaches to the building at an angle or to carry leads around the corner of a building. Consists of a short bracket with 3 5/8in clearance, BSP 080-720-135.

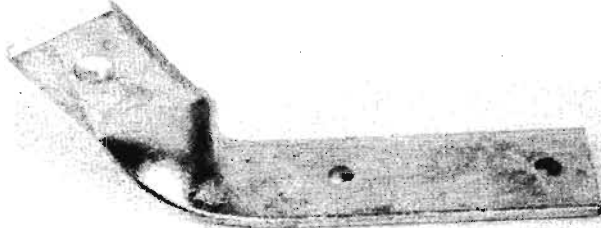

1116988

260405790 BRACKET H89 ACCESSORY

N	EA	1	4	1
---	----	---	---	---

Homaco, for quick connect blocks.

260364880 BRACKET HANGAR OFFSET AC-HBI

1954867	1	SE	IL	IN	MI	OH	WI
			08	08	08	08	08

400314571 BRACKET HOUSE CA04591

1117044	1	EA	IL	IN	MI	OH	WI
			08	08	08	08	08

For use with porcelain knobs for supporting drop wires, BSP 080-720-134.



1117044

PRODUCT IDENTIFIER		DESCRIPTION						
ITEM NUMBER	ORD. MULT.	SELL UNIT	STD. STOCK	PKG. AVAILABILITY	LEAD TIME / PA	MIN. ORD.	A C	

260418819 BRACKET L TIE SUPPORT CSS-H

1973693	1	EA	IL	IN	MI	OH	WI
			21	21	21		

Chrome L bracket w/mounting holes & tie support openings for Deltec ties. Quote # T06548.

300040474 BRACKET MSO-1 FOR 'M' STANDOFF MOUNTING

1123158	1	EA	IL	IN	MI	OH	WI
			08	08	08	08	08

For 'M' type Terminal Block.

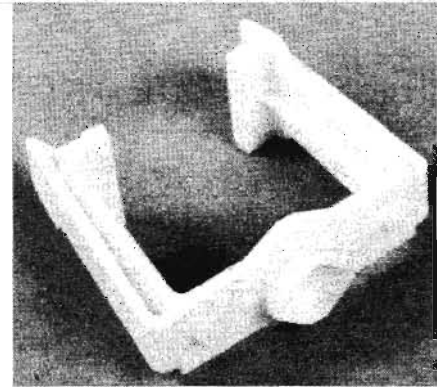

1123158

260404074 BRACKET PAD HA21L-0001-T017

N	EA	1	6	1
---	----	---	---	---

260447669 BRACKET POLE-MOUNT 1200PR

N For Reliable cabinets.

260447644 BRACKET POLE-MOUNT 400PR

N For Reliable cabinets.

260447651 BRACKET POLE-MOUNT 500-900PR

N For Reliable cabinets.

300055662 BRACKET PREWIRE FSB 4001

1226001	1	EA	IL	IN	MI	OH	WI
			18	18	18	18	18

400018206 BRACKET SIGN 170 SIZE 2

1117184	1	EA	IL	IN	MI	OH	WI
			18	18	18	18	18

Fits 1 7/8in to 3in post, also used for holding drop wires on metal poles, package of 50, CA06726 - BSP 462-350-213.

400018214 BRACKET SIGN 170 SIZE 3

1117200	1	EA	IL	IN	MI	OH	WI
			18	18	18	18	18

For use in mounting flange type phone signs on posts or poles. Fits 3in to 4in diameter post, package of 50.

400018222 BRACKET SIGN 170 SIZE 4

1117226	1	EA	IL	IN	MI	OH	WI
			59	59	59	59	59

Fits 4in to 5in diameter post, package of 50.

DISTRIBUTION SERVICES

NETWORK SERVICES

TOOLS

BUILDING JANITORIAL

AUTOMOTIVE

FORMS/OFFICE SUPPLIES

GENERAL

DATA VOICE

PRODUCT IDENTIFIER		DESCRIPTION					
ITEM NUMBER	ORD. MULT.	SELL UNIT	STD. PKG. STOCK AVAILABILITY / PA	LEAD TIME	MIN. ORD.	A	C

400018230 BRACKET SIGN 188 SIZE 6							
1117242	50	EA	IL 59 IN 59 MI 59 OH 59 WI 59				
Fits 5in to 8in diameter post, package of 50, CA06726 - BSP 508-810-205.							

400018248 BRACKET SIGN 188 SIZE 10							
1117267	40	EA	IL 59 IN 59 MI 59 OH 59 WI 59				
Fits 8in to 12in diameter post, package of 50.							

260392311 BRACKET TELEPHONE LBE-0147-10							
1965863		EA	IL 09 IN IN MI OH WI				

260418801 BRACKET U CHANNEL TIE CSS-BOY							
1973685		EA	IL 14 IN 14 MI OH WI 14				
Chrome U-shape bracket w/2 screw holes used to fasten w/Deltec ties to flat surfaces. Quote # T0654B.							

400018495 BRACKET WALL E CA06573							
N		EA	25	10	50		

400018503 BRACKET WALL L CA06573							
1102277	1	EA	IL 08 IN 08 MI 08 OH 08 WI 08				
An L shaped bracket used in attaching strand to buildings where there are obstructions on a wall, BSP 627-610-611.							



1102277

400018511 BRACKET WALL S CA06573							
1332767	1	EA	IL 08 IN 08 MI 08 OH 08 WI 08				
A wall bracket designed for terminating aerial wire or cable.							

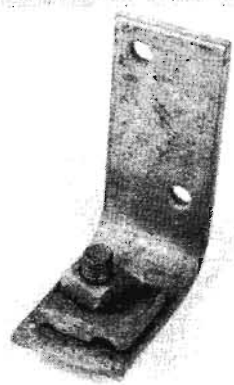

1332767

PRODUCT IDENTIFIER		DESCRIPTION					
ITEM NUMBER	ORD. MULT.	SELL UNIT	STD. PKG. STOCK AVAILABILITY / PA	LEAD TIME	MIN. ORD.	A	C

BRAID BONDING							
SEE BOND.							

BRIDGE LIFTER							
SEE LIFTER BRIDGE.							

BRIEFCASE							
260444716 BRIEFCASE CANVAS							
N		EA	1	7	1000		
For Outside Plant personnel.							

BUILDOUT							
260303276 BUILDOUT 401 /501 /601M1							
1940312	1	EA					
Consists of an assembly containing a barrel, biconic sleeve, and retaining ring. Each end is equipped with a protective cap, gray.							

103912812 BUILDOUT 401A1							
N		EA	1	2	1		
Consists of a biconical sleeve housed in a polycarbonate barrel. Sleeves contain a carbon filter.							

105275630 BUILDOUT 401M1/501M1/601M1							
N		EA	1	2	1		

103910949 BUILDOUT 500A CABLE							
N		EA	1	2	1		
Consists of a special lightguide connector attached to a short LA1A-A lightguide interconnection cable. Sleeve contains a carbon filter. NOW AVAILABLE THROUGH TOUCH-TONE ORDER ENTRY.							

103912861 BUILDOUT 501A1							
1147165	1	EA	IL 21 IN MI 21 OH 21 WI 21				
Multimode. Biconical sleeve housed in a polycarbonate barrel. Sleeves contain a carbon filter. 4-6 DB.							

103912879 BUILDOUT 501B1 LIGHTGUIDE							
6510966	1	EA	IL IN MI OH WI 21 21				
6-8 DB, white.							

103912887 BUILDOUT 501C1							
1188938	1	EA	IL IN MI OH WI 21 21 21				
8-10 DB.							

103912895 BUILDOUT 501D1 MULTIMODE							
N		EA	1	2	1		

103912903 BUILDOUT 501E1 LIGHTGUIDE							
6510917	1	EA	IL IN MI OH WI 21 21				
12-14 DB, white.							

DISTRIBUTION SERVICES
NETWORK SERVICES
TOOLS
BUILDING JANITORIAL
AUTOMOTIVE
FORMS/OFFICE SUPPLIES
GENERAL
DATA VOICE

BUILDOUT

PRODUCT IDENTIFIER		DESCRIPTION						
ITEM NUMBER	ORD. MULT.	SELL UNIT	STD. PKG. STOCK AVAILABILITY / PA	LEAD TIME	MIN. ORD.	A	C	
103912911 BUILDOUT 501F1								
1140517	1	EA	IL IN MI OH WI 21 21 21 21					
14-16 DB.								
103911111 BUILDOUT 600E CABLE								
N		EA	1	2	1			
260303300 BUILDOUT 601 /701S1								
1940320	1	EA	IL IN MI OH WI 21 21 21 21					
DB Singlemode-to-Singlemode connection, without attenuation is required.								
								
1940320								
105166474 BUILDOUT 60151/70151								
N		EA	1	2	1			
103912937 BUILDOUT 601A1								
1218396	1	EA	IL IN MI OH WI 21 21 21 21					
Singlemode. Consists of a biconical sleeve housed in a polycarbonated barrel. Sleeves contain a carbon filter. 2-4 DB, white.								
103912945 BUILDOUT 601B1								
1131490	1	EA	IL IN MI OH WI 21 21 21 21					
4-6 DB, white.								
103912952 BUILDOUT 601C1								
1190017	1	EA	IL IN MI OH WI 21 21 21 21					
Singlemode 6-8 DB white.								
103912960 BUILDOUT 601D1								
1114496	1	EA	IL IN MI OH WI 21 21 21 21					
8-10 DB, white.								
103912978 BUILDOUT 601E1								
1159558	1	EA	IL IN MI OH WI 21 21 21 21					
Singlemode 10-12 DB white.								
103912986 BUILDOUT 601M1 MULTIMODE								
N		EA	1	2	1			
Contains standard low-loss multimode sleeve.								
105166060 BUILDOUT 701B1 SINGLEMODE								
N		EA	1	2	1			

PRODUCT IDENTIFIER		DESCRIPTION						
ITEM NUMBER	ORD. MULT.	SELL UNIT	STD. PKG. STOCK AVAILABILITY / PA	LEAD TIME	MIN. ORD.	A	C	
105166086 BUILDOUT 701D1 SINGLEMODE								
N		EA	1	2	1			
105166094 BUILDOUT 701E1 SINGLEMODE								
N		EA	1	2	1			
105166102 BUILDOUT 701F1 SINGLEMODE								
N		EA	1	2	1			
105166128 BUILDOUT 701H1 SINGLEMODE								
N		EA	1	2	1			
105383830 BUILDOUT BLOCK 1000BC								
N		EA	1	2	1			
260027271 BUILDOUT DP11 06-00006								
1214965	1	EA	IL IN MI OH WI					
260027230 BUILDOUT DP11 06-00008								
1214916	1	EA	IL IN MI OH WI					
260027248 BUILDOUT DP11 06-00014								
1214924	1	EA	IL IN MI OH WI					
260027289 BUILDOUT DP11 06-00016								
1214981	1	EA	IL IN MI OH WI					
260027255 BUILDOUT DP11 06-00023								
1214932	1	EA	IL IN MI OH WI					
260027297 BUILDOUT DP11 06-00026								
1214999	1	EA	IL IN MI OH WI					
260027263 BUILDOUT DP11 06-00032								
1214957	1	EA	IL IN MI OH WI					
260027305 BUILDOUT DP11 06-00036								
1215004	1	EA	IL IN MI OH WI					
BUSHING								
260346762 BUSHING B-100- 50								
N		EA	1	2	1			
78-8011-1905-4.								
260346770 BUSHING B-100- 70								
N		EA	1	2	1			
78-8041-9019-3.								
260322284 BUSHING B-125-100								
N		EA	1	2	1			
260322292 BUSHING B-175-125								
N		EA	1	2	1			

PRODUCT IDENTIFIER DESCRIPTION

ITEM NUMBER	ORD. MULT.	SELL UNIT	STD. PKG. STOCK AVAILABILITY / PA	LEAD TIME	MIN. ORD.	A C
-------------	------------	-----------	-----------------------------------	-----------	-----------	-----

260322300 BUSHING B-175-150
N EA 1 2 1

260322318 BUSHING B-225-175
N EA 1 2 1
NOW AVAILABLE THROUGH TOUCH-TONE ORDER ENTRY.

260346788 BUSHING B-225-200
N EA 1 2 1
78-8041-9119-1.

260346796 BUSHING B-275-200
N EA 1 2 1
78-8011-2951-7.

260330048 BUSHING B-275-225
N EA 1 2 1

260322326 BUSHING B-275-250
N EA 1 2 1

260322334 BUSHING B-300-275
1969717 EA IL 08 IN MI 08 OH WI 08

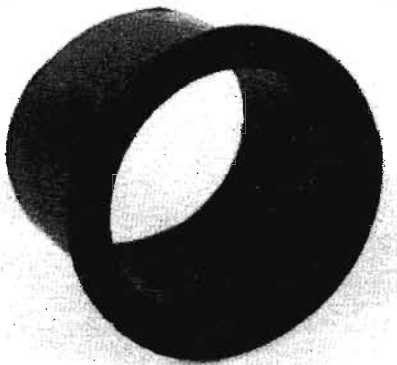

1969717

260322342 BUSHING B-360-300
1969709 EA IL 08 IN MI 08 OH WI 08

260322359 BUSHING B-360-330
1969691 EA IL 08 IN MI 08 OH WI

260346804 BUSHING B-390-360
N EA 1 2 1
78-8011-2957-4.

BUSHING VARIABLE

260346812 BUSHING VARIABLE B 1.00-2.50
N EA 1 2 1
78-8011-1922-9.

260346820 BUSHING VARIABLE B 1.75-1.50-1.00
N EA 1 2 1
78-8011-1807-2.

PRODUCT IDENTIFIER DESCRIPTION

ITEM NUMBER	ORD. MULT.	SELL UNIT	STD. PKG. STOCK AVAILABILITY / PA	LEAD TIME	MIN. ORD.	A C
-------------	------------	-----------	-----------------------------------	-----------	-----------	-----

260322367 BUSHING VARIABLE B 2.50-1.00
N EA 1 2 1

CABINET

102895042 CABINET 34C
N EA 1 6 1
Back is mounting surface for #100, 101, & 200 type connecting units. Gate has mounting space for #2 power panel and one or two #702 or 703 type panels.

104178843 CABINET 36E 367165
1142133 1 EA IL 04 IN MI OH WI
Weather-proof housing initially intended for use with SLC-96 Carrier System. 48 X 29 X20.5 inches.

103081337 CABINET 40AA1- 10S/600HA
N EA 1 6 1

103081378 CABINET 40AP1- 108S/600HA
N EA 1 6 1

102805991 CABINET 40AP1-J1
N EA 1 3 1

103081477 CABINET 40BP1- 108S/1200HA
N EA 1 1 1

102806064 CABINET 40BP1-J1
N EA 1 3 1

103160701 CABINET 40CP1-J1
N EA 1 2 1

300080397 CABINET 4200ER EMPTY-MBT
N EA 1 3 1

300086303 CABINET 4200FR EMPTY-MBT
N EA 1 3 1

260405378 CABINET 4927SS COCOA BROWN
N EA 1 4 1

102936630 CABINET FDR 40AP1 76S/ 300HA
N EA 1 1 1

103243218 CABINET FDR 40AP1 108S/ 600KT
N EA 1 5 1

103081543 CABINET FDR 40CA1 108S
N EA 1 5 1

103081584 CABINET FDR 40CP1 108S/1200HA
N EA 1 5 1

103243267 CABINET FDR 40CP1 108S/1200KT
N EA 1 4 1

103081618 CABINET FDR 40CP1 108S/1800HA
N EA 1 1 1

DISTRIBUTION SERVICES

NETWORK SERVICES

TOOLS

BUILDING JANITORIAL

AUTOMOTIVE

FORMS/OFFICE SUPPLIES

GENERAL

DATA VOICE

DISTRIBUTION SERVICES

NETWORK SERVICES

TOOLS

BUILDING JANITORIAL

AUTOMOTIVE

FORMS/OFFICE SUPPLIES

GENERAL

DATA VOICE

CABINET

PRODUCT IDENTIFIER		DESCRIPTION				
ITEM NUMBER	ORD. MULT.	SELL UNIT	STD. PKG. STOCK AVAILABILITY / PA	LEAD TIME	MIN. ORD.	A C
103243275		CABINET FDR 40CP1	108S/1800KT	1	5	1
N		EA				
103081667		CABINET FDR 40DP1	108S	1	4	1
N		EA				
103081691		CABINET FDR 40DP1	108S/2700HA	1	1	1
N		EA				
103243283		CABINET FDR 40DP1	108S/2700KT	1	5	1
N		EA				
104408869		CABINET FDR 40DP2	108S/2700HA	1	5	1
N		EA				
104408851		CABINET FDR 49CP2	108S/1800HA	1	5	1
N		EA				
105685093		CABINET LG 41BP1-ILGCS/TS-1		1	2	1
N		EA				
601075419		CABINET LSCIE ED8C008-50	G15	1	4	1
N		EA				
		E/W G7 & Six G12.				
601158066		CABINET LSCIM ED8C010-50	G1	1	4	1
N		EA				
		E/W G5 & G10.				
601158074		CABINET LSCIM ED8C010-50	G2	1	4	1
N		EA				
		E/W G5 & G10.				
601158017		CABINET LSCIT ED8C007-50	G2	1	4	1
N		EA				
		E/W G5 & Three G10.				
280027970		CABINET MHI OR SS-25	200-PAIR	1	3	1
N		EA				
		4365.				
280027988		CABINET MHI OR SS-25	600-PAIR	1	3	1
N		EA				
		4382.				
280027947		CABINET PEDESTAL 4065	300 PAIR	1	3	1
N		EA				
280027954		CABINET PEDESTAL 4082	900 PAIR	1	3	1
N		EA				
		With 4032 latch.				
401389358		CABINET PEDESTAL 4084		1	2	1
N		EA				
401389366		CABINET PEDESTAL 4086		1	2	1
N		EA				
280080698		CABINET PEDESTAL 4200EE		1	2	1
N		EA				
280027962		CABINET POLE MOUNT 1800-PAIR		1	2	1
N		EA				
		4095.				

PRODUCT IDENTIFIER		DESCRIPTION				
ITEM NUMBER	ORD. MULT.	SELL UNIT	STD. PKG. STOCK AVAILABILITY / PA	LEAD TIME	MIN. ORD.	A C
300097128		CABINET POLE MOUNT MHI OR SS25		1	3	1
N		EA				
		1200 Pair 4395.				
260426846		CABINET POSITRON 4900 P		1	1	1
N		EA				
		Assembled with backboard.				
260440326		CABINET RT 80A		1	4	1
N		EA				

CABINET CROSS-CONNECT

260327085		CABINET CROSS-CONNECT	600 25FT T			
1948455	1	EA				
		Pole mounted, binding post application, top entry, single stud with air core stub.				

260327184		CABINET CROSS-CONNECT	900 25FT T			
1948471	1	EA	IL IN MI OH WI 15 15 15 15 15			
		Pole mounted, binding post application, top entry, single stud with air core stub.				

260327283		CABINET CROSS-CONNECT	1200 25FT T			
1948497	1	EA	IL IN MI OH WI 15 15 15 15 15			
		Pole mounted, binding post application, top entry, single stud with air core stub.				

260327382		CABINET CROSS-CONNECT	1500 25FT T			
1948513	1	EA	IL IN MI OH WI 15 15 15 15 15			
		Pole mounted, binding post application, top entry, single stud with air core stub.				

260327481		CABINET CROSS-CONNECT	1800 25FT T			
1948539	1	EA	IL IN MI OH WI 15 15 15 15 15			
		Pole mounted, binding post application, top entry, single stud with air core stub.				

260406863		CABINET CROSS-CONNECT	2400-S DPM			
N		EA		1	4	1
		FSCQF 2400 S MSAM single side.				

260406871		CABINET CROSS-CONNECT	2700-S DPM			
N		EA		1	4	1
		FSCQF 2700 S MSAM DPM single.				

280027319		CABINET CROSS-CONNECT	4200-E EMPTY			
1922328	1	EA	IL IN MI OH WI 08 08 08 08 08			
		Pedestal, 900 pair maximum single side.				

300073715		CABINET CROSS-CONNECT	4200-F EMPTY			
5121749	1	EA	IL IN MI OH WI 08 08 08 08 08			
		Pedestal, 1800 pair maximum single-sided. Three SS-6-DPM frames must be ordered with 4200.				

DISTRIBUTION SERVICES

NETWORK SERVICES

TOOLS

BUILDING JANITORIAL

AUTOMOTIVE

FORMS/OFFICE SUPPLIES

GENERAL

DATA VOICE

PRODUCT IDENTIFIER DESCRIPTION

ITEM NUMBER	ORD. MULT.	SELL UNIT	STD. PKG. STOCK AVAILABILITY / PA	LEAD TIME	MIN. ORD.	A C
-------------	------------	-----------	-----------------------------------	-----------	-----------	-----

300073723 CABINET CROSS-CONNECT 4200-G EMPTY
 5121756 1 EA IL IN MI OH WI
 08 08 08 08
 Pedestal, 2700 pair maximum double-sided.
 Four SS6-DPM and one SS3-DPM frames must be ordered.

260326178 CABINET CROSS-CONNECT SS 200PR DPM 4365
 N EA 1 2 1
 3M product with self strip connector.

260326186 CABINET CROSS-CONNECT SS 400PR DPM 4382
 N EA 1 2 1
 3M product with self strip connector.

260326194 CABINET CROSS-CONNECT SS 600PR DPM 4382
 N EA 1 2 1
 3M product with self strip connector.

260326160 CABINET CROSS-CONNECT SS 100PR DPM 4365
 N EA 1 2 1
 3M product with self strip connector.

260326202 CABINET X-CONN SS 600PR DPM 4200E
 1945741 1 EA IL IN MI OH WI
 15 15 15 15
 Single-sided 3M product with self strip connector.

260442611 CABINET X-CONN SS 900PR DPM 4200E
 N EA 1 3 1
 Almond.

260326210 CABINET X-CONN SS 900PR DPM 4200E
 1945758 1 EA IL IN MI OH WI
 15 15 15 15
 Single-sided 3M product with self strip connector.

260430582 CABINET X-CONN SS 900PR DPM 4200E
 N EA 1 3 1
 Cocoa brown.

260326228 CABINET X-CONN SS 900PR DPM 4200EE
 N EA 1 2 1
 Double-sided 3M product with self strip connector.

260326236 CABINET X-CONN SS 900PR DPM 4200F
 N EA 1 2 1
 Single-sided 3M product with self strip connector.

260326244 CABINET X-CONN SS 1200PR DPM 4200EE
 N EA 1 2 1
 Double-sided 3M product with self strip connector.

260430590 CABINET X-CONN SS 1200PR DPM 4200F
 N EA 1 3 1
 Cocoa brown.

PRODUCT IDENTIFIER DESCRIPTION

ITEM NUMBER	ORD. MULT.	SELL UNIT	STD. PKG. STOCK AVAILABILITY / PA	LEAD TIME	MIN. ORD.	A C
-------------	------------	-----------	-----------------------------------	-----------	-----------	-----

260442629 CABINET X-CONN SS 1200PR DPM 4200F
 N EA 1 3 1
 Almond.

260326251 CABINET X-CONN SS 1200PR DPM 4200F
 1945766 1 EA IL IN MI OH WI
 15 15 15 15
 Single-sided 3M product with self strip connector.

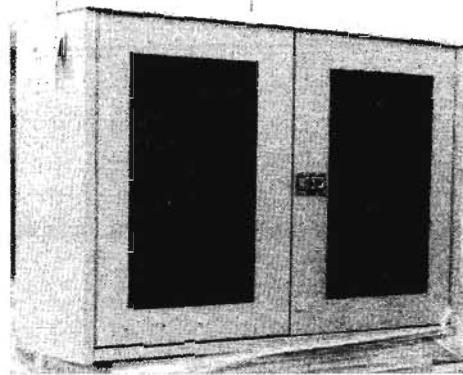

1945766

260326269 CABINET X-CONN SS 1500PR DPM 4200EE
 N EA 1 2 1
 Double-sided 3M product with self strip connector.

260430608 CABINET X-CONN SS 1500PR DPM 4200F
 N EA 1 3 1
 Cocoa brown.

260442637 CABINET X-CONN SS 1500PR DPM 4200F
 N EA 1 3 1
 Almond.

260326277 CABINET X-CONN SS 1500PR DPM 4200F
 1945774 1 EA IL IN MI OH WI
 15 15 15 15
 Single-door 3M product with self strip connector.

260326285 CABINET X-CONN SS 1800PR DPM 4200EE
 N EA 1 2 1
 Double-sided 3M product with self strip connector.

260326293 CABINET X-CONN SS 1800PR DPM 4200F
 1945782 1 EA IL IN MI OH WI
 15 15 15 15
 Single-sided 3M product with self strip connector.

260406335 CABINET X-CONN SS 1800PR DPM 4200F
 N EA 1 3 1
 Cocoa brown.

260442645 CABINET X-CONN SS 1800PR DPM 4200F
 N EA 1 3 1
 Single-sided. Almond.

260326301 CABINET X-CONN SS 1800PR DPM 4200G
 N EA 1 2 1
 Double-sided 3M product with self strip connector.

DISTRIBUTION SERVICES

NETWORK SERVICES

TOOLS

BUILDING JANITORIAL

AUTOMOTIVE

FORMS/OFFICE SUPPLIES

GENERAL

DATA VOICE

CABINET CROSS-CONNECT

PRODUCT IDENTIFIER		DESCRIPTION						
ITEM NUMBER	ORD. MULT.	SELL UNIT	STD. PKG. STOCK AVAILABILITY / PA	LEAD TIME	MIN. ORD.	A	C	
260442710			CABINET X-CONN SS 1800PR DPM 4918					
N		EA	1	3	1			
		Almond.						
260430624			CABINET X-CONN SS 1800PR DPM 4918					
N		EA	1	3	1			
		Cocoa brown.						
260326319			CABINET X-CONN SS 2100PR DPM 4200G					
1945790	1	EA	IL IN MI OH WI 15 15 15 15					
		Double-sided 3M product with self strip connector.						
260430566			CABINET X-CONN SS 2100PR DPM 4200G					
N		EA	1	3	1			
		Cocoa brown.						
260442652			CABINET X-CONN SS 2100PR DPM 4200G					
N		EA	1	3	1			
		Double-sided. Almond.						
260442660			CABINET X-CONN SS 2400PR DPM 4200G					
N		EA	1	3	1			
		Double-sided. Almond.						
260430574			CABINET X-CONN SS 2400PR DPM 4200G					
N		EA	1	3	1			
		Cocoa brown.						
260326327			CABINET X-CONN SS 2400PR DPM 4200G					
1945808	1	EA	IL IN MI OH WI 15 15 15 15					
		Double-sided 3M product with self strip connector.						
260326335			CABINET X-CONN SS 2700PR DPM 4200G					
1945816	1	EA	IL IN MI OH WI 15 15 15 15					
		Double-sided 3M product with self strip connector.						
260430640			CABINET X-CONN SS 2700PR DPM 4200G					
N		EA	1	3	1			
		Cocoa brown.						
260442678			CABINET X-CONN SS 2700PR DPM 4200G					
N		EA	1	3	1			
		Double-sided. Almond.						
260442728			CABINET X-CONN SS 2700PR DPMM 4927					
N		EA	1	3	1			
		Almond.						
260430657			CABINET X-CONN SS 3000PR DPM 4200G					
N		EA	1	3	1			
		Cocoa brown.						
260326343			CABINET X-CONN SS 3000PR DPM 4200G					
1945824	1	EA	IL IN MI OH WI 15 15 15 15					
		Double-sided 3M product with self strip connector.						
260442686			CABINET X-CONN SS 3000PR DPM 4200G					
N		EA	1	3	1			
		Double-sided. Almond.						

PRODUCT IDENTIFIER		DESCRIPTION						
ITEM NUMBER	ORD. MULT.	SELL UNIT	STD. PKG. STOCK AVAILABILITY / PA	LEAD TIME	MIN. ORD.	A	C	
260430665			CABINET X-CONN SS 3300PR DPM 4200G					
N		EA	1	3	1			
		Cocoa brown.						
260442694			CABINET X-CONN SS 3300PR DPM 4200G					
N		EA	1	3	1			
		Double-sided. Almond.						
260326350			CABINET X-CONN SS 3300PR DPM 4200G					
N		EA	1	2	1			
		Double-sided 3M product with self strip connector.						
260442702			CABINET X-CONN SS 3600PR DPM 4200G					
N		EA	1	3	1			
		Double-sided. Almond.						
260326368			CABINET X-CONN SS 3600PR DPM 4200G					
1945832	1	EA	IL IN MI OH WI 15 15 15 15					
		Double-sided 3M product with self strip connector.						
260430616			CABINET X-CONN SS 3600PR DPM 4200G					
N		EA	1	3	1			
		Cocoa brown.						
260442736			CABINET X-CONN SS 5400PR DPM 4200H					
N		EA	1	3	1			
		Almond.						
260430632			CABINET X-CONN SS 5400PR DPM 4200H					
N		EA	1	3	1			
		Cocoa brown.						
260326681			CABINET X-CONNECT POLE 100PR 25FT T					
N		EA	1	4	1			
260330162			CABINET X-CONNECT POLE 100PR 25FT T2					
N		EA	1	4	1			
		Top entry, Two 25ft cable stubs.						
260326814			CABINET X-CONNECT POLE 200PR 15FT B					
N		EA	1	4	1			
260326764			CABINET X-CONNECT POLE 200PR 15FT T					
N		EA	1	4	1			
260326830			CABINET X-CONNECT POLE 200PR 25FT B					
N		EA	1	4	1			
260326780			CABINET X-CONNECT POLE 200PR 25FT T					
N		EA	1	4	1			
260326798			CABINET X-CONNECT POLE 200PR 30FT T					
N		EA	1	4	1			
260326863			CABINET X-CONNECT POLE 300PR 15FT					
N		EA	1	4	1			
260326913			CABINET X-CONNECT POLE 300PR 15FT B					
N		EA	1	4	1			

PRODUCT IDENTIFIER							DESCRIPTION
ITEM NUMBER	ORD. MULT.	SELL UNIT	STD. PKG. STOCK AVAILABILITY / PA	LEAD TIME	MIN. ORD.	A C	
260330212			CABINET X-CONNECT POLE	300PR 25FT B2			
N		EA	1	4	1		Bottom entry, two 25ft cable stubs.
260326889			CABINET X-CONNECT POLE	300PR 25FT T			
N		EA	1	4	1		
260326897			CABINET X-CONNECT POLE	300PR 30FT T			
N		EA	1	4	1		
260326954			CABINET X-CONNECT POLE	400PR 10FT T			
N		EA	1	4	1		
260327010			CABINET X-CONNECT POLE	400PR 15FT B			
N		EA	1	4	1		
260326962			CABINET X-CONNECT POLE	400PR 15FT T			
N		EA	1	4	1		
260327036			CABINET X-CONNECT POLE	400PR 25FT B			
N		EA	1	4	1		
260326988			CABINET X-CONNECT POLE	400PR 25FT T			
N		EA	1	4	1		
260327044			CABINET X-CONNECT POLE	400PR 30FT B			
N		EA	1	4	1		
260326996			CABINET X-CONNECT POLE	400PR 30FT T			
N		EA	1	4	1		
260327119			CABINET X-CONNECT POLE	600PR 15FT B			
N		EA	1	4	1		
260330238			CABINET X-CONNECT POLE	600PR 25FT B2			
N		EA	1	4	1		Bottom entry, two 25ft cable stubs.
260327143			CABINET X-CONNECT POLE	600PR 30FT B			
N		EA	1	4	1		
260327093			CABINET X-CONNECT POLE	600PR 30FT T			
N		EA	1	4	1		
260327218			CABINET X-CONNECT POLE	900PR 15FT B			
N		EA	1	4	1		
260327168			CABINET X-CONNECT POLE	900PR 15FT T			
N		EA	1	5	1		
260327234			CABINET X-CONNECT POLE	900PR 25FT B			
N		EA	1	4	1		
260330253			CABINET X-CONNECT POLE	900PR 25FT T2			
N		EA	1	4	1		Top entry, two 25ft cable stubs.
260327242			CABINET X-CONNECT POLE	900PR 30FT B			
N		EA	1	4	1		
260327192			CABINET X-CONNECT POLE	900PR 30FT T			
N		EA	1	4	1		

PRODUCT IDENTIFIER							DESCRIPTION
ITEM NUMBER	ORD. MULT.	SELL UNIT	STD. PKG. STOCK AVAILABILITY / PA	LEAD TIME	MIN. ORD.	A C	
260327317			CABINET X-CONNECT POLE	1200PR 15FT B			
N		EA	1	4	1		
260327267			CABINET X-CONNECT POLE	1200PR 15FT T			
N		EA	1	5	1		
260330287			CABINET X-CONNECT POLE	1200PR 25FT T2			
N		EA	1	4	1		Top entry, two 25ft cable stubs.
260327341			CABINET X-CONNECT POLE	1200PR 30FT B			
N		EA	1	4	1		
260327291			CABINET X-CONNECT POLE	1200PR 30FT T			
N		EA	1	4	1		
260327366			CABINET X-CONNECT POLE	1500PR 15FT T			
N		EA	1	5	1		
260327432			CABINET X-CONNECT POLE	1500PR 25FT B			
N		EA	1	4	1		
260330329			CABINET X-CONNECT POLE	1500PR 25FT T2			
N		EA	1	4	1		Top entry, two 25ft cable stubs.
260327440			CABINET X-CONNECT POLE	1500PR 30FT B			
N		EA	1	4	1		
260327390			CABINET X-CONNECT POLE	1500PR 30FT T			
N		EA	1	4	1		
260426838			CABINET X-CONNECT POLE	1800PR			
N		EA	1	4	1		40IN x 60IN - FOR SPECIAL APPLICATIONS ONLY.
260327465			CABINET X-CONNECT POLE	1800PR 15FT T			
N		EA	1	5	1		
260327531			CABINET X-CONNECT POLE	1800PR 25FT B			
N		EA	1	4	1		
260330345			CABINET X-CONNECT POLE	1800PR 25FT T2			
N		EA	1	4	1		Top entry, two 25ft cable stubs.
260327549			CABINET X-CONNECT POLE	1800PR 30FT B			
N		EA	1	4	1		
260327499			CABINET X-CONNECT POLE	1800PR 30FT T			
N		EA	1	4	1		
260327648			CABINET X-CONNECT POLE	2700PR 30FT B			
N		EA	1	4	1		
260327598			CABINET X-CONNECT POLE	2700PR 30FT T			
N		EA	1	4	1		

CABLE

260423397 CABLE 003-297250
1976068 1 EA

DISTRIBUTION SERVICES

NETWORK SERVICES

TOOLS

BUILDING JANITORIAL

AUTOMOTIVE

FORMS/OFFICE SUPPLIES

GENERAL

DATA VOICE

DISTRIBUTION SERVICES

NETWORK SERVICES

TOOLS

BUILDING JANITORIAL

AUTOMOTIVE

FORMS/OFFICE SUPPLIES

GENERAL

DATA VOICE

CABLE

PRODUCT IDENTIFIER	DESCRIPTION		MIN.	A		
ITEM NUMBER	ORD. MULT.	SELL UNIT	STD. PKG. STOCK AVAILABILITY / PA	LEAD TIME	MIN. ORD.	A
103728598		CABLE 451R3				
N		FT	10100	2	10100	
103363503		CABLE 606B				
N		FT	3675	1	3675	
260445234		CABLE 606C 6PR 22 GAUGE				
N		FT	1	1	1	
		SEE #106556491 for cost.				
260445267		CABLE 606C 6PR 22 GAUGE 1000FT				
N		FT	1000	1	1000	
		SEE #106556525 for cost.				
260441647		CABLE 606C 6PR 22 GAUGE 150FT				
N		FT	150	1	150	
		1990 UL Listed Cable Required.				
260441654		CABLE 606C 6PR 22 GAUGE 250FT				
N						
		1990 UL Listed cable required.				
260441639		CABLE 606C 6PR 22 GAUGE 30FT				
N						
		1990 UL Listed Cable Required.				
260441662		CABLE 606C 6PR 22 GAUGE 350FT				
N						
103363511		CABLE 607B				
N		FT	2450	2	2450	
260445242		CABLE 607C 12PR 22 GAUGE				
N		FT	1	1	1	
		SEE #106556541 for cost.				
260445259		CABLE 608B 16PR 22 GAUGE				
N		FT	1	1	1	
		SEE #106556780 for cost.				
104304175		CABLE 608C 16PR				
N		FT	3700	2	3700	
103363537		CABLE 609B 25PR CM/310				
N		FT	1633	2	1633	
		1987 UL List material required.				
104304183		CABLE 609C 25PR 22 GAUGE				
N		FT	2950	2	2950	
103363545		CABLE 610B 50PR 22 GAUGE/310				
N		FT	1200	2	1200	
		Copper alvyn sheath used for main frame terminations, BSP 626-200-116.				
103363552		CABLE 611B				
N		FT	515	2	515	
105004915		CABLE 613B NCA-3248-01				
N		FT	1633	2	1633	
105044473		CABLE 613C 30PR				
N		FT	2400	2	2400	

PRODUCT IDENTIFIER	DESCRIPTION		MIN.	A		
ITEM NUMBER	ORD. MULT.	SELL UNIT	STD. PKG. STOCK AVAILABILITY / PA	LEAD TIME	MIN. ORD.	A

105393888		CABLE 761A 600FT REEL 12IN				
5120659	1	FT	IL IN MI OH WI 18 18 18 18			
101307924		CABLE 761A1 600FT REEL				
5120659	1	FT	IL IN MI OH WI 18 18 18 18			
101420586		CABLE 761A2/CM				
N		FT	9000	2	9000	
		1987 UL List material required.				
300080660		CABLE COAXIAL RG62AU AMP				
5125252	1	RL	IL IN MI OH WI 18 18 18 18			
260427885		CABLE HARNESS ALARM FEMALE 10FT				
1977785	1	EA	IL IN MI OH WI			
		003-297810.				
260427877		CABLE HARNESS ALARM MALE 5FT				
1977777	1	EA	IL IN MI OH WI			
		003-500025.				
260427869		CABLE HARNESS POWER FEMALE 10FT				
1977769	1	EA	IL IN MI OH WI 08			
260427851		CABLE HARNESS POWER MALE 5FT				
1977751	1	EA	IL IN MI OH WI 08			
260382205		CABLE NT3E42AA 5M JUMPER				
1961425	1	EA	IL IN MI OH WI 09			
260382197		CABLE NT3E45AA 5M JUMPER				
1961417	1	EA	IL IN MI OH WI 09			
CABLE AIR EQUIPMENT						
SEE PRESSURIZATION AIR CABLE EQUIPMENT						
CABLE CLAMP						
SEE CLAMP CABLE.						
CABLE CLIP						
SEE CLIP CABLE.						
CABLE CONNECTOR						
100959105		CABLE CONNECTOR A 25B 5FT DE				
1180133	1	EA	Double-ended.			
100959113		CABLE CONNECTOR A 25B 5FT SE				
1129932	1	EA	IL IN MI OH WI 18 18 18 18			
		Intended for use with 233A Key telephone units, single-ended, BSP 461-200-101.				

DISTRIBUTION SERVICES

NETWORK SERVICES

TOOLS

BUILDING JANITORIAL

AUTOMOTIVE

FORMS/OFFICE SUPPLIES

GENERAL

DATA VOICE

PRODUCT IDENTIFIER		DESCRIPTION							
ITEM NUMBER	ORD. MULT.	SELL UNIT	STD. PKG.		LEAD TIME		MIN. ORD.	A C	
			STOCK AVAILABILITY / PA						
100959170 CABLE CONNECTOR A 25B 15FT DE									
1161661	1	EA	IL	IN	MI	OH	WI		
			18	18	18	18	18		
Double-ended.									
100959162 CABLE CONNECTOR A 25B 15FT SE									
1147579	1	EA	IL	IN	MI	OH	WI		
			18			18			
Single-ended.									
100016781 CABLE CONNECTOR A 25B 30FT DE									
1171009	1	EA	IL	IN	MI	OH	WI		
			18	18	18	18			
Double-ended.									
100016765 CABLE CONNECTOR A 25B 50FT SE									
1160689	1	EA	IL	IN	MI	OH	WI		
			18	18	18	18	18		
Single-ended.									
100016799 CABLE CONNECTOR A 25B 80FT DE									
1183319	1	EA	IL	IN	MI	OH	WI		
			18	18	18	18			
Double-ended.									
100016807 CABLE CONNECTOR A 25B 100FT DE									
1144709	1	EA	IL	IN	MI	OH	WI		
			18	18	18	18	18		
Double-ended.									
100016773 CABLE CONNECTOR A 25B 100FT SE									
1147512	1	EA	IL	IN	MI	OH	WI		
			18	18	18	18	18		
Single-ended.									
100016815 CABLE CONNECTOR A 25B 200FT DE									
1149435	1	EA	IL	IN	MI	OH	WI		
			18	18	18	18	18		
Double-ended.									
100959477 CABLE CONNECTOR A 25B 200FT SE									
1156216	1	EA	IL	IN	MI	OH	WI		
			18	18	18	18	18		
Single-ended.									
100959899 CABLE CONNECTOR A 25D 5FT SE									
5386185	1	EA	IL	IN	MI	OH	WI		
			18			18			
Single-ended.									
100963990 CABLE CONNECTOR A 25D 15FT DE									
1139816	1	EA	IL	IN	MI	OH	WI		
			18	18	18	18	18		
Double-ended.									
100983899 CABLE CONNECTOR A 25D 20FT									
N		EA	1			1		1	
100959972 CABLE CONNECTOR A 25D 25FT DE									
N		EA	1			1		1	
Double-ended.									
100016872 CABLE CONNECTOR A 25D 25FT SE									
N		EA	1			1		1	
Single-ended.									

PRODUCT IDENTIFIER		DESCRIPTION							
ITEM NUMBER	ORD. MULT.	SELL UNIT	STD. PKG.		LEAD TIME		MIN. ORD.	A C	
			STOCK AVAILABILITY / PA						
100985563 CABLE CONNECTOR A 25D 30FT SE									
N		EA	1			1		1	
Single-ended.									
100959998 CABLE CONNECTOR A 25D 40FT SE									
5383687	1	EA	IL	IN	MI	OH	WI		
			18	18	18	18	18		
Single-ended.									
100985571 CABLE CONNECTOR A 25D 50FT DE									
N		EA	1			1		1	
Double-ended.									
100960004 CABLE CONNECTOR A 25D 50FT SE									
N		EA	1			1		1	
Single-ended.									
100960046 CABLE CONNECTOR A 25D 100FT DE									
N		EA	1			1		1	
Double-ended.									
101129484 CABLE CONNECTOR A 25D 100FT SE									
5116897	1	EA	IL	IN	MI	OH	WI		
			18	18	18	18			
Single-ended.									
100960053 CABLE CONNECTOR A 25D 200FT SE									
5117390	1	EA	IL	IN	MI	OH	WI		
			18	18	18	18			
Single-ended.									
260441621 CABLE CONNECTOR A 25R 30FT SE									
N		EA	1			1		1	
Single ended female connector, tinned conductors. 1990 UL Listed cable only.									
260441613 CABLE CONNECTOR A 25R 45FT SE									
N		EA	1			1		1	
1990 UL Listed cable only, single end female connector, tinned copper conductor.									
100960319 CABLE CONNECTOR A 50B									
N		EA	1			2		1	
100017029 CABLE CONNECTOR A 50B 50FT SE									
1143172	1	EA	IL	IN	MI	OH	WI		
			18	18	18	18	18		
Intended for use with 610 key telephone sets, single-ended, BSP 461-200-101.									
100960434 CABLE CONNECTOR A 50B 100FT DE									
1209999	1	EA	IL	IN	MI	OH	WI		
			18	18	18	18	18		
Double-ended.									
100017037 CABLE CONNECTOR A 50B 100FT SE									
1170779	1	EA	IL	IN	MI	OH	WI		
			18	18	18	18	18		
Single-ended. Intended for use with 635A key telephone sets, BSP 461-200-101.									
100960491 CABLE CONNECTOR A 50B 200FT DE									
1156596	1	EA	IL	IN	MI	OH	WI		
			18	18	18	18	18		
Double-ended.									

DISTRIBUTION SERVICES

NETWORK SERVICES

TOOLS

BUILDING JANITORIAL

AUTOMOTIVE

FORMS/OFFICE SUPPLIES

GENERAL

DATA VOICE

CABLE CONNECTOR

PRODUCT IDENTIFIER		DESCRIPTION						
ITEM NUMBER	ORD. MULT.	SELL UNIT	STD. PKG. STOCK AVAILABILITY / PA	LEAD TIME	MIN. ORD.	A	C	
100960483 CABLE CONNECTOR A 50B 200FT SE								
1199653	1	EA	IL IN MI OH WI 18 18 18 18 18					
Single-ended. Intended for use with 610 key telephone sets. Used with 831 and 2831 telephone sets, BSP 461-200-101.								
100017110 CABLE CONNECTOR A 75A 50FT SE								
1219014	1	EA	IL IN MI OH WI 18 18 18 18 18					
Single-ended.								
100961630 CABLE CONNECTOR A 75A 150FT SE								
N		EA	1	1	1			
Single-ended.								
100961663 CABLE CONNECTOR A 75A 200FT SE								
1198770	1	EA	IL IN MI OH WI 18 18 18 18 18					
Single-ended.								
100961903 CABLE CONNECTOR A100C 100FT DE								
N		EA	1	1	1			
Double-ended.								
100017201 CABLE CONNECTOR A100C 100FT SE								
1164806	1	EA	IL IN MI OH WI 18 18 18 18 18					
Single-ended.								
100961960 CABLE CONNECTOR A100C 200FT DE								
N		EA	1	1	1			
Double-ended.								
100017219 CABLE CONNECTOR A100C 200FT SE								
1174292	1	EA	IL IN MI OH WI 18 18 18 18 18					
Single-ended. Intended for use with 612 and 615 key telephone sets, BSP 461-200-101.								
100017235 CABLE CONNECTOR A100D 100FT SE								
1187211	1	EA	IL IN MI OH WI 18 18 18 18 18					
Single-ended.								
100017276 CABLE CONNECTOR A100D 200FT DE								
1199489	1	EA	IL IN MI OH WI 18 18 18 18 18					
Double-ended.								
100017326 CABLE CONNECTOR B 25A 5FT DE								
1150474	1	EA	IL IN MI OH WI 18 18 18 18 18					
Double-ended.								
101619336 CABLE CONNECTOR B 25A 10FT DE								
1111435	1	EA	IL IN MI OH WI 18 18 18 18 18					
Double-ended.								
100017334 CABLE CONNECTOR B 25A 15FT DE								
1105270	1	EA	IL IN MI OH WI 18 18 18 18 18					
Double-ended.								

PRODUCT IDENTIFIER		DESCRIPTION						
ITEM NUMBER	ORD. MULT.	SELL UNIT	STD. PKG. STOCK AVAILABILITY / PA	LEAD TIME	MIN. ORD.	A	C	

101619450 CABLE CONNECTOR B 25A 20FT DE							
1199109	1	EA	IL IN MI OH WI 18 18 18 18				
Double-ended.							
100017342 CABLE CONNECTOR B 25A 30FT DE							
1123000	1	EA	IL IN MI OH WI 18 18 18 18 18				
Double-ended.							
100961796 CABLE CONNECTOR B 25A 50FT DE							
1184374	1	EA	IL IN MI OH WI 18 18 18 18 18				
Double-ended.							
100017359 CABLE CONNECTOR B 25A 60FT DE							
1166843	1	EA	IL IN MI OH WI 18 18 18 18 18				
Double-ended.							
100017367 CABLE CONNECTOR B 25A 100FT DE							
1192153	1	EA	IL IN MI OH WI 18 18 18 18 18				
Double-ended. For use in moves, extending, or additions in exposed or concealed cabling systems, BSP 461-200-101.							

CABLE COUPLER

SEE COUPLER.

CABLE CROSS-CONNECT

260386537 CABLE CROSS-CONNECT DFX							
N		EA	1	4	1		
C4444A4063-2. Single mode jumper w/AT&T ST Super PC connector on both ends. Length 2 Meters.							
260386545 CABLE CROSS-CONNECT DFX C4444A4063-3							
N		EA	1	4	1		
C4444A4063-3. Single mode jumper w/AT&T ST Super PC connector on both ends. Length 3 Meters.							

CABLE DP11

Cable Assemblies - Single Mode Jumper-Jacketed w/biconic connector on both ends. The last four digits of each description is the jumper length in meters. MICHIGAN ONLY.

260029913 CABLE DP11 AAAAA-AT0001							
1223776	1	EA					
260029921 CABLE DP11 AAAAA-AT0002							
1223784	1	EA	IL IN MI OH WI				
260029947 CABLE DP11 AAAAA-AT0004							
1223842	1	EA	IL IN MI OH WI				
260029954 CABLE DP11 AAAAA-AT0005							
1223883	1	EA	IL IN MI OH WI				

PRODUCT IDENTIFIER		DESCRIPTION					
ITEM NUMBER	ORD. MULT.	SELL UNIT	STD. PKG. STOCK AVAILABILITY / PA	LEAD TIME	MIN. ORD.	A C	
260029962	1	EA	IL IN MI OH WI				
1223909	1	EA	IL IN MI OH WI				
260029970	1	EA	IL IN MI OH WI				
1223917	1	EA	IL IN MI OH WI				
260976337	1	EA	IL IN MI OH WI				
1253179	1	EA	IL IN MI OH WI				
260976345	1	EA	IL IN MI OH WI				
1253187	1	EA	IL IN MI OH WI				
260031117	1	EA	IL IN MI OH WI				
1226936	1	EA	IL IN MI OH WI				
260976352	1	EA	IL IN MI OH WI				
1253195	1	EA	IL IN MI OH WI				
260031125	1	EA	IL IN MI OH WI				
1227009	1	EA	IL IN MI OH WI				
260976402	1	EA	IL IN MI OH WI				
1253252	1	EA	IL IN MI OH WI				
260031133	1	EA	IL IN MI OH WI				
1227033	1	EA	IL IN MI OH WI				
260976360	1	EA	IL IN MI OH WI				
1253211	1	EA	IL IN MI OH WI				
260963897	1	EA	IL IN MI OH WI				
1237685	1	EA	IL IN MI OH WI				
260976378	1	EA	IL IN MI OH WI				
1253229	1	EA	IL IN MI OH WI				
260964507	1	EA	IL IN MI OH WI				
1238519	1	EA	IL IN MI OH WI				
260976386	1	EA	IL IN MI OH WI				
1253237	1	EA	IL IN MI OH WI				
260971551	1	EA	IL IN MI OH WI				
1247585	1	EA	IL IN MI OH WI				
260976394	1	EA	IL IN MI OH WI				
1253245	1	EA	IL IN MI OH WI				
260971684	1	EA	IL IN MI OH WI				
1247759	1	EA	IL IN MI OH WI				

PRODUCT IDENTIFIER		DESCRIPTION					
ITEM NUMBER	ORD. MULT.	SELL UNIT	STD. PKG. STOCK AVAILABILITY / PA	LEAD TIME	MIN. ORD.	A C	
260029988	1	EA	IL IN MI OH WI				
1223958	1	EA	IL IN MI OH WI				
260971494	1	EA	IL IN MI OH WI				
1247528	1	EA	IL IN MI OH WI				
260971502	1	EA	IL IN MI OH WI				
1247536	1	EA	IL IN MI OH WI				
260971510	1	EA	IL IN MI OH WI				
1247544	1	EA	IL IN MI OH WI				
260966049	1	EA	IL IN MI OH WI				
1240838	1	EA	IL IN MI OH WI				
260977350	1	EA	IL IN MI OH WI				
1254334	1	EA	IL IN MI OH WI				
260030002	1	EA	IL IN MI OH WI				
1223974	1	EA	IL IN MI OH WI				
260977368	1	EA	IL IN MI OH WI				
1254342	1	EA	IL IN MI OH WI				
260977376	1	EA	IL IN MI OH WI				
1254359	1	EA	IL IN MI OH WI				
260977178	1	EA	IL IN MI OH WI				
N		EA		3	1		
260030010	1	EA	IL IN MI OH WI				
1223990	1	EA	IL IN MI OH WI				

PRODUCT IDENTIFIER		DESCRIPTION					
ITEM NUMBER	ORD. MULT.	SELL UNIT	STD. PKG. STOCK AVAILABILITY / PA	LEAD TIME	MIN. ORD.	A C	
CABLE EXCHANGE							
103266425				11 PAIR			
5519546	1	FT					
Even Pic Cable, 22 gauge, polyethylene insulated, waterproof, ASP sheath for buried use, BSP 626-200-113.							
103266441				16 PAIR			
5519561	1	FT	IL IN MI OH WI	15 15			
103266466				25 PAIR			
1436444	1	FT	IL IN MI OH WI	15 15 15 15 15			
103266482				50 PAIR			
1436428	1	FT	IL IN MI OH WI	15 15 15 15 15			
103266524				100 PAIR			
1436469	1	FT	IL IN MI OH WI	15 15 15 15 15			

DISTRIBUTION SERVICES
 NETWORK SERVICES
 TOOLS
 BUILDING JANITORIAL
 AUTOMOTIVE
 FORMS/OFFICE SUPPLIES
 GENERAL
 DATA VOICE

DISTRIBUTION SERVICES
 NETWORK SERVICES
 TOOLS
 BUILDING JANITORIAL
 AUTOMOTIVE
 FORMS/OFFICE SUPPLIES
 GENERAL
 DATA VOICE

CABLE EXCHANGE

PRODUCT IDENTIFIER		DESCRIPTION						
ITEM NUMBER	ORD. MULT.	SELL UNIT	STD. PKG. STOCK AVAILABILITY / PA	LEAD TIME	MIN. ORD.	A	C	
103266565			CABLE EXCHANGE AFAW	200 PAIR				
1436485	1	FT	IL IN MI OH WI 15 15 15 15 15					
103266581			CABLE EXCHANGE AFAW	300 PAIR				
1436527	1	FT	IL IN MI OH WI 15 15 15 15 15					
103266607			CABLE EXCHANGE AFAW	400 PAIR				
1436501	1	FT	IL IN MI OH WI 15 15 15 15 15					
103266623			CABLE EXCHANGE AFAW	600 PAIR				
1213645	1	FT	IL IN MI OH WI 15 15 15 15 15					
103266649			CABLE EXCHANGE AFAW	900 PAIR				
1941765	1	FT	IL IN MI OH WI 15 15 15 15 15					
103266664			CABLE EXCHANGE AFAW	1200 PAIR				
1954974	1	FT	IL IN MI OH WI 15 15 15 15 15					
103266680			CABLE EXCHANGE AFBW	6 PAIR				
5519447	1	FT	IL IN MI OH WI 15 15 15 15 15					
19 guage copper.								
103266706			CABLE EXCHANGE AFBW	11 PAIR				
5519462	1	FT	IL IN MI OH WI 15 15 15 15 15					
103266748			CABLE EXCHANGE AFBW	25 PAIR				
1436626	1	FT	IL IN MI OH WI 15 15 15 15 15					
103266763			CABLE EXCHANGE AFBW	50 PAIR				
1436600	1	FT	IL IN MI OH WI 15 15 15 15 15					
103266805			CABLE EXCHANGE AFBW	100 PAIR				
1190264	1	FT	IL IN MI OH WI 15 15 15 15 15					
103266847			CABLE EXCHANGE AFBW	200 PAIR				
1196618	1	FT	IL IN MI OH WI 15 15 15 15 15					
103266888			CABLE EXCHANGE AFMW	25 PAIR				
1436923	1	FT	IL IN MI OH WI 15 15 15 15 15					
24 gauge copper, polyethylene insulated, waterproof, ASP sheath for buried use, BSP 626-200-113.								
103266904			CABLE EXCHANGE AFMW	50 PAIR				
1436782	1	FT	IL IN MI OH WI 15 15 15 15 15					
103266920			CABLE EXCHANGE AFMW	100 PAIR				
1436907	1	FT	IL IN MI OH WI 15 15 15 15 15					
103266946			CABLE EXCHANGE AFMW	200 PAIR				
1436881	1	FT	IL IN MI OH WI 15 15 15 15 15					

PRODUCT IDENTIFIER		DESCRIPTION						
ITEM NUMBER	ORD. MULT.	SELL UNIT	STD. PKG. STOCK AVAILABILITY / PA	LEAD TIME	MIN. ORD.	A	C	
103266961			CABLE EXCHANGE AFMW	300 PAIR				
1436865	1	FT	IL IN MI OH WI 15 15 15 15 15					
103266987			CABLE EXCHANGE AFMW	400 PAIR				
1436840	1	FT	IL IN MI OH WI 15 15 15 15 15					
103267001			CABLE EXCHANGE AFMW	600 PAIR				
1436824	1	FT	IL IN MI OH WI 15 15 15 15 15					
103267027			CABLE EXCHANGE AFMW	900 PAIR				
1436808	1	FT	IL IN MI OH WI 15 15 15 15 15					
103267043			CABLE EXCHANGE AFMW	1200 PAIR				
1941773	1	FT	IL IN MI OH WI 15 15 15 15 15					
103267068			CABLE EXCHANGE AFMW	1500 PAIR				
1954966	1	FT	IL IN MI OH WI 15 15 15 15 15					
103267084			CABLE EXCHANGE AFMW	1800 PAIR				
1957522	1	FT	IL IN MI OH WI 15 15 15 15 15					
260319926			CABLE EXCHANGE AFMY	900 PAIR				
1941781	1	FT	IL IN MI OH WI 15 15 15 15 15					
Filled Pic cable with bonded ASP sheath 24 guage.								
103267092			CABLE EXCHANGE AFTW	25 PAIR				
1437301	1	FT	IL IN MI OH WI 15 15 15 15 15					
26 Gauge copper, polyethylene insulated, waterproof, ASP sheath for buried use, BSP 626-200-113.								
103267118			CABLE EXCHANGE AFTW	50 PAIR				
1437269	1	FT	IL IN MI OH WI 15 15 15 15 15					
103267134			CABLE EXCHANGE AFTW	100 PAIR				
1437228	1	FT	IL IN MI OH WI 15 15 15 15 15					
103267159			CABLE EXCHANGE AFTW	200 PAIR				
1437186	1	FT	IL IN MI OH WI 15 15 15 15 15					
103267175			CABLE EXCHANGE AFTW	300 PAIR				
1437145	1	FT	IL IN MI OH WI 15 15 15 15 15					
103267191			CABLE EXCHANGE AFTW	400 PAIR				
1437103	1	FT	IL IN MI OH WI 15 15 15 15 15					
103267217			CABLE EXCHANGE AFTW	600 PAIR				
1437087	1	FT	IL IN MI OH WI 15 15 15 15 15					

PRODUCT IDENTIFIER		DESCRIPTION					
ITEM NUMBER	ORD. MULT.	SELL UNIT	STD. PKG. STOCK AVAILABILITY / PA	LEAD TIME	MIN. ORD.	A C	
103267233		CABLE EXCHANGE AFTW	900 PAIR				
1437061	1	FT	IL IN MI OH WI 15 15 15 15 15				
103382156		CABLE EXCHANGE AFTW	1200 PAIR				
1941799	1	FT	IL IN MI OH WI 15 15 15 15 15				
103382172		CABLE EXCHANGE AFTW	1500 PAIR				
1954958	1	FT	IL IN MI OH WI 15 15 15 15 15				
103382198		CABLE EXCHANGE AFTW	1800 PAIR				
1941807	1	FT	IL IN MI OH WI 15 15 15 15 15				
401757893		CABLE EXCHANGE AJAA	6 PAIR				
1228353	1	FT	IL IN MI OH WI 15 15				
103562609		CABLE EXCHANGE ARMM	100 PAIR				
4200410	1	FT	IL IN MI OH WI 15 15 15 15 15				
103562625		CABLE EXCHANGE ARMM	200 PAIR				
1135129	1	FT	IL IN MI OH WI 15 15 15 15 15				
103562641		CABLE EXCHANGE ARMM	400 PAIR				
4200436	1	FT	IL IN MI OH WI 15 15 15 15 15				
103562658		CABLE EXCHANGE ARMM	600 PAIR				
4200428	1	FT	IL IN MI OH WI 15 15 15 15 15				
103562690		CABLE EXCHANGE ARTM	300 PAIR				
5521781	1	FT	IL IN MI OH WI 15 15 15 15 15				
		Building Riser Cable, PVC insulation, 26 Gauge, ALVYN sheath, BSP 626-107-006.					
103562708		CABLE EXCHANGE ARTM	400 PAIR				
5521807	1	FT	IL IN MI OH WI 15 15 15 15 15				
		Per FPQ83282.					
103562716		CABLE EXCHANGE ARTM	600 PAIR				
5521823	1	FT	IL IN MI OH WI 15 15 15 15 15				
103562724		CABLE EXCHANGE ARTM	900 PAIR				
5218495	1	FT	IL IN MI OH WI 15 15 15 15 15				
100021146		CABLE EXCHANGE BHAA	25 PAIR				
2672626	1	FT	IL IN MI OH WI 15 15 15 15 15				
		PIC, air core, solid Polyethylene, 22 gauge, alpeh sheath, BSP 626-101-005.					
100021179		CABLE EXCHANGE BHAA	50 PAIR				
2672642	1	FT	IL IN MI OH WI 15 15 15 15 15				

PRODUCT IDENTIFIER		DESCRIPTION					
ITEM NUMBER	ORD. MULT.	SELL UNIT	STD. PKG. STOCK AVAILABILITY / PA	LEAD TIME	MIN. ORD.	A C	
100021237		CABLE EXCHANGE BHAA	100 PAIR				
2672667	1	FT	IL IN MI OH WI 15 15 15 15 15				
100021294		CABLE EXCHANGE BHAA	200 PAIR				
2672683	1	FT	IL IN MI OH WI 15 15 15 15 15				
100021328		CABLE EXCHANGE BHAA	300 PAIR				
2672709	1	FT	IL IN MI OH WI 15 15 15 15 15				
100021351		CABLE EXCHANGE BHAA	400 PAIR				
2672725	1	FT	IL IN MI OH WI 15 15 15 15 15				
100021385		CABLE EXCHANGE BHAA	600 PAIR				
2672741	1	FT	IL IN MI OH WI 15 15 15 15 15				
103711339		CABLE EXCHANGE BHAA	900 PAIR				
1302448	1	FT	IL IN MI OH WI 15 15 15 15 15				
102614393		CABLE EXCHANGE BHAAUM	300 PR				
1971457	1	FT	IL IN MI OH WI 15 15 15 15				
		Provides mechanical protection against rodent damage.					
100021856		CABLE EXCHANGE BHAH	25 PAIR				
5520502	1	FT	IL IN MI OH WI 15 15 15 15 15				
100021872		CABLE EXCHANGE BHAH	50 PAIR				
1302513	1	FT	IL IN MI OH WI 15 15 15 15 15				
100021914		CABLE EXCHANGE BHAH	100 PAIR				
1302539	1	FT	IL IN MI OH WI 15 15 15 15 15				
100021955		CABLE EXCHANGE BHAH	200 PAIR				
1302547	1	FT	IL IN MI OH WI 15 15 15 15 15				
100021971		CABLE EXCHANGE BHAH	300 PAIR				
4435024	1	FT	IL IN MI OH WI 15 15 15 15 15				
100021997		CABLE EXCHANGE BHAH	400 PAIR				
1302554	1	FT	IL IN MI OH WI 15 15 15 15 15				
100022011		CABLE EXCHANGE BHAH	600 PAIR				
1302562	1	FT	IL IN MI OH WI 15 15 15 15 15				
103711321		CABLE EXCHANGE BHAH	900 PAIR				
1302570	1	FT	IL IN MI OH WI 15 15 15 15 15				

DISTRIBUTION SERVICES

NETWORK SERVICES

TOOLS

BUILDING JANITORIAL

AUTOMOTIVE

FORMS/OFFICE SUPPLIES

GENERAL

DATA VOICE

CABLE EXCHANGE

DISTRIBUTION SERVICES

NETWORK SERVICES

TOOLS

BUILDING JANITORIAL

AUTOMOTIVE

FORMS/OFFICE SUPPLIES

GENERAL

DATA VOICE

PRODUCT IDENTIFIER		DESCRIPTION						
ITEM NUMBER	ORD. MULT.	SELL UNIT	STD. PKG. STOCK AVAILABILITY / PA	LEAD TIME			MIN. ORD.	A C
100022045 CABLE EXCHANGE BHAS		25 PAIR						
1120527	1	FT	IL IN MI OH WI 15 15 15 15 15					
22 gauge copper, polyethylene insulated, alpeh sheath for aerial use, self supporting, F.R. - 4250ft, BSP 626-200-130.								
100022052 CABLE EXCHANGE BHAS		50 PAIR						
1120501	1	FT	IL IN MI OH WI 15 15 15 15 15					
101452084 CABLE EXCHANGE BHAS		100 PAIR						
1147371	1	FT	IL IN MI OH WI 15 15 15 15 15					
100022821 CABLE EXCHANGE BHBH		25 PAIR						
5520445	1	FT	IL IN MI OH WI 15 15 15 15 15					
100022847 CABLE EXCHANGE BHBH		50 PAIR						
5520460	1	FT	IL IN MI OH WI 15 15 15 15 15					
100022888 CABLE EXCHANGE BHBH		100 PAIR						
5520486	1	FT	IL IN MI OH WI 15 15 15 15 15					
100023043 CABLE EXCHANGE BKMA		25 PAIR						
1120980	1	FT	IL IN MI OH WI 15 15 15 15 15					
24 gauge copper, polyethylene insulated, alpeh sheath for aerial use. Binders and pairs are full color, BSP 626-200-112.								
100023076 CABLE EXCHANGE BKMA		50 PAIR						
1121004	1	FT	IL IN MI OH WI 15 15 15 15 15					
100023134 CABLE EXCHANGE BKMA		100 PAIR						
1121046	1	FT	IL IN MI OH WI 15 15 15 15 15					
100023191 CABLE EXCHANGE BKMA		200 PAIR						
2672808	1	FT	IL IN MI OH WI 15 15 15 15 15					
100023225 CABLE EXCHANGE BKMA		300 PAIR						
2672782	1	FT	IL IN MI OH WI 15 15 15 15 15					
100023258 CABLE EXCHANGE BKMA		400 PAIR						
2672824	1	FT	IL IN MI OH WI 15 15 15 15 15					
100023282 CABLE EXCHANGE BKMA		600 PAIR						
2672840	1	FT	IL IN MI OH WI 15 15 15 15 15					
100023316 CABLE EXCHANGE BKMA		900 PAIR						
2672865	1	FT	IL IN MI OH WI 15 15 15 15 15					
103711313 CABLE EXCHANGE BKMA		1200 PAIR						
1302455	1	FT	IL IN MI OH WI 15 15 15 15 15					

PRODUCT IDENTIFIER		DESCRIPTION						
ITEM NUMBER	ORD. MULT.	SELL UNIT	STD. PKG. STOCK AVAILABILITY / PA	LEAD TIME			MIN. ORD.	A C
103711305 CABLE EXCHANGE BKMA		1500 PAIR						
1302463	1	FT	IL IN MI OH WI 15 15 15 15 15					
103711297 CABLE EXCHANGE BKMA		1800 PAIR						
1302471	1	FT	IL IN MI OH WI 15 15 15 15 15					
102613478 CABLE EXCHANGE BKMAUM		300 PAIR						
1971465	1	FT	IL IN MI OH WI 15 15 15 15 15					
Provides mechanical protection against rodent damage.								
102613486 CABLE EXCHANGE BKMAUM		400 PAIR						
1971473	1	FT	IL IN MI OH WI 15 15 15 15 15					
Provides mechanical protection against rodent damage.								
102612553 CABLE EXCHANGE BKMAUM		600 PAIR						
1971481	1	FT	IL IN MI OH WI 15 15 15 15 15					
Provides mechanical protection against rodent damage.								
102612561 CABLE EXCHANGE BKMAUM		900 PAIR						
1971499	1	FT	IL IN MI OH WI 15 15 15 15 15					
Provides mechanical protection against rodent damage.								
100023746 CABLE EXCHANGE BKMH		25 PAIR						
1148692	1	FT	IL IN MI OH WI 15 15 15 15 15					
100023761 CABLE EXCHANGE BKMH		50 PAIR						
1302588	1	FT	IL IN MI OH WI 15 15 15 15 15					
100023803 CABLE EXCHANGE BKMH		100 PAIR						
1302596	1	FT	IL IN MI OH WI 15 15 15 15 15					
100023845 CABLE EXCHANGE BKMH		200 PAIR						
1302604	1	FT	IL IN MI OH WI 15 15 15 15 15					
100023860 CABLE EXCHANGE BKMH		300 PAIR						
1302612	1	FT	IL IN MI OH WI 15 15 15 15 15					
100023886 CABLE EXCHANGE BKMH		400 PAIR						
1302638	1	FT	IL IN MI OH WI 15 15 15 15 15					
100023902 CABLE EXCHANGE BKMH		600 PAIR						
1302646	1	FT	IL IN MI OH WI 15 15 15 15 15					
100023928 CABLE EXCHANGE BKMH		900 PAIR						
1302653	1	FT	IL IN MI OH WI 15 15 15 15 15					
103711289 CABLE EXCHANGE BKMH		1200 PAIR						
1302661	1	FT	IL IN MI OH WI 15 15 15 15 15					

PRODUCT IDENTIFIER		DESCRIPTION					
ITEM NUMBER	ORD. MULT.	SELL UNIT	STD. PKG. STOCK AVAILABILITY / PA	LEAD TIME	MIN. ORD.	A	C
103711271			CABLE EXCHANGE BKMH	1500 PAIR			
1302679	1	FT	IL IN MI OH WI 15 15 15 15 15				
102857174			CABLE EXCHANGE BKMP	25 PAIR			
1442145	1	FT	IL IN MI OH WI 15 15 15 15 15				
Solid PIC, 24 gauge, reinforced self-supporting sheath, non-screened, exchange cable, BSP 626-101-005.							
102857182			CABLE EXCHANGE BKMP	50 PAIR			
1305128	1	FT	IL IN MI OH WI 15 15 15 15 15				
102857208			CABLE EXCHANGE BKMP	100 PAIR			
1442186	1	FT	IL IN MI OH WI 15 15 15 15 15				
102857224			CABLE EXCHANGE BKMP	200 PAIR			
1305912	1	FT	IL IN MI OH WI 15 15 15 15 15				
100023944			CABLE EXCHANGE BKMS	25 PAIR			
1121368	1	FT	IL IN MI OH WI 15 15 15 15 15				
24 gauge copper, polyethylene insulated, alpeth sheath for aerial use, self supporting, F.R. 4260ft, BSP 626-200-130.							
100023951			CABLE EXCHANGE BKMS	50 PAIR			
1121343	1	FT	IL IN MI OH WI 15 15 15 15 15				
101452100			CABLE EXCHANGE BKMS	100 PAIR			
1121442	1	FT	IL IN MI OH WI 15 15 15 15 15				
101452126			CABLE EXCHANGE BKMS	200 PAIR			
1121426	1	FT	IL IN MI OH WI 15 15 15 15 15				
100024025			CABLE EXCHANGE BKTA	25 PAIR			
2672881	1	FT	IL IN MI OH WI 15 15 15 15 15				
100024058			CABLE EXCHANGE BKTA	50 PAIR			
2673020	1	FT	IL IN MI OH WI 15 15 15 15 15				
100024116			CABLE EXCHANGE BKTA	100 PAIR			
2673004	1	FT	IL IN MI OH WI 15 15 15 15 15				
100024173			CABLE EXCHANGE BKTA	200 PAIR			
2672980	1	FT	IL IN MI OH WI 15 15 15 15 15				
100024207			CABLE EXCHANGE BKTA	300 PAIR			
2672964	1	FT	IL IN MI OH WI 15 15 15 15 15				
100024231			CABLE EXCHANGE BKTA	400 PAIR			
2672949	1	FT	IL IN MI OH WI 15 15 15 15 15				

PRODUCT IDENTIFIER		DESCRIPTION					
ITEM NUMBER	ORD. MULT.	SELL UNIT	STD. PKG. STOCK AVAILABILITY / PA	LEAD TIME	MIN. ORD.	A	C
100024264			CABLE EXCHANGE BKTA	600 PAIR			
2672923	1	FT	IL IN MI OH WI 15 15 15 15 15				
100024298			CABLE EXCHANGE BKTA	900 PAIR			
2672907	1	FT	IL IN MI OH WI 15 15 15 15 15				
103711248			CABLE EXCHANGE BKTA	1200 PAIR			
1302489	1	FT	IL IN MI OH WI 15 15 15 15 15				
103711255			CABLE EXCHANGE BKTA	1500 PAIR			
1302497	1	FT	IL IN MI OH WI 15 15 15 15 15				
102314564			CABLE EXCHANGE BKTAUM	400 PAIR			
1971507	1	FT	IL IN MI OH WI 15 15 15 15 15				
Provides mechanical protection against rodent damage.							
102612827			CABLE EXCHANGE BKTAUM	600 PAIR			
1971515	1	FT	IL IN MI OH WI 15 15 15 15 15				
Provides mechanical protection against rodent damage.							
102612835			CABLE EXCHANGE BKTAUM	900 PAIR			
1971523	1	FT	IL IN MI OH WI 15 15 15 15 15				
Provides mechanical protection against rodent damage.							
100024728			CABLE EXCHANGE BKTH	25 PAIR			
8410613	1	FT	IL IN MI OH WI 15 15 15 15 15				
100024744			CABLE EXCHANGE BKTH	50 PAIR			
1302687	1	FT	IL IN MI OH WI 15 15 15 15 15				
100024785			CABLE EXCHANGE BKTH	100 PAIR			
1302695	1	FT	IL IN MI OH WI 15 15 15 15 15				
100024827			CABLE EXCHANGE BKTH	200 PAIR			
1302703	1	FT	IL IN MI OH WI 15 15 15 15 15				
100024843			CABLE EXCHANGE BKTH	300 PAIR			
1179432	1	FT	IL IN MI OH WI 15 15 15 15 15				
100024868			CABLE EXCHANGE BKTH	400 PAIR			
1302711	1	FT	IL IN MI OH WI 15 15 15 15 15				
100024884			CABLE EXCHANGE BKTH	600 PAIR			
1302729	1	FT	IL IN MI OH WI 15 15 15 15 15				
100024900			CABLE EXCHANGE BKTH	900 PAIR			
1302737	1	FT	IL IN MI OH WI 15 15 15 15 15				

DISTRIBUTION SERVICES

NETWORK SERVICES

TOOLS

BUILDING JANITORIAL

AUTOMOTIVE

FORMS/OFFICE SUPPLIES

GENERAL

DATA VOICE

DISTRIBUTION SERVICES

NETWORK SERVICES

TOOLS

BUILDING JANITORIAL

AUTOMOTIVE

FORMS/OFFICE SUPPLIES

GENERAL

DATA VOICE

CABLE EXCHANGE

PRODUCT IDENTIFIER		DESCRIPTION						
ITEM NUMBER	ORD. MULT.	SELL UNIT	STD. PKG. STOCK	LEAD TIME AVAILABILITY	MIN. ORD.	A	C	
103711388		CABLE EXCHANGE BKTH	1200 PAIR					
1302745	1	FT	IL IN MI OH WI	15 15 15 15 15				
103711370		CABLE EXCHANGE BKTH	1500 PAIR					
1302752	1	FT	IL IN MI OH WI	15 15 15 15 15				
102857232		CABLE EXCHANGE BKTP	25 PAIR					
1442129	1	FT	IL IN MI OH WI	15 15 15 15 15				
Solid PIC, 26 gauge, reinforced self-supporting sheath, non-screened, exchange cable, BSP 626-101-005.								
102857240		CABLE EXCHANGE BKTP	50 PAIR					
1442103	1	FT	IL IN MI OH WI	15 15 15 15 15				
102857257		CABLE EXCHANGE BKTP	100 PAIR					
1442087	1	FT	IL IN MI OH WI	15 15 15 15 15				
102857273		CABLE EXCHANGE BKTP	200 PAIR					
1442046	1	FT	IL IN MI OH WI	15 15 15 15 15				
102857281		CABLE EXCHANGE BKTP	300 PAIR					
1442020	1	FT	IL IN MI OH WI	15 15 15 15 15				
101452134		CABLE EXCHANGE BKTS	25 PAIR					
1121889	1	FT	IL IN MI OH WI	15 15 15 15 15				
26 gauge copper, polyethylene insulated, alpeh sheath for aerial use, self supporting, F.R. 4850ft, BSP 626-200-130.								
100024926		CABLE EXCHANGE BKTS	50 PAIR					
1121822	1	FT	IL IN MI OH WI	15 15 15 15 15				
100024934		CABLE EXCHANGE BKTS	100 PAIR					
1121848	1	FT	IL IN MI OH WI	15 15 15 15 15				
101452168		CABLE EXCHANGE BKTS	450 PAIR					
7462408	1	FT	IL IN MI OH WI	15 15 15 15 15				
101452167		CABLE EXCHANGE BKTS	200 PAIR					
1121921	1	FT	IL IN MI OH WI	15 15 15 15 15				
101452175		CABLE EXCHANGE BKTS	300 PAIR					
1121947	1	FT	IL IN MI OH WI	15 15 15 15 15				
103715736		CABLE EXCHANGE CDAZ	600 PAIR W/GAS					
1109314	1	FT	IL IN MI OH WI	15 15 15 15 15				
Stalpeth.								
103715744		CABLE EXCHANGE CDAZ	900 PAIR					
1954941	1	FT	IL IN MI OH WI	15 15 15 15 15				

PRODUCT IDENTIFIER		DESCRIPTION						
ITEM NUMBER	ORD. MULT.	SELL UNIT	STD. PKG. STOCK	LEAD TIME AVAILABILITY	MIN. ORD.	A	C	
103175576		CABLE EXCHANGE CDAZ	1200 PAIR W/GAS					
1221275	1	FT	IL IN MI OH WI	15 15 15 15 15				
Stalpeth.								
102309622		CABLE EXCHANGE CDMC	900 PAIR W/GAS					
1221895	1	FT	IL IN MI OH WI	15 15 15 15 15				
102738481		CABLE EXCHANGE CDMC	1200 PAIR W/GAS					
1187310	1	FT	IL IN MI OH WI	15 15 15 15 15				
102738499		CABLE EXCHANGE CDMC	1500 PAIR W/GAS					
4266429	1	FT	IL IN MI OH WI	15 15 15 15 15				
102738507		CABLE EXCHANGE CDMC	1800 PAIR W/GAS					
4266403	1	FT	IL IN MI OH WI	15 15 15 15 15				
103889598		CABLE EXCHANGE CDMZ	300 PAIR W/GAS					
1150102	1	FT	IL IN MI OH WI	15 15 15 15 15				
Bonded stalpeth.								
103889614		CABLE EXCHANGE CDMZ	600 PAIR W/GAS					
1220335	1	FT	IL IN MI OH WI	15 15 15 15 15				
Bonded stalpeth.								
103715769		CABLE EXCHANGE CDMZ	900 PAIR W/GAS					
1164376	1	FT	IL IN MI OH WI	15 15 15 15 15				
Bonded stalpeth.								
103715777		CABLE EXCHANGE CDMZ	1200 PAIR W/GAS					
5102574	1	FT	IL IN MI OH WI	15 15 15 15 15				
Bonded stalpeth.								
103715785		CABLE EXCHANGE CDMZ	1500 PAIR W/GAS					
1925248	1	FT	IL IN MI OH WI	15 15 15 15 15				
Bonded stalpeth.								
103715793		CABLE EXCHANGE CDMZ	1800 PAIR					
1130443	1	FT	IL IN MI OH WI	15 15 15 15 15				
With gas, bonded stalpeth.								
103175543		CABLE EXCHANGE CDMZ	2100 PAIR W/GAS					
1941815	1	FT	IL IN MI OH WI	15 15 15 15 15				
Bonded stalpeth.								
103889648		CABLE EXCHANGE CDTZ	600 PAIR W/GAS					
1941823	1	FT	IL IN MI OH WI	15 15 15 15 15				
103889655		CABLE EXCHANGE CDTZ	900 PAIR W/GAS					
1941831	1	FT	IL IN MI OH WI	15 15 15 15 15				
103737631		CABLE EXCHANGE CDTZ	1200 PAIR					
1957480	1	FT	IL IN MI OH WI	15 15 15 15 15				

PRODUCT IDENTIFIER		DESCRIPTION						
ITEM NUMBER	ORD. MULT.	SELL UNIT	STD. PKG. STOCK AVAILABILITY / PA	LEAD TIME	MIN. ORD.	A	C	
103715793	1	FT	IL IN MI OH WI 15 15 15 15 15	1500 PAIR				
1954933	1	FT	IL IN MI OH WI 15 15 15 15 15	1500 PAIR				
103715801	1	FT	IL IN MI OH WI 15 15 15 15 15	1800 PAIR W/GAS				
1941849	1	FT	IL IN MI OH WI 15 15 15 15 15	1800 PAIR W/GAS				
103715819	1	FT	IL IN MI OH WI 15 15 15 15 15	2100 PAIR				
1957514	1	FT	IL IN MI OH WI 15 15 15 15 15	2100 PAIR				
103715827	1	FT	IL IN MI OH WI 15 15 15 15 15	2400 PAIR				
1957506	1	FT	IL IN MI OH WI 15 15 15 15 15	2400 PAIR				
103379343	1	FT	IL IN MI OH WI 15 15 15 15 15	2700 PAIR				
1159061	1	FT	IL IN MI OH WI 15 15 15 15 15	2700 PAIR				
With gas.								
103357893	1	FT	IL IN MI OH WI 15 15 15 15 15	25 PAIR				
1945733	1	FT	IL IN MI OH WI 15 15 15 15 15	25 PAIR				
DISCONTINUE, ORDER NON STOCK UPON STOCK DEPLETION								
260388582		FT	IL IN MI OH WI 15 15 15 15 15	1200 PAIR				
1964205		FT	IL IN MI OH WI 15 15 15 15 15	1200 PAIR				
103716692	1	FT	IL IN MI OH WI 15 15 15 15 15	1500 PAIR				
1964213	1	FT	IL IN MI OH WI 15 15 15 15 15	1500 PAIR				
103175147	1	FT	IL IN MI OH WI 15 15 15 15 15	1200 PAIR				
1964221	1	FT	IL IN MI OH WI 15 15 15 15 15	1200 PAIR				
103175154	1	FT	IL IN MI OH WI 15 15 15 15 15	1800 PAIR				
1964239	1	FT	IL IN MI OH WI 15 15 15 15 15	1800 PAIR				
103175162	1	FT	IL IN MI OH WI 15 15 15 15 15	2400 PAIR				
1964247	1	FT	IL IN MI OH WI 15 15 15 15 15	2400 PAIR				
103175170	1	FT	IL IN MI OH WI 15 15 15 15 15	3000 PAIR				
1964254	1	FT	IL IN MI OH WI 15 15 15 15 15	3000 PAIR				
103886941	1	FT	IL IN MI OH WI 15 15 15 15 15	1500 PAIR				
1955724	1	FT	IL IN MI OH WI 15 15 15 15 15	1500 PAIR				
To order as stock from the RDC, for an emergency, contact your local Cable Manager.								
260369038	1	FT	IL IN MI OH WI 15 15 15 15 15	2700 PAIR				
1955716	1	FT	IL IN MI OH WI 15 15 15 15 15	2700 PAIR				
To order as stock from the RDC, for an emergency, contact your local Cable Manager.								
260433776				28 PAIR				
N								

PRODUCT IDENTIFIER		DESCRIPTION						
ITEM NUMBER	ORD. MULT.	SELL UNIT	STD. PKG. STOCK AVAILABILITY / PA	LEAD TIME	MIN. ORD.	A	C	
103342184				54 PAIR				
1941856	1	FT	IL IN MI OH WI 15 15 15 15 15	54 PAIR				
Screened depic copper filled, core ASP, 22 guage.								
103342192	1	FT	IL IN MI OH WI 15 15 15 15 15	106 PAIR				
1954925	1	FT	IL IN MI OH WI 15 15 15 15 15	106 PAIR				
103342218	1	FT	IL IN MI OH WI 15 15 15 15 15	210 PAIR				
1957498	1	FT	IL IN MI OH WI 15 15 15 15 15	210 PAIR				
103262648	1	FT	IL IN MI OH WI 15 15 15 15 15	600 PAIR				
1194209	1	FT	IL IN MI OH WI 15 15 15 15 15	600 PAIR				
CABLE GUARD								
SEE GUARD CABLE.								
CABLE HOOK								
SEE HOOK CABLE.								
CABLE INTERCONNECT								
845627975				17F 10A ST FAN				
N		EA	1	13		1		
845627983				17F 10B ST FAN				
N		EA	1	4		1		
105113161				F86AK8500 FA1P				
N		EA	1	6		1		
104271457				F-61980 75FT				
N		EA	1	6		1		
104271481				F-61980 200FT				
N		EA	1	6		1		
180000002				LA1A-A				
N		EA	1	4		1		
104085485				LA1A-A 20FT				
N		EA	1	4		1		
104228044				LA1A-A 25FT				
N		EA	1	4		1		
180000010				LA1A-F				
N		EA	1	4		1		
180000028				LA1E-F				
N		EA	1	4		1		
180008310				LA2A-A				
N		EA	1	4		1		
180009177				LA4A-A				
N		EA	1	4		1		

DISTRIBUTION SERVICES

NETWORK SERVICES

TOOLS

BUILDING JANITORIAL

AUTOMOTIVE

FORMS/OFFICE SUPPLIES

GENERAL

DATA VOICE

CABLE INTERCONNECT

DISTRIBUTION SERVICES

NETWORK SERVICES

TOOLS

BUILDING JANITORIAL

AUTOMOTIVE

FORMS/OFFICE SUPPLIES

GENERAL

DATA VOICE

PRODUCT IDENTIFIER		DESCRIPTION				
ITEM NUMBER	ORD. MULT.	SELL UNIT	STD. PKG. STOCK AVAILABILITY / PA	LEAD TIME	MIN. ORD.	A C
180000069			CABLE INTERCONNECT LB1B-B			
N		EA	1	4	1	
180008336			CABLE INTERCONNECT LB1L-L			
N		EA	1	4	1	
180008104			CABLE INTERCONNECT LB2B-B			
N		EA	1	4	1	
180008385			CABLE INTERCONNECT LIGHTGUIDE			
N		EA	1	4	1	
			Equipped with 1861A.			
180008435			CABLE INTERCONNECT LIGHTGUIDE			
N		EA	1	4	1	
			MM 50 Micron.			
180008187			CABLE INTERCONNECT LIGHTGUIDE			
N		EA	1	4	1	
			Equipped with 1862A.			
180008146			CABLE INTERCONNECT LL1A-A			
N		EA	1	4	1	
104274022			CABLE INTERCONNECT LL1A-A	2FT		
N		EA	1	2	1	
104274030			CABLE INTERCONNECT LL1A-A	4FT		
N		EA	1	2	1	
180008377			CABLE INTERCONNECT LL1A-B			
N		EA	1	4	1	
104274048			CABLE INTERCONNECT LL1A-B	2FT		
N		EA	1	2	1	
844590091			CABLE INTERCONNECT LL1A-F	4FT		
N		EA	1	4	1	
180008302			CABLE INTERCONNECT LL2A-A			
N		EA	1	4	1	
180008393			CABLE INTERCONNECT LL2A-B			
N		EA	1	4	1	
104273750			CABLE INTERCONNECT LL2A-B	10FT		
N		EA	1	2	1	
180008443			CABLE INTERCONNECT LL2B-B			
N		EA	1	4	1	
104278593			CABLE INTERCONNECT LL2B-B	25FT		
N		EA	1	14	1	
104278601			CABLE INTERCONNECT LL2B-B	30FT		
N		EA	1	14	1	
104149216			CABLE INTERCONNECT LS1A-A	5FT		
N		EA	1	2	1	
105055073			CABLE INTERCONNECT LS1A-H1	10FT		
N		EA	1	1	1	
			AV1 4th.			

PRODUCT IDENTIFIER		DESCRIPTION				
ITEM NUMBER	ORD. MULT.	SELL UNIT	STD. PKG. STOCK AVAILABILITY / PA	LEAD TIME	MIN. ORD.	A C
105210470			CABLE INTERCONNECT LS1A-H1	20FT		
N		EA	1	2	1	
105055131			CABLE INTERCONNECT LS1A-H2	10FT		
N		EA	1	2	1	
			AV1 4th.			
180008401			CABLE INTERCONNECT LS1T-N			
N		EA	1	4	1	
180008120			CABLE INTERCONNECT LT1A-A			
N		EA	1	4	1	

CABLE PLENUM

260428792			CABLE PLENUM	4 PAIR 24 GAUGE		
1978148			1000 FT			
			1990 UL Listed Material.			
300007085			CABLE PLENUM	4 PAIR 24 GAUGE		
1179614			1000 FT	IL IN MI OH WI		
			402458863.	18 18 18 18 18		
260428800			CABLE PLENUM	6 PAIR 24 GAUGE		
1978130			1000 FT	IL IN MI OH WI		
			1990 UL Listed Rated CMP	18 18 18 18 18		
402458671			CABLE PLENUM	6 PAIR 24 GAUGE		
1926899			1000 FT	IL IN MI OH WI		
			CK22084 L 3.	18 18 18 18 18		
260375860			CABLE PLENUM	6 PAIR SHIELDED QCK PK		
1957720			1000 BX	IL IN MI OH WI		
				18		
260424023			CABLE PLENUM	12 PAIR 24 GAUGE		
			NONSHIELD			
N			FT	100	1	100
002079879			CABLE PLENUM	25 PAIR 24 GAUGE		
			NONSHIELD			
1201871			1 FT	IL IN MI OH WI		
				08 08 08 08 08		
260424015			CABLE PLENUM	50 PAIR 24 GAUGE		
			NONSHIELD			
N			FT	100	1	100
260424007			CABLE PLENUM	100 PAIR 24 GAUGE		
			NONSHIELD			
N			FT	100	1	100
002079853			CABLE PLENUM	4 CONDUCTOR 22GA		
			NONSHIELD			
1151274			1000 FT	IL IN MI OH WI		
				18 18 18 18 18		

DISTRIBUTION SERVICES
 NETWORK SERVICES
 TOOLS
 BUILDING JANITORIAL
 AUTOMOTIVE
 FORMS/OFFICE SUPPLIES
 GENERAL
 DATA VOICE

PRODUCT IDENTIFIER							DESCRIPTION						
ITEM NUMBER	ORD. MULT.	SELL UNIT	STD. PKG.	LEAD TIME	MIN. ORD.	A C							
							STOCK AVAILABILITY / PA						
CABLE RACK													
SEE RACK CABLE.													
CABLE STRAP													
SEE STRAP CABLE.													
CABLE STUB													
SEE STUB CABLE.													
CABLE TAG													
SEE TAG CABLE.													
CABLE TERMINAL													
SEE TERMINAL CABLE.													
CABLE TIE													
SEE TIE CABLE.													
CABLE WIRE INSIDE													
403101140 CABLE WIRE INSIDE D 4 PAIR													
1228551	1000	FT					Intended primarily for use in PBX and station wiring, BSP 461-200-180.						
105004188 CABLE WIRE INSIDE D 6 PAIR													
N		FT	1000	1	1000		Standard length 1000FT.						
105056089 CABLE WIRE INSIDE D 6 PAIR													
1170555	1	FT	IL 18	IN 18	MI 18	OH 18	WI 18	Standard length 500FT.					
105035398 CABLE WIRE INSIDE D 6 PAIR GRAY													
1182725	1	FT	IL 18	IN 18	MI 18	OH 18	WI 18	Standard length 1000FT.					
105034805 CABLE WIRE INSIDE D 12 PAIR GRAY													
1105452		FT	IL 18	IN 18	MI 18	OH 18	WI 18	Standard length 1000FT.					
105034797 CABLE WIRE INSIDE D 16 PAIR													
1146910	1	FT	IL 18	IN 18	MI 18	OH 18	WI 18	Standard length 1000FT.					
105003693 CABLE WIRE INSIDE D 25 PAIR													
1123281	1	FT	IL 18	IN 18	MI 18	OH 18	WI 18	Standard length 1000FT.					
105004907 CABLE WIRE INSIDE D 50 PAIR													
1123307	1	FT	IL 18	IN 18	MI 18	OH 18	WI 18	Standard length 1000FT.					

PRODUCT IDENTIFIER							DESCRIPTION						
ITEM NUMBER	ORD. MULT.	SELL UNIT	STD. PKG.	LEAD TIME	MIN. ORD.	A C							
							STOCK AVAILABILITY / PA						
400025441 CABLE WIRE INSIDE D 75 PAIR													
1136556	1	FT	IL 18	IN 18	MI 18	OH 18	WI 18						
105004170 CABLE WIRE INSIDE D 100 PAIR													
1164350	1	FT	IL 18	IN 18	MI 18	OH 18	WI 18	Standard length 1000FT.					
CAP													
260339668 CAP CAD ORANGE 4IN													
1949446	1	CT	Reflective orange plastic cap to be placed on CAD closures for identification purposes.										
280094020 CAP CAD ORANGE 6IN													
1937359	1	CT	IL 08	IN 08	MI 08	OH 08	WI 08	Box of 50.					
280094038 CAP CAD ORANGE 8IN													
1937367	1	CT	IL 08	IN 08	MI 08	OH 08	WI 08	Box of 50.					
280094046 CAP CAD ORANGE 12IN													
1937342	1	CT	IL 08	IN 08	MI 08	OH 08	WI 08	Box of 30.					
260348909 CAP CONNECTOR 710 CAL-25													
1951749	1	EA	IL 08	IN MI	OH WI	A 710 filled cap.							
260348917 CAP CONNECTOR 710 CB1-25													
1951756	1	EA	IL 08	IN MI	OH WI	A 710 dry cap.							
260428412 CAP END VALVED 103P845													
N		EA	200		6	200							
260346515 CAP ESS C10-100-27/300													
N		EA	1		2	1	78-8020-7319-3. NOW AVAILABLE THROUGH TOUCH-TONE ORDER ENTRY.						
300013968 CAP FAAC 100													
N		EA	75		6	300							
300013950 CAP FAAC 200													
N		EA	50		6	250							
300040359 CAP FAAC 300													
N		EA	25		6	125							
401340138 CAP MOULDING W1120													
1332759	1	EA	IL 08	IN 08	MI MI	OH OH	WI WI	Wood moulding 15 inches long to be placed over the ground wire connection and the power companies wood moulding.					

DISTRIBUTION SERVICES

NETWORK SERVICES

TOOLS

BUILDING JANITORIAL

AUTOMOTIVE

FORMS/OFFICE SUPPLIES

GENERAL

DATA VOICE

CAP

PRODUCT IDENTIFIER DESCRIPTION

ITEM NUMBER	ORD. MULT.	SELL UNIT	STD. PKG. STOCK AVAILABILITY / PA	LEAD TIME	MIN. ORD.	A C
-------------	------------	-----------	-----------------------------------	-----------	-----------	-----

300049079 CAP PRIORITY CIRCUIT 4014
 1332742 1 EA IL IN MI OH WI
 08 08 08 08 08
 Used to identify special circuits in modular type buried service terminals, BSP 631-620-900W.



1332742

300073756 CAP PRIORITY CIRCUIT 4314

5121806 1 EA IL IN MI OH WI
 08 08 08 08 08
 Bag of 120.



5121806

280057001 CAP PRIORITY CIRCUIT 4324

1936500 1 EA IL IN MI OH WI
 08 08 08 08 08

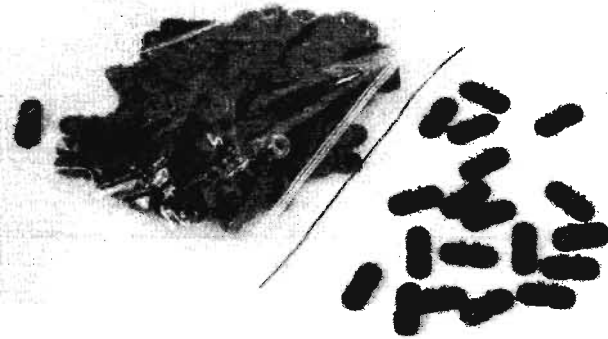

1936500

260338801 CAP PRIORITY CIRCUIT P38220

N PK 1 4 1

PRODUCT IDENTIFIER DESCRIPTION

ITEM NUMBER	ORD. MULT.	SELL UNIT	STD. PKG. STOCK AVAILABILITY / PA	LEAD TIME	MIN. ORD.	A C
-------------	------------	-----------	-----------------------------------	-----------	-----------	-----

280029943 CAP PRIORITY TERMAX
 1922930 1 EA IL IN MI OH WI
 08
 Bag of 50.

001024025 CAP SEC 1/0 YELLOW CECO348348
 8180901 1 EA IL IN MI OH WI
 08
 Ship no charge.

001024041 CAP SEC 3/0 BLACK CECO348349
 8181065 1 EA IL IN MI OH WI
 08

001024058 CAP SEC 4/0 BROWN CECO348372
 8181362 1 EA IL IN MI OH WI
 08

260330436 CAP SELF STRIP HALF-TAP
 N KT 1 3 1
 Replacement for 3M Self Strip. NOW AVAILABLE THROUGH TOUCH-TONE ORDER ENTRY.

260330428 CAP SELF STRIP STANDARD
 N KT 1 3 1
 Replacement for 3M Self Strip.

300040367 CAP VAAC-100
 N EA 75 6 375

300040375 CAP VAAC-200
 N EA 50 6 250

300040383 CAP VAAC-300
 N EA 25 6 125

260447636 CAP, RED PRIORITY CIRCUIT
 N
 For use on Reliable self-strip blocks.

CAP CABLE

400025862 CAP CABLE C 3/4IN CA08187
 1123604 1 EA
 C caps are intended for temporarily sealing the ends of lead or plastic sheath cables, BSP 633-505-212.



400025862

400025870 CAP CABLE C 1 IN CA08187
 1123620 1 EA IL IN MI OH WI
 08 08 08 08 08

PRODUCT IDENTIFIER		DESCRIPTION						
ITEM NUMBER	ORD. MULT.	SELL UNIT	STD. PKG. STOCK	PKG. AVAILABILITY	LEAD TIME / PA	MIN. ORD.	A C	
400025888 CAP CABLE C 1 1/2IN CA08187								
1123646	1	EA	IL 08	IN 08	MI 08	OH 08	WI 08	
400025896 CAP CABLE C 2 IN CA08187								
1123661	1	EA	IL 08	IN 08	MI 08	OH 08	WI 08	
400025904 CAP CABLE C 2 1/2IN CA08187								
1123687	1	EA	IL 08	IN 08	MI 08	OH 08	WI 08	
400025912 CAP CABLE C 3 IN CA08187								
1123703	1	EA	IL 08	IN 08	MI 08	OH 08	WI 08	
400327946 CAP CABLE C 3 1/4IN CA08187								
1101311	1	EA	IL 08	IN 08	MI 08	OH 08	WI 08	

CAP COLLARED

260346531 CAP COLLARED C 3-175-1C								
N		EA	1		2		1	
78-8011-2984-8. NOW AVAILABLE THROUGH TOUCH-TONE ORDER ENTRY.								
260346549 CAP COLLARED C 4-175-1C								
N		EA	1		2		1	
78-8011-2985-5.								
260346556 CAP COLLARED C 5-275-1C								
N		EA	1		2		1	
78-8011-2986-3.								
260346564 CAP COLLARED C 6-275-1C								
N		EA	1		2		1	
78-8011-2987-1.								
260330063 CAP COLLARED C 7-275-1C								
N		EA	1		2		1	
260328497 CAP COLLARED C 8-300-1C								
N		EA	1		2		1	
260322417 CAP COLLARED C10-360-1C								
1969675	1	EA	IL 08	IN	MI 08	OH	WI	
260346572 CAP COLLARED C12-390-1C								
N		EA	1		2		1	
78-8011-2992-1.								

CAP FLAT

260346655 CAP FLAT 2IN C 2								
N		EA	1		2		1	
78-8011-1835-3.								
260323316 CAP FLAT 3IN C 3								
N		EA	1		2		1	

PRODUCT IDENTIFIER		DESCRIPTION						
ITEM NUMBER	ORD. MULT.	SELL UNIT	STD. PKG. STOCK	PKG. AVAILABILITY	LEAD TIME / PA	MIN. ORD.	A C	
260346663 CAP FLAT 4IN C 4								
N		EA	1		2		1	
78-8011-1837-9.								
260346671 CAP FLAT 5IN C 5								
N		EA	1		2		1	
78-8020-7452-2.								
260346689 CAP FLAT 6IN C 6								
N		EA	1		2		1	
78-8020-7453-0.								
260322375 CAP FLAT 7IN C 7								
N		EA	1		2		1	
260322383 CAP FLAT 8IN C 8								
N		EA	1		2		1	
260322391 CAP FLAT 9IN C 9								
N		EA	1		2		1	

260346697 CAP FLAT 10IN C10								
1969683	1	EA	IL 08	IN	MI 08	OH	WI 08	
78-8020-7457-1.								
260328489 CAP FLAT 12IN C12								
N		EA	1		2		1	

CAP FLAT END

280023425 CAP FLAT END 102P811 1 IN								
1921908	1	EA						
280023433 CAP FLAT END 102P832 2 IN								
1921890	1	EA	IL 08	IN	MI	OH	WI	
280047796 CAP FLAT END 102P845 2 1/2IN								
1926683	1	EA	IL	IN	MI	OH	WI	
280023441 CAP FLAT END 102P854 3 IN								
1921882	1	EA	IL	IN	MI	OH	WI	

CAP MULTIPLE

260346648 CAP MULTIPLE BUTT 2IN C2-2								
N		EA	1		2		1	
78-8011-1875-9.								
260346382 CAP MULTIPLE C 4-175- 2								
N		EA	1		2		1	
260323381 CAP MULTIPLE C 5-100- 6								
1969600	1	EA	IL 08	IN	MI 08	OH 08	WI	
260346390 CAP MULTIPLE C 5-130- 6								
N		EA	1		2		1	

DISTRIBUTION SERVICES

NETWORK SERVICES

TOOLS

BUILDING JANITORIAL

AUTOMOTIVE

FORMS/OFFICE SUPPLIES

GENERAL

DATA VOICE

DISTRIBUTION SERVICES

NETWORK SERVICES

TOOLS

BUILDING JANITORIAL

AUTOMOTIVE

FORMS/OFFICE SUPPLIES

GENERAL

DATA VOICE

CAP MULTIPLE

PRODUCT IDENTIFIER		DESCRIPTION						
ITEM NUMBER	ORD. MULT.	SELL UNIT	STD. PKG. STOCK AVAILABILITY / PA	LEAD TIME	MIN. ORD.	A	C	
260346408		CAP MULTIPLE C	5-175- 2					
N		EA	1	2	1			
260346416		CAP MULTIPLE C	6-100- 9					
1969618	1	EA	IL 08 IN MI 08 OH WI 08					
260346424		CAP MULTIPLE C	6-100-10 END					
N		EA	1	2	1			
260346432		CAP MULTIPLE C	6-130- 9					
N		EA	1	2	1			
260346440		CAP MULTIPLE C	6-175- 3					
N		EA	1	2	1			
260330055		CAP MULTIPLE C	7-100-15					
1969626	1	EA	IL 08 IN MI 08 OH WI 08					
260346457		CAP MULTIPLE C	7-175- 5					
N		EA	1	2	1			
			78-8011-1863-5.					
260323340		CAP MULTIPLE C	8-100-24					
N		EA	1	2	1			
260346465		CAP MULTIPLE C	8-130-18					
N		EA	1	2	1			
			78-8011-1866-8.					
260346473		CAP MULTIPLE C	8-175- 8					
N		EA	1	2	1			
			78-8011-1867-6.					
260322425		CAP MULTIPLE C	9-100-27					
1969634	1	EA	IL 08 IN MI 08 OH WI 08					
260346481		CAP MULTIPLE C	9-130-24					
N		EA	1	2	1			
			78-8011-1870-0.					
260346499		CAP MULTIPLE C	9-175- 9					
N		EA	1	2	1			
			78-8011-1871-8.					
260346507		CAP MULTIPLE C	9-275- 3					
N		EA	1	2	1			
			78-8026-7553-4.					
260322409		CAP MULTIPLE C	10-100-36					
1969642	1	EA	IL 08 IN MI 08 OH WI 08					
260346523		CAP MULTIPLE C	12-100-48					
N		EA	1	2	1			
			78-8020-7451-4.					
260323399		CAP MULTIPLE C	12-130-37					
N		EA	1	2	1			

PRODUCT IDENTIFIER		DESCRIPTION						
ITEM NUMBER	ORD. MULT.	SELL UNIT	STD. PKG. STOCK AVAILABILITY / PA	LEAD TIME	MIN. ORD.	A	C	
CAP PLASTIC								
400866182		CAP PLASTIC G	2IN X 4IN CA08643					
1435842	1	EA						
			Plastic cap used above ground level to reduce size of conduit opening to accept smaller U cable guard, BSP 628-200-206.					
400866190		CAP PLASTIC G	3IN X 4IN CA08643					
1177899	1	EA	IL 35 IN 35 MI 35 OH 35 WI 35					
400866208		CAP PLASTIC G	4IN X 4IN CA08643					
1435883	1	EA	IL 08 IN 08 MI 08 OH 08 WI 08					
CAP POST BINDING								
400026175		CAP POST BINDING	BLACK					
N		EA	2500	6	2500			
			25 caps per package.					
400026183		CAP POST BINDING	RED					
N		EA	2500	6	2500			
			25 caps per package.					
400151890		CAP POST BINDING	3					
1185603	1	EA	IL 08 IN 08 MI 08 OH 08 WI 08					
			Used for bndng posts and fuses of special circuits to prevent accidental contacts. Ht. 7/BIN, diam. 13/32IN, CA06798. BSP 460-110-100. Package of 25.					
								
			1185603					
400151908		CAP POST BINDING	6					
5205468	1	PK	IL 08 IN 08 MI 08 OH 08 WI 08					
			CA06798. Package of 25.					

PRODUCT IDENTIFIER DESCRIPTION

ITEM	ORD.	SELL	STD. PKG.	LEAD TIME	MIN.	A
NUMBER	MULT.	UNIT	STOCK AVAILABILITY / PA	ORD.	C	

400026068 CAP POST BINDING B RED

1124487	1	EA	IL 08	IN 08	MI 08	OH 08	WI 08
---------	---	----	-------	-------	-------	-------	-------

Moulded rubber cap which completely covers non-working binding posts in 8, 14 CF and NA type distribution terminals, BSP 460-110-100. Package of 25.

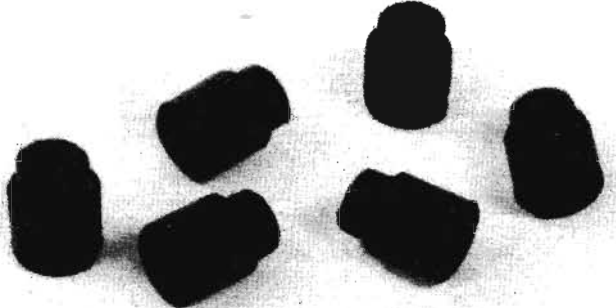

1124487

400026084 CAP POST BINDING C RED

1124529	1	EA	IL 08	IN 08	MI 08	OH 08	WI 08
---------	---	----	-------	-------	-------	-------	-------

Permits installation over drop or bridle wire terminated on binding posts in 8, 14, F and NA type terminals, BSP 460-110-100. Package of 25.



1124529

400026092 CAP POST BINDING D BLACK

N	EA	2500	6	2500
---	----	------	---	------

400026100 CAP POST BINDING D RED

N	EA	2500	6	2500
---	----	------	---	------

Package of 25. NOW AVAILABLE THROUGH TOUCH-TONE ORDER ENTRY.

400026118 CAP POST BINDING E BLACK

N	EA	2500	6	2500
---	----	------	---	------

Package of 25.

400026126 CAP POST BINDING E RED CA07187

N	EA	2500	6	2500
---	----	------	---	------

400026134 CAP POST BINDING F BLACK

N	EA	2500	6	2500
---	----	------	---	------

Package of 25.

400026159 CAP POST BINDING G BLACK CA07187

N	EA	2500	6	2500
---	----	------	---	------

PRODUCT IDENTIFIER DESCRIPTION

ITEM	ORD.	SELL	STD. PKG.	LEAD TIME	MIN.	A
NUMBER	MULT.	UNIT	STOCK AVAILABILITY / PA	ORD.	C	

CAP PUDDLE

260346580	CAP PUDDLE C 7-5	N	EA	1	2	1
-----------	------------------	---	----	---	---	---

78-8011-1881-7.

260346598	CAP PUDDLE C 8-7	N	EA	1	2	1
-----------	------------------	---	----	---	---	---

78-8020-7438-1.

260346606	CAP PUDDLE C 9-5	N	EA	1	2	1
-----------	------------------	---	----	---	---	---

78-8011-1882-5.

260346614	CAP PUDDLE C 9-7	N	EA	1	2	1
-----------	------------------	---	----	---	---	---

78-8011-1883-3.

260346622	CAP PUDDLE C10-8	N	EA	1	2	1
-----------	------------------	---	----	---	---	---

78-8020-7437-3.

260346630	CAP PUDDLE C12-8-6	N	EA	1	2	1
-----------	--------------------	---	----	---	---	---

78-8026-7552-6.

CAP TERMINAL

400151825	CAP TERMINAL CK16604 L1	5205385	1	PK		
-----------	-------------------------	---------	---	----	--	--

Red plastic, slotted, 1/2in long, wire wrap terminal for 300 type connectors only. Package of 100.

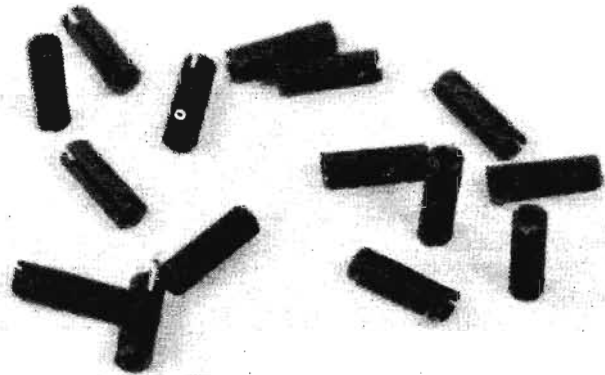

400151825

DISTRIBUTION SERVICES

NETWORK SERVICES

TOOLS

BUILDING JANITORIAL

AUTOMOTIVE

FORMS/OFFICE SUPPLIES

GENERAL

DATA VOICE

DISTRIBUTION SERVICES

NETWORK SERVICES

TOOLS

BUILDING JANITORIAL

AUTOMOTIVE

FORMS/OFFICE SUPPLIES

GENERAL

DATA VOICE

CAP TERMINAL

PRODUCT IDENTIFIER		DESCRIPTION						
ITEM NUMBER	ORD. MULT.	SELL UNIT	STD. PKG. STOCK AVAILABILITY / PA	LEAD TIME	MIN. ORD.	A	C	

401206180 CAP TERMINAL CK21168 L1
 8169086 1 PK IL IN MI OH WI
 18 18 18 18 18
 A red polyvinyl terminal insulator used to insulate, protect & designate special service pairs on a 303 connector cross connect field. Package of 100.

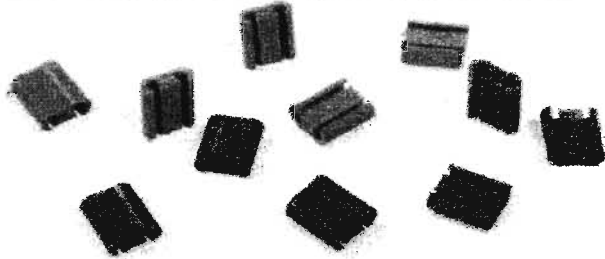

8169086

401851514 CAP TERMINAL CLIP B CA08095
 2810424 1 PK IL IN MI OH WI
 18 18 18 18 18
 Package of 24. Designed to protect one row of terminals on the 66 type connecting block, BSP 460-110-100.

280028184 CAP TERMINAL TLC B BLACK
 1929307 1 EA IL IN MI OH WI
 08 08 08 08 08
 A chemical filled sealing cap designed to protect 9A1 and RPT type terminal lugs against corrosion. Package of 10.

280028218 CAP TERMINAL TLC B RED
 1930958 1 EA IL IN MI OH WI
 08 08 08 08 08
 A chemical filled sealing cap designed to protect 9A1 and RPT type terminal lugs against corrosion when used for special circuits. Package of 10.

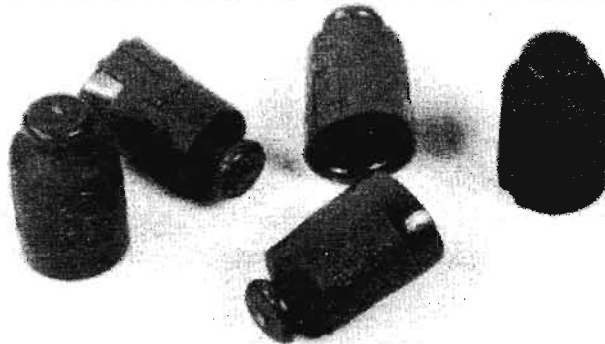

1930958

260327804 CAP TERMINAL TLC B XB BLACK
 N EA 5000 6 5000
 Used for cross-connect box applications, package of 50.

260327788 CAP TERMINAL TLC B XB RED
 N EA 5000 6 5000
 Used for cross-connect box applications, package of 50.

PRODUCT IDENTIFIER		DESCRIPTION						
ITEM NUMBER	ORD. MULT.	SELL UNIT	STD. PKG. STOCK AVAILABILITY / PA	LEAD TIME	MIN. ORD.	A	C	

280028176 CAP TERMINAL TLC AA BLACK
 1929299 1 EA IL IN MI OH WI
 08 08 08 08 08
 A chemical filled sealing cap designed to protect NF type terminal lugs against corrosion. Package of 10.

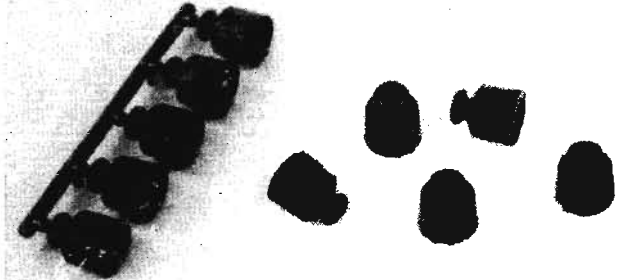

1929299

280028200 CAP TERMINAL TLC AA RED
 1930941 1 EA IL IN MI OH WI
 08 08 08 08 08
 A chemical filled sealing cap designed to protect NF type terminal lugs, when used for special circuits, against corrosion. Package of 10.

260327812 CAP TERMINAL TLC AA XB BLACK
 N EA 5000 6 5000
 Used for cross-connect box applications, package of 50.

260327796 CAP TERMINAL TLC AA XB RED
 1945303 1 EA IL IN MI OH WI
 08 08 08 08
 Used for cross-connect box applications, package of 50.



1945303

260428420 CAP TERMINAL TLC-AA-XB RED
 N EA 5000 6 5000
 NOW AVAILABLE THROUGH TOUCH-TONE ORDER ENTRY.

CAP VALVED END

280023458 CAP VALVED END 103P811
 1921874 1 EA
 A one inch rubber cap used to cover cable ends. ADC USAGE ONLY.

PRODUCT IDENTIFIER		DESCRIPTION				
ITEM NUMBER	ORD. MULT.	SELL UNIT	STD. PKG. STOCK AVAILABILITY / PA	LEAD TIME	MIN. ORD.	A C
280023466 CAP VALVED END 103P832						
1921866	1	EA	IL IN MI OH WI			
A two inch rubber cap used to cover cable ends. ADC USAGE ONLY.						
280047804 CAP VALVED END 103P845						
1926675	1	EA	IL IN MI OH WI			
A two 1/2 inch rubber cap used to cover cable ends. ADC USAGE ONLY.						
280023474 CAP VALVED END 103P854						
1921858	1	EA	IL IN MI OH WI			
A three inch rubber cap used to cover cable ends. ADC USAGE ONLY.						

CASE COIL						
ITEM NUMBER	ORD. MULT.	SELL UNIT	STD. PKG. STOCK AVAILABILITY / PA	LEAD TIME	MIN. ORD.	A C
MH MANHOLE BRACKET, PM POST MOUNT BRACKET.						
260349196 CASE COIL			25PR 10FT W/MH BKT			
N		EA	1	6	1	
		662				
260349212 CASE COIL			25PR 10FT W/MH BKT FILL			
N		EA	1	6	1	
		662				
260349204 CASE COIL			25PR 10FT W/PM BKT			
N		EA	1	6	1	
		662				
260349220 CASE COIL			25PR 10FT W/PM BKT FILL			
N		EA	1	6	1	
		662				
260349238 CASE COIL			25PR 15FT W/MH BKT			
N		EA	1	6	1	
		662				
260349253 CASE COIL			25PR 15FT W/MH BKT FILL			
N		EA	1	6	1	
		662				
260349246 CASE COIL			25PR 15FT W/PM BKT			
N		EA	1	6	1	
		662				
260349261 CASE COIL			25PR 15FT W/PM BKT FILL			
N		EA	1	6	1	
		662				
260349279 CASE COIL			25PR 20FT W/MH BKT			
N		EA	1	6	1	
		662				
260349295 CASE COIL			25PR 20FT W/MH BKT FILL			
N		EA	1	6	1	
		662				
260349287 CASE COIL			25PR 20FT W/PM BKT			
N		EA	1	6	1	
		662				

PRODUCT IDENTIFIER		DESCRIPTION				
ITEM NUMBER	ORD. MULT.	SELL UNIT	STD. PKG. STOCK AVAILABILITY / PA	LEAD TIME	MIN. ORD.	A C
260349303 CASE COIL			25PR 20FT W/PM BKT FILL			
N		EA	1	6	1	
		662				
260349311 CASE COIL			50PR 10FT W/MH BKT			
N		EA	1	6	1	
		662				
260349337 CASE COIL			50PR 10FT W/MH BKT FILL			
N		EA	1	6	1	
		662				
260349329 CASE COIL			50PR 10FT W/PM BKT			
N		EA	1	6	1	
		662				
260349345 CASE COIL			50PR 10FT W/PM BKT FILL			
N		EA	1	6	1	
		662				
260349352 CASE COIL			50PR 15FT W/MH BKT			
N		EA	1	6	1	
		662				
260349378 CASE COIL			50PR 15FT W/MH BKT FILL			
N		EA	1	6	1	
		662				
260349360 CASE COIL			50PR 15FT W/PM BKT			
N		EA	1	6	1	
		662				
260349386 CASE COIL			50PR 15FT W/PM BKT FILL			
N		EA	1	6	1	
		662				
260349394 CASE COIL			50PR 20FT W/MH BKT			
N		EA	1	6	1	
		662				
260349410 CASE COIL			50PR 20FT W/MH BKT FILL			
N		EA	1	6	1	
		662				
260349402 CASE COIL			50PR 20FT W/PM BKT			
N		EA	1	6	1	
		662				
260349428 CASE COIL			50PR 20FT W/PM BKT FILL			
N		EA	1	6	1	
		662				
260349436 CASE COIL			75PR 10FT W/MH BKT			
N		EA	1	3	1	
		662				
260349451 CASE COIL			75PR 10FT W/MH BKT FILL			
N		EA	1	3	1	
		662				
260349444 CASE COIL			75PR 10FT W/PM BKT			
N		EA	1	3	1	
		662				

DISTRIBUTION SERVICES
 NETWORK SERVICES
 TOOLS
 BUILDING JANITORIAL
 AUTOMOTIVE
 FORMS/OFFICE SUPPLIES
 GENERAL
 DATA VOICE

DISTRIBUTION SERVICES

NETWORK SERVICES

TOOLS

BUILDING JANITORIAL

AUTOMOTIVE

FORMS/OFFICE SUPPLIES

GENERAL

DATA VOICE

CASE COIL

PRODUCT IDENTIFIER		DESCRIPTION				
ITEM NUMBER	ORD. MULT.	SELL UNIT	STD. PKG. STOCK AVAILABILITY / PA	LEAD TIME	MIN. ORD.	A C
260349469		CASE COIL	75PR 10FT W/PM BKT FILL			
N		EA	1	3	1	
	662					
260349477		CASE COIL	75PR 15FT W/MH BKT			
N		EA	1	3	1	
	662					
260349493		CASE COIL	75PR 15FT W/MH BKT FILL			
N		EA	1	3	1	
	662					
260349485		CASE COIL	75PR 15FT W/PM BKT			
N		EA	1	3	1	
	662					
260349501		CASE COIL	75PR 15FT W/PM BKT FILL			
N		EA	1	3	1	
	662					
260349519		CASE COIL	75PR 20FT W/MH BKT			
N		EA	1	3	1	
	662					
260349535		CASE COIL	75PR 20FT W/MH BKT FILL			
N		EA	1	3	1	
	662					
260349527		CASE COIL	75PR 20FT W/PM BKT			
N		EA	1	3	1	
	662					
260349543		CASE COIL	75PR 20FT W/PM BKT FILL			
N		EA	1	3	1	
	662					
260349550		CASE COIL	100PR 10FT W/MH BKT			
N		EA	1	6	1	
	662					
260349576		CASE COIL	100PR 10FT W/MH BKT FILL			
N		EA	1	6	1	
	662					
260349568		CASE COIL	100PR 10FT W/PM BKT			
N		EA	1	6	1	
	662					
260349584		CASE COIL	100PR 10FT W/PM BKT FILL			
N		EA	1	6	1	
	662					
260349592		CASE COIL	100PR 15FT W/MH BKT			
N		EA	1	6	1	
	662					
260349618		CASE COIL	100PR 15FT W/MH BKT FILL			
N		EA	1	6	1	
	662					
260349600		CASE COIL	100PR 15FT W/PM BKT			
N		EA	1	6	1	
	662					

PRODUCT IDENTIFIER		DESCRIPTION				
ITEM NUMBER	ORD. MULT.	SELL UNIT	STD. PKG. STOCK AVAILABILITY / PA	LEAD TIME	MIN. ORD.	A C
260349626		CASE COIL	100PR 15FT W/PM BKT FILL			
N		EA	1	6	1	
	662					
260349634		CASE COIL	100PR 20FT W/MH BKT			
N		EA	1	6	1	
	662					
260349659		CASE COIL	100PR 20FT W/MH BKT FILL			
N		EA	1	6	1	
	662					
260349642		CASE COIL	100PR 20FT W/PM BKT			
N		EA	1	6	1	
	662					
260349667		CASE COIL	100PR 20FT W/PM BKT FILL			
N		EA	1	6	1	
	662					
260349675		CASE COIL	150PR 10FT W/MH BKT			
N		EA	1	3	1	
	662					
260349691		CASE COIL	150PR 10FT W/MH BKT FILL			
N		EA	1	3	1	
	662					
260349683		CASE COIL	150PR 10FT W/PM BKT			
N		EA	1	3	1	
	662					
260349709		CASE COIL	150PR 10FT W/PM BKT FILL			
N		EA	1	3	1	
	662					
260349717		CASE COIL	150PR 15FT W/MH BKT			
N		EA	1	3	1	
	662					
260349733		CASE COIL	150PR 15FT W/MH BKT FILL			
N		EA	1	3	1	
	662					
260349725		CASE COIL	150PR 15FT W/PM BKT			
N		EA	1	3	1	
	662					
260349741		CASE COIL	150PR 15FT W/PM BKT FILL			
N		EA	1	3	1	
	662					
260349758		CASE COIL	150PR 20FT W/MH BKT			
N		EA	1	3	1	
	662					
260349774		CASE COIL	150PR 20FT W/MH BKT FILL			
N		EA	1	3	1	
	662					
260349766		CASE COIL	150PR 20FT W/PM BKT			
N		EA	1	3	1	
	662					

PRODUCT IDENTIFIER		DESCRIPTION				
ITEM NUMBER	ORD. MULT.	SELL UNIT	STD. PKG. STOCK AVAILABILITY / PA	LEAD TIME	MIN. ORD.	A C
260349782	N	EA	150PR 20FT W/PM BKT FILL	3	1	
	662					
260349790	N	EA	200PR 10FT W/MH BKT	3	1	
	662					
260349816	N	EA	200PR 10FT W/MH BKT FILL	3	1	
	662					
260349808	N	EA	200PR 10FT W/PM BKT	3	1	
	662					
260349824	N	EA	200PR 10FT W/PM BKT FILL	3	1	
	662					
260349832	N	EA	200PR 15FT W/MH BKT	3	1	
	662					
260349857	N	EA	200PR 15FT W/MH BKT FILL	3	1	
	662					
260349840	N	EA	200PR 15FT W/PM BKT	3	1	
	662					
260349865	N	EA	200PR 15FT W/PM BKT FILL	3	1	
	662					
260349873	N	EA	200PR 20FT W/MH BKT	3	1	
	662					
260349899	N	EA	200PR 20FT W/MH BKT FILL	3	1	
	662					
260349881	N	EA	200PR 20FT W/PM BKT	3	1	
	662					
260349907	N	EA	200PR 20FT W/PM BKT FILL	3	1	
	662					
260349915	N	EA	250PR 10FT W/MH BKT	3	1	
	662					
260349931	N	EA	250PR 10FT W/MH BKT FILL	3	1	
	662					
260349923	N	EA	250PR 10FT W/PM BKT	3	1	
	662					

PRODUCT IDENTIFIER		DESCRIPTION				
ITEM NUMBER	ORD. MULT.	SELL UNIT	STD. PKG. STOCK AVAILABILITY / PA	LEAD TIME	MIN. ORD.	A C
260349949	N	EA	250PR 10FT W/PM BKT FILL	3	1	
	662					
260349956	N	EA	250PR 15FT W/MH BKT	3	1	
	662					
260349972	N	EA	250PR 15FT W/MH BKT FILL	3	1	
	662					
260349964	N	EA	250PR 15FT W/PM BKT	3	1	
	662					
260349980	N	EA	250PR 15FT W/PM BKT FILL	3	1	
	662					
260349998	N	EA	250PR 20FT W/MH BKT	3	1	
	662					
260350020	N	EA	250PR 20FT W/MH BKT FILL	3	1	
	662					
260350004	N	EA	250PR 20FT W/PM BKT	3	1	
	662					
260350012	N	EA	250PR 20FT W/PM BKT FILL	3	1	
	662					
260350046	N	EA	300PR 10FT W/MH BKT	3	1	
	662					
260350053	N	EA	300PR 10FT W/MH BKT FILL	3	1	
	662					
260350038	N	EA	300PR 10FT W/PM BKT	3	1	
	662					
260350061	N	EA	300PR 10FT W/PM BKT FILL	3	1	
	662					
260350079	N	EA	300PR 15FT W/MH BKT	3	1	
	662					
260350095	N	EA	300PR 15FT W/MH BKT FILL	3	1	
	662					
260350087	N	EA	300PR 15FT W/PM BKT	3	1	
	662					

DISTRIBUTION SERVICES
NETWORK SERVICES
TOOLS
BUILDING JANITORIAL
AUTOMOTIVE
FORMS/OFFICE SUPPLIES
GENERAL
DATA VOICE

DISTRIBUTION SERVICES

NETWORK SERVICES

TOOLS

BUILDING JANITORIAL

AUTOMOTIVE

FORMS/OFFICE SUPPLIES

GENERAL

DATA VOICE

CASE COIL

PRODUCT IDENTIFIER		DESCRIPTION				
ITEM NUMBER	ORD. MULT.	SELL UNIT	STD. PKG. STOCK AVAILABILITY / PA	LEAD TIME	MIN. ORD.	A C
260350103		CASE COIL	300PR 15FT W/PM BKT FILL			
N		EA	1	3	1	
	662					
260350111		CASE COIL	300PR 20FT W/MH BKT			
N		EA	1	3	1	
	662					
260350137		CASE COIL	300PR 20FT W/MH BKT FILL			
N		EA	1	3	1	
	662					
260350129		CASE COIL	300PR 20FT W/PM BKT			
N		EA	1	3	1	
	662					
260350145		CASE COIL	300PR 20FT W/PM BKT FILL			
N		EA	1	3	1	
	662					
260350152		CASE COIL	400PR 10FT W/MH BKT			
N		EA	1	3	1	
	662					
260350178		CASE COIL	400PR 10FT W/MH BKT FILL			
N		EA	1	3	1	
	662					
260350160		CASE COIL	400PR 10FT W/PM BKT			
N		EA	1	3	1	
	662					
260350186		CASE COIL	400PR 10FT W/PM BKT FILL			
N		EA	1	3	1	
	662					
260350194		CASE COIL	400PR 15FT W/MH BKT			
N		EA	1	3	1	
	662					
260350210		CASE COIL	400PR 15FT W/MH BKT FILL			
N		EA	1	3	1	
	662					
260350202		CASE COIL	400PR 15FT W/PM BKT			
N		EA	1	3	1	
	662					
260350228		CASE COIL	400PR 15FT W/PM BKT FILL			
N		EA	1	3	1	
	662					
260350236		CASE COIL	400PR 20FT W/MH BKT			
N		EA	1	3	1	
	662					
260350251		CASE COIL	400PR 20FT W/MH BKT FILL			
N		EA	1	3	1	
	662					
260350244		CASE COIL	400PR 20FT W/PM BKT			
N		EA	1	3	1	
	662					

PRODUCT IDENTIFIER		DESCRIPTION				
ITEM NUMBER	ORD. MULT.	SELL UNIT	STD. PKG. STOCK AVAILABILITY / PA	LEAD TIME	MIN. ORD.	A C
260350269		CASE COIL	400PR 20FT W/PM BKT FILL			
N		EA	1	3	1	
	662					
260350277		CASE COIL	450PR 10FT W/MH BKT			
N		EA	1	3	1	
	662					
260350293		CASE COIL	450PR 10FT W/MH BKT FILL			
N		EA	1	3	1	
	662					
260350285		CASE COIL	450PR 10FT W/PM BKT			
N		EA	1	3	1	
	662					
260350301		CASE COIL	450PR 10FT W/PM BKT FILL			
N		EA	1	3	1	
	662					
260350319		CASE COIL	450PR 15FT W/MH BKT			
N		EA	1	3	1	
	662					
260350335		CASE COIL	450PR 15FT W/MH BKT FILL			
N		EA	1	3	1	
	662					
260350327		CASE COIL	450PR 15FT W/PM BKT			
N		EA	1	3	1	
	662					
260350343		CASE COIL	450PR 15FT W/PM BKT FILL			
N		EA	1	3	1	
	662					
260350350		CASE COIL	450PR 20FT W/MH BKT			
N		EA	1	3	1	
	662					
260350376		CASE COIL	450PR 20FT W/MH BKT FILL			
N		EA	1	3	1	
	662					
260350368		CASE COIL	450PR 20FT W/PM BKT			
N		EA	1	3	1	
	662					
260350384		CASE COIL	450PR 20FT W/PM BKT FILL			
N		EA	1	3	1	
	662					
260350392		CASE COIL	500PR 10FT W/MH BKT			
N		EA	1	3	1	
	662					
260350418		CASE COIL	500PR 10FT W/MH BKT FILL			
N		EA	1	3	1	
	662					
260350400		CASE COIL	500PR 10FT W/PM BKT			
N		EA	1	3	1	
	662					

PRODUCT IDENTIFIER		DESCRIPTION				
ITEM NUMBER	ORD. MULT.	SELL UNIT	STD. PKG. STOCK AVAILABILITY / PA	LEAD TIME	MIN. ORD.	A C
260350426		CASE COIL	500PR 10FT W/PM BKT FILL			
N		EA	1	3	1	
	662					
260350434		CASE COIL	500PR 15FT W/MH BKT			
N		EA	1	3	1	
	662					
260350459		CASE COIL	500PR 15FT W/MH BKT FILL			
N		EA	1	3	1	
	662					
260350442		CASE COIL	500PR 15FT W/PM BKT			
N		EA	1	3	1	
	662					
260350467		CASE COIL	500PR 15FT W/PM BKT FILL			
N		EA	1	3	1	
	662					
260350491		CASE COIL	500PR 20FT W/MH BKT FILL			
N		EA	1	3	1	
	662					
260350509		CASE COIL	500PR 20FT W/PM BKT FILL			
N		EA	1	3	1	
	662					
260350517		CASE COIL	550PR 10FT W/MH BKT			
N		EA	1	3	1	
	662					
260350533		CASE COIL	550PR 10FT W/MH BKT FILL			
N		EA	1	3	1	
	662					
260350525		CASE COIL	550PR 10FT W/PM BKT			
N		EA	1	3	1	
	662					
260350541		CASE COIL	550PR 10FT W/PM BKT FILL			
N		EA	1	3	1	
	662					
260350558		CASE COIL	550PR 15FT W/MH BKT			
N		EA	1	3	1	
	662					
260350574		CASE COIL	550PR 15FT W/MH BKT FILL			
N		EA	1	3	1	
	662					
260350566		CASE COIL	550PR 15FT W/PM BKT			
N		EA	1	3	1	
	662					
260350582		CASE COIL	550PR 15FT W/PM BKT FILL			
N		EA	1	3	1	
	662					
260350590		CASE COIL	550PR 20FT W/MH BKT			
N		EA	1	3	1	
	662					

PRODUCT IDENTIFIER		DESCRIPTION				
ITEM NUMBER	ORD. MULT.	SELL UNIT	STD. PKG. STOCK AVAILABILITY / PA	LEAD TIME	MIN. ORD.	A C
260350616		CASE COIL	550PR 20FT W/MH BKT FILL			
N		EA	1	3	1	
	662					
260350608		CASE COIL	550PR 20FT W/PM BKT			
N		EA	1	3	1	
	662					
260350624		CASE COIL	550PR 20FT W/PM BKT FILL			
N		EA	1	3	1	
	662					
260350673		CASE COIL	600PR 15FT W/MH BKT			
N		EA	1	3	1	
	662					
260350699		CASE COIL	600PR 15FT W/MH BKT FILL			
N		EA	1	3	1	
	662					
260350681		CASE COIL	600PR 15FT W/PM BKT			
N		EA	1	3	1	
	662					
260350707		CASE COIL	600PR 15FT W/PM BKT FILL			
N		EA	1	3	1	
	662					
260350715		CASE COIL	600PR 20FT W/MH BKT			
N		EA	1	3	1	
	662					
260350731		CASE COIL	600PR 20FT W/MH BKT FILL			
N		EA	1	3	1	
	662					
260350723		CASE COIL	600PR 20FT W/PM BKT			
N		EA	1	3	1	
	662					
260350749		CASE COIL	600PR 20FT W/PM BKT FILL			
N		EA	1	3	1	
	662					
260350871		CASE COIL	750PR 10FT W/MH BKT			
N		EA	1	3	1	
	662					
260350897		CASE COIL	750PR 10FT W/MH BKT FILL			
N		EA	1	3	1	
	662					
260350889		CASE COIL	750PR 10FT W/PM BKT			
N		EA	1	3	1	
	662					
260350905		CASE COIL	750PR 10FT W/PM BKT FILL			
N		EA	1	3	1	
	662					
260350913		CASE COIL	750PR 15FT W/MH BKT			
N		EA	1	3	1	
	662					

DISTRIBUTION SERVICES

NETWORK SERVICES

TOOLS

BUILDING JANITORIAL

AUTOMOTIVE

FORMS/OFFICE SUPPLIES

GENERAL

DATA VOICE

DISTRIBUTION SERVICES
NETWORK SERVICES
TOOLS
BUILDING JANITORIAL
AUTOMOTIVE
FORMS/OFFICE SUPPLIES
GENERAL
DATA VOICE

CASE COIL

PRODUCT IDENTIFIER		DESCRIPTION				
ITEM NUMBER	ORD. MULT.	SELL UNIT	STD. PKG. STOCK AVAILABILITY / PA	LEAD TIME	MIN. ORD.	A C
260350939		CASE COIL	750PR 15FT W/MH BKT FILL			
N		EA	1	3	1	
	662					
260350921		CASE COIL	750PR 15FT W/PM BKT			
N		EA	1	3	1	
	662					
260350947		CASE COIL	750PR 15FT W/PM BKT FILL			
N		EA	1	3	1	
	662					
260350954		CASE COIL	750PR 20FT W/MH BKT			
N		EA	1	3	1	
	662					
260350970		CASE COIL	750PR 20FT W/MH BKT FILL			
N		EA	1	3	1	
	662					
260350962		CASE COIL	750PR 20FT W/PM BKT			
N		EA	1	3	1	
	662					
260350988		CASE COIL	750PR 20FT W/PM BKT FILL			
N		EA	1	3	1	
	662					
260351119		CASE COIL	900PR 10FT W/MH BKT			
N		EA	1	3	1	
	662					
260351135		CASE COIL	900PR 10FT W/MH BKT FILL			
N		EA	1	3	1	
	662					
260351127		CASE COIL	900PR 10FT W/PM BKT			
N		EA	1	3	1	
	662					
260351143		CASE COIL	900PR 10FT W/PM BKT FILL			
N		EA	1	3	1	
	662					
260351150		CASE COIL	900PR 15FT W/MH BKT			
N		EA	1	3	1	
	662					
260351176		CASE COIL	900PR 15FT W/MH BKT FILL			
N		EA	1	3	1	
	662					
260351168		CASE COIL	900PR 15FT W/PM BKT			
N		EA	1	3	1	
	662					
260351184		CASE COIL	900PR 15FT W/PM BKT FILL			
N		EA	1	3	1	
	662					
260351192		CASE COIL	900PR 20FT W/MH BKT			
N		EA	1	3	1	
	662					

PRODUCT IDENTIFIER		DESCRIPTION				
ITEM NUMBER	ORD. MULT.	SELL UNIT	STD. PKG. STOCK AVAILABILITY / PA	LEAD TIME	MIN. ORD.	A C
260351218		CASE COIL	900PR 20FT W/MH BKT FILL			
N		EA	1	3	1	
	662					
260351200		CASE COIL	900PR 20FT W/PM BKT			
N		EA	1	3	1	
	662					
260351226		CASE COIL	900PR 20FT W/PM BKT FILL			
N		EA	1	3	1	
	662					
260351358		CASE COIL	1200PR 10FT W/MH BKT			
N		EA	1	3	1	
	662					
260351374		CASE COIL	1200PR 10FT W/MH BKT FILL			
N		EA	1	3	1	
	662					
260351366		CASE COIL	1200PR 10FT W/PM BKT			
N		EA	1	3	1	
	662					
260351382		CASE COIL	1200PR 10FT W/PM BKT FILL			
N		EA	1	3	1	
	662					
260351390		CASE COIL	1200PR 15FT W/MH BKT			
N		EA	1	3	1	
	662					
260351416		CASE COIL	1200PR 15FT W/MH BKT FIL			
N		EA	1	3	1	
	662					
260351408		CASE COIL	1200PR 15FT W/PM BKT			
N		EA	1	3	1	
	662					
260351424		CASE COIL	1200PR 15FT W/PM BKT FILL			
N		EA	1	3	1	
	662					
260351432		CASE COIL	1200PR 20FT W/MH BKT			
N		EA	1	3	1	
	662					
260351457		CASE COIL	1200PR 20FT W/MH BKT FILL			
N		EA	1	3	1	
	662					
260351440		CASE COIL	1200PR 20FT W/PM BKT			
N		EA	1	3	1	
	662					
260351465		CASE COIL	1200PR 20FT W/PM BKT FILL			
N		EA	1	3	1	
	662					
300036902		CASE COIL	152 16PR			
N		EA	1	4	1	
103096541		CASE COIL	184C1 E/W 2 662			
N		EA	1	4	1	

PRODUCT IDENTIFIER		DESCRIPTION				
ITEM NUMBER	ORD. MULT.	SELL UNIT	STD. PKG. STOCK AVAILABILITY / PA	LEAD TIME	MIN. ORD.	A C

103103933 CASE COIL 184D1 E/W 2 662

1935320 1 EA IL IN MI OH WI
15 15 15 15 15
Epoxy printed circuit board equipped with a connector jack on one end and a finger pull on the other. Arranged to contain two 662 load coils.

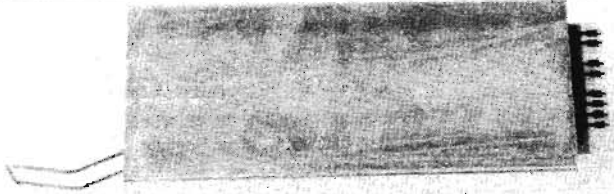

1935320

103103941 CASE COIL 184DI E/W 2-668

N EA 1 4 1

260404041 CASE COIL B152 1 PAIR

N EA 1 4 1

260404058 CASE COIL B152 2 PAIR

N EA 1 4 1

300036910 CASE COIL B152 6 PAIR

N EA 1 4 1

300036894 CASE COIL B152 11 PAIR

N EA 1 4 1

CASE COIL 662

280048109 CASE COIL 662 25PR 10FT STUB

N EA 1 3 1
Filled.

280048091 CASE COIL 662 25PR 10FT STUB

N EA 1 3 1

280048117 CASE COIL 662 25PR 15FT STUB

N EA 1 3 1

280048125 CASE COIL 662 25PR 15FT STUB

N EA 1 3 1
Filled.

280048133 CASE COIL 662 25PR 20FT STUB

1955328 1 EA IL IN MI OH WI
15 15 15 15 15
Filled.

280048141 CASE COIL 662 50PR 10FT STUB

N EA 1 3 1

280048158 CASE COIL 662 50PR 10FT STUB

N EA 1 3 1
Filled.

280048166 CASE COIL 662 50PR 15FT STUB

N EA 1 3 1

PRODUCT IDENTIFIER		DESCRIPTION				
ITEM NUMBER	ORD. MULT.	SELL UNIT	STD. PKG. STOCK AVAILABILITY / PA	LEAD TIME	MIN. ORD.	A C

280048182 CASE COIL 662 50PR 20FT STUB

1954420 1 EA IL IN MI OH WI
15 15 15 15 15
Filled.

280048190 CASE COIL 662 75PR 10FT STUB

N EA 1 3 1

280048208 CASE COIL 662 75PR 10FT STUB

N EA 1 3 1
Filled.

280048224 CASE COIL 662 75PR 15FT STUB

N EA 1 3 1
Filled.

280048216 CASE COIL 662 75PR 15FT STUB

N EA 1 3 1

280048232 CASE COIL 662 75PR 20FT STUB

N EA 1 3 1

280048240 CASE COIL 662 75PR 20FT STUB

N EA 1 3 1
Filled.

280023029 CASE COIL 662 100PR 10FT STUB

N EA 1 3 1
Filled.

280022773 CASE COIL 662 100PR 10FT STUB

N EA 1 3 1

280023037 CASE COIL 662 100PR 15FT STUB

N EA 1 3 1
Filled.

280022781 CASE COIL 662 100PR 15FT STUB

N EA 1 3 1

280023045 CASE COIL 662 100PR 20FT STUB

1955310 1 EA IL IN MI OH WI
15 15 15 15 15
Filled.

280023052 CASE COIL 662 150PR 10FT STUB

N EA 1 3 1
Filled.

280022807 CASE COIL 662 150PR 10FT STUB

N EA 1 3 1

280023060 CASE COIL 662 150PR 15FT STUB

N EA 1 3 1
Filled.

280022815 CASE COIL 662 150PR 15FT STUB

N EA 1 3 1

280022823 CASE COIL 662 150PR 20FT STUB

N EA 1 3 1

280023078 CASE COIL 662 150PR 20FT STUB

N EA 1 3 1
Filled.

DISTRIBUTION SERVICES

NETWORK SERVICES

TOOLS

BUILDING JANITORIAL

AUTOMOTIVE

FORMS/OFFICE SUPPLIES

GENERAL

DATA VOICE

CASE COIL 662

PRODUCT IDENTIFIER		DESCRIPTION						
ITEM NUMBER	ORD. MULT.	SELL UNIT	STD. PKG. STOCK AVAILABILITY / PA	LEAD TIME	MIN. ORD.	A	C	
280023086		EA	200PR 10FT STUB	3	1			
N		Filled.						
280022831		EA	200PR 10FT STUB	3	1			
N								
280022849		EA	200PR 15FT STUB	3	1			
N								
280023094		EA	200PR 15FT STUB	3	1			
N		Filled.						
280023102		EA	200PR 20FT STUB					
1955302	1	IL IN MI OH WI	15 15 15					
		Filled.						
280048265		EA	250PR 10FT STUB	3	1			
N		Filled.						
280048257		EA	250PR 10FT STUB	3	1			
N								
280048281		EA	250PR 15FT STUB	3	1			
N		Filled.						
280048273		EA	250PR 15FT STUB	3	1			
N								
280048299		EA	250PR 20FT STUB	3	1			
N								
280048307		EA	250PR 20FT STUB	3	1			
N		Filled.						
280023110		EA	300PR 10FT STUB	3	1			
N		Filled.						
280022864		EA	300PR 10FT STUB	3	1			
N								
280023128		EA	300PR 15FT STUB	3	1			
N		Filled.						
280022872		EA	300PR 15FT STUB	3	1			
N								
280023136		EA	300PR 20FT STUB					
1955294	1	IL IN MI OH WI	15 15 15					
		Filled.						
280048323		EA	350PR 10FT STUB	3	1			
N		Filled.						
280048315		EA	350PR 10FT STUB	3	1			
N								

PRODUCT IDENTIFIER		DESCRIPTION						
ITEM NUMBER	ORD. MULT.	SELL UNIT	STD. PKG. STOCK AVAILABILITY / PA	LEAD TIME	MIN. ORD.	A	C	
280048349		EA	350PR 15FT STUB	3	1			
N		Filled.						
280048331		EA	350PR 15FT STUB	3	1			
N								
280048364		EA	350PR 20FT STUB	3	1			
N		Filled.						
280048356		EA	350PR 20FT STUB	3	1			
N								
280048372		EA	400PR 10FT STUB	3	1			
N								
280048380		EA	400PR 10FT STUB	3	1			
N		Filled.						
280048398		EA	400PR 15FT STUB	3	1			
N								
280048406		EA	400PR 15FT STUB	3	1			
N		Filled.						
280048414		EA	400PR 20FT STUB	3	1			
N								
280048422		EA	400PR 20FT STUB					
1955286	1	IL IN MI OH WI	15 15 15					
		Filled.						
280023144		EA	450PR 10FT STUB	4	1			
N		Filled.						
280022906		EA	450PR 10FT STUB	4	1			
N								
280023151		EA	450PR 15FT STUB	4	1			
N		Filled.						
280022914		EA	450PR 15FT STUB	4	1			
N								
280023169		EA	450PR 20FT STUB	4	1			
N		Filled.						
280048448		EA	500PR 10FT STUB	3	1			
N		Filled.						
280048430		EA	500PR 10FT STUB	3	1			
N								
280048463		EA	500PR 15FT STUB	3	1			
N		Filled.						

DISTRIBUTION SERVICES
 NETWORK SERVICES
 TOOLS
 BUILDING JANITORIAL
 AUTOMOTIVE
 FORMS/OFFICE SUPPLIES
 GENERAL
 DATA VOICE

PRODUCT IDENTIFIER		DESCRIPTION					MIN. ORD.	A
ITEM NUMBER	ORD. MULT.	SELL UNIT	STD. PKG. STOCK	PKG. AVAILABILITY	LEAD TIME / PA	ORD.	C	
280048455		CASE COIL 662	500PR	15FT	STUB			
N		EA	1	3		1		
280048489		CASE COIL 662	500PR	20FT	STUB			
N		EA	1	3		1		
		Filled.						
280048505		CASE COIL 662	550PR	10FT	STUB			
N		EA	1	3		1		
		Filled.						
280048497		CASE COIL 662	550PR	10FT	STUB			
N		EA	1	3		1		
280048521		CASE COIL 662	550PR	15FT	STUB			
N		EA	1	3		1		
		Filled.						
280048513		CASE COIL 662	550PR	15FT	STUB			
N		EA	1	3		1		
280048539		CASE COIL 662	550PR	20FT	STUB			
N		EA	1	3		1		
280048547		CASE COIL 662	550PR	20FT	STUB			
N		EA	1	3		1		
		Filled.						
280022948		CASE COIL 662	600PR	15FT	STUB			
N		EA	1	4		1		
280023185		CASE COIL 662	600PR	15FT	STUB			
N		EA	1	4		1		
		Filled.						
280023193		CASE COIL 662	600PR	20FT	STUB			
1955278	1	EA	IL	IN	MI	OH	WI	
			15	15	15		15	
		Filled.						
280048554		CASE COIL 662	700PR	10FT	STUB			
N		EA	1	3		1		
280048562		CASE COIL 662	700PR	10FT	STUB			
N		EA	1	3		1		
		Filled.						
280048570		CASE COIL 662	700PR	15FT	STUB			
N		EA	1	3		1		
280048588		CASE COIL 662	700PR	15FT	STUB			
N		EA	1	3		1		
		Filled.						
280048604		CASE COIL 662	700PR	20FT	STUB			
N		EA	1	3		1		
		Filled.						
280048596		CASE COIL 662	700PR	20FT	STUB			
N		EA	1	3		1		
260367628		CASE COIL 662	750PR	20FT	STUB			
1955260	1	EA	IL	IN	MI	OH	WI	
			15	15	15		15	
		Filled.						

PRODUCT IDENTIFIER		DESCRIPTION					MIN. ORD.	A
ITEM NUMBER	ORD. MULT.	SELL UNIT	STD. PKG. STOCK	PKG. AVAILABILITY	LEAD TIME / PA	ORD.	C	
280048612		CASE COIL 662	800PR	10FT	STUB			
N		EA	1	3		1		
280048620		CASE COIL 662	800PR	10FT	STUB			
N		EA	1	3		1		
		Filled.						
280048646		CASE COIL 662	800PR	15FT	STUB			
N		EA	1	3		1		
		Filled.						
280048638		CASE COIL 662	800PR	15FT	STUB			
N		EA	1	3		1		
280048661		CASE COIL 662	800PR	20FT	STUB			
N		EA	1	3		1		
		Filled.						
280048653		CASE COIL 662	800PR	20FT	STUB			
N		EA	1	3		1		
280023235		CASE COIL 662	900PR	10FT	STUB			
N		EA	1	4		1		
		Filled.						
280022997		CASE COIL 662	900PR	10FT	STUB			
N		EA	1	4		1		
280023003		CASE COIL 662	900PR	15FT	STUB			
N		EA	1	4		1		
280023243		CASE COIL 662	900PR	15FT	STUB			
N		EA	1	4		1		
		Filled.						
280023250		CASE COIL 662	900PR	20FT	STUB			
1955252	1	EA	IL	IN	MI	OH	WI	
			15	15	15		15	
		Filled.						
280048687		CASE COIL 662	1100PR	10FT	STUB			
N		EA	1	3		1		
		Filled.						
280048679		CASE COIL 662	1100PR	10FT	STUB			
N		EA	1	3		1		
280048695		CASE COIL 662	1100PR	15FT	STUB			
N		EA	1	3		1		
280048703		CASE COIL 662	1100PR	15FT	STUB			
N		EA	1	3		1		
		Filled.						
280048729		CASE COIL 662	1100PR	20FT	STUB			
N		EA	1	3		1		
280048711		CASE COIL 662	1100PR	20FT	STUB			
N		EA	1	4		1		
280048745		CASE COIL 662	1200PR	10FT	STUB			
N		EA	1	4		1		
		Filled.						

DISTRIBUTION SERVICES
 NETWORK SERVICES
 TOOLS
 BUILDING JANITORIAL
 AUTOMOTIVE
 FORMS/OFFICE SUPPLIES
 GENERAL
 DATA VOICE

CASE COIL 662

PRODUCT IDENTIFIER		DESCRIPTION					
ITEM NUMBER	ORD. MULT.	SELL UNIT	STD. PKG. STOCK AVAILABILITY / PA	LEAD TIME	MIN. ORD.	A C	

280048737		CASE	COIL 662	1200PR	10FT	STUB
N		EA	1	4	1	
280048760		CASE	COIL 662	1200PR	15FT	STUB
N		EA	1	4	1	
		Filled.				
280048752		CASE	COIL 662	1200PR	15FT	STUB
N		EA	1	4	1	
280048778		CASE	COIL 662	1200PR	20FT	STUB
N		EA	1	4	1	
280048786		CASE	COIL 662	1200PR	20FT	STUB
1955245	1	EA	IL IN MI OH WI	15	15	
		Filled.				

CASE COIL 902

OHIO ORDER ITEM ONLY.						
ITEM NUMBER	ORD. MULT.	SELL UNIT	STD. PKG. STOCK AVAILABILITY / PA	LEAD TIME	MIN. ORD.	A C
260339916		CASE	COIL 902	25PR	10FT	STUB
N		EA	1	3	1	
260340542		CASE	COIL 902	25PR	10FT	STUB
N		EA	1	3	1	
		Filled.				
260339924		CASE	COIL 902	25PR	15FT	STUB
N		EA	1	3	1	
260340559		CASE	COIL 902	25PR	15FT	STUB
N		EA	1	3	1	
		Filled.				
260340567		CASE	COIL 902	25PR	20FT	STUB
N		EA	1	3	1	
		Filled.				
260339932		CASE	COIL 902	25PR	20FT	STUB
N		EA	1	3	1	
260340575		CASE	COIL 902	50PR	10FT	STUB
N		EA	1	3	1	
		Filled.				
260339940		CASE	COIL 902	50PR	10FT	STUB
N		EA	1	3	1	
260340583		CASE	COIL 902	50PR	15FT	STUB
N		EA	1	3	1	
		Filled.				
260339957		CASE	COIL 902	50PR	15FT	STUB
N		EA	1	3	1	
260339965		CASE	COIL 902	50PR	20FT	STUB
N		EA	1	3	1	
260340591		CASE	COIL 902	50PR	20FT	STUB
N		EA	1	3	1	
		Filled.				

PRODUCT IDENTIFIER		DESCRIPTION					
ITEM NUMBER	ORD. MULT.	SELL UNIT	STD. PKG. STOCK AVAILABILITY / PA	LEAD TIME	MIN. ORD.	A C	

260339973		CASE	COIL 902	75PR	10FT	STUB
N		EA	1	3	1	
260340609		CASE	COIL 902	75PR	10FT	STUB
N		EA	1	3	1	
		Filled.				
260340617		CASE	COIL 902	75PR	15FT	STUB
N		EA	1	3	1	
		Filled.				
260339981		CASE	COIL 902	75PR	15FT	STUB
N		EA	1	3	1	
260340625		CASE	COIL 902	75PR	20FT	STUB
N		EA	1	3	1	
		Filled.				
260339999		CASE	COIL 902	75PR	20FT	STUB
N		EA	1	3	1	
260340633		CASE	COIL 902	100PR	10FT	STUB
N		EA	1	3	1	
		Filled.				
260340005		CASE	COIL 902	100PR	10FT	STUB
N		EA	1	3	1	
260340013		CASE	COIL 902	100PR	15FT	STUB
N		EA	1	3	1	
260340641		CASE	COIL 902	100PR	15FT	STUB
N		EA	1	3	1	
		Filled.				
260340021		CASE	COIL 902	100PR	20FT	STUB
N		EA	1	3	1	
260340658		CASE	COIL 902	100PR	20FT	STUB
N		EA	1	3	1	
		Filled.				
260340666		CASE	COIL 902	150PR	10FT	STUB
N		EA	1	3	1	
		Filled.				
260340039		CASE	COIL 902	150PR	10FT	STUB
N		EA	1	3	1	
260340674		CASE	COIL 902	150PR	15FT	STUB
N		EA	1	3	1	
		Filled.				
260340047		CASE	COIL 902	150PR	15FT	STUB
N		EA	1	3	1	
260340682		CASE	COIL 902	150PR	20FT	STUB
N		EA	1	3	1	
		Filled.				
260340054		CASE	COIL 902	150PR	20FT	STUB
N		EA	1	3	1	

PRODUCT IDENTIFIER							DESCRIPTION						
ITEM NUMBER	ORD. MULT.	SELL UNIT	STD. PKG.	LEAD TIME	MIN. ORD.	A C	ITEM NUMBER	ORD. MULT.	SELL UNIT	STD. PKG.	LEAD TIME	MIN. ORD.	A C
							STOCK AVAILABILITY / PA						
260340062		EA	1	3	1		260340062		EA	1	3	1	
N							N						
FILLED													
260340690		EA	1	3	1		260340690		EA	1	3	1	
N							N						
FILLED													
260340070		EA	1	3	1		260340070		EA	1	3	1	
N							N						
FILLED													
260340708		EA	1	3	1		260340708		EA	1	3	1	
N							N						
FILLED													
260340716		EA	1	3	1		260340716		EA	1	3	1	
N							N						
FILLED													
260340088		EA	1	3	1		260340088		EA	1	3	1	
N							N						
FILLED													
260340724		EA	1	3	1		260340724		EA	1	3	1	
N							N						
FILLED													
260340096		EA	1	3	1		260340096		EA	1	3	1	
N							N						
FILLED													
260340732		EA	1	3	1		260340732		EA	1	3	1	
N							N						
FILLED													
260340104		EA	1	3	1		260340104		EA	1	3	1	
N							N						
FILLED													
260340112		EA	1	3	1		260340112		EA	1	3	1	
N							N						
FILLED													
260340740		EA	1	3	1		260340740		EA	1	3	1	
N							N						
FILLED													
260340120		EA	1	3	1		260340120		EA	1	3	1	
N							N						
FILLED													
260340757		EA	1	3	1		260340757		EA	1	3	1	
N							N						
FILLED													
260340765		EA	1	3	1		260340765		EA	1	3	1	
N							N						
FILLED													
260340138		EA	1	3	1		260340138		EA	1	3	1	
N							N						
FILLED													
260340773		EA	1	3	1		260340773		EA	1	3	1	
N							N						
FILLED													
260340146		EA	1	3	1		260340146		EA	1	3	1	
N							N						
FILLED													

PRODUCT IDENTIFIER							DESCRIPTION						
ITEM NUMBER	ORD. MULT.	SELL UNIT	STD. PKG.	LEAD TIME	MIN. ORD.	A C	ITEM NUMBER	ORD. MULT.	SELL UNIT	STD. PKG.	LEAD TIME	MIN. ORD.	A C
							STOCK AVAILABILITY / PA						
260340781		EA	1	3	1		260340781		EA	1	3	1	
N							N						
FILLED													
260340153		EA	1	3	1		260340153		EA	1	3	1	
N							N						
FILLED													
260340161		EA	1	3	1		260340161		EA	1	3	1	
N							N						
FILLED													
260340799		EA	1	3	1		260340799		EA	1	3	1	
N							N						
FILLED													
260340179		EA	1	3	1		260340179		EA	1	3	1	
N							N						
FILLED													
260340807		EA	1	3	1		260340807		EA	1	3	1	
N							N						
FILLED													
260340815		EA	1	3	1		260340815		EA	1	3	1	
N							N						
FILLED													
260340187		EA	1	3	1		260340187		EA	1	3	1	
N							N						
FILLED													
260340823		EA	1	3	1		260340823		EA	1	3	1	
N							N						
FILLED													
260340195		EA	1	3	1		260340195		EA	1	3	1	
N							N						
FILLED													
260340203		EA	1	3	1		260340203		EA	1	3	1	
N							N						
FILLED													
260340849		EA	1	3	1		260340849		EA	1	3	1	
N							N						
FILLED													
260340211		EA	1	3	1		260340211		EA	1	3	1	
N							N						
FILLED													
260340864		EA	1	3	1		260340864		EA	1	3	1	
N							N						
FILLED													
260340237		EA	1	3	1		260340237		EA	1	3	1	
N							N						
FILLED													
260340872		EA	1	3	1		260340872		EA	1	3	1	
N							N						
FILLED													
260340245		EA	1	3	1		260340245		EA	1	3	1	
N							N						
FILLED													
260340252		EA	1	3	1		260340252		EA	1	3	1	
N							N						
FILLED													

DISTRIBUTION SERVICES

NETWORK SERVICES

TOOLS

BUILDING JANITORIAL

AUTOMOTIVE

FORMS/OFFICE SUPPLIES

GENERAL

DATA VOICE

CASE COIL 902

DISTRIBUTION SERVICES

ITEM NUMBER	ORD. MULT.	SELL UNIT	DESCRIPTION		MIN. ORD.	A C
			STD. PKG. STOCK AVAILABILITY / PA	LEAD TIME		
260340880			CASE COIL 902	500PR 15FT STUB		
N		EA	1	3	1	
			Filled.			
260340260			CASE COIL 902	500PR 20FT STUB		
N		EA	1	3	1	
260340898			CASE COIL 902	500PR 20FT STUB		
N		EA	1	3	1	
			Filled.			
260340906			CASE COIL 902	550PR 10FT STUB		
N		EA	1	3	1	
			Filled.			
260340278			CASE COIL 902	550PR 10FT STUB		
N		EA	1	3	1	
260340914			CASE COIL 902	550PR 15FT STUB		
N		EA	1	3	1	
			Filled.			
260340286			CASE COIL 902	550PR 15FT STUB		
N		EA	1	3	1	
260340922			CASE COIL 902	550PR 20FT STUB		
N		EA	1	3	1	
			Filled.			
260340294			CASE COIL 902	550PR 20FT STUB		
N		EA	1	3	1	
260340302			CASE COIL 902	600PR 10FT STUB		
N		EA	1	3	1	
260340930			CASE COIL 902	600PR 10FT STUB		
N		EA	1	3	1	
			Filled.			
260340310			CASE COIL 902	600PR 15FT STUB		
N		EA	1	3	1	
260340948			CASE COIL 902	600PR 15FT STUB		
N		EA	1	3	1	
			Filled.			
260340955			CASE COIL 902	600PR 20FT STUB		
N		EA	1	3	1	
			Filled.			
260340328			CASE COIL 902	600PR 20FT STUB		
N		EA	1	3	1	
260340963			CASE COIL 902	700PR 10FT STUB		
N		EA	1	3	1	
			Filled.			
260340336			CASE COIL 902	700PR 10FT STUB		
N		EA	1	3	1	
260340971			CASE COIL 902	700PR 15FT STUB		
N		EA	1	3	1	
			Filled.			

NETWORK SERVICES

TOOLS

BUILDING JANITORIAL

AUTOMOTIVE

FORMS/OFFICE SUPPLIES

GENERAL

DATA VOICE

ITEM NUMBER	ORD. MULT.	SELL UNIT	DESCRIPTION		MIN. ORD.	A C
			STD. PKG. STOCK AVAILABILITY / PA	LEAD TIME		
260340344			CASE COIL 902	700PR 15FT STUB		
N		EA	1	3	1	
260340351			CASE COIL 902	700PR 20FT STUB		
N		EA	1	3	1	
260340989			CASE COIL 902	700PR 20FT STUB		
N		EA	1	3	1	
			Filled.			
260340369			CASE COIL 902	800PR 10FT STUB		
N		EA	1	3	1	
260341029			CASE COIL 902	800PR 10FT STUB		
N		EA	1	3	1	
			Filled.			
260341037			CASE COIL 902	800PR 15FT STUB		
N		EA	1	3	1	
			Filled.			
260340377			CASE COIL 902	800PR 15FT STUB		
N		EA	1	3	1	
260341045			CASE COIL 902	800PR 20FT STUB		
N		EA	1	3	1	
			Filled.			
260340385			CASE COIL 902	800PR 20FT STUB		
N		EA	1	3	1	
260341052			CASE COIL 902	900PR 10FT STUB		
N		EA	1	3	1	
			Filled.			
260340393			CASE COIL 902	900PR 10FT STUB		
N		EA	1	3	1	
260340401			CASE COIL 902	900PR 15FT STUB		
N		EA	1	3	1	
260341060			CASE COIL 902	900PR 15FT STUB		
N		EA	1	3	1	
			Filled.			
260340419			CASE COIL 902	900PR 20FT STUB		
N		EA	1	3	1	
260341078			CASE COIL 902	900PR 20FT STUB		
N		EA	1	3	1	
			Filled.			
260341086			CASE COIL 902	1200PR 10FT STUB		
N		EA	1	3	1	
			Filled.			
260340427			CASE COIL 902	1200PR 10FT STUB		
N		EA	1	3	1	
260341094			CASE COIL 902	1200PR 15FT STUB		
N		EA	1	3	1	
			Filled.			

PRODUCT IDENTIFIER		DESCRIPTION				
ITEM NUMBER	ORD. MULT.	SELL UNIT	STD. PKG. STOCK AVAILABILITY / PA	LEAD TIME	MIN. ORD.	A C
260340435		CASE	COIL 902 1200PR 15FT STUB			
N		EA	1	3	1	
260341102		CASE	COIL 902 1200PR 20FT STUB			
N		EA	1	3	1	
		Filled.				
260340443		CASE	COIL 902 1200PR 20FT STUB			
N		EA	1	3	1	

CASE CS902

OHIO ORDER ITEM ONLY.

260351473		CASE CS902	25 10FT W/MH BKT			
N		EA	1	3	1	
		662				
260351499		CASE CS902	25 10FT W/MH BKT FIL			
N		EA	1	3	1	
		662				
260351481		CASE CS902	25 10FT W/PM BKT			
N		EA	1	3	1	
		662				
260351507		CASE CS902	25 10FT W/PM BKT FIL			
N		EA	1	3	1	
		662				
260351515		CASE CS902	25 15FT W/MH BKT			
N		EA	1	3	1	
		662				
260351531		CASE CS902	25 15FT W/MH BKT FIL			
N		EA	1	3	1	
		662				
260351523		CASE CS902	25 15FT W/PM BKT			
N		EA	1	3	1	
		662				
260351549		CASE CS902	25 15FT W/PM BKT FIL			
N		EA	1	3	1	
		662				
260351556		CASE CS902	25 20FT W/MH BKT			
N		EA	1	3	1	
		662				
260351572		CASE CS902	25 20FT W/MH BKT FIL			
N		EA	1	3	1	
		662				
260351564		CASE CS902	25 20FT W/PM BKT			
N		EA	1	3	1	
		662				
260351580		CASE CS902	25 20FT W/PM BKT FIL			
N		EA	1	3	1	
		662				
260351598		CASE CS902	50 10FT W/MH BKT			
N		EA	1	3	1	
		662				

PRODUCT IDENTIFIER		DESCRIPTION				
ITEM NUMBER	ORD. MULT.	SELL UNIT	STD. PKG. STOCK AVAILABILITY / PA	LEAD TIME	MIN. ORD.	A C
260351614		CASE CS902	50 10FT W/MH BKT FIL			
N		EA	1	3	1	
		662				
260351606		CASE CS902	50 10FT W/PM BKT			
N		EA	1	3	1	
		662				
260351622		CASE CS902	50 10FT W/PM BKT FIL			
N		EA	1	3	1	
		662				

260351630		CASE CS902	50 15FT W/MH BKT			
N		EA	1	3	1	
		662				
260351655		CASE CS902	50 15FT W/MH BKT FIL			
N		EA	1	3	1	
		662				
260351648		CASE CS902	50 15FT W/PM BKT			
N		EA	1	3	1	
		662				
260351663		CASE CS902	50 15FT W/PM BKT FIL			
N		EA	1	3	1	
		662				
260351671		CASE CS902	50 20FT W/MH BKT			
N		EA	1	3	1	
		662				
260351697		CASE CS902	50 20FT W/MH BKT FIL			
N		EA	1	3	1	
		662				
260351689		CASE CS902	50 20FT W/PM BKT			
N		EA	1	3	1	
		662				
260351705		CASE CS902	50 20FT W/PM BKT FIL			
N		EA	1	3	1	
		662				
260351713		CASE CS902	75 10FT W/MH BKT			
N		EA	1	3	1	
		662				
260351739		CASE CS902	75 10FT W/MN BKT FIL			
N		EA	1	3	1	
		662				
260351721		CASE CS902	75 10FT W/PM BKT			
N		EA	1	3	1	
		662				
260351747		CASE CS902	75 10FT W/PM BKT FIL			
N		EA	1	3	1	
		662				
260351754		CASE CS902	75 15FT W/MH BKT			
N		EA	1	3	1	
		662				

DISTRIBUTION SERVICES

NETWORK SERVICES

TOOLS

BUILDING JANITORIAL

AUTOMOTIVE

FORMS/OFFICE SUPPLIES

GENERAL

DATA VOICE

CASE CS902

DISTRIBUTION SERVICES

PRODUCT IDENTIFIER DESCRIPTION

ITEM	ORD.	SELL	STD. PKG.	LEAD TIME	MIN.	A
NUMBER	MULT.	UNIT	STOCK AVAILABILITY / PA		ORD.	C

260351770	N	EA	75	15FT W/MH BKT FIL	1	3	1
		662	1				

260351762	N	EA	75	15FT W/PM BKT	1	3	1
		662	1				

260351788	N	EA	75	15FT W/PM BKT FIL	1	3	1
		662	1				

260351796	N	EA	75	20FT W/MH BKT	1	3	1
		662	1				

260351812	N	EA	75	20FT W/MH BKT FIL	1	3	1
		662	1				

260351804	N	EA	75	20FT W/PM BKT	1	3	1
		662	1				

260351820	N	EA	75	20FT W/PM BKT FIL	1	3	1
		662	1				

260351838	N	EA	100	10FT W/MH BKT	1	3	1
		662	1				

260351853	N	EA	100	10FT W/MH BKT FIL	1	3	1
		662	1				

260351846	N	EA	100	10FT W/PM BKT	1	3	1
		662	1				

260351861	N	EA	100	10FT W/PM BKT FIL	1	3	1
		662	1				

260351879	N	EA	100	15FT W/MH BKT	1	3	1
		662	1				

260351895	N	EA	100	15FT W/MH BKT FIL	1	3	1
		662	1				

260351887	N	EA	100	15FT W/PM BKT	1	3	1
		662	1				

260351903	N	EA	100	15FT W/PM BKT FIL	1	3	1
		662	1				

260351911	N	EA	100	20FT W/MH BKT	1	3	1
		662	1				

NETWORK SERVICES

TOOLS

BUILDING JANITORIAL

AUTOMOTIVE

FORMS/OFFICE SUPPLIES

GENERAL

DATA VOICE

PRODUCT IDENTIFIER DESCRIPTION

ITEM	ORD.	SELL	STD. PKG.	LEAD TIME	MIN.	A
NUMBER	MULT.	UNIT	STOCK AVAILABILITY / PA		ORD.	C

260351937	N	EA	100	20FT W/MH BKT FIL	1	3	1
		662	1				

260351929	N	EA	100	20FT W/PM BKT	1	3	1
		662	1				

260351945	N	EA	100	20FT W/PM BKT FIL	1	3	1
		662	1				

260351952	N	EA	150	10FT W/MH BKT	1	3	1
		662	1				

260351978	N	EA	150	10FT W/MN BKT FIL	1	3	1
		662	1				

260351986	N	EA	150	10FT W/PM BKT FIL	1	3	1
		662	1				

260351994	N	EA	150	15FT W/MH BKT	1	3	1
		662	1				

260352018	N	EA	150	15FT W/MH BKT FIL	1	3	1
		662	1				

260352000	N	EA	150	15FT W/PM BKT	1	3	1
		662	1				

260352026	N	EA	150	15FT W/PM BKT FIL	1	3	1
		662	1				

260352034	N	EA	150	20FT W/MH BKT	1	3	1
		662	1				

260352059	N	EA	150	20FT W/MH BKT FIL	1	3	1
		662	1				

260352042	N	EA	150	20FT W/PM BKT	1	3	1
		662	1				

260352067	N	EA	150	20FT W/PM BKT FIL	1	3	1
		662	1				

260352075	N	EA	200	10FT W/MH BKT	1	3	1
		662	1				

260352091	N	EA	200	10FT W/MH BKT FIL	1	3	1
		662	1				

PRODUCT IDENTIFIER DESCRIPTION						
ITEM NUMBER	ORD. MULT.	SELL UNIT	STD. PKG. STOCK AVAILABILITY / PA	LEAD TIME	MIN. ORD.	A C
260352083		CASE	CS902 200 10FT W/PM BKT			
N		EA	1	3	1	
	662					
260352109		CASE	CS902 200 10FT W/PM BKT FIL			
N		EA	1	3	1	
	662					
260352117		CASE	CS902 200 15FT W/MH BKT			
N		EA	1	3	1	
	662					
260352133		CASE	CS902 200 15FT W/MH BKT FIL			
N		EA	1	3	1	
	662					
260352125		CASE	CS902 200 15FT W/PM BKT			
N		EA	1	3	1	
	662					
260352141		CASE	CS902 200 15FT W/PM BKT FIL			
N		EA	1	3	1	
	662					
260352158		CASE	CS902 200 20FT W/MH BKT			
N		EA	1	3	1	
	662					
260352174		CASE	CS902 200 20FT W/MH BKT FIL			
N		EA	1	3	1	
	662					
260352166		CASE	CS902 200 20FT W/PM BKT			
N		EA	1	3	1	
	662					
260352182		CASE	CS902 200 20FT W/PM BKT FIL			
N		EA	1	3	1	
	662					
260352190		CASE	CS902 300 10FT W/MH BKT			
N		EA	1	3	1	
	662					
260352216		CASE	CS902 300 10FT W/MH BKT FIL			
N		EA	1	3	1	
	662					
260352208		CASE	CS902 300 10FT W/PM BKT			
N		EA	1	3	1	
	662					
260352224		CASE	CS902 300 10FT W/PM BKT FIL			
N		EA	1	3	1	
	662					
260352232		CASE	CS902 300 15FT W/MH BKT			
N		EA	1	3	1	
	662					
260352257		CASE	CS902 300 15FT W/MH BKT FIL			
N		EA	1	3	1	
	662					

PRODUCT IDENTIFIER DESCRIPTION						
ITEM NUMBER	ORD. MULT.	SELL UNIT	STD. PKG. STOCK AVAILABILITY / PA	LEAD TIME	MIN. ORD.	A C
260352240		CASE	CS902 300 15FT W/PM BKT			
N		EA	1	3	1	
	662					
260352265		CASE	CS902 300 15FT W/PM BKT FIL			
N		EA	1	3	1	
	662					
260352273		CASE	CS902 300 20FT W/MH BKT			
N		EA	1	3	1	
	662					
260352299		CASE	CS902 300 20FT W/MH BKT FIL			
N		EA	1	3	1	
	662					
260352281		CASE	CS902 300 20FT W/PM BKT			
N		EA	1	3	1	
	662					
260352307		CASE	CS902 300 20FT W/PM BKT FIL			
N		EA	1	3	1	
	662					
260352315		CASE	CS902 400 10FT W/MH BKT			
N		EA	1	3	1	
	662					
260352331		CASE	CS902 400 10FT W/MH BKT FIL			
N		EA	1	3	1	
	662					
260352323		CASE	CS902 400 10FT W/PM BKT			
N		EA	1	3	1	
	662					
260352349		CASE	CS902 400 10FT W/PM BKT FIL			
N		EA	1	3	1	
	662					
260352356		CASE	CS902 400 15FT W/MH BKT			
N		EA	1	3	1	
	662					
260352372		CASE	CS902 400 15FT W/MH BKT FIL			
N		EA	1	3	1	
	662					
260352364		CASE	CS902 400 15FT W/PM BKT			
N		EA	1	3	1	
	662					
260352380		CASE	CS902 400 15FT W/PM BKT FIL			
N		EA	1	3	1	
	662					
260352398		CASE	CS902 400 20FT W/MH BKT			
N		EA	1	3	1	
	662					
260352406		CASE	CS902 400 20FT W/PM BKT			
N		EA	1	3	1	
	662					

DISTRIBUTION SERVICES

NETWORK SERVICES

TOOLS

BUILDING JANITORIAL

AUTOMOTIVE

FORMS/OFFICE SUPPLIES

GENERAL

DATA VOICE

CASE CS902

DISTRIBUTION SERVICES

PRODUCT IDENTIFIER		DESCRIPTION					
ITEM NUMBER	ORD. MULT.	SELL UNIT	STD. PKG. STOCK AVAILABILITY / PA	LEAD TIME	MIN. ORD.	A C	
260352430		CASE	CS902	450 10FT W/MH BKT			
N		EA	1	3	1		
	662						
260352455		CASE	CS902	450 10FT W/MH BKT FIL			
N		EA	1	3	1		
	662						
260352448		CASE	CS902	450 10FT W/PM BKT			
N		EA	1	3	1		
	662						
260352463		CASE	CS902	450 10FT W/PM BKT FIL			
N		EA	1	3	1		
	662						
260352513		CASE	CS902	450 20FT W/MH BKT			
N		EA	1	3	1		
	662						
260352539		CASE	CS902	450 20FT W/MH BKT FIL			
N		EA	1	3	1		
	662						
260352521		CASE	CS902	450 20FT W/PM BKT			
N		EA	1	3	1		
	662						
260352547		CASE	CS902	450 20FT W/PM BKT FIL			
N		EA	1	3	1		
	662						
260352679		CASE	CS902	600 10FT W/MH BKT			
N		EA	1	3	1		
	662						
260352695		CASE	CS902	600 10FT W/MH BKT FIL			
N		EA	1	3	1		
	662						
260352687		CASE	CS902	600 10FT W/PM BKT			
N		EA	1	3	1		
	662						
260352703		CASE	CS902	600 10FT W/PM BKT FIL			
N		EA	1	3	1		
	662						
260352711		CASE	CS902	600 15FT W/MH BKT			
N		EA	1	3	1		
	662						
260352737		CASE	CS902	600 15FT W/MH BKT FIL			
N		EA	1	3	1		
	662						
260352729		CASE	CS902	600 15FT W/PM BKT			
N		EA	1	3	1		
	662						
260352745		CASE	CS902	600 15FT W/PM BKT FIL			
N		EA	1	3	1		
	662						

NETWORK SERVICES

TOOLS

BUILDING JANITORIAL

AUTOMOTIVE

FORMS/OFFICE SUPPLIES

GENERAL

DATA VOICE

PRODUCT IDENTIFIER		DESCRIPTION					
ITEM NUMBER	ORD. MULT.	SELL UNIT	STD. PKG. STOCK AVAILABILITY / PA	LEAD TIME	MIN. ORD.	A C	
260352752		CASE	CS902	600 20FT W/MH BKT			
N		EA	1	3	1		
	662						
260352778		CASE	CS902	600 20FT W/MH BKT FIL			
N		EA	1	3	1		
	662						
260352760		CASE	CS902	600 20FT W/PM BKT			
N		EA	1	3	1		
	662						
260352786		CASE	CS902	600 20FT W/PM BKT FIL			
N		EA	1	3	1		
	662						
260352919		CASE	CS902	750 10FT W/MH BKT			
N		EA	1	3	1		
	662						
260352935		CASE	CS902	750 10FT W/MH BKT FIL			
N		EA	1	3	1		
	662						
260352927		CASE	CS902	750 10FT W/PM BKT			
N		EA	1	3	1		
	662						
260352943		CASE	CS902	750 10FT W/PM BKT FIL			
N		EA	1	3	1		
	662						
260352950		CASE	CS902	750 15FT W/MH BKT			
N		EA	1	3	1		
	662						
260352976		CASE	CS902	750 15FT W/MH BKT FIL			
N		EA	1	3	1		
	662						
260352968		CASE	CS902	750 15FT W/PM BKT			
N		EA	1	3	1		
	662						
260352984		CASE	CS902	750 15FT W/PM BKT FIL			
N		EA	1	3	1		
	662						
260352992		CASE	CS902	750 20FT W/MH BKT			
N		EA	1	3	1		
	662						
260353016		CASE	CS902	750 20FT W/MH BKT FIL			
N		EA	1	3	1		
	662						
260353008		CASE	CS902	750 20FT W/PM BKT			
N		EA	1	3	1		
	662						
260353024		CASE	CS902	750 20FT W/PM BKT FIL			
N		EA	1	3	1		
	662						

PRODUCT IDENTIFIER		DESCRIPTION				
ITEM NUMBER	ORD. MULT.	SELL UNIT	STD. PKG. STOCK AVAILABILITY / PA	LEAD TIME	MIN. ORD.	A C
260353156	N	EA	900 10FT W/MH BKT	3	1	
		662	1			
260353172	N	EA	900 10FT W/MH BKT FIL	3	1	
		662	1			
260353164	N	EA	900 10FT W/PM BKT	3	1	
		662	1			
260353180	N	EA	900 10FT W/PM BKT FIL	3	1	
		662	1			
260353198	N	EA	900 15FT W/MH BKT	3	1	
		662	1			
260353214	N	EA	900 15FT W/MH BKT FIL	3	1	
		662	1			
260353206	N	EA	900 15FT W/PM BKT	3	1	
		662	1			
260353222	N	EA	900 15FT W/PM BKT FIL	3	1	
		662	1			
260353230	N	EA	900 20FT W/MH BKT	3	1	
		662	1			
260353255	N	EA	900 20FT W/MH BKT FIL	3	1	
		662	1			
260353248	N	EA	900 20FT W/PM BKT	3	1	
		662	1			
260353263	N	EA	900 20FT W/PM BKT FIL	3	1	
		662	1			
260353271	N	EA	1200 10FT W/MH BKT	3	1	
		662	1			
260353297	N	EA	1200 10FT W/MH BKT FIL	3	1	
		662	1			
260353289	N	EA	1200 10FT W/PM BKT	3	1	
		662	1			
260353305	N	EA	1200 10FT W/PM BKT FIL	3	1	
		662	1			

PRODUCT IDENTIFIER		DESCRIPTION				
ITEM NUMBER	ORD. MULT.	SELL UNIT	STD. PKG. STOCK AVAILABILITY / PA	LEAD TIME	MIN. ORD.	A C
260353313	N	EA	1200 15FT W/MH BKT	3	1	
		662	1			
260353339	N	EA	1200 15FT W/MH BKT FIL	3	1	
		662	1			
260353321	N	EA	1200 15FT W/PM BKT	3	1	
		662	1			
260353347	N	EA	1200 15FT W/PM BKT FIL	3	1	
		662	1			
260353354	N	EA	1200 20FT W/MH BKT	3	1	
		662	1			
260353370	N	EA	1200 20FT W/MH BKT FIL	3	1	
		662	1			
260353362	N	EA	1200 20FT W/PM BKT	3	1	
		662	1			
260353388	N	EA	1200 20FT W/PM BKT FIL	3	1	
		662	1			

CASE LOAD COIL

300037744 CASE LOAD COIL 25 662 W/20FT STUB
 5109835 1 EA
 A build out case for use in building out the mutual capacitance and resistance of cable to correct loading section irregularities.

300037751 CASE LOAD COIL 50 662 W/20FT STUB
 5109850 1 EA

IL	IN	MI	OH	WI
15	15	15	15	15

 A build out case for use in building out the mutual capacitance and resistance of cable to correct loading section irregularities.

300037769 CASE LOAD COIL 100 662 W/20FT STUB
 5109876 1 EA

IL	IN	MI	OH	WI
15	15	15	15	15

 A build out case for use in building out the mutual capacitance and resistance of cable to correct loading section irregularities.

300037777 CASE LOAD COIL 200 662 W/20FT STUB
 5109751 1 EA

IL	IN	MI	OH	WI
15	15	15	15	15

 A build out case for use in building out the mutual capacitance and resistance of cable to correct loading section irregularities.

300037785 CASE LOAD COIL 300 662 W/20FT STUB
 5109777 1 EA

IL	IN	MI	OH	WI
15	15	15	15	15

 A build out case for use in building out the mutual capacitance and resistance of cable to correct loading section irregularities.

DISTRIBUTION SERVICES
 NETWORK SERVICES
 TOOLS
 BUILDING JANITORIAL
 AUTOMOTIVE
 FORMS/OFFICE SUPPLIES
 GENERAL
 DATA VOICE

CASE LOAD COIL

PRODUCT IDENTIFIER		DESCRIPTION						
ITEM NUMBER	ORD. MULT.	SELL UNIT	STD. PKG. STOCK AVAILABILITY / PA	LEAD TIME	MIN. ORD.	A	C	

280022922 CASE LOAD COIL 450 662 W/20FT STUB
 1945246 1 EA IL IN MI OH WI
 15 15 15 15 15
 A build out case for use in building out the mutual capacitance and resistance of cable to correct loading section irregularities.

300037793 CASE LOAD COIL 600 662 W/20FT STUB
 5109793 1 EA IL IN MI OH WI
 15 15 15 15 15
 A build out case for use in building out the mutual capacitance and resistance of cable to correct loading section irregularities.

260325634 CASE LOAD COIL 750 662 W/20FT STUB
 1945238 1 EA IL IN MI OH WI
 15 15 15 15 15
 A build out case for use in building out the mutual capacitance and resistance of cable to correct loading section irregularities.

300037801 CASE LOAD COIL 900 662 W/20FT STUB
 5109819 1 EA IL IN MI OH WI
 15 15 15 15 15
 A build out case for use in building out the mutual capacitance and resistance of cable to correct loading section irregularities.

300085347 CASE LOAD COIL LC110
 N EA 1 3 1
 For volt-ohm meter 2806 and 2816. Marsh.

CASE REPEATER

260323696 CASE REPEATER 475J
 1943969 1 EA

260342936 CASE REPEATER 475K
 1949941 1 EA IL IN MI OH WI
 08 08

104391297 CASE REPEATER 809A3
 1935346 1 EA IL IN MI OH WI
 08 08 08 08 08
 Updated version of 809A2 case designed for pole mount installation. It has a 25FT, 52PR ASP sheath filled stub. Designed for digital carrier system with T1 carrier line repeaters.

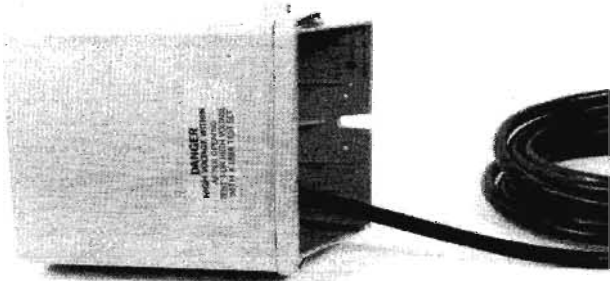

1935346

104391305 CASE REPEATER 809B3
 1935338 1 EA IL IN MI OH WI
 08 08 08 08 08
 Updated version of 809B2 Case designed as a pedestal mounted case. Same stubs and design use as the 809A3 Case.

PRODUCT IDENTIFIER		DESCRIPTION						
ITEM NUMBER	ORD. MULT.	SELL UNIT	STD. PKG. STOCK AVAILABILITY / PA	LEAD TIME	MIN. ORD.	A	C	

260323670 CASE REPEATER 818A1
 1975714 1 EA IL IN MI OH WI
 09
 Consists of a #81A1-1H Repeater case base and a #88A1 repeater case housing. Equipped with a 30FT, 108 PR guard screened plastic stub cable.

103246666 CASE REPEATER 818A2C
 N EA 1 4 1
 Consists of #818A2C repeater case housing and #81A1-1H repeater case base. BSP 640-525-307.

103064077 CASE REPEATER 818C1C
 N EA 1 4 1
 Consists of #81A1-2H repeater case base and #88A1C repeater case housing.

103064085 CASE REPEATER 819A1
 1214015 1 EA IL IN MI OH WI
 08 08 08 08
 Consists of #88A1-1H repeater case base and #89A1C repeater case housing. Has air core stub to be used in pressurized cable. Requires air source and alarm.

103064093 CASE REPEATER 819A1C
 N EA 1 4 1
 BSP 640-525-307.

260323688 CASE REPEATER 819A2
 1943977 1 EA IL IN MI OH WI
 08 08 08 08
 Same as #819A1, but with two #306M connectors added in the switch positions to accommodate two B protectors.

103246674 CASE REPEATER 819A2C PROT
 N EA 1 4 1

103062568 CASE REPEATER 819B1
 1158956 1 EA IL IN MI OH WI
 08 08 08 08
 Repeater case used for high capacity transport service.

103265922 CASE REPEATER 819B2C
 4210377 1 EA IL IN MI OH WI
 08 08 08 08
 Consists of 81B1-1H base and 89B1C housing and can be used for T1, with adapter T1C and T1D.

103064127 CASE REPEATER 819C1C
 N EA 1 4 1
 Consists of #81A1-2H base and #89A1C housing.

104027750 CASE REPEATER 841CP1-025T1
 1333112 1 EA IL IN MI OH WI
 08 08 08 08

104027776 CASE REPEATER 841CP1-050T1
 N EA 1 4 1

104027818 CASE REPEATER 841CP1-100T1
 N EA 1 7 1

DISTRIBUTION SERVICES

NETWORK SERVICES

TOOLS

BUILDING JANITORIAL

AUTOMOTIVE

FORMS/OFFICE SUPPLIES

GENERAL

DATA VOICE

PRODUCT IDENTIFIER		DESCRIPTION					
ITEM NUMBER	ORD. MULT.	SELL UNIT	STD. PKG. STOCK AVAILABILITY / PA	LEAD TIME	MIN. ORD.	A	C
260366786 CASE REPEATER CIAC-1000 SINGLE SLOT							
1955096	1	EA	IL IN MI OH WI 08 08				

CASE SPLICE

100105352 CASE SPLICE 9A							
1166116	1	EA					
Double seal splice case for double sheath cable. Such as PASP or PAP, BSP 633-460-210.							

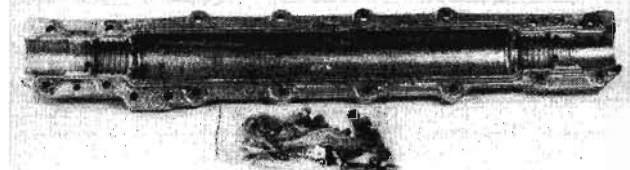

100105352

100105360 CASE SPLICE 10A							
1220178	1	EA	IL IN MI OH WI 08 08				
Double seal splice case for double sheath cable. Such as PASP or PAP, BSP 633-460-210.							

100105378 CASE SPLICE 11A GRAY IRON HALF							
N		EA	3	8		3	

100105386 CASE SPLICE 12A							
1144766	1	EA	IL IN MI OH WI 08 08				
Double seal splice case for double sheath cable. Such as PASP or PAP, BSP 633-460-210.							

100105428 CASE SPLICE 20A2 1.03IN X 1.0IN							
1179358	1	EA	IL IN MI OH WI 08 08 08				
Cast iron, gas tight case for single and lead sheath cable. Used for manholes and buried plant, BSP 633-400-200.							

100105444 CASE SPLICE 20B2 1.10IN X 1.6IN							
1129676	1	EA	IL IN MI OH WI 08 08 08				
Cast iron.							

100105469 CASE SPLICE 20C2 1.70IN X 2.2IN							
1181156	1	EA	IL IN MI OH WI 08 08 08				
Cast iron.							

100105485 CASE SPLICE 20D2 2.30IN X 3.0IN							
1178053	1	EA	IL IN MI OH WI 08 08 08				
Cast iron.							

PRODUCT IDENTIFIER		DESCRIPTION					
ITEM NUMBER	ORD. MULT.	SELL UNIT	STD. PKG. STOCK AVAILABILITY / PA	LEAD TIME	MIN. ORD.	A	C
100105501 CASE SPLICE 21A2 1.03IN X 1.0IN							
1199695	1	EA	IL IN MI OH WI 08 08 08				
Cast iron, gastight case used when two cables enter same end of case. For single and lead sheath cable, used in manholes and buried plant, BSP 633-400-200.							

Cast iron, gastight case used when two cables enter same end of case. For single and lead sheath cable, used in manholes and buried plant, BSP 633-400-200.

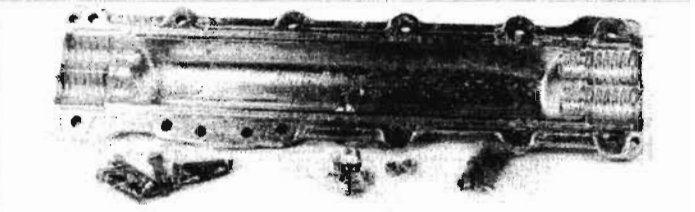

1199695

100105527 CASE SPLICE 21B2 1.10IN X 1.6IN							
1106559	1	EA	IL IN MI OH WI 08 08 08				
Cast iron.							

100105543 CASE SPLICE 21C2 1.70IN X 2.2IN							
1230888	1	EA	IL IN MI OH WI 08 08 08				
Cast iron.							

100105568 CASE SPLICE 21D2 2.30IN X 3.0IN							
1162818	1	EA	IL IN MI OH WI 08 08 08				
Cast iron.							

100105584 CASE SPLICE 30D2 28IN L X 11IN W							
1203810	2	EA	IL IN MI OH WI 08 08 08 08				
Gas tight case for single and lead sheath cable. Used in manholes and buried plant, BSP 633-400-210.							

100105592 CASE SPLICE 31D2 28IN L X 12IN W							
1148254	1	EA	IL IN MI OH WI 08 08 08 08				
Gas tight case used when two cables enter same end of case. For single and lead sheath cable in manholes and buried plant, BSP 633-400-210.							

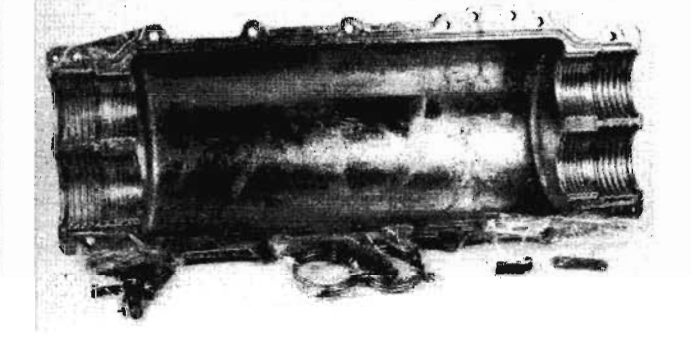

1148254

101413573 CASE SPLICE 41E2 IRON HALF							
N		EA	2	8		2	
NOW AVAILABLE THROUGH TOUCH-TONE ORDER ENTRY.							

DISTRIBUTION SERVICES

NETWORK SERVICES

TOOLS

BUILDING JANITORIAL

AUTOMOTIVE

FORMS/OFFICE SUPPLIES

GENERAL

DATA VOICE

CASE SPLICE

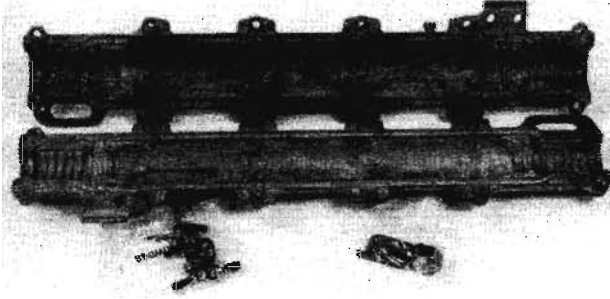
PRODUCT IDENTIFIER		DESCRIPTION				
ITEM NUMBER	ORD. MULT.	SELL UNIT	STD. PKG. STOCK AVAILABILITY / PA	LEAD TIME	MIN. ORD.	A C
100105410 CASE SPLICE ALUMINUM 20A1						
N		EA	144	8	288	
						
100105410						
100105436 CASE SPLICE ALUMINUM 20B1						
N		EA	64	8	128	
100105451 CASE SPLICE ALUMINUM 20C1						
N		EA	56	8	112	
100105477 CASE SPLICE ALUMINUM 20D1						
N		EA	32	8	64	
100105493 CASE SPLICE ALUMINUM 21A1						
N		EA	72	8	144	
100105519 CASE SPLICE ALUMINUM 21B1						
N		EA	40	8	80	
100105535 CASE SPLICE ALUMINUM 21C1						
N		EA	32	8	64	
100105550 CASE SPLICE ALUMINUM 21D1						
N		EA	32	8	64	

CEMENT

400120119 CEMENT C RUBBER 4OZ CA7167						
1127589	1	CN				
For use in splicing alpth sheath cable. E/W applicator, BSP 633-300-202.						
402096473 CEMENT GALLON CA08618						
N						
900193319 CEMENT HYDRAULIC 3LB CONTAINER						
1127647	1	CS	IL IN MI OH WI			
35 35 35 35 35						
For use sealing vacant and occupied ducts in conduit system, BSP 628-220-200.						

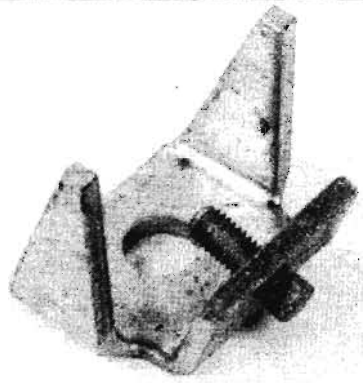
PRODUCT IDENTIFIER		DESCRIPTION				
ITEM NUMBER	ORD. MULT.	SELL UNIT	STD. PKG. STOCK AVAILABILITY / PA	LEAD TIME	MIN. ORD.	A C
CEMENT SOLVENT						
SEE SOLVENT CEMENT.						
CHALK MARKING						
SEE PAINT.						
CHANNEL						
260405477 CHANNEL SD 2X2						
1969808	1	EA				
CHEMICAL CRC						
SEE LUBRICANT.						
CLAMP						
300032042 CLAMP 14-44						
1214577	1	EA				
Used to secure riser pipe to side of building.						
400120879 CLAMP BEAM B CA07433						
1102319	1	EA	IL IN MI OH WI			
08 08 08 08 08						
Used with a 5/8in bolt for dead ending strand on the flange of a structural steel member, BSP 627-610-200.						
						
1102319						

DISTRIBUTION SERVICES
 NETWORK SERVICES
 TOOLS
 BUILDING JANITORIAL
 AUTOMOTIVE
 FORMS/OFFICE SUPPLIES
 GENERAL
 DATA VOICE

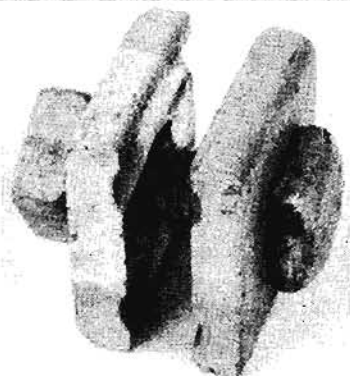
PRODUCT IDENTIFIER		DESCRIPTION						
ITEM NUMBER	ORD. MULT.	SELL UNIT	STD. PKG. STOCK AVAILABILITY / PA	LEAD TIME	MIN. ORD.	A	C	
400120887 CLAMP BEAM C CA07464								
1192690	1	EA	IL 08 IN 08 MI 08 OH 08 WI 08					
Used for intermediate attachments of strand to the flange of a structural member, BSP 627-610-200.								
								
1192690								
900219973 CLAMP BULLDOG 3								
5602201	1	BX	IL 33 IN 12 MI OH WI					
260346838 CLAMP COLLARED CAP 34CC N EA 1 2 1 26-0001-7868-6.								
260322441 CLAMP COLLARED CAP 59CC N EA 1 2 1								
260322433 CLAMP COLLARED CAP 1012CC N EA 1 2 1								
842136061 CLAMP EXTRUDED 200/KIT N KT 1 9 1								
400121315 CLAMP GUY 1 BOLT CA06090								
1128728	1	EA	IL 14 IN 14 MI 14 OH 14 WI 14					
For use with 2200lb strand in guying and cable work, BSP 621-405-201.								
								
1128728								

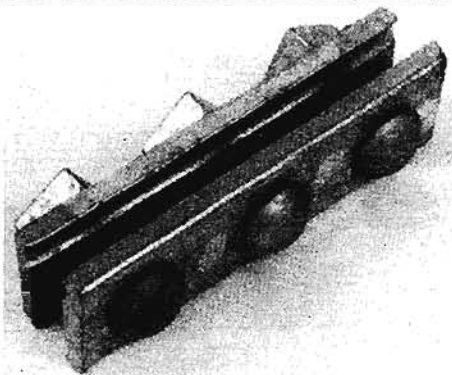
PRODUCT IDENTIFIER		DESCRIPTION						
ITEM NUMBER	ORD. MULT.	SELL UNIT	STD. PKG. STOCK AVAILABILITY / PA	LEAD TIME	MIN. ORD.	A	C	
400762286 CLAMP GUY B CA08624								
2765164	1	EA	IL 14 IN 14 MI 14 OH 14 WI 14					
For use with strand in poleline and aerial cable construction, BSP 621-405-201.								
								
2765164								
104384490 CLAMP HOSE 12A1								
N		EA		1 2 1				
NOW AVAILABLE THROUGH TOUCH-TONE ORDER ENTRY.								
300069002 CLAMP HOSE 12IN DIAMETER MAXIMUM								
5120881	1	EA	IL 58 IN MI OH WI					
Snap-lock, 9/16in wide.								
260344460 CLAMP INDICATOR PRESSURE								
1950410	1	PK	IL 08 IN MI OH WI 08 08					
Package of 10.								
400121364 CLAMP RIBBON BOND CA06567								
1101386	50	EA	IL 08 IN 08 MI 08 OH 08 WI 08					
Bonding ribbon clamps intended for use in attaching plain bonding ribbon to manhole walls and roofs, BSP 638-300-211 & BSP 622-520-100.								
900274598 CLAMP ROD GUY 5/8IN TO 3/4IN								
4119545	1	EA	IL 08 IN 08 MI 08 OH 08 WI 08					
For adding an eye to an existing guy rod, BSP 621-415-217N.								

CLAMP

PRODUCT IDENTIFIER DESCRIPTION

ITEM	ORD.	SELL	STD. PKG.	LEAD TIME	MIN.	A
NUMBER	MULT.	UNIT	STOCK AVAILABILITY / PA		ORD.	C

260391636 CLAMP ROD GUY 7/8IN TO 1IN
 N EA 25 6 25
 NOW AVAILABLE THROUGH TOUCH-TONE ORDER ENTRY.

400121422 CLAMP SLEEVE SPLITTING B
 N EA 30 4 510
 CA07747. Used in closing split sleeves 1in to 3 1/2in in diameter, e/w thumb screw, BSP 081-330-130.

400121430 CLAMP SLEEVE SPLITTING G
 1101402 1 EA IL IN MI OH WI
 16 16 16 16 16
 CA07747. Used to close split lead sleeves 3 1/2in to 8in and to hold them closed until the seam is tacked with solder, BSP 081-330-130.

300085404 CLAMP SNAPLOCK 500-072
 N EA 1 2 23

300085412 CLAMP SNAPLOCK 500-088
 N EA 1 2 13

300085396 CLAMP SNAPLOCK 500-104
 N EA 1 2 13

400324489 CLAMP SPAN E CA08391
 1128967 1 EA IL IN MI OH WI
 08 08 08 08 08
 This span clamp is used on self-supporting cable and suspension strand. A (B) guard must be placed around lashed lead cable when this clamp is used, BSP 462-300-205.

260421276 CLAMP SPAN E JAW
 1974675 5 EA IL IN MI OH WI
 08 08 08 08 08

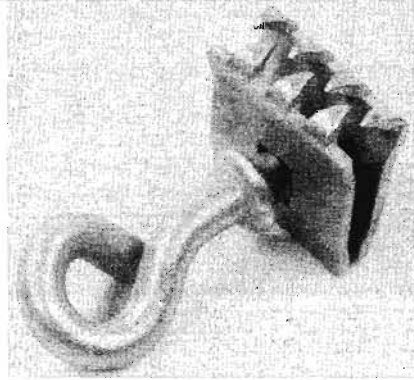

1974675

900329517 CLAMP SUSPENSION CABLE 1
 N EA 100 8 100
 BOLT J1095. NOW AVAILABLE THROUGH TOUCH-TONE ORDER ENTRY.

400762282 CLAMP SUSPENSION CABLE B
 2765180 1 EA IL IN MI OH WI
 08 08 08 08 08
 CA08623. Used to support suspension strand, at all inline poles and at poles where reinforcing links are used, BSP 621-410-200.

PRODUCT IDENTIFIER DESCRIPTION

ITEM	ORD.	SELL	STD. PKG.	LEAD TIME	MIN.	A
NUMBER	MULT.	UNIT	STOCK AVAILABILITY / PA		ORD.	C

400762274 CLAMP SUSPENSION CORNER B
 1129023 1 EA IL IN MI OH WI
 08 08 08 08 08
 CA08625. Used at corners where the pull is 10in to 50in with 6M strands and 5in and 50in with larger sizes of strand, BSP 627-220-200.

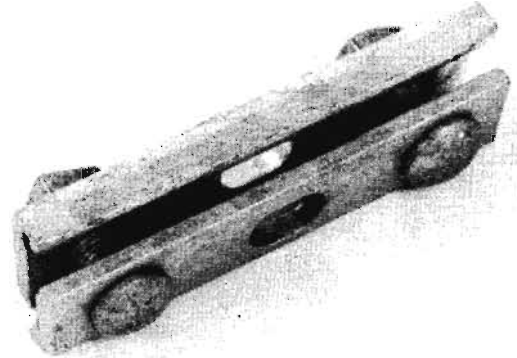

1129023

CLAMP CABLE

402855183 CLAMP CABLE 1 ZINC PACKAGE 10
 1445486 1 PK

400120895 CLAMP CABLE 3 ZINC PACKAGE 50
 1332734 1 PK IL IN MI OH WI
 08 08 08 08 08

400120903 CLAMP CABLE 4 ZINC PACKAGE 50
 1128124 1 PK IL IN MI OH WI
 08 08 08 08 08

400120911 CLAMP CABLE 6 ZINC PACKAGE 50
 1128140 1 PK IL IN MI OH WI
 08 08 08 08 08

400120937 CLAMP CABLE 8 ZINC PACKAGE 50
 1128181 1 PK IL IN MI OH WI
 08 08 08 08 08

400120952 CLAMP CABLE 10 ZINC PACKAGE 25
 1128223 1 PK IL IN MI OH WI
 08 08 08 08 08

400120978 CLAMP CABLE 13 ZINC PACKAGE 20
 1128264 1 PK IL IN MI OH WI
 08 08 08 08 08

400120986 CLAMP CABLE 17 ZINC PACKAGE 25
 1128280 1 PK IL IN MI OH WI
 08 08 08 08 08

400120994 CLAMP CABLE 21 ZINC PACKAGE 10
 1128306 1 PK IL IN MI OH WI
 08 08 08 08 08

400121018 CLAMP CABLE 30 ZINC PACKAGE 10
 1128348 1 PK IL IN MI OH WI
 08 08 08 08 08

DISTRIBUTION SERVICES

NETWORK SERVICES

TOOLS

BUILDING JANITORIAL

AUTOMOTIVE

FORMS/OFFICE SUPPLIES

GENERAL

DATA VOICE

PRODUCT IDENTIFIER		DESCRIPTION					
ITEM NUMBER	ORD. MULT.	SELL UNIT	STD. PKG. STOCK AVAILABILITY / PA	LEAD TIME	MIN. ORD.	A C	

400121026 CLAMP CABLE 35 ZINC PACKAGE 10							
1128363	1	PK	IL IN MI OH WI 08 08 08 08 08				

260370275 CLAMP CABLE 12A1							
1955963	1	EA	IL IN MI OH WI 08 08 08 08 08				

400121042 CLAMP CABLE C							
1128405	1	EA	IL IN MI OH WI 08 08 08 08 08				
Clamp is installed over the jacketed strand. Use on self supporting strand, CA08261 - BSP 627-100-014.							

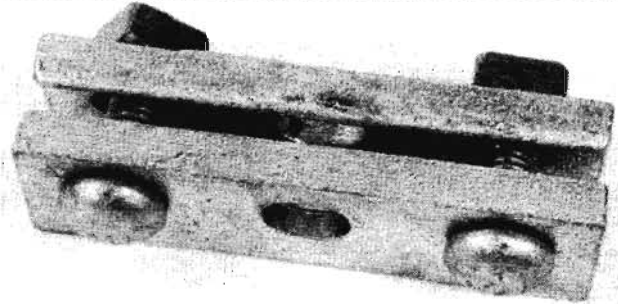

1128405

840245203 CLAMP CABLE TIE							
N		EA	1	1	1		

400121349 CLAMP LASHING CABLE D							
1128801	1	EA	IL IN MI OH WI 08 08 08 08 08				
Two piece clamp for attaching lashing wire or No. 6 ground wire to strand, BSP 627-330-202.							

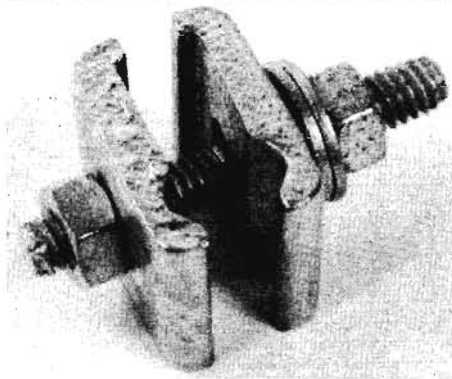

1128801

PRODUCT IDENTIFIER		DESCRIPTION					
ITEM NUMBER	ORD. MULT.	SELL UNIT	STD. PKG. STOCK AVAILABILITY / PA	LEAD TIME	MIN. ORD.	A C	

CLAMP CHECK VALVE							
SEE VALVE CHECK CLAMP							

CLAMP GROUND							
---------------------	--	--	--	--	--	--	--

402689822 CLAMP GROUND C CA08981							
1444745	1	EA					
Package of 5.							

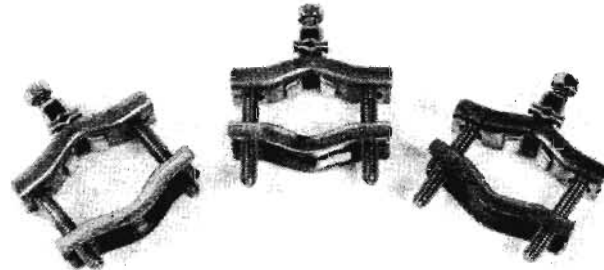

402689822

900220039 CLAMP GROUND ELECTRIC LINE L160							
1128660	1	EA	IL IN MI OH WI 08 08 08 08 08				
A ground clamp for use on buried ground rod where the power company occupies the top of the rod.							

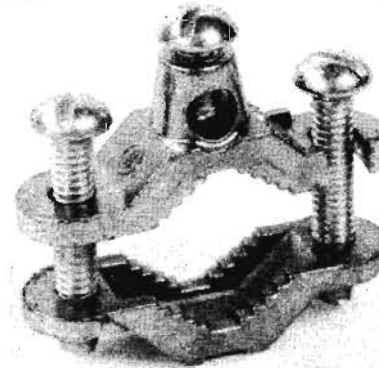

1128660

280003815 CLAMP GROUND EM 5510							
1921205	10	EA	IL IN MI OH WI 08 08 08 08 08				

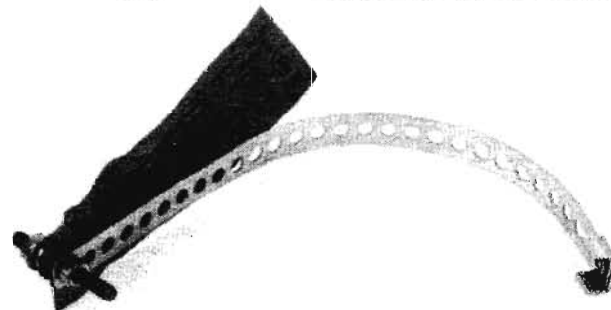

1921205

DISTRIBUTION SERVICES

NETWORK SERVICES

TOOLS

BUILDING JANITORIAL

AUTOMOTIVE

FORMS/OFFICE SUPPLIES

GENERAL

DATA VOICE

DISTRIBUTION SERVICES

NETWORK SERVICES

TOOLS

BUILDING JANITORIAL

AUTOMOTIVE

FORMS/OFFICE SUPPLIES

GENERAL

DATA VOICE

CLAMP GROUND

PRODUCT IDENTIFIER		DESCRIPTION					
ITEM NUMBER	ORD. MULT.	SELL UNIT	STD. PKG.	LEAD TIME	MIN. ORD.	A	C

002058568 CLAMP GROUND JAB 58H CA06299
 1445445 1 EA IL IN MI OH WI
 08 08 08 08 08
 A ground clamp for connecting #6 ground wire to buried ground rods.



1445445

400121307 CLAMP GROUND STRAND B CA07182
 1128702 1 EA IL IN MI OH WI
 08 08 08 08 08
 Used for attaching ground wire or bonding ribbon to suspension strand, BSP 627-230-010.

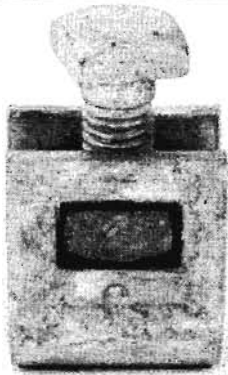

1128702

CLAMP STAINLESS STEEL

260346846	CLAMP STAINLESS STEEL	2IN	N	EA	1	2	1
26-0001-7872-8.							
260346853	CLAMP STAINLESS STEEL	3IN	N	EA	1	2	1
26-0001-7871-0.							
260346861	CLAMP STAINLESS STEEL	4IN	N	EA	1	2	1
26-0001-7873-6.							
260346879	CLAMP STAINLESS STEEL	5IN	N	EA	1	2	1
26-0001-7874-4.							
260346887	CLAMP STAINLESS STEEL	6IN- 7IN	N	EA	1	2	1
26-0001-7875-1.							

PRODUCT IDENTIFIER		DESCRIPTION					
ITEM NUMBER	ORD. MULT.	SELL UNIT	STD. PKG.	LEAD TIME	MIN. ORD.	A	C

260323332 CLAMP STAINLESS STEEL 8IN
 N EA 1 2 1

260322458 CLAMP STAINLESS STEEL 9IN-10IN
 N EA 1 2 1
 910SS. NOW AVAILABLE THROUGH TOUCH-TONE ORDER ENTRY.

260346895 CLAMP STAINLESS STEEL 12IN
 N EA 1 2 1
 26-0001-8342-0.

CLAMP WIRE

400121513 CLAMP WIRE DROP B CA07380
 1229211 25 EA
 Suitable for use on all drop wires including high strength drop wires, BSP 462-030-105.

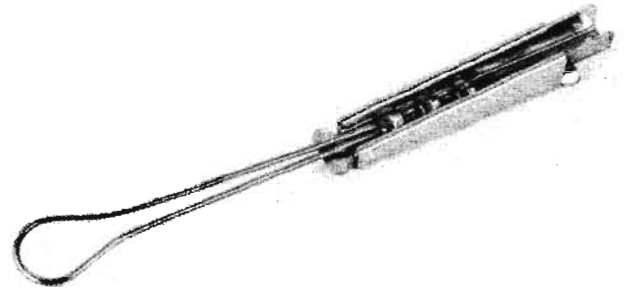

400121513

400121547 CLAMP WIRE DROP E
 1129122 1 PK IL IN MI OH WI
 08 08 08 08 08
 For use as a building attachment for drop wires. Package of 50, BSP 080-720-144.

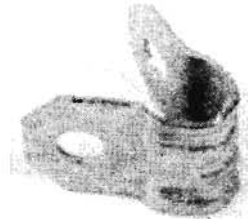

1129122

402582266 CLAMP WIRE DROP G
 1437368 1 EA IL IN MI OH WI
 08 08 08 08 08
 Package of 2. DISCONTINUE UPON STOCK DEPLETION

PRODUCT IDENTIFIER		DESCRIPTION				
ITEM NUMBER	ORD. MULT.	SELL UNIT	STD. PKG. STOCK AVAILABILITY / PA	LEAD TIME	MIN. ORD.	A C

402220024 CLAMP WIRE SERVICE C
 8386664 1 PK IL IN MI OH WI
 08 08 08 08 08
 Package of 10. For bonding metallic shield of the service wire when attached to the bond bracket in a pedestal closure, BSP 081-852-119.

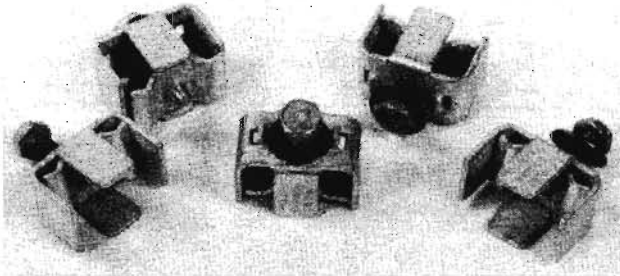

8386664

402220016 CLAMP WIRE SERVICE C P43197
 N EA 1 6 1
 Package of 50.

CLEANER FILLED CABLE
 SEE SOLVENT CABLE CLEANER.

CLIP

900274606 CLIP A0112 854 MSQ 4100 L1
 N EA 1 3 22

280026493 CLIP BRANCH OFF 1051 LARGE BOCL-20
 N EA 25 6 50

280026485 CLIP BRANCH OFF 1066 MEDIUM BOCL-20
 N EA 25 6 75

280026477 CLIP BRANCH OFF 1636 SMALL BOCL-20
 N EA 25 6 125

900538075 CLIP CASEY 1 C4029
 N EA 100 4 100

260357140 CLIP FLOATING GROUND PANDUIT
 1952648 10 PK IL IN MI OH WI
 08 08 08 08 08
 For bonding buried service wires. To be shipped on pallet #NC-NL.

900233867 CLIP GROUND 6C4045
 6500751 1 EA IL IN MI OH WI
 08
 DISCONTINUE AND FORWARD TO CONN F UPON STOCK DEPLETION

PRODUCT IDENTIFIER		DESCRIPTION				
ITEM NUMBER	ORD. MULT.	SELL UNIT	STD. PKG. STOCK AVAILABILITY / PA	LEAD TIME	MIN. ORD.	A C

402520498 CLIP MOD BRIDGE C CA08596
 1438481 1 PK IL IN MI OH WI
 18 18 18
 3PR mod for use with 66-M-type blocks to electrically connect 3 pairs of adjacent terminals. BSP.

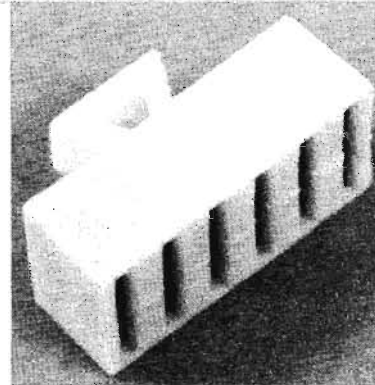

1438481

260370267 CLIP PREWIRE QUICK LOCK
 1956078 1 EA IL IN MI OH WI
 18 18 18 18 18

900194770 CLIP PROTECT G C4047
 1169946 1 EA IL IN MI OH WI
 18 18 18 18 18
 A one piece clip used to bond or ground the shield of buried service wires, 1/4in diameter wire.



1169946

900410325 CLIP PROTECT G11 C4058
 1423822 1 EA IL IN MI OH WI
 18 18 18 18 18
 For 3/8in diameter wire.

300088986 CLIP RETENTION BACK COVER BCC10
 1920835 1 EA IL IN MI OH WI
 08 08 08 08 08
 A retaining clip used with the 2 Type Splice Closure for supporting back cover to end plates during splicing.

260345095 CLIP SIDING 061-0112-V
 1950915 1 PK IL IN MI OH WI
 18 18 18 18
 Package of 50.

DISTRIBUTION SERVICES
 NETWORK SERVICES
 TOOLS
 BUILDING JANITORIAL
 AUTOMOTIVE
 FORMS/OFFICE SUPPLIES
 GENERAL
 DATA VOICE

CLIP

PRODUCT IDENTIFIER DESCRIPTION

ITEM NUMBER	ORD. MULT.	SELL UNIT	STD. PKG. STOCK AVAILABILITY / PA	LEAD TIME	MIN. ORD.	A C
-------------	------------	-----------	-----------------------------------	-----------	-----------	-----

402594931 CLIP SIDING B CA08939
 8408518 1 PK IL IN MI OH WI
 18 18 18 18 18
 Used to fasten station wires or drop wires to aluminum siding, on vertical or horizontal runs, package of 25, BSP 461-200-210.

900291436 CLIP SIDING HORIZONTAL METAL
 2805523 1 PK IL IN MI OH WI
 18 18 18 18
 Horizontal siding clip used to attach 1W to aluminum siding, package of 50.

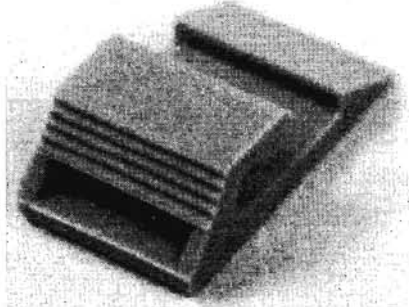

2805523

900291428 CLIP SIDING VERTICAL METAL
 2805549 1 PK IL IN MI OH WI
 18 18 18 18
 Vertical siding clip used to attach 1W to aluminum siding, package of 50.

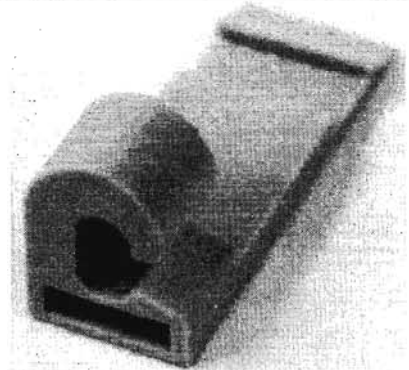

2805549

400122537 CLIP WIRE B CAO7587
 1111955 1 EA IL IN MI OH WI
 18 18

260437090 CLIP WIRE RETAINING P20229
 N PK 1 5 1

PRODUCT IDENTIFIER DESCRIPTION

ITEM NUMBER	ORD. MULT.	SELL UNIT	STD. PKG. STOCK AVAILABILITY / PA	LEAD TIME	MIN. ORD.	A C
-------------	------------	-----------	-----------------------------------	-----------	-----------	-----

400122560 CLIP WIRE SC CA07226
 1130187 25 EA IL IN MI OH WI
 08 08 08 08 08
 Used on drop wires at house attachments to provide slack in the wire, package of 25, BSP 080-720-145.

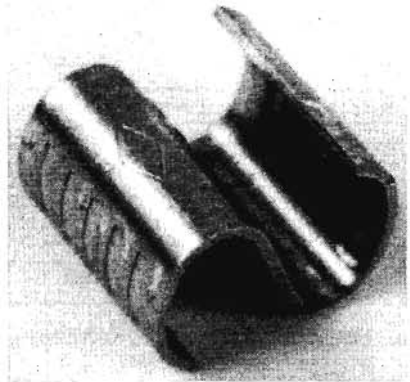

1130187

CLIP BRIDGING

260339700 CLIP BRIDGING ADAPTER 1 PAIR RED
 1949453 25 EA

260339718 CLIP BRIDGING ADAPTER 1 PAIR WHITE
 1949461 25 EA IL IN MI OH WI
 18 18 18

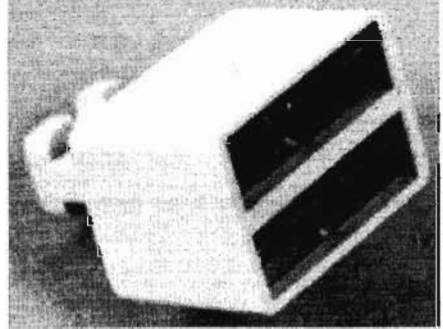

1949461

260339726 CLIP BRIDGING ADAPTER 1 PAIR YELLOW
 1949479 25 EA IL IN MI OH WI
 18 18 18

402537757 CLIP BRIDGING C 2 PAIR
 1416446 1 EA IL IN MI OH WI
 18 18 18 18 18
 A stainless steel spring clip used to electrically interconnect two adjacent terminals in the same row of a 66 type connecting blocks, BSP 461-604-100. Package of 25.

CLIP CABLE

400487138 CLIP CABLE ADHESIVE 706 GRAY
 1315846 1 EA
 Used with station wire D, bag of 100, BSP 461-200-210. DISCONTINUE AND FORWARD TO CLIP CORD B1 61 GY UPON STOCK DEPLETION

DISTRIBUTION SERVICES

NETWORK SERVICES

TOOLS

BUILDING JANITORIAL

AUTOMOTIVE

FORMS/OFFICE SUPPLIES

GENERAL

DATA VOICE

PRODUCT IDENTIFIER DESCRIPTION

ITEM NUMBER	ORD. MULT.	SELL UNIT	STD. PKG. STOCK AVAILABILITY / PA	LEAD TIME	MIN. ORD.	A C
-------------	------------	-----------	-----------------------------------	-----------	-----------	-----

400556874 CLIP CABLE ADHESIVE 708 GRAY
 3357301 1 EA IL IN MI OH WI
 18 18 18 18 18
 Bag of 100. DISCONTINUE AND FORWARD TO CLIP CORD B2 61 GY UPON STOCK DEPLETION

400556890 CLIP CABLE ADHESIVE 713 GRAY
 1129841 1 EA IL IN MI OH WI
 18 18 18 18 18
 Bag of 100. DISCONTINUE AND FORWARD TO CLIP CORD B3 61 GY UPON STOCK DEPLETION

280013855 CLIP CABLE RACK L1100 HOOK LOCK
 N EA 1 2 1
 Used in manholes. NOW AVAILABLE THROUGH TOUCH-TONE ORDER ENTRY.

CLIP CORD

CA08598. A molded plastic clip e/w double faced adhesive tape to permit mounting on a smooth surface. Used to fasten wire, cords or cables. Comes in 3 sizes and 4 colors. BSP461-210-200.

400717559 CLIP CORD B1 03 BLACK PACKAGE 10
 N PK 1 8 100

400717641 CLIP CORD B1 61 GRAY PACKAGE 10
 2740001 1 PK IL IN MI OH WI
 18 18 18 18 18

400717567 CLIP CORD B2 03 BLACK PACKAGE 100
 N PK 100 8 500

400717633 CLIP CORD B2 60 BEIGE PACKAGE 10
 N PK 1 8 100

400717658 CLIP CORD B2 61 GRAY PACKAGE 10
 2740100 1 PK IL IN MI OH WI
 18 18 18 18 18

400719100 CLIP CORD B3 60 BEIGE PACKAGE 10
 N PK 1 8 100

400719118 CLIP CORD B3 61 GRAY PACKAGE 10
 2740209 1 PK IL IN MI OH WI
 18 18 18 18 18

CLIP MASONRY

402594907 CLIP MASONRY B1 CA08938
 N EA 10 3 650
 Package of 10.

402594915 CLIP MASONRY B2 CA08938
 N EA 10 3 650
 Package of 10.

402594923 CLIP MASONRY B3 CA08938
 N EA 10 3 650
 Used to fasten Dropwire or Station Wire to masonry or other hard surfaces. Package of 10.

PRODUCT IDENTIFIER DESCRIPTION

ITEM NUMBER	ORD. MULT.	SELL UNIT	STD. PKG. STOCK AVAILABILITY / PA	LEAD TIME	MIN. ORD.	A C
-------------	------------	-----------	-----------------------------------	-----------	-----------	-----

900768664 CLIP MASONRY TAP TA 1
 5516369 1 PC IL IN MI OH WI
 18 18 18 18 18
 A plastic clip with masonry nail used with a plastic tie to mount inside wire to a masonry surface. Package of 10.

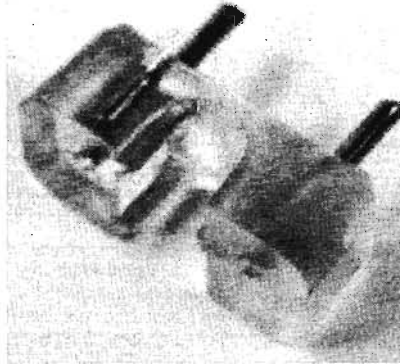

5516369

900768672 CLIP MASONRY TAP TA 6
 5516328 1 EA IL IN MI OH WI
 18 18 18 18 18
 Package of 10.

900768698 CLIP MASONRY TAP TA12
 5516344 1 EA IL IN MI OH WI
 18 18 18 18 18
 REPLACES TA2. Package of 10.

CLOSURE

300076015 CLOSURE 23 CA2
 4210914 1 EA
 23 type closure used to encapsulate straight splices on waterproof cables in buried and UG plant. 8in ID for a 19in sheath opening.

300076023 CLOSURE 23 CA4
 4210906 1 EA IL IN MI OH WI
 08
 23 type closure used to encapsulate 3-way and 4-way splices on waterproof cables in buried and UG plant. 8in ID for a 19in sheath opening.

300076031 CLOSURE 23 DA2
 4210898 1 EA IL IN MI OH WI
 08
 23 type closure used to encapsulate a straight splice on waterproof cables in buried and UG plant. 9.5in ID for a 19in sheath opening.

300076049 CLOSURE 23 DA4
 4210922 1 EA IL IN MI OH WI
 08
 23 type closure used to encapsulate 3-way and 4-way splices on waterproof cables in buried and UG plant. 9.5in ID for a 19in sheath opening.

CLOSURE

DISTRIBUTION SERVICES

PRODUCT IDENTIFIER		DESCRIPTION				
ITEM NUMBER	ORD. MULT.	SELL UNIT	STD. PKG. STOCK AVAILABILITY / PA	LEAD TIME	MIN. ORD.	A C
260303052		CLOSURE	23 DB4			
1939751	1	EA	IL IN MI OH WI 08			
23 type closure used to encapsulate up to a 4 way splice in buried and UG plant. 27 1/2in sheath open.						

NETWORK SERVICES

PRODUCT IDENTIFIER		DESCRIPTION				
ITEM NUMBER	ORD. MULT.	SELL UNIT	STD. PKG. STOCK AVAILABILITY / PA	LEAD TIME	MIN. ORD.	A C
260303060		CLOSURE	23 DC4			
1939769	1	EA	IL IN MI OH WI 08			
23 type closure used to encapsulate up to a 4 way splice in buried and underground plant up to a 36in sheath open.						

TOOLS

PRODUCT IDENTIFIER		DESCRIPTION				
ITEM NUMBER	ORD. MULT.	SELL UNIT	STD. PKG. STOCK AVAILABILITY / PA	LEAD TIME	MIN. ORD.	A C
104016704		CLOSURE	85 C6B			
N		EA	1	5	1	
Provides fixed count terminating facilities for buried service wires or aerial drops, and provides protection against corrosion.						

PRODUCT IDENTIFIER		DESCRIPTION				
ITEM NUMBER	ORD. MULT.	SELL UNIT	STD. PKG. STOCK AVAILABILITY / PA	LEAD TIME	MIN. ORD.	A C
104016712		CLOSURE	85 C6FB BURIED CABLE			
N		EA	1	5	1	
Same as 85C6B, but is equipped with flood cover instead of upper front cover.						

BUILDING JANITORIAL

PRODUCT IDENTIFIER		DESCRIPTION				
ITEM NUMBER	ORD. MULT.	SELL UNIT	STD. PKG. STOCK AVAILABILITY / PA	LEAD TIME	MIN. ORD.	A C
104189782		CLOSURE	85 C6FC			
N		EA	1	14	1	
Same as 85C6B, but is equipped with moisture barrier and flood cover instead of upper front cover.						

AUTOMOTIVE

PRODUCT IDENTIFIER		DESCRIPTION				
ITEM NUMBER	ORD. MULT.	SELL UNIT	STD. PKG. STOCK AVAILABILITY / PA	LEAD TIME	MIN. ORD.	A C
105037576		CLOSURE	2000 LG 7/20-TP			
N		EA	1	2	1	

PRODUCT IDENTIFIER		DESCRIPTION				
ITEM NUMBER	ORD. MULT.	SELL UNIT	STD. PKG. STOCK AVAILABILITY / PA	LEAD TIME	MIN. ORD.	A C
105037550		CLOSURE	2000 LG 7/20-U			
N		EA	1	2	1	

FORMS/OFFICE SUPPLIES

PRODUCT IDENTIFIER		DESCRIPTION				
ITEM NUMBER	ORD. MULT.	SELL UNIT	STD. PKG. STOCK AVAILABILITY / PA	LEAD TIME	MIN. ORD.	A C
260411384		CLOSURE	2200 UG 4/20			
1971275	1	EA	IL IN MI OH WI 08			

PRODUCT IDENTIFIER		DESCRIPTION				
ITEM NUMBER	ORD. MULT.	SELL UNIT	STD. PKG. STOCK AVAILABILITY / PA	LEAD TIME	MIN. ORD.	A C
260363205		CLOSURE	2200 UG 6/20			
1954305	1	EA	IL IN MI OH WI 08 08 08 08 08			

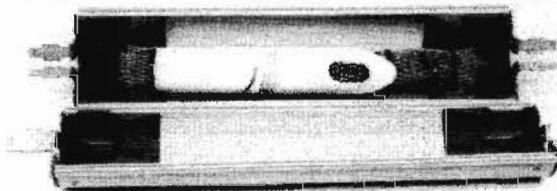

1954305

GENERAL

PRODUCT IDENTIFIER		DESCRIPTION				
ITEM NUMBER	ORD. MULT.	SELL UNIT	STD. PKG. STOCK AVAILABILITY / PA	LEAD TIME	MIN. ORD.	A C
260344486		CLOSURE	2200 UG 8/20			
1950386	1	EA	IL IN MI OH WI 08 08 08 08 08			
For re-entry, use Kit of Parts D181775 (1950519).						

PRODUCT IDENTIFIER		DESCRIPTION				
ITEM NUMBER	ORD. MULT.	SELL UNIT	STD. PKG. STOCK AVAILABILITY / PA	LEAD TIME	MIN. ORD.	A C
260344494		CLOSURE	2200 UG 10/20			
1950394	1	EA	IL IN MI OH WI 08 08 08 08 08			
For re-entry, Use Kit of Parts D181776 (1950527)						

DATA VOICE

PRODUCT IDENTIFIER		DESCRIPTION				
ITEM NUMBER	ORD. MULT.	SELL UNIT	STD. PKG. STOCK AVAILABILITY / PA	LEAD TIME	MIN. ORD.	A C
260411376		CLOSURE	2200 UG 10/30			
1971267	1	EA	IL IN MI OH WI 08			

PRODUCT IDENTIFIER		DESCRIPTION				
ITEM NUMBER	ORD. MULT.	SELL UNIT	STD. PKG. STOCK AVAILABILITY / PA	LEAD TIME	MIN. ORD.	A C
105412290		CLOSURE	2400 LG/00			
N		EA	1	6	1	

PRODUCT IDENTIFIER		DESCRIPTION				
ITEM NUMBER	ORD. MULT.	SELL UNIT	STD. PKG. STOCK AVAILABILITY / PA	LEAD TIME	MIN. ORD.	A C
105412308		CLOSURE	2400 LG/00FR			
N		EA	1	6	1	

PRODUCT IDENTIFIER		DESCRIPTION				
ITEM NUMBER	ORD. MULT.	SELL UNIT	STD. PKG. STOCK AVAILABILITY / PA	LEAD TIME	MIN. ORD.	A C
105412332		CLOSURE	2400 LG/41			
N		EA	1	6	1	

PRODUCT IDENTIFIER		DESCRIPTION				
ITEM NUMBER	ORD. MULT.	SELL UNIT	STD. PKG. STOCK AVAILABILITY / PA	LEAD TIME	MIN. ORD.	A C
105412316		CLOSURE	2400 LG/41FR			
N		EA	1	6	1	

PRODUCT IDENTIFIER		DESCRIPTION				
ITEM NUMBER	ORD. MULT.	SELL UNIT	STD. PKG. STOCK AVAILABILITY / PA	LEAD TIME	MIN. ORD.	A C
105412340		CLOSURE	2400 LG/48			
N		EA	1	6	1	

PRODUCT IDENTIFIER		DESCRIPTION				
ITEM NUMBER	ORD. MULT.	SELL UNIT	STD. PKG. STOCK AVAILABILITY / PA	LEAD TIME	MIN. ORD.	A C
105412324		CLOSURE	2400 LG/48FR			
N		EA	1	6	1	

PRODUCT IDENTIFIER		DESCRIPTION				
ITEM NUMBER	ORD. MULT.	SELL UNIT	STD. PKG. STOCK AVAILABILITY / PA	LEAD TIME	MIN. ORD.	A C
002085736		CLOSURE	4530 BLOCKING			
1229112	1	KT	IL IN MI OH WI 08 08 08 08 08			
An open sheath blocking closure. A system designed to provide full pressure blocking on air core cable.						

PRODUCT IDENTIFIER		DESCRIPTION				
ITEM NUMBER	ORD. MULT.	SELL UNIT	STD. PKG. STOCK AVAILABILITY / PA	LEAD TIME	MIN. ORD.	A C
280099490		CLOSURE	4634 POST PEDESTAL SPLICE			
1937516	10	KT	IL IN MI OH WI 08 08 08 08 08			
Used for security, protection, from moisture and ultraviolet light. PST (Pre Stretched Tubing).						



1937516

PRODUCT IDENTIFIER		DESCRIPTION				
ITEM NUMBER	ORD. MULT.	SELL UNIT	STD. PKG. STOCK AVAILABILITY / PA	LEAD TIME	MIN. ORD.	A C
280099524		CLOSURE	4634R POST PEDESTAL REHAB			
1937540	10	KT	IL IN MI OH WI 08 08 08 08 08			
Used when replacing pedestal splice closure.						

PRODUCT IDENTIFIER		DESCRIPTION					
ITEM NUMBER	ORD. MULT.	SELL UNIT	STD. PKG. STOCK AVAILABILITY / PA	LEAD TIME	MIN. ORD.	A	C

280099508 CLOSURE 4635 POST PEDESTAL SPLICE

1937524	10	KT	IL 08 IN 08	MI 08	OH 08	WI 08
---------	----	----	----------------	-------	-------	-------

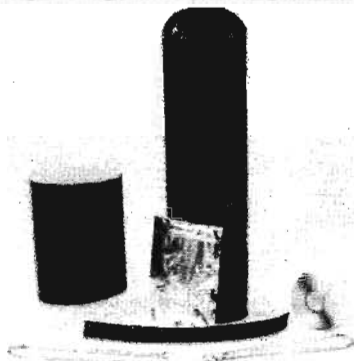

1937524

280099532 CLOSURE 4635R POST PEDESTAL REHAB

1937557	10	KT	IL 08 IN 08	MI 08	OH 08	WI 08
---------	----	----	----------------	-------	-------	-------

280099516 CLOSURE 4636 POST PEDESTAL SPLICE

1937532	5	KT	IL 08 IN 08	MI 08	OH 08	WI 08
---------	---	----	----------------	-------	-------	-------

280099540 CLOSURE 4636R POST PEDESTAL REHAB

1937508	5	KT	IL 08 IN 08	MI 08	OH 08	WI 08
---------	---	----	----------------	-------	-------	-------

4636 maximum bundle size 6.00.

260386347 CLOSURE 4637R POST PEDESTAL REHAB

1964270	5	KT	IL 08	MI 08	OH 08	WI 08
---------	---	----	-------	-------	-------	-------

260386339 CLOSURE 4637XL POST PEDESTAL SPLICE

1964262	1	KT	IL 08	MI 08	OH 08	WI 08
---------	---	----	-------	-------	-------	-------

8in.

002044220 CLOSURE BURIED SERVICE WIRE 4IN

1438283	1	EA	IL 08 IN 08	MI 08	OH 08	WI 08
---------	---	----	----------------	-------	-------	-------

401397294 CLOSURE BURIED WIRE B T6-2-6

3363960	1	EA	IL 08	MI 08	OH 08	WI 08
---------	---	----	-------	-------	-------	-------

401356795 CLOSURE KB 6IN W/C6-9

1222257	1	KT	IL 08 IN 08	MI 08	OH 08	WI 08
---------	---	----	----------------	-------	-------	-------

Kit consisting of a solid black PVC sleeve, steel clamps, a multiple end cap, a collared end cap, hose clamps and cable lubricant. Used to house splices in exposed entrance cable.

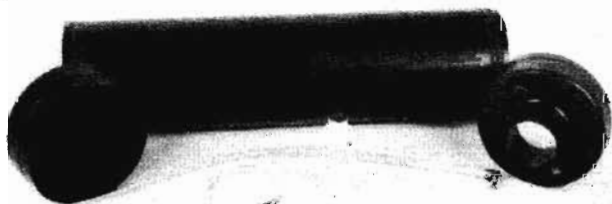

1222257

PRODUCT IDENTIFIER		DESCRIPTION					
ITEM NUMBER	ORD. MULT.	SELL UNIT	STD. PKG. STOCK AVAILABILITY / PA	LEAD TIME	MIN. ORD.	A	C

401356803 CLOSURE KB 7IN W/C7-15

1409946	1	KT	IL 08 IN 08	MI 08	OH 08	WI 08
---------	---	----	----------------	-------	-------	-------

KB7-100-15.

401356811 CLOSURE KB 8IN W/C8-24

1222851	1	KT	IL 08 IN 08	MI 08	OH 08	WI 08
---------	---	----	----------------	-------	-------	-------

KB8-100-24.

001024843 CLOSURE KB 9IN W/C9-27

1410027	1	KT	IL 08 IN 08	MI 08	OH 08	WI 08
---------	---	----	----------------	-------	-------	-------

KB9-100-27.

105150247 CLOSURE KIT G & G UC41/41

N		EA	1	2	1	
---	--	----	---	---	---	--

105150254 CLOSURE KIT G & G UC48/41

N		EA	1	2	1	
---	--	----	---	---	---	--

260401922 CLOSURE KIT K & B RE/HAB

1969667	1	KT	IL 08 IN 08	MI 08	OH 08	WI 08
---------	---	----	----------------	-------	-------	-------

Fire Retardant, BSP 633-560-101.



1969667

300067675 CLOSURE KNK TBT9105 1IN

1177477	1	BX	IL 08 IN 08	MI 08	OH 08	WI 08
---------	---	----	----------------	-------	-------	-------

Sleeve used to repair plastic cable sheath damages in buried, aerial, and UG cable environments. Used in conjunction with Kold-N-Klose core wrappings. Box of 4.

280079112 CLOSURE KNK TBT9120

N		BX	64	4	64	
---	--	----	----	---	----	--

Box of 1.

DISTRIBUTION SERVICES

NETWORK SERVICES

TOOLS

BUILDING JANITORIAL

AUTOMOTIVE

FORMS/OFFICE SUPPLIES

GENERAL

DATA VOICE

CLOSURE

DISTRIBUTION SERVICES

PRODUCT IDENTIFIER		DESCRIPTION						
ITEM NUMBER	ORD. MULT.	SELL UNIT	STD. PKG. STOCK AVAILABILITY / PA	LEAD TIME	MIN. ORD.	A C		
300081015 CLOSURE KNK TBT9205 7IN								
5125476	1	BX	IL 08 IN 08 MI 08 OH 08 WI 08					
Box of 4.								

NETWORK SERVICES

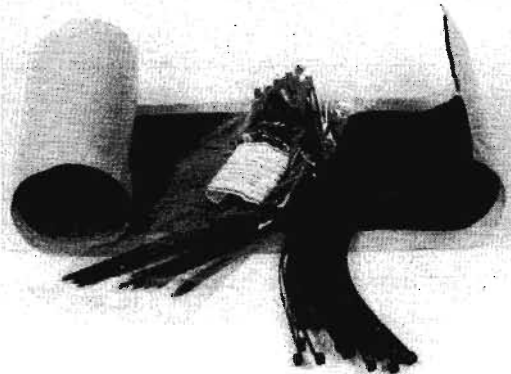

5125476

TOOLS

280079120 CLOSURE KNK TBT9220							
N		BX	48	4	48		
Box of 1.							

300067626 CLOSURE KNK TBT9305 2 1/8IN							
1143891	1	BX	IL 08 IN 08 MI 08 OH 08 WI 08				
Box of 4.							

280079138 CLOSURE KNK TBT9320							
N		BX	48	4	144		
Box of 1.							

300067683 CLOSURE KNK TBT9405 3 1/4IN							
1138099	1	BX	IL 08 IN 08 MI 08 OH 08 WI 08				
Box of 4.							

280079146 CLOSURE KNK TBT9420							
N		BX	32	4	32		
Box of 1.							

400981056 CLOSURE MC-10/48 LOC							
N		EA	1	8	1		

300062304 CLOSURE OUTSIDE BUILDING TERMINAL							
6512608	1	EA	IL 08 IN 08 MI 08 OH 08 WI 08				
Temporary storage for buried service wire. Ohio Bell.							

280079419 CLOSURE OUTSIDE BUILDING TERMINAL 25/50							
N		EA	1	8	10		
PW12 - 25 pair protected, 50 pair unprotected. Terminals E/W 12ft stub.							

280046210 CLOSURE OUTSIDE BUILDING TERMINAL 50/100							
N		EA	1	8	10		
PW12 - 50 pair protected, 100 pair unprotected. Terminals E/W 12ft stub.							

280026311 CLOSURE PEDESTAL SPLICE PEDCAP RE-2							
N		EA	10	6	10		

BUILDING JANITORIAL

AUTOMOTIVE

FORMS/OFFICE SUPPLIES

GENERAL

DATA VOICE

PRODUCT IDENTIFIER		DESCRIPTION						
ITEM NUMBER	ORD. MULT.	SELL UNIT	STD. PKG. STOCK AVAILABILITY / PA	LEAD TIME	MIN. ORD.	A C		
280026329 CLOSURE PEDESTAL SPLICE PEDCAP RE-3								
N		EA	10	6	10			
280026337 CLOSURE PEDESTAL SPLICE PEDCAP RE-4								
N		EA	10	6	10			
280026345 CLOSURE PEDESTAL SPLICE PEDCAP RE-6								
N		EA	5	6	5			
104173380 CLOSURE PROTECTOR MC12/40 E/W 50-100								
N		EA	1	1	1			
260339148 CLOSURE RIGID BODY W/4407								
N		KT	1	3	1			
Compound 8986-07.								
260339130 CLOSURE RIGID BODY W/4407								
N		KT	1	3	1			
Compound 8984-07.								

401971080 CLOSURE SERVICE CUSTOMER B CA08813

1114462	1	EA	IL 08 IN 08 MI 08 OH 08 WI 08				
A plastic base with plastic cover e/w 2 cable ties for locking the cover and 2 screws for mounting a single 123 or 128 type protector, BSP 460-100-400.							

402122006 CLOSURE SERVICE CUSTOMER C CA08813

1413765	1	EA	IL 08 IN 08 MI 08 OH 08 WI 08				
This is a plastic closure to house the protector at the customer premise. The dimensions are 8in high x 4 1/2in long x 3in deep, BSP 463-121-120.							

402250070 CLOSURE SERVICE CUSTOMER D CA08813

1413781	1	EA	IL 08 IN 08 MI 08 OH 08 WI 08				
Holds up to 4-128 type protectors, similar to the B closure.							

300052339 CLOSURE UP 08/25 OB							
N		EA	30	8	30		
Temporary storage for service wire.							

401481122 CLOSURE UP 16/52							
N		EA	6	8	6		
Buried splice closure used to house all types of splice cases up to 13in diameter and 30in height, BSP 631-600-908N. NOW AVAILABLE THROUGH TOUCH-TONE ORDER ENTRY.							

300068509 CLOSURE UP 16/52 OB							
N		EA	6	8	6		

DISTRIBUTION SERVICES

NETWORK SERVICES

TOOLS

BUILDING JANITORIAL

AUTOMOTIVE

FORMS/OFFICE SUPPLIES

GENERAL

DATA VOICE

PRODUCT IDENTIFIER DESCRIPTION

ITEM NUMBER	ORD. MULT.	SELL UNIT	STD. STOCK	PKG. AVAILABILITY	LEAD TIME / PA	MIN. ORD.	A C
-------------	------------	-----------	------------	-------------------	----------------	-----------	-----

402389936 CLOSURE UPC 1000

5370262 1 EA IL IN MI OH WI
08 08 08 08 08
Used to enclose rebuilt splices in buried plant. 48in high X 16in wide X 10 1/4in deep with double doors. For use by maintenance forces only.

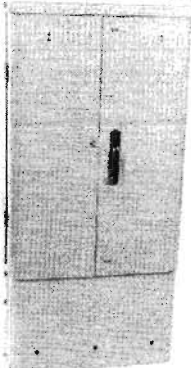

5370262

400657144 CLOSURE UPC 1248

2723882 1 EA IL IN MI OH WI
08 08 15 08 08
Used to close large splices in dedicated plant. Used as control or access points for buried cable in above ground locations, BSP 631-600-105.

CLOSURE AERIAL

260364872 CLOSURE AERIAL SLIC 2-19

1954859 1 EA



260364872

260364930 CLOSURE AERIAL SLIC 2-29

1954909 1 EA IL IN MI OH WI
08 08 08 08 08

260364922 CLOSURE AERIAL SLIC 3-33

1954891 1 EA IL IN MI OH WI
08 08 08 08 08

260364914 CLOSURE AERIAL SLIC 5-33FB

1954883 1 EA IL IN MI OH WI
08 08 08 08 08

PRODUCT IDENTIFIER DESCRIPTION

ITEM NUMBER	ORD. MULT.	SELL UNIT	STD. STOCK	PKG. AVAILABILITY	LEAD TIME / PA	MIN. ORD.	A C
-------------	------------	-----------	------------	-------------------	----------------	-----------	-----

260364898 CLOSURE AERIAL SLIC 7-33FB

1954875 1 EA IL IN MI OH WI
08 08 08 08 08

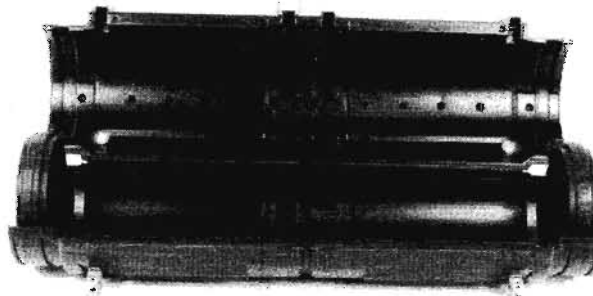

1954875

260431473 CLOSURE AERIAL SLIC 9-36

1978957 1 KT IL IN MI OH WI
08 08 08 08 08

CLOSURE BUILDING

280028044 CLOSURE BUILDING RISER FR R3

1969550 1 KT
Fire Retardant, BSP 633-560-101.



280028044

280028051 CLOSURE BUILDING RISER FR R5

1969568 1 KT IL IN MI OH WI
08 08 08
Fire Retardant, BSP 633-560-101.

280028069 CLOSURE BUILDING RISER FR R6

1969576 1 KT IL IN MI OH WI
08 08 08
Fire Retardant, BSP 633-560-101.

280028077 CLOSURE BUILDING RISER FR R7

1969584 1 KT IL IN MI OH WI
08 08 08
Fire Retardant, BSP 633-560-101.

280028085 CLOSURE BUILDING RISER FR R9

1969592 1 KT IL IN MI OH WI
08 08
Fire Retardant, BSP 633-560-101.

DISTRIBUTION SERVICES

CLOSURE CABLE

PRODUCT IDENTIFIER		DESCRIPTION						
ITEM NUMBER	ORD. MULT.	SELL UNIT	STD. PKG. STOCK AVAILABILITY / PA	LEAD TIME	MIN. ORD.	A	C	

CLOSURE CABLE

401684360 CLOSURE CABLE C3573

N EA 1
DISCONTINUE UPON STOCK DEPLETION.

260321955 CLOSURE CABLE CAD 4 AM

1941898 1 EA IL IN MI OH WI
08 08 08 08
For buried distribution system. Used for both joint and non-joint buried plant. Mounting post and ground ribbon assembly must be ordered separately.

260320296 CLOSURE CABLE CAD 6 AM

1941906 1 EA IL IN MI OH WI
08 08 08 08 08
For buried distribution system. Used for both joint and non-joint buried plant. Mounting post and ground ribbon assembly must be ordered separately.

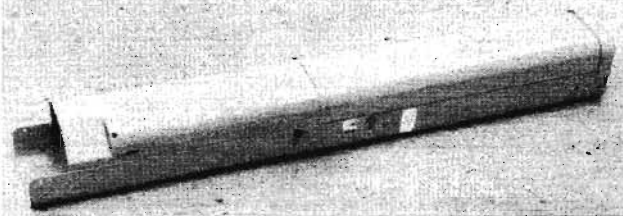

1941906

260321856 CLOSURE CABLE CAD 6/70 AM

1942870 1 EA IL IN MI OH WI
08 08
For buried distribution system. Used for both joint and non-joint buried plant. Mounting post and ground ribbon assembly must be ordered separately.

260320304 CLOSURE CABLE CAD 8 AM

1941914 1 EA IL IN MI OH WI
08 08 08 08 08
For buried distribution system. Used for both joint and non-joint buried plant. Mounting post and ground ribbon assembly must be ordered separately.

260320288 CLOSURE CABLE CAD 12 AM

1941922 1 EA IL IN MI OH WI
08 08 08 08 08
For buried distribution system. Used for both joint and non-joint buried plant. Mounting post and ground ribbon assembly must be ordered separately.

400547477 CLOSURE CABLE MC10/48 CA08585

1101634 1 EA IL IN MI OH WI
08 08 08 08 08
Cable closure designed to provide station protected outdoor termination facility. Intended to house outdoor distribution terminals for garden apartments, BSP 631-470-204.

002044212 CLOSURE CABLE MC10/48 MB-UP

1438309 1 EA IL IN MI OH WI
08 08 08 08 08

TOOLS

BUILDING JANITORIAL

AUTOMOTIVE

FORMS/OFFICE SUPPLIES

GENERAL

DATA VOICE

PRODUCT IDENTIFIER		DESCRIPTION						
ITEM NUMBER	ORD. MULT.	SELL UNIT	STD. PKG. STOCK AVAILABILITY / PA	LEAD TIME	MIN. ORD.	A	C	

CLOSURE FIBER OPTIC SPLICE

260418827 CLOSURE FIBER OPTIC 3M2178-A

1973701 1 EA
Fiber optic splice closure for use in building entrance and vault splice applications.

260418777 CLOSURE FOSC 100B

1973651 1 EA IL IN MI OH WI
21 21 21 21 21
Fiber Optic Splice Closure for cables 48 fibers or less, complete closure assembly, P/N317051.

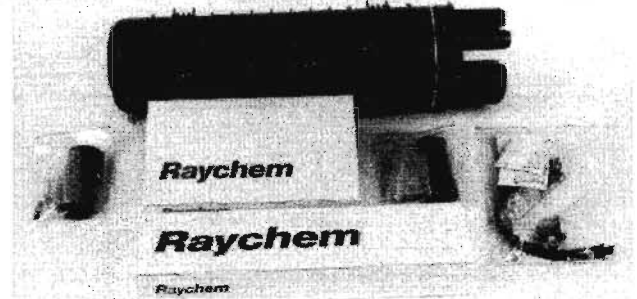

1973651

260436191 CLOSURE FOSC 100B-2

1980755 EA IL IN MI OH WI

260418876 CLOSURE FOSC 100D

1973750 1 EA IL IN MI OH WI
21 21 21 21 21
Fiber Optical Splice Closure for cables 48 fibers and over, complete closure assembly. P/N185615.



1973750

PRODUCT IDENTIFIER DESCRIPTION

ITEM	ORD.	SELL	STD.	PKG.	LEAD TIME	MIN.	A
NUMBER	MULT.	UNIT	STOCK AVAILABILITY / PA		ORD.	C	

260418843 KIT BUTT ADAPTER 2181-A
 1973727 1 EA IL IN MI OH WI
 21 21 21 21 21
 Fiber Optic Splice Closure Kit contains the needed piece parts to add a 3rd cable to a splice in a Butt configuration or when adding a 5th cable to an in-line splice.

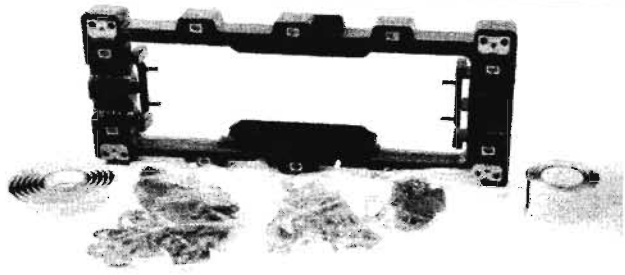

1973727

260418850 KIT CABLE ADDITION 2180-A
 1973735 1 EA IL IN MI OH WI
 21 21 21 21 21
 Fiber Optic Splice Closure Kit used to add a single cable to an existing closure.

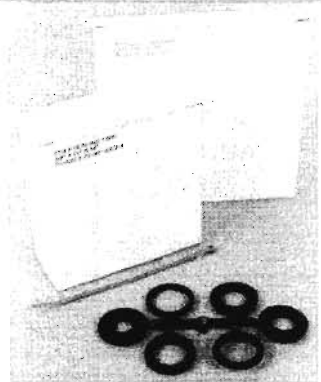

1973735

260418835 KIT CORE BLOCKING 2185
 1973719 1 EA IL IN MI OH WI
 08 08 08 08 08
 Fiber Optic Splice Closure Kit used on a cable end to stop water from entering closure. #2185 (1 each) will block 3-4 fiber cables.

260418868 KIT DOUBLE BUTT ADAPTER 2181A/B
 1973743 1 EA IL IN MI OH WI
 21 21 21 21 21
 Kit contains the fasteners necessary to assemble the closure when butt adapters are double stacked.

PRODUCT IDENTIFIER DESCRIPTION

ITEM	ORD.	SELL	STD.	PKG.	LEAD TIME	MIN.	A
NUMBER	MULT.	UNIT	STOCK AVAILABILITY / PA		ORD.	C	

260418710 KIT FOSC 100AT ACCESS TUBE
 1973594 1 PK IL IN MI OH WI
 21 21 21 21 21
 Fiber Optic Splice Closure Kit contains 200 split adhesive tubes.

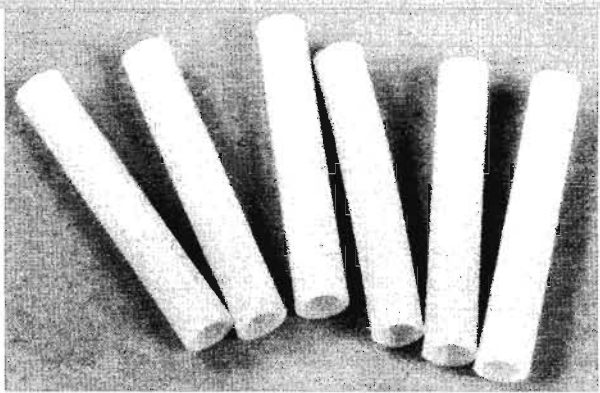

1973594

260418744 KIT FOSC 100B/2CK SEAL
 1973610 1 EA IL IN MI OH WI
 21 21 21 21 21
 Fiber Optic Splice Closure Kit used to seal the oval entrance port, P/N977679.

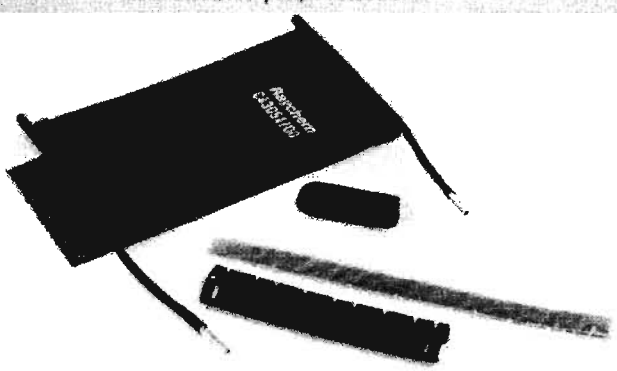

1973610

260418736 KIT FOSC 100B/DK OVAL PORT SEAL
 1973628 1 EA IL IN MI OH WI
 21 21 21 21 21
 Fiber Optic Splice Closure Kit is used to seal the round entrance port, P/N400033.

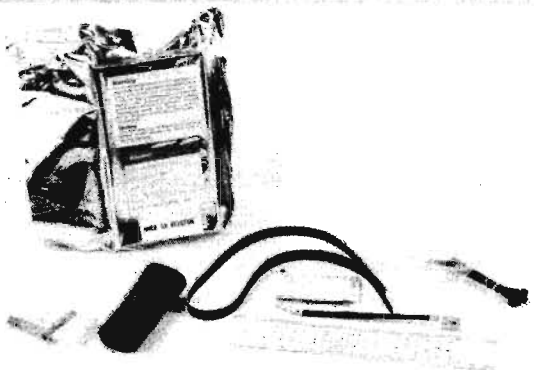

1973628

- DISTRIBUTION SERVICES
- NETWORK SERVICES
- TOOLS
- BUILDING JANITORIAL
- AUTOMOTIVE
- FORMS/OFFICE SUPPLIES
- GENERAL
- DATA VOICE

DISTRIBUTION SERVICES

NETWORK SERVICES

TOOLS

BUILDING JANITORIAL

AUTOMOTIVE

FORMS/OFFICE SUPPLIES

GENERAL

DATA VOICE

CLOSURE FIBER OPTIC SPLICE

PRODUCT IDENTIFIER DESCRIPTION

ITEM NUMBER	ORD. MULT.	SELL UNIT	STD. PKG. STOCK AVAILABILITY / PA	LEAD TIME	MIN. ORD.	A C
-------------	------------	-----------	-----------------------------------	-----------	-----------	-----

260418769 KIT FOSC 100B/DSK PERMANENT DOME SEAL

1973644	1	EA	IL IN MI OH WI	21 21 21 21 21		
---------	---	----	----------------	----------------	--	--

Fiber Optic Splice Closure Kit is used to seal the dome to the base of an existing closure. Dome sealing kit, P/N411431.



1973644

260418793 KIT FOSC 100B/RK RIBBON CABLE

1973677	1	EA	IL IN MI OH WI	21 21 21 21 21		
---------	---	----	----------------	----------------	--	--

Fiber Optic Splice Closure Kit is used when splicing ribbon cable with arrays, P/N197753.

260418785 KIT FOSC 100B/SK SLACK TRAY

1973669	1	EA	IL IN MI OH WI	21 21 21 21 21		
---------	---	----	----------------	----------------	--	--

Tray is used to store slack cable in a 100B fiber optic splice closure; cable tube organizer, P/N755589.

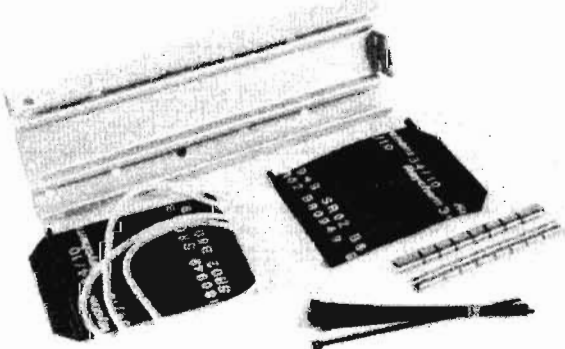

1973669

260418751 KIT FOSC 100B/TK SPLICE TRAY

1973636	1	KT	IL IN MI OH WI	21 21 21 21 21		
---------	---	----	----------------	----------------	--	--

Fiber Optic Splice Closure Kit contains 3 splice trays holding 12 splices each, P/N711611.

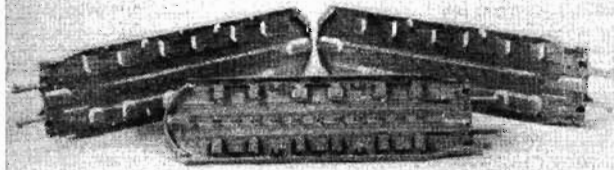

1973636

PRODUCT IDENTIFIER DESCRIPTION

ITEM NUMBER	ORD. MULT.	SELL UNIT	STD. PKG. STOCK AVAILABILITY / PA	LEAD TIME	MIN. ORD.	A C
-------------	------------	-----------	-----------------------------------	-----------	-----------	-----

260418926 KIT FOSC 100D/2CK OVAL PORT SEAL

1973792	1	EA	IL IN MI OH WI	21 21 21 21 21		
---------	---	----	----------------	----------------	--	--

Fiber Optic Splice Closure Kit is used to seal the oval cable entrance port, P/N130231.

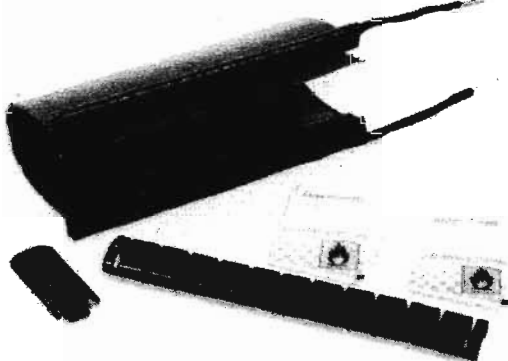

1973792

260418660 KIT FOSC 100D/CK SEAL

1973545	1	EA	IL IN MI OH WI	21 21 21 21 21		
---------	---	----	----------------	----------------	--	--

Fiber Optic Splice Closure Kit round port seal - kit is used to seal the round cable entrance port. Single cable termination kit P/N668495.

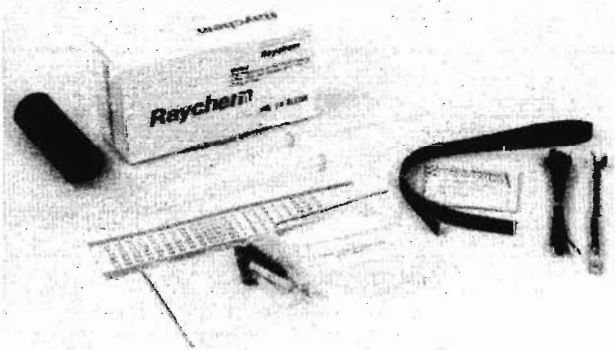

1973545

260418918 KIT FOSC 100D/DSK PERMANENT DOME SEAL

1973784	1	EA	IL IN MI OH WI	21 21 21 21 21		
---------	---	----	----------------	----------------	--	--

Fiber Optic Splice Closure Kit contains parts needed to seal an existing 100D splice closure. Dome sealing kit, P/N321207.

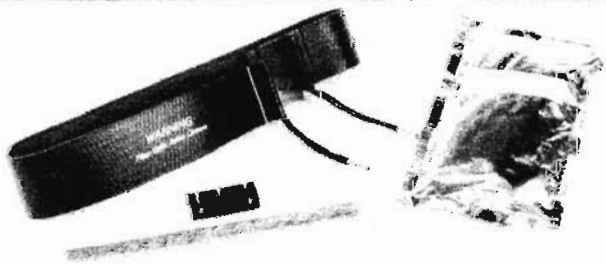

1973784

260418686 KIT FOSC 100D/RK RIBBON CBL ORGANIZER

1973560	1	EA	IL IN MI OH WI	21 21 21 21 21		
---------	---	----	----------------	----------------	--	--

Fiber Optic Splice Kit Ribbon Cable Organizer - kit is used when splicing ribbon cable with arrays; organizer kit (ribbon) P/N924813.

DISTRIBUTION SERVICES

NETWORK SERVICES

TOOLS

BUILDING JANITORIAL

AUTOMOTIVE

FORMS/OFFICE SUPPLIES

GENERAL

DATA VOICE

PRODUCT IDENTIFIER DESCRIPTION

ITEM NUMBER	ORD. MULT.	SELL UNIT	STD. PKG.		LEAD TIME			MIN. ORD.	A C
			STOCK AVAILABILITY / PA		IL	IN	MI		

260418678 KIT FOSC 100D/SK SLACK TRAY

1973552	1	EA	IL	IN	MI	OH	WI		
			21	21	21	21	21		

Fiber Optic Splice Closure Kit is used to store slack in the splice closure. Kit contains a slack tray, spacers, & wrap-around moisture block sleeve; cable tube slack tray, P/N379247.

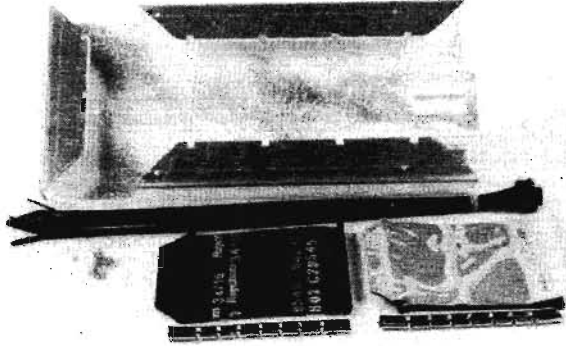

1973552

260418884 KIT FOSC 100D/TK SPLICE TRAY

1973768	1	KT	IL	IN	MI	OH	WI		
			21	21	21	21	21		

Fiber Optic Splice Closure Kit contains 3 splice trays holding 24 fibers each, P/N147695.

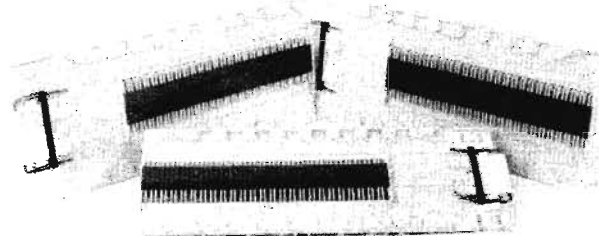

1973768

260418694 KIT FOSC 100LMB LOOP CABLE MOISTURE

1973578	1	EA	IL	IN	MI	OH	WI		
			21	21	21	21	21		

BLOCK. Fiber Optic Splice Closure kit is used to moisture block loop-thru cables. Kit contains 28 adhesive tubes, 2 wrap-around sleeves, and 24 transportation tubes, P/N784761.

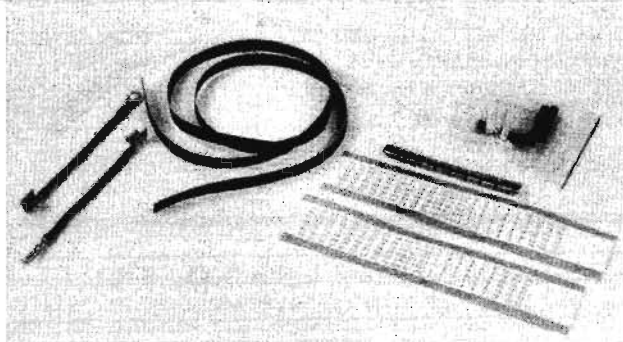

1973578

PRODUCT IDENTIFIER DESCRIPTION

ITEM NUMBER	ORD. MULT.	SELL UNIT	STD. PKG.		LEAD TIME			MIN. ORD.	A C
			STOCK AVAILABILITY / PA		IL	IN	MI		

260418702 KIT FOSC 100MB SINGLE CABLE MOISTURE

1973586	1	EA	IL	IN	MI	OH	WI		
			21	21	21	21	21		

BLOCK. Fiber Optic Splice Closure Kit is a single cable moisture block, P/N206847.

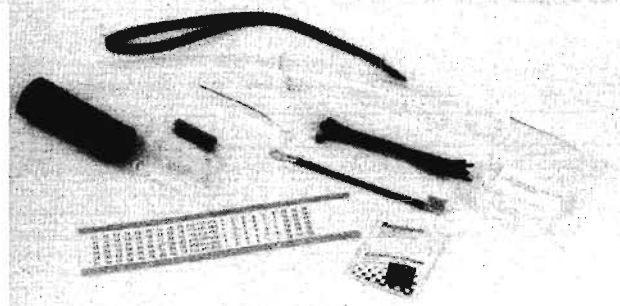

1973586

260423330 KIT FOSC 100TT

1976118	1	KT	IL	IN	MI	OH	WI		
			21	21					

Fiber Optic Splice Closure Kit contains 50 loose transportation tubes.

260418892 KIT FOSC D/TK48 SPLICE TRAY

1973776	1	KT	IL	IN	MI	OH	WI		
			21	21	21	21	21		

Fiber Optic Splice Closure Kit contains 3 splice trays holding 48 splices each, P/N435119.

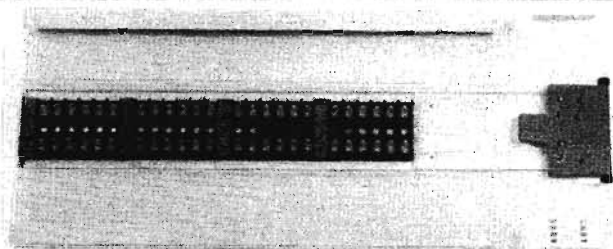

1973776

260436688 KIT TRIPLE BUTT ADAPTER 2181-A/C

1980920	1	KT	IL	IN	MI	OH	WI		
---------	---	----	----	----	----	----	----	--	--

260436704 ORGANIZER SPLICE TRAY 2524-FT

1980946	1	EA	IL	IN	MI	OH	WI		
---------	---	----	----	----	----	----	----	--	--

Fiber optic splice tray used in a 2178A splice case for fusion and/or fiberlok splices.

CLOSURE SPLICE

103100434 CLOSURE SPLICE 50B3

1332718	1	EA							
---------	---	----	--	--	--	--	--	--	--

Gas tight closure for aerial or underground straight splices. For cables up to 1.6in diameter, BSP 633-506-205.

102902368 CLOSURE SPLICE 50C3

1332700	1	EA	IL	IN	MI	OH	WI		
			08	08	08	08	08		

For cables up to 2.2in diameter.

CLOSURE SPLICE

DISTRIBUTION SERVICES

PRODUCT IDENTIFIER		DESCRIPTION						
ITEM NUMBER	ORD. MULT.	SELL UNIT	STD. PKG. STOCK AVAILABILITY / PA	LEAD TIME	MIN. ORD.	A	C	

102902376 CLOSURE SPLICE 50D3
 1332676 1 EA IL IN MI OH WI
 08 08 08 08
 For cables up to 3in diameter.

102902384 CLOSURE SPLICE 51B3
 1332692 1 EA IL IN MI OH WI
 08 08 08 08
 Gas tight closure for aerial or underground Y or double Y splices. For cables up to 1.6in diameter, BSP 633-506-205.

103199444 CLOSURE SPLICE 51D3
 1332684 1 EA IL IN MI OH WI
 08 08 08 08
 For use on cable up to 3in diameter.

103921938 CLOSURE SPLICE 51D3-LG2
 1218859 1 EA IL IN MI OH WI
 21 21 21 21 21
 Closure to encapsulate UCB1 for fiber optic cable splicing.

NETWORK SERVICES

TOOLS

BUILDING JANITORIAL

AUTOMOTIVE

FORMS/OFFICE SUPPLIES

GENERAL

DATA VOICE

CLOSURE VAULT & RISER

260329503	CLOSURE VAULT & RISER KB 2-100-2	N	KT	1	2	1
260346176	CLOSURE VAULT & RISER KB 2-2-1.0	N	KT	1	2	1
	2in butt.					
300015245	CLOSURE VAULT & RISER KB 3-175-1	N	KT	1	2	1
260346184	CLOSURE VAULT & RISER KB 3-3-1.0	N	KT	1	2	1
	3in butt, 78-8026-7435-4 SJ.					
260346036	CLOSURE VAULT & RISER KB 4-175-1	N	KT	1	2	1
	1 per kit.					
260346044	CLOSURE VAULT & RISER KB 4-175-2	N	KT	1	2	1
	1 per kit.					
260323456	CLOSURE VAULT & RISER KB 5-100-6	N	KT	1	2	1
260346051	CLOSURE VAULT & RISER KB 5-130-6	N	KT	1	2	1
260346069	CLOSURE VAULT & RISER KB 5-175-2	N	KT	1	2	1
	1 per kit.					
260346192	CLOSURE VAULT & RISER KB 5-4	N	KT	1	2	1
	5in butt, 78-8026-7436-2 SJ.					
260346077	CLOSURE VAULT & RISER KB 6-130-9	N	KT	1	2	1

PRODUCT IDENTIFIER		DESCRIPTION						
ITEM NUMBER	ORD. MULT.	SELL UNIT	STD. PKG. STOCK AVAILABILITY / PA	LEAD TIME	MIN. ORD.	A	C	

260346085	CLOSURE VAULT & RISER KB 6-175-3	N	KT	1	2	1
260346093	CLOSURE VAULT & RISER KB 7-175-5	N	KT	1	2	1
260346101	CLOSURE VAULT & RISER KB 8-130-18	N	KT	1	2	1
260346119	CLOSURE VAULT & RISER KB 8-175-8	N	KT	1	2	1
260346127	CLOSURE VAULT & RISER KB 9-130-24	N	KT	1	2	1
401397351	CLOSURE VAULT & RISER KB 9-175-9	N	KT	1	2	1
260346135	CLOSURE VAULT & RISER KB10-100-36	N	KT	1	2	1
260346143	CLOSURE VAULT & RISER KB10-100-36L	N	KT	1	2	1
260346168	CLOSURE VAULT & RISER KB12-130-37	N	KT	1	2	1
260345921	CLOSURE VAULT & RISER KBS 3-175	N	KT	1	2	1
	1 per kit.					
260345939	CLOSURE VAULT & RISER KBS 5-100-6	N	KT	1	2	1
	1 per kit.					
260345947	CLOSURE VAULT & RISER KBS 5-130-6	N	KT	1	2	1
	1 per kit.					
260345954	CLOSURE VAULT & RISER KBS 5-175-2	N	KT	1	2	1
	1 per kit.					
300015328	CLOSURE VAULT & RISER KBS 6-100-9	N	KT	1	2	1
260345897	CLOSURE VAULT & RISER KBS 6-130-9	N	KT	1	2	1
	1 per kit.					
260345962	CLOSURE VAULT & RISER KBS 6-175-3	N	KT	1	2	1
	1 per kit.					
260323290	CLOSURE VAULT & RISER KBS 7-100-15	N	KT	1	2	1
260345970	CLOSURE VAULT & RISER KBS 7-175-5	N	KT	1	2	1
	1 per kit.					
260345988	CLOSURE VAULT & RISER KBS 8-100-24	N	KT	1	2	1
	1 per kit.					

DISTRIBUTION SERVICES

NETWORK SERVICES

TOOLS

BUILDING JANITORIAL

AUTOMOTIVE

FORMS/OFFICE SUPPLIES

GENERAL

DATA VOICE

PRODUCT IDENTIFIER		DESCRIPTION				
ITEM NUMBER	ORD. MULT.	SELL UNIT	STD. PKG. STOCK AVAILABILITY / PA	LEAD TIME	MIN. ORD.	A C
260345905		CLOSURE VAULT & RISER KBS 8-130-18				
N		KT	1	2	1	
		1 per kit.				
260345996		CLOSURE VAULT & RISER KBS 8-175-8				
N		KT	1	2	1	
		1 per kit.				
260346002		CLOSURE VAULT & RISER KBS 9-100-27				
N		KT	1	2	1	
		1 per kit.				
260345913		CLOSURE VAULT & RISER KBS 9-130-24				
N		KT	1	2	1	
		1 per kit.				
300015336		CLOSURE VAULT & RISER KBS 9-175-9				
N		KT	1	2	1	
260346010		CLOSURE VAULT & RISER KBS10-100-36				
N		KT	1	2	1	
		26in.				
260346028		CLOSURE VAULT & RISER KBS10-100-36L				
N		KT	1	2	1	
		1 per kit, 34in.				

CLOSURE WIRE

401818554		CLOSURE WIRE B				
N		EA	90	6	90	
001244581		CLOSURE WIRE MB-5				
1166512	1	EA	IL IN MI OH WI			
			08 08 08 08 08			
		Used exclusively by Ohio & Michigan. Storage post 5IN ID with 52IN inside height. Stores 100FT of 5 pair drop wire.				
300037512		CLOSURE WIRE SERVICE C8810				
6505826	1	EA	IL IN MI OH WI			
			08 08 08 08 08			
		Used to encapsulate 1 or 2 pair C service wire splices.				
300037504		CLOSURE WIRE SERVICE C8811				
6505818	1	EA	IL IN MI OH WI			
			08 08 08 08 08			
		Used to encapsulate 2 to 5 pair C service wire splices.				

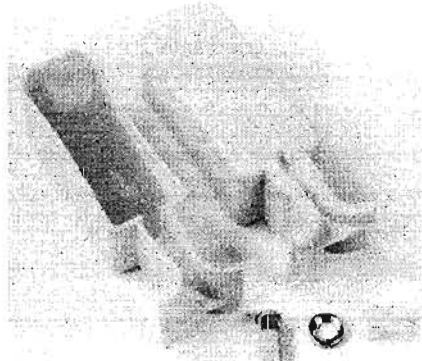

6505818

PRODUCT IDENTIFIER		DESCRIPTION				
ITEM NUMBER	ORD. MULT.	SELL UNIT	STD. PKG. STOCK AVAILABILITY / PA	LEAD TIME	MIN. ORD.	A C
260437108		CLOSURE WIRE SERVICE C8813				
N		EA	60	4	60	
300068491		CLOSURE WIRE STORAGE UP-10/250B				
N		EA	30	12	30	

CLOSURE XAGA

260328067 CLOSURE XAGA 1000-A2
1945725 1 EA
A heat shrinkable closure that can be used for buried air core pressurized cable.

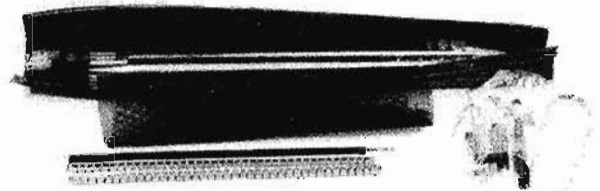

260328067

260322979 CLOSURE XAGA 1000-B2
1943415 1 EA IL IN MI OH WI
08 08 08 08 08
A heat shrinkable closure that can be used for buried air core pressurized cable.

260322987 CLOSURE XAGA 1000-C2
1943373 1 EA IL IN MI OH WI
08 08 08 08 08
A heat shrinkable closure that can be used for buried air core pressurized cable.

260322995 CLOSURE XAGA 1000-D2
1943381 1 EA IL IN MI OH WI
08 08 08 08 08
A heat shrinkable closure that can be used for buried air core pressurized cable.

260323001 CLOSURE XAGA 1000-E2
1943407 1 EA IL IN MI OH WI
08 08 08 08 08
A heat shrinkable closure that can be used for buried air core pressurized cable.

260323019 CLOSURE XAGA 1000-E3
1943399 1 EA IL IN MI OH WI
08 08 08 08 08
A heat shrinkable closure that can be used for buried air core pressurized cable.

260329354 CLOSURE XAGA 1850-A
1946228 1 EA IL IN MI OH WI
08 08 08 08 08
An encapsulated heat shrinkable closure that is used in buried distribution cables.

260329230 CLOSURE XAGA 1650-A2
1946202 1 EA IL IN MI OH WI
08 08 08 08 08
An encapsulated heat shrinkable closure that is used in buried distribution cables.

CLOSURE XAGA

PRODUCT IDENTIFIER DESCRIPTION

ITEM NUMBER	ORD. MULT.	SELL UNIT	STD. PKG. STOCK AVAILABILITY / PA	LEAD TIME	MIN. ORD.	A C
-------------	------------	-----------	-----------------------------------	-----------	-----------	-----

260329248 CLOSURE XAGA 1650-A4
 1946194 1 EA IL IN MI OH WI
 08 08 08 08 08
 An encapsulated heat shrinkable closure that is used in buried distribution cables.

260329255 CLOSURE XAGA 1650-B2
 1946186 1 EA IL IN MI OH WI
 08 08 08 08 08
 An encapsulated heat shrinkable closure that is used in buried distribution cables.

260329263 CLOSURE XAGA 1650-B4
 1946178 1 EA IL IN MI OH WI
 08 08 08 08 08
 An encapsulated heat shrinkable closure that is used in buried distribution cables.

260329271 CLOSURE XAGA 1650-C2
 1946160 1 EA IL IN MI OH WI
 08 08 08 08 08
 An encapsulated heat shrinkable closure that is used in buried distribution cables.

260329289 CLOSURE XAGA 1650-C4
 1946152 1 EA IL IN MI OH WI
 08 08 08 08 08
 An encapsulated heat shrinkable closure that is used in buried distribution cables.

260329297 CLOSURE XAGA 1650-D2
 1946145 1 EA IL IN MI OH WI
 08 08 08 08 08
 An encapsulated heat shrinkable closure that is used in buried distribution cables.

260329305 CLOSURE XAGA 1650-D4
 1946137 1 EA IL IN MI OH WI
 08 08 08 08 08
 An encapsulated heat shrinkable closure that is used in buried distribution cables.

260329347 CLOSURE XAGA 1650-S
 1946210 1 EA IL IN MI OH WI
 08 08 08 08 08
 An encapsulated heat shrinkable closure that is used in buried distribution cables.

COIN - SEE PUBLIC COMMUNICATION EQUIP.

COMPOUND

900687773 COMPOUND B CORD RELEASE C-3018
 N EA 12 4 12

PRODUCT IDENTIFIER DESCRIPTION

ITEM NUMBER	ORD. MULT.	SELL UNIT	STD. PKG. STOCK AVAILABILITY / PA	LEAD TIME	MIN. ORD.	A C
-------------	------------	-----------	-----------------------------------	-----------	-----------	-----

260419353 COMPOUND BUFFERING PLASTIC 10Z
 1974261 1 BT IL IN MI OH WI
 21 21 21 21 21
 Used to recoat bare fiber after splice.



1974261

996292397 COMPOUND CK16832 L 2 LUBRICATING
 1200444 1 BT IL IN MI OH WI
 32 32 32 32 32
 2oz used on SXS switches, BSP 065-330-110.

400864484 COMPOUND CK19094 L 1 8OZ TUBE
 1132530 1 TU IL IN MI OH WI
 08 08 08 08 08
 Compound used on metal screws to prevent corrosion when used in aluminum booths etc.

900450271 COMPOUND DC4 5.3OZ TUBE
 N TU 12 2 12
 FORWARD TO SEALANT B 30Z TUBE

280049867 COMPOUND DUCT SEAL KIT 6OZ
 1948398 1 CS IL IN MI OH WI
 08 08 08 08 08
 Conduit, case of 12.

005734827 COMPOUND JEL E KLEEN RP6012
 N EA 4 4 4
 One gallon container.

400776274 COMPOUND JOINT PIPETITE
 1132688 1 GR IL IN MI OH WI
 08 08 08 08 08
 For lubricating threads of pressure testing fittings before placing, for easy removal.

300088895 COMPOUND LEAD ENTRAPMENT
 1920686 12 TU IL IN MI OH WI
 08 08 08 08 08
 Used in lead cable applications to ensure proper clean up of lead particles.

900304783 COMPOUND PIC-PLUGDAM RP6004
 1451260 1 EA IL IN MI OH WI
 08 08 08 08 08
 6oz green polyurethane compound for plugging PIC cable.

401990783 COMPOUND R3266 L 1 NONOXIDE
 5122879 1 EA IL IN MI OH WI
 18 18 18 18 18

DISTRIBUTION SERVICES

NETWORK SERVICES

TOOLS

BUILDING JANITORIAL

AUTOMOTIVE

FORMS/OFFICE SUPPLIES

GENERAL

DATA VOICE

DISTRIBUTION SERVICES

NETWORK SERVICES

TOOLS

BUILDING JANITORIAL

AUTOMOTIVE

FORMS/OFFICE SUPPLIES

GENERAL

DATA VOICE

PRODUCT IDENTIFIER		DESCRIPTION				
ITEM NUMBER	ORD. MULT.	SELL UNIT	STD. PKG. STOCK AVAILABILITY / PA	LEAD TIME	MIN. ORD.	A C

COMPOUND BLOCKING

900340696 COMPOUND BLOCKING 4407B
 5123059 1 BG
 Replaces encapsulant B 180GM KT.



900340696

900340704 COMPOUND BLOCKING 4407C
 5123372 1 BG
 420 grams.

900340712 COMPOUND BLOCKING 4407D
 1177279 1 BG
 675 grams.

300072170 COMPOUND BLOCKING 4408D
 1154518 1 BG
 600 grams.

300072188 COMPOUND BLOCKING 4408E
 5123497 1 BG
 300 grams.

COMPOUND CAULKING

401925292 COMPOUND CAULKING B 1LB CA08832
 1204578 1 PK
 Fire retardant caulking compound used in fire stopping cable holes below main frames, BSP 632-305-903N.

401925300 COMPOUND CAULKING B 5LB CA08832
 1195537 1 PK

COMPOUND PLUG

900651373 COMPOUND PLUG PR 868- 06
 5285502 1 CS
 Case of 24.

000246652 COMPOUND PLUG PR 868- 20 20OZ
 5285601 1 CS
 Case of 12.

PRODUCT IDENTIFIER		DESCRIPTION				
ITEM NUMBER	ORD. MULT.	SELL UNIT	STD. PKG. STOCK AVAILABILITY / PA	LEAD TIME	MIN. ORD.	A C

900342072 COMPOUND PLUG RP6000 6OZ
 1451245 1 EA
 IL IN MI OH WI
 08 08 08 08
 An off white polyurethane compound for plugging pulp or paper insulated cable.

COMPOUND SEAL

300017746 COMPOUND SEAL PR 850-02 2OZ
 N CS 1 3 1
 Case of 20. NOW AVAILABLE THROUGH TOUCH-TONE ORDER ENTRY.

300017753 COMPOUND SEAL PR 850-06
 1934422 1 CS
 IL IN MI OH WI
 08 08 08 08

002039147 COMPOUND SEAL PR 851-06
 1158758 1 CS
 IL IN MI OH WI
 08 08 08 08
 An expanding compound used as a water stop in conduits subject to water flow. Case of 20.

CONCAP

260358197 CONCAP RE-4IN
 N EA 75 6 75
 End cap for pre-connecterized cable.

260358189 CONCAP RE-6IN
 N EA 25 6 25
 End cap for pre-connecterized cable.

CONCENTRATE

400124368 CONCENTRATE TEST PRESSURE E
 N GL 4 3 108
 A replacement for the B, C, and D pressure testing concentrate. For locating leaks in lead and polyethylene jacketed cables, one gallon bottle, CA08287 - BSP 637-020-100.

CONDUIT

002011120 CONDUIT PLASTIC 1/2IN
 1139956 1 BD
 Heavy wall rigid PVC conduit 1/2in inside diameter 7 1/2ft in length. Provided with a 90 degree bend on one end. Used to protect buried drop at pole and building locations.



002011120

DISTRIBUTION SERVICES

CONDUIT

PRODUCT IDENTIFIER		DESCRIPTION				
ITEM NUMBER	ORD. MULT.	SELL UNIT	STD. PKG. STOCK AVAILABILITY / PA	LEAD TIME	MIN. ORD.	A C
401358593			CONDUIT PLASTIC B 4 IN	SPLIT		
N		FT	50	2	50	
DISCONTINUE, ORDER NON STOCK UPON STOCK DEPLETION						

NETWORK SERVICES

PRODUCT IDENTIFIER		DESCRIPTION				
ITEM NUMBER	ORD. MULT.	SELL UNIT	STD. PKG. STOCK AVAILABILITY / PA	LEAD TIME	MIN. ORD.	A C
401022454			CONDUIT PLASTIC C 4IN X 20FT			
5116970	1520	EA	IL IN MI OH WI 35 35 35			

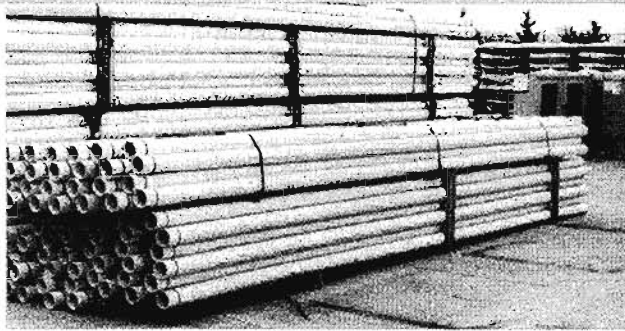

5116970

TOOLS

BUILDING JANITORIAL

PRODUCT IDENTIFIER		DESCRIPTION				
ITEM NUMBER	ORD. MULT.	SELL UNIT	STD. PKG. STOCK AVAILABILITY / PA	LEAD TIME	MIN. ORD.	A C
280010356			CONDUIT PVC B DUCT 4IN X 20FT			
N		FT	1	1	1	
Single bore solid.						

PRODUCT IDENTIFIER		DESCRIPTION				
ITEM NUMBER	ORD. MULT.	SELL UNIT	STD. PKG. STOCK AVAILABILITY / PA	LEAD TIME	MIN. ORD.	A C
280010364			CONDUIT PVC C DUCT 4IN X 20FT			
N		FT	1	1	1	
Single bore solid.						

PRODUCT IDENTIFIER		DESCRIPTION				
ITEM NUMBER	ORD. MULT.	SELL UNIT	STD. PKG. STOCK AVAILABILITY / PA	LEAD TIME	MIN. ORD.	A C
280010372			CONDUIT PVC D DUCT 4IN X 20FT			
N		FT	1	1	1	
Single bore solid.						

PRODUCT IDENTIFIER		DESCRIPTION				
ITEM NUMBER	ORD. MULT.	SELL UNIT	STD. PKG. STOCK AVAILABILITY / PA	LEAD TIME	MIN. ORD.	A C
260432984			CONDUIT PVC SINGLE BORE SPLIT 3.5 X 10FT			
N		FT	1	1	1	

PRODUCT IDENTIFIER		DESCRIPTION				
ITEM NUMBER	ORD. MULT.	SELL UNIT	STD. PKG. STOCK AVAILABILITY / PA	LEAD TIME	MIN. ORD.	A C
260432976			CONDUIT PVC 'C' SPLIT DUCT 4IN X 10FT			
N		FT	1	1	1	
Single bore.						

AUTOMOTIVE

FORMS/OFFICE SUPPLIES

PRODUCT IDENTIFIER		DESCRIPTION				
ITEM NUMBER	ORD. MULT.	SELL UNIT	STD. PKG. STOCK AVAILABILITY / PA	LEAD TIME	MIN. ORD.	A C
996180709			CONDUIT THINWALL 1/2IN			
5183442	10	FT	IL IN MI OH WI 35 35 35 35 35			
Ten 10ft pieces bundled together, 1/2in galvanized pipe.						

CONNECTING BLOCK

SEE BLOCK CONNECTING.

CONNECTOR

PRODUCT IDENTIFIER		DESCRIPTION				
ITEM NUMBER	ORD. MULT.	SELL UNIT	STD. PKG. STOCK AVAILABILITY / PA	LEAD TIME	MIN. ORD.	A C
104316583			CONNECTOR 3 B/ST F85AK8528			
N		EA	1	6	1	

PRODUCT IDENTIFIER		DESCRIPTION				
ITEM NUMBER	ORD. MULT.	SELL UNIT	STD. PKG. STOCK AVAILABILITY / PA	LEAD TIME	MIN. ORD.	A C
260319736			CONNECTOR 939A T1R0C01			
N		EA	1	13	1	

PRODUCT IDENTIFIER		DESCRIPTION				
ITEM NUMBER	ORD. MULT.	SELL UNIT	STD. PKG. STOCK AVAILABILITY / PA	LEAD TIME	MIN. ORD.	A C
260319728			CONNECTOR 939C			
1311092	1	EA	IL IN MI OH WI 08 08 08 08 08			
Plug-in connector used in carrier apparatus cases. BSP 640-525-315.						

GENERAL

DATA VOICE

PRODUCT IDENTIFIER		DESCRIPTION				
ITEM NUMBER	ORD. MULT.	SELL UNIT	STD. PKG. STOCK AVAILABILITY / PA	LEAD TIME	MIN. ORD.	A C

102814449			CONNECTOR 977A			
N		EA	1	13	1	

103922662			CONNECTOR 1005 B/140 F83AK8578			
N		EA	1	4	1	

300085578			CONNECTOR 3131 METAL END W/HEX NIPPLE			
N		EA	1	2	1	

103257515			CONNECTOR 710 BB125			
N		EA	24	1	24	
NOW AVAILABLE THROUGH TOUCH-TONE ORDER ENTRY.						

260436985			CONNECTOR ASSEMBLY 15-PIN			
N		EA	250	8	250	

PRODUCT IDENTIFIER		DESCRIPTION				
ITEM NUMBER	ORD. MULT.	SELL UNIT	STD. PKG. STOCK AVAILABILITY / PA	LEAD TIME	MIN. ORD.	A C
260436589			CONNECTOR BLOCK 80 PIN PJ608			
1980821		EA	IL IN MI OH WI 09			

PRODUCT IDENTIFIER		DESCRIPTION				
ITEM NUMBER	ORD. MULT.	SELL UNIT	STD. PKG. STOCK AVAILABILITY / PA	LEAD TIME	MIN. ORD.	A C
260421953			CONNECTOR BOND SHIELD 4480D			
1975243		EA	IL IN MI OH WI 08 08 08 08			

PRODUCT IDENTIFIER		DESCRIPTION				
ITEM NUMBER	ORD. MULT.	SELL UNIT	STD. PKG. STOCK AVAILABILITY / PA	LEAD TIME	MIN. ORD.	A C
280054362			CONNECTOR BOND SHIELD 4462-SNA			
1929869	100	EA	IL IN MI OH WI 08 08 08 08 08			
Box of 100.						

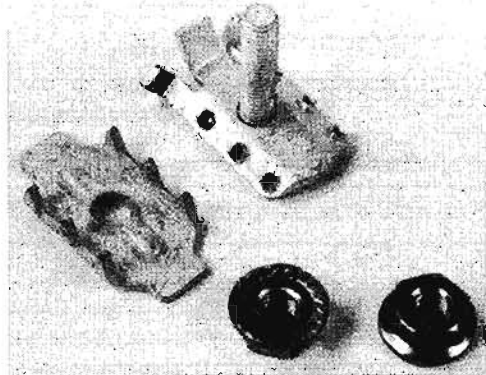

1929869

400127569			CONNECTOR BRIDGING 3B CA07249			
N		EA	1	4	1	
Used for connecting AL, HD or block wire to 104 and 128 copper or copper steel line wire, BSP 623-300-202.						

PRODUCT IDENTIFIER		DESCRIPTION				
ITEM NUMBER	ORD. MULT.	SELL UNIT	STD. PKG. STOCK AVAILABILITY / PA	LEAD TIME	MIN. ORD.	A C
400127585			CONNECTOR C CA08270			
1138511	1	EA	IL IN MI OH WI 08 08 08 08 08			
Used for attaching B ground wire to 6.6M strand associated with self supporting cable, BSP 627-700-014.						

260427836			CONNECTOR C TAP 54715 GRAY			
N		EA	100	6	100	

PRODUCT IDENTIFIER		DESCRIPTION				
ITEM NUMBER	ORD. MULT.	SELL UNIT	STD. PKG. STOCK AVAILABILITY / PA	LEAD TIME	MIN. ORD.	A C
260394069			CONNECTOR C TAP BROWN 54720			
1968747	1	EA	IL IN MI OH WI 08 08 08 08			
Splice #6 AWG solid ground wire in C.O. vaults.						

DISTRIBUTION SERVICES

NETWORK SERVICES

TOOLS

BUILDING JANITORIAL

AUTOMOTIVE

FORMS/OFFICE SUPPLIES

GENERAL

DATA VOICE

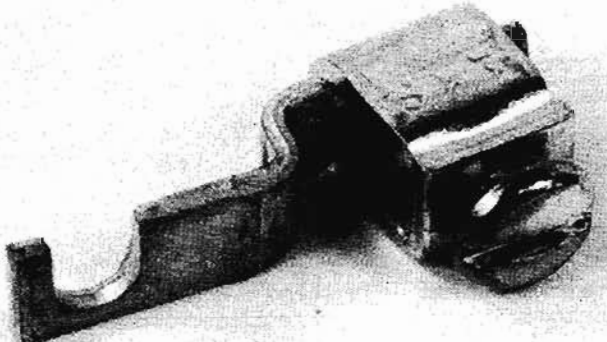
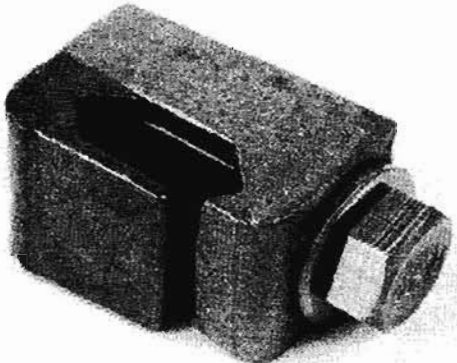
PRODUCT IDENTIFIER		DESCRIPTION					
ITEM NUMBER	ORD. MULT.	SELL UNIT	STD. PKG. STOCK AVAILABILITY / PA	LEAD TIME	MIN. ORD.	A C	
260394077 CONNECTOR C TAP GREEN 54725TP							
1966754	1	EA	IL IN MI OH WI 08				
Splice flat bonding ribbon in manholes.							
401815501 CONNECTOR CK21500 L13							
N		EA	1	1	1		
401815519 CONNECTOR CK21500 L14							
N		EA	1	1	1		
280026501 CONNECTOR DROP WIRE AERIAL CDS-1							
N		EA	50	6	100		
400456000 CONNECTOR F CA08523							
1297408	1	EA	IL IN MI OH WI 18 18 18 18 18				
Package of 100. Used to bond the wrapped aluminum tape of B service wire to the grounding post of a protector or terminal, BSP 629-720-205.							
							
1297408							
001145879 CONNECTOR FARGO 5020							
1405589	1	EA	IL IN MI OH WI 08 08 08 08				
							
1405589							
280039231 CONNECTOR FARGO GA 620C							
1924258	1	EA	IL IN MI OH WI 18				
Aluminum connector for connecting galvanized or aluminum-clad strand to copper conductors. Strand range 1/4 - 3/8, conductor range 2/0 - 8.							

PRODUCT IDENTIFIER		DESCRIPTION					
ITEM NUMBER	ORD. MULT.	SELL UNIT	STD. PKG. STOCK AVAILABILITY / PA	LEAD TIME	MIN. ORD.	A C	
402587539 CONNECTOR G CA08944							
1437962	1	EA	IL IN MI OH WI 08 08 08 08 08				
This vice type connector is intended to provide a means of making solderless connections on plain bonding ribbon in manholes and cable vaults, BSP 638-300-2126.							

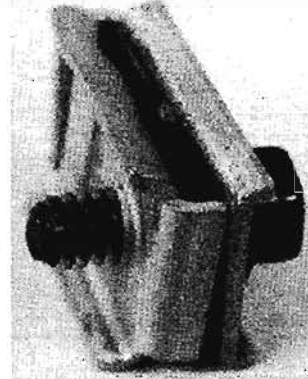

1437962

PRODUCT IDENTIFIER		DESCRIPTION					
ITEM NUMBER	ORD. MULT.	SELL UNIT	STD. PKG. STOCK AVAILABILITY / PA	LEAD TIME	MIN. ORD.	A C	
403370075 CONNECTOR GROUND H1 CA08980							
1333377	1	EA	IL IN MI OH WI 08 08 08 08 08				
Package of 5. A three piece wire grip type bronze connector intended to join ground wires numbers 6 thru 10 to numbers 4 thru 6 or the aluminum tape of a B service wire at the terminal end.							

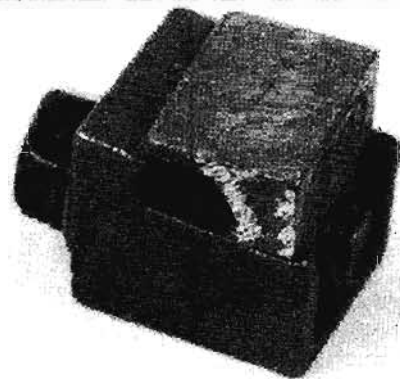

1333377

CONNECTOR

DISTRIBUTION SERVICES

PRODUCT IDENTIFIER		DESCRIPTION				
ITEM NUMBER	ORD. MULT.	SELL UNIT	STD. PKG. STOCK AVAILABILITY / PA	LEAD TIME	MIN. ORD.	A C

402689244 CONNECTOR GROUND H2 CA08980
 1440669 1 EA IL IN MI OH WI
 18 18 18 18 18
 Package of 5. Used for bonding station ground wire to power ground wire. Conductor size 14 thru 4, BSP 460-100-201.

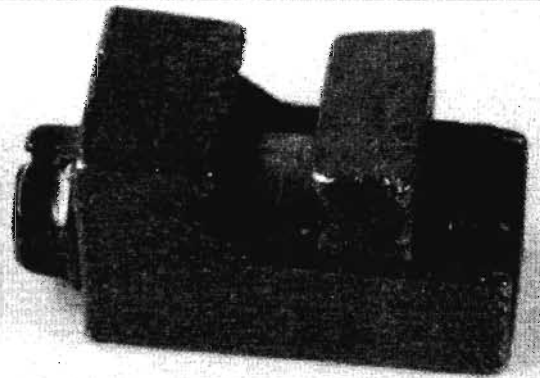

1440669

260440979 CONNECTOR GROUND SHIELD KON 201RSKA
 N EA 100 2 1000

841634165 CONNECTOR L CB30009 841634165
 1442343 1 EA IL IN MI OH WI
 18 18 18 18 18
 Used to connect service wire shield to ground terminal of protector mounted in 93D type mounting. BSP 460-100-400.

260386578 CONNECTOR LG-P3020A-C-125
 1963850 1 EA IL IN MI OH WI
 09 09 09 09 09

103707188 CONNECTOR LIGID 1009C
 N EA 1 2 1
 Consists of 2 negative silicon chips bonded to stainless steel shims and 2 spring fasteners. Need tool 9333.

103878310 CONNECTOR LIGID 1012A
 N EA 1 2 1
 Provides optical connection between 2 LS1A-A lightguide interconnection cables. No provision for mounting.

105271118 CONNECTOR P3020A-C-125 ST
 N EA 1 2 1
 NOW AVAILABLE THROUGH TOUCH-TONE ORDER ENTRY.

401358817 CONNECTOR SOLDERLESS ID74B
 1108035 100 EA IL IN MI OH WI
 18
 DISCONTINUE, ORDER NON STOCK UPON STOCK DEPLETION

401358825 CONNECTOR SOLDERLESS ID76B
 1150458 100 EA IL IN MI OH WI
 18
 DISCONTINUE, ORDER NON STOCK UPON STOCK DEPLETION

400129128 CONNECTOR STRAND POLE CA6916
 N EA 10 8 20

NETWORK SERVICES

TOOLS

BUILDING JANITORIAL

AUTOMOTIVE

FORMS/OFFICE SUPPLIES

GENERAL

DATA VOICE

PRODUCT IDENTIFIER		DESCRIPTION				
ITEM NUMBER	ORD. MULT.	SELL UNIT	STD. PKG. STOCK AVAILABILITY / PA	LEAD TIME	MIN. ORD.	A C

280027897 CONNECTOR TRIMLOK 211
 1923292 1 EA IL IN MI OH WI
 08 08 08 08 08
 Box of 100. Non service interrupting connector used for removal of existing problem connectors or for standard two wire butt type splicing operations.

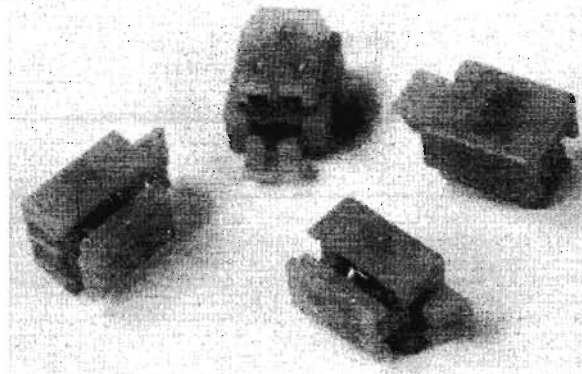

1923292

260394085 CONNECTOR TWO HOLE LUG BLUE 54205
 1966770 1 EA IL IN MI OH WI
 08 08 08 08 08
 Crimped on end of #6 AWG solid ground wire to provide termination on bus bars.

CONNECTOR ADAPTER

105219158 CONNECTOR ADAPTER 1A AT&T BIC
 N EA 1 4 1

105219166 CONNECTOR ADAPTER 2A AT DATAI
 N EA 1 4 1

105219174 CONNECTOR ADAPTER 3A AT&T ST
 N EA 1 4 1

105219182 CONNECTOR ADAPTER 4A NTT FC
 N EA 1 14 1

105219190 CONNECTOR ADAPTER 5A MIL 82SMA
 N EA 1 4 1

105219208 CONNECTOR ADAPTER 6A DEC D4
 N EA 1 4 1

105219216 CONNECTOR ADAPTER 7A FUJI OF-2
 N EA 1 4 1

105219224 CONNECTOR ADAPTER 8A HITACH H
 N EA 1 4 1

105219232 CONNECTOR ADAPTER 9A TOS TL80-82
 N EA 1 4 1

105219240 CONNECTOR ADAPTER 10A SUMITOMO
 N EA 1 4 1

105219257 CONNECTOR ADAPTER 11A SIECOR SC
 N EA 1 4 1

DISTRIBUTION SERVICES

NETWORK SERVICES

TOOLS

BUILDING JANITORIAL

AUTOMOTIVE

FORMS/OFFICE SUPPLIES

GENERAL

DATA VOICE

PRODUCT IDENTIFIER		DESCRIPTION				
ITEM NUMBER	ORD. MULT.	SELL UNIT	STD. PKG. STOCK AVAILABILITY / PA	LEAD TIME	MIN. ORD.	A C
105219265	N	EA	1	4	1	

CONNECTOR CABLE
SEE CABLE CONNECTOR.

CONNECTOR COUPLING

103221602	N	EA	1	2	1	
103239836	N	EA	1	2	1	NOW AVAILABLE THROUGH TOUCH-TONE ORDER ENTRY.
103239844	N	EA	1	2	1	
104300124	N	EA	1	2	1	

CONNECTOR MODULE

260384680	1969873	1	EA							SUPER MINI
Dry-flame retardant module used for straight splices inside.										
260384698	1968503	1	EA	IL 08	IN 08	MI	OH	WI 08		FR PLUG
Dry-flame retardant module used for straight and bridge splices inside of buildings.										
260384706	1968495	1	EA	IL 08	IN 08	MI 08	OH 08	WI 08		HALF TAP
Dry-flame retardant module used when half-tapping inside of buildings.										
401549480	1217943	1	EA	IL 08	IN 08	MI 08	OH 08	WI 08		FEEDER
For terminating feeder cable pairs in 3M company pedestal and pole mounted cabinets, 12 modules per bag, 10 bags per carton, BSP 631-620-900W.										
401349188	1219063	1	EA	IL 08	IN 08	MI	OH	WI 08		DISTRIBUTION
For terminating distribution cable pairs in various 3M company pedestal and pole mounted cabinets, 12 modules per bag, 10 bags per carton, BSP 631-620-900W.										

PRODUCT IDENTIFIER		DESCRIPTION				
ITEM NUMBER	ORD. MULT.	SELL UNIT	STD. PKG. STOCK AVAILABILITY / PA	LEAD TIME	MIN. ORD.	A C
260388632						

1965285 1 EA IL 08 IN 08 MI 08 OH 08 WI 08
Used for high production cable splicing and cable repair operations.

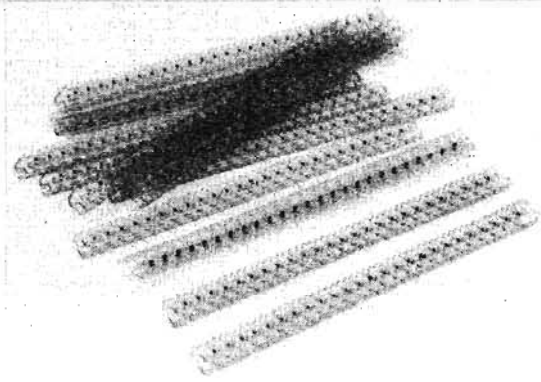

1965285

260386016	1965293	1	EA	IL 08	IN 08	MI 08	OH 08	WI 08		CONNECTOR MODULE CLEAR 4000DT/TR
-----------	---------	---	----	-------	-------	-------	-------	-------	--	----------------------------------

260388145	1965319	1	EA	IL 08	IN 08	MI 08	OH 08	WI 08		CONNECTOR MODULE CLEAR 4000D/TR
-----------	---------	---	----	-------	-------	-------	-------	-------	--	---------------------------------

260436712	1980953	1	EA	IL 08	IN	MI	OH	WI		CONNECTOR MODULE CLEAR 4005CBM/TR
-----------	---------	---	----	-------	----	----	----	----	--	-----------------------------------

260388152	1965301	1	EA	IL 08	IN 08	MI 08	OH 08	WI 08		CONNECTOR MODULE CLEAR 4005DPM/TR PLUG
-----------	---------	---	----	-------	-------	-------	-------	-------	--	--

280027764	N	EA	120				2		120	CONNECTOR MODULE CLEAR 4008C/TR
Super Mini Half Tap.										

260388640	1965327	1	EA	IL 08	IN 08	MI 08	OH 08	WI 08		CONNECTOR MODULE CLEAR 4008D/TR HALF TAP
-----------	---------	---	----	-------	-------	-------	-------	-------	--	--

280054594	1929612	1	EA	IL 04	IN 04	MI	OH	WI 04		CONNECTOR MODULE MTCE TERM UNIT
For use on the SNI 2100, used on COPTS service lines only.										

CONNECTOR PICABOND

402642714	N	EA	1				8		1	CONNECTOR PICABOND 60944-6
402039887	N	EA	1				8		1	CONNECTOR PICABOND 60946-4
Package of 1000.										
401899687	N	EA	1				8		1	CONNECTOR PICABOND 229915-2

CONNECTOR PICABOND

PRODUCT IDENTIFIER		DESCRIPTION				
ITEM NUMBER	ORD. MULT.	SELL UNIT	STD. PKG. STOCK AVAILABILITY / PA	LEAD TIME	MIN. ORD.	A C
401899695 CONNECTOR PICABOND 229917-2						
N		EA	1	8	1	
401670682 CONNECTOR PICABOND 552576-1						
N		EA	1	8	1	
401864517 CONNECTOR PICABOND 552576-2						
N		EA	1	8	1	
Package of 1000.						
401969217 CONNECTOR PICABOND 552647-2						
N		EA	1	8	1	
402204648 CONNECTOR PICABOND 552769-1						
N		EA	1	8	1	
402204655 CONNECTOR PICABOND 552769-2						
N		EA	1	8	1	

CONNECTOR PLUG

104233168 CONNECTOR PLUG 1006A SINGLE PK						
N		EA	1	2	1	
104310024 CONNECTOR PLUG 1006C						
N		EA	1	2	1	
104300249 CONNECTOR PLUG 2016A						
N		EA	1	2	1	
NOW AVAILABLE THROUGH TOUCH-TONE ORDER ENTRY.						
104310040 CONNECTOR PLUG 2016A 1						
N		EA	1	2	1	
104310032 CONNECTOR PLUG 2016C						
N		EA	1	2	1	
104310057 CONNECTOR PLUG 2016C 1						
N		EA	1	2	1	
401895826 CONNECTOR PLUG 229912-1 BLACK						
N		EA	1	4	10	

402491583 CONNECTOR PLUG 229912-4 GRAY

4429704	1	EA	IL	IN	MI	OH	WI
			18	18	18		

A 50 position male connector arranged for field installation when using the 229378-1 butterfly tool.

105218333 CONNECTOR PLUG P2020A-A-125 LG						
N		EA	1	2	1	
104148002 CONNECTOR PLUG P2020A-C-125						
N		EA	1	6	1	
105240790 CONNECTOR PLUG P2030A-C-125 LG						
N		EA	1	2	1	

PRODUCT IDENTIFIER		DESCRIPTION				
ITEM NUMBER	ORD. MULT.	SELL UNIT	STD. PKG. STOCK AVAILABILITY / PA	LEAD TIME	MIN. ORD.	A C

CONNECTOR RECEPTACLE

002082527 CONNECTOR RECEPTACLE 4151-0002						
1150144	1	EA				
A high-profile female ribbon connector used for interface with 3M-Universal plug 4162.						
280007329 CONNECTOR RECEPTACLE 229913-1						
N		EA	1	4	10	
Black.						

401306055 CONNECTOR RECEPTACLE 229913-4 GRAY

5239061	1	EA	IL	IN	MI	OH	WI
			18	18	18		

A 50 position female connector arranged for field installation when using the 229378-1 butterfly tool.

CONNECTOR SCOTCHLOK

260327655 CONNECTOR SCOTCHLOK ST CLEAR						
N		EA	100	2	100	
Box of 1000. NOW AVAILABLE THROUGH TOUCH-TONE ORDER ENTRY.						

401983846 CONNECTOR SCOTCHLOK UAL

5106880	1	EA	IL	IN	MI	OH	WI
			08	08	08	08	08

3 way, moisture resistant, for 17-20 AWG air core or 19-24 AWG solid copper air core-filled connector. Box of 100.

401358858 CONNECTOR SCOTCHLOK UAL CARTRIDGE

5106906	1	PK	IL	IN	MI	OH	WI
			08	08	08	08	08

3 way, moisture resistant, for 17-20 AWG air core or 19-24 AWG solid copper air core-filled connector.

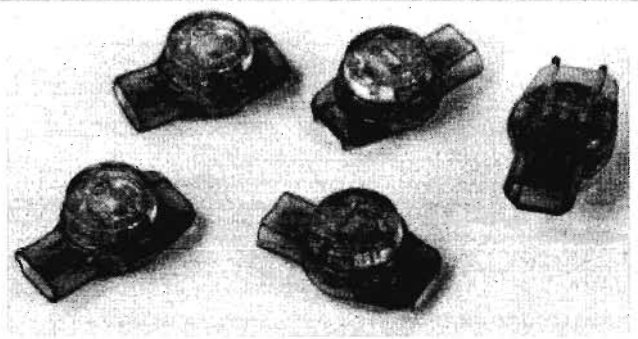

5106906

DISTRIBUTION SERVICES

NETWORK SERVICES

TOOLS

BUILDING JANITORIAL

AUTOMOTIVE

FORMS/OFFICE SUPPLIES

GENERAL

DATA VOICE

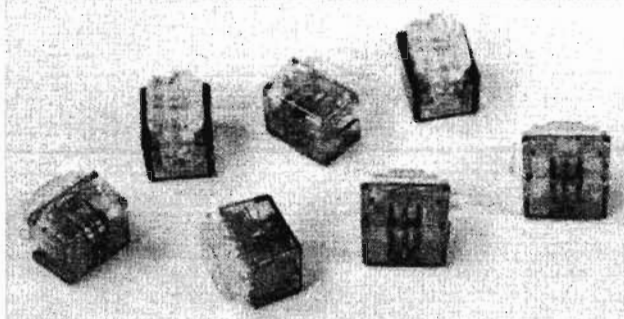
PRODUCT IDENTIFIER		DESCRIPTION					
ITEM NUMBER	ORD. MULT.	SELL UNIT	STD. PKG. STOCK AVAILABILITY / PA	LEAD TIME	MIN. ORD.	A C	
401637822 CONNECTOR SCOTCHLOK UB							
1332874	1	EA	IL 08 IN 08 MI 08 OH 08 WI 08				
A sealed, moisture resistant, two wire with pre-crimp feature, for 22-26 AWG air core or 24-26 AWG filled connector. Box of 100.							
							
1332874							
000246975 CONNECTOR SCOTCHLOK UCC CARTRIDGE							
1142091	1	PK	IL 08 IN 08 MI 08 OH 08 WI 08				
Used for clearing and capping a full pair in a cable where future use is expected, 19-26 AWG air core or 22-26 AWG filled.							
000246967 CONNECTOR SCOTCHLOK UDW							
1332866	1	EA	IL 08 IN 08 MI 08 OH 08 WI 08				
A sealed moisture resistant connector used for splicing drop wire. Case of 100.							
401271523 CONNECTOR SCOTCHLOK UG							
1133868	1	EA	IL 08 IN 08 MI 08 OH 08 WI 08				
Box of 100.							
300015393 CONNECTOR SCOTCHLOK ULG							
5114959	1	EA	IL 08 IN 08 MI 08 OH 08 WI 08				
Box of 100.							
001024975 CONNECTOR SCOTCHLOK ULG CARTRIDGE							
1332858	1	PK	IL 08 IN 08 MI 08 OH 08 WI 08				
000246934 CONNECTOR SCOTCHLOK ULG STRIP 100							
N		EA	100	3	100		
000260174 CONNECTOR SCOTCHLOK UP2							
1140657	1	EA	IL 08 IN 08 MI 08 OH 08 WI 08				
A dry 2 wire connector for splicing paper or pulp cable, in strips of 100 for use with E-9H crimper. Box of 1000.							
402596654 CONNECTOR SCOTCHLOK UP2 CARTRIDGE							
1195032	1	PK	IL 08 IN 08 MI 08 OH 08 WI 08				
A dry 2 wire connector for splicing paper or pulp cable, in strips of 100 for use with E-9H crimper.							

PRODUCT IDENTIFIER		DESCRIPTION					
ITEM NUMBER	ORD. MULT.	SELL UNIT	STD. PKG. STOCK AVAILABILITY / PA	LEAD TIME	MIN. ORD.	A C	
300015427 CONNECTOR SCOTCHLOK UP3							
1228031	1	EA	IL 08 IN 08 MI 08 OH 08 WI 08				
A dry 3 wire connector for paper or pulp cable. Box of 500.							
402596076 CONNECTOR SCOTCHLOK UP3 CARTRIDGE							
1332841	1	PK	IL 08 IN 08 MI 08 OH 08 WI 08				
A dry 3 wire connector for paper or pulp cable.							
300036704 CONNECTOR SCOTCHLOK UPB							
1332908	1	EA	IL 08 IN 08 MI 08 OH 08 WI 08				
A dry 2 wire connector with pre-crimp feature for 22-26 AWG air core, bridge connector. Box of 100.							
280057290 CONNECTOR SCOTCHLOK UPC							
1930883	1	EA	IL 08 IN 08 MI 08 OH 08 WI 08				
Box of 1000.							
260317912 CONNECTOR SCOTCHLOK UPC CARTRIDGE							
N		PK	1	3	1		
Package of 160.							
000246892 CONNECTOR SCOTCHLOK UR							
1168690	1	EA	IL 08 IN 08 MI 08 OH 08 WI 08				
A sealed 3 way connector. Box of 100.							
000238022 CONNECTOR SCOTCHLOK UR CARTRIDGE							
1217596	1	PK	IL 08 IN 08 MI 08 OH 08 WI 08				
A sealed 3 way connector in cartridges to be used with 3M E9C tool. A carton contains 10 packs of 10 cartridges of 10 connectors.							
300009537 CONNECTOR SCOTCHLOK UR CASE							
1304261	1	PK	IL 08 IN 08 MI 08 OH 08 WI 08				
000246884 CONNECTOR SCOTCHLOK UY							
5297689	1	EA	IL 08 IN 08 MI 08 OH 08 WI 08				
Same as UR only it's a 2 way connector. Box of 100.							
000246868 CONNECTOR SCOTCHLOK UY SP 100							
N		EA	100	2	100		
Same as UR only it's a 2 way connector.							
401360334 CONNECTOR SCOTCHLOK UY CARTRIDGE							
1439307	1	PK	IL 08 IN 08 MI 08 OH 08 WI 08				
Package of 160, Same as UR only it's a 2 way connector.							
CONNECTOR STRAND							
400129037 CONNECTOR STRAND CA06677							
1134049	1	EA					
Strand connectors are primarily intended for joining two different size strands. For use in splicing 6000, 6600, 10000, 16000, and 25000lb suspension strand. Galvanized cast iron, BSP 627-230-205.							

DISTRIBUTION SERVICES
 NETWORK SERVICES
 TOOLS
 BUILDING JANITORIAL
 AUTOMOTIVE
 FORMS/OFFICE SUPPLIES
 GENERAL
 DATA VOICE

CONNECTOR STRAND

PRODUCT IDENTIFIER		DESCRIPTION				
ITEM NUMBER	ORD. MULT.	SELL UNIT	STD. PKG. STOCK AVAILABILITY / PA	LEAD TIME	MIN. ORD.	A C
400129102		CONNECTOR STRAND B	2.2M	CA07939		
N		EA	100	16	100	

PRODUCT IDENTIFIER		DESCRIPTION				
ITEM NUMBER	ORD. MULT.	SELL UNIT	STD. PKG. STOCK AVAILABILITY / PA	LEAD TIME	MIN. ORD.	A C
400129110		CONNECTOR STRAND B	6M	CA07939		
1133967	1	EA	08 08 08 08 08	08 08 08 08 08		

Used to splice like sizes of galvanized strand and to reinforce damaged areas of galvanized strand, BSP 627-230-208.

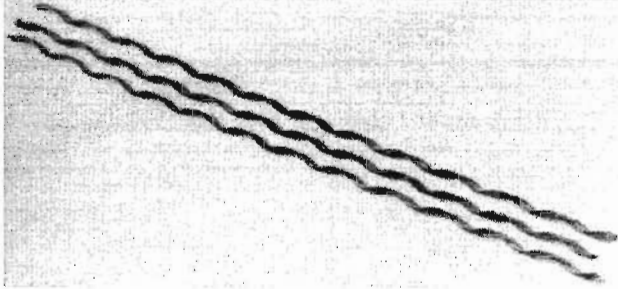

1133967

PRODUCT IDENTIFIER		DESCRIPTION				
ITEM NUMBER	ORD. MULT.	SELL UNIT	STD. PKG. STOCK AVAILABILITY / PA	LEAD TIME	MIN. ORD.	A C
400129060		CONNECTOR STRAND B	6.6M	CA07939		
1133983	1	EA	08 08 08 08 08	08 08 08 08 08		

PRODUCT IDENTIFIER		DESCRIPTION				
ITEM NUMBER	ORD. MULT.	SELL UNIT	STD. PKG. STOCK AVAILABILITY / PA	LEAD TIME	MIN. ORD.	A C
400129078		CONNECTOR STRAND B	10M	CA07939		
1134007	1	EA	08 08 08 08 08	08 08 08 08 08		

PRODUCT IDENTIFIER		DESCRIPTION				
ITEM NUMBER	ORD. MULT.	SELL UNIT	STD. PKG. STOCK AVAILABILITY / PA	LEAD TIME	MIN. ORD.	A C
400129086		CONNECTOR STRAND B	16M	CA07939		
N		EA	25	4	50	

PRODUCT IDENTIFIER		DESCRIPTION				
ITEM NUMBER	ORD. MULT.	SELL UNIT	STD. PKG. STOCK AVAILABILITY / PA	LEAD TIME	MIN. ORD.	A C
400129094		CONNECTOR STRAND B	25M	CA07939		
N		EA	10	12	10	

CONTAINER

PRODUCT IDENTIFIER		DESCRIPTION				
ITEM NUMBER	ORD. MULT.	SELL UNIT	STD. PKG. STOCK AVAILABILITY / PA	LEAD TIME	MIN. ORD.	A C
260426002		CONTAINER TARPULIN				
N		EA	1	6	1	

CORD

PRODUCT IDENTIFIER		DESCRIPTION				
ITEM NUMBER	ORD. MULT.	SELL UNIT	STD. PKG. STOCK AVAILABILITY / PA	LEAD TIME	MIN. ORD.	A C
260438692		CORD POWER CK	20842L	79		
N		EA	1	4	1	

CORD RUBBER

PRODUCT IDENTIFIER		DESCRIPTION				
ITEM NUMBER	ORD. MULT.	SELL UNIT	STD. PKG. STOCK AVAILABILITY / PA	LEAD TIME	MIN. ORD.	A C
400132080		CORD RUBBER	1/8IN X 50FT			
1146167	1	CL				

Used with CR tape in cable splicing operations, BSP 633-040-201.

CORD SEALING

PRODUCT IDENTIFIER		DESCRIPTION				
ITEM NUMBER	ORD. MULT.	SELL UNIT	STD. PKG. STOCK AVAILABILITY / PA	LEAD TIME	MIN. ORD.	A C
401799366		CORD SEALING B	72IN LONG			
2825828	1	RO				

BSP 633-460-012, BSP 633-460-011.

PRODUCT IDENTIFIER		DESCRIPTION				
ITEM NUMBER	ORD. MULT.	SELL UNIT	STD. PKG. STOCK AVAILABILITY / PA	LEAD TIME	MIN. ORD.	A C
401799580		CORD SEALING B	108IN LONG			
2826263	1	RO	IL IN MI OH WI 08 08 08 08 08			

PRODUCT IDENTIFIER		DESCRIPTION				
ITEM NUMBER	ORD. MULT.	SELL UNIT	STD. PKG. STOCK AVAILABILITY / PA	LEAD TIME	MIN. ORD.	A C
280043548		CORD SEALING RC45	REENTER			
N		RL	1	4	96	

NOW AVAILABLE THROUGH TOUCH-TONE ORDER ENTRY.

PRODUCT IDENTIFIER		DESCRIPTION				
ITEM NUMBER	ORD. MULT.	SELL UNIT	STD. PKG. STOCK AVAILABILITY / PA	LEAD TIME	MIN. ORD.	A C
300074291		CORD SEALING RC62	9/32IN X 62IN			
5121525	1	RO	IL IN MI OH WI 08 08 08 08 08			

PRODUCT IDENTIFIER		DESCRIPTION				
ITEM NUMBER	ORD. MULT.	SELL UNIT	STD. PKG. STOCK AVAILABILITY / PA	LEAD TIME	MIN. ORD.	A C
300074259		CORD SEALING RC96	9/32IN X 96IN			
1226514	1	RO	IL IN MI OH WI 08 08 08 08 08			

Used to close splice closures. Round .305in diameter X 96in oil resistant sealing cord.

CORD SHIELDED

PRODUCT IDENTIFIER		DESCRIPTION				
ITEM NUMBER	ORD. MULT.	SELL UNIT	STD. PKG. STOCK AVAILABILITY / PA	LEAD TIME	MIN. ORD.	A C
260323803		CORD SHIELDED	8 PIN 10FT			
1944249	1	EA				

SPI-000136.

COUPLER

PRODUCT IDENTIFIER		DESCRIPTION				
ITEM NUMBER	ORD. MULT.	SELL UNIT	STD. PKG. STOCK AVAILABILITY / PA	LEAD TIME	MIN. ORD.	A C
104298484		COUPLER	1001D			
N		EA	1	2	1	

Panel mounted connector for use with multimode fiber SLC Carrier System circuit packs.

PRODUCT IDENTIFIER		DESCRIPTION				
ITEM NUMBER	ORD. MULT.	SELL UNIT	STD. PKG. STOCK AVAILABILITY / PA	LEAD TIME	MIN. ORD.	A C
104298476		COUPLER	1011D			
N		EA	1	2	1	

PRODUCT IDENTIFIER		DESCRIPTION				
ITEM NUMBER	ORD. MULT.	SELL UNIT	STD. PKG. STOCK AVAILABILITY / PA	LEAD TIME	MIN. ORD.	A C
300085230		COUPLER CABLE	9011 12FT			
N		EA	1	6	1	

PRODUCT IDENTIFIER		DESCRIPTION				
ITEM NUMBER	ORD. MULT.	SELL UNIT	STD. PKG. STOCK AVAILABILITY / PA	LEAD TIME	MIN. ORD.	A C
260406467		COUPLER ST C-3000A-2				
1970004		EA	IL IN MI OH WI 21 21 21 21			

CC105271142.

COUPLING

PRODUCT IDENTIFIER		DESCRIPTION				
ITEM NUMBER	ORD. MULT.	SELL UNIT	STD. PKG. STOCK AVAILABILITY / PA	LEAD TIME	MIN. ORD.	A C
280001843		COUPLING	3 1/2IN X 3 1/2IN			
N		EA	1	2	1	

Joining.

PRODUCT IDENTIFIER		DESCRIPTION				
ITEM NUMBER	ORD. MULT.	SELL UNIT	STD. PKG. STOCK AVAILABILITY / PA	LEAD TIME	MIN. ORD.	A C
280001850		COUPLING	4IN X 4IN INTRNAL J			
N		EA	1	2	1	

PRODUCT IDENTIFIER		DESCRIPTION				
ITEM NUMBER	ORD. MULT.	SELL UNIT	STD. PKG. STOCK AVAILABILITY / PA	LEAD TIME	MIN. ORD.	A C
280023698		COUPLING BELLED	3 1/2IN X 3 1/2IN			
N		EA	1	1	1	

With stop.

PRODUCT IDENTIFIER		DESCRIPTION				
ITEM NUMBER	ORD. MULT.	SELL UNIT	STD. PKG. STOCK AVAILABILITY / PA	LEAD TIME	MIN. ORD.	A C
280001827		COUPLING BELLED	3 1/2IN X 3 1/2IN			
N		EA	1	2	1	

With stop.

DISTRIBUTION SERVICES

NETWORK SERVICES

TOOLS

BUILDING JANITORIAL

AUTOMOTIVE

FORMS/OFFICE SUPPLIES

GENERAL

DATA VOICE

PRODUCT IDENTIFIER		DESCRIPTION				
ITEM NUMBER	ORD. MULT.	SELL UNIT	STD. PKG. STOCK AVAILABILITY / PA	LEAD TIME	MIN. ORD.	A C

280001835 COUPLING BELLED 4IN X 4IN W/STOP
 N EA 1 2 1

900220716 COUPLING BRONZE 5/8IN THREADED

1146688 1 EA IL IN MI OH WI
 14 14 14 14 14
 REPLACED BY 360395207.

260395207 COUPLING BRONZE 5/8IN UNTHREADED

1970947 1 EA IL IN MI OH WI
 14 14 14 14 14
 For use with ground rod 5/8IN X 5FT unthreaded (PID 260395199, item 1970954).



1970947

280001934 COUPLING G DOG LEG 4IN
 N EA 1 2 1

300044104 COUPLING INTERNAL JOIN 3.5IN
 N EA 1 1

002010759 COUPLING LB ACS FITTING PVC
 1160473 1 EA IL IN MI OH WI
 18 18
 Plastic connector used to effect a 90 degree turn of PVC 1/2in conduit. Fitting has a removable plate that is used to access the wires at the point of the turn.

002048379 COUPLING LOCKNUT 1/2IN
 1144816 1 EA IL IN MI OH WI
 18 18
 Plastic connector used to connect one section of PVC 1/2in conduit to an outlet box or wire terminal by means of a provided metal locknut.

001033034 COUPLING PLASTIC B/C4
 7305763 1 EA IL IN MI OH WI
 35
 With center stop.

002010726 COUPLING PVC 1/2IN
 1180562 1 EA IL IN MI OH WI
 18 18 18
 Plastic connector used to connect one section of PVC 1/2in conduit to another to effect an extension of the conduit in a straight line.

PRODUCT IDENTIFIER		DESCRIPTION				
ITEM NUMBER	ORD. MULT.	SELL UNIT	STD. PKG. STOCK AVAILABILITY / PA	LEAD TIME	MIN. ORD.	A C

002011146 COUPLING PVC OFFSET

1128850 1 EA IL IN MI OH WI
 18 18 18
 A 28 inch section of plastic 1/2 inch conduit pre-bent with two opposing 45 degree angles used to extend PVC conduit over or around obstacles.

260338207 COUPLING ROD EXTENDER 1IN

1948125 1 EA IL IN MI OH WI
 14 14

280008012 COUPLING SLEEVE 3/8IN

N EA 1 6 1

300049434 COUPLING SLEEVE EXTERNAL 3.5IN

N EA 1 1
 Sleeve-type couplings for joining male ends of duct 6IN.

280001819 COUPLING SLEEVE EXTERNAL 4IN X 4IN

N EA 1 2 1

260439211 COUPLING SMOOTH CORE 4IN

N

300044096 COUPLING SPLIT INTERNAL JOIN 3.5IN

N EA 1 1

280014572 COUPLING WYE BRANCH 4IN

N EA 1 2 1

COUPLING ENLARGING

280001868 COUPLING ENLARGING 3 IPS X 4IN TE
 N EA 1 2 1
 TEL

280001876 COUPLING ENLARGING 3.5 IPS X 4IN TE
 N EA 1 2 1

280023672 COUPLING ENLARGING 3.5 TEL X 3.5 IP
 N EA 1 1 1

280001892 COUPLING ENLARGING 3.5 TEL X 3.5 TE
 N EA 1 2 1

280023680 COUPLING ENLARGING 3.5 TEL X 4IN IP
 N EA 1 1 1

280001884 COUPLING ENLARGING 3.5 TEL X 4IN TE
 N EA 1 2 1

280023664 COUPLING ENLARGING 4 TEL X 3.5IN
 N EA 1 1 1

280001900 COUPLING ENLARGING 4 TEL X 4IN IPS
 N EA 1 2 1

280001926 COUPLING ENLARGING 4 TEL X 5IN IPS
 N EA 1 2 1

DISTRIBUTION SERVICES

NETWORK SERVICES

TOOLS

BUILDING JANITORIAL

AUTOMOTIVE

FORMS/OFFICE SUPPLIES

GENERAL

DATA VOICE

DISTRIBUTION SERVICES

NETWORK SERVICES

TOOLS

BUILDING JANITORIAL

AUTOMOTIVE

FORMS/OFFICE SUPPLIES

GENERAL

DATA VOICE

COVER

PRODUCT IDENTIFIER		DESCRIPTION					
ITEM NUMBER	ORD. MULT.	SELL UNIT	STD. PKG. STOCK AVAILABILITY / PA	LEAD TIME	MIN. ORD.	A C	
COVER							
845129154 COVER							
N		EA	32	5	32		
300084431 COVER 2A2AA- 510							
5126144	1	EA	IL 08 IN 08 MI 08 OH 08 WI 08				
A cover to be used with 2A type closures.							
300084423 COVER 2A2A- 510							
5126136	1	EA	IL 08 IN 08 MI 08 OH 08 WI 08				
Each assembly includes tape, cord and bonding/grounding kit. This is a 5IN X 28IN cover to be used with 2 type cable closure.							
300068749 COVER 2A4AA- 510							
N		EA	1	4	1		
300068731 COVER 2A4A- 510							
1975193	1	EA	IL 08 IN 08 MI 08 OH 08 WI 08				
300084449 COVER 2B2A- 510							
5126151	1	EA	IL 08 IN 08 MI 08 OH 08 WI 08				
Kit containing a 7IN X 28IN cover to be used with the 2B type cable closure.							
300084456 COVER 2B2B- 510							
5126177	1	EA	IL 08 IN 08 MI 08 OH 08 WI 08				
Kit containing a 7IN X 36IN cover to be used with the 2 type cable closure. Polypropylene, black are non-fire retardant for outside use, Blue are fire retardant for inside use.							
300084464 COVER 2B2C- 510							
5126193	1	EA	IL 08 IN 08 MI 08 OH 08 WI 08				
Kit containing a 7IN X 44IN cover to be used with the 2 type cable closure.							
300084472 COVER 2C2A- 510							
5126292	1	EA	IL 08 IN 08 MI 08 OH 08 WI 08				
Kit containing an 8IN X 28IN cover to be used with the 2C type cable closure.							
300084480 COVER 2C2B- 510							
5126284	1	EA	IL 08 IN 08 MI 08 OH 08 WI 08				
Kit containing an 8IN X 36IN cover to be used with the 2C type cable closure.							
300084498 COVER 2C2C- 510							
5126278	1	EA	IL 08 IN 08 MI 08 OH 08 WI 08				
Kit containing an 8IN X 44IN cover to be used with the 2C type cable closure.							
300084506 COVER 2D2A- 510							
5126268	1	EA	IL 08 IN 08 MI 08 OH 08 WI 08				
Kit containing a 9IN X 28IN cover to be used with the 2D type cable closure.							

PRODUCT IDENTIFIER		DESCRIPTION					
ITEM NUMBER	ORD. MULT.	SELL UNIT	STD. PKG. STOCK AVAILABILITY / PA	LEAD TIME	MIN. ORD.	A C	
300084522 COVER 2D2B- 510							
5126250	1	EA	IL 08 IN 08 MI 08 OH 08 WI 08				
Kit containing a 9IN X 36IN cover to be used with the 2D type cable closure.							
300084514 COVER 2D2C- 510							
5126235	1	EA	IL 08 IN 08 MI 08 OH 08 WI 08				
Kit containing a 9IN X 44IN cover to be used with the 2D type cable closure.							
300068798 COVER 2D4C- 510							
N		EA	1	4	1		
300084530 COVER 2E2A-DD-510							
5126227	1	EA	IL 08 IN 08 MI 08 OH 08 WI 08				
Kit containing a 12IN X 28IN cover to be used with the 2 type cable closure.							
260320916 COVER 2E2A-DE-510							
1950709	1	EA	IL 08 IN 08 MI 08 OH 08 WI 08				
280093667 COVER 2E2A-EE-510							
1950717	1	EA	IL 08 IN 08 MI 08 OH 08 WI 08				
300084548 COVER 2E2B-DD-510							
5126219	1	EA	IL 08 IN 08 MI 08 OH 08 WI 08				
260320924 COVER 2E2B-DE-510							
1975219	1	EA	IL 08 IN 08 MI 08 OH 08 WI 08				
280093675 COVER 2E2B-EE-510							
1954917	1	EA	IL 08 IN 08 MI 08 OH 08 WI 08				
260404025 COVER 2E2C-DD-510							
1975235	1	EA	IL 08 IN 08 MI 08 OH 08 WI 08				
260404008 COVER 2E2C-DE-510							
N		EA	1	4	1		
260403993 COVER 2E2C-EE-510							
1975227	1	EA	IL 08 IN 08 MI 08 OH 08 WI 08				
260404017 COVER 2E2D-DD-510							
N		EA	1	4	1		
260322805 COVER 2X2AA- 510							
N		EA	1	4	1		
280041302 COVER 2Y2AA- 510							
N		EA	1	4	1		
280041252 COVER 2Z2AAA- 510							
N		EA	1	4	1		
280041260 COVER 2Z4AAA- 510							
N		EA	1	4	1		

PRODUCT IDENTIFIER		DESCRIPTION					
ITEM NUMBER	ORD. MULT.	SELL UNIT	STD. PKG. STOCK AVAILABILITY / PA	LEAD TIME	MIN. ORD.	A	C
260328208 COVER 49C2 TERMINAL CABLE							
N		KT	1	9	1		
Used to replace missing or damaged covers for 49C2 terminals. 5 covers per kit.							
260328216 COVER 49D2 TERMINAL CABLE							
N		KT	1	7	1		
Used to replace missing or damaged covers for 49D2 terminals, 5 covers per kit.							
280057308 COVER 54-0003 PLASTIC WARNING							
N		EA	100	4	800		
W/O Insert coding device.							
401281670 COVER 66B PROT TEL							
5245308	1	EA	IL 08	IN 08	MI 08	OH 08	WI 08
842138802 COVER 105 25 PAIR 842138802							
1921130	1	EA	IL 08	IN 08	MI 08	OH 08	WI 08
REPLACED BY 105389977							
102231974 COVER 149A1							
4201038	1	EA	IL 08	IN 08	MI 08	OH 08	WI 08
Cover for G type closure.							
101770808 COVER 150B							
2241042	1	EA	IL 18	IN 18	MI 18	OH 18	WI 18
A plastic cover for 111A protector. Replaces cover 150A, BSP 638-215-100.							
103067716 COVER 710B1							
1139998	1	EA	IL 08	IN 08	MI 08	OH 08	WI 08
Cover used to protect the conductor ends on a 710 half-tap module after the pairs are trimmed out.							
001168327 COVER 4019 PROTECTOR MODULE							
1219451	1	EA	IL 08	IN 08	MI 08	OH 08	WI 08
Used to protect module from dust and moisture.							
300049095 COVER 4078C HALF-TAP BG 12							
1332825	1	EA	IL 08	IN 08	MI 08	OH 08	WI 08
300073772 COVER 4246 CHAMBER SPLICE							
5121814	1	EA	IL 18	IN 18	MI 18	OH 18	WI 18
Used to cover unused frame positions in F & G cabinets.							
845129154 COVER 845129154							
N		EA	32	5	32		
400134938 COVER CK19316 L 5							
N		EA	50	5	100		
A weatherproof cover used where box for jack has been installed at outdoor location. BSP 461-630-102.							

PRODUCT IDENTIFIER		DESCRIPTION					
ITEM NUMBER	ORD. MULT.	SELL UNIT	STD. PKG. STOCK AVAILABILITY / PA	LEAD TIME	MIN. ORD.	A	C
400461265 COVER CK20458 L 2							
1162164	1	EA	IL 18	IN 18	MI 18	OH 18	WI 18
Three connector cover for multi contact connectors, equipped with CK20458 L11 magnet assembly, associated with call directors and consoles. BSP 461-200-103.							
400461273 COVER CK20458 L 3							
1311597	1	EA	IL 18	IN 18	MI 18	OH 18	WI 18
To house and support 2 or 3 multi-contact connectors, equipped with adhesive brackets, per FPQ 84-760. Associated with call directors & console. BSP 461-200-103.							
400461299 COVER CK20458 L 7							
N		EA	1	3	50		
Cover to house and support four or five multi contact connectors, using CK20458 L1 magnet assembly. Associated with call directors and consoles. Magnetic assemblies per FPQ 84-760. BSP 461-200-103.							
400604641 COVER CK20458 L 12 WITH BRACKET							
2398008	1	EA	IL 18	IN 18	MI 18	OH 18	WI 18
Cover only for housing single mated CK type plug connector e/w bracket for mounting on a non-magnetic surface or outlet box. BSP 461-200-103.							
400604658 COVER CK20458 L 13							
2398024	1	EA	IL 18	IN 18	MI 18	OH 18	WI 18
Cover for housing single mated CK type plug connector e/w magnets and splash guard for mounting on steel walls or desk. BSP 461-200-103.							
400604633 COVER CK20458 L 14							
2398040	1	EA	IL 18	IN 18	MI 18	OH 18	WI 18
Same as Cover CK20458 L2 except e/w adhesive back on mounting bracket. BSP 461-200-103.							
401818323 COVER CK21776 L101 03 BLACK							
N		EA	1	8	240		
Used with Key CK21776 L1 and L5.							
401818331 COVER CK21776 L101 50 IVORY							
N		EA	1	8	220		
401818349 COVER CK21776 L101 51 GREEN							
1178293	1	EA	IL 18	IN 18	MI 18	OH 18	WI 18
DISCONTINUE UPON STOCK DEPLETION							
401818356 COVER CK21776 L101 53 RED							
N		EA	1	8	220		
401818364 COVER CK21776 L101 56 YELLOW							
N		EA	1	8	220		
401818380 COVER CK21776 L101 60 BEIGE							
1169573	1	EA	IL 18	IN 18	MI 18	OH 18	WI 18
DISCONTINUE UPON STOCK DEPLETION							

DISTRIBUTION SERVICES

NETWORK SERVICES

TOOLS

BUILDING JANITORIAL

AUTOMOTIVE

FORMS/OFFICE SUPPLIES

GENERAL

DATA VOICE

DISTRIBUTION SERVICES

NETWORK SERVICES

TOOLS

BUILDING JANITORIAL

AUTOMOTIVE

FORMS/OFFICE SUPPLIES

GENERAL

DATA VOICE

COVER

PRODUCT IDENTIFIER		DESCRIPTION				
ITEM NUMBER	ORD. MULT.	SELL UNIT	STD. PKG. STOCK AVAILABILITY / PA	LEAD TIME	MIN. ORD.	A C
401818398		COVER CK21776 L101 61 GRAY				
N		EA	1	8	220	
401843875		COVER CK21876 L 2 DESIGNATION				
N		PC	1	2	1	
105219372		COVER DUST 13A				
N		EA	1	4	1	
260405964		COVER DUST FOR HOMACO RELAY RACK DC-23				
N		EA	1	4	1	
401524970		COVER FLOOD B 8 1/2				
N		EA	1	7	1	
401524988		COVER FLOOD B 16 CA8761				
N		EA	1	5	1	
260322235		COVER FLOOD FC 4				
N		EA	1	6	5	
260322243		COVER FLOOD FC 6				
N		EA	1	6	5	
260322250		COVER FLOOD FC 8				
N		EA	1	6	5	
NOW AVAILABLE THROUGH TOUCH-TONE ORDER ENTRY.						
260322268		COVER FLOOD FC12				
N		EA	1	6	5	

842931271 COVER MALE CONTACT 842931271

ITEM NUMBER	ORD.	SELL UNIT	STD. PKG.	LEAD TIME	MIN. ORD.	A C
4205062	1	PC	IL IN MI OH WI			
			08			

Cover used on 710 bridge modules to protect the contacts. DISCONTINUE, ORDER NON STOCK UPON STOCK DEPLETION.

300055431 COVER MICROPHONE PACKAGE OF 10

N		PK	1	2	1	
---	--	----	---	---	---	--

280009796 COVER POLE C406-0030 12IN X 4IN

N		EA	1	6	1	
---	--	----	---	---	---	--

A protective cover for use where poles are to be raised or lowered thru 20 KVA overhead distribution. NOW AVAILABLE THROUGH TOUCH-TONE ORDER ENTRY.

PRODUCT IDENTIFIER		DESCRIPTION				
ITEM NUMBER	ORD. MULT.	SELL UNIT	STD. PKG. STOCK AVAILABILITY / PA	LEAD TIME	MIN. ORD.	A C

300069010 COVER S66MC4LH HINGED GRAY

5120717	1	EA	IL IN MI OH WI			
			18 18 18 18 18			

A gray plastic cover designed for use on 66 type blocks.

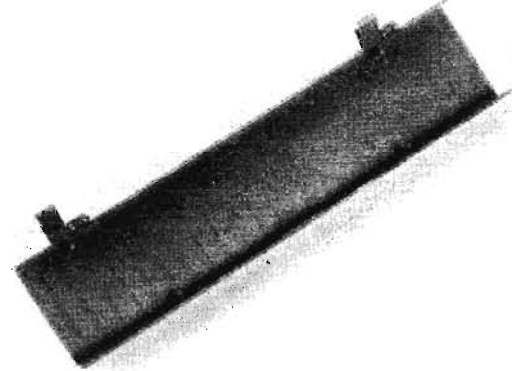

5120717

300069028 COVER S66MC4LH HINGED ORANGE

5120725	1	EA	IL IN MI OH WI			
			18 18 18 18 18			

An orange plastic cover designed for use on 66 type blocks.

002076545 COVER SE100C

1182972	1	EA	IL IN MI OH WI			
			18 18			

400134946 COVER SPLICE B 20IN X 24IN

1194886	1	PK	IL IN MI OH WI			
			08 08 08 08 08			

BSP 632-020-100.

401917406 COVER SPLICE B 48IN X 100FT ROLL

2694125	1	RO	IL IN MI OH WI			
			08 08 08 08 08			

For use as a temporary covering on open splices in aerial and block cables.

845583780 COVER SPLICE W/SCREWS

N		EA	1	14	1	
---	--	----	---	----	---	--

Package of 12.

COVER FIRE RETARDANT

260320833 COVER 2B4AA- 510 FIRE RETARDANT

N		EA	1	4	1	
---	--	----	---	---	---	--

300068756 COVER 2B4A- 510 FIRE RETARDANT

1943506	1	EA	IL IN MI OH WI			
			08 08 08 08 08			

280080813 COVER 2B4B- 510 FIRE RETARDANT

N		EA	1	4	1	
---	--	----	---	---	---	--

280080821 COVER 2B4C- 510 FIRE RETARDANT

N		EA	1	4	1	
---	--	----	---	---	---	--

PRODUCT IDENTIFIER		DESCRIPTION					
ITEM NUMBER	ORD. MULT.	SELL UNIT	STD. PKG. STOCK AVAILABILITY / PA	LEAD TIME	MIN. ORD.	A C	
300068764 COVER 2C4A- 510 FIRE RETARDANT							
1943514	1	EA	IL 08 IN 08 MI 08 OH 08 WI 08				
Kit containing an 8in by 28in cover to be used with the 2 type cable closure.							
280080839 COVER 2C4B- 510 FIRE RETARDANT							
N		EA	1	4	1		
NOW AVAILABLE THROUGH TOUCH-TONE ORDER ENTRY.							
280080847 COVER 2C4C- 510 FIRE RETARDANT							
N		EA	1	4	1		
300068772 COVER 2D4A- 510 FIRE RETARDANT							
1943530	1	EA	IL 08 IN 08 MI 08 OH 08 WI 08				
300068780 COVER 2D4B- 510 FIRE RETARDANT							
1943522	1	EA	IL 08 IN 08 MI 08 OH 08 WI 08				
260320841 COVER 2E4A-DD-510 FIRE RETARDANT							
1975185	1	EA	IL 08 IN 08 MI 08 OH 08 WI 08				
260320858 COVER 2E4A-DE-510 FIRE RETARDANT							
N		EA	1	4	1		
NOW AVAILABLE THROUGH TOUCH-TONE ORDER ENTRY.							
260320866 COVER 2E4A-EE-510 FIRE RETARDANT							
N		EA	1	4	1		
260320874 COVER 2E4B-DD-510 FIRE RETARDANT							
N		EA	1	4	1		
NOW AVAILABLE THROUGH TOUCH-TONE ORDER ENTRY.							
260320882 COVER 2E4B-DE-510 FIRE RETARDANT							
N		EA	1	4	1		
NOW AVAILABLE THROUGH TOUCH-TONE ORDER ENTRY.							
260320890 COVER 2E4B-EE-510 FIRE RETARDANT							
N		EA	1	4	1		
260320825 COVER 2X4AA- 510 FIRE RETARDANT							
N		EA	1	4	1		
260320817 COVER 2Y4AA- 510 FIRE RETARDANT							
N		EA	1	4	1		
CROSSARM							
400135083 CROSSARM 6A WOOD CA07298							
N		EA	25	5	25		
For supporting open line wires, BSP 621-300-103.							
400135166 CROSSARM 10A WOOD CA07298							
N		EA	25	5	25		

PRODUCT IDENTIFIER		DESCRIPTION					
ITEM NUMBER	ORD. MULT.	SELL UNIT	STD. PKG. STOCK AVAILABILITY / PA	LEAD TIME	MIN. ORD.	A C	
400135208 CROSSARM 10B WOOD CA07298							
5192047	1	EA	IL 14 IN 14 MI 14 OH 14 WI 14				
401594734 CROSSARM C METAL CA08783							
N		EA	1	7	1		
400135604 CROSSARM DE WOOD CA07298							
N		EA	25	5	25		
DAMPER CABLE							
400136032 DAMPER CABLE B CA07385							
N		EA	1	4	1		
DEADEND							
400136057 DEADEND FALSE B 6 M							
1148007	1	EA					
Used for making false dead ends on 6 M strand, BSP 627-240-213.							
400726261 DEADEND FALSE B 6.6M							
1148049	1	EA	IL 08 IN 08 MI 08 OH 08 WI 08				
400136073 DEADEND FALSE B 10 M							
1148023	1	EA	IL 08 IN 08 MI 08 OH 08 WI 08				
400136081 DEADEND FALSE B 16 M CA07940							
N		EA	25	12	25		
400136099 DEADEND FALSE B 25 M CA07940							
N		EA	10	14	10		
NOW AVAILABLE THROUGH TOUCH-TONE ORDER ENTRY.							
400464335 DEADEND SERVICE MESSAGE DE2506							
3324723	1	EA	IL 08 IN 08 MI 08 OH 08 WI 08				
DECAL							
280038829 DECAL FIBER-OPTIC CARSONITE							
1923912	1	EA					
To be placed over the existing decal on the 72in fiberglass post WB 567.							
260321872 DECAL ILLINOIS CLOSURE AM							
N		PK	1	6	4		
For CAD closures. Package of 25.							
260321880 DECAL INDIANA CLOSURE AM							
N		PK	1	6	4		
For CAD closures. Decal for use on buried cable term to indicate existence of buried cable & the # to call before digging. Black lettering on orange. Package of 25.							

DISTRIBUTION SERVICES

NETWORK SERVICES

TOOLS

BUILDING JANITORIAL

AUTOMOTIVE

FORMS/OFFICE SUPPLIES

GENERAL

DATA VOICE

DISTRIBUTION SERVICES
 NETWORK SERVICES
 TOOLS
 BUILDING JANITORIAL
 AUTOMOTIVE
 FORMS/OFFICE SUPPLIES
 GENERAL
 DATA VOICE

DECAL

PRODUCT IDENTIFIER		DESCRIPTION						
ITEM NUMBER	ORD. MULT.	SELL UNIT	STD. PKG. STOCK AVAILABILITY / PA	LEAD TIME	MIN. ORD.	A	C	
260321898		DECAL MICHIGAN CLOSURE AM						
1942912	1	PK	IL IN MI OH WI	08				
For CAD closures. Package of 25.								



1942912

260321906		DECAL OHIO CLOSURE AM					
1942920	1	PK	IL IN MI OH WI	08			
For CAD closures. Package of 25.							

002076362		DECAL WARNING B 3 1/2IN X 4 1/2IN					
1226613	1	EA	IL IN MI OH WI	08			
Decal for use on buried cable terminals to indicate the existence of buried cable, and the number to call before digging. White lettering on dark green background.							

002076420		DECAL WARNING C 3 1/2IN X 4 1/2IN					
1218297	1	EA	IL IN MI OH WI	08			
Decal for use on buried cable terminals to indicate the existence of buried cable, and the number to call before digging. Black lettering on yellow background.							

400589976		DECAL WARNING F CA08352 L56					
1161216	1	PK	IL IN MI OH WI	08			
Package of 100.							

260321914		DECAL WISCONSIN CLOSURE AM					
N		PK	1	6	4		
For CAD closures. Package of 25.							

401325592		DECAL-'PLEASE DO NOT OBSTRUCT'					
1229757	1	EA	IL IN MI OH WI	08			

DECAL 5005 REFLECTIVE

COLOR: BLACK LETTERS, NUMBERS & SYMBOLS ON ORANGE BACKGROUND. PACKAGE OF 100.

260395157		DECAL 5005 ARROW SYMBOL					
1972430	1	EA					
A decal used to indicate rural lead directions.							

PRODUCT IDENTIFIER		DESCRIPTION						
ITEM NUMBER	ORD. MULT.	SELL UNIT	STD. PKG. STOCK AVAILABILITY / PA	LEAD TIME	MIN. ORD.	A	C	
260395173		DECAL 5005 BLANK SYMBOL						
1972455	1	EA	IL IN MI OH WI	08				
A decal to insert spaces between numbers or letters on OSP products.								

260421110		DECAL 5005 CLOSURE INBT					
1972414	100	EA	IL IN MI OH WI	08			
IN - (Warning Label for Buried Cable) Decal for use on buried cable terminals to indicate the existence of buried cable, and the # to call before digging. Black lettering on orange background.							

260395165		DECAL 5005 DASH SYMBOL					
1972448	1	EA	IL IN MI OH WI	08			
A decal used to indicate a dash lead on OSP products.							

300041324		DECAL 5005 LETTER A					
1153379	1	EA	IL IN MI OH WI	08 08 08 08			

300041332		DECAL 5005 LETTER B					
1179549	1	EA	IL IN MI OH WI	08 08 08 08			

300041340		DECAL 5005 LETTER C					
1138321	1	EA	IL IN MI OH WI	08 08 08 08			

300041357		DECAL 5005 LETTER D					
1123711	1	EA	IL IN MI OH WI	08 08 08 08			

300041407		DECAL 5005 LETTER E					
1229732	1	EA	IL IN MI OH WI	08 08 08 08			

300041365		DECAL 5005 LETTER F					
1104976	1	EA	IL IN MI OH WI	08 08 08 08			

300041373		DECAL 5005 LETTER G					
1146712	1	EA	IL IN MI OH WI	08 08 08 08			

300041381		DECAL 5005 LETTER H					
1216515	1	EA	IL IN MI OH WI	08 08 08 08			

300041399		DECAL 5005 LETTER I					
1167155	1	EA	IL IN MI OH WI	08 08 08 08			

300041415		DECAL 5005 LETTER J					
1229120	1	EA	IL IN MI OH WI	08 08 08 08			

300041423		DECAL 5005 LETTER K					
1155432	1	EA	IL IN MI OH WI	08 08 08 08			

300041431		DECAL 5005 LETTER L					
1112318	1	EA	IL IN MI OH WI	08 08 08 08			

PRODUCT IDENTIFIER		DESCRIPTION					
ITEM NUMBER	ORD. MULT.	SELL UNIT	STD. PKG. STOCK AVAILABILITY / PA	LEAD TIME	MIN. ORD.	A C	
300041449 DECAL 5005 LETTER M							
1202291	1	EA	IL IN MI OH WI 08 08 08 08 08				
300041456 DECAL 5005 LETTER N							
1227397	1	EA	IL IN MI OH WI 08 08 08 08 08				
300041464 DECAL 5005 LETTER P							
1150565	1	EA	IL IN MI OH WI 08 08 08 08 08				
300041472 DECAL 5005 LETTER Q							
1229880	1	EA	IL IN MI OH WI 08 08 08 08 08				
300041480 DECAL 5005 LETTER R							
1107714	1	EA	IL IN MI OH WI 08 08 08 08 08				
300041498 DECAL 5005 LETTER S							
1143453	1	EA	IL IN MI OH WI 08 08 08 08 08				
300041506 DECAL 5005 LETTER T							
1106153	1	EA	IL IN MI OH WI 08 08 08 08 08				
300041514 DECAL 5005 LETTER U							
1163311	1	EA	IL IN MI OH WI 08 08 08 08 08				
300041522 DECAL 5005 LETTER V							
1144824	1	EA	IL IN MI OH WI 08 08 08 08 08				
300041530 DECAL 5005 LETTER W							
1150656	1	EA	IL IN MI OH WI 08 08 08 08 08				
300041548 DECAL 5005 LETTER X							
1191957	1	EA	IL IN MI OH WI 08 08 08 08 08				
300041555 DECAL 5005 LETTER Y							
1191247	1	EA	IL IN MI OH WI 08 08 08 08 08				
300041563 DECAL 5005 LETTER Z							
1167254	1	EA	IL IN MI OH WI 08 08 08 08 08				
300041571 DECAL 5005 NUMBER 0							
1179853	1	EA	IL IN MI OH WI 08 08 08 08 08				
300041589 DECAL 5005 NUMBER 1							
1216358	1	EA	IL IN MI OH WI 08 08 08 08 08				
300041597 DECAL 5005 NUMBER 2							
1190140	1	EA	IL IN MI OH WI 08 08 08 08 08				
300041605 DECAL 5005 NUMBER 3							
1221812	1	EA	IL IN MI OH WI 08 08 08 08 08				

PRODUCT IDENTIFIER		DESCRIPTION					
ITEM NUMBER	ORD. MULT.	SELL UNIT	STD. PKG. STOCK AVAILABILITY / PA	LEAD TIME	MIN. ORD.	A C	
300041613 DECAL 5005 NUMBER 4							
1196436	1	EA	IL IN MI OH WI 08 08 08 08 08				
300041621 DECAL 5005 NUMBER 5							
1226456	1	EA	IL IN MI OH WI 08 08 08 08 08				
300041639 DECAL 5005 NUMBER 6							
1157974	1	EA	IL IN MI OH WI 08 08 08 08 08				
300041647 DECAL 5005 NUMBER 7							
1148775	1	EA	IL IN MI OH WI 08 08 08 08 08				
300041654 DECAL 5005 NUMBER 8							
1150300	1	EA	IL IN MI OH WI 08 08 08 08 08				
300056041 DECAL 5005 NUMBER 9							
1221358	1	EA	IL IN MI OH WI 08 08 08 08 08				
300097151 HOLDER STRIP 5012							
1940247	1	BX	IL IN MI OH WI 14				
Holder for decal 5000 series.							
300041662 KIT DECAL 5005							
N		KT	1	5	50		
With letters and numbers.							
260395140 KIT DECAL 5005 W/ARROW							
1972422		KT	IL IN MI OH WI 08 08 08 08 08				
A plastic box containing reflective numbers, letters and symbols to address OSP products. 11N X 1 1/2IN.							

DECAL PEDESTAL						
002059020 DECAL PEDESTAL B-928- NUMBER 0						
1197293	1	CD				
Pressure sensitive, 7/8in x 2 1/4in, black on orange, used to mark buried cable closures, 10 per card.						
002059038 DECAL PEDESTAL B-928-1 CARD 10						
1181610	1	CD	IL IN MI OH WI 08			
002059046 DECAL PEDESTAL B-928-2 CARD 10						
8141606	1	CD	IL IN MI OH WI 08			
002059053 DECAL PEDESTAL B-928-3 CARD 10						
8141648	1	CD	IL IN MI OH WI 08			
002059061 DECAL PEDESTAL B-928-4 CARD 10						
1143461	1	CD	IL IN MI OH WI 08			

DISTRIBUTION SERVICES
 NETWORK SERVICES
 TOOLS
 BUILDING JANITORIAL
 AUTOMOTIVE
 FORMS/OFFICE SUPPLIES
 GENERAL
 DATA VOICE

DECAL PEDESTAL

PRODUCT IDENTIFIER DESCRIPTION

ITEM NUMBER	ORD. MULT.	SELL. UNIT	STD. PKG. STOCK AVAILABILITY / PA	LEAD TIME	MIN. ORD.	A C
-------------	------------	------------	-----------------------------------	-----------	-----------	-----

002059079 DECAL PEDESTAL B-928-5 CARD 10
 1227710 1 CD IL IN MI OH WI 08

002059095 DECAL PEDESTAL B-928-8 CARD 10
 8141804 1 CD IL IN MI OH WI 08

002059103 DECAL PEDESTAL B-928-9 CARD 10
 8141820 1 CD IL IN MI OH WI 08

002059111 DECAL PEDESTAL B-928-LETTER L
 1187575 1 CD IL IN MI OH WI 08
 Pressure sensitive, 7/8in x 2 1/4in, black on orange, used to mark buried cable closures, 10 per card.

DESICCANT

401470299 DESICCANT B 325 GRAM PINT
 2612242 1 CT
 A white granular material that may be used to dry the insulating materials in cables and splices, 12 pint pkgs/ct, CA7014 - BSP 632-050-205.

996487526 DESICCANT C 4OZ BAG 10 PER CAN
 2129825 1 CN IL IN MI OH WI 08 08 08 08 08
 Consists of a granular material packaged in cloth or paper bags for use in splicing. Ten bags per can, 4 ounces per bag, BSP 632-050-205.

DISTRIBUTING RING

SEE RING DISTRIBUTING.

DOCUMENT DOOR HANGER

See Interface Network Door Hanger Document.

DOOR

104436878 DOOR 11A
 N EA 1 6 1

PRODUCT IDENTIFIER DESCRIPTION

ITEM NUMBER	ORD. MULT.	SELL. UNIT	STD. PKG. STOCK AVAILABILITY / PA	LEAD TIME	MIN. ORD.	A C
-------------	------------	------------	-----------------------------------	-----------	-----------	-----

DOOR HANGER DOCUMENT

See Interface Network Document Door Hanger.

DRYER AIR

SEE PRESSURIZATION AIR DRYER

DRYER AIR PARTS

SEE PRESSURIZATION AIR DRYER PARTS

DUCT

002010742 DUCT COVER TYPE C

1169219 6 FT
 Plastic wiring duct cover used with duct type S .5in wide X 6ft long, light gray. Used to cover exposed 1W at coin stations.

401140769 DUCT FLEX 2 BLACK 5FT LONG

7371625 1 PK IL IN MI OH WI 18 18 18 18

401192471 DUCT FLEX C3 50FT CA08693

5325407 1 PK IL IN MI OH WI 18 18 18 18

DISCONTINUE, ORDER NON STOCK UPON STOCK DEPLETION

401192463 DUCT FLOOR C2 50FT CA08693

2296582 1 PK IL IN MI OH WI 18 18 18 18

A vinyl floor duct, accommodates one 25 pair cable, two 50ft rolls per package, BSP 461-350-100.

400463287 DUCT OVERFLOOR 1500 5ft

1152967 1 EA IL IN MI OH WI 18 18 18 18

Used as over floor duct across floors to hold 6 pair station wire or 4 triple station wire, BSP 461-350-100.

400463303 DUCT OVERFLOOR 2600 5ft

N FT 25 5 25

Used as over floor duct across floor to hold two 26 pair inside wiring cable, BSP 461-350-100.

260439203 DUCT SMOOTH CORE C 20FT W/COUPL & GASKET

N W/Cement.

002010809 DUCT TYPE S

N FT 120 4 120

Plastic wiring .5in wide X .5in high X 6ft long, light gray, provides channel for exposed 1W at coin station.

DISTRIBUTION SERVICES

NETWORK SERVICES

TOOLS

BUILDING JANITORIAL

AUTOMOTIVE

FORMS/OFFICE SUPPLIES

GENERAL

DATA VOICE

DISTRIBUTION SERVICES

NETWORK SERVICES

TOOLS

BUILDING JANITORIAL

AUTOMOTIVE

FORMS/OFFICE SUPPLIES

GENERAL

DATA VOICE

PRODUCT IDENTIFIER		DESCRIPTION				
ITEM NUMBER	ORD. MULT.	SELL UNIT	STD. PKG. STOCK AVAILABILITY / PA	LEAD TIME	MIN. ORD.	A C

DUCT CABLE

401363023		DUCT CABLE ADHESIVE 805 4FT GRAY				
8299842	1	EA				
An adhesive backed vinyl duct used to protect 3/8in (outside diameter) cables on wall. BSP 461-350-100. Box of 10.						
401363031		DUCT CABLE ADHESIVE 806 4FT GRAY				
8299867	1	EA	IL IN MI OH WI 18 18			
An adhesive backed vinyl duct used to protect 1in (outside diameter) cables on wall. BSP 461-350-100. Box of 10.						
300000692		DUCT CABLE ADHESIVE 807 4FT GRAY				
8400218	1	EA	IL IN MI OH WI 18 18			
An adhesive backed vinyl duct used to protect cables on wall. BSP 461-350-100. Box of 10.						
280039207		DUCT CABLE BROWN 3/8IN				
N		EA	10	2		10
260328059		DUCT CABLE BROWN 1IN				
N		EA	10	2		10
300055977		DUCT CABLE IVORY 1-1/4IN 806I				
N		EA	1			1

DUCTLINER - SEE INNERDUCT

ED-NUMBERED PARTS

260322821		ED7C621-30 G110 368338				
1943001	1	EA				
1EA G34, 1EA G38, 1EA G143, 1EA F900H0067						
260322839		ED7C621-30 G122 368338				
1943050	1	EA	IL IN MI OH WI 18			
1EA G34, 1EA G38, 1EA G143, 1EA F900H0067						
601019474		ED8C501-50 FRAME BAY EQUIPMENT				
N		EA	1	6		1

ENCAPSULANT

845826171		ENCAPSULANT E-Z ENTRY 500 GRAM				
N		EA	25	1		25
845826197		ENCAPSULANT E-Z ENTRY 1500 GRAM				
N		EA	6	1		6
280055633		ENCAPSULANT E-Z ENTRY 1900 GRAM				
1930156	1	EA	IL IN MI OH WI 08 08 08 08			
845826213		ENCAPSULANT E-Z ENTRY 3000 GRAM				
N		EA	6	1		6

PRODUCT IDENTIFIER		DESCRIPTION				
ITEM NUMBER	ORD. MULT.	SELL UNIT	STD. PKG. STOCK AVAILABILITY / PA	LEAD TIME	MIN. ORD.	A C

845826221		ENCAPSULANT E-Z ENTRY 5000 GRAM				
1939330	1	EA	IL IN MI OH WI 08 08 08			
280055625		ENCAPSULANT E-Z ENTRY 8000 GRAM				
1930164	1	EA	IL IN MI OH WI 08 08 08			
280093303		ENCAPSULANT RE-ENTERABLE 750 GRAM				
1937276	1	EA	IL IN MI OH WI 08 08			
4442.						
280055617		ENCAPSULANT RE-ENTERABLE 750 GRAM				
1930172	1	EA	IL IN MI OH WI 08 08 08 08			
An E-Z entry encapsulating compound used in buried and underground splices to protect against water penetration. Consists of: 1 - can encap., 1-plastic bag encap., stirrer, & pail.						



1930172

280093295		ENCAPSULANT RE-ENTERABLE 1500 GRAM				
1937268	1	EA	IL IN MI OH WI 08 08			
4442.						
280093287		ENCAPSULANT RE-ENTERABLE 3000 GRAM				
1937250	1	EA	IL IN MI OH WI 08 08			
4442.						
260317110		ENCAPSULANT RE-ENTERABLE 6000 GRAM				
1941021	1	EA	IL IN MI OH WI 08 08			
4442.						

ENCLOSURE

260382387		ENCLOSURE CONTROL MODULE				
1961524	1	EA				
384-154-00.						
260382379		ENCLOSURE SERIES LINE MODULE				
1961516	1	EA	IL IN MI OH WI 08 08 08 08			
384-144-01.						
260417084		ENCLOSURE SPLICE PAIR GAINS				
1978916	1	EA	IL IN MI OH WI 09 09 09 09 09			

DISTRIBUTION SERVICES	END							PRODUCT IDENTIFIER DESCRIPTION								
	ITEM	ORD.	SELL	STD. PKG.	LEAD TIME	MIN.	A	ITEM	ORD.	SELL	STD. PKG.	LEAD TIME	MIN.	A		
	NUMBER	MULT.	UNIT	STOCK AVAILABILITY / PA		ORD.	C	NUMBER	MULT.	UNIT	STOCK AVAILABILITY / PA		ORD.	C		
	END							002049831	EYE-PULLING 940-1006-5							
								1930040	1	EA	IL	IN	MI	OH	WI	
NETWORK SERVICES	280010893 END BELL 4IN ROUND							002049849	EYE-PULLING 940-1007-7							
	N		EA	1		2	1	1930065	1	EA	IL	IN	MI	OH	WI	
			BSP	622-400-100.												
	280014556 END BELL 4IN W/SPIGOT							002049856	EYE-PULLING 940-1008-9							
	N		EA	1		2	1	1929984	1	EA	IL	IN	MI	OH	WI	
	260439260 END BELL PVC (TO SCHED 40) SMOOTH CORE							002049864	EYE-PULLING 940-1009-1							
	N							1934075	1	EA	IL	IN	MI	OH	WI	
TOOLS	260439237 END SPIGOT (PVC TO C DUCT) SMOOTH CORE							402942429	EYE-PULLING 940-1630-2							
	N							6510016	1	EA	IL	IN	MI	OH	WI	
	260439252 END SPIGOT (PVC TO SCHED 40) SMOOTH CORE							402942437	EYE-PULLING 940-1631-4							
	N							6510073	1	EA	IL	IN	MI	OH	WI	
BUILDING JANITORIAL	END PLATE							002049914	EYE-PULLING 940-1632-6							
								1930057	1	EA	IL	IN	MI	OH	WI	
	EXTENSION							002049922	EYE-PULLING 940-1633-8							
	400875902 EXTENSION E SPLIT PLAS CA08618							1930073	1	EA	IL	IN	MI	OH	WI	
	N		EA	1		2	1						08	08		
AUTOMOTIVE	EYE-PULLING							260338769	EYE-PULLING 940-1634-0							
								1948612	1	EA	IL	IN	MI	OH	WI	
	FOR ADC USAGE ONLY.							260303177	EYE-PULLING 940-1635-2							
	260324637 EYE-PULLING 30115 SPECIAL							1940197	1	EA	IL	IN	MI	OH	WI	
	1944900	1	EA													
FORMS/OFFICE SUPPLIES	260324645 EYE-PULLING 36050 DOWEL							260323795	EYE-PULLING 940-1636-4							
	1944892	1	EA	IL	IN	MI	OH	WI	1944231	1	EA	IL	IN	MI	OH	WI
	402942296 EYE-PULLING 940-1000-3							280047812	EYE-PULLING 940-1669-7							
	6510115	1	EA	IL	IN	MI	OH	WI	1926717	1	EA	IL	IN	MI	OH	WI
	402942304 EYE-PULLING 940-1001-5							280047820	EYE-PULLING 940-1670-8							
	6510024	1	EA	IL	IN	MI	OH	WI	1926709	1	EA	IL	IN	MI	OH	WI
GENERAL	402942312 EYE-PULLING 940-1002-7							280055641	EYE-PULLING 940-1671-0							
	6510107	1	EA	IL	IN	MI	OH	WI	1930081	1	EA	IL	IN	MI	OH	WI
	402942320 EYE-PULLING 940-1003-9							002049955	EYE-PULLING 940-1878-8							
	6510032	1	EA	IL	IN	MI	OH	WI	1936484	1	EA	IL	IN	MI	OH	WI
DATA VOICE	402942338 EYE-PULLING 940-1004-1							FANOUT								
	6510099	1	EA	IL	IN	MI	OH	WI	104219753	FANOUT	3C					
									N	EA	1		2	1		
	402942346 EYE-PULLING 940-1005-3															
	6510081	1	EA	IL	IN	MI	OH	WI								

PRODUCT IDENTIFIER							DESCRIPTION						
ITEM NUMBER	ORD. MULT.	SELL UNIT	STD. PKG. STOCK AVAILABILITY / PA	LEAD TIME	MIN. ORD.	A C							
105468102		FANOUT	3C	ST									
N		EA	1	2	1								
104325071		FANOUT	10A 1	8/24 ST CONN									
N		EA	1	2	1								
104325089		FANOUT	10B 1	8/24 ST CONN									
N		EA	1	2	1								
105464721		FANOUT	10C 1	48/24									
N		EA	1	2	1								
105464713		FANOUT	10C 1	48/48									
N		EA	1	2	1								
104325097		FANOUT	11A 1	8/24 DATA LINK									
N		EA	1	2	1								
104325105		FANOUT	11B 1	8/24 DATALINK									
N		EA	1	2	1								
104325113		FANOUT	12A 1	8/24 BILONIC									
N		EA	1	2	1								
104325121		FANOUT	12B 1	8/24 BILONIC									
N		EA	1	2	1								
104325139		FANOUT	12C 1	8/24 BILONIC									
N		EA	1	2	1								
105155014		FANOUT	12C 1	8/48									
N		EA	1	4	1								
104325600		FANOUT	LIU 110A1	MINI ST									
N		EA	1	2	1		Lightguide 50 Microns.						
104325618		FANOUT	LIU 110B1	MINI ST									
N		EA	1	2	1		Lightguide 62.5 Microns.						
104325626		FANOUT	LIU 111A1	MINI 1005B									
N		EA	1	2	1		Lightguide 50 Microns.						
104325634		FANOUT	LIU 111B1	MINI 1005B									
N		EA	1	2	1		Lightguide 62.5 Microns.						
104325642		FANOUT	LIU 112A1	MINI BCN									
N		EA	1	2	1		Lightguide 50 Microns.						
104325659		FANOUT	LIU 112B1	MINI BCN									
N		EA	1	2	1		Lightguide 62.5 Microns.						
104325667		FANOUT	LIU 112C1	MINI BCN									
N		EA	1	2	1		Lightguide 8.3 Microns.						

PRODUCT IDENTIFIER							DESCRIPTION						
ITEM NUMBER	ORD. MULT.	SELL UNIT	STD. PKG. STOCK AVAILABILITY / PA	LEAD TIME	MIN. ORD.	A C							
							FAST WELD						
403138639		FAST WELD	C1212										
N		EA	24	4	24								
							FASTENER						
900210584		FASTENER	WELL NUT C632	W/SCREW									
N		EA	100	4	1500								
							FASTENER MASONRY B CA07887						
							Nail type fastener, used at permanent installations. BSP 080-720-110.						
400139895		FASTENER	MASONRY B 2										
2193003	1	PK					Package of 12. Shank 5/16in thread length 9/16in.						
400139903		FASTENER	MASONRY B 3										
2193045	1	PK	IL	IN	MI	OH	WI						
			18	18	18	18	18						
			Package of 12. Shank 3/4in thread length 13/16in.										
400139911		FASTENER	MASONRY B 4										
1155721	1	PK	IL	IN	MI	OH	WI						
			18	18	18	18	18						
			Package of 12. Shank 1in thread length 1 1/16in.										
400139929		FASTENER	MASONRY B 5										
1102491	1	PK	IL	IN	MI	OH	WI						
			18	18	18	18	18						
			Package of 12. Shank 1 1/4in thread length 1 5/16in.										
400139937		FASTENER	MASONRY B 6										
1155747	1	PK	IL	IN	MI	OH	WI						
			18	18	18	18	18						
			Package of 12. Shank 1 1/2in thread length 1 9/16in.										
400139945		FASTENER	MASONRY B 8										
1102517	1	PK	IL	IN	MI	OH	WI						
			18	18	18	18	18						
			Package of 12. Shank 2in thread length 2 1/16in.										
400139952		FASTENER	MASONRY B10										
1146134	1	PK	IL	IN	MI	OH	WI						
			18	18	18	18	18						
			Package of 12. Shank 2 1/16in thread length 2 1/2in.										
400139960		FASTENER	MASONRY B12										
1227132	1	PK	IL	IN	MI	OH	WI						
			18	18	18	18	18						
			Package of 12. Shank 3in thread length 3 1/16in.										

DISTRIBUTION SERVICES

NETWORK SERVICES

TOOLS

BUILDING JANITORIAL

AUTOMOTIVE

FORMS/OFFICE SUPPLIES

GENERAL

DATA VOICE

FASTENER MASONRY C CA07887

DISTRIBUTION SERVICES

PRODUCT IDENTIFIER		DESCRIPTION					
ITEM NUMBER	ORD. MULT.	SELL UNIT	STD. PKG. STOCK AVAILABILITY / PA	LEAD TIME	MIN. ORD.	A C	

FASTENER MASONRY C CA07887

Threaded type fastener, used at temporary installations or where equipment may later be removed. BSP 030-720-110.

400139978 FASTENER MASONRY C31

2193227 1 PK
Package of 12. Shank 3/4in thread length 1/4in.

400139986 FASTENER MASONRY C32

2194266 1 PK
IL IN MI OH WI
18 18 18 18 18
Package of 12. Shank 3/4in thread length 1/2in.

400139994 FASTENER MASONRY C35

N PK 50 2 50
Package of 50.

400140000 FASTENER MASONRY C41

N PK 50 2 50
Package of 50.

400140018 FASTENER MASONRY C42

1135970 1 PK
IL IN MI OH WI
18 18
Package of 12. Shank 1in thread length 1 1/2in.

400140026 FASTENER MASONRY C45

1133132 1 PK
IL IN MI OH WI
18
Package of 12. Shank 1in thread length 1 1/4in.

400140034 FASTENER MASONRY C51

N PK 50 2 50
Package of 50. NOW AVAILABLE THROUGH TOUCH-TONE ORDER ENTRY.

400140042 FASTENER MASONRY C52

1160978 1 PK
IL IN MI OH WI
18 18
Package of 12. Shank 1 1/4in length 1/2in.

400140059 FASTENER MASONRY C55

2194845 1 PK
IL IN MI OH WI
18 18 18 18 18
Package of 12. Shank 1 1/4in length 1 1/4in.

FIBER OPTIC COMPONENTS

260431143 ADAPTER FIBER IND SC/ST HYBRID

N EA 1 1 1
BULKHEAD.

260431135 ADAPTER FIBER INDIV SC IN-LINE BULKHEAD

N EA 1 4 1

260431408 ATTENUATOR 5DB SC MM

N EA 1 4 1

NETWORK SERVICES

TOOLS

BUILDING JANITORIAL

AUTOMOTIVE

FORMS/OFFICE SUPPLIES

GENERAL

DATA VOICE

PRODUCT IDENTIFIER		DESCRIPTION					
ITEM NUMBER	ORD. MULT.	SELL UNIT	STD. PKG. STOCK AVAILABILITY / PA	LEAD TIME	MIN. ORD.	A C	

260431374 ATTENUATOR 5DB SC SM

1980060 1 EA
IL IN MI OH WI
08 08 08 08 08
SC optical attenuators are placed in CO & remote terminal fiber distribution frame applications & are used to reduce optical signal strength when max receive power level of FO muxs are exceeded.

260431416 ATTENUATOR 10DB SC MM

N EA 1 4 1

260431382 ATTENUATOR 10DB SC SM

1980078 1 EA
IL IN MI OH WI
08 08 08 08 08
SC optical attenuators are placed in CO & remote terminal fiber distribution frame applications & are used to reduce optical signal strength when max receive power level of FO muxs are exceeded.

260431424 ATTENUATOR 15DB SC MM

N EA 1 4 1

260431390 ATTENUATOR 15DB SC SM

1980086 1 EA
IL IN MI OH WI
08 08 08 08 08
SC optical attenuators are placed in CO & remote terminal fiber distribution frame applications & are used to reduce optical signal strength when max receive power level of FO muxs are exceeded.

260436019 ATTENUATOR 20DB SC MM

N EA 1 4 1

260436001 ATTENUATOR 20DB SC SM

N EA 1 4 1

260433750 CLEANER FIBER OPTIC CONNECTOR

N EA 1 4 1

260433768 CLEANER SPLIT SLEEVE TIP

N PK 1 4 1

260434766 CONNECTOR SC FIELD MOUNTABLE 125M

N EA 1 1 1

260431093 CONNECTOR SC FIELD MOUNTABLE 126M

1980011 1 EA
IL IN MI OH WI
08 08 08 08 08
SC optical connectors are field-installed rather than factory-installed. the two applications are CO break-out cable terminations & periodic repair of break-out cable terms including other interconn

260443411 CORD 4 FIBER BREAKOUT

N

260431911 CORD FIBER 2M MM SC/BCN

N EA 1 4 1

260431648 CORD FIBER 2M MM SC/SC

N EA 1 4 1

260431630 CORD FIBER 2M MM SC/ST

N EA 1 4 1

PRODUCT IDENTIFIER							DESCRIPTION						
ITEM NUMBER	ORD. MULT.	SELL UNIT	STD. PKG. STOCK AVAILABILITY / PA	LEAD TIME	MIN. ORD.	A C							
260431622		CORD	FIBER 2M MM ST/BCN										
N		EA	1	4	1								
260446620		CORD	FIBER 2M SC/BCN SN DUPLEX										
N													
260446638		CORD	FIBER 2M SC/SC SM DUPLEX										
N													
260431903		CORD	FIBER 2M SM SC/BCN										
N		EA	1	4	1								
260432893		CORD	FIBER 2M SM SC/FC										
N		EA	1	4	1								
260431333		CORD	FIBER 2M SM SC/SC										
N		EA	1	4	12								
260431325		CORD	FIBER 2M SM SC/ST										
N		EA	1	4	1								
260431317		CORD	FIBER 2M SM ST/BCN										
N		EA	1	4	1								
260432885		CORD	FIBER 2M SM ST/FC										
N		EA	1	4	1								
260440474		CORD	FIBER 4M SC BC										
N		EA	1	3	1								
260431192		CORD	FIBER 5.2M SC/SC MM DUPLEX										
N		EA	1	1	1								
260431150		CORD	FIBER 5.2M SC/SC SM DUPLEX										
1980037	1	EA	IL IN MI OH WI 08 08 08										
260431275		CORD	FIBER 5.2M SC/ST MM DUPLEX										
N		EA	1	4	1								
260431234		CORD	FIBER 5.2M SC/ST SM DUPLEX										
N		EA	1	4	1								
260431200		CORD	FIBER 5.8M SC/SC MM DUPLEX										
N		EA	1	1	1								
260431168		CORD	FIBER 5.8M SC/SC SM DUPLEX										
1980045	1	EA	IL IN MI OH WI 08 08 08										
260431283		CORD	FIBER 5.8M SC/ST MM DUPLEX										
N		EA	1	4	1								
260431242		CORD	FIBER 5.8M SC/ST SM DUPLEX										
N		EA	1	4	1								
260431218		CORD	FIBER 6.55.8M SC/SC MM DUPLEX										
N		EA	1	1	1								
260431176		CORD	FIBER 6.5M SC/SC SM DUPLEX										
1980052	1	EA	IL IN MI OH WI 08 08 08										

PRODUCT IDENTIFIER							DESCRIPTION						
ITEM NUMBER	ORD. MULT.	SELL UNIT	STD. PKG. STOCK AVAILABILITY / PA	LEAD TIME	MIN. ORD.	A C							
260431291		CORD	FIBER 6.5M SC/ST MM DUPLEX										
N		EA	1	4	1								
260431259		CORD	FIBER 6.5M SC/ST SM DUPLEX										
N		EA	1	4	1								
260431226		CORD	FIBER 7.2M SC/SC MM DUPLEX										
N		EA	1	4	1								
260431184		CORD	FIBER 7.2M SC/SC SM DUPLEX										
1980094	1	EA	IL IN MI OH WI 21 21										
260431309		CORD	FIBER 7.2M SC/ST MM DUPLEX										
N		EA	1	4	1								
260431267		CORD	FIBER 7.2M SC/ST SM DUPLEX										
N		EA	1	4	1								
260431366		CORD	TEST FIBER 2M MM BCN/SC										
N		EA	1	2	1								
260431341		CORD	TEST FIBER 2M MM SC/SC										
N		EA	1	2	1								
260431358		CORD	TEST FIBER 2M MM ST/SC										
N		EA	1	2	1								
260434782		CORD	TEST FIBER MM 2M ST/BCN										
N		EA	1	2	1								
260430731		CORD	TEST FIBER SM 2M BCN/SC										
N		EA	1	2	1								
260430756		CORD	TEST FIBER SM 2M SC/SC										
N		EA	1	2	1								
260434774		CORD	TEST FIBER SM 2M ST/BCN										
N		EA	1	2	1								
260430749		CORD	TEST FIBER SM 2M ST/SC										
N		EA	1	2	1								
260435904		EPOXY	ZIRCONIA FERRULE										
N		EA	1	2	1								
260431101		KIT	FIBER FIELD TERMINATION SC										
N		EA	1	1	1								
260431739		KIT	SC ADD-ON TERMINATION										
N		EA	1	2	1								
260431747		KIT	SC CONSUMABLE FOR CERAMIC FERRULE CONNECTORS.										
N		EA	1	2	1								
260431119		PANEL	FIBER SC/SC 6-PACK										
1980474	1	EA	IL IN MI OH WI 09 09 09 09 09										
			W/BULKHEAD ADAPTER.										
260431127		PANEL	FIBER SC/ST HYBRID 6-PACK										
N		EA	1	1	1								
			W/BULKHEAD ADAPTER.										

DISTRIBUTION SERVICES
 NETWORK SERVICES
 TOOLS
 BUILDING JANITORIAL
 AUTOMOTIVE
 FORMS/OFFICE SUPPLIES
 GENERAL
 DATA VOICE

DISTRIBUTION SERVICES

NETWORK SERVICES

TOOLS

BUILDING JANITORIAL

AUTOMOTIVE

FORMS/OFFICE SUPPLIES

GENERAL

DATA VOICE

FIBER OPTIC COMPONENTS

PRODUCT IDENTIFIER		DESCRIPTION						
ITEM NUMBER	ORD. MULT.	SELL UNIT	STD. PKG. STOCK AVAILABILITY / PA	LEAD TIME	MIN. ORD.	A	C	
300087319 PEDESTAL FIBER OPTIC LOCK LT1								
1920058	1	EA	IL IN MI OH WI 21				21	
C6181.								
105380703 PIGTAIL FIBER 1.5M BCN SM								
N		EA	1	1	1			
Used for splicing Outside Plant fibers to termination equipment. NOW AVAILABLE THROUGH TOUCH-TONE ORDER ENTRY.								
260431440 PIGTAIL FIBER 2M ST SM UNJACKETED								
N		EA	1	4	1			
260431721 PIGTAIL FIBER 2.1M BCN MM UNJACKETED								
N		EA	1	4	1			
260431457 PIGTAIL FIBER 2.1M BCN SM UNJACKETED								
N		EA	1	4	1			
260431705 PIGTAIL FIBER 2.1M SC MM UNJACKETED								
N		EA	1	4	1			
260431432 PIGTAIL FIBER 2.1M SC SM UNJACKETED								
1980102	1	EA	IL IN MI OH WI 08				08 08	
260431713 PIGTAIL FIBER 2.1M ST MM UNJACKETED								
N		EA	1	4	1			
105165443 PIGTAIL MULTI MODE 2B- 5 50.0/125								
N		EA	1	2	1			
5ft orange.								
105165419 PIGTAIL MULTI MODE 2B- 7 50.0/125								
N		EA	1	4	1			
7ft orange.								
105165385 PIGTAIL MULTI MODE 2B-17 50.0/125								
N		EA	1	4	1			
17ft orange.								
105165328 PIGTAIL MULTI MODE 2B-35 50.0/125								
N		EA	1	4	1			
35ft orange.								
105165302 PIGTAIL MULTI MODE 3B- 5 62.5/125								
N		EA	1	4	1			
5ft grey.								
105165286 PIGTAIL MULTI MODE 3B- 7 62.5/125								
N		EA	1	2	1			
7ft grey.								
105165229 PIGTAIL MULTI MODE 3B-35 62.5/125								
N		EA	1	2	1			
35ft grey.								
105167563 PIGTAIL SINGLE MODE 1B -5								
N		EA	1	2	1			
5ft yellow.								
105168108 PIGTAIL SINGLE MODE 1B -7								
N		EA	1	2	1			
7ft yellow.								

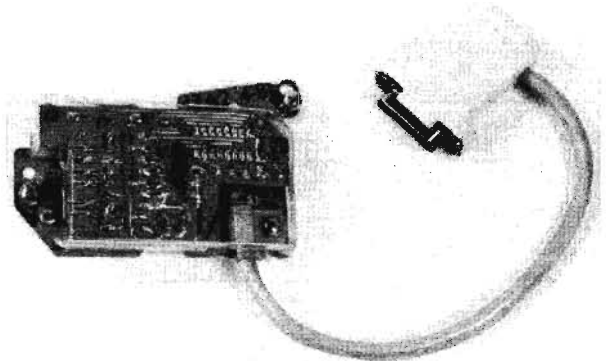
PRODUCT IDENTIFIER		DESCRIPTION						
ITEM NUMBER	ORD. MULT.	SELL UNIT	STD. PKG. STOCK AVAILABILITY / PA	LEAD TIME	MIN. ORD.	A	C	
300074242 PIGTAIL SINGLE MODE 80IN BICONICAL								
1334052	1	EA	IL IN MI OH WI 21 21 21 21 21					
Pigtail is fusion spliced directly to the fiber cable. The other end is equipped with biconic conn which allows outside cable to be terminated on field side of a 6-pack in a LSCIE cabinet.								
300055068 KIT CL0606 B-RANGE								
1177394	1	EA	IL IN MI OH WI 21 21 21 21 21					
Kit of parts used for fiber optic cables .410in to .585in diameter in a UCB1/51D3-LG2 closure. Includes adapter block w/SS screws and washers, 2 inboard/2 outboard inserts & 2 1-hole chevron grommets.								
								
1177394								
300055050 KIT CL0607 C-RANGE								
1187013	1	EA	IL IN MI OH WI 21 21 21 21 21					
Kit of parts used for fiber optic cables .590in to .765in diameter in a UCB1/51D3-LG2 closure.								
								
1187013								

DISTRIBUTION SERVICES

NETWORK SERVICES

TOOLS

BUILDING JANITORIAL

AUTOMOTIVE

FORMS/OFFICE SUPPLIES

GENERAL

DATA VOICE

PRODUCT IDENTIFIER		DESCRIPTION					
ITEM NUMBER	ORD. MULT.	SELL UNIT	STD. PKG. STOCK AVAILABILITY / PA	LEAD TIME	MIN. ORD.	A	C

300055043 KIT CL0608 D-RANGE

1211292	1	EA	IL 21	IN 21	MI 21	OH 21	WI 21
---------	---	----	-------	-------	-------	-------	-------

Kit of parts used for fiber optic cables .770in to .900in diameter in a UCB1/51D3-LG2 closure.

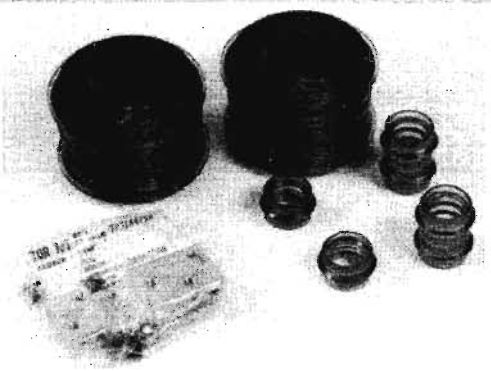

1211292

260411129 KIT CLEANING FIBER OPTIC TXT50A

1971119	1	EA	IL 21	IN 21	MI 21	OH 21	WI 21
---------	---	----	-------	-------	-------	-------	-------

FILTER

260446976 FILTER RADIO FREQUENCY INTERFERENCE

N With spade connectors.

260443114 FILTER RADIO FREQUENCY MODULAR, IVORY

N EA 1 4 1
Small encapsulated unit equipped with modular connector and line cord. Filter will suppress radio waves (AM & FM), CB and HAM frequency bands.

260437819 FILTER RADIO FREQUENCY SUPPRESSOR

N EA 1 4 1
W/O Spade Tips.

FIRE BARRIER

280052150 FIRE BARRIER CAULK 10.5OZ CP25

1927764 12 TU
Self leveling.

260392394 FIRE BARRIER CAULK 10.5OZ CS25WB

1969956 12 TU IL IN MI OH WI 09
Water based, 3M, for cable trays, openings, conduits, etc.

260406442 FIRE BARRIER CAULK 5 GALLON CP25WB

1969972 1 CS IL IN MI OH WI 09
Water-based, 3M, caulk for cable trays, openings, conduits, etc.

PRODUCT IDENTIFIER		DESCRIPTION					
ITEM NUMBER	ORD. MULT.	SELL UNIT	STD. PKG. STOCK AVAILABILITY / PA	LEAD TIME	MIN. ORD.	A	C

300017662 FIRE BARRIER COMPOUND SEAL PR-855-06

5123117	1	CS	IL 08	IN 08	MI 08	OH 08	WI 08
---------	---	----	-------	-------	-------	-------	-------

Fire resistant silicone foam. Used to block fire, smoke, fumes and water in floor and wall penetration, cable conduit cable trays, and cable vaults, case of 2.

280053828 FIRE BARRIER FIBER CERAMIC AA417

N CT 1 2 1
2LB BAG. 5 bags per carton.

280049859 FIRE BARRIER FOAM PR-855

N CS 1 2 2
Fire resistant, case of 2 one gallon containers.

260353693 FIRE BARRIER PUTTY MPP-1

1951871	1	EA	IL 04	IN 04	MI 04	OH 04	WI 04
---------	---	----	-------	-------	-------	-------	-------

4in X 8in X 1/8in, used as a fire protection barrier for cable trays, openings, conduit, etc.

260353701 FIRE BARRIER PUTTY MPS-2 STICK

1951863	1	EA	IL 09	IN 09	MI 09	OH 09	WI 09
---------	---	----	-------	-------	-------	-------	-------

1 1/2in X 12in, used as a fire protection barrier for cable trays, openings, conduit, etc.

280052135 FIRE BARRIER SHEET CS195 36IN X 24IN

1927780	1	EA	IL 08	IN 08	MI 08	OH 08	WI 08
---------	---	----	-------	-------	-------	-------	-------

Composite, 3M, used as a fire protection barrier for cable trays, openings, conduit, etc., use only 42in x 42in pallet.

260406400 FIRE BARRIER SHEET CS195 36IN X 36IN

1969931	1	CS	IL 09	IN 09	MI 09	OH 09	WI 09
---------	---	----	-------	-------	-------	-------	-------

Composite, 3M, used as a fire protection barrier for cable trays, openings, conduit, etc., use only 42in x 42in pallet.

260406418 FIRE BARRIER SHEET CS195 36IN X 41IN

1969949	1	CS	IL 09	IN 09	MI 09	OH 09	WI 09
---------	---	----	-------	-------	-------	-------	-------

Composite, 3M, used as a fire protection barrier for cable trays, openings, conduit, etc., use only 42in x 42in pallet.

300017779 FIRE BARRIER SILICONE FOAM PR-855- 2

N CS 1 2 2
Fire resistant, case of 2, 2 OZ container.

300017670 FIRE BARRIER SILICONE FOAM PR-855- 8

N CS 1 2 2
Fire resistant, case of 20, 8 OZ.

300017688 FIRE BARRIER SILICONE FOAM PR-855-20

N CS 1 2 1
Fire resistant, case of 12, 20 OZ.

280052143 FIRE BARRIER SYSTEM PENETRATION SEAL

N EA 10 3 10
7902-4.

280052168 FIRE BARRIER WRAP/STRIP 2IN X 24IN

1927855	10	EA	IL 08	IN 08	MI 08	OH 08	WI 08
---------	----	----	-------	-------	-------	-------	-------

FS 195.

DISTRIBUTION SERVICES

NETWORK SERVICES

TOOLS

BUILDING JANITORIAL

AUTOMOTIVE

FORMS/OFFICE SUPPLIES

GENERAL

DATA VOICE

FIRE BARRIER

PRODUCT IDENTIFIER

DESCRIPTION

ITEM NUMBER	ORD. MULT.	SELL UNIT	STD. PKG. STOCK AVAILABILITY / PA	LEAD TIME	MIN. ORD.	A	C
-------------	------------	-----------	-----------------------------------	-----------	-----------	---	---

260328521 FIRE RETARDANT PUTTY 1 1/4 PR895
N CS 1 3 1
Case of 12.

260328539 FIRE RETARDANT PUTTY 2 1/2 PR895
N CS 1 3 1
Case of 12. NOW AVAILABLE THROUGH TOUCH-TONE ORDER ENTRY.

FITTING

401331384 FITTING END EF4
1156448 1 EA

FIXTURE GUY

400144143 FIXTURE GUY SIDEWALK B
1156984 1 EA
Used for sidewalk guying consisting of pipe, 2 iron fittings, 2 set screws and a bolt.

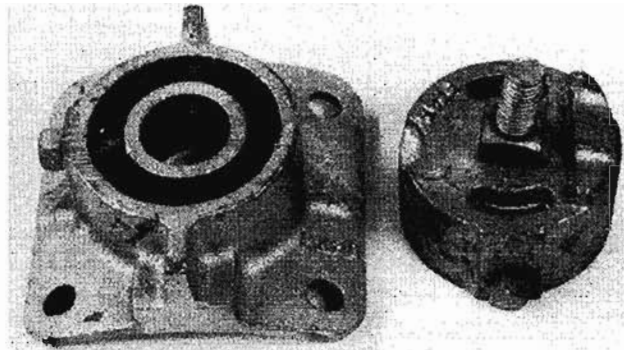

400144143

FLAG

300085826 FLAG VINYL COATED NYLON W/36IN
N EA 1 4 1
STAFF. Fluorescent orange/red, vinyl coated nylon 18in X 18in X 3/4in staff.

FLAG MARKER

260430772 FLAG MARKER 24IN ORANGE IL
1979468 1000 EA
Plastic Shaft, SC7452.

260412135 FLAG MARKER 24IN ORANGE MI
1979476 1000 EA IL IN MI OH WI
08
Plastic Shaft, Black Print, P/N SC7450.

260430798 FLAG MARKER 24IN ORANGE OH
1979484 1000 EA IL IN MI OH WI
08
Plastic Shaft, SC7453.

PRODUCT IDENTIFIER

DESCRIPTION

ITEM NUMBER	ORD. MULT.	SELL UNIT	STD. PKG. STOCK AVAILABILITY / PA	LEAD TIME	MIN. ORD.	A	C
-------------	------------	-----------	-----------------------------------	-----------	-----------	---	---

260430780 FLAG MARKER 24IN ORANGE WI
1979492 1000 EA IL IN MI OH WI
08
Plastic Shaft, SC7453.

260430848 FLAG MARKER 24IN WHITE ASI
1979500 1000 EA IL IN MI OH WI
08 08 08 08 08
Plastic Shaft, SC11165.

260395223 FLAG MARKER 30IN ORANGE ASI
1969857 1 EA IL IN MI OH WI
08 08 08 08 08
Metal Shaft, P/N SC11164

260436282 FLAG MARKER INSERTION TOOL
N EA 10 2 1
Carrier probe for use with marking flags.

FLEXPORT

SEE KIT FLEXPORT.

FOIL ALUMINUM

900589375 FOIL ALUMINUM KSR38A 04450136 500FT
N RO 1 4 2
NOW AVAILABLE THROUGH TOUCH-TONE ORDER ENTRY.

FRAME

260338629 FRAME 50K-1800-P3
N EA 1 4 1
Homaco.

260405717 FRAME 50LS-12-1 QUICK CONNECT
N EA 1 4 1
ACCESSORY. Homaco.

002049245 FRAME 50M-2700L QUICK CONNECT
N EA 1 4 1
ACCESSORY. Homaco, 2700 single sided, 8in high X 35.5in wide X 12in deep.

260338637 FRAME 50M-2700L-C140 WALL 66MI-50
N EA 1 4 1
Homaco.

401909403 FRAME 50M-2700W-89
N EA 1 4 1
Homaco.

260405816 FRAME 50M-GB QUICK CONNECT ACCESSORY
N EA 1 4 1
Homaco.

280011578 FRAME ACRYLIC 1401H8 5X7
N EA 1 2 1

DISTRIBUTION SERVICES
NETWORK SERVICES
TOOLS
BUILDING JANITORIAL
AUTOMOTIVE
FORMS/OFFICE SUPPLIES
GENERAL
DATA VOICE

PRODUCT IDENTIFIER DESCRIPTION

ITEM NUMBER	ORD. MULT.	SELL UNIT	STD. PKG. STOCK AVAILABILITY / PA	LEAD TIME	MIN. ORD.	A C
-------------	------------	-----------	-----------------------------------	-----------	-----------	-----

260439625 FRAME BAY NETWORK LGX DF 9FT ED8C504-50
 N EA 1 6 1
 G3.

260338900 FRAME BEF1AM

1954800	1	EA	IL 08	IN 08	MI 08	OH 08	WI
---------	---	----	-------	-------	-------	-------	----

260338918 FRAME BEF2AM CAB DOUBLE-SIDED

1954792	1	EA	IL 08	IN 08	MI 08	OH 08	WI
---------	---	----	-------	-------	-------	-------	----

300086360 FRAME MODULAR HARDWARE MH3DPM
 N EA 1 2 1

300086378 FRAME MODULAR HARDWARE MH6DPM
 N EA 1 2 1

280079534 FRAME MODULAR HARDWARE MH9DPM
 N EA 1 2 1
 900 pair, w/4005DPM tail MH9DPM.

280079724 FRAME MODULAR HARDWARE MH9E
 N EA 1 2 1
 900 pair, empty.

FRAME SELF STRIP

280057225 FRAME SELF STRIP SS3DPM
 1930875 1 EA
 600 pair frame, 300 filled, W/4320 self strip blocks.

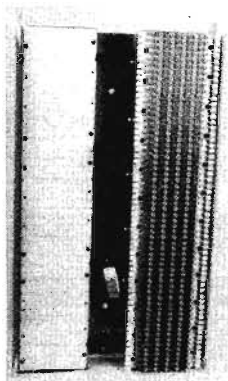

280057225

280056979 FRAME SELF STRIP SS3M
 N EA 1 2 1
 Filled W/MS2 tail.

280057233 FRAME SELF STRIP SS6DPM

1930867	1	EA	IL 08	IN 08	MI 08	OH 08	WI
---------	---	----	-------	-------	-------	-------	----

600 pair frame filled, W/4320-48 DPM blocks.

280056961 FRAME SELF STRIP SS6M
 N EA 1 2 1
 W/MS2 Tail.

PRODUCT IDENTIFIER DESCRIPTION

ITEM NUMBER	ORD. MULT.	SELL UNIT	STD. PKG. STOCK AVAILABILITY / PA	LEAD TIME	MIN. ORD.	A C
-------------	------------	-----------	-----------------------------------	-----------	-----------	-----

260325618 FRAME SELF STRIP SS9 6DPM
 N EA 1 3 1
 600 Pair filled with 4005DPM tail.

280079732 FRAME SELF STRIP SS9 6M
 N EA 1 2 1
 900 pair with 600 pair filled.

280079542 FRAME SELF STRIP SS9DPM
 N EA 1 2 1
 900 Pair 4005DPM Tail.

280057019 FRAME SELF STRIP SS9M
 N EA 1 2 1
 MS2 Tail.

GAS MONITORING EQUIPMENT

260434675 ALARM REMOTE #1755 ONLY CANNONBALL
 N

260434659 CYLINDER CARBON MONOXIDE 9033 CANNONBALL
 N
 Gas, 103 liter.

260422167 CYLINDER CARBON MONOXIDE P/N1810-0719
 N EA 1 3 1
 Calibration 50PPM.

260434667 CYLINDER H2S #9034 CANNONBALL 52 LITER
 N

260422159 CYLINDER PENTANE GAS P/N1810-1162
 N EA 1 3 1
 Calibration 25% LEL.

260422175 CYLINDER PENTANE GAS P/N1810-1253
 N EA 1 3 1
 Calibration N 02 CO.

260434634 CYLINDER PROPANE GAS 9032 FOR CANNONBALL
 N
 103 Liter.

260434683 HOSE ASPIRATOR 15FT STD ONLY CANNONBALL
 N
 P/N 53-001X. Standard.

260434691 HOSE ASPIRATOR 25FT OPT ONLY CANNONBALL
 N
 P/N 53-001X. Optional.

260445416 KIT CALIBRATION A-3 ONLY CANNONBALL
 N EA 1 1 1
 P/N 1753. Kit calibration for 3-sensor monitor, contains propane, & CO gases for Cannonball monitor/measures oxygen, LEL & carbon monoxide (CO).

GAS MONITORING EQUIPMENT

DISTRIBUTION SERVICES

PRODUCT IDENTIFIER DESCRIPTION

ITEM NUMBER	ORD. MULT.	SELL UNIT	STD. PKG. STOCK AVAILABILITY / PA	LEAD TIME	MIN. ORD.	A C
-------------	------------	-----------	-----------------------------------	-----------	-----------	-----

260434626 KIT CALIBRATION A-4 ONLY CANNONBALL
 N EA 1 1 1
 P/N 1753 Kit calibration for a 4-sensor monitor; contains Carbon Monoxide (CO), Propane & H2S gases for Cannonball monitor.

260421342 KIT CALIBRATION FOR CMX-271
 N EA 1 3 1
 GAS MONITOR P/N1810-1295.

260434618 MONITOR CONTINUOUS 3-GAS CANNONBALL
 N EA 1 1 1
 P/N 1723. Measures ONLY 3 gases, Oxygen (O2), LEL, & Carbon Monoxide (CO).

260419072 MONITOR GAS 434 CONTINUOUS
 N EA 1 4 1

260419080 MONITOR GAS CMX271
 N EA 1 4 1
 P/N 1810-1113.

260445390 SENSOR CO FOR CANNONBALL MONITOR #1634
 N EA 1 1 1

260445408 SENSOR COMBUSTBLE FOR CANNONBALL MONITOR
 N EA 1 1 1
 P/N 1738.

260445382 SENSOR H2S FOR CANNONBALL MONITOR #1632
 N EA 1 1 1

260445374 SENSOR OXYGEN FOR CANNONBALL MONITOR
 N EA 1 1 1
 P/N 1630.

NETWORK SERVICES

TOOLS

BUILDING JANITORIAL

AUTOMOTIVE

FORMS/OFFICE SUPPLIES

GENERAL

DATA VOICE

GASKET

260439229 GASKET ELASTOMERIC SMOOTH CORE
 N

GAUGE PRESSURE B & C

SEE SECTION 3-TOOLS - PRESSURIZATION AIR CABLE EQUIPMENT.

GEL

402698302 GEL B INDEX MATCHING CA08955
 N EA 1 4 1
 A compound that is placed between the fibers when spliced. CC 402-698-302, non-stock due to shelf life.

GRIP KIT

845583913 GRIP KIT UC-48
 N EA 1 4 1

PRODUCT IDENTIFIER DESCRIPTION

ITEM NUMBER	ORD. MULT.	SELL UNIT	STD. PKG. STOCK AVAILABILITY / PA	LEAD TIME	MIN. ORD.	A C
-------------	------------	-----------	-----------------------------------	-----------	-----------	-----

GRIP STRAND

Made spirally of formed high strength steel with class C galvanized coating. Used to terminate corrosion-resistant strand. BSP 627-240-212.

400146825 GRIP STRAND B 2.2M CA07938
 1180968 1 EA

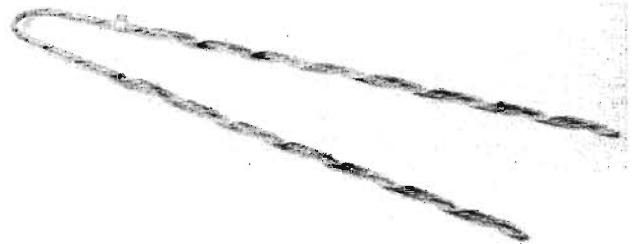

400146825

400146833 GRIP STRAND B 6 M CA07938
 1180984 1 EA IL IN MI OH WI
 14 14 14 14 14

400146841 GRIP STRAND B 6.6M CA07938
 1181024 1 EA IL IN MI OH WI
 08 08 08 08 08

400146858 GRIP STRAND B 10 M CA07938
 1181008 1 EA IL IN MI OH WI
 08 08 08 08 08

400146866 GRIP STRAND B 16 M CA07938
 N EA 25 4 75

400146874 GRIP STRAND B 25 M CA07938
 N EA 10 14 10

GROMMET

300060233 GROMMET CL 0200 CHEVRON
 N EA 10 2 10
 These fibre optic grommets must be inserted in the 5103-LG2 Closure, one grommet per cable.

300060241 GROMMET CL 0201 CHEVRON
 N EA 10 2 10
 These fibre optic grommets must be inserted in the 5103-LG2 Closure, one grommet per cable.

300060258 GROMMET CL 0202 CHEVRON
 N EA 10 2 10
 These fibre optic grommets must be inserted in the 5103-LG2 Closure, one grommet per cable.

300060266 GROMMET CL 0203 CHEVRON
 N EA 10 2 10
 These fibre optic grommets must be inserted in the 5103-LG2 Closure, one grommet per cable.

105150270 GROMMET UC 41/41
 N EA 1 2 1
 NOW AVAILABLE THROUGH TOUCH-TONE ORDER ENTRY.

DISTRIBUTION SERVICES

NETWORK SERVICES

TOOLS

BUILDING JANITORIAL

AUTOMOTIVE

FORMS/OFFICE SUPPLIES

GENERAL

DATA VOICE

PRODUCT IDENTIFIER DESCRIPTION

ITEM NUMBER	ORD. MULT.	SELL UNIT	STD. PKG. STOCK AVAILABILITY / PA	LEAD TIME	MIN. ORD.	A C
105150296		GROMMET	UC 48/41			
N		EA	1	2	1	
400621389		GROMMET NYLON AERIAL TG4/6				
N		EA	50	6	50	
400621397		GROMMET NYLON AERIAL TG8				
N		EA	25	6	25	

ITEM NUMBER	ORD. MULT.	SELL UNIT	STD. PKG. STOCK AVAILABILITY / PA	LEAD TIME	MIN. ORD.	A C
280080979		GROMMET PLUG GP88100				
1945691	1	EA	IL 08 IN 08 MI 08 OH 08 WI 08			

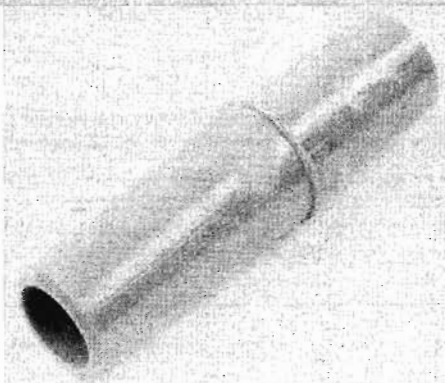

1945691

ITEM NUMBER	ORD. MULT.	SELL UNIT	STD. PKG. STOCK AVAILABILITY / PA	LEAD TIME	MIN. ORD.	A C
401970777		GROMMET SERVICE WIRING 3/4IN				
1194928	1	PK	IL 08 IN 08 MI 08 OH 08 WI 08			

Grommet fits CAD closures with inserts to allow B service wire entry, package of 50.

ITEM NUMBER	ORD. MULT.	SELL UNIT	STD. PKG. STOCK AVAILABILITY / PA	LEAD TIME	MIN. ORD.	A C
845628775		GROMMET UNIVERSAL CLOSURE				
N		EA	1	6	1	

GROMMET AND GRIP

ITEM NUMBER	ORD. MULT.	SELL UNIT	STD. PKG. STOCK AVAILABILITY / PA	LEAD TIME	MIN. ORD.	A C
845771344		GROMMET AND GRIP KIT UC-41				
N		EA	1	2	1	

Grommet and grips for a single unit cross ply cable. Used with the UCB1.

ITEM NUMBER	ORD. MULT.	SELL UNIT	STD. PKG. STOCK AVAILABILITY / PA	LEAD TIME	MIN. ORD.	A C
260329883		GROMMET AND GRIP KIT UC-50				
1946707	1	EA	IL 21 IN 21 MI 21 OH 21 WI 21			

CC105389258 Grommet and grip kit for LXE sheath and UCB1 closures.

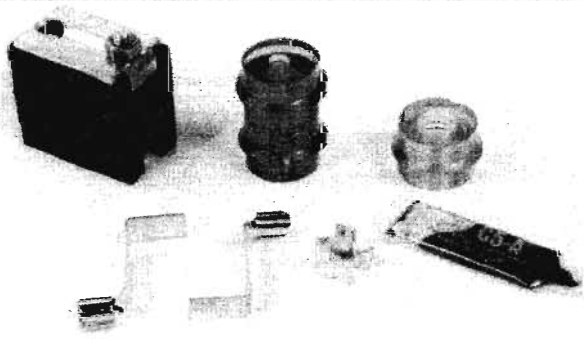

1946707

PRODUCT IDENTIFIER DESCRIPTION

ITEM NUMBER	ORD. MULT.	SELL UNIT	STD. PKG. STOCK AVAILABILITY / PA	LEAD TIME	MIN. ORD.	A C
260329909		GROMMET AND GRIP KIT UC-58				
1946715	1	EA	IL 21 IN 21 MI 21 OH 21 WI 21			

CC105439376 Grommet and grip kit for LXE sheath and UCB1 closures.

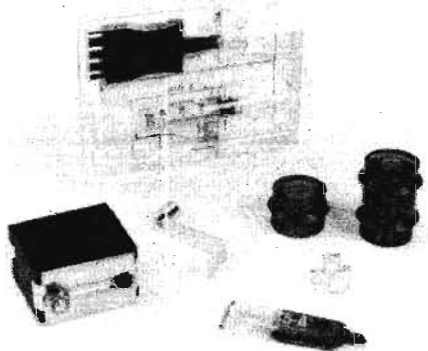

1946715

ITEM NUMBER	ORD. MULT.	SELL UNIT	STD. PKG. STOCK AVAILABILITY / PA	LEAD TIME	MIN. ORD.	A C
845771351		GROMMET AND GRIP KIT UC-65				
N		EA	1	2	1	

Grommets and grips for a three unit single ply fiber optic cable. Used with the UCB1 light guide closure.

ITEM NUMBER	ORD. MULT.	SELL UNIT	STD. PKG. STOCK AVAILABILITY / PA	LEAD TIME	MIN. ORD.	A C
845771369		GROMMET AND GRIP KIT UC-75				
N		EA	1	2	1	

ITEM NUMBER	ORD. MULT.	SELL UNIT	STD. PKG. STOCK AVAILABILITY / PA	LEAD TIME	MIN. ORD.	A C
845771377		GROMMET AND GRIP KIT UC-79/82				
N		EA	1	6	1	

ITEM NUMBER	ORD. MULT.	SELL UNIT	STD. PKG. STOCK AVAILABILITY / PA	LEAD TIME	MIN. ORD.	A C
845771385		GROMMET AND GRIP KIT UC-95/98				
N		EA	1	2	1	

GROMMET KIT

ITEM NUMBER	ORD. MULT.	SELL UNIT	STD. PKG. STOCK AVAILABILITY / PA	LEAD TIME	MIN. ORD.	A C
104145560		GROMMET KIT UC 41				
1139428	1	EA				

For cables with .41IN diameter used with the 51D3-LG2 outer closure that protects the UCB1 inner closure.

ITEM NUMBER	ORD. MULT.	SELL UNIT	STD. PKG. STOCK AVAILABILITY / PA	LEAD TIME	MIN. ORD.	A C
104145537		GROMMET KIT UC 48				
1154336	1	EA	IL 21 IN 21 MI 21 OH 21 WI 21			

For cables with .48IN to .50IN diameter. Used with the 51D3-LG2 outer closure that protects the UCB1 inner closure.

ITEM NUMBER	ORD. MULT.	SELL UNIT	STD. PKG. STOCK AVAILABILITY / PA	LEAD TIME	MIN. ORD.	A C
104146576		GROMMET KIT UC 55				
1947176	1	EA	IL 21 IN 21 MI 21 OH 21 WI 21			

Used on 51D3LG2 Outer Closure. One per sheath entry.

ITEM NUMBER	ORD. MULT.	SELL UNIT	STD. PKG. STOCK AVAILABILITY / PA	LEAD TIME	MIN. ORD.	A C
104145545		GROMMET KIT UC 65				
1175695	1	EA	IL 21 IN 21 MI 21 OH 21 WI 21			

Grommet for a three unit single ply cable. Used with the 51D2-LG2 closure.

ITEM NUMBER	ORD. MULT.	SELL UNIT	STD. PKG. STOCK AVAILABILITY / PA	LEAD TIME	MIN. ORD.	A C
300060506		GROMMET KIT ADAPTER BLOCK CL0600				
N		EA	10	2	10	

DISTRIBUTION SERVICES

NETWORK SERVICES

TOOLS

BUILDING JANITORIAL

AUTOMOTIVE

FORMS/OFFICE SUPPLIES

GENERAL

DATA VOICE

GROMMET KIT

PRODUCT IDENTIFIER		DESCRIPTION						
ITEM NUMBER	ORD. MULT.	SELL UNIT	STD. PKG. STOCK AVAILABILITY / PA	LEAD TIME	MIN. ORD.	A	C	

ITEM NUMBER	ORD. MULT.	SELL UNIT	STD. PKG. STOCK AVAILABILITY / PA	LEAD TIME	MIN. ORD.	A	C
-------------	------------	-----------	-----------------------------------	-----------	-----------	---	---

103922035 GROMMET KIT UC-41 LIGHTGUIDE

1333724	1	EA	IL IN MI OH WI	21 21 21 21 21			
---------	---	----	----------------	----------------	--	--	--

Used with UCB1 lightguide closures. One grommet kit is required for each cable entering the UCB1 closure.

103922043 GROMMET KIT UC-48 LIGHTGUIDE

1333716	1	EA	IL IN MI OH WI	21 21 21 21 21			
---------	---	----	----------------	----------------	--	--	--

103922050 GROMMET KIT UC-65 LIGHTGUIDE

1333708	1	EA	IL IN MI OH WI	21 21 21 21 21			
---------	---	----	----------------	----------------	--	--	--

Grommets and grips for a three unit single ply fiber optic cable. Used with the UCB1 lightguide closure.

103922027 GROMMET KIT UC-STH LIGHTGUIDE

N		EA	1	2	1		
---	--	----	---	---	---	--	--

Sheath term.

GROUND CLAMP

SEE CLAMP GROUND.

GROUND LEAD

SEE LEAD GROUND.

GROUND LUG

SEE LUG GROUND.

GROUND ROD

SEE ROD GROUND.

GROUND STRIP

SEE STRIP GROUND.

GROUND WIRE

SEE WIRE GROUND.

GUARD

842629503 GUARD 842629503

N		EA	1	12	1		
---	--	----	---	----	---	--	--

997161617 GUARD CK19478 L1

2750604	1	EA	IL IN MI OH WI	59 59 59 59 59			
---------	---	----	----------------	----------------	--	--	--

A guard to protect special circuits at the test field of 303 type connectors. BSP 636-330-100.

260441886 GUARD DROP STAINLESS STEEL

N		EA	1	2	1		
---	--	----	---	---	---	--	--

401781612 GUARD GUY 1 3/4IN X 8FT YELLOW

1190793	1	EA	IL IN MI OH WI	14 14 14 14 14			
---------	---	----	----------------	----------------	--	--	--

Used for protection of pedestrians and vehicles on ground side of down guys.

PRODUCT IDENTIFIER		DESCRIPTION						
ITEM NUMBER	ORD. MULT.	SELL UNIT	STD. PKG. STOCK AVAILABILITY / PA	LEAD TIME	MIN. ORD.	A	C	

ITEM NUMBER	ORD. MULT.	SELL UNIT	STD. PKG. STOCK AVAILABILITY / PA	LEAD TIME	MIN. ORD.	A	C
-------------	------------	-----------	-----------------------------------	-----------	-----------	---	---

402742704 GUARD GUY 2 3/4IN X 8FT YELLOW

1417022	1	EA	IL IN MI OH WI	14 14 14 14 14			
---------	---	----	----------------	----------------	--	--	--

300088655 GUARD SERVICE WIRE WITH OFFSET 5FT

1920538	1	CT	IL IN MI OH WI	18 18 18 18 18			
---------	---	----	----------------	----------------	--	--	--

A 1/2in plastic conduit used to protect buried drop at pole & building location. Manufactured with off set at top.

1920538

401133327 GUARD U 8IN X 5FT GALVANIZED METAL

N		EA	1	6	1		
---	--	----	---	---	---	--	--

GUARD CABLE

300094604 GUARD CABLE 1 1/2IN X 10FT BLACK

N		FT	200	2	1000		
---	--	----	-----	---	------	--	--

Used for the protection of cable against damage by squirrels, 200ft per bundle, black.

300094612 GUARD CABLE 2 1/2IN X 10FT BLACK

N		FT	200	6	1000		
---	--	----	-----	---	------	--	--

200ft per bundle, black.

300094620 GUARD CABLE 3 1/4IN X 10FT BLACK

N		FT	200	6	1000		
---	--	----	-----	---	------	--	--

200ft per bundle, CB30045AML5.

300094638 GUARD CABLE 4 1/2IN X 10FT BLACK

N		FT	200	2	1000		
---	--	----	-----	---	------	--	--

200ft per bundle, CB30045AML6.

402036008 GUARD CABLE B 1/2IN

N		PK	8	4	48		
---	--	----	---	---	----	--	--

Tubing used for the prevention of abrasion to cable sheath, CA07422. FORWARD TO GUARD CA B1. Package of 30.

402036024 GUARD CABLE B 1 1/2IN PACKAGE 10

N		PK	5	4	60		
---	--	----	---	---	----	--	--

Tubing used for the prevention of abrasion to cable sheath, CA07422. Package of 8.

402036016 GUARD CABLE B 1IN CA07422

N		PK	8	6	56		
---	--	----	---	---	----	--	--

Tubing used for the prevention of abrasion to cable sheath. Package of 8. BSP 627-360-200.

402036032 GUARD CABLE B 2IN CA07422

2823120	1	PK	IL IN MI OH WI	08 08 08 08 08			
---------	---	----	----------------	----------------	--	--	--

Tubing used for the prevention of abrasion to cable sheath. Package of 8. BSP 627-360-200.

280046418 GUARD CABLE C 1 1/2IN CA08402

N		PK	50	4	1000		
---	--	----	----	---	------	--	--

280046426 GUARD CABLE C 2IN X 10FT BLACK

N		PK	36	4	1000		
---	--	----	----	---	------	--	--

CA08402.

DISTRIBUTION SERVICES

NETWORK SERVICES

TOOLS

BUILDING JANITORIAL

AUTOMOTIVE

FORMS/OFFICE SUPPLIES

GENERAL

DATA VOICE

PRODUCT IDENTIFIER		DESCRIPTION					
ITEM NUMBER	ORD. MULT.	SELL UNIT	STD. PKG. STOCK AVAILABILITY / PA	LEAD TIME	MIN. ORD.	A	C
280047119			GUARD CABLE L 9 10FT X 1 1/2IN				
N		FT	200 CB 30045 AM L9.	6	200		
280047127			GUARD CABLE L10 10FT X 2 1/2IN				
N		FT	200 CB 30045 AM L10.	6	1000		
280017104			GUARD CABLE PLASTIC U 1IN X 8FT				
1924084	1	EA	IL IN MI OH WI 08 08 08				
IBT Specification.							
280017120			GUARD CABLE PLASTIC U 2IN X 8FT				
1924076	1	EA	IL IN MI OH WI 08 08				
IBT Specification.							
280017146			GUARD CABLE PLASTIC U 3IN X 8FT				
1924068	1	EA	IL IN MI OH WI 08 08				
IBT Specification.							
280017112			GUARD CABLE PLASTIC U 4IN X 8FT				
1924050	1	EA	IL IN MI OH WI 08 08				
IBT Specification.							
280017138			GUARD CABLE PLASTIC U 5IN X 8FT				
1924043	1	EA	IL IN MI OH WI 08 08 08 08				
IBT Specification.							
401498118			GUARD CABLE U UP3758G				
N		EA	5	6	5		
400314308			GUARD CABLE U0 5FT CA06789				
N		EA	5	8	5		
400314316			GUARD CABLE U0 8FT CA06789				
1333658	1	EA	IL IN MI OH WI 08 08 08 08				
A galvanized guard formed in the shape of a (U) and used to protect cable on poles and building walls from mechanical injury, BSP 627-620-200.							
400314324			GUARD CABLE U1 5FT CA06789				
N		EA	5	8	5		
400314332			GUARD CABLE U1 8FT CA06789				
1103085	1	EA	IL IN MI OH WI 08 08 08 08 08				
Cable size 1IN.							
400314357			GUARD CABLE U1A 8FT CA06789				
1181461	1	EA	IL IN MI OH WI 08 08 08 08				
400314373			GUARD CABLE U2 8FT CA06789				
1181503	1	EA	IL IN MI OH WI 08 08 08 08 08				
Cable size 2IN.							

PRODUCT IDENTIFIER		DESCRIPTION					
ITEM NUMBER	ORD. MULT.	SELL UNIT	STD. PKG. STOCK AVAILABILITY / PA	LEAD TIME	MIN. ORD.	A	C
400314399			GUARD CABLE U3 8FT CA06789				
1181529	1	EA	IL IN MI OH WI 08 08 08 08 08				
Cable size 3IN.							
400314407			GUARD CABLE U4 8FT CA06789				
1181545	1	EA	IL IN MI OH WI 08 08 08 08 08				
GUARD TREE							
400147450			GUARD TREE L 1 3/4IN CA06862				
1181727	1	EA					
Guard is 2ft long, made of wood and is used for protecting lashed cables passing among tree branches.							
400147468			GUARD TREE L 2 3/8IN CA06862				
1181743	1	EA	IL IN MI OH WI 08 08 08 08 08				
400147476			GUARD TREE L 3 IN CA06862				
1181768	1	EA	IL IN MI OH WI 08 08 08 08 08				
GUARD WIRE							
300032034			GUARD WIRE 12-122				
1139386	1	EA					
Specially designed for use on telephone and power poles to protect against damaging the wire inside.							
400147518			GUARD WIRE C CA07979				
1103150	1	PK	IL IN MI OH WI 18 18 18 18 18				
A slip plastic tube 36in long 1 1/8in diameter and is designed to protect multiple line wire and multiple drop wire against abrasion, BSP 624-030-105.							
							
1103150							
400147526			GUARD WIRE E 50FT COIL CA07195				
1181800	1	CL	IL IN MI OH WI 18 18 18 18 18				
Clear plastic tubing for protection of station wires from mechanical injury where attached to wall surface or passed through partitions. BSP 461-200-201.							
400147534			GUARD WIRE L 3/16 CA07150				
N		CL	10	4	10		
400147542			GUARD WIRE L 21/24 CA07150				
N		CL	10	4	10		
400147559			GUARD WIRE P CA07013				
1181826	1	PK	IL IN MI OH WI 18 18 18 18 18				
A plastic tubing, Helically wound, 3in x 7/16in used to protect drop wire from abrasion where tree contacts are unavoidable, BSP 461-200-201.							

DISTRIBUTION SERVICES

GUIDE

PRODUCT IDENTIFIER		DESCRIPTION					
ITEM NUMBER	ORD. MULT.	SELL UNIT	STD. PKG. STOCK AVAILABILITY / PA	LEAD TIME	MIN. ORD.	A	C

PRODUCT IDENTIFIER		DESCRIPTION					
ITEM NUMBER	ORD. MULT.	SELL UNIT	STD. PKG. STOCK AVAILABILITY / PA	LEAD TIME	MIN. ORD.	A	C

NETWORK SERVICES

GUIDE

260448980			GUIDE WIRE 50/PKG PLASTIC F600271				
N							
845363506			GUIDE CABLE (ED8C003 G-2)				
N		EA	1	4		1	

HANGER DOOR DOCUMENT

SEE INTERFACE NETWORK DOOR HANGER DOCUMENT.

TOOLS

HANDHOLE

260450713			HANDHOLE ASSEMBLY FIBER OPTIC 30X48X36				
N							
260450721			HANDHOLE ASSEMBLY FIBER OPTIC FITL				
N			13 X 24 X 36IN.				
260450739			HANDHOLE COVER FIBER OPTIC 30 X 48IN				
N							

HARDWARE

260405774			HARDWARE CABLE RUNWAY P401750H-2				
N		EA	1	4		1	
			Homaco, frame.				
260405766			HARDWARE CABLE RUNWAY P403472H				
N		EA	1	4		1	
			Homaco, frame.				
260405782			HARDWARE CABLE RUNWAY P429503H				
N		EA	1	4		1	
			Homaco, frame.				
260405758			HARDWARE CABLE RUNWAY P987645H				
N		EA	1	4		1	
			Homaco, frame.				
260405824			HARDWARE CABLE RUNWAY TR10-12				
N		EA	1	4		1	
			Homaco, frame.				

BUILDING JANITORIAL

HANDLE AIR FUEL

280028127			HANDLE AIR FUEL AD-1601				
N		EA	1	6		10	

HARNESS BONDING

260345889			HARNESS BONDING 2IN X 6IN				
N		SE	1	2		1	
			Closure BH2-6 78-8011-1809-8 SJ.				
260323308			HARNESS BONDING 7IN CLOSURE BH7				
N		SE	1	2		1	
260323373			HARNESS BONDING 8IN-9IN CLOSURE				
N		SE	1	2		1	
			BH8-9.				
260322466			HARNESS BONDING 10IN-12IN CLOSURE				
N		SE	1	2		1	
			BH12-10. NOW AVAILABLE THROUGH TOUCH-TONE ORDER ENTRY.				

AUTOMOTIVE

HANDLE POLE MOUNT

260347968			HANDLE POLE MOUNT LARGE				
N		SE	1	2		1	
			1 set 2 handles for 1200, 1500, and 1800 pair cabinets.				
260347950			HANDLE POLE MOUNT SMALL				
N		SE	1	2		1	
			1 set 2 handles for 100, 200, 300, 400, 600, and 900 pair cabinets.				

FORMS/OFFICE SUPPLIES

HANGER

103118865			HANGER 54A				
1403246	100	EA					
			Hanger bracket for strand mounting a 50 type closure. Used to support 50 & 51 type splice closures from aerial stand, BSP 633-506-205.				

GENERAL

300034113			HANGER AH 20				
5108753	1	PK	IL	IN	MI	OH	WI
			08	08	08	08	08
			This hanger is used to hang the 2 type plastic closure from aerial strand, BSP 633-506-201. Package of 2.				

DATA VOICE

PRODUCT IDENTIFIER		DESCRIPTION				
ITEM NUMBER	ORD. MULT.	SELL UNIT	STD. PKG. STOCK AVAILABILITY / PA	LEAD TIME	MIN. ORD.	A C

PRODUCT IDENTIFIER		DESCRIPTION				
ITEM NUMBER	ORD. MULT.	SELL UNIT	STD. PKG. STOCK AVAILABILITY / PA	LEAD TIME	MIN. ORD.	A C

HEADS LOCKING

HOOK

280054438 HEADS LOCKING STRAPPING CSS-LH

1929877 20 PK
Used in association with 1/2in strapping material to permanently support outdoor facilities such as aerial terminals and closures, DELTEC.

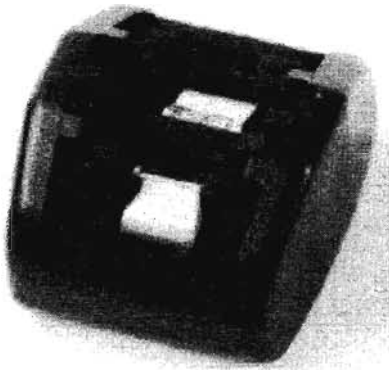

280054438

400314530 HOOK DRIVE 5 1/2IN X 7/16IN CA07365

1183822 25 EA
A steel hook for use in attaching parallel drop wires to poles, BSP 462-300-200.

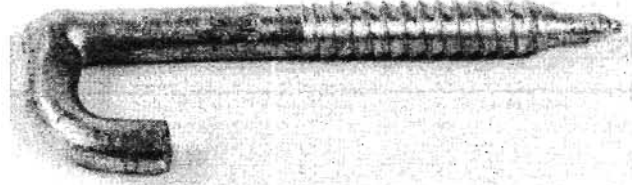

400314530

401338967 HOOK EXTENSION DROP WIRE W1116

N EA 25 8 100
A 36in long galvanized rod used to extend drop wire from roof anchor or electric service pipe around overhang.

400315156 HOOK WIRE DROP B CA06530

1183947 50 EA IL IN MI OH WI
18 18 18 18 18
Used as first and intermediate attachments when porcelain insulated building attachments are not required, BSP 080-720-131.

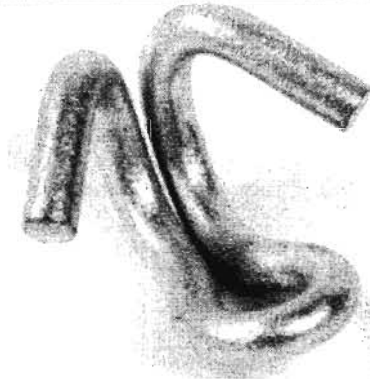

1183947

HELIX ANCHOR

SEE ANCHOR HELIX.

HINGE

400369690 HINGE CK20309 L 1

N PK 1 3 1
2 hinges per package,

HOLDER

105034474 HOLDER 1A1

N EA 1 3 1
Provides a place to mount the #4, 5 & 6 type mini-fanout inside a #100A lightguide interconnection unit (LIU).

845626415 HOLDER CONNECTOR

N EA 1 4 1

260394259 HOLDER EGG NEST SPLICE 90637

N EA 1 2 1

260440870 HOLDER JUMPER WIRE - HUT

N EA 1 3 1

005731526 HOLDER NUMBER POLE CEI SP

1220723 1 EA IL IN MI OH WI
14

260437116 HOLDER TIE NSH376

N PK 1 5 1

HOOK CABLE

997951108 HOOK CABLE 4 IN CA06784

1183665 1 EA
Used in supporting cable in manholes and cable vaults, BSP 632-305-015.

996031159 HOOK CABLE 7 1/2IN CA06784

1183681 1 EA IL IN MI OH WI
08 08 08 08 08

996031187 HOOK CABLE 10 IN CA06784

1183707 1 EA IL IN MI OH WI
08 08 08 08 08

400314480 HOOK CABLE 10 IN L CA06784

N EA 25 8 25

DISTRIBUTION SERVICES
 NETWORK SERVICES
 TOOLS
 BUILDING JANITORIAL
 AUTOMOTIVE
 FORMS/OFFICE SUPPLIES
 GENERAL
 DATA VOICE

HOOK CABLE

PRODUCT IDENTIFIER		DESCRIPTION						
ITEM NUMBER	ORD. MULT.	SELL UNIT	STD. PKG. STOCK AVAILABILITY / PA	LEAD TIME			MIN. ORD.	A C
400314464 HOOK CABLE 14 IN CA06784								
1183723	1	EA	IL 08 IN 08 MI 08 OH 08 WI 08					

400314472 HOOK CABLE 18 IN CA06784								
1183749	1	EA	IL 08 IN 08 MI 08 OH 08 WI 08					

HOOK GUY

400149928 HOOK GUY B 3/4IN CA07909								
1183863	1	EA	For attaching guys to poles. The size of the hook is associated with diameter of the cross-arm or cable suspension bolt used, BSP 621-410-212.					

400149910 HOOK GUY B 5/8IN CA07909								
1183848	1	EA	IL 14 IN 14 MI 14 OH 14 WI 14					

400722716 HOOK GUY B 1IN								
N		EA	20	6	20			

HOSE PRESSURE B, D & E

SEE SECTION 3-TOOLS - PRESSURIZATION AIR CABLE EQUIPMENT.

HOUSELINE

400150850 HOUSELINE 1LB BALL CA06788								
1184143	1	BL	A heavy hemp string for supporting cables temporarily, BSP 632-020-100.					

HOUSING

400151007 HOUSING CK19316 L4								
1184382	1	EA	Weatherproof housing and snap cover for an outdoor extension outlet. Equipped with receptacle mounting bracket, screws, etc., BSP 461-630-100.					

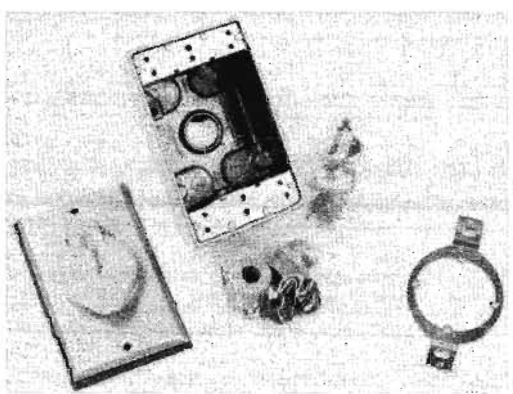

400151007

PRODUCT IDENTIFIER		DESCRIPTION						
ITEM NUMBER	ORD. MULT.	SELL UNIT	STD. PKG. STOCK AVAILABILITY / PA	LEAD TIME			MIN. ORD.	A C

HOUSING CASE

103815197 HOUSING CASE 40DDP1 CABINET								
N		EA	1	1	1			

HOUSING REPEATER

103064010 HOUSING REPEATER 88A1								
N		EA	1	4	1	BSP 640-525-307.		

103064028 HOUSING REPEATER 88A1C								
N		EA	1	4	1			

103246476 HOUSING REPEATER 88A2C UN								
N		EA	1	4	1			

103064036 HOUSING REPEATER 89A1								
N		EA	1	4	1			

103064044 HOUSING REPEATER 89A1C								
N		EA	1	4	1			

103246484 HOUSING REPEATER 89A2C PR								
N		EA	1	4	1			

103205159 HOUSING REPEATER 89B1								
N		EA	1	4	1			

103205167 HOUSING REPEATER 89B1C								
N		EA	1	4	1			

HYDRALUBE

SEE LUBRICANT.

INDICATOR

260344569 INDICATOR PRESSURE D181546								
1950469	1	EA	Consists of 10 piece kit for 2200 UG Closure.					

INNERDUCT

260413505 INNERDUCT 1 1/2IN ORANGE P4450								
1971671	1	FT	SPLIT OR CORRUGATED. To be slipped over fiber optic cables in manhole locations to afford extra protection and high visibility to the cables.					

280079500 INNERDUCT 1 1/4IN ORANGE 1410								
1936054	1	FT	IL 21 IN 21 MI 21 OH 21 WI 21					
Fireproof orange corrugated solid innerduct for use w/fiber-optics in the central office.								

DISTRIBUTION SERVICES

NETWORK SERVICES

TOOLS

BUILDING JANITORIAL

AUTOMOTIVE

FORMS/OFFICE SUPPLIES

GENERAL

DATA VOICE

PRODUCT IDENTIFIER		DESCRIPTION					
ITEM NUMBER	ORD. MULT.	SELL UNIT	STD. PKG. STOCK AVAILABILITY / PA	LEAD TIME	MIN. ORD.	A	C

PRODUCT IDENTIFIER		DESCRIPTION					
ITEM NUMBER	ORD. MULT.	SELL UNIT	STD. PKG. STOCK AVAILABILITY / PA	LEAD TIME	MIN. ORD.	A	C

INSERT

INSIGNIA TAG

300086055 INSERT C03147000
 N EA 1 2 1
 An accessory for a Set Test 417A-2.

400315669 INSIGNIA TAG POLE MBT CO
 1185322 10 EA
 MICHIGAN BELL ONLY.

400472478 INSERT CONCRETE 1/2IN X 2 1/2IN
 1137000 1 EA IL IN MI OH WI
 35 35
 For fastening cable rack to manhole walls furnished with 1/2in x 2 1/2in bolt, BSP 622-520-100.

401501952 INSERT CONCRETE B CA8730
 5360289 100 EA IL IN MI OH WI
 35

260323407 INSERT THREADED ENDPLATE SNI300K
 1943704 1 PK IL IN MI OH WI
 08 08 08 08
 Used for replacing lost or damaged endplate inserts. 25 per pkg.

INSULATOR

400151916 INSULATOR PUNCHING TERMINAL 4
 N PK 120 4 240
 CA06798. Package of 100.

400151924 INSULATOR PUNCHING TERMINAL 5
 1185645 1 PK IL IN MI OH WI
 08 08 08 08
 CA06798. Package of 100. DISCONTINUE UPON STOCK DEPLETION

400151932 INSULATOR PUNCHING TERMINAL 7
 1185660 1 PK IL IN MI OH WI
 08 08
 CA06798. Package of 100.

400472502 INSULATOR PUNCHING TERMINAL 9
 1103309 1 PK IL IN MI OH WI
 18 18
 CA06798. Package of 100.

400314639 INSULATOR SCREWEYE L 5/8IN CA06206
 1240481 10 EA IL IN MI OH WI
 08 08 08 08
 A S-short stem and L-long stem screw eye used for supporting drop wires on wood or stucco buildings at attachments other than the first, BSP 080-720-101.

INSIGNIA POLE

CA06185. For use in identifying poles. Made of .016in half-hard aluminum alloy, 1 1/2in high, BSP 621-200-206.

400315503 INSIGNIA POLE 1 1/2IN 0
 1185348 100 EA

400315420 INSIGNIA POLE 1 1/2IN 1
 1185363 100 EA IL IN MI OH WI
 14 14 14 14 14

400315438 INSIGNIA POLE 1 1/2IN 2
 1185389 100 EA IL IN MI OH WI
 14 14 14 14 14

400315446 INSIGNIA POLE 1 1/2IN 3
 1185405 100 EA IL IN MI OH WI
 14 14 14 14 14

400315453 INSIGNIA POLE 1 1/2IN 4
 1185421 100 EA IL IN MI OH WI
 14 14 14 14 14

400315461 INSIGNIA POLE 1 1/2IN 5
 1185447 100 EA IL IN MI OH WI
 14 14 14 14 14

400315479 INSIGNIA POLE 1 1/2IN 6
 1185462 100 EA IL IN MI OH WI
 14 14 14 14 14

400315487 INSIGNIA POLE 1 1/2IN 7
 1185488 100 EA IL IN MI OH WI
 14 14 14 14 14

400315495 INSIGNIA POLE 1 1/2IN 8
 1185504 100 EA IL IN MI OH WI
 14 14 14 14 14

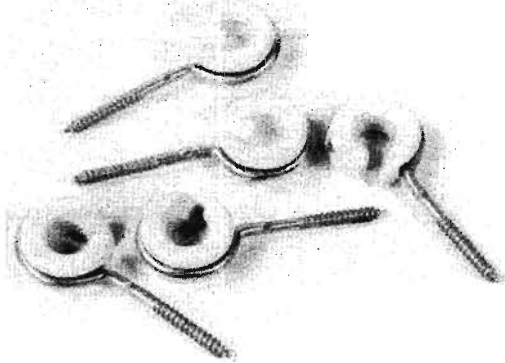

1240481

400151965 INSULATOR STRAIN 10 M
 3159228 1 EA IL IN MI OH WI
 08 08 08 08
 3 1/2IN LONG X 2 1/2in diameter, package of 50, BSP 621-405-201.

400151973 INSULATOR STRAIN 16 M
 N EA 50 3 200
 4 1/2in long x 3in diameter single fin.

400809042 INSULATOR TERMINAL CK16604 L2
 N PK 1 4 100
 Package of 100.

DISTRIBUTION SERVICES

NETWORK SERVICES

TOOLS

BUILDING JANITORIAL

AUTOMOTIVE

FORMS/OFFICE SUPPLIES

GENERAL

DATA VOICE

INTERFACE

PRODUCT IDENTIFIER		DESCRIPTION					
ITEM NUMBER	ORD. MULT.	SELL UNIT	STD. PKG. STOCK AVAILABILITY / PA	LEAD TIME	MIN. ORD.	A C	

INSULATOR POST BINDING

SEE CAP POST BINDING.

INSULATOR TERMINAL

SEE CAP TERMINAL

INTERFACE

260010780 INTERFACE BURIED POST & BRKT W/KIT
N EA 8 1 1200

260405873 INTERFACE FEEDER DIST SS-1200
1971580 1 EA IL IN MI OH WI
09 09 09
78-8072-7783-1.

260405865 INTERFACE FEEDER DIST SS-1800
1971598 1 EA IL IN MI OH WI
09 09 09
78-8072-7784-9.

INTERFACE NETWORK

260387444 INTERFACE NETWK DOOR HANGER DOCUMENT
1963926 1 EA

260339023 INTERFACE NETWK RETROFIT SNI2122R-AX7 S
1949032 1 EA IL IN MI OH WI
08 08
1 line retrofit w/half ringer & security screw.

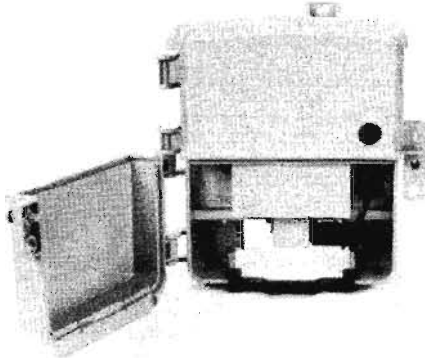

1949032

260358015 INTERFACE NETWK SNI 1212-2-2-12-23-3 BSL
1952960 1 EA IL IN MI OH WI
18 18 18
12 pair protected, outdoor, E/W half ringer.

260358023 INTERFACE NETWK SNI 1212-2-2-12-34-3 XSL
1952994 1 EA IL IN MI OH WI
08 08
12 line outdoor e/w terminal block & half ringer.

260442421 INTERFACE NETWK SNI 2525-2BX-1-25-30-X S
N EA 12 6 12
25PR Indoor W/O Protectors, 3FT Stub, no Half Ringer.

PRODUCT IDENTIFIER		DESCRIPTION					
ITEM NUMBER	ORD. MULT.	SELL UNIT	STD. PKG. STOCK AVAILABILITY / PA	LEAD TIME	MIN. ORD.	A C	

260357991 INTERFACE NETWK SNI1210-2-2-12-23 3 B S
1952952 2 EA IL IN MI OH WI
18
12 line, indoor, E/W half ringer.

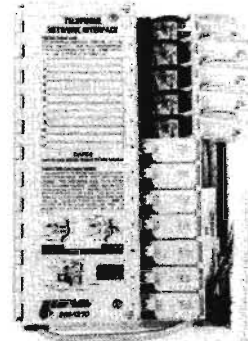

1952952

260358007 INTERFACE NETWK SNI1210-2-2-12-34 3 X S
1953000 1 EA IL IN MI OH WI
18
12 pair indoor e/w terminal block & half ringer.

260442371 INTERFACE NETWK SNI1212-2BX-1-12-23-3BSL
N EA 1 6 1
12PR Protected, Outdoor, no Half Ringer.

260442389 INTERFACE NETWK SNI1212-2BX-1-12-34-3XSL
N EA 1 6 1
12 Line Outdoor E/W Terminal Block, no Half Ringer.

260442413 INTERFACE NETWK SNI2510-2BX-1-25-25-BSL
N EA 1 6 1
25PR Outdoor W/ Protectors, 3FT Stub, no Half Ringer).

260442405 INTERFACE NETWK SNI2510-2BX-1-25-30-XSL
N EA 1 6 1
25PR Outdoor W/O Protectors, 3FT Stub, no Half Ringer).

260364971 INTERFACE NETWORK 2 LINE RETROFIT
1954842 1 EA IL IN MI OH WI
18
SNI 2122R-A-X7-S. E/W half ringer & security screw, outdoor.

260407804 INTERFACE NETWORK 4 POSITION GBB
1970988 1 EA IL IN MI OH WI
08 08 08 08
Ground Bus Bar, used when upgrading network interface (4600) with additional customer bridge.



1970988

300084365 INTERFACE NETWORK 630 NI
1207936 1 EA IL IN MI OH WI
18 18 18 18

DISTRIBUTION SERVICES

NETWORK SERVICES

TOOLS

BUILDING JANITORIAL

AUTOMOTIVE

FORMS/OFFICE SUPPLIES

GENERAL

DATA VOICE

PRODUCT IDENTIFIER DESCRIPTION

ITEM NUMBER	ORD. MULT.	SELL UNIT	STD. PKG. STOCK AVAILABILITY / PA	LEAD TIME	MIN. ORD.	A C
-------------	------------	-----------	-----------------------------------	-----------	-----------	-----

280047572 INTERFACE NETWORK 630 TD
 1926287 1 EA IL IN MI OH WI
 08 08 08 08

300084373 INTERFACE NETWORK 631 NI
 8413419 1 EA IL IN MI OH WI
 18 18 18

260302708 INTERFACE NETWORK 2125-1-1-1
 1939447 1 EA IL IN MI OH WI
 08 08 08 08
 No half ringer, indoor, 25 pair, w/cover.

260442397 INTERFACE NETWORK 2LN RETROFIT 2222R-A-
 N EA 30 4 30
 XX-B-XX-S (Outdoor, Security Screw, no Half Ringer).

260405808 INTERFACE NETWORK DEVICE 50M-600-MDP
 N EA 1 4 1
 For Homaco frame.

260405840 INTERFACE NETWORK DEVICE MDP50-2-23C
 N EA 1 4 1
 Homaco.

300033529 INTERFACE NETWORK E633A1-50
 1169722 1 EA IL IN MI OH WI
 18 18 18 18
 A combination SNI/EB intended for indoor use in finished dwellings for wall set applications. DISCONTINUE UPON STOCK DEPLETION

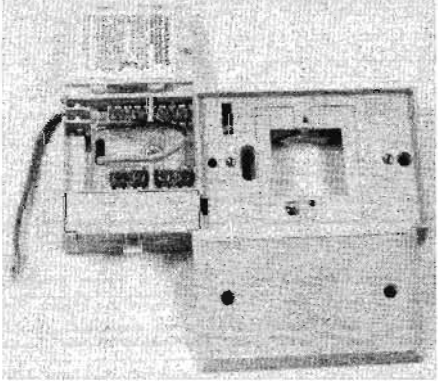

1169722

300033511 INTERFACE NETWORK E633B1-50
 5108076 1 EA IL IN MI OH WI
 18 18 18 18

260391008 INTERFACE NETWORK ELEC MOD/4600
 1965343 1 EA IL IN MI OH WI
 18
 Holder kit 90960, for use in 4600 NID for party line service.

260442439 INTERFACE NETWORK ML5-1-1-5
 N EA 28 2 28
 (Indoor 5 Line, 66 Block, no Half Ringer).

PRODUCT IDENTIFIER DESCRIPTION

ITEM NUMBER	ORD. MULT.	SELL UNIT	STD. PKG. STOCK AVAILABILITY / PA	LEAD TIME	MIN. ORD.	A C
-------------	------------	-----------	-----------------------------------	-----------	-----------	-----

260358106 INTERFACE NETWORK ML-5-1-2-5
 1952937 1 EA IL IN MI OH WI
 18 18
 Indoor, 5 line, 66 block, E/W half ringer.

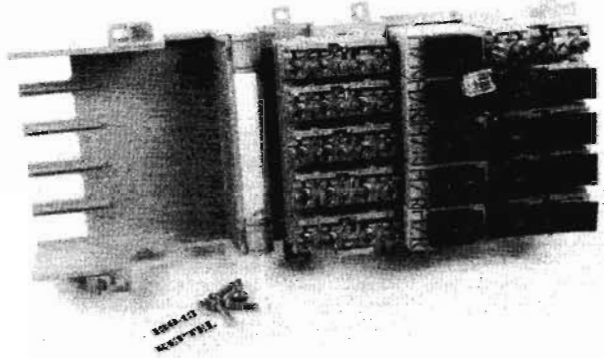

1952937

260302716 INTERFACE NETWORK ML-5-5-1-5
 1939454 1 EA IL IN MI OH WI
 08 08 08
 66 clips, 5-line, indoor.

260330741 INTERFACE NETWORK ML-5-5-3-1
 1947150 1 EA IL IN MI OH WI
 18
 66 clips, MTU, 1-line, indoor.

260339551 INTERFACE NETWORK RETROFIT
 1949065 1 EA IL IN MI OH WI
 18
 2 line with half ringer & security screw.

280054545 INTERFACE NETWORK SNI 1100-3A-57-H
 1929638 1 EA IL IN MI OH WI
 08 08
 E/W MTU & 356L-ASI Protector. Coin application.

260442363 INTERFACE NETWORK SNI 1210-2BX-1-12-23-3
 N EA 1 6 1
 -B-S (12 Line Indoor, no Half Ringer).

260442355 INTERFACE NETWORK SNI 1210-2BX-1-12-34-3
 N EA 1 6 1
 -X-S (12PR Indoor E/W Terminal Block, no Half Ringer).

260442454 INTERFACE NETWORK SNI 2122R-A-XX-S
 N EA 30 4 30
 1 line retrofit w/security screw, no half ringer).

260320395 INTERFACE NETWORK SNI 2125
 1942037 1 EA IL IN MI OH WI
 08 08 08
 E/W half ringer, indoor, 25 pair & cover.

INTERFACE NETWORK

PRODUCT IDENTIFIER		DESCRIPTION						
ITEM NUMBER	ORD. MULT.	SELL UNIT	STD. STOCK	PKG. AVAILABILITY / PA	LEAD TIME	MIN. ORD.	A C	

260358049 INTERFACE NETWORK SNI 2510-2-2-25-25 BSL
 1952911 1 EA IL IN MI OH WI
 18
 25 pair outdoor with protector, 3ft stub & half ringer.

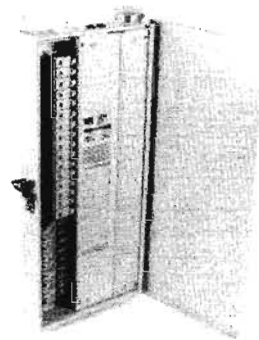

1952911

260358056 INTERFACE NETWORK SNI 2510-2-2-25-30 XSL
 1952895 1 EA IL IN MI OH WI
 18 18
 25 pair outdoor without protector, 3ft stub, E/W half ringer.

260358072 INTERFACE NETWORK SNI 2525-2-2-25-30 X S
 1952903 1 EA IL IN MI OH WI
 18
 25 pair indoor without protector, 3ft stub, E/W half ringer.

260444807 INTERFACE NETWORK SNI 4600
 N
 7/8IN diameter, entrance grommet for SNI 4600.

260377593 INTERFACE NETWORK SNI 4600XL-2BX-1-6-57-
 1959825 1 EA IL IN MI OH WI
 08 08 08 08 08
 S-AMER. E/W 6 subscriber locks and doors, 6 4-wire color coded customer bridges, 6 356L protectors and external hasp. Indoor/outdoor use.

260380688 INTERFACE NETWORK SNI 4600-1BX-1-1-57S-A
 1960955 1 EA IL IN MI OH WI
 08 08 08 08 08
 MER. E/W one 4-wire color coded customer bridge, one 356L protector and external hasp. Upgradeable to 6 lines, indoor/outdoor use.

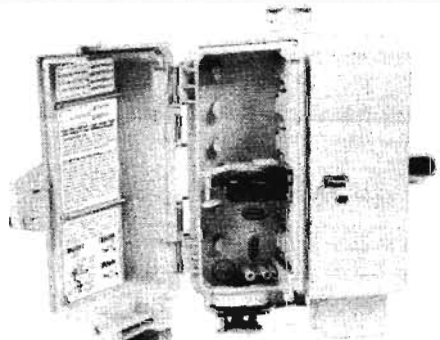

1960955

PRODUCT IDENTIFIER		DESCRIPTION						
ITEM NUMBER	ORD. MULT.	SELL UNIT	STD. STOCK	PKG. AVAILABILITY / PA	LEAD TIME	MIN. ORD.	A C	

260425582 INTERFACE NETWORK SNI 8925-1-1-1
 N EA 1 4 1
 25 Pair, indoor, screw termination with 89D mounting bracket.

260390919 INTERFACE NETWORK SNI 8925-1-1-2
 1965269 1 EA IL IN MI OH WI
 18 18 18 18
 25 pair, indoor, screw termination without 89D mounting bracket.

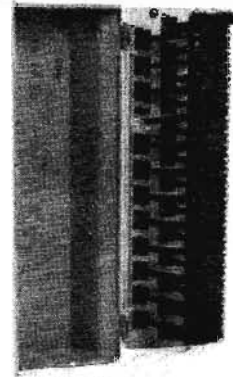

1965269

260425590 INTERFACE NETWORK SNI 8925-2-1-1
 N EA 1 4 1
 25 pair, indoor, 66-clip punch-down termination with 89D mounting bracket.

260394051 INTERFACE NETWORK SNI 8925-2-1-2
 1966739 1 EA IL IN MI OH WI
 08 08 08 08
 25 pair, indoor, 66 clip, punch-down termination without 89D mounting bracket.

260390984 INTERFACE NETWORK UPGRADE
 1965335 EA IL IN MI OH WI
 18 18 18
 AM4600-1D-1. For party line service.

260380696 INTERFACE NETWORK UPGRADE
 1960963 1 EA IL IN MI OH WI
 08 08 08 08
 AM4600-1BX-1. Complete customer upgrade kit. Includes RJ11 and one 4-wire color coded customer bridge.



1960963

DISTRIBUTION SERVICES

NETWORK SERVICES

TOOLS

BUILDING JANITORIAL

AUTOMOTIVE

FORMS/OFFICE SUPPLIES

GENERAL

DATA VOICE

PRODUCT IDENTIFIER		DESCRIPTION				
ITEM NUMBER	ORD. MULT.	SELL UNIT	STD. PKG.	LEAD TIME	MIN. ORD.	A C
			STOCK AVAILABILITY / PA			

IRON PULLING

400314563 IRON PULLING-IN NO.2 CA04552
 2781906 1 EA
 Used in manhole, concrete, walls as an anchor for pulling devices for underground cable, BSP 622-520-100.

JACK

280052259 JACK 631SJ
 1927459 1 EA
 Designed for use with the 631NI indoor network device when both SNI/EB and set location is required.

103551776 JACK 700A66 B1 25 NETWORK DEM
 1439505 1 EA
 IL IN MI OH WI
 18 18 18 18 18
 Network interface unit for FCC Registration, 3 vertical columns of terminals, 50 single/50 double quick connect terminals. No backboard. BSP 481-604-108.

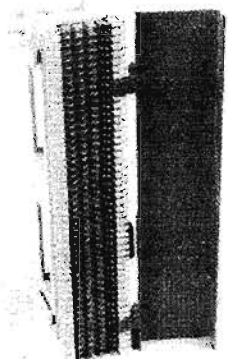

1439505

300029147 JACK 700A66 B1 25 REGISTERED
 5106294 1 EA
 IL IN MI OH WI
 18 18 18 18 18
 Gray cover.

PRODUCT IDENTIFIER		DESCRIPTION				
ITEM NUMBER	ORD. MULT.	SELL UNIT	STD. PKG.	LEAD TIME	MIN. ORD.	A C
			STOCK AVAILABILITY / PA			

103746970 JACK 700A66 B1 25B
 1158774 1 EA
 IL IN MI OH WI
 18 18 18 18 18
 Three vertical columns of terminals, 50 single and 50 double quick-connect terminals, includes 183C6 backboard. BSP 481-604-105.

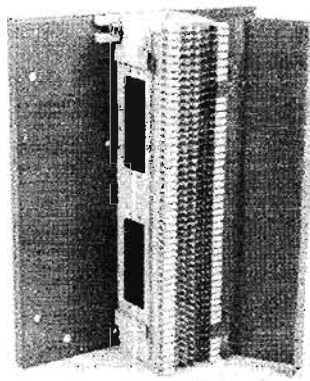

1158774

103551735 JACK 700AR B1 100
 1154575 1 EA
 IL IN MI OH WI
 18 18 18 18 18
 100 pair for network interface.

103551818 JACK 700B66 B1 12
 1203216 1 EA
 IL IN MI OH WI
 18 18 18 18 18
 Connecting block used for interpositioning up to twelve pairs of tip and ring conductors in series with PBX, key and other systems.

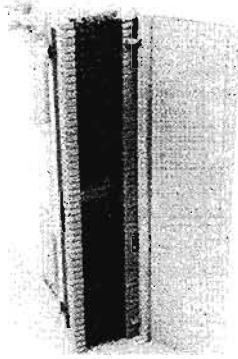

1203216

103562039 JACK 700C66 B1 4
 N EA 1 2 1
 Consists of a 4-pair jack intended for use as a network interface to connect tip/ring configurations to network.

JACKET FIRE RESISTANT

103757795 JACKET FIRE RESISTANT FR-CA	N	EA	1	1	1
103757803 JACKET FIRE RESISTANT FR-CB	N	EA	1	1	1
103757811 JACKET FIRE RESISTANT FR-CC	N	EA	1	10	1

DISTRIBUTION SERVICES

NETWORK SERVICES

TOOLS

BUILDING JANITORIAL

AUTOMOTIVE

FORMS/OFFICE SUPPLIES

GENERAL

DATA VOICE

JACKET FIRE RESISTANT

PRODUCT IDENTIFIER		DESCRIPTION						
ITEM NUMBER	ORD. MULT.	SELL UNIT	STD. PKG. STOCK AVAILABILITY / PA	LEAD TIME	MIN. ORD.	A	C	
103757829		JACKET FIRE RESISTANT FR-DA						
N		EA	1	1	1			
NOW AVAILABLE THROUGH TOUCH-TONE ORDER ENTRY.								
103757837		JACKET FIRE RESISTANT FR-DB						
N		EA	1	1	1			
NOW AVAILABLE THROUGH TOUCH-TONE ORDER ENTRY.								
103757845		JACKET FIRE RESISTANT FR-DC						
N		EA	1	10	1			
JUMPER								
260405659		JUMPER DFX XCONN 5.2METER						
1971655	1	EA						
260405667		JUMPER DFX XCONN 5.8METER						
1971648	1	EA	IL 09	IN	MI	OH	WI	
260428776		JUMPER FIBER ST BICONIC FS1E-A-06						
1979179	1	EA	IL 09	IN 09	MI	OH	WI 09	
280056854		JUMPER MULTIMODE 1 METER BCN						
N		EA	1	2	1			
3.2ft.								
300098282		JUMPER MULTIMODE 6 METER BCN						
N		EA	1	2	1			
19.7ft.								
300070091		JUMPER MULTIMODE 10FT 099999						
1921817	1	EA	IL 21	IN	MI	OH	WI 21	
280022013		JUMPER MULTIMODE 30FT 099999						
1921973	1	EA	IL 21	IN	MI	OH	WI 21	
280022054		JUMPER MULTIMODE 50FT 099999						
1922005	1	EA	IL 21	IN	MI	OH	WI 21	
300098274		JUMPER SINGLEMODE 6 METER BCN						
N		EA	1	2	1			
19.7ft.								
300070109		JUMPER SINGLEMODE 10FT 099999						
1921940	1	EA	IL 08	IN 08	MI 08	OH	WI 08	
Bicon 3M, 9.8FT.								
280022005		JUMPER SINGLEMODE 30FT 099999						
1921999	1	EA	IL 21	IN	MI	OH	WI 21	
Bicon 10M, 32.8FT.								
280022047		JUMPER SINGLEMODE 50FT 099999						
1922039	1	EA	IL 21	IN	MI	OH	WI 21	
Bicon 15M, 49.2FT.								

PRODUCT IDENTIFIER		DESCRIPTION						
ITEM NUMBER	ORD. MULT.	SELL UNIT	STD. PKG. STOCK AVAILABILITY / PA	LEAD TIME	MIN. ORD.	A	C	
105420913		JUMPER ST BICONIC FS1E-A- 4						
N		EA	1	2	1			
105420921		JUMPER ST BICONIC FS1E-A- 6						
N		EA	1	2	1			
105420939		JUMPER ST BICONIC FS1E-A- 8						
N		EA	1	2	1			
105420947		JUMPER ST BICONIC FS1E-A- 10						
N		EA	1	2	1			
105420954		JUMPER ST BICONIC FS1E-A- 15						
N		EA	1	2	1			
105420962		JUMPER ST BICONIC FS1E-A- 20						
N		EA	1	2	1			
105423958		JUMPER ST BICONIC FS1E-A- 25						
N		EA	1	6	1			
105423974		JUMPER ST BICONIC FS1E-A- 30						
N		EA	1	2	1			
105423982		JUMPER ST BICONIC FS1E-A- 35						
N		EA	1	2	1			
105424006		JUMPER ST BICONIC FS1E-A- 50						
N		EA	1	2	1			
105424014		JUMPER ST BICONIC FS1E-A- 75						
N		EA	1	6	1			
105424022		JUMPER ST BICONIC FS1E-A-100						
N		EA	1	6	1			

KIT							
842366940		KIT 700					
N		EA	1	9	1		
Kit of parts consisting of ground strap and 2 screws for 142 protector, outside plant. NOW AVAILABLE THROUGH TOUCH-TONE ORDER ENTRY.							
103808416		KIT 1032A TOOL					
N		EA	1	4	1		
Consists of tools and expendable supplies for field assembly of approx. 100 MM fiber optic connectors.							
104186150		KIT 1040A					
N		EA	1	4	1		
Designed for use with the #1033A, 1034A, and 1036A lightguide connectors. Provides bare essentials for mechanical splicing.							
260447719		KIT 12PR DROP BLOCK					
N							
For Reliable self-strip cabinets.							

DISTRIBUTION SERVICES

NETWORK SERVICES

TOOLS

BUILDING JANITORIAL

AUTOMOTIVE

FORMS/OFFICE SUPPLIES

GENERAL

DATA VOICE

DISTRIBUTION SERVICES

NETWORK SERVICES

TOOLS

BUILDING JANITORIAL

AUTOMOTIVE

FORMS/OFFICE SUPPLIES

GENERAL

DATA VOICE

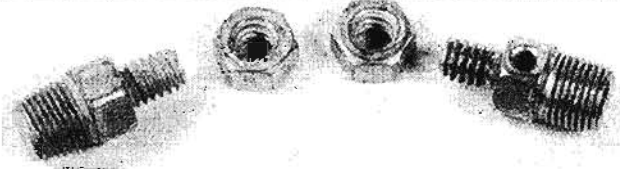
PRODUCT IDENTIFIER		DESCRIPTION				
ITEM NUMBER	ORD. MULT.	SELL UNIT	STD. PKG. STOCK AVAILABILITY / PA	LEAD TIME	MIN. ORD.	A C
300033842 KIT BCHN 10K						
5108639	1	EA	IL 08 IN 08 MI 08 OH 08 WI 08			
						
5108639						
104316658 KIT BC- 4/6 G&G BUILDING CABLE						
N		EA	1	2	1	
104316690 KIT BC- 6/3 G&G BUILDING CABLE						
N		EA	1	2	1	
104316716 KIT BC-12/1 G&G BUILDING CABLE						
N		EA	1	2	1	
104316708 KIT BC-12/2 G&G BUILDING CABLE						
N		EA	1	2	1	
300033776 KIT BG 10K						
5108514	1	EA	IL 08 IN 08 MI 08 OH 08 WI 08			
002077048 KIT BG 12K						
1141656	1	EA	IL 08 IN 08 MI 08 OH 08 WI 08			
401448352 KIT BONDING G1267-FB C-4012						
N		EA	6	4	6	
Used to effect an electrical & mechanical bond across cable shield openings, or used to make attachments from the cable shield to ground connect points. Electrical rating of #6 solid copper.						
300033834 KIT CBW 10K						
1222075	1	PK	IL 08 IN 08 MI 08 OH 08 WI 08			
Package of 25. Used for replacing lost or damaged inserts in channel bars.						
843820531 KIT CHIP 30ML						
N		EA	1	4	1	
402401301 KIT COMBINATION CK19790 L1						
N		EA	1	16	1	
280041237 KIT CONVERSION CAB 4200 E-EE						
N		EA	1	3	1	
78-8054-2339-5.						
260440862 KIT DECAL FDI - HUT						
N		EA	1	3	1	
402948400 KIT DECAL OB						
N		KT	1	6	10	
Package of 40.						
300033784 KIT DSW 10K						
5108522	1	EA	IL 08 IN 08 MI 08 OH 08 WI 08			

PRODUCT IDENTIFIER		DESCRIPTION				
ITEM NUMBER	ORD. MULT.	SELL UNIT	STD. PKG. STOCK AVAILABILITY / PA	LEAD TIME	MIN. ORD.	A C
300033792 KIT DSW 11K						
5108530	1	EA	IL 08 IN 08 MI 08 OH 08 WI 08			
300033800 KIT DSW 12K						
5108555	1	EA	IL 08 IN 08 MI 08 OH 08 WI 08			
260369012 KIT ENCAPSULANT REENTRY 2200UG 6/20						
1955559	1	EA	IL 08 IN 08 MI 08 OH 08 WI 08			
300033859 KIT EP 10K						
5108613	1	EA	IL 08 IN 08 MI 08 OH 08 WI 08			
103895579 KIT EXTENDER F82BA0014-40						
N		EA	1	8	200	
280029950 KIT EXTENDER TERMAX						
1922948	1	EA	IL 08 IN MI OH WI			
280010158 KIT EXTENSION 6 CAD						
N		EA	1	6	1	
280038399 KIT EXTENSION 8 CAD						
N		EA	1	6	1	
300032091 KIT FIELD GRADE 2 LN 60-065-10						
5107755	1	EA	IL 08 IN MI OH WI			
280057035 KIT FILLED SERVICE WIRE CLEANING						
N		KT	1	2	1	
4415.						
260346903 KIT FIRE BARRIER VAULT 5925						
N		KT	1	2	1	
98-0400-0255-6.						
280015553 KIT FLAG POLE TRANSPORTER						
N		EA	1	2	1	
FC1150HD.						
260324686 KIT FLEXPOR PLUGGING 4298 3/KIT						
1948042	1	KT	IL 08 IN 08 MI 08 OH 08 WI 08			
For 3M cross connect cabinet installations.						
280060351 KIT F/G CONVERSION 4200						
N		EA	1	2	1	
78-8054-2338-7.						
001149137 KIT G6031						
N		EA	12	4	12	
Single sheath pulp or paper damming kit, BSP 637-242-901.						
001149129 KIT G6033						
1149567	1	EA	IL 08 IN MI OH WI			
Universal kit containing all materials required for a combination pressure plug/insulating joint in any single sheath plug or paper insulated cable, BSP 633-320-802.						

KIT

PRODUCT IDENTIFIER		DESCRIPTION					
ITEM NUMBER	ORD. MULT.	SELL UNIT	STD. PKG. STOCK AVAILABILITY / PA	LEAD TIME	MIN. ORD.	A	C
001202282 KIT GB 10567 B							
N		EA	1	6		1	
260438254 KIT HANDLE F-016916 CROSS-CONNECT							
N		EA	1	4		1	
Climbing assist handle kit for aerial cross-connect cabinets.							
260440854 KIT HARDWARE FDI							
N		EA	1	3		1	
260446349 KIT HARDWARE FDI FOR 80A CABINET ASSMBLY							
N							
260380068 KIT INTERWRAP 2200UG							
1960658	1	EA	IL IN MI OH WI	18 18			
401340872 KIT KORPLUG G117							
2793265	1	BX	IL IN MI OH WI	08 08 08			
Contains necessary fittings for making direct sheath injection pressure plugs, BSP 637-242-901N. Box of 12.							
260339825 KIT LABEL P49940 1501-2700							
1949644	1	KT	IL IN MI OH WI	08 08 08			
Remembering kit for reliable cross box.							
300014156 KIT LATCH 4032							
N		EA	1	2		1	
NOW AVAILABLE THROUGH TOUCH-TONE ORDER ENTRY.							
300086139 KIT LEAD TEST 1683							
N		EA	1	2		1	
To be used with 135 meter.							
105113708 KIT LIGHTGUIDE F86-AK 8504							
N		EA	1	2		1	
000246769 KIT LINE ASSIGNMENT							
N		EA	1	2		24	
260368154 KIT LOCK P62759							
1971085	1	EA	IL IN MI OH WI	31			
For building entrance frame, BSP 916-559-950AM.							
260302237 KIT MANIFOLD 5 PORT 561408-4							
N		EA	1	1		1	
001171065 KIT MOSPN DROP WIRE SPLICE							
1112516	1	EA	IL IN MI OH WI	18 18			
401203708 KIT MULTIMOLD 8962							
2770826	1	EA	IL IN MI OH WI	08 08 08 08			
For use with B encapsulant to form moisture barrier at pedestal terminals in buried cable distribution systems, BSP 631-600-305.							

PRODUCT IDENTIFIER		DESCRIPTION					
ITEM NUMBER	ORD. MULT.	SELL UNIT	STD. PKG. STOCK AVAILABILITY / PA	LEAD TIME	MIN. ORD.	A	C
300052453 KIT P400Y CABLE IDENTIFICATION							
6509448	1	KT	IL IN MI OH WI	08 08 08 08			
300072196 KIT PEDESTAL BLOCKING 8964							
N		EA	1	3		1	
260328547 KIT PEDESTAL MOIST/PRESSURE PLUG							
N		CS	1	3		1	
Case of 12.							
300052461 KIT PIPE PLUG BONDING 8000-714							
6509455	1	EA	IL IN MI OH WI	08			
260320411 KIT PLUGGING 7IN S-69-SV							
1942177	1	CS	IL IN MI OH WI	08 08 08			
Case of 12.							
260320783 KIT PLUGGING 12IN S-72-SV							
1945485	1	CS	IL IN MI OH WI	08 08 08			
Case of 12.							
280080664 KIT PRESSURE VALVE PVK							
N		EA	12	4		60	
103199519 KIT PULLOUT 105A 9							
N		EA	1	1		1	
Provides method of bonding and enclosing exposed core caused by excessive cable sheath pullout in the 105 cable terminal.							
260324629 KIT PULLOUT 105A 12HBE							
1944850	1	EA	IL IN MI OH WI	08 08 08			
103235842 KIT PULLOUT 105A 15							
N		EA	1	1		1	
401257100 KIT PULLOUT A49A-C4089							
N		EA	1	8		1	
300014552 KIT PUP 4477							
5123455	1	KT	IL IN MI OH WI	08			
300014560 KIT PUP 4477R REPLENISHNG							
5123448	1	KT	IL IN MI OH WI	08 08 08 08			
A replenishment kit that permits use of kit components that are removed after plug during other pressure block applications.							
403065667 KIT REPAIR DOOR MC 10/48							
N		EA	25	8		25	
280043175 KIT RETROFIT 2 LN							
1924910	1	EA	IL IN MI OH WI	18			
280060369 KIT RETROFIT 4035							
N		EA	1	2		1	
78-8026-7867-8.							

DISTRIBUTION SERVICES
 NETWORK SERVICES
 TOOLS
 BUILDING JANITORIAL
 AUTOMOTIVE
 FORMS/OFFICE SUPPLIES
 GENERAL
 DATA VOICE

DISTRIBUTION SERVICES

NETWORK SERVICES

TOOLS

BUILDING JANITORIAL

AUTOMOTIVE

FORMS/OFFICE SUPPLIES

GENERAL

DATA VOICE

PRODUCT IDENTIFIER		DESCRIPTION					
ITEM NUMBER	ORD. MULT.	SELL UNIT	STD. PKG. STOCK AVAILABILITY / PA	LEAD TIME	MIN. ORD.	A C	
280041286	N	EA	1	4	20		
KIT RE-ENTRY BKZ-10							
280041278	N	EA	1	4	1		
KIT RE-ENTRY RKZ-10							
300033818	N	EA	1	4	30		
KIT RE-ENTRY TSK-10							
260432943	N	KT	1	3	1		
KIT SPLICE 2525K FIBER OPTIC 250 X 250. NOW AVAILABLE THROUGH TOUCH-TONE ORDER ENTRY.							
260432950	N	KT	1	3	1		
KIT SPLICE 2590K FIBER OPTIC 250 X 900.							
260432968	N	KT	1	3	1		
KIT SPLICE 2599K FIBER OPTIC 900 X 900.							
280046335	1931147	1 EA	IL 08	IN 08	MI 08	OH 08	WI 08
KIT SPLICE ENCAPSULANT TBT 60 Use with Kold-N-Klose buried cable.							
104318567	N	EA	1	4	1		
KIT SPLICE ROTARY ASSEMBLY F85AK8523							
845626449	N	EA	1	4	1		
KIT SPLICED ENHANCED							
402764054	N	EA	3	4	3		
KIT SPLICERS C-4437							
300096161	1930578	1 KT	IL 08	IN 08	MI 08	OH 08	WI 08
KIT SPLIT GLAND 4097							
280079096	1937219	1 EA	IL 08	IN 08	MI 08	OH 08	WI 08
KIT STRAIN RELIEF TBT 69							

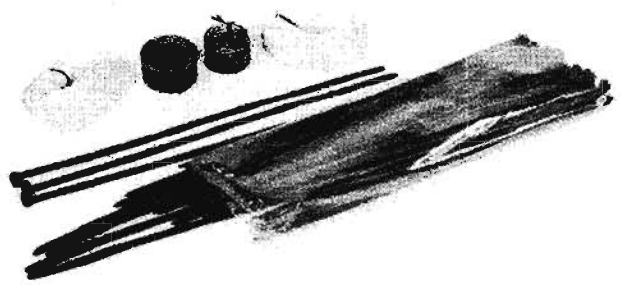

1937219

260319868	1941690	1 EA	IL 18	IN 18	MI 18	OH 18	WI 18
KIT UPGRADE AL4-1 Consists of a subscriber terminal block and interface module used to add lines to the ML5 Interface Device.							

PRODUCT IDENTIFIER		DESCRIPTION					
ITEM NUMBER	ORD. MULT.	SELL UNIT	STD. PKG. STOCK AVAILABILITY / PA	LEAD TIME	MIN. ORD.	A C	
260330915	1947143	1 EA	IL 18	IN 18	MI 18	OH 18	WI 18
KIT UPGRADE AL4-3 Kit contains a jack equipped with Maintenance Terminating Unit and Bridge to expand the ML-5 Network Interface. For use on COPTS service lines only.							
260353438	1952085	1 EA	IL 18	IN 18	MI 18	OH 18	WI 18
KIT UPGRADE SNI2100 H356 IBT 2nd line upgrade kit for SNI 2100, including bridge, plug, jack, stainless steel screws.							
260321526	N	EA	1	3	1		
KIT WEATHERSTRIPPING FOR 3M 4000/4300 Series Cabinets 78-8012-9574-8. NOW AVAILABLE THROUGH TOUCH-TONE ORDER ENTRY.							
280007188	N	EA	1	2	1		
KIT WIRE SUPPORT REPLACEMENT Amp 229188-1, for use with VS-3 hand tool.							
280041138	1924605	1 EA	IL 08	IN 08	MI 08	OH 08	WI 08
KIT XAGA PT							
KIT AUTOFIT							
SEE SLEEVE REPAIR AUTOFIT.							
KIT CABLE CLEANER							
SEE SOLVENT.							
KIT ENCAPSULANT							
104174818	N	EA	25	1	25		
KIT ENCAPSULANT 1000A 500 GRAM							
104174826	N	EA	25	5	25		
KIT ENCAPSULANT 1000B 750 GRAM							
104174842	N	EA	1	5	1		
KIT ENCAPSULANT 1000D 5000 GRAM							
104178611	N	EA	1	5	1		
KIT ENCAPSULANT 1000E 8000 GRAM							
104373311	N	EA	6	5	6		
KIT ENCAPSULANT 1000F 1500 GRAM							
104373329	N	EA	6	5	6		
KIT ENCAPSULANT 1000G 3000 GRAM NOW AVAILABLE THROUGH TOUCH-TONE ORDER ENTRY.							

DISTRIBUTION SERVICES

KIT OF PARTS

PRODUCT IDENTIFIER		DESCRIPTION				
ITEM NUMBER	ORD. MULT.	SELL UNIT	STD. PKG. STOCK AVAILABILITY / PA	LEAD TIME	MIN. ORD.	A C

KIT MODULE

SEE CONNECTOR MODULE.

NETWORK SERVICES

KIT OF PARTS

100891803 KIT OF PARTS D179997

N		EA	1	13	1	
---	--	----	---	----	---	--

101137933 KIT OF PARTS D180229

N		EA	1	13	1	
---	--	----	---	----	---	--

102095213 KIT OF PARTS D180380

2750828	1	EA	IL	IN	MI	OH	WI
			58	58	58	58	58

Used to indicate ringing signals. The kit consists of a 1F Lens, a red neon glow lamp and an adapter, BSP 463-210-100.

101769511 KIT OF PARTS D180382

N		EA	1	2	1	
---	--	----	---	---	---	--

To add lock to 526 type telephone set. For extra keys order CC 840164545, BSP 502-501-117.

102189289 KIT OF PARTS D180466

N		EA	1	13	1	
---	--	----	---	----	---	--

Transmitter receiver unit for 1 type head telephone sets, BSP 028-363-801.

102312600 KIT OF PARTS D180487

N		EA	30	2	30	
---	--	----	----	---	----	--

102362860 KIT OF PARTS D180489

N		EA	1	6	1	
---	--	----	---	---	---	--

102343779 KIT OF PARTS D180494

N		EA	1	2	1	
---	--	----	---	---	---	--

102366259 KIT OF PARTS D180510

N		EA	12	2	12	
---	--	----	----	---	----	--

102798188 KIT OF PARTS D180673

N		EA	25	7	25	
---	--	----	----	---	----	--

102798642 KIT OF PARTS D180702

N		EA	1	13	1	
---	--	----	---	----	---	--

102904778 KIT OF PARTS D180758

N		EA	12	6	12	
---	--	----	----	---	----	--

Parts necessary to provide personal line at primary, BSP 518-450-106.

102899614 KIT OF PARTS D180773

N		EA	1	9	1	
---	--	----	---	---	---	--

102990595 KIT OF PARTS D180829

N		EA	1	9	1	
---	--	----	---	---	---	--

Spare part & tool.

103067609 KIT OF PARTS D180838

N		EA	1	2	1	
---	--	----	---	---	---	--

TOOLS

BUILDING JANITORIAL

AUTOMOTIVE

FORMS/OFFICE SUPPLIES

GENERAL

DATA VOICE

PRODUCT IDENTIFIER		DESCRIPTION				
ITEM NUMBER	ORD. MULT.	SELL UNIT	STD. PKG. STOCK AVAILABILITY / PA	LEAD TIME	MIN. ORD.	A C

102998077 KIT OF PARTS D180841

N		EA	1	14	1	
---	--	----	---	----	---	--

Spare part & tool.

103162731 KIT OF PARTS D180995

N		EA	1	1	1	
---	--	----	---	---	---	--

103381554 KIT OF PARTS D181127

N		EA	1	9	1	
---	--	----	---	---	---	--

103707196 KIT OF PARTS D181146

N		EA	1	9	1	
---	--	----	---	---	---	--

103710331 KIT OF PARTS D181147

N		EA	1	9	1	
---	--	----	---	---	---	--

103710349 KIT OF PARTS D181148

N		EA	1	9	1	
---	--	----	---	---	---	--

103891552 KIT OF PARTS D181246

N		EA	1	2	1	
---	--	----	---	---	---	--

Replacement items used with the 1031A1 Tool Kit to field assemble 100ea 1006 Connectors. Quantity required - one per (100) 1006 Connectors.

103910089 KIT OF PARTS D181259

N		EA	1	2	1	
---	--	----	---	---	---	--

Tools used in conjunction with the 1031A1 Tool Kit to field assemble 1005B Connectors. Quantity required - one per kit to be converted.

103910329 KIT OF PARTS D181265

N		EA	1	2	1	
---	--	----	---	---	---	--

Replacement items used with the 1031A Tool Kit and Kit of Parts D181259 to field assemble 1005B Connectors. Quantity required - One Kit per (100) 1005B Connectors.

103914438 KIT OF PARTS D181270

N		EA	1	2	1	
---	--	----	---	---	---	--

PVC tube inserts used in field assembling 2016 (Standard and Keyed), 1006A, and 1005B Biconic Connectors. This Kit is not required when field mounting connectors on interconnect jumper cable. 100 ea.

104225198 KIT OF PARTS D181348

N		EA	1	2	1	
---	--	----	---	---	---	--

Unit Splitter. Pitchfork-shaped apparatus to organize and reroute fibers to different organizer trays inside of closure, 20ea.

104277090 KIT OF PARTS D181398 CONN INSERTS

N		EA	1	2	1	
---	--	----	---	---	---	--

105046536 KIT OF PARTS D181516

N		EA	1	2	1	
---	--	----	---	---	---	--

Replacement items used with the 1031A Tool Kit to field assemble 2016 Connectors. 100ea. Quantity required - one per (100) 2016 Connectors. NOW AVAILABLE THROUGH TOUCH-TONE ORDER ENTRY.

105052047 KIT OF PARTS D181517 BUFFER TUBE

N		EA	1	2	1	
---	--	----	---	---	---	--

PRODUCT IDENTIFIER							DESCRIPTION						
ITEM	ORD.	SELL	STD. PKG.	LEAD TIME	MIN.	A	ITEM	ORD.	SELL	STD. PKG.	LEAD TIME	MIN.	A
NUMBER	MULT.	UNIT	STOCK AVAILABILITY / PA		ORD.	C	NUMBER	MULT.	UNIT	STOCK AVAILABILITY / PA		ORD.	C
105150718 KIT OF PARTS D181556													
N		EA	1	2	1		Bonding Lug Kit for use on cable .41 inches in diameter, instruction sheet included.						
105150700 KIT OF PARTS D181557													
N		EA	1	2	1		Bonding Lug Kit for use on cable .48 inches in diameter, instruction sheet included.						
105205652 KIT OF PARTS D181597													
N		EA	1	2	1		Polishing Paper. Kit contains 100 .3 Micron Polishing Papers and 100 8 Micron Polishing Papers. Quantity required - one per six Kit of Parts d181699.						
105205660 KIT OF PARTS D181598													
N		EA	1	2	1		UV Curing Adhesive (5 Packs). Quantity required - one per 3-Kit of Parts D181699.						
105205678 KIT OF PARTS D181599													
N		EA	1	2	1		Wipes (250ea). Quantity required - one per 10-Kit of Parts D181699.						
105205686 KIT OF PARTS D181600													
N		EA	1	2	1		Alignment Sleeve B (60ea)						
105205702 KIT OF PARTS D181602													
N		EA	1	2	1		Alignment Sleeve A (60ea)						
105205710 KIT OF PARTS D181603													
N		EA	1	2	1		Alignment Sleeve D (60ea)						
105205728 KIT OF PARTS D181604													
N		EA	1	2	1		This kit is used in conjunction with Kit of Parts D181617 and contains Alignment Sleeve A (6ea) and Alignment Sleeve D (12ea). Quantity required - one per ten-Kit of Parts D181617.						
105226252 KIT OF PARTS D181617													
N		EA	1	2	1		Contains all consumables necessary to assemble 12 rotary mechanical splices. Does not include alcohol and index matching gel. Quantity required - one kit per 12 fiber splices.						
105246185 KIT OF PARTS D181618													
N		EA	1	2	1		One 400B Polishing Tool and instruction sheet. Required for field termination of all plastic tip ST Connectors, also used for all ceramic tip ST Connectors.						
105276810 KIT OF PARTS D181699													
N		EA	1	2	1		Contents - Rotary Ferrules (60ea), Red Protector Tips (25ea), Clear Strain Reliefs (PVC tubes)(125ea) and Razor Blade (1ea). Quantity required - one per 60 splices.						

PRODUCT IDENTIFIER							DESCRIPTION						
ITEM	ORD.	SELL	STD. PKG.	LEAD TIME	MIN.	A	ITEM	ORD.	SELL	STD. PKG.	LEAD TIME	MIN.	A
NUMBER	MULT.	UNIT	STOCK AVAILABILITY / PA		ORD.	C	NUMBER	MULT.	UNIT	STOCK AVAILABILITY / PA		ORD.	C
260344585 KIT OF PARTS D181775													
1950519	1	EA	IL	IN	MI	OH	WI	Re-entry kit for Closure 2200UG 8/20 (1950386).					
260344593 KIT OF PARTS D181776													
1950527	1	EA	IL	IN	MI	OH	WI	Re-entry kit for Closure 2200UG 10/20 (1950394).					
260415393 KIT OF PARTS D182037													
1972638	1	EA	IL	IN	MI	OH	WI	Contains all supplies to field mount 100 single mode ST Connectors on jumper cordage, LGBC Cable or direct termination on outside plant cable fibers. Alcohol, compressed air & connectors not included.					
KNOB PORCELAIN													
400153623 KNOB PORCELAIN C PLAIN CA04323													
1196444	25	EA	For use as an intermediate or last attachment of drop wires when porcelain insulated building attachments are required. Accommodates 2 drop wires, BSP 080-720-143.										
400153649 KNOB PORCELAIN S PLAIN CA04308													
1196469	10	EA	IL	IN	MI	OH	WI	First attachment for drop wires when porcelain insulated building attachments are required. Accommodates 1 drop wire, BSP 080-720-132.					
400153664 KNOB PORCELAIN T PLAIN CA04308													
1137091	1	EA	IL	IN	MI	OH	WI	First attachment for drop wires when porcelain insulated building attachments are required. Accommodates 2 drop wires, BSP 080-720-132.					
LABEL													
104436084 LABEL 11A PG00													
N		PK	1	6	1		Package of 12.						
300014024 LABEL CABLE PWC													
6500769	1	PK	IL	IN	MI	OH	WI	Package of 30.					
260447685 LABEL IN-COUNT 1-2100													
N		For Reliable self-strip blocks (green).											
260447677 LABEL IN-COUNT 2101-4200													
N		For Reliable self-strip blocks (green).											
260339098 LABEL KIT BLUE 1-2700 CQF													
N		EA	1	4	1								

DISTRIBUTION SERVICES

NETWORK SERVICES

TOOLS

BUILDING JANITORIAL

AUTOMOTIVE

FORMS/OFFICE SUPPLIES

GENERAL

DATA VOICE

DISTRIBUTION SERVICES

LABEL

PRODUCT IDENTIFIER		DESCRIPTION					
ITEM NUMBER	ORD. MULT.	SELL UNIT	STD. PKG. STOCK AVAILABILITY / PA	LEAD TIME	MIN. ORD.	A C	
260339106		LABEL KIT	BLUE	2800-5400	CQF		
N		EA	1	4	1		
260338819		LABEL KIT	GREEN	1-1500	CQF		
N		EA	1	4	1		

NETWORK SERVICES

260323555 LABEL MODULAR HARDWIRE TAGGING
 1973800 1 SE IL IN MI OH WI
 08 08
 1801-3600 BP labels for 3M X boxes, blue and green, 4379, 78-8020-7955-4.

260323548 LABEL MODULAR HARDWIRE TAGGING 1-1800
 1973818 1 SE IL IN MI OH WI
 08 08
 BP labels for 3M X boxes, blue and green, 4379, 78-8012-9865-0.

TOOLS

260447701 LABEL OUT-COUNT 1-3600
 N
 For Reliable self-strip blocks (blue).

260339817 LABEL P44195 KIT 1-1500
 1949636 1 KT IL IN MI OH WI
 08 08 08
 Remembering kit for reliable cross box.

BUILDING JANITORIAL

260355755 LABEL P60248 GREEN PROT
 N EA 1 6 1
 R305 Block.

260355763 LABEL P60249 BLUE RJ21
 N EA 1 6 1

AUTOMOTIVE

260355771 LABEL P60250 GREEN 66 BLOCK-IN
 1954735 1 EA IL IN MI OH WI
 33
 For BEFX200MM and BEFPX1220MM.

FORMS/OFFICE SUPPLIES

2801	2851	2855	2875	2901	2961	2975	2975	2975	3001
2825	2875	2850	2900	2925	2975	2950	2975	2950	3001
3001	3051	3025	3075	3101	3151	3125	3175	3150	3200
3075	3075	3050	3100	3125	3175	3150	3200	3175	3225
3201	3251	3225	3275	3301	3351	3325	3375	3350	3400
3275	3275	3250	3300	3325	3375	3350	3400	3375	3425
3401	3451	3425	3475	3501	3551	3525	3575	3550	3600
3475	3475	3450	3500	3525	3575	3550	3600	3575	3625
3601	3651	3625	3675	3701	3751	3725	3775	3750	3800
3675	3675	3650	3700	3725	3775	3750	3800	3775	3825
3801	3851	3825	3875	3901	3951	3925	3975	3950	4000
3875	3875	3850	3900	3925	3975	3950	4000	3975	4025
4001	4051	4025	4075	4101	4151	4125	4175	4150	4200
4075	4075	4050	4100	4125	4175	4150	4200	4175	4225
4201	4251	4225	4275	4301	4351	4325	4375	4350	4400
4275	4275	4250	4300	4325	4375	4350	4400	4375	4425
4401	4451	4425	4475	4501	4551	4525	4575	4550	4600
4475	4475	4450	4500	4525	4575	4550	4600	4575	4625
4601	4651	4625	4675	4701	4751	4725	4775	4750	4800
4675	4675	4650	4700	4725	4775	4750	4800	4775	4825
4801	4851	4825	4875	4901	4951	4925	4975	4950	5000
4875	4875	4850	4900	4925	4975	4950	5000	4975	5025
5001	5051	5025	5075	5101	5151	5125	5175	5150	5200
5075	5075	5050	5100	5125	5175	5150	5200	5175	5225
5201	5251	5225	5275	5301	5351	5325	5375	5350	5400
5275	5275	5250	5300	5325	5375	5350	5400	5375	5425

1954735

260355789 LABEL P60251 BLUE 66 BLOCK-OUT
 1954727 1 EA IL IN MI OH WI
 33
 For BEFPX200MM, BEFC800MM, BEFCX800MM and BEFPX1220MM.

GENERAL

DATA VOICE

PRODUCT IDENTIFIER		DESCRIPTION					
ITEM NUMBER	ORD. MULT.	SELL UNIT	STD. PKG. STOCK AVAILABILITY / PA	LEAD TIME	MIN. ORD.	A C	
260355797		LABEL P60252	BLUE NID				
N		EA	1	6	1		
260441688		LABEL WHITE 66	BLOCK IN/OUT				
N		EA	1	6	1		
FOR BEFP200MVH P60523.							

LADDER MANHOLE

400154357 LADDER MANHOLE 6 1/2FT W/HOOKS
 N EA 1 2 1
 CA06758. NOW AVAILABLE THROUGH TOUCH-TONE ORDER ENTRY.

400154290 LADDER MANHOLE 8FT CA06758
 1196865 1 EA IL IN MI OH WI
 35 35 35 35 35
 A straight end ladder used in manholes as permanent installation, BSP 622-520-100.

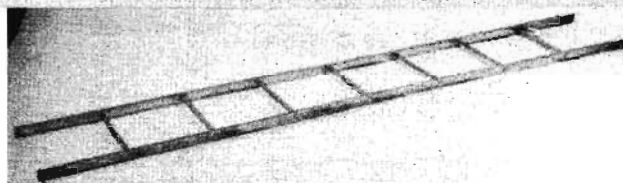

1196865

400154365 LADDER MANHOLE 8FT W/HOOKS CA06758
 N EA 1 2 1
 A straight 8FT manhole ladder e/w hooks for temporary use.

280014580 LADDER MANHOLE 9FT HOOK OVER
 N EA 1 2 1
 8382200.

400154308 LADDER MANHOLE 10FT CA06758
 1196881 1 EA IL IN MI OH WI
 35 35 35 35 35

400154373 LADDER MANHOLE 10FT W/HOOKS CA06758
 3321000 1 EA IL IN MI OH WI
 35 35 35 35 35

400154316 LADDER MANHOLE 12FT CA06758
 N EA 1 8 1

400154381 LADDER MANHOLE 12FT W/HOOKS CA06758
 3330423 1 EA IL IN MI OH WI
 35 35 35 35 35

400154324 LADDER MANHOLE 14FT CA06758
 N EA 1 2 1

400154399 LADDER MANHOLE 14FT W/HOOKS CA06758
 N EA 1 8 1

400154340 LADDER MANHOLE 18FT CA06758
 N EA 1 8 1

400154415 LADDER MANHOLE 18FT W/HOOKS CA06758
 N EA 1 8 1

DISTRIBUTION SERVICES

PRODUCT IDENTIFIER		DESCRIPTION				
ITEM NUMBER	ORD. MULT.	SELL UNIT	STD. PKG. STOCK AVAILABILITY / PA	LEAD TIME	MIN. ORD.	A C

PRODUCT IDENTIFIER		DESCRIPTION				
ITEM NUMBER	ORD. MULT.	SELL UNIT	STD. PKG. STOCK AVAILABILITY / PA	LEAD TIME	MIN. ORD.	A C

NETWORK SERVICES

LADDER SPLICE

LEAD SLEEVE

300050382 LADDER SPLICE SUPPORT 8

SEE SLEEVE LEAD.

1116871 1 EA

300050390 LADDER SPLICE SUPPORT 12

5115733 1 EA IL IN MI OH WI
08 08 08 08 08

LEADERGARD

401152277 LEADERGARD CABLE PROTECT LG 345

2755926 1 EA

A flanged split nylon tube that is 6in long and designed to be placed on the cable sheath and inserted into the duct, BSP 628-200-208.

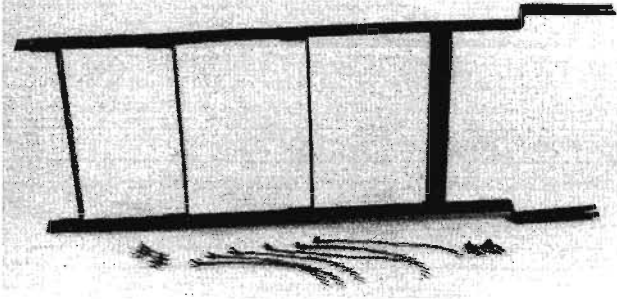

5115733

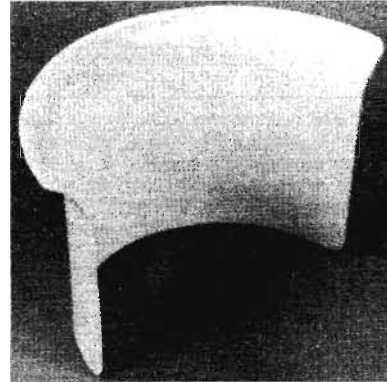

401152277

TOOLS

LATCH HOOK

842397580 LATCH HOOK 19A

N EA 1 15 1

Designed for use on 12 inch high printed wiring boards in the 150-type app. mountings.

BUILDING JANITORIAL

LEAD BAR

SEE BAR LEAD.

LID

300096179 LID ONLY TP6-2-6

N EA 1 4 36

For Closure Buried Wire B T6-2-6 (3363960).

AUTOMOTIVE

LEAD GROUND

401328372 LEAD GROUND NO.6 13IN HP6

7361980 1 EA

Used in grounding cap closures. Ctn/50.

FORMS/OFFICE SUPPLIES

LIFTER BRIDGE

260342498 LIFTER BRIDGE MDF BLOCK

1949933 1 EA

MDF assembly w/Porta 88 blocks wired for single-party, strapped for 2-party service.

LIGHT POLE

280002262 LIGHT POLE RM102PL

N EA 1 5 1

GENERAL

LINK REIN

400155784 LINK REIN L CA03943

N EA 50 8 50

400155792 LINK REIN S CA03943

N EA 50 8 50

DATA VOICE

DISTRIBUTION SERVICES

NETWORK SERVICES

TOOLS

BUILDING JANITORIAL

AUTOMOTIVE

FORMS/OFFICE SUPPLIES

GENERAL

DATA VOICE

LOG BINDING POST

PRODUCT IDENTIFIER		DESCRIPTION				
ITEM NUMBER	ORD. MULT.	SELL UNIT	STD. PKG. STOCK AVAILABILITY / PA	LEAD TIME	MIN. ORD.	A C

LOG BINDING POST

260321583 LOG BINDING POST 34-7015-4649-0						
N		EA	1	3	1	
4200E-EC-EE-F-G-GC, spare part for 3M 4200 series cabinet.						
260321518 LOG BINDING POST 34-7021-0475-2						
N		EA	1	3	1	
40/43, 84/86/95.						

LOOP WIRE

400491650 LOOP WIRE C 1/2IN CA07887						
1101857	1	PK				
Used together with band C masonry fasteners as an intermediate support of station wires and inside wiring cable attached to masonry surfaces, BSP 080-720-141.						

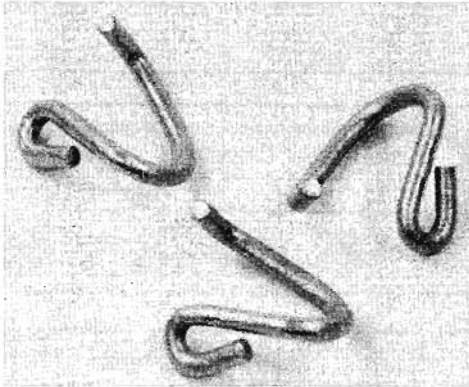

400491650

400491643 LOOP WIRE C 5/8IN CA07887							
1101865	1	PK	IL	IN	MI	OH	WI
			18	18	18	18	18

400491635 LOOP WIRE C 7/8IN CA07887							
1101873	1	PK	IL	IN	MI	OH	WI
			18	18	18	18	18

400491619 LOOP WIRE C 1 1/4IN CA07887							
6313320	1	PK	IL	IN	MI	OH	WI
			18				

LUBRICANT

300009628 LUBRICANT CABLE 16OZ BOTTLE SG							
1178137	1	CS					
Hydra-lube Blue, used for pulling cable. DISCONTINUE, ORDER NON STOCK UPON STOCK DEPLETION							

900617820 LUBRICANT CABLE 1 QUART BOTTLE							
3435305	1	BT	IL	IN	MI	OH	WI
			08	08	08	08	08
Polywater G35, squeeze bottle. Used as lubricant to pull cable in various applications.							

PRODUCT IDENTIFIER		DESCRIPTION				
ITEM NUMBER	ORD. MULT.	SELL UNIT	STD. PKG. STOCK AVAILABILITY / PA	LEAD TIME	MIN. ORD.	A C

300036951 LUBRICANT CABLE 1/2 GALLON BAG							
8407494	1	BG	IL	IN	MI	OH	WI
			08	08	08	08	08
Polywater G55, used to lubricate cable in under ground or building conduit.							

280043811 LUBRICANT CABLE 1 GALLON JUG							
1927707	1	GL	IL	IN	MI	OH	WI
			08	08	08	08	08
Polywater F128, a pourable liquid lubricant recommended for long copper & fiber optic cable pulls.							

280079716 LUBRICANT CABLE 4 OZ BOTTLE K&B							
N		EA	1	2	1		

001196864 LUBRICANT CRC 226 16OZ CAN							
1220392	1	EA	IL	IN	MI	OH	WI
			08	08	08	08	08
An inert organic solvent spray which penetrates, cleans and leaves a soft film to lubricate. Displaces and seals out moisture, prevents corrosion.							

260434758 LUBRICANT F320 2.5 GALLON JUG							
N		JG	2	2	4		
Summer grade cable pulling lubricant.							

LUG GROUND

300040995 LUG GROUND TII 155							
5112235	1	EA					
Made of tin plated copper to ensure good electrical connection between the shield of buried service drop wire and ground lug.							

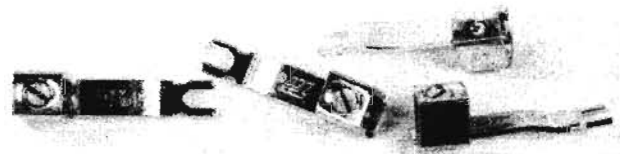

300040995

LUG TERMINAL

997815014 LUG TERMINAL CK5517 L 1							
5288324	1	PC					
260425038 LUG TERMINAL PEDESTAL REPLACEMENT							
1976928	1	PK	IL	IN	MI	OH	WI
Black replacement cap for AMP QUIET Front Terminal Block. 5 lugs per pack.							

260425046 LUG TERMINAL PEDESTAL REPLACEMENT							
1976936	1	PK	IL	IN	MI	OH	WI
			03				
Red replacement cap for AMP QUIET Front Terminal Block. 5 lugs per pack.							

PRODUCT IDENTIFIER							DESCRIPTION						
ITEM NUMBER	ORD. MULT.	SELL UNIT	STD. PKG. STOCK AVAILABILITY / PA	LEAD TIME	MIN. ORD.	A C							
MANHOLE FRAME & COVER													
400145819	N	EA	1	9	1		MANHOLE FRAME & COVER B27 CA06572.						
400145827	N	EA	1	9	1		MANHOLE FRAME & COVER B30 CA06572.						
402462923	N	EA	1	9	1		MANHOLE FRAME & COVER G27 CA08453.						
402462931	N	EA	1	9	1		MANHOLE FRAME & COVER G30 CA08453.						
402462949	N	EA	1	9	1		MANHOLE FRAME & COVER H27 CA08453.						
402462956	N	EA	1	9	1		MANHOLE FRAME & COVER H30 CA08453.						
400145876	N	EA	1	9	1		MANHOLE FRAME & COVER SB27 CA06572.						
400145884	N	EA	1	9	1		MANHOLE FRAME & COVER SB30 CA06572.						
402463293	N	EA	1	9	1		MANHOLE FRAME & COVER SG27 CA08453.						
402462964	N	EA	1	9	1		MANHOLE FRAME & COVER SG30 CA08453.						
402462972	N	EA	1	9	1		MANHOLE FRAME & COVER SH27 CA08453.						
402462980	N	EA	1	9	1		MANHOLE FRAME & COVER SH30 CA08453.						
MANHOLE RING EXTENSION													
400260717	N	EA	1	9	1		MANHOLE RING EXTENSION B27 2IN						
280002403	N	EA	1	4	1		MANHOLE RING EXTENSION B27 2IN						
400260725	N	EA	1	9	1		MANHOLE RING EXTENSION B27 3IN						

PRODUCT IDENTIFIER							DESCRIPTION						
ITEM NUMBER	ORD. MULT.	SELL UNIT	STD. PKG. STOCK AVAILABILITY / PA	LEAD TIME	MIN. ORD.	A C							
280002387	N	EA	1	4	1		MANHOLE RING EXTENSION B27 3IN						
280002395	N	EA	1	4	1		MANHOLE RING EXTENSION B30 2IN						
400260758	N	EA	1	9	1		MANHOLE RING EXTENSION B30 2IN						
400260766	N	EA	1	9	1		MANHOLE RING EXTENSION B30 3IN						
MARKER													
260440300	N	EA	1	2	1		MARKER CABLE BIG FINK P/N300B8-ORG-4BS Complete with Test Pad, Ground Wire, and Retrofit Kit.						
260440284	N	EA	1	2	1		MARKER CABLE BIG FINK TEST PAD Cott.						
300060894	6511154	1	EA	IL IN MI OH WI			MARKER CABLE OB166L 33						
260440276	N	EA	1	2	1		MARKER CABLE RETRO-FIT KIT P/N PIN-0001, Cott.						
402704068	1177519	1	EA	IL IN MI OH WI	1250		MARKER ELECTRONIC 08 08 08 08 08 Full Range-Telephone Electronic Marker System. Use with EMS Locator.						
													
1177519													

DISTRIBUTION SERVICES

NETWORK SERVICES

TOOLS

BUILDING JANITORIAL

AUTOMOTIVE

FORMS/OFFICE SUPPLIES

GENERAL

DATA VOICE

MARKER

PRODUCT IDENTIFIER DESCRIPTION

ITEM NUMBER	ORD. MULT.	SELL UNIT	STD. PKG. STOCK AVAILABILITY / PA	LEAD TIME	MIN. ORD.	A C
-------------	------------	-----------	-----------------------------------	-----------	-----------	-----

280093436 MARKER ELECTRONIC BALL 1401 4IN
 1936997 1 EA IL IN MI OH WI
 08 08 08 08
 Use with EMS telephone marker locator. Buried marker 4ft max.



1936997

000247890 MARKER UTILITY 66
 5317388 1 EA IL IN MI OH WI
 08
 With Ohio Bell decal.

260441472 MARKER UTILITY FINDER 5FT
 N EA 1 4 1
 Orange/white, clamp attachment.

260440425 MARKER UTILITY FINDER 5FT W/CLAMP
 N EA 1 4 1
 No spring on clamp. Pedestal marker.

260441480 MARKER UTILITY FINDER 6FT
 N EA 1 4 1
 Orange/white, adhesive attachment.

002093789 MARKER UTILITY ORANGE 72IN
 1198838 1 EA IL IN MI OH WI
 08

402574099 MARKER WIRE PWS
 5390922 1 PK IL IN MI OH WI
 18
 Package of 14.

401665427 MARKER Y15-0 7/8IN X 1 1/2IN
 1204347 1 CD IL IN MI OH WI
 18 18
 Card of 10.

401665435 MARKER Y15-1 7/8IN X 1 1/2IN
 1204362 1 CD IL IN MI OH WI
 18 18
 Card of 10.

401665443 MARKER Y15-2 7/8IN X 1 1/2IN
 1204388 1 CD IL IN MI OH WI
 18 18
 Card of 10.

401665450 MARKER Y15-3 7/8IN X 1 1/2IN
 1204404 1 CD IL IN MI OH WI
 18 18
 Card of 10.

PRODUCT IDENTIFIER DESCRIPTION

ITEM NUMBER	ORD. MULT.	SELL UNIT	STD. PKG. STOCK AVAILABILITY / PA	LEAD TIME	MIN. ORD.	A C
-------------	------------	-----------	-----------------------------------	-----------	-----------	-----

401665468 MARKER Y15-4 7/8IN X 1 1/2IN
 1204420 1 CD IL IN MI OH WI
 18 18
 Card of 10.

401665476 MARKER Y15-5 7/8IN X 1 1/2IN
 1204446 1 CD IL IN MI OH WI
 18 18
 Card of 10.

401665484 MARKER Y15-6 7/8IN X 1 1/2IN
 1204461 1 CD IL IN MI OH WI
 18 18
 Card of 10.

401665492 MARKER Y15-7 7/8IN X 1 1/2IN
 1204487 1 CD IL IN MI OH WI
 18 18
 Card of 10.

401665500 MARKER Y15-8 7/8IN X 1 1/2IN
 1204503 1 CD IL IN MI OH WI
 18 18
 Card of 10.

401665518 MARKER Y15-9 7/8IN X 1 1/2IN
 1204529 1 CD IL IN MI OH WI
 18 18
 Card of 10.

MARKER CABLE WARNING SYSTEM

For marking the location of Underground Telephone Cable.

260407069 MARKER CABLE WARNING POST-IL
 N EA 5 2 5
 WITH TEST STATION - Post Anchor included.

260407010 MARKER CABLE WARNING POST-IL
 1975441 18 EA IL IN MI OH WI
 08
 Warning Post used to properly identify state - CALL BEFORE YOU DIG-Telephone Number - Package includes Post, Collar, Mounting Pegs & Post Anchor.

260407077 MARKER CABLE WARNING POST-IN
 N EA 5 2
 WITH TEST STATION - Post Anchor included.

260407028 MARKER CABLE WARNING POST-IN
 1975458 18 EA IL IN MI OH WI
 08
 Warning Post used to properly identify state - CALL BEFORE YOU DIG-Telephone Number - Package includes Post, Collar, Mounting Pegs & Post Anchor.

260407101 MARKER CABLE WARNING POST-MI
 N EA 5 2 5
 WITH TEST STATION - Post Anchor included.

DISTRIBUTION SERVICES

NETWORK SERVICES

TOOLS

BUILDING JANITORIAL

AUTOMOTIVE

FORMS/OFFICE SUPPLIES

GENERAL

DATA VOICE

MOUNTING APPARATUS

PRODUCT IDENTIFIER DESCRIPTION

ITEM NUMBER	ORD. MULT.	SELL UNIT	STD. PKG. STOCK AVAILABILITY / PA	LEAD TIME	MIN. ORD.	A C
-------------	------------	-----------	-----------------------------------	-----------	-----------	-----

260407051 MARKER CABLE WARNING POST-MI
 1975482 18 EA IL IN MI OH WI
 08
 Warning Post used to properly identify state - CALL BEFORE YOU DIG-Telephone Number -. Package includes Post, Collar, Mounting Pegs & Post Anchor.

260407093 MARKER CABLE WARNING POST-OH
 N EA 5 2 5
 WITH TEST STATION - Post Anchor included.

260407044 MARKER CABLE WARNING POST-OH
 1975474 18 EA IL IN MI OH WI
 08
 Warning Post used to properly identify state - CALL BEFORE YOU DIG-Telephone Number -. Package includes Post, Collar, Mounting Pegs & Post Anchor.

260407085 MARKER CABLE WARNING POST-WI
 N EA 5 2 5
 WITH TEST STATION - Post Anchor included.

260407036 MARKER CABLE WARNING POST-WI
 1975466 18 EA IL IN MI OH WI
 08
 Warning Post used to properly identify state - CALL BEFORE YOU DIG-Telephone Number -. Package includes Post, Collar, Mounting Pegs & Post Anchor.

MODULE

260402847 MODULE 3G 5 PIN F013750
 1968537 1 EA

260437959 MODULE 4005 DPM/16
 N EA 12 3 120

260428651 MODULE 4005DPM/NC BODY ONLY W/INSULATOR
 1977918 1 EA IL IN MI OH WI
 08 08 08 08 08
 No cover. Used in conjunction with 4005 DPM modules in various configurations & eliminates discarding cover from 4005 DPM module packaging.

260337951 MODULE ANI 911 TIP PARTY
 1947960 1 EA IL IN MI OH WI
 18

260337944 MODULE PSR 904 SELECT RING
 1947952 1 EA IL IN MI OH WI
 18

260405949 MODULE WALL MOUNTED 50M 200W C103
 N EA 1 4 1
 Homaco.

260405931 MODULE WALL MOUNTED 50M 900PPW MODA190
 N EA 1 4 1
 Homaco.

PRODUCT IDENTIFIER DESCRIPTION

ITEM NUMBER	ORD. MULT.	SELL UNIT	STD. PKG. STOCK AVAILABILITY / PA	LEAD TIME	MIN. ORD.	A C
-------------	------------	-----------	-----------------------------------	-----------	-----------	-----

260338611 MODULE WALL MOUNTED 50M 1500W
 N EA 1 4 1
 Homaco.

260405675 MODULE WALL MOUNTED 50M 2000W
 N EA 1 4 1
 Homaco.

MOUNT SET

400836045 MOUNT SET 3M C0 4060
 N SE 120 3 1200
 Package of 120. For use in mounting module 4010E and 4011E in various 3M company cabinets, BSP 631-620-900W.

MOUNTING

402377410 MOUNTING COMPARTMENT L8A
 N EA 1 9 1

260431804 MOUNTING RING FOR 4200H-5400
 N EA 1 2 1

260388400 MOUNTING RING FOR 4918/4927
 N EA 1 2 1

260388418 MOUNTING RING FOR 4954
 N EA 1 2 1

400162095 MOUNTING STEPPOLE B
 1202689 1 EA IL IN MI OH WI
 14 14 14 14 14
 For use with the B portable pole step, BSP 821-210-011.

MOUNTING APPARATUS

100321587 MOUNTING APPARATUS 37A
 N EA 1 9 1
 For mounting a 243C or similar type jack. NOW AVAILABLE THROUGH TOUCH-TONE ORDER ENTRY.

100321603 MOUNTING APPARATUS 39A
 N EA 1 9 1

101026169 MOUNTING APPARATUS 39B
 N EA 1 9 1

100321637 MOUNTING APPARATUS 42A
 N EA 1 9 1

DISTRIBUTION SERVICES

NETWORK SERVICES

TOOLS

BUILDING JANITORIAL

AUTOMOTIVE

FORMS/OFFICE SUPPLIES

GENERAL

DATA VOICE

DISTRIBUTION SERVICES

NETWORK SERVICES

TOOLS

BUILDING JANITORIAL

AUTOMOTIVE

FORMS/OFFICE SUPPLIES

GENERAL

DATA VOICE

MOUNTIN

PRODUCT IDENTIFIER DESCRIPTION

ITEM NUMBER	ORD. MULT.	SELL UNIT	STD. PKG.	LEAD TIME	MIN. ORD.	A C
STOCK AVAILABILITY / PA						

102918802 MOUNTING APPARATUS 103A

ITEM NUMBER	ORD. MULT.	SELL UNIT	STD. PKG.	LEAD TIME	MIN. ORD.	A C
1213637	1	EA	IL IN MI OH WI	18 18 18 18 18		

Apparatus mounting used as a 16 slot data mounting.



1213637

MUSLIN

400162103 MUSLIN ROLL 2IN CA06727

ITEM NUMBER	ORD. MULT.	SELL UNIT	STD. PKG.	LEAD TIME	MIN. ORD.	A C
1202721	10	RO				

Used for wrapping splices, BSP 632-020-100.

400162111 MUSLIN ROLL 4IN CA06727

ITEM NUMBER	ORD. MULT.	SELL UNIT	STD. PKG.	LEAD TIME	MIN. ORD.	A C
1202747	10	RO	IL IN MI OH WI	08 08 08 08 08		

280050832 MUSLIN ROLL 40IN X 25YD

ITEM NUMBER	ORD. MULT.	SELL UNIT	STD. PKG.	LEAD TIME	MIN. ORD.	A C
1929133	1	YD	IL IN MI OH WI	08 08 08 08 08		

Commercial.

NAIL

900218553 NAIL ROOF 11 1 1/2IN X 7/16IN

ITEM NUMBER	ORD. MULT.	SELL UNIT	STD. PKG.	LEAD TIME	MIN. ORD.	A C
N		PK	50	4	50	

Galvanized, 1 pound package.

900127408 NAIL ROOF 12 1IN X 3/8IN

ITEM NUMBER	ORD. MULT.	SELL UNIT	STD. PKG.	LEAD TIME	MIN. ORD.	A C
1202788	1	PK	IL IN MI OH WI	14 14 14 14 14		

Galvanized, used for installing clamps or cleats in station work, 1 pound package.

400314019 NAIL STRAPS 2IN X 3/16IN FLATHEAD

ITEM NUMBER	ORD. MULT.	SELL UNIT	STD. PKG.	LEAD TIME	MIN. ORD.	A C
1202848	1	PK	IL IN MI OH WI	08 08 08 08 08		

1LB Package. Galvanized, used for attaching cable straps and clamps to poles, BSP 632-020-100.

400162137 NAIL TAG POLE 1 1/4IN CA06187

ITEM NUMBER	ORD. MULT.	SELL UNIT	STD. PKG.	LEAD TIME	MIN. ORD.	A C
2765768	1	PK	IL IN MI OH WI	14 14 14 14 14		

1LB Package. Used for securing aluminum or zinc pole tag insignia to telephone poles, BSP 621-200-206.

NAIL WIRE

001026871 NAIL WIRE BRAD 4D 1 1/2IN STEEL

ITEM NUMBER	ORD. MULT.	SELL UNIT	STD. PKG.	LEAD TIME	MIN. ORD.	A C
1180745	1	PK				

APAN #88-0049/01, 1lb package. DISCONTINUE UPON STOCK DEPLETION

PRODUCT IDENTIFIER DESCRIPTION

ITEM NUMBER	ORD. MULT.	SELL UNIT	STD. PKG.	LEAD TIME	MIN. ORD.	A C
STOCK AVAILABILITY / PA						

900168881 NAIL WIRE COMMON 4D 5LB PACKAGE

ITEM NUMBER	ORD. MULT.	SELL UNIT	STD. PKG.	LEAD TIME	MIN. ORD.	A C
2788463	1	PK	IL IN MI OH WI	14 14 14 14 14		

A common galvanized wire nail, with a flat head, used in outside work. May be used for wooden pins in cross-arms.

900168899 NAIL WIRE COMMON 6D 5LB PACKAGE

ITEM NUMBER	ORD. MULT.	SELL UNIT	STD. PKG.	LEAD TIME	MIN. ORD.	A C
2788489	1	PK	IL IN MI OH WI	14 14 14 14 14		

A common galvanized wire nail, with a flat head, used in outside work.

001108174 NAIL WIRE COMMON 8D 2LB PACKAGE

ITEM NUMBER	ORD. MULT.	SELL UNIT	STD. PKG.	LEAD TIME	MIN. ORD.	A C
N		PK	50	4	50	

A common galvanized wire nail, with a flat head, used in outside work.

900168907 NAIL WIRE COMMON 8D 5LB PACKAGE

ITEM NUMBER	ORD. MULT.	SELL UNIT	STD. PKG.	LEAD TIME	MIN. ORD.	A C
2788505	1	PK	IL IN MI OH WI	14 14 14 14 14		

A common galvanized wire nail, with a flat head, used in outside work.

900168915 NAIL WIRE COMMON 10D 5LB PACKAGE

ITEM NUMBER	ORD. MULT.	SELL UNIT	STD. PKG.	LEAD TIME	MIN. ORD.	A C
N		PK	10	4	10	

Galvanized.

900168931 NAIL WIRE COMMON 30D 5LB PACKAGE

ITEM NUMBER	ORD. MULT.	SELL UNIT	STD. PKG.	LEAD TIME	MIN. ORD.	A C
2788547	1	PK	IL IN MI OH WI	14 14 14 14 14		

A common galvanized wire nail, with a flat head, used in outside work. May be used to attach wooden pole brackets to pole.

900168949 NAIL WIRE COMMON 40D 5LB PACKAGE

ITEM NUMBER	ORD. MULT.	SELL UNIT	STD. PKG.	LEAD TIME	MIN. ORD.	A C
N		PK	10	4	10	

Galvanized. NOW AVAILABLE THROUGH TOUCH-TONE ORDER ENTRY.

900168964 NAIL WIRE COMMON 60D 5LB PACKAGE

ITEM NUMBER	ORD. MULT.	SELL UNIT	STD. PKG.	LEAD TIME	MIN. ORD.	A C
2788562	1	PK	IL IN MI OH WI	14 14 14 14 14		

A common galvanized wire nail, with a flat head, used in outside work. May be used to attach wooden pole brackets to pole.

400162244 NAIL WIRE GROUND 7/8LB

ITEM NUMBER	ORD. MULT.	SELL UNIT	STD. PKG.	LEAD TIME	MIN. ORD.	A C
1203026	1	PK	IL IN MI OH WI	08 08 08 08 08		

400162251 NAIL WIRE GROUND 1 3/8LB

ITEM NUMBER	ORD. MULT.	SELL UNIT	STD. PKG.	LEAD TIME	MIN. ORD.	A C
1203042	1	PK	IL IN MI OH WI	08 08 08 08 08		

400162319 NAIL WIRE INSIDE 1/2 IN

ITEM NUMBER	ORD. MULT.	SELL UNIT	STD. PKG.	LEAD TIME	MIN. ORD.	A C
N		PK	100		10	

CA06667. Package of 100.

DISTRIBUTION SERVICES

NETWORK SERVICES

TOOLS

BUILDING JANITORIAL

AUTOMOTIVE

FORMS/OFFICE SUPPLIES

GENERAL

DATA VOICE

PRODUCT IDENTIFIER		DESCRIPTION				
ITEM NUMBER	ORD. MULT.	SELL UNIT	STD. PKG. STOCK AVAILABILITY / PA	LEAD TIME	MIN. ORD.	A C

NETWORK INTERFACE
SEE INTERFACE NETWORK

NIPPLE

001244755	NIPPLE PREWIRE 8IN					
N	EA	50	3	100		

An 8 inch threaded nipple and bracket to affixed to a stud at the time of prewire. This nipple would then provide a path through the wall to the protector.

NUT

400162822	NUT BOLT CROSSARM 5/8IN CA07232					
5215327	1	EA				

260431879	NUT CAP ACORN 3/8IN					
1979310	1	PK	IL 08	IN 08	MI	OH WI

002077030	NUT CHANNEL BAR CBN10K					
1135251	1	PK	IL 05	IN 08	MI 14	OH 08 WI 08

Channel bar inserts used to replace threaded inserts in channel bars.

400162921	NUT EYE THIMBLE 3/4IN CA06228					
1204686	1	EA	IL 14	IN 14	MI 14	OH 14 WI 14

Used for dead ending strand and guy attachments on joint used poles. Used with thimble guy rod or eyebolt, BSP 621-415-215.

400162913	NUT EYE THIMBLE 5/8IN CA06228					
1204560	1	EA	IL 14	IN 14	MI 14	OH 14 WI 14

260329792	NUT SQUARE 1/2IN					
1946681	1	EA	IL 18	IN	MI	OH WI

900218637	NUT SQUARE IRON 10/24					
5215467	1	BX	IL 18	IN	MI	OH WI 18

Box of 144.

900077371	NUT STEEL 5/24 0.175IN					
2610444	1	EA	IL	IN	MI 08	OH 08 WI

NUT HEX

900127556	NUT HEX 1/4IN-20 BRASS					
1226217	1	BX				

900158932	NUT HEX 1/4IN-20 PLATED STEEL					
N	BX	1	4	25		

900165788	NUT HEX 1/4IN-20 STEEL SHST					
N	BX	1	4	50		

PRODUCT IDENTIFIER		DESCRIPTION				
ITEM NUMBER	ORD. MULT.	SELL UNIT	STD. PKG. STOCK AVAILABILITY / PA	LEAD TIME	MIN. ORD.	A C

997052659	NUT HEX 1/4IN-20 X 3/16IN X 7/16IN					
6125187	1	EA	IL 12	IN 12	MI 12	OH 12 WI 12

Machine screw stainless steel.

841064777	NUT HEX 3/8IN 289A 841064777					
1196816	1	EA	IL 08	IN	MI	OH 08 WI 08

900127806	NUT HEX 6/32IN IRON					
5126169	1	BX	IL 18	IN	MI	OH WI

900127622	NUT HEX 8/32IN IRON					
5126201	1	BX	IL 18	IN	MI	OH WI

900165994	NUT HEX STOP ELASTIC SL29U040					
1213868	1	EA	IL 18	IN	MI	OH WI

OIL

996468740	OIL LUBE CK7470 QUART CAN					
1204768	12	QT				

Used in motors and generators in teletypewriter service where room temperatures are 40F, BSP 065-330-110.

900218801	OIL PENETRATING-LIQUID WRENCH					
1228908	1	CS	IL 08	IN 08	MI 08	OH 08 WI 08

16 OZ CAN. Used to desolve rust on nuts and bolts and lubricate hard to reach places on machinery.

PACK CIRCUIT

103056081	PACK CIRCUIT D 97A1					
1110734	1	EA				

(1) Adapts eight 97 type data jacks to 50 pin connectors. (2) Holds sixteen 97 type data jacks. (3) Multiple mounting for eight D97A type circuit packs.

103056099	PACK CIRCUIT D 97A2					
1202275	1	EA	IL 18	IN 18	MI 18	OH 18 WI 18

4 thru 12 data jack circuitry for one line. Plugs into 97A1 data mount.

103056107	PACK CIRCUIT D 97A3					
1199034	1	EA	IL 18	IN 18	MI 18	OH 11 WI 18

4 thru 12 data jack circuitry for one line. Plugs into 97A1 data mount.

103056115	PACK CIRCUIT D 97A4					
1172270	1	EA	IL 18	IN 18	MI 18	OH 18 WI 18

4 thru 12 data jack circuitry for one line. Plugs into 97A1 data mount.

PACK CIRCUIT

PRODUCT IDENTIFIER DESCRIPTION

ITEM	ORD.	SELL	STD. PKG.	LEAD TIME	MIN.	A
NUMBER	MULT.	UNIT	STOCK AVAILABILITY / PA		ORD.	C

103056123 PACK CIRCUIT D 97A5
 1177451 1 EA IL IN MI OH WI
 18 18 18 18 18
 DISCONTINUE UPON STOCK DEPLETION.

103056131 PACK CIRCUIT D 97A6
 1228050 1 EA IL IN MI OH WI
 18 18 18 18 18
 DISCONTINUE UPON STOCK DEPLETION.

103056149 PACK CIRCUIT D 97A7
 1218966 1 EA IL IN MI OH WI
 18 18 18 18
 Used in 97 A1 mounting. DISCONTINUE UPON STOCK DEPLETION.

103056156 PACK CIRCUIT D 97A8
 1141531 1 EA IL IN MI OH WI
 18 18 18 18
 DISCONTINUE UPON STOCK DEPLETION.

103056164 PACK CIRCUIT D 97A9
 N EA 1 2 1

PAD

280026386 PAD REPLACEMENT AD-7500 FOR UTD REPAIR
 N EA 1 6 10
 For AD-7520 abraiding tool used to prepare cable for up-the-duct sheath repair.

PAD CROSS-CONNECT

300069077 PAD CROSS CONNECT 60X42 TP-6042-04
 1945840 7 EA

300056082 PAD CROSS CONNECT 60X72 TP-7260-04
 5117382 5 EA IL IN MI OH WI
 08 08 08 08

260428354 PAD CROSS CONNECT 6200 TP-96135-04
 N EA 1 4 1

300069093 PAD CROSS CONNECT 80D TP-84112-04
 N EA 1 4 1

PAINT

300067527 PAINT MARKING FLOURESCENT ORANGE
 5120410 1 CN
 AT03701. A flourescent orange paint for marking locations of underground buried cable, 17oz can.

260361399 PAINT MARKING WHITE
 1954156 1 CN IL IN MI OH WI
 08 08 08 08

260322227 PAINT TOUCH-UP TU17
 N EA 12 6 12

PRODUCT IDENTIFIER DESCRIPTION

ITEM	ORD.	SELL	STD. PKG.	LEAD TIME	MIN.	A
NUMBER	MULT.	UNIT	STOCK AVAILABILITY / PA		ORD.	C

PANEL

105428247 PANEL 1000DL
 N EA 1 2 1

105428254 PANEL 1000FC/D4
 N EA 1 2 1

105428239 PANEL 1000SMA
 N EA 1 6 1

105428486 PANEL 1000ST LO-LOOSE
 N PK 1 2 1
 Package of 12.

260440458 PANEL 50 PAIR OBTPNLMM
 N EA 1 6 6
 E/W 50 protectors and MS2 connectors. Used to upgrade 200PR cabinet (260430715).

260338942 PANEL BEFC800MM

1954750 1 EA IL IN MI OH WI
 04 04 04
 Cross-connect panel R66 black only, 800pr.

260441670 PANEL BEFP200MMVH PRE-BRIDGED
 N EA 1 6 1
 Cross-connect panel e/w 200PR protectors (4B1E), 4-split 100PR in/out 66 blocks w/pre-installed bridge clips, MS2 connectorized input/output stubs.

104216338 PANEL CONNECTOR LCP 12A
 N EA 1 2 1

106372121 PANEL COUPLING SC
 N EA 1 6 1

106500630 PANEL F91AK8515 BULKHEAD 1.14X
 N EA 1 3 1

106500614 PANEL F9AK8513 BULKHEAD 16.
 N EA 1 3 1

260338983 PANEL RJ11 BEFNID 100MMB

1954768 1 EA IL IN MI OH WI
 18 08
 100 pair RJ11 w/bridge MS2 input connector.

260354618 PANEL RJ21 BEFG 600MM

1954743 1 EA IL IN MI OH WI
 04 04
 Equipped W/RJ21 connectors.

PANEL BLANK

260338967 PANEL BLANK BEFBP BACK
 1954818 1 EA

DISTRIBUTION SERVICES
 NETWORK SERVICES
 TOOLS
 BUILDING JANITORIAL
 AUTOMOTIVE
 FORMS/OFFICE SUPPLIES
 GENERAL
 DATA VOICE

DISTRIBUTION SERVICES

NETWORK SERVICES

TOOLS

BUILDING JANITORIAL

AUTOMOTIVE

FORMS/OFFICE SUPPLIES

GENERAL

DATA VOICE

PRODUCT IDENTIFIER		DESCRIPTION				
ITEM NUMBER	ORD. MULT.	SELL UNIT	STD. PKG. STOCK AVAILABILITY / PA	LEAD TIME	MIN. ORD.	A C

PANEL PROTECTOR

260354592 PANEL PROTECTOR BEFB300MM
 1966788 1 EA
 300 pair. Cross connect panel for Reliable Electric building entrance frame.

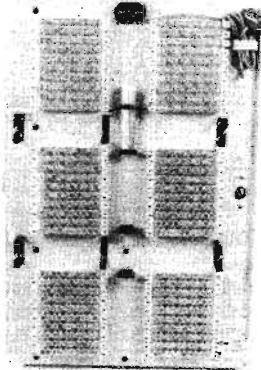

260354592

260364583 PANEL PROTECTOR BEFP400MMVH
 1954776 1 EA IL IN MI OH WI
 04 04 04
 400 pair R4B1E gas and heat coil protectors installed.

260364609 PANEL PROTECTOR BEFPX12200MMVH
 1954834 1 EA IL IN MI OH WI
 04 04
 200 pair R4B1E gas and heat coil protectors installed.

260364591 PANEL PROTECTOR BEFPX200MMVH
 1954826 1 EA IL IN MI OH WI
 04 04 04 04
 200 pair R4B1E gas and heat coil protectors installed.

PASTE SPACKLE

401154273 PASTE SPACKLE SYNKLD 1/2 PINT CAN
 1101931 1 CN
 A spackling compound to patch small holes in plaster used by installation forces.

PASTER

401496872 PASTER CABLE 2IN X 60FT CA06865
 5108449 1 RO

PEDESTAL

260405527 PEDESTAL AM PEIL-1-1-12G
 1971002 1 EA

260405535 PEDESTAL AM PEIL-1-1-12IMM
 1971010 1 EA IL IN MI OH WI
 08 08

PRODUCT IDENTIFIER		DESCRIPTION				
ITEM NUMBER	ORD. MULT.	SELL UNIT	STD. PKG. STOCK AVAILABILITY / PA	LEAD TIME	MIN. ORD.	A C

260403696 PEDESTAL AM PEIL-1-1-12T
 1970707 EA IL IN MI OH WI
 09 09 09

260403746 PEDESTAL AM PEIL-1-2715I
 1970699 EA IL IN MI OH WI
 09 09

260446554 PEDESTAL AM PEIL-2-1-12TBX
 N

260446562 PEDESTAL AM PEIL-2-1-12TBXMM
 N

260441597 PEDESTAL AM RPEIL-1-2715I
 N EA 1 6 1

260446570 PEDESTAL AM RPEIL-2-1-12TBX
 N

260446588 PEDESTAL AM RPEIL-2-1-12TBXMM
 N

260446596 PEDESTAL EXTEN PEIL-BE-6
 N

260427778 PEDESTAL EXTENSION PEIL-IE-6
 1977652 1 EA IL IN MI OH WI
 09

260300397 PEDESTAL FIBER OPTIC C-6181-W
 N EA 1 3 1

260418645 PEDESTAL POWER 4T U8980-0-KK 100 AMP
 1973529 1 EA IL IN MI OH WI
 09

260427901 PEDESTAL RPEIL-1-1-12IXMM
 1977801 1 EA IL IN MI OH WI
 09

PIN

260436993 PIN 10-12 GAUGE
 N EA 250 8 250

260437009 PIN 18-24 GAUGE
 N EA 2000 8 2000

PIN INSULATOR

400290987 PIN INSULATOR B STEEL CA06509
 N EA 50 8 2000

PIPE STEEL

900305228 PIPE STEEL 1/2IN X 5FT
 N EA 10 1 10
 Threaded both ends coupled one.

DISTRIBUTION SERVICES

NETWORK SERVICES

TOOLS

BUILDING JANITORIAL

AUTOMOTIVE

FORMS/OFFICE SUPPLIES

GENERAL

DATA VOICE

PIPE STEEL

PRODUCT IDENTIFIER DESCRIPTION

ITEM NUMBER	ORD. MULT.	SELL UNIT	STD. PKG. STOCK AVAILABILITY / PA	LEAD TIME	MIN. ORD.	A C
-------------	------------	-----------	-----------------------------------	-----------	-----------	-----

401357363 PIPE STEEL 2IN X 8FT DRILLED

1225664	1	EA	IL 35 IN 35 MI 35 OH 35 WI			
---------	---	----	----------------------------	--	--	--

260420203 PIPE STEEL GALVANIZED 1 X 42IN

N		EA	1	4	10	
---	--	----	---	---	----	--

A point of support used in a manhole to attach a fiber optic splice case.

401357397 PIPE STEEL GALVANIZED 1IN X 5FT

N		EA	10	1	10	
---	--	----	----	---	----	--

Threaded Both Ends Coupled One.

401357371 PIPE STEEL GALVANIZED 2IN X 5FT

N		EA	10	1	10	
---	--	----	----	---	----	--

Threaded Both Ends Coupled One.

401357389 PIPE STEEL GALVANIZED 3IN X 5FT

N		EA	5	1	5	
---	--	----	---	---	---	--

Threaded Both Ends Coupled One.

PLANK

400328639 PLANK ANCHOR PINE 24IN CA06702

N		EA	60	5	60	
---	--	----	----	---	----	--

Used in pairs in conjunction with a thimble guy rod to form a plank anchor in cases where the anchor hole is to be dug by machine.

400328654 PLANK COVER 9IN X 10FT CA07265

1143115	1	EA	IL 08 IN MI OH WI 08			
---------	---	----	----------------------	--	--	--

Used primarily as top protection for banks of creosoted wood conduit.

260441746 PLANK MANHOLE WOOD WI-218 6X10-3/4X1-3/4

N		EA	1	3	1	
---	--	----	---	---	---	--

401357421 PLANK TREATED 2IN X 10IN X 4FT

5218628	1	EA	IL 08 IN 08 MI OH WI 08			
---------	---	----	-------------------------	--	--	--

A treated plank used for supporting buried encapsulated splices.

PLATE

400290714 PLATE CABLE LOCATION NO CA06216

1189217	1	EA				
---------	---	----	--	--	--	--

Soft metallic tag, 3 1/2 X 2 1/2IN, used to mark MH volumes & equipment locations. BSP 622-500-011N.

PRODUCT IDENTIFIER DESCRIPTION

ITEM NUMBER	ORD. MULT.	SELL UNIT	STD. PKG. STOCK AVAILABILITY / PA	LEAD TIME	MIN. ORD.	A C
-------------	------------	-----------	-----------------------------------	-----------	-----------	-----

260321849 PLATE DIVIDER DP12AM

1942888	1	EA	IL 08 IN 08 MI 08 OH 08 WI			
---------	---	----	----------------------------	--	--	--

Used to separate splicing area from block terminals for closure cable CAD 12 AM.

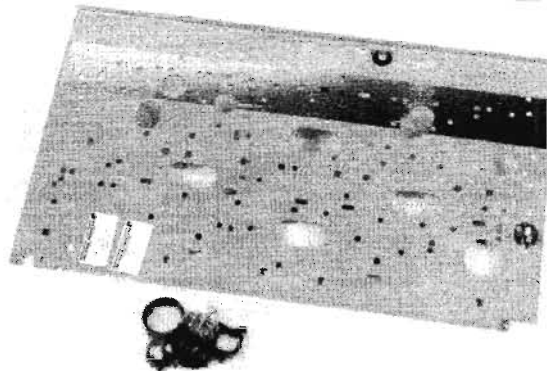

1942888

280008830 PLATE DIVIDER DP12PT

N		EA	2	6	10	
---	--	----	---	---	----	--

NOW AVAILABLE THROUGH TOUCH-TONE ORDER ENTRY.

300050465 PLATE DIVIDER HB12

N		EA	2	6	2	
---	--	----	---	---	---	--

401357637 PLATE FLUSH WITH 7/8IN IVORY SCREW

1148684	1	EA	IL 18 IN MI OH WI 18			
---------	---	----	----------------------	--	--	--

400482832 PLATE TEL TPY IV

1226746	1	EA	IL 18 IN 18 MI OH WI			
---------	---	----	----------------------	--	--	--

PLATE END

300084563 PLATE END 2A2 1E-505

5126318	1	EA				
---------	---	----	--	--	--	--

Used in conjunction with a 2 type closure to enclose and seal underground cables. The 1E's contain a single, the 2E's a double, and the 3E's a triple entrance.

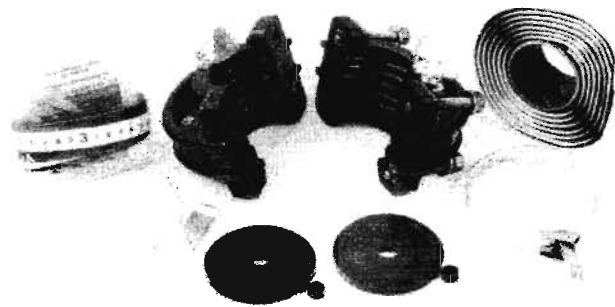

300084563

300084571 PLATE END 2A2 2E-505

5126334	1	EA	IL 08 IN 08 MI 08 OH 08 WI			
---------	---	----	----------------------------	--	--	--

PLATE END FIRE RETARDANT

PRODUCT IDENTIFIER		DESCRIPTION						
ITEM NUMBER	ORD. MULT.	SELL UNIT	STD. PKG. STOCK AVAILABILITY / PA	LEAD TIME			MIN. ORD.	A C
260320957 PLATE END 2A4 1E-505								
1975177	1	EA	IL 08 IN 08 MI OH WI 08					
260320965 PLATE END 2A4 2E-505								
N		EA	1	4			1	
NOW AVAILABLE THROUGH TOUCH-TONE ORDER ENTRY.								
260320908 PLATE END 2A4 9E								
N		EA	1	4			1	
260320981 PLATE END 2A4 9S								
N		EA	1	4			1	
300084589 PLATE END 2B2 1E-505								
1134858	1	EA	IL 08 IN 08 MI 08 OH 08 WI 08					
300084597 PLATE END 2B2 2E-505								
5126359	1	EA	IL 08 IN 08 MI 08 OH 08 WI 08					
300084605 PLATE END 2B2 3E-505								
5126367	1	EA	IL 08 IN 08 MI 08 OH 08 WI 08					
300084613 PLATE END 2C2 1E-505								
5126375	1	EA	IL 08 IN 08 MI 08 OH 08 WI 08					
300084621 PLATE END 2C2 2E-505								
5126391	1	EA	IL 08 IN 08 MI 08 OH 08 WI 08					
300084639 PLATE END 2C2 3E-505								
1189134	1	EA	IL 08 IN 08 MI 08 OH 08 WI 08					
300084647 PLATE END 2D2 1E-505								
5126417	1	EA	IL 08 IN 08 MI 08 OH 08 WI 08					
300084654 PLATE END 2D2 2E-505								
5126433	1	EA	IL 08 IN 08 MI 08 OH 08 WI 08					
280038936 PLATE END 2D2 3E-110								
N		EA	1	4			1	
300084662 PLATE END 2D2 3E-505								
5126458	1	EA	IL 08 IN 08 MI 08 OH 08 WI 08					
300068913 PLATE END 2E2 2E-505								
1941393	1	EA	IL 08 IN 08 MI 08 OH 08 WI 08					
280093683 PLATE END 2E2 3E-505								
1941385	1	EA	IL 08 IN 08 MI 08 OH 08 WI 08					
280041310 PLATE END 2X2 2E-505								
N		EA	1	4			1	

PRODUCT IDENTIFIER		DESCRIPTION						
ITEM NUMBER	ORD. MULT.	SELL UNIT	STD. PKG. STOCK AVAILABILITY / PA	LEAD TIME			MIN. ORD.	A C
260320940 PLATE END 2X4 2E-505								
N		EA	1	4			1	
280041328 PLATE END 2Y2 2E-505								
N		EA	1	4			1	
300076536 PLATE END INSERT SNI-300K								
N		PK	1				1	
300076544 PLATE END INSERT SWI-300K								
N		PK	1				1	

PLATE END FIRE RETARDANT

300068939 PLATE END FR 2B4 1E-505								
1943282	1	EA						
Fire retardant End Plates used in 2 type closures.								
300068806 PLATE END FR 2B4 2E-505								
1975201	1	EA	IL 08 IN MI OH WI 08					
Fire retardant End Plates used in 2 type closures.								
280080854 PLATE END FR 2B4 3E-505								
N		EA	1	4			1	
Fire retardant End Plates used in 2 type closures.								
300068814 PLATE END FR 2B4 12E 505								
1943431	1	EA	IL 08 IN 08 MI 08 OH 08 WI 08					
Fire retardant End Plates used in 2 type closures.								
300068921 PLATE END FR 2B4 12S								
1975144	1	EA	IL 08 IN MI OH WI 08					
Fire retardant End Plates used in 2 type closures.								
300068822 PLATE END FR 2C4 1E-505								
1943357	1	EA	IL 08 IN 08 MI 08 OH 08 WI 08					
Fire retardant End Plates used in the 2 type closures.								
300068830 PLATE END FR 2C4 2E-505								
1975169	1	EA	IL 08 IN 08 MI 08 OH 08 WI 08					
Fire retardant End Plates used in the 2 type closures.								
280080862 PLATE END FR 2C4 3E-505								
N		EA	1	4			1	
Fire retardant End Plates used in the 2 type closures. NOW AVAILABLE THROUGH TOUCH-TONE ORDER ENTRY.								
300068848 PLATE END FR 2C4 18E 505								
1949883	1	EA	IL 08 IN 08 MI 08 OH 08 WI 08					
Fire retardant End Plates used in the 2 type closures.								

DISTRIBUTION SERVICES

NETWORK SERVICES

TOOLS

BUILDING JANITORIAL

AUTOMOTIVE

FORMS/OFFICE SUPPLIES

GENERAL

DATA VOICE

PLATE END FIRE RETARDANT

DISTRIBUTION SERVICES

PRODUCT IDENTIFIER		DESCRIPTION					
ITEM NUMBER	ORD. MULT.	SELL UNIT	STD. PKG. STOCK AVAILABILITY / PA	LEAD TIME	MIN. ORD.	A C	

300068947 PLATE END FR 2C4 18S
 1943464 1 EA IL IN MI OH WI
 08 08 08 08 08
 Fire retardant End Plates used in the 2 type closures.

300068855 PLATE END FR 2D4 1E-505
 1943290 1 EA IL IN MI OH WI
 08 08 08 08 08
 Fire retardant End Plates used in the 2 type closures.

300068863 PLATE END FR 2D4 2E-505
 1943365 1 EA IL IN MI OH WI
 08 08 08 08 08
 Fire retardant End Plates used in the 2 type closures.

300068871 PLATE END FR 2D4 3E-505
 1945717 1 EA IL IN MI OH WI
 08 08 08 08 08
 Fire retardant End Plates used in the 2 type closures.

300068889 PLATE END FR 2D4 18E
 1943449 1 EA IL IN MI OH WI
 08 08 08 08 08
 Fire retardant End Plates used in the 2 type closures.

280080870 PLATE END FR 2D4 18S
 1943472 1 EA IL IN MI OH WI
 08 08 08 08 08
 Fire retardant End Plates used in the 2 type closures.

300068897 PLATE END FR 2D4 27E
 N EA 1 4 1
 Fire retardant End Plates used in the 2 type closures.

280080888 PLATE END FR 2D4 27S
 1975151 1 EA IL IN MI OH WI
 08 08 08 08 08
 Fire retardant End Plates used in the 2 type closures.

300068905 PLATE END FR 2D4 36E
 1945709 1 EA IL IN MI OH WI
 08 08 08 08 08
 Fire retardant End Plates used in the 2 type closures.

280080896 PLATE END FR 2D4 42E
 N EA 1 4 1
 Fire retardant End Plates used in the 2 type closures.

280080904 PLATE END FR 2E4 27E
 N EA 1 4 1
 Fire retardant End Plates used in 2 type closures.

280080938 PLATE END FR 2E4 27S
 N EA 1 4 1
 Fire retardant End Plates used in 2 type closures.

NETWORK SERVICES

TOOLS

BUILDING JANITORIAL

AUTOMOTIVE

FORMS/OFFICE SUPPLIES

GENERAL

DATA VOICE

PRODUCT IDENTIFIER		DESCRIPTION					
ITEM NUMBER	ORD. MULT.	SELL UNIT	STD. PKG. STOCK AVAILABILITY / PA	LEAD TIME	MIN. ORD.	A C	

260320973 PLATE END FR 2E4 2E-505
 N EA 1 4 1
 Fire retardant End Plates used in 2 type closures. NOW AVAILABLE THROUGH TOUCH-TONE ORDER ENTRY.

280080912 PLATE END FR 2E4 36E
 N EA 1 4 1
 Fire retardant End Plates used in 2 type closures.

280080946 PLATE END FR 2E4 36S
 N EA 1 4 1
 Fire retardant End Plates used in 2 type closures.

280080961 PLATE END FR 2E4 3E-505
 N EA 1 4 1
 Fire retardant End Plates used in 2 type closures.

280080920 PLATE END FR 2E4 42E
 N EA 1 4 1
 Fire retardant End Plates used in 2 type closures.

260320932 PLATE END FR 2Y4 2E-505
 N EA 1 4 1
 Fire retardant end plates used in 2 type closures.

PLATE FACE

100367960 PLATE FACE 16A 50
 1149914 1 EA
 For use with the 47C connecting block generally used with flush mounting jacks on residential wiring plans, BSP 461-610-100.

100368059 PLATE FACE 16D 50
 1224360 1 EA IL IN MI OH WI
 18 18
 Blank face plate.

105166730 PLATE FACE 65A 254
 N EA 1 3 1
 Blank brown cover plate with mounting bracket for use on 800A wire box, BSP 461-400-140.

103658498 PLATE FACE 65B 50
 N EA 1 4 1

105210421 PLATE FACE 860A
 N EA 1 3 1

PLATE MOUNTING

001185917 PLATE MOUNTING ADHESIVE 735
 1444604 1 EA
 For adhesively mounting 42A connecting blocks to wall or baseboard surfaces.

002039378 PLATE MOUNTING CAD 12 SMDP12MB
 N EA 2 8 2

DISTRIBUTION SERVICES

NETWORK SERVICES

TOOLS

BUILDING JANITORIAL

AUTOMOTIVE

FORMS/OFFICE SUPPLIES

GENERAL

DATA VOICE

PRODUCT IDENTIFIER DESCRIPTION

ITEM NUMBER	ORD. MULT.	SELL UNIT	STD. PKG. STOCK AVAILABILITY / PA	LEAD TIME	MIN. ORD.	A C
-------------	------------	-----------	-----------------------------------	-----------	-----------	-----

002075091 PLATE MOUNTING LPMS S8 C PKG 100
 1227835 1 PK IL IN MI OH WI
 08 08 08 08 08
 Cable tie mount.

402353767 PLATE MOUNTING MAGNETIC 735M
 5361444 1 EA IL IN MI OH WI
 18 18 18 18 18
 Magnetic version of the 735 plate mounting plate for connecting blocks WE 42A, SE 42A, 625A, CAC625A.

401374947 PLATE MOUNTING WE TC 102
 N PK 1 5 1
 Small plastic mounting plate for securing cable ties to wood surfaces. Has hole to take #8 screw.

PLATFORM

400343075 PLATFORM AERIAL E 52IN
 N EA 1 4 1
 CA07955 - E/W Four 12ft support ropes.

400343091 PLATFORM AERIAL E 52IN
 N EA 1 4 1
 CAO7955 - E/W Four K hooks on four 6 1/2ft support ropes.

400343216 PLATFORM AERIAL E 52IN
 N EA 1 4 1
 CA07955 - E/W Two K hooks on two 6 1/2ft support ropes and two 12ft support ropes.

400343281 PLATFORM SADDLE B CA07955
 N EA 1 4 2

PLUG

401357686 PLUG CREOSOTE 3/4IN X 4IN
 5126508 1 EA
 Used to plug a boring for wooden utility pole re-inspection.

401357678 PLUG CREOSOTE 5/8IN X 4IN
 5220681 1 EA IL IN MI OH WI
 14

260344601 PLUG DUCT 1 1/2IN EXPANDING
 1950329 1 EA IL IN MI OH WI
 08 08
 Used for 23 type cable closures prior to encapsulation.

400328563 PLUG ENTRANCE B 1/2IN CA07900
 1102632 1 EA IL IN MI OH WI
 18 18 18 18 18
 A rubber plug used at building entrance of drop wire. Intended primarily for use with N, C, P or E drop wires, BSP 625-350-214.

260354451 PLUG MODULAR 2 CONDUCTOR
 1952457 1 BX IL IN MI OH WI
 18 18 18 18
 Box of 1000.

PRODUCT IDENTIFIER DESCRIPTION

ITEM NUMBER	ORD. MULT.	SELL UNIT	STD. PKG. STOCK AVAILABILITY / PA	LEAD TIME	MIN. ORD.	A C
-------------	------------	-----------	-----------------------------------	-----------	-----------	-----

280002056 PLUG PLASTIC UNIVERSAL 4 IN
 N EA 1 1 1

260439278 PLUG TAPERED END 4IN SMOOTH CORE
 N

401359377 PLUG TEST PAIR 4047
 1165548 1 EA IL IN MI OH WI
 18 18 18 18 18
 Plug is a connector probe which permits pair checking without damage to wire insulation. The prongs fit the test entry port of 3M modules. The cord permits easy connection to a talk block or test set.



1165548

002082519 PLUG UNIVERSAL 4150-0002
 N EA 1 2 1

300080116 PLUG VBC20K
 N PK 4 4 4

PLUG COLLARED

260346721 PLUG COLLARED 1.75IN PC-175
 N EA 1 2 1
 78-8011-1892-4.

260346739 PLUG COLLARED 2.25IN PC-225
 N EA 1 2 1
 78-8011-1893-2.

260346747 PLUG COLLARED 2.75IN PC-275
 N EA 1 2 1
 78-8011-1895-7.

260346754 PLUG COLLARED 2.98IN PC-298
 N EA 1 2 1
 78-8011-1897-3.

PLUG CONDUIT

995182656 PLUG CONDUIT 3 IN
 N EA 1 1
 CA06668.

995182623 PLUG CONDUIT 3 1/2IN
 N EA 1 1
 Split round CA06668.

DISTRIBUTION SERVICES

PLUG CONDUIT

PRODUCT IDENTIFIER		DESCRIPTION					
ITEM NUMBER	ORD. MULT.	SELL UNIT	STD. PKG. STOCK AVAILABILITY / PA	LEAD TIME	MIN. ORD.	A	C

995182664			PLUG CONDUIT 3 1/4IN				
N		EA	1		1		
Split square, CA06668.							

995203122			PLUG CONDUIT 4 IN				
N		EA	1		1		
SPSQ, CA06668.							

995203262			PLUG CONDUIT 4 IN				
N		EA	1		1		

995203064			PLUG CONDUIT 4 1/2IN				
N		EA	1		1		
SPRD, CA06668.							

995182722			PLUG CONDUIT 4 1/4IN				
N		EA	1		1		
SPSQ, CA06668.							

995203239			PLUG CONDUIT 4 1/4IN				
N		EA	1		1		
CA06668.							

995182516			PLUG CONDUIT ROUND 3 1/2IN				
N		EA	1		1		
Solid rubber.							

995182508			PLUG CONDUIT ROUND 3IN				
N		EA	1		1		
Solid rubber.							

995203288			PLUG CONDUIT ROUND 4 1/2IN				
N		EA	1		1		
Solid rubber.							

995203270			PLUG CONDUIT ROUND 4IN				
2300509	1	EA	IL IN MI OH WI				
35 35 35 35 35							
Solid rubber used to plug conduits to keep water and sand out.							

995182615			PLUG CONDUIT SPLIT ROUND 3-1/2 X 1-1/16				
N		EA	1		1		

995182540			PLUG CONDUIT SPRD 3IN SPLIT ROUND				
N		EA	1		1		

995203130			PLUG CONDUIT SPSQ 4 X 1-5/8IN				
N		EA	1		1		
Split square rubber.							

995182532			PLUG CONDUIT SQUARE 4 1/4IN				
N		EA	1		1		
Solid rubber.							

401234174			PLUG CONDUIT UNIVERSAL 4IN				
2754705	1	EA	IL IN MI OH WI				
08 08 08 08 08							
Plastic.							

PLUG TAPERED

300015377			PLUG TAPERED 1.25IN X 1.75IN PT 175				
N		EA	1	2	1		

PRODUCT IDENTIFIER		DESCRIPTION					
ITEM NUMBER	ORD. MULT.	SELL UNIT	STD. PKG. STOCK AVAILABILITY / PA	LEAD TIME	MIN. ORD.	A	C

260346713			PLUG TAPERED 1.75				
N		EA	1	2	1		
PT-225 78-8011-1903-9.							

401150958 PLUG TAPERED PT 100 K AND B

3302026	1	EA	IL IN MI OH WI				
08 08 08 08 08							

Tapered plug 1in in diameter used to close unwanted tip cable entrances on multiple and special caps on K&B Vault and Riser Closure.



3302026

260346705			PLUG TAPERED PT 120 1.2IN				
N		EA	1	2	1		
78-8011-1900-5.							

401359427 PLUG TAPERED PT 125

1151639	1	EA	IL IN MI OH WI				
08 08 08 08 08							

Tapered plug, 1.25in X .82in, used to close unwanted tip cable entrances on multiple and special end caps of vault closures.

260323597			PLUG TAPERED PT 130 1.3IN				
N		EA	1	2	1		

POLE LIGHT

SEE LIGHT POLE.

POLE TAG

SEE TAG POLE.

POLE WOODEN UTILITY

300054541			POLE WOODEN UTILITY 25FT CLASS 3				
N		EA	1	4	1		

300029642			POLE WOODEN UTILITY 25FT CLASS 4				
N		EA	1	4	1		

300054475			POLE WOODEN UTILITY 25FT CLASS 5				
N		EA	1	4	1		

300029659			POLE WOODEN UTILITY 25FT CLASS 6				
N		EA	1	4	1		

300054772			POLE WOODEN UTILITY 25FT CLASS 7				
N		EA	1	4	1		

NETWORK SERVICES

TOOLS

BUILDING JANITORIAL

AUTOMOTIVE

FORMS/OFFICE SUPPLIES

GENERAL

DATA VOICE

DISTRIBUTION SERVICES

NETWORK SERVICES

TOOLS

BUILDING JANITORIAL

AUTOMOTIVE

FORMS/OFFICE SUPPLIES

GENERAL

DATA VOICE

PRODUCT IDENTIFIER		DESCRIPTION				
ITEM NUMBER	ORD. MULT.	SELL UNIT	STD. PKG. STOCK AVAILABILITY / PA	LEAD TIME	MIN. ORD.	A C
300029667	N	EA	1	4	1	POLE WOODEN UTILITY 30FT CLASS 1
300029675	N	EA	1	4	1	POLE WOODEN UTILITY 30FT CLASS 2
300054038	N	EA	1	4	1	POLE WOODEN UTILITY 30FT CLASS 3
300029683	N	EA	1	4	1	POLE WOODEN UTILITY 30FT CLASS 4
300054087	N	EA	1	4	1	POLE WOODEN UTILITY 30FT CLASS 5
300029691	N	EA	1	4	1	POLE WOODEN UTILITY 30FT CLASS 6
300054137	N	EA	1	4	1	POLE WOODEN UTILITY 30FT CLASS 7
300029709	N	EA	1	4	1	POLE WOODEN UTILITY 35FT CLASS 1
300029717	N	EA	1	4	1	POLE WOODEN UTILITY 35FT CLASS 2
300054186	N	EA	1	4	1	POLE WOODEN UTILITY 35FT CLASS 3
300029725	N	EA	1	4	1	POLE WOODEN UTILITY 35FT CLASS 4
300054236	N	EA	1	4	1	POLE WOODEN UTILITY 35FT CLASS 5
300029741	N	EA	1	4	1	POLE WOODEN UTILITY 40FT CLASS 1
300054392	N	EA	1	4	1	POLE WOODEN UTILITY 40FT CLASS 2
300054285	N	EA	1	4	1	POLE WOODEN UTILITY 40FT CLASS 3
300054483	N	EA	1	4	1	POLE WOODEN UTILITY 40FT CLASS 4
300054335	N	EA	1	4	1	POLE WOODEN UTILITY 40FT CLASS 5
300029782	N	EA	1	4	1	POLE WOODEN UTILITY 45FT CLASS 1
300054442	N	EA	1	4	1	POLE WOODEN UTILITY 45FT CLASS 2
300054384	N	EA	1	4	1	POLE WOODEN UTILITY 45FT CLASS 3
300054491	N	EA	1	4	1	POLE WOODEN UTILITY 45FT CLASS 4

PRODUCT IDENTIFIER		DESCRIPTION				
ITEM NUMBER	ORD. MULT.	SELL UNIT	STD. PKG. STOCK AVAILABILITY / PA	LEAD TIME	MIN. ORD.	A C
300054434	N	EA	1	4	1	POLE WOODEN UTILITY 45FT CLASS 5
260328281	N	EA	1	4	1	POLE WOODEN UTILITY 50FT CLASS 1
300054244	N	EA	1	4	1	POLE WOODEN UTILITY 50FT CLASS 3
300054293	N	EA	1	4	1	POLE WOODEN UTILITY 50FT CLASS 4
280099623	N	EA	1	4	1	POLE WOODEN UTILITY 50FT CLASS 5

PORT CABLE

260323225	N	KT	1	2	1	PORT CABLE 4297-2
260322797	N	KT	1	2	1	PORT CABLE 4297-3

POST

400777009 POST ANCHOR CLOSURE DSB 32IN
 1223057 1 EA
 For use in stabilizing buried plant closures in loose soil.

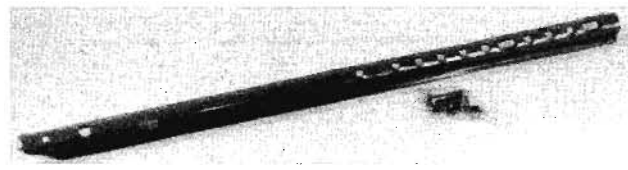

400777009

100398445 POST BINDING 29A
 1311423 1 EA
 Used to repair broken binding posts in No. 8 and 14 cable terminals.



1311423

260412259 POST BINDING REHAB BLUE 105-TYPE
 1975623 1 KT
 105 NFA/NCA Type.

DISTRIBUTION SERVICES
 NETWORK SERVICES
 TOOLS
 BUILDING JANITORIAL
 AUTOMOTIVE
 FORMS/OFFICE SUPPLIES
 GENERAL
 DATA VOICE

POST

PRODUCT IDENTIFIER		DESCRIPTION						
ITEM NUMBER	ORD. MULT.	SELL UNIT	STD. PKG. STOCK AVAILABILITY / PA	LEAD TIME	MIN. ORD.	A	C	
260412226 POST BINDING REHAB GREEN TIP HIGH								
1975599	1	KT	IL 08 IN 08 MI 08 OH 08 WI 08					
260412242 POST BINDING REHAB ORANGE								
N		KT	50	6	50			
260412267 POST BINDING REHAB PURPLE								
N		KT	50	6	50			
260412234 POST BINDING REHAB RED RING HIGH								
1975615	1	KT	IL 08 IN 08 MI 08 OH 08 WI 08					
002048759 POST BUMPER 3IN X 5FT STEEL								
1229088	1	EA	IL 08 IN 08 MI 08 OH 08 WI 08					



1229088

300041738 POST DP 1							
1180232	1	EA	IL 08 IN 08 MI 08 OH 08 WI 08				
A distribution ring assembly used with 184, 185, & 187 type backboards.							
280037003 POST FIBERGLASS CUM 72IN WB-567							
N		EA	20	4	20		
401428974 POST HOME MOBILE MHP-36							
N		EA	50	6	50		
300088630 POST MARKER UTILITY 6FT ORANGE							
1920553	1	EA	IL 08 IN MI OH WI				
M-CUM375 With L LB-170 Decal							

POST MOUNTING

260375753 POST MOUNTING ADJUSTABLE							
1960732	1	EA					

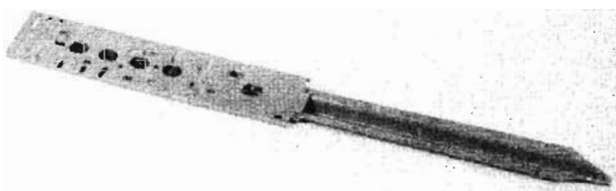

260375753

403061005 POST MOUNTING DM 72 GCS							
N		EA	50	6	50		
300050473 POST MOUNTING DM 72 GJI/CE							
5115758	1	EA	IL 08 IN MI OH WI				

403061112 POST MOUNTING DM 72 HJ							
N		EA	50	6	50		
FORWARD TO POST MOUNTING DM 78GT							

PRODUCT IDENTIFIER		DESCRIPTION						
ITEM NUMBER	ORD. MULT.	SELL UNIT	STD. PKG. STOCK AVAILABILITY / PA	LEAD TIME	MIN. ORD.	A	C	
300080546 POST MOUNTING DM 78 GJ								
4212043	1	EA	IL 08 IN 08 MI 08 OH 08 WI 08					
78 inch, joint mount stake, with hardware, green finish for use on CAD Closures.								
401780374 POST MOUNTING PROTECTOR PMP38								
N		EA	50	6	50			
Provides for the exterior mounting of a 305A2 or a 93 type protector mounting. For mounting protector at permanent installations of mobil homes, BSP 460-100-400, BSP 461-220-100.								
401814082 POST MOUNTING PROTECTOR PMP50								
N		EA	50	6	50			
Provides for the exterior mounting of one 305A2 or one 93 type protector mtg. For mounting protector at permanent installations of mobil homes, BSP 460-100-400, BSP 461-220-100.								
402015549 POST MOUNTING SIGN UP412-0-72								
N		EA	50	6	50			
401259809 POST MOUNTING SINGLE PT 19G								
1141671	1	EA	IL 08 IN 08 MI 08 OH 08 WI 08					
48 inch green mounting stake with hardware for CAD type closures.								

PRESSURIZATION AIR CABLE EQUIPMENT

280050287 ASSEMBLY CABLE 10FT 0500-00140							
N		EA	1	2	2		
10FT cable assy accessory for the Model 500 Series Flow Transducers that is used in central offices only. Cable assy transmits power to read signals from the flow transducer to the monitoring system.							
280050279 ASSEMBLY CABLE 15FT 0500-00138							
N		EA	1	2	2		
15FT cable assembly for the Model 500 Series Flow Transducers. The cable assembly transmits power to read signals from the flow transducer to the monitoring system.							
280050543 ASSEMBLY COIL CORD 1805-00219							
N		EA	1	2	2		
6FT coil cord with a phone plug on one end for connecting the Model 1805 Multisonic Translator/Detector & a screw-down audio plug on the other end for connecting to the duct probe.							
260360987 ATTACHMENT BRAKE 1802-00488							
N		EA	1	2	1		
Functions as a brake by resisting the forward travel of the Model 1802 Mini Duct Probe rod when the rod is released.							
401546734 BOX JUNCTION C CA08746							
2630301	1	EA	IL 08 IN 08 MI 08 OH 08 WI 08				
A metallic housing used as an interface point between up to five C pressure housings and tel pairs in a cable splice. Term facilities for up to 25 F pressure transducers. For 88 type punch down block.							

PRODUCT IDENTIFIER		DESCRIPTION				
ITEM NUMBER	ORD. MULT.	SELL UNIT	STD. PKG. STOCK AVAILABILITY / PA	LEAD TIME	MIN. ORD.	A C
260402987 BOX JUNCTION MODEL 230A						
N		EA	1	2	1	
A metallic housing used as an interface pt between up to 5 C pressure transducer hsnsgs & tel pairs in a cable splice. Term facilities for up to 25 F pressure transducers. Wire wrap term block. 230 Ver						
260402995 BOX JUNCTION UNDERGROUND 230AP						
N		EA	1		1	
Used in cable pressure systems, plugged with 2 SCFH controlled leak, same equipment as 230A.						
260403001 BOX JUNCTION UNDERGROUND 230C						
N		EA	1		1	
Used in cable pressure systems, 25 pair wire wrap terminal, 231 extensionarm.						
260403019 BOX JUNCTION UNDERGROUND 230CP						
N		EA	1		1	
Used in cable pressure systems, plugged with 2 SCFH controlled leak, same equipment as 230C.						
280050600 BRACKET WALL 7IN 0290-27211						
N		SE	1	2	1	
Set of two 7IN Wall Mounting Brackets for Mark Products' central office panels.						
280050618 BRACKET WALL 10IN 0291-27223						
N		EA	1	2	1	
Set of two 10IN Wall Mounting Brackets for Mark Products' central office panels.						
280050311 BRACKET WALL MOUNT FLOW TRANSDUCER						
N		EA	1	2	2	
Model 0500-21801 is a stainless steel, wall mounting bracket for the Model 500 or 550 Series Flow Transducers.						
280050469 CABLE AUDIO PLUG 1801-00197						
N		EA	1	2	2	
Connects the Model 1801-00195 Connector Box to the Hewlett Packard Model 4905A Ultrasonic Detector.						
280050527 CABLE PHONE PLUG 1801-00211						
N		EA	1	2	2	
30FT interconnect cable phone plug that connects the Model 1801 Duct Probe to the Model 1805 Multisonic Translator/Detector.						
997537006 CAP VALVE PRESSURE TEST CA06914M						
1124784	1	PK	IL 08	IN 08	MI 08	OH 08 WI 08
A hexagonal brass cap designed for installation and removal by means of a wrench.						
996147419 CAP VALVE PRESSURE TEST CA06914R						
1124800	1	PK	IL 08	IN 08	MI 08	OH 08 WI 08
Knurled dome brass cap with rubber jacket designed for installation and removal by means of the fingers.						

PRODUCT IDENTIFIER		DESCRIPTION				
ITEM NUMBER	ORD. MULT.	SELL UNIT	STD. PKG. STOCK AVAILABILITY / PA	LEAD TIME	MIN. ORD.	A C
400486916 CLAMP SEALING B 1 1/16IN						
1128884	1	EA	IL 08	IN 08	MI 08	OH 08 WI 08
For use over wrapped joints in splicing plastic sheathed cables to be maintained under air pressure. Slow action. Screw must be turned to advance the band through the housing. Stainless steel.						
400486940 CLAMP SEALING C 1 3/4 INCH						
N		EA	10		4	500
CA08346. For use over wrapped joints in splicing plastic sheathed cables to be maintained under air pressure. Quick lock/quick release of the band. Stainless steel.						
900290669 CLAMP SEALING C 2 1/2 INCH						
N		EA	500		4	500
For use over wrapped joints in splicing plastic sheathed cables to be maintained under air pressure. Quick lock/quick release of the band. Stainless steel.						
400486932 CLAMP SEALING C 2 INCH						
1128926	1	EA	IL 08	IN 08	MI 08	OH 08 WI 08
For use over wrapped joints in splicing plastic sheathed cables to be maintained under air pressure. Quick lock/quick release of the band. Stainless steel. BSP-633-300-204.						
400411195 CLAMP SEALING C 4 INCH						
1128942	1	EA	IL 08	IN 08	MI 08	OH 08 WI 08
For use over wrapped joints in splicing plastic sheathed cables to be maintained under air pressure. Quick lock/quick release of the band. Stainless steel. CA08346.						
260322144 CLAMP SEALING C 7 INCH						
N		EA	150		4	600
For use over wrapped joints in splicing plastic sheathed cables to be maintained under air pressure. Quick lock/quick release of the band. Stainless steel.						
002055002 CONNECTOR 3131 AMP-FIT 561274 1						
4205963	1	EA	IL 08	IN 08	MI 08	OH 08 WI 08
Has a 5/16IN diameter pulling eye. This fitting is used as an aid in pulling pipe through conduit, and, in addition, can serve as a pipe plug.						
002055028 CONNECTOR 3131 AMP-FIT COUPLING 332843						
4205922	1	EA	IL 08	IN 08	MI 08	OH 08 WI 08
Used for the permanent joining of two sections of CA-3131 Feeder Pipe.						
002055036 CONNECTOR 3131 AMP-FIT END PLUG 561683 1						
4206029	1	EA	IL 08	IN 08	MI 08	OH 08 WI 08
Has a pre-assembled F Pressure Testing Valve to provide a pressure testing point.						

DISTRIBUTION SERVICES
 NETWORK SERVICES
 TOOLS
 BUILDING JANITORIAL
 AUTOMOTIVE
 FORMS/OFFICE SUPPLIES
 GENERAL
 DATA VOICE

PRESSURIZATION AIR CABLE EQUIPMENT

DISTRIBUTION SERVICES

NETWORK SERVICES

TOOLS

BUILDING JANITORIAL

AUTOMOTIVE

FORMS/OFFICE SUPPLIES

GENERAL

DATA VOICE

PRODUCT IDENTIFIER		DESCRIPTION						
ITEM NUMBER	ORD. MULT.	SELL UNIT	STD. STOCK	PKG. AVAILABILITY / PA	LEAD TIME	MIN. ORD.	A C	
280008087 CONNECTOR 3131 AMP-FIT PANEL 561411-1								
1939041	1	EA	IL	IN MI OH WI	08 08			
Has a 1/4IN male NPT thread at one end and is used as a panel connector.								
002055440 CONNECTOR 3131 AMP-FIT TEE 561515-1								
4206086	1	EA	IL	IN MI OH WI	08 08 08 08			
Used for tapping a CA-3131 Feeder Pipe. Three crimping rings, required for installation, are supplied with the fitting.								
900402801 CONNECTOR 3131 AMP-FIT TYPE H 332824								
2677880	1	EA	IL	IN MI OH WI	08 08 08 08 08			
Used for the permanent joining of two sections of CA-3131 Feeder Pipe. Has a side exit port with a 1/4IN NPT thread with ground post.								
900402819 CONNECTOR 3131 AMP-FIT TYPE J 332841								
2677948	1	EA	IL	IN MI OH WI	08 08 08 08 08			
Has an exit port on one end with a 1/4IN NPT thread. It also has a side exit port with a 1/8IN NPT thread for an F Pressure Testing Valve with ground post.								
900402827 CONNECTOR 3131 AMP-FIT TYPE K 332823								
2677922	1	EA	IL	IN MI OH WI	08 08 08 08			
Used for the permanent joining of two sections of CA-3131 Feeder Pipe. Has side exit ports with 1/8IN NPT threads for F Pressure Testing Valves with ground post.								
900402835 CONNECTOR 3131 AMP-FIT TYPE L 332842								
2677906	1	EA	IL	IN MI OH WI	08 08 08 08 08			
Has an end port with a 1/4IN male NPT thread and a side exit port with 1/8IN NPT for an F Pressure Testing Valve with ground post.								
300036720 CONNECTOR 3131 METAL COUPLING								
1226779	5	EA	IL	IN MI OH WI	08 08			
Provides a connection between two pieces of air pipe. Includes 1/8IN NPT port for a pressure testing valve or a connection to feed or monitor the air pipe pressure. Includes bonding clip.								
300036738 CONNECTOR 3131 METAL COUPLING/TEE								
1117077	1	EA	IL	IN MI OH WI	08			
Provides a connection between two pieces of air pipe. Includes 1/4IN NPT outlet. Includes bonding clip.								
300036712 CONNECTOR 3131 METAL END WITH PLUG								
1111195	5	EA	IL	IN MI OH WI	08			
Provides a terminating point for air pipe or a means of connecting any 1/4IN male pipe thread to air pipe. Includes 1/8IN NPT outlet for pressure test valve, and includes bonding clip.								

PRODUCT IDENTIFIER		DESCRIPTION						
ITEM NUMBER	ORD. MULT.	SELL UNIT	STD. STOCK	PKG. AVAILABILITY / PA	LEAD TIME	MIN. ORD.	A C	
300080066 CONNECTOR 3131 METAL TEE JUNCTION								
5124933	1	EA	IL	IN MI OH WI	08			
The T-185B with bonding clip provides for the connection of three 3131 air pipes. Designed to permit equalization of air flow from one pipe to another. Includes tee & three shut-off assemblies.								
280050667 CONNECTOR STRIP 5022-27241								
N		EA	1		2	5		
Connects two Model 5330 Modular Panels together on a rack.								
401804844 CONTACTOR PRESSURE R CA08782								
4204990	1	EA	IL	IN MI OH WI	08 08 08 08 08			
Plugs into T1-T1/OS & T1C carrier apparatus cases and monitors gas pressure on associated pressurized cable. Signals a drop in cable pressure below a preset 5 PSI level by completing a loop circuit.								
402984223 CONTACTOR PRESSURE W CA09017								
N		EA	1		3	1		
Plugs into the T1-T1/OS and T1C/T1D carrier apparatus cases and monitors gas pressure and humidity on above-ground static pressurized apparatus cases. Signals a drop in pressure below 5 PSI, 65% hum..								
401733761 CONTRACTOR PRESSURE P CA08680								
N		EA	1		3	1		
260360904 CONTROLLER HELIUM FLOW 530								
N		EA	1		2	1		
Delivers a constant flow of helium into pressurized systems, eliminating helium waste. Used with Helium Detector.								
280050758 CONTROLLER PRESSURE MODEL 401								
N		EA	1		2	2		
Can be used to lower the pressure of an entire manifold system when the pressure available from the pipe is greater than required.								
280050451 CORD PATCH 1801-00196								
N		EA	1		2	4		
Connects the Mark Model 1801 Reel Hub to the Connector Box.								
260396726 COVER MODIFIED TRANSDUCER HOUSING								
N		KT	1		3	1		
6361-369 For mounting a flow transducer on a 5-bank or 10-bank C transducer housing. Kit includes cover, gasket, & 3/8IN tubing fitting. Also known as Kit Flange Plate Adapter.								
260338009 DETECTOR HELIUM 1820A 10 SECOND CYCLE								
N		EA	1		2	1 C		
Used to detect leaks in direct buried pressurized cables, underground ducted cables, & pressurized pipe systems. Includes carrying case & strap, complete probe assembly, and battery charger.								
280050501 DEVICE DISTANCE MEASURE 1801-00204								
N		EA	1		2	1		
Used with the Mark Duct Probe 1801. Functions both as a device for measuring distance in feet and as a brake to control uncoiling of the rod.								

PRODUCT IDENTIFIER							DESCRIPTION						
ITEM NUMBER	ORD. MULT.	SELL UNIT	STD. PKG. STOCK AVAILABILITY / PA	LEAD TIME	MIN. ORD.	A C							
260301981	N	EA	1	6	1		ELBOW 45 DEGREE AMP-FIT 561402-1						
260301973	N	EA	1	6	1		ELBOW CRIMP SUB ASSEMBLY 561403-1						
280008095	N	EA	1	6	1		ELBOW SUB ASSEMBLY VALVE 561438-1						
260360995	N	EA	1	2	1		EQUIPMENT DISTANCE MEASURING 1802-00490. Use with the 1802 Mini Duct Probe. Reads out the footage of rod inserted into a duct for accurate distance measurement to the fault. It also functions as a brake.						
260384342	N	EA	1	1	1		FINDER FLOW 9.5 SCFH W/O CHECK VALVE Device installed on air pipe routes to provide a means for measuring air flow using a flow gauge. Model 3008.						
260384326	N	EA	1	1	1		FINDER FLOW 19 SCFH W/O CHECK VALVE Device installed on air pipe routes to provide a means for measuring air flow using a flow gauge. Model 3005. NOW AVAILABLE THROUGH TOUCH-TONE ORDER ENTRY.						
260384334	N	EA	1	1	1		FINDER FLOW 47.5 SCFH W/O CHECK VALVE Device installed on air pipe routes to provide a means for measuring air flow using a flow gauge. Model 3006. NOW AVAILABLE THROUGH TOUCH-TONE ORDER ENTRY.						
260384300	N	EA	1	1	1		FINDER FLOW 9.5 SCFH W/O CHECK VALVE Device installed on air pipe routes to provide a means for measuring air flow using a flow gauge. Model 3003. NOW AVAILABLE THROUGH TOUCH-TONE ORDER ENTRY.						
260396643	N	BX	1	1	1		FITTING 1/4 NPT X 3/8IN TUBING Used for flow finder installation on 3/8IN tubing. Model 3023. Box of 10. NOW AVAILABLE THROUGH TOUCH-TONE ORDER ENTRY.						
280007972	N	EA	1	6	1		FITTING 3/8 TUBE AMP-FIT COUPLING 561309-1. Coupling is used for joining two ends of a 3/8IN plastic tubing.						
280008004	N	EA	1	6	1		FITTING 3/8 TUBE AMP-FIT DEAD END 561308-1. Used to seal a section of 3/8IN plastic tubing.						
280008038	N	EA	1	6	1		FITTING 3/8 TUBE AMP-FIT DISCONNECT COUPLING 1/4 561312-1. Disconnect Coupling connects 3/8IN plastic tubing to any 1/4IN female NPT fitting. It also features a knurled, captive nut for convenient disconnection.						

PRODUCT IDENTIFIER							DESCRIPTION						
ITEM NUMBER	ORD. MULT.	SELL UNIT	STD. PKG. STOCK AVAILABILITY / PA	LEAD TIME	MIN. ORD.	A C							
280008020	N	EA	1	6	1		FITTING 3/8 TUBE AMP-FIT DISCONNECT COUPLING 1/8 561310-1. Disconnect Coupling connects 3/8IN plastic tubing to any 1/8IN female NPT fitting. This coupling also features a knurled, captive nut for convenient disconnection.						
280008053	N	EA	1	6	1		FITTING 3/8 TUBE AMP-FIT ELBOW 561318-1. Connects two ends of 3/8IN plastic tubing through a 90-degree elbow.						
280008046	N	EA	1	6	1		FITTING 3/8 TUBE AMP-FIT EL/COUPLING 561314-1. Disconnect Elbow connects 3/8IN plastic tubing to any 1/8IN female NPT fitting. It provides a 90-degree elbow, with a knurled, captive nut for convenient disconnection.						
280007980	N	EA	1	6	1		FITTING 3/8 TUBE AMP-FIT TEE 561304-1 Used to tap into a 3/8IN plastic tubing.						
280008152	N	EA	1	6	1		FITTING 3/8 TUBE AMP-FIT TO 3131 AIRPIPE 561720-1. Transition fitting is used to connect a section of CA-3131 Feeder Pipe to a section of 3/8IN plastic tubing.						
401331392	1156869	1	PK	IL 08	IN 08	MI 08	OH 08	WI 08					
CA08347B. Fitting used to connect 3/8IN tubing to 1/8IN NPT port.													
401331327	1156729	1	BX	IL 08	IN 08	MI 08	OH 08	WI 08					
CA08347. Fitting used to connect 3/8IN tubing to 1/8IN NPT port.													
401331335	1142596	1	BX	IL 08	IN 08	MI 08	OH 08	WI 08					
CA08347. Fitting used to connect three pieces of 3/8IN tubing.													
401332887	1156745	1	PK	IL 08	IN 08	MI 08	OH 08	WI 08					
CA08347. Fitting used to connect two pieces of 3/8IN tubing.													
401541230	N	PK	1	2	10		FITTING B STUB CABLE CA08756 For use in connecting stub cable between pressure transducer housing & junction boxes. 1/8IN NPT thread at one end. Furnished with C transducer housing.						
260428925	N	EA	1	1	1		FITTING NPT ADAPTER 1/2 F X 3/8 M						
260428909	N	EA	1	1	1		FITTING NPT ADAPTER 1/4 F X 1/4 M						
260428891	N	EA	1	1	1		FITTING NPT ADAPTER 1/4 F X 1/8 M						

DISTRIBUTION SERVICES
NETWORK SERVICES
TOOLS
BUILDING JANITORIAL
AUTOMOTIVE
FORMS/OFFICE SUPPLIES
GENERAL
DATA VOICE

DISTRIBUTION SERVICES

NETWORK SERVICES

TOOLS

BUILDING JANITORIAL

AUTOMOTIVE

FORMS/OFFICE SUPPLIES

GENERAL

DATA VOICE

PRESSURIZATION AIR CABLE EQUIPMENT

PRODUCT IDENTIFIER		DESCRIPTION					
ITEM NUMBER	ORD. MULT.	SELL UNIT	STD. PKG. STOCK AVAILABILITY / PA	LEAD TIME	MIN. ORD.	A	C
260428883			FITTING NPT ADAPTER 1/8 F X 1/8 M				
N		EA	1	1	1		
260428917			FITTING NPT ADAPTER 3/8 F X 1/4 M				
N		EA	1	1	1		
260428974			FITTING NPT BUSHING 1/2 M X 1/4 F				
N		EA	1	1	1		
260428966			FITTING NPT BUSHING 1/2 M X 1/8 F				
N		EA	1	1	1		
260428982			FITTING NPT BUSHING 1/2 M X 3/8 F				
N		EA	1	1	1		
260428933			FITTING NPT BUSHING 1/4 M X 1/8 F				
N		EA	1	1	1		
260428958			FITTING NPT BUSHING 3/8 M X 1/4 F				
N		EA	1	1	1		
260428941			FITTING NPT BUSHING 3/8 M X 1/8 F				
N		EA	1	1	1		
260429014			FITTING NPT BUSHING REDUCING 1/2 F X 3/8 F.				
N		EA	1	1	1		
260428990			FITTING NPT BUSHING REDUCING 1/4 F X 1/8 F.				
N		EA	1	1	1		
260429006			FITTING NPT BUSHING REDUCING 3/8 F X 1/4 F.				
N		EA	1	1	1		
260429097			FITTING NPT CAP 1/2IN				
N		EA	1	1	1		
260429030			FITTING NPT CAP 1/4IN				
N		EA	1	1	1		
260429022			FITTING NPT CAP 1/8IN				
N		EA	1	1	1		
260429048			FITTING NPT CAP 3/8IN				
N		EA	1	1	1		
260429089			FITTING NPT COUPLING 1/2IN				
N		EA	1	1	1		
260429063			FITTING NPT COUPLING 1/4IN				
N		EA	1	1	1		
260429055			FITTING NPT COUPLING 1/8IN				
N		EA	1	1	1		
260429071			FITTING NPT COUPLING 3/8IN				
N		EA	1	1	1		
260429139			FITTING NPT CROSS 1/2IN				
N		EA	1	1	1		

PRODUCT IDENTIFIER		DESCRIPTION					
ITEM NUMBER	ORD. MULT.	SELL UNIT	STD. PKG. STOCK AVAILABILITY / PA	LEAD TIME	MIN. ORD.	A	C
260429113			FITTING NPT CROSS 1/4IN				
N		EA	1	1	1		
260429105			FITTING NPT CROSS 1/8IN				
N		EA	1	1	1		
260429121			FITTING NPT CROSS 3/8IN				
N		EA	1	1	1		
260429170			FITTING NPT ELBOW 90 DEGREE 1/2IN				
N		EA	1	1	1		
260429154			FITTING NPT ELBOW 90 DEGREE 1/4IN				
N		EA	1	1	1		
260429147			FITTING NPT ELBOW 90 DEGREE 1/8IN				
N		EA	1	1	1		
260429162			FITTING NPT ELBOW 90 DEGREE 3/8IN				
N		EA	1	1	1		
260429238			FITTING NPT ELBOW STREET 45 DEG 1/2IN				
N		EA	1	1	1		
260429212			FITTING NPT ELBOW STREET 45 DEG 1/4IN				
N		EA	1	1	1		
260429204			FITTING NPT ELBOW STREET 45 DEG 1/8IN				
N		EA	1	1	1		
260429220			FITTING NPT ELBOW STREET 45 DEG 3/8IN				
N		EA	1	1	1		
260429196			FITTING NPT ELBOW STREET 90 DEG 1/2IN				
N		EA	1	1	1		
300085735			FITTING NPT ELBOW STREET 90 DEG 1/4IN				
N		EA	1	1	1		
900421223			FITTING NPT ELBOW STREET 90 DEG 1/8IN				
5317800	1	EA	IL IN MI OH WI 08 06 08 08				
260429188			FITTING NPT ELBOW STREET 90 DEG 3/8IN				
N		EA	1	1	1		
260429279			FITTING NPT NIPPLE 1/8 X 1 1/2IN				
N		EA	1	1	1		
260429261			FITTING NPT NIPPLE HEX 1/2IN				
N		EA	1	1	1		
260429246			FITTING NPT NIPPLE HEX 1/4IN				
N		EA	1	1	1		
			Brass cadmium plated.				
260323514			FITTING NPT NIPPLE HEX 1/8IN				
1943894	1	EA	IL IN MI OH WI 08 08 08 08				
			For pipe to pipe connections in cable pressurization.				
260429253			FITTING NPT NIPPLE HEX 3/8IN				
N		EA	1	1	1		

PRESSURIZATION AIR CABLE EQUIPMENT

PRODUCT IDENTIFIER		DESCRIPTION				
ITEM NUMBER	ORD. MULT.	SELL UNIT	STD. PKG. STOCK AVAILABILITY / PA	LEAD TIME	MIN. ORD.	A C
260429311		EA	1	1	1	
FITTING NPT PLUG 1/2IN						
N		EA	1	1	1	
260429295		EA	1	1	1	
FITTING NPT PLUG 1/4IN						
N		EA	1	1	1	
260429287		EA	1	1	1	
FITTING NPT PLUG 1/8IN						
N		EA	1	1	1	
260429303		EA	1	1	1	
FITTING NPT PLUG 3/8IN						
N		EA	1	1	1	
260429345		EA	1	1	1	
FITTING NPT TEE 1/2IN						
N		EA	1	1	1	
260323522		EA	IL IN MI OH WI 08 08 08 08			
FITTING NPT TEE 1/8IN						
1943902	1	EA	IL IN MI OH WI 08 08 08 08			
For pipe to pipe connections in cable pressurization.						
260429329		EA	1	1	1	
FITTING NPT TEE 1/8IN						
N		EA	1	1	1	
260429337		EA	1	1	1	
FITTING NPT TEE 3/8IN						
N		EA	1	1	1	
401990767		EA	IL IN MI OH WI 08 08 08 08			
FITTING NPT TEE BRANCH 1/8IN						
5317867	1	EA	IL IN MI OH WI 08 08 08 08			
260429386		EA	1	2	1	
FITTING NPT TEE STREET M-F-F 1/2IN						
N		EA	1	2	1	
260429352		EA	1	1	1	
FITTING NPT TEE STREET M-F-F 1/4IN						
N		EA	1	1	1	
260429360		EA	1	1	1	
FITTING NPT TEE STREET M-F-F 1/8IN						
N		EA	1	1	1	
260429378		EA	1	2	1	
FITTING NPT TEE STREET M-F-F 3/8IN						
N		EA	1	2	1	
260429428		EA	1	1	1	
FITTING NPT UNION 1/2IN						
N		EA	1	1	1	
260429402		EA	1	1	1	
FITTING NPT UNION 1/4IN						
N		EA	1	1	1	
260429394		EA	1	1	1	
FITTING NPT UNION 1/8IN						
N		EA	1	1	1	
260429410		EA	1	1	1	
FITTING NPT UNION 3/8IN						
N		EA	1	1	1	
400144655		PK	IL IN MI OH WI 08 08 08 08 08			
FLANGE PRESSURE C LEAD CABLE						
1146977	1	PK	IL IN MI OH WI 08 08 08 08 08			
Used to make pressure connections for testing pressure or injecting air into lead sheath cable under 100PR. Flange is tinned for soldering to lead sheath or sleeves. Package of 25.						

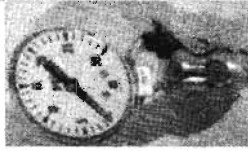
PRODUCT IDENTIFIER		DESCRIPTION				
ITEM NUMBER	ORD. MULT.	SELL UNIT	STD. PKG. STOCK AVAILABILITY / PA	LEAD TIME	MIN. ORD.	A C
280396551		EA	IL IN MI OH WI 08 08 08 08			
FLANGE PRESSURE CABLE						
1967695		EA	IL IN MI OH WI 08 08 08 08			
Replaces F pressure flange and G pressure flange. Used to make pressure connections for testing pressure or injecting air into 100PR or larger cable. Molded-in insert with 9/16 hex and 1/8 NPT thread.						
280050675		EA	1	2	1	
FLOWRATER PORTABLE 526						
N		EA	1	2	1	
Visual gauge for measuring the flow of air & helium into cable plant. 2 scales measure air flow from 0-4 SCFH & 2-21 SCFH, & helium flow from 0-8 SCFH & 5-44 SCFH. NOW AVAILABLE THRU TOUCH-TONE ORDER.						
280050691		EA	1	2	1	
FLOWRATER PORTABLE 535						
N		EA	1	2	1	
Visual gauge for measuring air flow in cable plants. Scale measures air flow from 0-100 SCFH.						
260431929		EA	1	2	1	
GASKET JUNCTION BOX C						
N		EA	1	2	1	
Rubber gasket used as a replacement O-ring for the 'C' junction box.						
280093394		EA	1	2	18	
GASKET U0230-50803						
N		EA	1	2	18	
4 X 5 1/2IN rubber gasket used as a Junction Box replacement part. The Model 0230-50803 Gasket is used with Model 230 Junction Boxes that do not have captive screws.						
400146171		EA	IL IN MI OH WI 12 12 12 12			E
GAUGE B PRESSURE CA07470						
1179507	1	EA	IL IN MI OH WI 12 12 12 12			E
Used in cases where approximate pressure measurements are desired. Consists of 2IN diameter dial, 0-30 PSI, and snap-on air chuck.						
						
1179507						
260361225		EA	1	2	1	
GAUGE C DIGITAL PRESSURE 4300						
N		EA	1	2	1	
Solid state, hand-held device with a digital display designed for easy reading of pneumatic pressures from -14.70 to +19.99 PSIG.						

DISTRIBUTION SERVICES
NETWORK SERVICES
TOOLS
BUILDING JANITORIAL
AUTOMOTIVE
FORMS/OFFICE SUPPLIES
GENERAL
DATA VOICE

DISTRIBUTION SERVICES

NETWORK SERVICES

TOOLS

BUILDING JANITORIAL

AUTOMOTIVE

FORMS/OFFICE SUPPLIES

GENERAL

DATA VOICE

PRESSURIZATION AIR CABLE EQUIPMENT

PRODUCT IDENTIFIER DESCRIPTION

ITEM NUMBER	ORD. MULT.	SELL UNIT	STD. PKG. STOCK AVAILABILITY / PA	LEAD TIME	MIN. ORD.	A C
-------------	------------	-----------	-----------------------------------	-----------	-----------	-----

400146189 GAUGE C PRESSURE ANALOG CA07717

1179523	1	EA	IL IN MI OH WI			E
			12 12 12 12 12			

sed to measure pressure in pressurized plant. Measures in tenths of a pound, from 0 to 12 PSIG.



1179523

260384359 GAUGE FLOW FINDER MODEL 3100

N		EA	1	1	1	
---	--	----	---	---	---	--

Air flow measuring device used in conjunction with flow finders. Measures the difference in air pressure and converts this value to an air flow rate. For use with any range flow finder.

260331921 HEADSET FOR MARK 1805 PROBE

N		EA	1	2	1	
---	--	----	---	---	---	--

Multisonic Translator/Detector. It comes standard with the Model 1805 Multisonic Translator/Detector.

400150520 HOSE PRESSURE B 30FT CA07676

1184069	1	EA	IL IN MI OH WI			E
			12 12 12 12 12			

One end has a spring guard coupling for connection to standard types of nitrogen regulators. The other end has a spring guard coupling & snap-on air chuck for connection to a pressure testing valve.

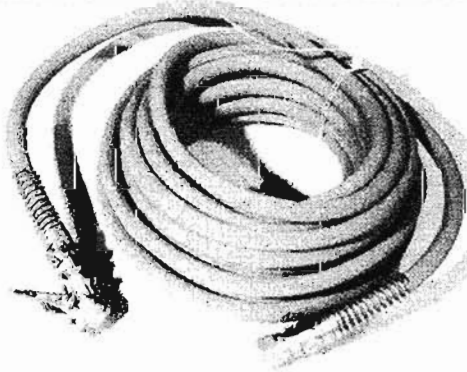

1184069

260429998 HOSE TWIN SANTOPRENE 3031

N		BX	1	3	1	1
---	--	----	---	---	---	---

1/8 inch double air tubing used to connect a Flow Finder to a High Valve Assembly. 50FT length.

PRODUCT IDENTIFIER DESCRIPTION

ITEM NUMBER	ORD. MULT.	SELL UNIT	STD. PKG. STOCK AVAILABILITY / PA	LEAD TIME	MIN. ORD.	A C
-------------	------------	-----------	-----------------------------------	-----------	-----------	-----

300077773 HOUSING TRANSDUCER C 10 CAVITY W/25PR

N		EA	1	3	1	
---	--	----	---	---	---	--

Metallic housing which can accommodate from 1 to 5 F Pressure Transducers in individual air-tight cavities. Equipped with 15FT, 25PR, 22-gauge single sheath plastic stub cable, talk term & spare leads.

300077765 HOUSING TRANSDUCER C 5 CAVITY W/25PR

1929471	1	EA	IL IN MI OH WI			
			04 04			

Metallic housing which can accommodate from 1 to 10 F Pressure Transducers in individual air-tight cavities. Equipped with 15FT, 25PR, 22-gauge single sheath plastic stub cable, talk term & spare leads.

401601851 HOUSING TRANSDUCER C WITH 6PR STUB

2631846	1	EA	IL IN MI OH WI			
			08 08 08 08 08			

CA08773. Metallic housing to accommodate one to five F Pressure Transducers in individual air-tight cavities. The housing is equipped with a 15 foot, 6 pair, 22 gauge single sheath plastic stub cable.

260442348 HYGROMETER PORTABLE BATTERY-OPERATED

N						
---	--	--	--	--	--	--

Humidity meter used to test relative humidity levels in pressurized cable. Includes sensor & carrying case.

280050683 INDICATOR FLOW DIRECTION

N		EA	1	2	1	
---	--	----	---	---	---	--

Attaches to two pressure testing valves. Used to indicate the direction of air flow in pressurized cables. NOW AVAILABLE THROUGH TOUCH-TONE ORDER ENTRY.

280054107 INTERROGATOR FLOW TD 245

N		EA	1	2	1	
---	--	----	---	---	---	--

For on-line monitoring of Mark Powered 500 Series Flow Transducers without violating the integrity of a pressurized cable plant, providing for voltage, current, and resistance readings.

280396718 KIT 1291 AIR DRYER HOOK-UP

N		KT	1	3	1	
---	--	----	---	---	---	--

With one 3/4IN Close Nipple, one 3/4IN Brass Ball Valve, two 3/4IN Nylon Hose Clamps, two 3/4IN Male Hose Adapters, one 2 X 3/4IN Reducing Bushing, and one 3/4IN X 10FT Tubing.

260396692 KIT 1293 AIR DRYER HOOK-UP EMERGENCY

N		KT	1	3	1	
---	--	----	---	---	---	--

With one 2 X 3/4IN Reducing Bushing, one Female Coupler with Male Threads, one Male Air Fitting w/Hose Shank Adapter, one 3/4IN Adapter, two 3/4IN Clamps, and 3/4IN X 10FT Tubing.

280008111 KIT CONNECTOR 3131 AMP-FIT WITH TOOL

N		EA	1	4	1	
---	--	----	---	---	---	--

Includes assortment of AMP-FIT 3131 pipe connectors and hand tool 69992.

280008061 KIT FITTING 3/8 AMP-FIT WITH TOOL

N		EA	1	6	1	
---	--	----	---	---	---	--

Contains assortment of AMP-FIT 3/8IN tubing fittings and hand tool 68317-1.

PRESSURIZATION AIR CABLE EQUIPMENT

PRODUCT IDENTIFIER DESCRIPTION

ITEM NUMBER	ORD. MULT.	SELL UNIT	STD. PKG. STOCK AVAILABILITY / PA	LEAD TIME	MIN. ORD.	A C
-------------	------------	-----------	-----------------------------------	-----------	-----------	-----

280050295 KIT MOUNTING 500 SERIES TRANSDUCER

N		EA	1	2	4	
---	--	----	---	---	---	--

An ADDITIONAL mounting kit for the Model 500 Series Flow Transducers. Mounting kits are supplied with and included in the price of the transducer.

280050329 KIT MOUNTING 550 SERIES TRANSDUCER

N		EA	1	2	5	
---	--	----	---	---	---	--

An ADDITIONAL mounting kit for the Model 550 Series Flow Transducers. Mounting kits are supplied and included in the price of the transducer.

280050535 KIT ROD ADAPTER 1801-00212

N		EA	1	2	2	
---	--	----	---	---	---	--

Rod end adapter repair kit for the Model 1801 and 1802 Duct Probes.

280050519 KIT ROD REPAIR 1801-00206

N		EA	1	2	1	
---	--	----	---	---	---	--

Used to repair the Model 1801 or 1802 duct rod.

260396650 MANIFOLD 2IN PVC 1 RACK

N		EA	1	3	1	
---	--	----	---	---	---	--

260396668 MANIFOLD 2IN PVC 2 RACK DUNLAP

N		EA	1	3	1	
---	--	----	---	---	---	--

260396676 MANIFOLD 2IN PVC 3 RACK DUNLAP

N		EA	1	3	1	
---	--	----	---	---	---	--

260396684 MANIFOLD 2IN PVC 4 RACK DUNLAP

N		EA	1	3	1	
---	--	----	---	---	---	--

401001482 MANIFOLD 3131 5-PORT

1200600	1	EA	IL	IN	MI	OH	WI
			08	08	08	08	08

Ameritech version of C manifold assembly. Connects 1-5 cables to pressurized CA3131 air supply. Inlet connection is 1/8 NPT female opening. Outlet connections are 3/8IN plastic tube fittings.

260331277 MANIFOLD FLOW 501-1-1

N		EA	1	4	1	
---	--	----	---	---	---	--

Consists of 1 Model 501 Flow Transducer, 1 Model 230A Junction Box, & 1 Five Bank Manifold.

260331301 MANIFOLD FLOW 501-1-1P

N		EA	1	4	1	
---	--	----	---	---	---	--

Consists of 1 Model 501 Flow Transducer, 1 Model 230A Junction Box, 1 Five Bank Manifold, and 1 Sparton Model 730 UG-1 Pressure Transducer.

260331335 MANIFOLD FLOW 501-1-2

N		EA	1	4	1	
---	--	----	---	---	---	--

Consists of 1 Model 501 Flow Transducer, 1 Model 230A Junction Box, & 2 Five Bank Manifolds.

PRODUCT IDENTIFIER DESCRIPTION

ITEM NUMBER	ORD. MULT.	SELL UNIT	STD. PKG. STOCK AVAILABILITY / PA	LEAD TIME	MIN. ORD.	A C
-------------	------------	-----------	-----------------------------------	-----------	-----------	-----

260331368 MANIFOLD FLOW 501-1-2P

N		EA	1	4	1	
---	--	----	---	---	---	--

Consists of 1 Model 501 Flow Transducer, 1 Model 230A Junction Box, 2 Five Bank Manifolds, & 1 Sparton Model 730 UG-1 Pressure Transducer.

260331392 MANIFOLD FLOW 501-2-2

N		EA	1	4	1	
---	--	----	---	---	---	--

Consists of 2 Model 501 Flow Transducers, 1 Model 230A Junction Box, & 2 Five Bank Manifolds.

260331426 MANIFOLD FLOW 501-2-2P

N		EA	1	4	1	
---	--	----	---	---	---	--

Consists of 2 Model 501 Flow Transducers, 1 Model 230A Junction Box, 2 Five Bank Manifolds, & 1 Sparton Model 730 UG-1 Pressure Transducer.

260331152 MANIFOLD FLOW 502-1-1

N		EA	1	4	1	
---	--	----	---	---	---	--

Consists of 1 Model 502 Flow Transducer, 1 Model 230A Junction Box, & 1 Five Bank Manifold.

260331160 MANIFOLD FLOW 502-1-1P

N		EA	1	4	1	
---	--	----	---	---	---	--

Assembly consists of 1 Model 502 Flow Transducer, 1 Model 230A Junction Box, 1 Five Bank Manifold, & 1 Sparton Model 730 UG-1 Pressure Transducer.

260331178 MANIFOLD FLOW 502-1-2

N		EA	1	4	1	
---	--	----	---	---	---	--

Assembly consists of 1 Model 502 Powered (0-20) Flow Transducer, 1 Model 230A Junction Box, & 2 Five Bank Manifolds.

260331186 MANIFOLD FLOW 502-1-2P

N		EA	1	4	1	
---	--	----	---	---	---	--

Assembly consists of 1 Model 502 Flow Transducer, 1 Model 230A Junction Box, 2 Five Bank Manifolds, & 1 Sparton Model 730 UG-1 Pressure Transducer.

260331194 MANIFOLD FLOW 502-2-2

N		EA	1	4	1	
---	--	----	---	---	---	--

Consists of 2 Model 502 Flow Transducers, 1 Model 230A Junction Box, & 2 Five Bank Manifolds.

260331202 MANIFOLD FLOW 502-2-2P

N		EA	1	4	1	
---	--	----	---	---	---	--

Consists of 2 Model 502 Flow Transducers, 1 Model 230A Junction Box, 2 Five Bank Manifolds, & 1 Sparton Model 730 UG-1 Pressure Transducer.

260331285 MANIFOLD FLOW 503-1-1

N		EA	1	4	1	
---	--	----	---	---	---	--

Consists of 1 Model 503 Flow Transducer, 1 Model 230A Junction Box, & 1 Five Bank Manifold.

260331319 MANIFOLD FLOW 503-1-1P

N		EA	1	4	1	
---	--	----	---	---	---	--

Consists of 1 Model 503 Flow Transducer, 1 Model 230A Junction Box, 1 Five Bank Manifold, & 1 Sparton Model 730 UG-1 Pressure Transducer.

DISTRIBUTION SERVICES

NETWORK SERVICES

TOOLS

BUILDING JANITORIAL

AUTOMOTIVE

FORMS/OFFICE SUPPLIES

GENERAL

DATA VOICE

DISTRIBUTION SERVICES
 NETWORK SERVICES
 TOOLS
 BUILDING JANITORIAL
 AUTOMOTIVE
 FORMS/OFFICE SUPPLIES
 GENERAL
 DATA VOICE

PRESSURIZATION AIR CABLE EQUIPMENT

PRODUCT IDENTIFIER		DESCRIPTION					
ITEM NUMBER	ORD. MULT.	SELL UNIT	STD. PKG. STOCK AVAILABILITY / PA	LEAD TIME	MIN. ORD.	A C	
260331343 MANIFOLD FLOW 503-1-2							
N		EA	1	4	1		
Consists of 1 Model 503 Flow Transducer, 1 Model 230A Junction Box, & 2 Five Bank Manifolds.							
260331376 MANIFOLD FLOW 503-1-2P							
N		EA	1	4	1		
Consists of 1 Model 503 Flow Transducer, 1 Model 230A Junction Box, 2 Five Bank Manifolds, & 1 Sparton Model 730 UG-1 Pressure Transducer.							
260331400 MANIFOLD FLOW 503-2-2							
N		EA	1	4	1		
Consists of 2 Model 503 Flow Transducers, 1 Model 230A Junction Box, & 2 Five Bank Manifolds.							
260331434 MANIFOLD FLOW 503-2-2P							
N		EA	1	4	1		
Consists of 2 Model 503 Flow Transducers, 1 Model 230A Junction Box, 2 Five Bank Manifolds, & 1 Sparton Model 730 UG-1 Pressure Transducer..							
260331293 MANIFOLD FLOW 505-1-1							
N		EA	1	4	1		
Consists of 1 Model 505 Flow Transducer, 1 Model 230A Junction Box, & 1 Five Bank Manifold.							
260331327 MANIFOLD FLOW 505-1-1P							
N		EA	1	4	1		
Consists of 1 Model 505 Flow Transducer, 1 Model 230A Junction Box, 1 Five Bank Manifold, & 1 Sparton Model 730 UG-1 Pressure Transducer..							
260331350 MANIFOLD FLOW 505-1-2							
N		EA	1	4	1		
Consists of 1 Model 505 Flow Transducer, 1 Model 230A Junction Box, & 2 Five Bank Manifolds.							
260331384 MANIFOLD FLOW 505-1-2P							
N		EA	1	4	1		
Consists of 1 Model 505 Flow Transducer, 1 Model 230A Junction Box, 2 Five Bank Manifolds, & 1 Sparton Model 730 UG-1 Pressure Transducer.							
260331418 MANIFOLD FLOW 505-2-2							
N		EA	1	4	1		
Consists of 2 Model 505 Flow Transducers, 1 Model 230A Junction Box, & 2 Five Bank Manifolds.							
260331442 MANIFOLD FLOW 505-2-2P							
N		EA	1	4	1		
Consists of 2 Model 505 Flow Transducers, 1 Model 230A Junction Box, 2 Five Bank Manifolds, & 1 Sparton Model 730 UG-1 Pressure Transducer.							
260331459 MANIFOLD FLOW 551-1-1							
N		EA	1	4	1		
Consists of 1 Model 551 Flow Transducer, 1 Model 230A Junction Box, & 1 Five Bank Manifold.							

PRODUCT IDENTIFIER		DESCRIPTION					
ITEM NUMBER	ORD. MULT.	SELL UNIT	STD. PKG. STOCK AVAILABILITY / PA	LEAD TIME	MIN. ORD.	A C	
260331483 MANIFOLD FLOW 551-1-1P							
N		EA	1	4	1		
Consists of 1 Model 551 Flow Transducer, 1 Model 230A Junction Box, 1 Five Bank Manifold, & 1 Sparton Model 730 UG-1 Pressure Transducer.							
260331517 MANIFOLD FLOW 551-1-2							
N		EA	1	4	1		
Consists of 1 Model 551 Flow Transducer, 1 Model 230A Junction Box, & 2 Five Bank Manifolds.							
260331541 MANIFOLD FLOW 551-1-2P							
N		EA	1	4	1		
Consists of 1 Model 551 Flow Transducer, 1 Model 230A Junction Box, 2 Five Bank Manifolds, & 1 Sparton Model 730 UG-1 Pressure Transducer.							
260331574 MANIFOLD FLOW 551-2-2							
N		EA	1	4	1		
Consists of 2 Model 551 Flow Transducers, 1 Model 230A Junction Box, & 2 Five Bank Manifolds.							
260331608 MANIFOLD FLOW 551-2-2P							
N		EA	1	4	1		
Consists of 2 Model 551 Flow Transducers, 1 Model 230A Junction Box, 2 Five Bank Manifolds, & 1 Sparton Model 730 UG-1 Pressure Transducer.							
260331210 MANIFOLD FLOW 552-1-1							
N		EA	1	4	1		
Assembly consists of 1 Model 552 Non-powered (0-20) Flow Transducer, 1 Model 230A Junction Box, & 1 Five Bank Manifold.							
260331228 MANIFOLD FLOW 552-1-1P							
N		EA	1	4	1		
Assembly consists of 1 Model 552 Non-powered (0-20) Flow Transducer, 1 Model 230A Junction Box, 1 Five Bank Manifold, & 1 Sparton Model 730 UG-1 Pressure Transducer.							
260331236 MANIFOLD FLOW 552-1-2							
N		EA	1	4	1		
Assembly consists of 1 Model 552 Non-powered (0-20) Flow Transducer, 1 Model 230A Junction Box, and 2 Five Bank Manifolds.							
260331244 MANIFOLD FLOW 552-1-2P							
N		EA	1	4	1		
Assembly consists of 1 Model 552 Non-powered (0-20) Flow Transducer, 1 Model 230A Junction Box, 2 Five Bank Manifolds, & 1 Sparton Model 730 UG-1 Pressure Transducer.							
260331251 MANIFOLD FLOW 552-2-2							
N		EA	1	4	1		
Consists of 2 Model 552 Flow Transducers, 1 Model 230A Junction Box, & 2 Five Bank Manifolds.							
260331269 MANIFOLD FLOW 552-2-2P							
N		EA	1	4	1		
Consists of 2 Model 552 Flow Transducers, 1 Model 230A Junction Box, 2 Five Bank Manifolds, & 1 Sparton Model 730 UG-1 Pressure Transducer.							

PRESSURIZATION AIR CABLE EQUIPMENT

PRODUCT IDENTIFIER		DESCRIPTION				
ITEM NUMBER	ORD. MULT.	SELL UNIT	STD. PKG. STOCK AVAILABILITY / PA	LEAD TIME	MIN. ORD.	A C
260331467 MANIFOLD FLOW 553-1-1						
N		EA	1	4	1	
Consists of 1 Model 553 Flow Transducer, 1 Model 230A Junction Box, & 1 Five Bank Manifold.						
260331491 MANIFOLD FLOW 553-1-1P						
N		EA	1	4	1	
Consists of 1 Model 553 Flow Transducer, 1 Model 230A Junction Box, 1 Five Bank Manifold, & 1 Sparton Model 730 UG-1 Pressure Transducer.						
260331525 MANIFOLD FLOW 553-1-2						
N		EA	1	4	1	
Consists of 1 Model 553 Flow Transducer, 1 Model 230A Junction Box, & 2 Five Bank Manifolds.						
260331558 MANIFOLD FLOW 553-1-2P						
N		EA	1	4	1	
Consists of 1 Model 553 Flow Transducer, 1 Model 230A Junction Box, 2 Five Bank Manifolds, & 1 Sparton Model 730 UG-1 Pressure Transducer.						
260331582 MANIFOLD FLOW 553-2-2						
N		EA	1	4	1	
Consists of 1 Model 553 Flow Transducer, 1 Model 230A Junction Box, & 2 Five Bank Manifolds.						
260331616 MANIFOLD FLOW 553-2-2P						
N		EA	1	4	1	
Consists of 2 Model 553 Flow Transducers, 1 Model 230A Junction Box, 2 Five Bank Manifolds, & 1 Sparton Model 730 UG-1 Pressure Transducer.						
260331475 MANIFOLD FLOW 555-1-1						
N		EA	1	4	1	
Consists of 1 Model 555 Flow Transducer, 1 Model 230A Junction Box, & 1 Five Bank Manifold.						
260331509 MANIFOLD FLOW 555-1-1P						
N		EA	1	4	1	
Consists of 1 Model 555 Flow Transducer, 1 Model 230A Junction Box, 1 Five Bank Manifold, & 1 Sparton Model 730 UG-1 Pressure Transducer.						
260331533 MANIFOLD FLOW 555-1-2						
N		EA	1	4	1	
Consists of 1 Model 555 Flow Transducer, 1 Model 230A Junction Box, & 2 Five Bank Manifolds.						
260331566 MANIFOLD FLOW 555-1-2P						
N		EA	1	4	1	
Consists of 1 Model 555 Flow Transducer, 1 Model 230A Junction Box, 2 Five Bank Manifolds, & 1 Sparton Model 730 UG-1 Pressure Transducer.						
260331590 MANIFOLD FLOW 555-2-2						
N		EA	1	4	1	
Consists of 2 Model 555 Flow Transducers, 1 Model 230A Junction Box, & 2 Five Bank Manifolds.						

PRODUCT IDENTIFIER		DESCRIPTION				
ITEM NUMBER	ORD. MULT.	SELL UNIT	STD. PKG. STOCK AVAILABILITY / PA	LEAD TIME	MIN. ORD.	A C
260331624 MANIFOLD FLOW 555-2-2P						
N		EA	1	4	1	
Consists of 2 Model 555 Flow Transducers, 1 Model 230A Junction Box, 2 Five Bank Manifolds, and 1 Sparton Model 730 UG-1 Pressure Transducer.						
260345806 PANEL BLANK 2IN X 23IN 30574						
N		EA	1	3	1	
Used to cover open spaces on new or upgraded rack assemblies.						
260345798 PANEL BLANK 5IN X 23IN 30575						
N		EA	1	3	1	
Used to cover open spaces on new or upgraded rack assemblies.						
260345780 PANEL BLANK 7IN X 23IN 47643-2						
N		EA	1	3	1	
Used to cover open spaces on new or upgraded rack assemblies.						
260431937 PANEL DISTRIBUTION TYPE DA						
N		EA	1		1	
W/Flow Transducer 0-50, non-powered.						
260430186 PANEL DISTRIBUTION (TYPE DA) 7 X 23IN						
N		EA	1		1	
With non-powered SCFH Flow Transducer (0-20). Provides dry air from 1 source to a maximum of 10 indiv. cables. E/W press. regulator, input shutoff&press test valve, press. gauge & 10 bank flowrater.						
260430194 PANEL DISTRIBUTION (TYPE DB) 7 X 23IN						
N		EA	1		1	
With powered SCFH Flow Transducer (0-20). Provides dry air from 1 source to a maximum of 10 indiv. cables. E/W a pressure regulator, input shutoff&press testing valve, press. gauge&10 bank flowrater.						
260430202 PANEL DISTRIBUTION (TYPE DC) 7 X 23IN						
N		EA	1		1	
With powered SCFH Flow Transducer (0-50). Provides dry air from 1 source to a maximum of 10 indiv. cables. E/W a pressure regulator, input shutoff&press testing valve, press. gauge&10 bank flowrater.						
260430210 PANEL DISTRIBUTION (TYPE DD) 7 X 23IN						
N		EA	1		1	
With powered SCFH Flow Transducer (0-20). Provides dry air from 1 source to a maximum of 10 indiv. cables. E/W input shutoff&press testing valve, press. gauge & 10 bank flowrater. No press. regulator.						
260435987 PANEL E/W BLOCK CONNECTOR 66 M-1-50						
N		EA	1		1	
A blank 7 X 23IN panel equipped with a 66 M-1-50 punch down connecting block. Used to cross-connect powered or non-powered transducers to remote air pressure monitoring devices.						
260432364 PANEL PIPE MODULAR DUAL TYPE PB						
N						
W/Flow Transducer 0-50, non-powered.						

DISTRIBUTION SERVICES

NETWORK SERVICES

TOOLS

BUILDING JANITORIAL

AUTOMOTIVE

FORMS/OFFICE SUPPLIES

GENERAL

DATA VOICE

DISTRIBUTION SERVICES

NETWORK SERVICES

TOOLS

BUILDING JANITORIAL

AUTOMOTIVE

FORMS/OFFICE SUPPLIES

GENERAL

DATA VOICE

PRESSURIZATION AIR CABLE EQUIPMENT

PRODUCT IDENTIFIER		DESCRIPTION				
ITEM NUMBER	ORD. MULT.	SELL UNIT	STD. PKG. STOCK AVAILABILITY / PA	LEAD TIME	MIN. ORD.	A C
260432372			PANEL PIPE MODULAR DUAL TYPE PD			
N			W/Flow Transducer 0-50, powered.			
260432380			PANEL PIPE MODULAR DUAL TYPE PF			
N			W/Flow Transducer 0-100, powered.			
260431952			PANEL PIPE MODULAR SINGLE TYPE PAA			
N		EA	1		1	
			W/Flow Transducer 0-100, non-powered.			
260430152			PANEL PIPE MODULAR SINGLE (TYPE PA)			
N		EA	1		1	
			7 X 23IN. Provides continuous pressure regulated air flow from the C/O air dryer to the CA3131 air pipe. Each panel supplies 1 air pipe leaving office. E/W 1 non-powered flow transducer (0-50 SCFH).			
260430160			PANEL PIPE MODULAR SINGLE (TYPE PC)			
N		EA	1		1	
			7 X 23IN. Provides continuous press reg air flow from the C/O air dryer to the CA3131 air pipe. Each panel supplies 1 air pipe leaving office. E/W 1 powered flow transducer (0-50 SCFH) w/tee (plugged)			
260430178			PANEL PIPE MODULAR SINGLE (TYPE PE)			
N		EA	1		1	
			7 X 23IN. Provides continuous press reg air flow from the C/O air dryer to the CA3131 air pipe. Each panel supplies 1 air pipe leaving office. E/W 1 powered flow transducer (0-100 SCFH) w/press trans.			
401078712			PIPE AIR LEAD CA-1520			
N		FT	1	2	1	
			Extruded lead - antimony pipe with polyethylene jacket. Nominal dimensions: 1/4IN I.D., 1/2IN lead O.D., 0.63 total O.D.			
102930955			PIPE GAS FEEDER CA03131-001			
1225607	1	FT	IL IN MI OH WI 08 08 15 15 15			
			Aluminum line pipe used in cable pressurization systems for distributing dry air from the C.O., BSP 637-050-100, BSP 637-050-200, BSP 637-050-300 .			
102930963			PIPE GAS FEEDER CA03131-001 UM			
1938019	1	FT	IL IN MI OH WI 08 08 15 15 15			
			Aluminum line pipe, reinforced w/outer protection, used in cable pressurization systems for distributing dry air from the C.O. in buried applications.			
102739505			PIPE GAS FEEDER CA03131-002			
N		FT	1	6	2000	
102933280			PIPE GAS FEEDER CA03131-002 UM			
N		FT	1	6	2000	
102740776			PIPE GAS FEEDER CA03131-003			
N		FT	1	6	2000	
102933298			PIPE GAS FEEDER CA03131-003 UM			
N		FT	1	6	2000	

PRODUCT IDENTIFIER		DESCRIPTION				
ITEM NUMBER	ORD. MULT.	SELL UNIT	STD. PKG. STOCK AVAILABILITY / PA	LEAD TIME	MIN. ORD.	A C
102739620			PIPE GAS FEEDER CA03131-004			
N		FT	1	6	2000	
102933306			PIPE GAS FEEDER CA03131-004 UM			
N		FT	1	6	2000	
260430228			PIPE GAS FEEDER CA3131 W/LEAD SHEATH			
N		FT	4900	4	4900	
			Aluminum lined pipe w/lead sheath used in cable pressurization systems for distributing dry air below ground in petroleum contaminated areas. Use with AMP-FIT fittings only.			
400320578			PLUG FLANGE PRESSURE CA07548			
1189290	1	PK	IL IN MI OH WI 08 08 08 08 08			
			Used to seal pressure flanges having a female 1/8 NPT thread (brass).			
280050717			PROBE HAND REPLACEMENT 1805-00220			
N		EA	1	2	1	
			Included with the 1805 Multisonic Translator/Detector. The probe is 6IN long with a diameter of 1.3IN. A 6FT coil cord is provided with the probe.			
260360979			PROBE MINI DUCT 1802D			
N		EA	1	2	1	
			Has same features as the Model 1801, in a lighter, more compact, portable unit. 300FT X 3/8IN rod. Includes an interconnect cable, dummy probe tip, and Distance Measuring Equipment (DME).			
260338603			RACK EQUIPMENT 23-84-T2-SE			
N		EA	1	4	1	
			Homaco. Used for mounting pipe panels & distribution panels in central offices. Has bolted construction, brushed alum finish, 23 X 84IN HIGH, 1/2IN center mounting holes on both sides, selfsupport base			
260432174			RACK PIPE PANEL/DISTRIBUTION PANEL			
N		EA	1		1	
			7FT equipment rack e/w a connecting block panel and 2IN PVC manifold. 23 X 84IN High with a 3 1/2 X 6FT self-support base. Top brace is 1.5X1.5IN extruded angle. Sides are drilled & tapped on 1/2IN ctrs			

PRODUCT IDENTIFIER DESCRIPTION

ITEM	ORD.	SELL	STD. PKG.	LEAD TIME	MIN.	A
NUMBER	MULT.	UNIT	STOCK AVAILABILITY / PA	ORD.	ORD.	C

400218426 REGULATOR TEST PRESSURE C						
1163535	1	EA	IL IN MI OH WI			E
			12 12 12 12 12			

Controls the outlet pressure from nitrogen or helium gas cylinders in cable pressurization operations. Equipped with low pressure gauge (0-50 PSI) and high pressure gauge.

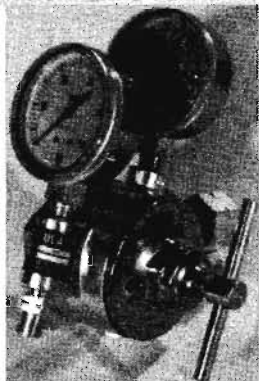

1163535

280050741 STRAP CARRYING 4200-00187						
N		EA	1	2		8

280050493 TIP DUMMY PROBE 1801-00202						
N		EA	1	2		3
Protects the end of the Model 1801 rod when the microphone probe tip is not in use.						

280050477 TIP MULTISONIC PROBE 1801-00198						
N		EA	1	2		1
Detects and pinpoints air leaks in ducted cables. It senses leaks from 100 Hz to 100 KHz when used with a Mark Model 1801 Duct Probe and Model 1805 Translator/Detector.						

280050485 TIP UG COIL PROBE 1801-00199						
N		EA	1	2		1
Underground Exploring Coil Probe Tip helps technicians pinpoint troublesome cable faults by locating shorts, crosses, and grounds.						

260302070 TOOL HAND AMP-FIT 3131 AIR PIPE 69992						
1938944	1	EA	IL IN MI OH WI			E
			12 12 12 12 12			
Used to crimp AMP-FIT connectors to CA-3131 air pipe.						

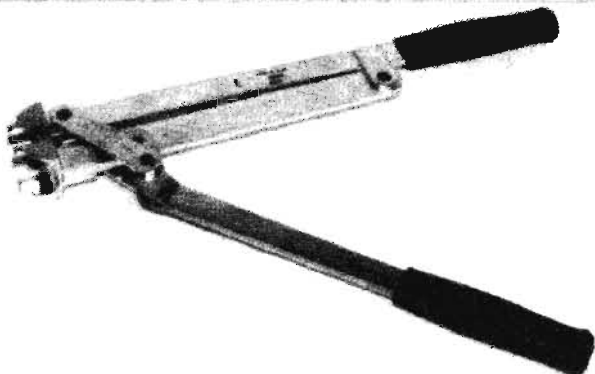

1938944

PRODUCT IDENTIFIER DESCRIPTION

ITEM	ORD.	SELL	STD. PKG.	LEAD TIME	MIN.	A
NUMBER	MULT.	UNIT	STOCK AVAILABILITY / PA	ORD.	ORD.	C

280006990 TOOL HAND AMP-FIT 3/8IN TUBING 69671-0						
N		EA	1	2		1
Used to crimp AMP-FIT fittings to 3/8IN tubing.						

300068632 TRANSDUCER FLOW 501						
5124511	1	EA	IL IN MI OH WI			
			08 08 08 08			
Monitors air flow from 0-10 SCFH (240 SCFD). Requires power pair in addition to read pair.						

402755870 TRANSDUCER FLOW 502						
1153593	1	EA	IL IN MI OH WI			
			08 08 08 08 08			
Monitors air flow from 0-20 SCFH (480 SCFD). Requires power pair in addition to read pair.						

300068657 TRANSDUCER FLOW 503						
5124537	1	EA	IL IN MI OH WI			
			08 08 08 08			
Monitors air flow from 0-50 SCFH (1200 SCFD). Requires power pair in addition to read pair.						

300068665 TRANSDUCER FLOW 505						
5124545	1	EA	IL IN MI OH WI			
			08 08 08 08			
Monitors air flow from 0-100 SCFH (2400 SCFD). Requires power pair in addition to read pair.						

260402953 TRANSDUCER FLOW 506						
N		EA	1			1

280050238 TRANSDUCER FLOW 551						
N		EA	1	2		1
Monitors air flow from 0-10 SCFH (240 SCFD). Does not require power pair.						

280050246 TRANSDUCER FLOW 552						
1948299	1	EA	IL IN MI OH WI			
			08 08 08 08			
Monitors air flow from 0-20 SCFH (480 SCFD). Does not require power pair.						

280050253 TRANSDUCER FLOW 553						
1948307	1	EA	IL IN MI OH WI			
			08 08 08 08			
Monitors air flow from 0-50 SCFH (1200 SCFD). Does not require power pair.						

280050261 TRANSDUCER FLOW 555						
N		EA	1	2		1
Monitors air flow from 0-100 SCFH (2400 SCFD). Does not require power pair.						

260402961 TRANSDUCER FLOW 556						
N		EA	1	2		1
Mark Products.						

280038654 TRANSDUCER PRESSURE 730 CME						
N		EA	1	3		2
Underground transducer for installation in 733.10 canisters already in place. SOE discontinued for new installations. See Transducer Pressure F.						

DISTRIBUTION SERVICES

NETWORK SERVICES

TOOLS

BUILDING JANITORIAL

AUTOMOTIVE

FORMS/OFFICE SUPPLIES

GENERAL

DATA VOICE

DISTRIBUTION SERVICES

NETWORK SERVICES

TOOLS

BUILDING JANITORIAL

AUTOMOTIVE

FORMS/OFFICE SUPPLIES

GENERAL

DATA VOICE

PRESSURIZATION AIR CABLE EQUIPMENT

PRODUCT IDENTIFIER		DESCRIPTION						
ITEM NUMBER	ORD. MULT.	SELL UNIT	STD. PKG.	LEAD TIME	MIN. ORD.	A	C	
			STOCK AVAILABILITY / PA					
400280368 TRANSDUCER PRESSURE C CA08311								
2308189	1	EA	IL 08	IN 08	MI 08	OH 08	WI 08	
Connected to aerial cable and electrically connected to an assigned working cable pair at a distribution cable terminal for monitoring of aerial cable pressure.								
401601547 TRANSDUCER PRESSURE F CA08772								
N		EA	1	4		2		
For remote monitoring of air pressure in the range of 0.0 to 9.5 PSI in 0.5 PSI increments. The F transducer must be installed in a C Pressure Transducer Housing.								
280002866 TRANSDUCER PRESSURE G-TYPE								
N		EA	1	3		2		
Self-contained unit which consists of an F Pressure Transducer attached to a mounting plate. Used in single install. 0-9.5 PSI Range A. Has B Fitting for 3/8IN plastic tubing. Without tubing.								
260432182 TRANSDUCER PRESSURE G-TYPE								
N		EA	1	3		1		
Self-contained unit which consists of an F Pressure Transducer attached to a mounting plate. Used in single installations. 0-9.5 PSI, Range A. Separate pressure input & sealed cable assy. W/O tubing.								
401601562 TRANSDUCER PRESSURE H CA08772								
N		EA	1	4		1		
Consists of an F transducer equipped with a wider flange at the base that allows the transducer to be installed in the B transducer housing. Measures air pressure flow in underground cable.								
300052719 TRANSDUCER PRESSURE MINI-F								
6509703	1	EA	IL 08	IN 08	MI 08	OH 08	WI 08	
For mounting on Chatlos TH5 or TH10 bank housing with 1.75IN hole spacing. Electrical output identical to F Pressure Transducer. For underground or aerial applications.								
300069119 TRANSDUCER PRESSURE PANEL								
5124552	1	EA	IL 08	IN 08	MI 08	OH 08	WI 08	
730 PME-1-A (or equivalent) with 15FT wire leads for inside installations. 5-14.5 PSI.								
400330189 TUBING C PLASTIC 3/8IN X 1 TUBE								
1283366	700	FT	IL 08	IN 08	MI 08	OH 08	WI 08	
CA08063 - 700 Maximum feet per reel. Provides air flow between air pressure devices that have 3/8IN tube fittings.								
400330213 TUBING C PLASTIC 3/8IN X 10 TUBES								
1128330	1	FT	IL 18	IN 18	MI 18	OH 18	WI 18	
Ten bundled tubes provides air flow between air pressure devices that have 3/8IN tube fittings.								
001123413 VALVE AIR FLOW CHECK								
5263301	1	EA	IL 08	IN 08	MI 08	OH 08	WI 08	
Allows free flow of air from manifold to cable. Prevents backflow of air. Mounts on 1/8 NPT female opening. Connects to 3/8IN tubing.								

PRODUCT IDENTIFIER		DESCRIPTION						
ITEM NUMBER	ORD. MULT.	SELL UNIT	STD. PKG.	LEAD TIME	MIN. ORD.	A	C	
			STOCK AVAILABILITY / PA					
400284683 VALVE AIR REPAIR TR15								
1289603	1	EA	IL 08	IN 08	MI 08	OH 08	WI 08	
Used when providing a temporary protective covering over incomplete splices. Allows gas admission and pressure testing. Replaces oval base repair valve which is M/D. See BSP 633-040-201.								
400959763 VALVE BYPASS 3/8IN								
1148674	1	EA	IL 08	IN 08	MI 08	OH 08	WI 08	
Solid brass, cadmium plated, with stainless steel bonnet assembly, shut-off valve, connectors at each end for 3/8IN tubing, and two pressure testing valves.								
001123421 VALVE CHECK CONTROLLED FLOW								
5283327	1	EA	IL 08	IN 08	MI 08	OH 08	WI 08	
Allows free flow of air from manifold to cable. Constricts backflow to approximately 3/4 to 1 SCFH. Mounts on 1/8 NPT female opening. Connects to 3/8IN tubing.								
280007998 VALVE GLOBE 3/8 TUBE AMP-FIT 581306-1								
N		EA	1	6		1		
Connects two wnds of 3/8IN plastic tubing and provides a shut-off capability.								
300080058 VALVE HIGH 3/8 INCH - 1 PORT								
5124917	1	EA	IL 08	IN 08	MI 08	OH 08	WI 08	
Designed to facilitate a quick, easy-to-install, pressure test point in the manhole neck or on riser pole, where 3/8IN tubing is used.								
260430236 VALVE HIGH 3/8 INCH - 2 PORT								
N		EA	1	1		1		
Designed to facilitate a quick, easy to install, pressure test point in the manhole neck or on the riser pole, where 3/8IN tubing is used.								
300052156 VALVE HIGH 3/8 INCH - 5 PORT								
1155911	1	EA	IL 08	IN 08	MI 08	OH 08	WI 08	
Designed to facilitate a quick, easy to install, pressure test point in the manhole neck or on the riser pole, where 3/8IN tubing is used.								
260396627 VALVE HIGH FLOW FINDER MODEL 3010								
N		EA	1	1		1		
Enables air flow measurements to be taken from flow finders that are placed in hard-to-reach locations, such as the bottom of a manhole or on an aerial pipe. Consists of hi valve & custom fittings.								
400284709 VALVE PRESSURE TEST C								
N		PK	1	4		14		
Provides a permanent gas admission and pressure reading point on cables maintained under continuous pressure, package of 5. BSP 637-235-100.								
996147401 VALVE PRESSURE TESTING F								
1289686	1	PK	IL 08	IN 08	MI 08	OH 08	WI 08	
Provides gas admission and pressure reading points for cables under pressure. Mounts on 1/8 NPT female openings.								

PRESSURIZATION AIR DRYER

PRODUCT IDENTIFIER		DESCRIPTION					
ITEM NUMBER	ORD. MULT.	SELL UNIT	STD. PKG. STOCK AVAILABILITY / PA	LEAD TIME	MIN. ORD.	A	C
400284733 VALVE PRESSURE TESTING P CA06914							
N		EA	1	4	1		
900418385 VALVE PRESSURE TESTING SHORT							
5392225		EA	IL IN MI OH WI 08				
Provides gas admission and pressure reading points for cables under pressure. Mounts on 1/8 NPT female openings. Special short length for hard-to-get-at places. Previously called 420S.							
401761358 VALVE SHUTOFF C CA08779							
2672668	1	EA	IL IN MI OH WI 08 08 08 08				
For use between air pipe and manifold, BSP 637-050-100.							
002055044 VALVE SHUT-OFF 3131 AMP-FIT							
4206060	1	EA	IL IN MI OH WI 08 08 08 08				
Provides a readily accessible test or isolation point in the air pipe. Includes an F valve test point on each side of the shut-off valve.							
300080165 VALVE SHUT-OFF 3131 METAL							
1120394	1	EA	IL IN MI OH WI 08 08 08 08				
Provides a readily accessible test or isolation point in the air pipe. Includes an F valve test point on each side of the shut-off valve. Cadmium-plated brass construction.							

PRESSURIZATION AIR DRYER

280000852 ALTERNATOR AIR DRYER 99234/99250							
N		EA	1	3	1		
In the Alternate mode, designed to cycle on a 24-Hr basis in dual McIntire air dryer installations(8,12,17,25000). In Transfer mode, dryers are cycled manually. Full backup cap. if dryer malfunctions.							
260372677 ALTERNATOR AIR DRYER P-08033-G2							
N		EA	1	3	1		
Cycles 2 Air Dryers. Operates a comb. of Puregas (8,12,16,24000) & non-Puregas dryers. Optional mode selection: 16hr, 24hr, 7-day & standby. Auto start of standby dryer if on-line dryer alarm rings.							
260372685 ALTERNATOR AIR DRYER P-08033-G3							
N		EA	1	3	1		
Cycles 3 Air Dryers. Operates a comb. of Puregas (8,12,16,24000) & non-Puregas dryers. Optional mode selection: 16hr, 24hr, 7-day & standby. Auto start of standby dryer if on-line dryer alarm rings.							
260372693 ALTERNATOR AIR DRYER P-08033-G4							
N		EA	1	3	1		
Cycles 4 Air Dryers. Operates a comb. of Puregas (8,12,16,24000) & non-Puregas dryers. Optional mode selection: 16hr, 24hr, 7-day & standby. Auto start of standby dryer if on-line dryer alarm rings.							
300004934 DRYER AIR C/O MCINTIRE 8000XE							
N		EA	1	3	1		

PRODUCT IDENTIFIER		DESCRIPTION					
ITEM NUMBER	ORD. MULT.	SELL UNIT	STD. PKG. STOCK AVAILABILITY / PA	LEAD TIME	MIN. ORD.	A	C
280038050 DRYER AIR C/O MCINTIRE 12000XE							
N		EA	1	3	1		
300004959 DRYER AIR C/O MCINTIRE 17000XE							
N		EA	1	3	1		
300004967 DRYER AIR C/O MCINTIRE 25000XE							
N		EA	1	3	1		
260344742 DRYER AIR C/O MCINTIRE CAD-5000							
N		EA	1	3	1		
300004991 DRYER AIR C/O MCINTIRE HDS-2500							
N		EA	1	3	1		
260344726 DRYER AIR C/O MCINTIRE PAD-2500							
N		EA	1	3	1		
Pole Mounted.							
300003969 DRYER AIR C/O PUREGAS P- 4200DCO							
N		EA	1	3	1		
Digital Central Office.							
300003944 DRYER AIR C/O PUREGAS P- 5000D							
N		EA	1	3	1		
260433321 DRYER AIR C/O PUREGAS P-10000DCO							
N		EA	1	3	1		
260433339 DRYER AIR C/O PUREGAS P-15000DCO							
N		EA	1	3	1		
260432190 DRYER AIR C/O PUREGAS P-20000D							
N		EA	1	3	1	1	
260432208 DRYER AIR C/O PUREGAS P-30000D							
N		EA	1	3	1		
300003993 DRYER AIR EMERGENCY PUREGAS P- 8542-A							
N		EA	1	3	1		
300004025 DRYER AIR EMERGENCY PUREGAS P- 9400-LV							
N		EA	1	3	1		
Emergency Heatless 9400 SCFD 208-230/1/60.							
300004009 DRYER AIR PUREGAS P-4200-STD							
N		EA	1	3	1		
Pole-mounted Indoor/Outdoor.							
260397633 FLOWMETER 12301							
N		EA	1	1	1		
8/18/25, McIntire Air Dryer Part/Acces.							
260397641 FLOWMETER 12315							
N		EA	1	1	1		
5000, McIntire Air Dryer Part/Acces.							
260397948 FUSE 79341 1 AMP							
N		EA	1	1	1		
McIntire Air Dryer Part/Acces.							
260413307 MOTOR 10112 COMPRESSOR EMC-02 2HP							
N		EA	1	3	1		
8/17, McIntire Air Dryer Part/Acces.							

DISTRIBUTION SERVICES

NETWORK SERVICES

TOOLS

BUILDING JANITORIAL

AUTOMOTIVE

FORMS/OFFICE SUPPLIES

GENERAL

DATA VOICE

DISTRIBUTION SERVICES

PRESSURIZATION AIR DRYER

PRODUCT IDENTIFIER		DESCRIPTION				
ITEM NUMBER	ORD. MULT.	SELL UNIT	STD. PKG. STOCK AVAILABILITY / PA	LEAD TIME	MIN. ORD.	A C
260398078		SCREEN 1121	WATER STRAINER			
N		EA	1	1	1	
			17/25, McIntire Air Dryer Part/Acces.			

NETWORK SERVICES

PRESSURIZATION AIR DRYER PARTS

260398714		ASSEMBLY 10401	INTAKE FILTER			
N		EA	1	1	1	
			McIntire Air Dryer Part/Acces..			

260398797		ASSEMBLY 10427	PISTON ROD & BEARING			
N		EA	1	1	1	
			1/2 HP, 50LB, McIntire Air Dryer Part/Acces.			

TOOLS

260398805		ASSEMBLY 10428	PISTON ROD & BEARING			
N		EA	1	1	1	
			3/4 HP, 50LB, McIntire Air Dryer Part/Acces.			

260398813		ASSEMBLY 10429	PISTON ROD & BEARING			
N		EA	1	1	1	
			1/2 HP, 100LB, McIntire Air Dryer Part/Acces.			

BUILDING JANITORIAL

260398821		ASSEMBLY 10430	PISTON ROD & BEARING			
N		EA	1	1	1	
			3/4 HP, 100LB, McIntire Air Dryer Part/Acces.			

260398318		ASSEMBLY 21601	PLUG NUT & BONNET			
N		EA	1	1	1	
			McIntire Air Dryer Part/Acces.			

AUTOMOTIVE

260398649		ASSEMBLY 40443	OUTLET CHECK VALVE			
N		EA	1	1	1	
			McIntire Air Dryer Part/Acces.			

260397427		ASSEMBLY 70136	RACK			
N		EA	1	3	1	
			With 10 CTP-10 Cable Transducer Panels, McIntire Air Dryer Part/Acces.			

FORMS/OFFICE SUPPLIES

260398755		BLADE 10415	FAN			
N		EA	1	1	1	
			McIntire Air Dryer Part/Acces.			

260398367		CABLE 26717	HUMISTAT SENSOR			
N		EA	1	1	1	
			McIntire Air Dryer Part/Acces.			

280026915		CANISTER 73310	ASSEMBLY EMPTY			
N		EA	1	1	1	
			Range A.			

GENERAL

260398847		CAPACITOR 10437	MOTOR			
N		EA	1	1	1	
			McIntire Air Dryer Part/Acces.			

280020447		COMPRESSOR AIR G033L				
N		EA	1	2	1	E

300085503		COMPRESSOR AIR G050L				
N		EA	1	3	1	E

DATA VOICE

280020439		COMPRESSOR AIR G075L				
N		EA	1	2	1	E

PRODUCT IDENTIFIER		DESCRIPTION				
ITEM NUMBER	ORD. MULT.	SELL UNIT	STD. PKG. STOCK AVAILABILITY / PA	LEAD TIME	MIN. ORD.	A C

260398227		CONTACTOR 20502	MOTOR			
N		EA	1	1	1	
			17/25, McIntire Air Dryer Part/Acces.			

260398458		CONTACTOR 99346	POWER 2			
N		EA	1	1	1	
			17/25, McIntire Air Dryer Part/Acces.			

260398235		CONTROL 20907	HUMIDITY FAIL SAFE			
N		EA	1	1	1	
			McIntire Air Dryer Part/Acces.			

260397773		CONTROL 25401	TIME DELAY			
N		EA	1	3	1	
			Comp override, McIntire Air Dryer Part/Acces.			

260398581		CORD POWER 55066				
N		EA	1	1	1	
			McIntire Air Dryer Part/Acces.			

260398839		CYLINDER 10431				
N		EA	1	1	1	
			McIntire Air Dryer Part/Acces.			

260398375		DIRECTOR 40244	AIR 8/17			
N		EA	1	1	1	
			McIntire Air Dryer Part/Acces.			

260398383		DIRECTOR 40245	AIR 12/25			
N		EA	1	1	1	
			McIntire Air Dryer Part/Acces.			

260398243		ELEMENT 20908	SENSOR FAIL SAFE			
N		EA	1	1	1	
			McIntire Air Dryer Part/Acces.			

260398110		ELEMENT 11428	INTAKE FILTER			
N		EA	1	1	1	
			All systems, McIntire Air Dryer Part/Acces.			

280020421		ELIMINATOR VIBRATION 5410A8				
N		EA	1	2	1	

260398052		EXCHANGER HEAT 11605				
N		EA	1	1	1	
			8/12, McIntire Air Dryer Part/Acces.			

260398029		EXCHANGER HEAT 16064				
N		EA	1	1	1	
			17/25, McIntire Air Dryer Part/Acces.			

260397583		FAN 11805	CABINET COOLING 115V			
N		EA	1	1	1	
			McIntire Air Dryer Part/Acces.			

260397591		FAN 11806	CABINET COOLING 230V			
N		EA	1	1	1	
			McIntire Air Dryer Part/Acces.			

260398722		FELT 10402	INTAKE FILTER			
N		EA	1	1	1	
			McIntire Air Dryer Part/Acces..			

PRESSURIZATION AIR DRYER PARTS

PRODUCT IDENTIFIER		DESCRIPTION				
ITEM NUMBER	ORD. MULT.	SELL UNIT	STD. PKG. STOCK AVAILABILITY / PA	LEAD TIME	MIN. ORD.	A C
260397955 FILTER 8545 HEAT EXCHANGER AIR						
N		EA	1	1	1	
McIntire Air Dryer Part/Acces.						
260397542 FILTER 10402 COMPRESSOR INLET						
N		EA	1	1	1	
McIntire Air Dryer Part/Acces.						
260398011 FILTER 16051 HEAT EXCHANGER AIR						
N		EA	1	1	1	
17/25, McIntire Air Dryer Part/Acces.						
260397781 FILTER 40333 CABINET						
N		EA	1	1	1	
McIntire Air Dryer Part/Acces.						
260302757 FILTER REPLACEMENT WATER BX4 99313						
N		BX	1	3	1	
260397922 GAUGE 763 OUTPUT & SYSTEM PRESSURE						
N		EA	1	1	1	
All models, McIntire Air Dryer Part/Acces.						
260397609 GAUGE 12005 SYSTEM PRESSURE						
N		EA	1	1	1	
0-100 PSIG, 5000, McIntire Air Dryer Part/Acces.						
260397617 GAUGE 12007 OUTPUT PRESSURE						
N		EA	1	1	1	
9/18/25, McIntire Air Dryer Part/Acces.						
260397625 GAUGE 12008 SYSTEM PRESSURE						
N		EA	1	1	1	
9/18/25, McIntire Air Dryer Part/Acces.						
260398748 HEAD 10414 CYLINDER						
N		EA	1	1	1	
McIntire Air Dryer Part/Acces.						
260398631 HOLDER FUSE 26603						
N		EA	1	1	1	
McIntire Air Dryer Part/Acces.						
260397575 HOSE 11701 VIBRATION						
N		EA	1	1	1	
McIntire Air Dryer Part/Acces.						
260398326 INDICATOR 22003 ALARM RED						
N		EA	1	1	1	
McIntire Air Dryer Part/Acces.						
260397757 INDICATOR 22004 TOWER AMBER						
N		EA	1	1	1	
McIntire Air Dryer Part/Acces.						
260398334 INDICATOR 22005 TOWER AMBER						
N		EA	1	1	1	
McIntire Air Dryer Part/Acces.						
260397567 INTERCOOLER 11606 FINNED TUBE						
N		EA	1	1	1	
5000, McIntire Air Dryer Part/Acces.						

PRODUCT IDENTIFIER		DESCRIPTION				
ITEM NUMBER	ORD. MULT.	SELL UNIT	STD. PKG. STOCK AVAILABILITY / PA	LEAD TIME	MIN. ORD.	A C
260397807 INTERCOOLER 42087 FINNED TUBE						
N		EA	1	1	1	
McIntire Air Dryer Part/Acces.						
260397914 ISOLATOR VIBRATION 99305						
N		EA	1	1	1	
Box of 4, McIntire Air Dryer Part/Acces.						
260397492 KIT 30744 COMPRESSOR REBUILD						
N		EA	1	1	1	
McIntire Air Dryer Part/Acces.						
260397468 KIT 99106 REFILL						
N		EA	1	3	1	
For indicating desiccant tower, McIntire Air Dryer Part/Acces.						
260398409 KIT 99125 HUMIDITY SHUT-OFF SOLENOID						
N		EA	1	1	1	
McIntire Air Dryer Part/Acces.						
260398417 KIT 99231 SNGL COMPRESSOR PURGE VALVE						
N		EA	1	1	1	
McIntire Air Dryer Part/Acces.						
260397872 KIT 99232 HUMID BYPASS SOLENOID VALVE						
N		EA	1	1	1	
McIntire Air Dryer Part/Acces.						
260397880 KIT 99233 AIR PURGE SOLENOID VALVE						
N		EA	1	1	1	
McIntire Air Dryer Part/Acces.						
260397476 KIT 99237 DISCRETE ALARM						
N		EA	1	3	1	
McIntire Air Dryer Part/Acces.						
260398672 KIT 99267 ALTERNATOR ADDENDUM						
N		EA	1	1	1	
McIntire Air Dryer Part/Acces.						
260397906 KIT 99268 SINGLE COMP SOLENOID VALVE						
N		EA	1	1	1	
5000, McIntire Air Dryer Part/Acces.						
260398680 KIT 99309 ALTERNATOR ADDENDUM						
N		EA	1	1	1	
McIntire Air Dryer Part/Acces.						
260398698 KIT 99310 ALTERNATOR ADDENDUM						
N		EA	1	1	1	
McIntire Air Dryer Part/Acces.						
260397435 KIT 99312 WATER FILTER						
N		EA	1	3	1	
17000 & 25000, McIntire Air Dryer Part/Acces.						
260398433 KIT 99321 HI-LO PRESSURE SWITCH						
N		EA	1	1	1	
McIntire Air Dryer Part/Acces.						
260398664 KIT 99327 ALARM DELAY MODIFICATION						
N		EA	1	1	1	
McIntire Air Dryer Part/Acces.						

DISTRIBUTION SERVICES

NETWORK SERVICES

TOOLS

BUILDING JANITORIAL

AUTOMOTIVE

FORMS/OFFICE SUPPLIES

GENERAL

DATA VOICE

PRESSURIZATION AIR DRYER PARTS

DISTRIBUTION SERVICES
NETWORK SERVICES
TOOLS
BUILDING JANITORIAL
AUTOMOTIVE
FORMS/OFFICE SUPPLIES
GENERAL
DATA VOICE

PRODUCT IDENTIFIER		DESCRIPTION				
ITEM NUMBER	ORD. MULT.	SELL UNIT	STD. PKG. STOCK AVAILABILITY / PA	LEAD TIME	MIN. ORD.	A C
260397419 KIT 99330 TRANSDUCER MOUNTING						
N		EA	1	3	1	
McIntire Air Dryer Part/Acces.						
260398441 KIT 99334 HUMIDITY CONTROL FAIL SAFE						
N		EA	1	1	1	
McIntire Air Dryer Part/Acces.						
280017773 KIT AIR SOLENOID 120-32A-1						
N		EA	1	1	1	
280027228 KIT MAINTENANCE AIR DRYER CHATLOS G526						
N		EA	1	3	1	
OR EQUIVALENT. Provides parts recommended for periodic maintenance of 1/2 & 3/4 HP air dryers.						
260430129 KIT MAINTENANCE AIR DRYER CHATLOS G528						
N		EA	1	3	1	
OR EQUIVALENT. Provides parts recommended for periodic maintenance of 1/4 & 1/3 HP air dryers.						
260430137 KIT MAINTENANCE AIR DRYER CHATLOS G530						
N		EA	1	3	1	
OR EQUIVALENT. Provides parts recommended for periodic maintenance of 1/6 HP air dryers.						
280000837 KIT MAINTENANCE AIR DRYER MCINTIRE						
N		EA	1	1	1	
99236 Provides parts recommended for periodic maintenance of air dryer models 9/18/25000.						
280000829 KIT MAINTENANCE AIR DRYER MCINTIRE						
N		EA	1	1	1	
99213 Provides parts recommended for periodic maintenance of air dryer models 8/12/17/25000.						
280000811 KIT MAINTENANCE AIR DRYER MCINTIRE						
N		EA	1	1	1	
99227 Provides parts recommended for periodic maintenance of air dryer model 5000.						
260430061 KIT MAINTENANCE AIR DRYER PUREGAS						
N		EA	1	1	1	
P15451D Provides parts recommended for periodic maintenance of air dryer models 16/24000.						
260430038 KIT MAINTENANCE AIR DRYER PUREGAS						
N		EA	1	1	1	
P07511 Provides parts recommended for periodic maintenance of air dryer models 3100/4200DO.						
260430012 KIT MAINTENANCE AIR DRYER PUREGAS						
N		EA	1	1	1	
P06885 Provides parts recommended for periodic maintenance of air dryer models 8/12000DCO.						

PRODUCT IDENTIFIER		DESCRIPTION				
ITEM NUMBER	ORD. MULT.	SELL UNIT	STD. PKG. STOCK AVAILABILITY / PA	LEAD TIME	MIN. ORD.	A C
260430020 KIT MAINTENANCE AIR DRYER PUREGAS						
N		EA	1	1	1	
P07586 W/SENSOR. Provides parts recommended for periodic maintenance of air dryer models 8/12000DCO/10/15000DCO.						
260430004 KIT MAINTENANCE AIR DRYER PUREGAS						
N		EA	1	1	1	
P05038 Provides parts recommended for periodic maintenance of air dryer model 5000 (2).						
260430103 KIT MAINTENANCE AIR DRYER PUREGAS						
N		EA	1	1	1	
P200-499 Provides parts recommended for periodic maintenance of heatless air dryers (AC valves).						
260430087 KIT MAINTENANCE AIR DRYER PUREGAS						
N		EA	1	1	1	
P3865 Provides parts recommended for periodic maintenance of air dryer models 3100/4200STD/4200CO/8542-3/8542A/9400LV (2).						
260430095 KIT MAINTENANCE AIR DRYER PUREGAS						
N		EA	1	1	1	
P07584 Provides parts recommended for periodic maintenance of air dryer models 3100/4200STD/4200CO/8542-3/8542A/9400LV (2).						
260430053 KIT MAINTENANCE AIR DRYER PUREGAS						
N		EA	1	1	1	
P07588 W/SENSOR. Provides parts recommended for periodic maintenance of air dryer models 16/24000.						
260430046 KIT MAINTENANCE AIR DRYER PUREGAS						
N		EA	1	1	1	
P15451 Provides parts recommended for periodic maintenance of air dryer models 16/24000.						
260430111 KIT MAINTENANCE AIR DRYER PUREGAS						
N		EA	1	1	1	
P200-499S. Provides parts recommended for periodic maintenance of heatless air dryers (DC valves).						
260430079 KIT MAINTENANCE AIR DRYER PUREGAS						
N		EA	1	1	1	
P07587 W/SENSOR. Provides parts recommended for periodic maintenance of air dryer models 16/24000D/20/30000D.						
300086154 KIT SOLENOID VALVE 4390A38						
N		EA	1	3	1	
280017740 KIT SPARE PARTS 99228						
N		EA	1	1	1	
260398565 KNOB 14022 TIMER						
N		EA	1	1	1	
McIntire Air Dryer Part/Acces.						
260398573 LIGHT 22001 AMBER INDICATOR						
N		EA	1	1	1	
McIntire Air Dryer Part/Acces.						

PRESSURIZATION AIR DRYER PARTS

PRODUCT IDENTIFIER		DESCRIPTION				
ITEM NUMBER	ORD. MULT.	SELL UNIT	STD. PKG. STOCK AVAILABILITY / PA	LEAD TIME	MIN. ORD.	A C
260397765 LIGHT 22009 POWER ON 230V-5000						
N		EA	1	1	1	
After 1/1/85, McIntire Air Dryer Part/Acces.						
260397534 MOTOR 10110 COMPRESSOR EMC-75 3/4HP						
N		EA	1	3	1	
-115/230V, McIntire Air Dryer Part/Acces.						
260397971 MOTOR 10113 COMPRESSOR EMC-03 3HP						
N		EA	1	3	1	
12/25, McIntire Air Dryer Part/Acces.						
260398037 MOTOR 16085 FAN						
N		EA	1	1	1	
17/25, McIntire Air Dryer Part/Acces.						
260398086 MOTOR 750054 FAN						
N		EA	1	1	1	
8/12, McIntire Air Dryer Part/Acces.						
260397518 NUT 794 SENSOR ELEMENT CBL RETAINING						
N		EA	1	3	1	
McIntire Air Dryer Part/Acces.						
260397526 O-RING 796 SENSOR CABLE						
N		EA	1	1	1	
McIntire Air Dryer Part/Acces.						
260398607 PLUG 7916 ALARM						
N		EA	1	1	1	
McIntire Air Dryer Part/Acces.						
260398359 PLUG 26204 SENSOR GLAND						
N		EA	1	1	1	
McIntire Air Dryer Part/Acces.						
260398656 PLUG 50251 DRYER ALTERNATOR ELIMINATOR						
N		EA	1	1	1	
McIntire Air Dryer Part/Acces.						
260398599 RECEPTICAL 716 POWER CORD						
N		EA	1	1	1	
McIntire Air Dryer Part/Acces.						
260398615 RECEPTICAL 7915 ALARM PLUG						
N		EA	1	1	1	
McIntire Air Dryer Part/Acces.						
260397500 REGULATOR 761 OUTPUT PRESSURE						
N		EA	1	3	1	
9-18-25, McIntire Air Dryer Part/Acces.						
260398094 REGULATOR 11200 BYPASS & FLOW LIMITER						
N		EA	1	1	1	
8000, McIntire Air Dryer Part/Acces.						
260398854 REGULATOR 11209 OUTPUT PRESSURE						
N		EA	1	1	1	
17/25, McIntire Air Dryer Part/Acces.						
260398102 REGULATOR 11210 OUTPUT PRESSURE						
N		EA	1	1	1	
8/12, McIntire Air Dryer Part/Acces.						

PRODUCT IDENTIFIER		DESCRIPTION				
ITEM NUMBER	ORD. MULT.	SELL UNIT	STD. PKG. STOCK AVAILABILITY / PA	LEAD TIME	MIN. ORD.	A C
260398003 REGULATOR 12039 BYPASS & FLOW LIMITER						
N		EA	1	1	1	
17/25, 12000, McIntire Air Dryer Part/Acces.						
260397963 REGULATOR 85100 BYPASS						
N		EA	1	1	1	
12000, McIntire Air Dryer Part/Acces.						
260397930 RELAY 7910 POWER						
N		EA	1	1	1	
8000, McIntire Air Dryer Part/Acces.						
260397989 RELAY 12010 POWER						
N		EA	1	1	1	
12000, McIntire Air Dryer Part/Acces.						
260398219 RELAY 20500 ALARM PLUG-IN						
N		EA	1	1	1	
McIntire Air Dryer Part/Acces.						
260398524 RELAY 20503 ALARM & COMPRESSOR						
N		EA	1	1	1	
LATCHING. McIntire Air Dryer Part/Acces.						
260397690 RELAY 20506 POWER						
N		EA	1	1	1	
5000, McIntire Air Dryer Part/Acces.						
260397708 RELAY 20507 LATCHING						
N		EA	1	1	1	
5000, McIntire Air Dryer Part/Acces.						
260398532 RELAY 20510 PLUG-IN						
N		EA	1	1	1	
McIntire Air Dryer Part/Acces.						
260397484 RELAY 20515 POWER FAILURE ALARM DELAY						
N		EA	1	3	1	
McIntire Air Dryer Part/Acces.						
260398060 SCREEN 1120 WATER STRAINER						
N		EA	1	3	1	
8/12, McIntire Air Dryer Part/Acces.						
280020470 SENSOR HUMIDITY 3530A12 O-RING						
N		EA	1	2	1	
280020488 SENSOR HUMIDITY 4541A 3						
N		EA	1	1	1	
260398706 SHROUD 10400 FAN						
N		EA	1	1	1	
McIntire Air Dryer Part/Acces.						
260398763 SLEEVE 10417 MANIFOLD ELBOW						
N		EA	1	1	1	
McIntire Air Dryer Part/Acces.						
260398540 SOCKET 26300 FOR PLUG-IN RELAY						
N		EA	1	1	1	
McIntire Air Dryer Part/Acces.						
260398250 SOLENOID 21003 HUMIDITY SHUT-OFF						
N		EA	1	1	1	
8/12, McIntire Air Dryer Part/Acces.						

DISTRIBUTION SERVICES

NETWORK SERVICES

TOOLS

BUILDING JANITORIAL

AUTOMOTIVE

FORMS/OFFICE SUPPLIES

GENERAL

DATA VOICE

DISTRIBUTION SERVICES

NETWORK SERVICES

TOOLS

BUILDING JANITORIAL

AUTOMOTIVE

FORMS/OFFICE SUPPLIES

GENERAL

DATA VOICE

PRESSURIZATION AIR DRYER PARTS

PRODUCT IDENTIFIER		DESCRIPTION				
ITEM NUMBER	ORD. MULT.	SELL UNIT	STD. PKG. STOCK AVAILABILITY / PA	LEAD TIME	MIN. ORD.	A C
260398268 SOLENOID 21004 HUMIDITY SHUT-OFF						
N		EA	1	1	1	
17/25, McIntire Air Dryer Part/Access.						
260398128 STRAINER 11432 WATER						
N		EA	1	1	1	
8/12, McIntire Air Dryer Part/Access.						
260398136 STRAINER 11433 WATER						
N		EA	1	1	1	
17/25, McIntire Air Dryer Part/Access.						
260398144 SWITCH 20103 MASTER						
N		EA	1	1	1	
8000, McIntire Air Dryer Part/Access.						
260398151 SWITCH 20104 MASTER						
N		EA	1	1	1	
12000, McIntire Air Dryer Part/Access.						
260398169 SWITCH 20106 MASTER						
N		EA	1	1	1	
17000 BEFORE 6/83, McIntire Air Dryer Part/Access.						
260398177 SWITCH 20107 MASTER						
N		EA	1	1	1	
25000 BEFORE 6/83, McIntire Air Dryer Part/Access.						
260398466 SWITCH 20111 ON-OFF SWITCH LIGHTED AND						
N		EA	1	1	1	
ALARM RM RESET, McIntire Air Dryer Part/Access.						
260397658 SWITCH 20112 OVERRIDE						
N		EA	1	1	1	
5000, McIntire Air Dryer Part/Access.						
260397666 SWITCH 20113 RESET						
N		EA	1	1	1	
5000, McIntire Air Dryer Part/Access.						
260397674 SWITCH 20115 MASTER CIRCUIT BREAKER						
N		EA	1	1	1	
5000, Before 1-1-85, McIntire Air Dryer Part/Access.						
260398482 SWITCH 20116 COMPRESSOR OVERRIDE						
N		EA	1	1	1	
McIntire Air Dryer Part/Access.						
260397682 SWITCH 20118 MASTER CIRCUIT BREAKER						
N		EA	1	1	1	
9/18/25, McIntire Air Dryer Part/Access.						
260398508 SWITCH 20120 ALTERNATOR TRANS						
N		EA	1	1	1	
SELECTOR Toggle, McIntire Air Dryer Part/Access.						
260398490 SWITCH 20121 DRYER SELECTOR						
N		EA	1	1	1	
McIntire Air Dryer Part/Access.						

PRODUCT IDENTIFIER		DESCRIPTION				
ITEM NUMBER	ORD. MULT.	SELL UNIT	STD. PKG. STOCK AVAILABILITY / PA	LEAD TIME	MIN. ORD.	A C
260398185 SWITCH 20132 MAIN POWER						
N		EA	1	1	1	
17-25 After 6/83, McIntire Air Dryer Part/Access.						
260398193 SWITCH 20133 MASTER						
N		EA	1	1	1	
17000 After 6/83, McIntire Air Dryer Part/Access.						
260398201 SWITCH 20134 MASTER						
N		EA	1	1	1	
25000 After 6/83, McIntire Air Dryer Part/Access.						
260397716 SWITCH 20707 LOW PRESSURE ALARM						
N		EA	1	3	1	
McIntire Air Dryer Part/Access.						
260397724 SWITCH 20709 COMPRESSOR PRESSURE						
N		EA	1	1	1	
5000, McIntire Air Dryer Part/Access.						
260397732 SWITCH 20711 COMPRESSOR PRESSURE						
N		EA	1	1	1	
9/18/25, McIntire Air Dryer Part/Access.						
260398391 SWITCH 40365 FLOAT WATER LEVEL						
N		EA	1	1	1	
McIntire Air Dryer Part/Access.						
260397740 THERMOSTAT 20901						
N		EA	1	1	1	
McIntire Air Dryer Part/Access.						
260398557 TIMER 22608 ALTERNATOR						
N		EA	1	1	1	
McIntire Air Dryer Part/Access.						
260397799 TIMER 40362 DEHYDRATOR						
N		EA	1	1	1	
5000, McIntire Air Dryer Part/Access.						
260397831 TIMER 50253 ALTERNATOR						
N		EA	1	1	1	
5000, McIntire Air Dryer Part/Access.						
260397898 TIMER 99263 DEHYDRATOR						
N		EA	1	1	1	
9/18/25, McIntire Air Dryer Part/Access.						
260398425 TIMER 99286 DEHYDRATOR						
N		EA	1	1	1	
All Systems, McIntire Air Dryer Part/Access.						
260397443 TOWER 70050 INDICATING DESICCANT						
N		EA	1	3	1	
1/2 Ports, McIntire Air Dryer Part/Access.						
260397450 TOWER 70051 INDICATING DESICCANT						
N		EA	1	3	1	
3/4 Ports, McIntire Air Dryer Part/Access.						
260398045 TRANSFORMER 16089						
N		EA	1	1	1	
17/25, McIntire Air Dryer Part/Access.						

PRODUCT IDENTIFIER		DESCRIPTION				
ITEM NUMBER	ORD. MULT.	SELL UNIT	STD. PKG. STOCK AVAILABILITY / PA	LEAD TIME	MIN. ORD.	A C
260398342 TRANSFORMER 23303						
N		EA	1	1	1	
8/12, McIntire Air Dryer Part/Access.						
260398771 TUBE 10418 MANIFOLD 3/4HP						
N		EA	1	1	1	
McIntire Air Dryer Part/Access.						
260398789 TUBE 10419 MANIFOLD 1/2HP						
N		EA	1	1	1	
McIntire Air Dryer Part/Access.						
280017807 VALVE 8554 INLET CHECK						
N		EA	1	1	1	
McIntire Air Dryer Part/Access.						
260398730 VALVE 10403 SAFETY RELIEF						
N		EA	1	1	1	
McIntire Air Dryer Part/Access.						
260397559 VALVE 11041 OUTPUT CHECK						
N		EA	1	1	1	
McIntire Air Dryer Part/Access.						
260397997 VALVE 12011 WATER METERING						
N		EA	1	1	1	
All Systems, McIntire Air Dryer Part/Access.						
260398276 VALVE 21008 SINGLE COMPRESSOR						
N		EA	1	1	1	
SOLENOID 17-25, McIntire Air Dryer Part/Access.						
260398284 VALVE 21013 DRAIN SOLENOID						
N		EA	1	1	1	
All Models, McIntire Air Dryer Part/Access.						
260398292 VALVE 21015 AIR SOLENOID						
N		EA	1	1	1	
8/12, McIntire Air Dryer Part/Access.						
260398300 VALVE 21016 AIR SOLENOID						
N		EA	1	1	1	
17/25, McIntire Air Dryer Part/Access.						
260397815 VALVE 50247 AIR PURGE SOLENOID						
N		EA	1	1	1	
5000, McIntire Air Dryer Part/Access.						
260397823 VALVE 50248 HUMIDITY BYPASS SOLENOID						
N		EA	1	1	1	
5000, McIntire Air Dryer Part/Access.						
260397849 VALVE 50255 HUMIDITY BYPASS SOLENOID						
N		EA	1	1	1	
9/18/25, McIntire Air Dryer Part/Access.						
260397856 VALVE 50256 AIR PURGE SOLENOID						
N		EA	1	1	1	
9/18/25, McIntire Air Dryer Part/Access.						
260397864 VALVE 50272 SINGLE COMP SOLENOID						
N		EA	1	1	1	
5000, McIntire Air Dryer Part/Access.						

PRODUCT IDENTIFIER		DESCRIPTION				
ITEM NUMBER	ORD. MULT.	SELL UNIT	STD. PKG. STOCK AVAILABILITY / PA	LEAD TIME	MIN. ORD.	A C
280020496 VALVE AIR SOLENOID 4390A21						
N		EA	1	1	1	
280020504 VALVE AIR SOLENOID 4390A5						
N		EA	1	1	1	
280003708 VALVE BACK PRESSURE 5620-M59						
N		EA	1	1	4	

PROTECTOR

100399799 PROTECTOR 106C						
N		EA	24	1	1	
Will carry sufficient current to permit the use of the 106C for fuseless operation, BSP 460-100-101.						

100399815 PROTECTOR 108C						
N		EA	1	8	1	
For use on PI carrier as well as on voice frequency circuits. Equipped with housing, NOW AVAILABLE THROUGH TOUCH-TONE ORDER ENTRY.						

104146725 PROTECTOR 116E1A						
1176933	1	EA	IL 08	IN 08	MI 08	OH 08
Six pair gas station outdoor protector which provides 500 volt protection for 6 pair multiple drop wire at subscribers premises.						

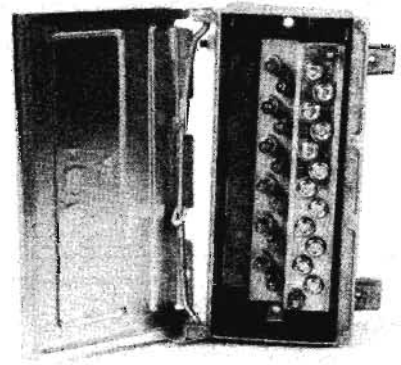

1176933

100399922 PROTECTOR 117B						
1220541	1	EA	IL 08	IN 08	MI 08	OH 08

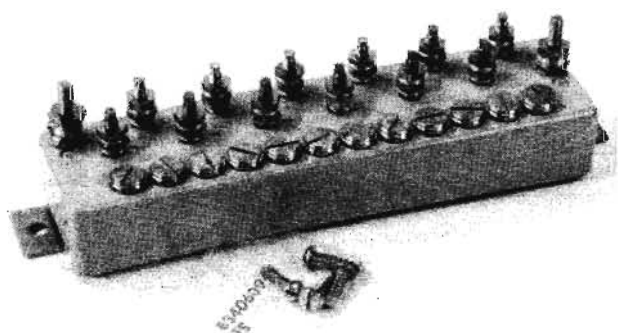

1220541

DISTRIBUTION SERVICES

NETWORK SERVICES

TOOLS

BUILDING JANITORIAL

AUTOMOTIVE

FORMS/OFFICE SUPPLIES

GENERAL

DATA VOICE

DISTRIBUTION SERVICES

NETWORK SERVICES

TOOLS

BUILDING JANITORIAL

AUTOMOTIVE

FORMS/OFFICE SUPPLIES

GENERAL

DATA VOICE

PROTECTOR

PRODUCT IDENTIFIER		DESCRIPTION				
ITEM NUMBER	ORD. MULT.	SELL UNIT	STD. PKG. STOCK AVAILABILITY / PA	LEAD TIME	MIN. ORD.	A C

100399930 PROTECTOR 118A
 N EA 30 1 1
 Used with open wire subscriber lines on joint used poles, or as lightning protection for one pair of conductors having high dielectric insulating.

100399948 PROTECTOR 118B
 1197756 1 EA IL IN MI OH WI
 08 08 08 08 08
 Used for protecting both, C, rural wire and drop wire on jointly used poles carrying higher voltage power distributing circuits.

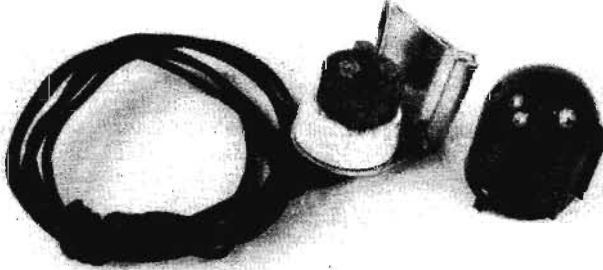

1197756

101951564 PROTECTOR 134A1A 16 12
 N EA 1 1 1
 Protectors for use as station protectors in buildings served by exposed cables, BSP 631-460-111, BSP 631-460-201.

101951580 PROTECTOR 134A1A 25 12
 N EA 1 1 1
 Cast resin block with 25 prs of #2A1A carbon protector units providing 500V protection. Includes two 12FT stub cables, a 24 gauge and a 26 gauge.

101951606 PROTECTOR 134A1A 50 12
 N EA 1 1 1

101205532 PROTECTOR 134A1A 50 25
 N EA 1 1 1

102165859 PROTECTOR 134A1A 100 12
 N EA 1 5 1

101413698 PROTECTOR 134A1A 100 25
 N EA 1 1 1

103389813 PROTECTOR 134E1A 25 12
 N EA 1 8 1
 Contains 25 pairs of #11A1 gas tube protector units with 12FT stub cables.

103389839 PROTECTOR 134E1A 50 12
 N EA 1 8 1

103389862 PROTECTOR 134E1A 100 12
 N EA 1 8 1

103389870 PROTECTOR 134E1A 100 25
 N EA 1 8 1

PRODUCT IDENTIFIER		DESCRIPTION				
ITEM NUMBER	ORD. MULT.	SELL UNIT	STD. PKG. STOCK AVAILABILITY / PA	LEAD TIME	MIN. ORD.	A C

103213609 PROTECTOR 142E1A
 1160036 1 EA IL IN MI OH WI
 08 08 08 08 08
 A five pair protector for use with 5 pair B-Service Wire.

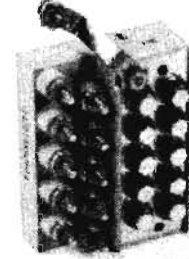

1160036

103289252 PROTECTOR 189B1 25 25
 N EA 1 1 1
 A combination 25 pair protector and terminating field with a 25ft stub. Uses 3 or 4B type protector units.

103289245 PROTECTOR 189B1 100 25
 N EA 1 1 1
 NOW AVAILABLE THROUGH TOUCH-TONE ORDER ENTRY.

103623633 PROTECTOR 189BC1 25
 N EA 1 1 1
 Same as 189B1-25 except equipped with a hinged cover.

103623641 PROTECTOR 189BC1 50
 N EA 1 1 1

103623658 PROTECTOR 189BC1 100
 N EA 1 1 1

103623666 PROTECTOR 189CC1 25 25
 N EA 1 1 1
 Similar to 189C1-25 except equipped with a cover.

103623674 PROTECTOR 189CC1 50 25
 N EA 1 1 1
 Similar to 189B1-50 except equipped with two KS16672L3 connectors in place of terminal dist field. Hinged cover.

103623682 PROTECTOR 189CC1 100 25
 N EA 1 1 1
 Similar to 189B1-100 except equipped with four KS16672L3 connectors in place of term dist field. Hinged cover.

102995073 PROTECTOR 190A1 50
 1973982 1 EA IL IN MI OH WI
 08 08 08 08
 Designed to accept 50 #3B or 4B type protector units. Equipped with 50-pair input and output cables, 25FT stub.

PRODUCT IDENTIFIER DESCRIPTION

ITEM NUMBER	ORD. MULT.	SELL UNIT	STD. PKG. STOCK AVAILABILITY / PA	LEAD TIME	MIN. ORD.	A C
-------------	------------	-----------	-----------------------------------	-----------	-----------	-----

102995099 PROTECTOR 190A1 100 25
 N EA 1 1 1
 Station protector used in buildings served by exposed cable - non gas tight.

260300496 PROTECTOR 190A1A3 50
 N EA 1 5 1

260300504 PROTECTOR 190A1A3 100
 1938258 1 EA IL IN MI OH WI
 15 15 15

103550067 PROTECTOR 199A1A 10 25
 N EA 1 8 16
 Equipped with a #9A1A-10 type term block and a #119A1-25 conn block 12FT stub.

103644530 PROTECTOR 199A1A 50 12
 N EA 1 6 1
 Equipped with two #9A1A-25W term blocks. 12FT stub.

103644621 PROTECTOR 199A1A 50 50
 1130229 1 EA IL IN MI OH WI
 08
 A 50 pair protector to be used in an MC 10/48 closure. The protector consists of a 134A1A-50 and two 50 pair 76 type binding post blocks, with 50 feeder pairs on one & 50 distrib pairs on the other.

103644639 PROTECTOR 199A3A 25 50
 4232888 1 EA IL IN MI OH WI
 18
 A 25 pair protector for use on MC 10/48 closure. Consists of a 134A1A and two 50 pair 76 type binding post blocks w/25 feeder pairs on one, & 50 distrib pairs on the other.

103941274 PROTECTOR 208A
 N EA 1 9 1
 Consists of an unbalanced, dual-gap, three electrode, gas-filled surge limiter. Individual pack.

300031721 PROTECTOR 356L
 1333013 1 EA IL IN MI OH WI
 08 08 08 08 08

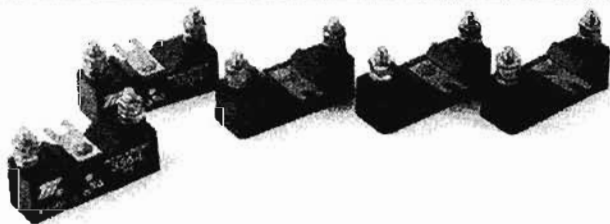

1333013

PRODUCT IDENTIFIER DESCRIPTION

ITEM NUMBER	ORD. MULT.	SELL UNIT	STD. PKG. STOCK AVAILABILITY / PA	LEAD TIME	MIN. ORD.	A C
-------------	------------	-----------	-----------------------------------	-----------	-----------	-----

300031770 PROTECTOR 356L 322 ADAPTER
 1333039 1 EA IL IN MI OH WI
 08 08 08 08 08

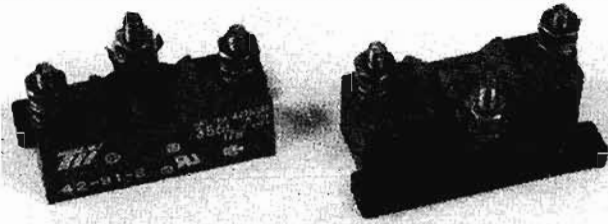

1333039

260303680 PROTECTOR 356L 382 ADAPTER
 1940288 1 EA IL IN MI OH WI
 08 08 08

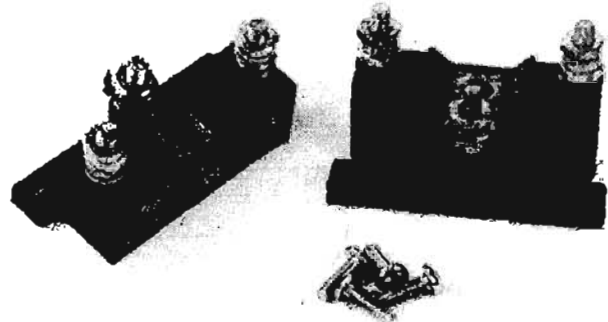

1940288

401189485 PROTECTOR CONDUIT 1C Z6G 8 X 12
 1215038 1 SH IL IN MI OH WI
 35

401982343 PROTECTOR PAIR 8000-719 LARGE
 8500827 1 EA IL IN MI OH WI
 08 08 08 08
 A plastic shim inserted between the cable shield and the core wrap prior to bonding and tabbing. package of 100, BSP 507-334-226.

401982350 PROTECTOR PAIR 8000-720 SMALL
 6500694 1 EA IL IN MI OH WI
 08 08 08 08
 Package of 100.



6500694

DISTRIBUTION SERVICES

NETWORK SERVICES

TOOLS

BUILDING JANITORIAL

AUTOMOTIVE

FORMS/OFFICE SUPPLIES

GENERAL

DATA VOICE

PUBLIC COMMUNICATION EQUIPMENT

DISTRIBUTION SERVICES

PRODUCT IDENTIFIER		DESCRIPTION					A
ITEM NUMBER	ORD. MULT.	SELL UNIT	STD. PKG. STOCK AVAILABILITY / PA	LEAD TIME	MIN. ORD.	A	

PUBLIC COMMUNICATION EQUIPMENT

260419569		EA	1	2	1	
ADAPTER CHASSIS RJ-11						
N		EA	1	2	1	
260323258		EA	1	13	1	
ADAPTER HARNESS OPTIC SENSOR						
260323647		EA	1			
ADAPTER JACK PJ959						
1944033	1	EA	IL IN MI OH WI			
			59 59 59 59			
300059425		EA	1			
ADAPTER MOUNTING KSVR 107-BF						
8410258	1	EA	IL IN MI OH WI			
			18			
280015686		EA	1			
ADAPTER PLATE ADCO G-145						
1940734	1	EA	IL IN MI OH WI			
			58			
300032125		EA	1			
ADAPTER R PHILLIP-BROOKS OHIO						
6501049	1	EA	IL IN MI OH WI			
			18			
Pole mount for housings and enclosures.						
260423504		EA	1	2	1	
ADAPTER SIGN BN7172						
N		EA	1	2	1	
May be required to mount SIGN TRIANGULAR LTD BN7600 - IL (260423512).						
260323241		EA	1	13	1	
ADAPTER TAIL TOTAL/SIGNAL						
N		EA	1	13	1	
260433255		EA	1	8	1	
ASSEMBLY BOARD AND FRAME 4010RT 11B						
N		EA	1	8	1	
260433263		EA	1	8	1	
ASSEMBLY BOARD AND FRAME 4010RT 1D						
N		EA	1	8	1	
400348579		EA	1			
ASSEMBLY BOX BREAKER CK19426 L17						
1219618	1	EA	IL IN MI OH WI			
			18			
841012123		EA	1	2	1	
ASSEMBLY CARD & PLUG						
N		EA	1	2	1	
840698294		EA	1	2	1	
ASSEMBLY COIL FIELD						
N		EA	1	2	1	
260422845		EA	1			
ASSEMBLY COIN RELEASE 434-907						
1979088	1	EA	IL IN MI OH WI			
280015694		KT	1	4	1	
ASSEMBLY COMB PIN 1 1/2IN 075						
N		KT	1	4	1	
Used with 1 1/2in directory binder, H-075, 25 per package.						
280015843		PK	1	4	1	
ASSEMBLY COMB PIN 3IN H-082						
N		PK	1	4	1	
Used with 3in binder directory, package of 20.						
260422100		KT	1	4	1	
ASSEMBLY COMB PIN LOCK 3IN BDR H076						
N		KT	1	4	1	

NETWORK SERVICES

TOOLS

BUILDING JANITORIAL

AUTOMOTIVE

FORMS/OFFICE SUPPLIES

GENERAL

DATA VOICE

PRODUCT IDENTIFIER		DESCRIPTION					A
ITEM NUMBER	ORD. MULT.	SELL UNIT	STD. PKG. STOCK AVAILABILITY / PA	LEAD TIME	MIN. ORD.	A	

260422126		KT	1	4	1	
ASSEMBLY COMB PIN LOCK 4IN BDR H077						
N		KT	1	4	1	
840152474		EA	1	2	1	
ASSEMBLY CUP						
N		EA	1	2	1	
260433271		EA	1	8	1	
ASSEMBLY DIAL 4010RT 10A/11B						
N		EA	1	8	1	
260433289		EA	1	8	1	
ASSEMBLY DIAL 4010RT 1D						
N		EA	1	8	1	
260422134		EA	1	4	1	
ASSEMBLY LIGHT FOR 31K B-025						
N		EA	1	4	1	
841012255		EA	1	2	1	
ASSEMBLY PLUNGER & SWITCH						
N		EA	1	2	1	
811056860		EA	1	2	1	
ASSEMBLY SELECTOR CARD						
N		EA	1	2	1	
843129982		EA	1			
ASSEMBLY SWITCH HOOK 843129982						
1225839	1	EA	IL IN MI OH WI			
			59 59 59 59 59			
101165694		EA	1			
BACKBOARD 178 A (SB-178A)						
1198184	1	EA	IL IN MI OH WI			
			58 58 58 58 58			
An Aluminum alloy backboard designed to be used with 1A type coin collectors, BSP 463-130-100.						
401655196		EA	1			
BACKBOARD CK20842 L45						
1166553	1	EA	IL IN MI OH WI			
			57 57 57 57			
Necessary to wall mount CK20842 L32,33,34 or 35 housings, BSP 508-452-100.						
280046178		EA	1			
BACKBOARD R						
1925693	1	EA	IL IN MI OH WI			
			18 18			
For Phillips and Brooks coin pedestal.						
260379979		EA	3000			
BAG COIN LARGE 11 3/8IN X 19 5/8IN						
1960518	3000	EA	IL IN MI OH WI			
			59			
280037243		EA	1	2	1	
BAR EXTRUSION UPPER/LOWER B-289						
N		EA	1	2	1	
401243498		EA	1	6	1	
BASE CK20842 L 50 REGULAR						
N		EA	1	6	1	
For above surface mounting of CK20842 Telephone Housing. BSP 508-452-100.						
402314074		EA	1			
BASE CK20842 L152 BURIED						
5403261	1	EA	IL IN MI OH WI			
			04 04			
280052093		EA	1			
BEZEL CARD READER CTR 04						
1950097	1	EA	IL IN MI OH WI			
			58 58			
280051285		EA	1			
BINDER DIRECTORY 153021						
1927350	1	EA	IL IN MI OH WI			
			58			

PRODUCT IDENTIFIER		DESCRIPTION					
ITEM NUMBER	ORD. MULT.	SELL UNIT	STD. PKG. STOCK AVAILABILITY / PA	LEAD TIME	MIN. ORD.	A C	
260422456 BINDER DIRECTORY 153022							
1975565	1	EA	IL IN MI	OH WI	59		
Ohio Bell Graphics 3 1/4in.							
280051210 BINDER DIRECTORY 153036							
1927343	1	EA	IL IN MI	OH WI	33		
1 1/4in, Michigan Bell.							
280051202 BINDER DIRECTORY 153037							
1927335	1	EA	IL IN MI	OH WI	33		
2 1/4in, Michigan Bell.							
280051194 BINDER DIRECTORY 153038							
1927327	1	EA	IL IN MI	OH WI	33		
3 1/4in, Michigan Bell.							
280052234 BINDER DIRECTORY 153040							
1927723	1	EA	IL IN MI	OH WI	04		
Black binder holds one 10in x 12in directory maximum thickness 1 1/4in. Requires sheet metal swivel with each binder.							
280051343 BINDER DIRECTORY 153093							
N		EA	30	5	30		
12 1/4in x 9 1/2in X 1 1/4in for holding directories at coin telephone locations. Wisconsin Bell, BSP 508-710-101.							
280051301 BINDER DIRECTORY 153096							
1927368	1	EA	IL IN MI	OH WI	33		
12 1/4in x 9 1/2in x 2 1/2in for holding directories at coin telephone locations. Wisconsin Bell, BSP 508-710-101.							
280051319 BINDER DIRECTORY 153097							
1927293	1	EA	IL IN MI	OH WI	33 33		
12 1/4in x 9 1/2in x 3 3/8in for holding directories at coin telephone locations. Wisconsin Bell, BSP 508-710-101.							
260302732 BINDER DIRECTORY 153267							
1940056	1	EA	IL IN MI	OH WI	04		
Black binder holds one 10in X 12in directory maximum thickness 2 1/4in. Equipped with lanyard.							
260302773 BINDER DIRECTORY 153316							
1940064	1	EA	IL IN MI	OH WI	04		
Black binder holds one 10in X 12in directory maximum thickness 2 1/4in. Equipped with swivel.							
260301908 BINDER DIRECTORY 153321							
1938761	1	EA	IL IN MI	OH WI	04		
Black binder holds one 10in X 12in directory maximum thickness 2 3/4in.							

PRODUCT IDENTIFIER		DESCRIPTION					
ITEM NUMBER	ORD. MULT.	SELL UNIT	STD. PKG. STOCK AVAILABILITY / PA	LEAD TIME	MIN. ORD.	A C	
260302740 BINDER DIRECTORY 153323							
1939546	1	EA	IL IN MI	OH WI	04		
Black binder holds one 10in X 12in directory maximum thickness 2 3/4in. Equipped with lanyard.							
260422464 BINDER DIRECTORY 153333							
1975573	1	EA	IL IN MI	OH WI	59		
Ohio Bell Graphics Bell Blue 2 1/2in.							
260367636 BINDER DIRECTORY 153494 1 1/2IN							
1955336	1	EA	IL IN MI	OH WI	59		
401397914 BINDER DIRECTORY 500262							
5214122	1	EA	IL IN MI	OH WI	33		
3/4in, Ohio Bell.							
001182047 BINDER DIRECTORY 500330 WE14750							
8300749	1	EA	IL IN MI	OH WI	33		
10 1/4in x 6 5/8in x 3/4in for holding directories at coin telephone locations, BSP 508-710-101.							
001182005 BINDER DIRECTORY 500331 WE21000							
8300582	1	EA	IL IN MI	OH WI	33		
12 1/4in x 9 1/2in x 3/4in for holding directories at coin telephone locations, BSP 508-710-101.							
280052218 BINDER DIRECTORY 501399							
1927731	1	EA	IL IN MI	OH WI	04		
Black binder holds one 10in X 12in directory maximum thickness 1/2in. Requires wire strap and sheet metal swivel.							
280099771 BINDER DIRECTORY IB 750S							
N		EA	45	5	45		
280099813 BINDER DIRECTORY IB 750S-L BLACK							
N		EA	45	5	45		
280099797 BINDER DIRECTORY IB 3250							
N		EA	12	5	24		
280099805 BINDER DIRECTORY IB 3750-L BLACK							
N		EA	10	5	20		
280099821 BINDER DIRECTORY IB 4250 BLACK							
N		EA	10	5	20		
280099714 BINDER DIRECTORY IL 750S							
N		EA	45	5	45		
280099722 BINDER DIRECTORY IL 750S-L							
N		EA	45	5	45		
280099730 BINDER DIRECTORY IL 1500							
N		EA	25	5	25		

DISTRIBUTION SERVICES

NETWORK SERVICES

TOOLS

BUILDING JANITORIAL

AUTOMOTIVE

FORMS/OFFICE SUPPLIES

GENERAL

DATA VOICE

DISTRIBUTION SERVICES

NETWORK SERVICES

TOOLS

BUILDING JANITORIAL

AUTOMOTIVE

FORMS/OFFICE SUPPLIES

GENERAL

DATA VOICE

PUBLIC COMMUNICATION EQUIPMENT

PRODUCT IDENTIFIER		DESCRIPTION						
ITEM NUMBER	ORD. MULT.	SELL UNIT	STD. PKG. STOCK AVAILABILITY / PA	LEAD TIME	MIN. ORD.	A	C	
280099748			BINDER DIRECTORY IL 1500-L					
N		EA	25	5	25			
280099755			BINDER DIRECTORY IL 2500					
N		EA	16	5	32			
280099763			BINDER DIRECTORY IL 2500-L					
N		EA	16	5	16			
280099839			BINDER DIRECTORY MB 750S					
N		EA	45	5	45			
280099847			BINDER DIRECTORY OB 750S					
N		EA	45	5	45			
280099896			BINDER DIRECTORY OB 1250					
N		EA	30	5	30			
280099854			BINDER DIRECTORY OB 1250-L					
N		EA	30	5	30			
280099862			BINDER DIRECTORY OB 2250-L					
N		EA	18	5	36			
280099870			BINDER DIRECTORY OB 3250-L					
N		EA	12	5	24			
280099904			BINDER DIRECTORY OB 4250					
N		EA	10	5	20			
280099888			BINDER DIRECTORY OB 4250-L					
N		EA	10	5	10			
280099912			BINDER DIRECTORY WB 1750					
N		EA	22	5	22			
280099920			BINDER DIRECTORY WB 2250					
N		EA	18	5	36			
300049475			BINDER DIRECTORY-PB-A-112					
N		EA	1	2	1			
			Swing away.					
280014036			BOOTH ADKO BD-45					
N		EA	1	6	1			
400318044			BRACKET CK20125 L 3					
1117283	1	EA	IL IN MI OH WI	58 58 58				
			For mounting sign CK20125 perpendicular to a vertical surface. Screws and bolts for mounting must be provided locally, BSP 508-810-100.					
401191929			BRACKET CK20842 L42					
1202457	1	EA	IL IN MI OH WI	57				
			Used to mount KS20842 type housing on wall or back-to-back on a post. Also called Backboard Mounting CK20842 L42. BSP 508-452-100.					
260343132			BRACKET MOUNTING C CLEAR PB-23					
N		EA	1	6	1			

PRODUCT IDENTIFIER		DESCRIPTION						
ITEM NUMBER	ORD. MULT.	SELL UNIT	STD. PKG. STOCK AVAILABILITY / PA	LEAD TIME	MIN. ORD.	A	C	
260422852			BRACKET PROTECTOR/SWITCH 434-917					
1979070	1	EA	IL IN MI OH WI					
260342506			BRACKET SIGN 12IN MSRBR12					
1949917	1	EA	IL IN MI OH WI	58 58 58				
300040482			BRACKET SIGN WITH SPIN LOGO					
5111773	1	PK	IL IN MI OH WI	58 58				
			Package of 25.					
002082618			BRACKET WALL MOUNT WMB-R					
1921098	1	EA	IL IN MI OH WI	57 57 57 57				
			Used for a wall mounting booth Adco 107 LT-BF will fit any BF series.					
400486700			BREAKER CIRCUIT 15A 120V CURV3					
5245340	1	EA	IL IN MI OH WI	31				
			Heinemann 0912-15-120AC-3.					
260422886			BUTTON AMPLIFIER 434-905					
1979047	1	EA	IL IN MI OH WI					
260449640			BUTTON LOUD 459AMC					
N			Kit for use in 1C/1D & 2C/2D public coin phones.					
260449483			BUTTON LOUD D182602					
N			For use with C/D Type public coin sets.					
260422860			CABLE CHASSIS/CHUTE 434-918					
N		EA	1	8	1			
260412796			CARD INSTRUCTION IL CAC 201					
N		EA	1	7	500			
260412804			CARD INSTRUCTION IL INMATE 201					
N		EA	1	7	500			
260407184			CARD INSTRUCTION IL LOWER 8					
N		EA	1	7	500			
260407119			CARD INSTRUCTION IL UPPER 3					
N		EA	1	7	1000			
260407127			CARD INSTRUCTION IL UPPER 3A					
N		EA	1	7	1000			
260407135			CARD INSTRUCTION IL UPPER 4					
N		EA	1	7	1000			
260407143			CARD INSTRUCTION IL UPPER 4A					
N		EA	1	7	1000			
260407150			CARD INSTRUCTION IL UPPER 5					
N		EA	1	7	1000			

PUBLIC COMMUNICATION EQUIPMENT

PRODUCT IDENTIFIER		DESCRIPTION				
ITEM NUMBER	ORD. MULT.	SELL UNIT	STD. PKG. STOCK AVAILABILITY / PA	LEAD TIME	MIN. ORD.	A C
260407168	N	EA	1	7	6	1000
CARD INSTRUCTION IL UPPER						
260407176	N	EA	1	7	7	500
CARD INSTRUCTION IL UPPER						
260412754	N	EA	1	7	103	500
CARD INSTRUCTION IL UPPER						
260412762	N	EA	1	7	103A	500
CARD INSTRUCTION IL UPPER						
260412770	N	EA	1	7	104	500
CARD INSTRUCTION IL UPPER						
260412788	N	EA	1	7	104A	500
CARD INSTRUCTION IL UPPER						
260412945	N	EA	1	7	202	500
CARD INSTRUCTION IN CAC						
260412952	N	EA	1	7	302	500
CARD INSTRUCTION IN INMATE						
260412960	N	EA	1	7	502	1000
CARD INSTRUCTION IN INMATE						
260407218	N	EA	1	7	11	500
CARD INSTRUCTION IN LOWER						
260407226	N	EA	1	7	12	500
CARD INSTRUCTION IN LOWER						
260407192	N	EA	1	7	9	1000
CARD INSTRUCTION IN UPPER						
260407200	N	EA	1	7	10	1000
CARD INSTRUCTION IN UPPER						
260412929	N	EA	1	7	109	500
CARD INSTRUCTION IN UPPER						
260412937	N	EA	1	7	110	500
CARD INSTRUCTION IN UPPER						
260413018	N	EA	1	7	203	500
CARD INSTRUCTION MI CAC						
260417779	N	EA	1	7	203A	500
CARD INSTRUCTION MI CAC						
260413026	N	EA	1	7	303	500
CARD INSTRUCTION MI INMATE						
260407259	N	EA	1	7	15	500
CARD INSTRUCTION MI LOWER						
260407267	N	EA	1	7	16	500
CARD INSTRUCTION MI LOWER						
260407234	N	EA	1	7	13	1000
CARD INSTRUCTION MI UPPER						

PRODUCT IDENTIFIER		DESCRIPTION				
ITEM NUMBER	ORD. MULT.	SELL UNIT	STD. PKG. STOCK AVAILABILITY / PA	LEAD TIME	MIN. ORD.	A C
260412978	N	EA	1	7	13A	1000
CARD INSTRUCTION MI UPPER						
260407242	N	EA	1	7	14	1000
CARD INSTRUCTION MI UPPER						
260412986	N	EA	1	7	14A	1000
CARD INSTRUCTION MI UPPER						
260412994	N	EA	1	7	113	500
CARD INSTRUCTION MI UPPER						
260413000	N	EA	1	7	114	500
CARD INSTRUCTION MI UPPER						
260412895	N	EA	1	7	204	500
CARD INSTRUCTION OH CAC						
260412903	N	EA	1	7	304	500
CARD INSTRUCTION OH INMATE						
260412911	N	EA	1	7	404	1000
CARD INSTRUCTION OH INMATE						
260407291	N	EA	1	7	19	500
CARD INSTRUCTION OH LOWER						
260407309	N	EA	1	7	20	500
CARD INSTRUCTION OH LOWER						
260407275	N	EA	1	7	17	1000
CARD INSTRUCTION OH UPPER						
260407283	N	EA	1	7	18	1000
CARD INSTRUCTION OH UPPER						
260412879	N	EA	1	7	117	500
CARD INSTRUCTION OH UPPER						
260412887	N	EA	1	7	118	500
CARD INSTRUCTION OH UPPER						
260412853	N	EA	1		205	1
CARD INSTRUCTION WI CAC						
260413828	N	EA	1		205A	1
CARD INSTRUCTION WI CAC						
260412861	N	EA	1		305	1
CARD INSTRUCTION WI INMATE						
260407358	N	EA	1		25	1
CARD INSTRUCTION WI LOWER						
260407366	N	EA	1		26	1
CARD INSTRUCTION WI LOWER						
260407374	N	EA	1		27	1
CARD INSTRUCTION WI LOWER						
260407382	N	EA	1		28	1
CARD INSTRUCTION WI LOWER						

DISTRIBUTION SERVICES

NETWORK SERVICES

TOOLS

BUILDING JANITORIAL

AUTOMOTIVE

FORMS/OFFICE SUPPLIES

GENERAL

DATA VOICE

DISTRIBUTION SERVICES

NETWORK SERVICES

TOOLS

BUILDING JANITORIAL

AUTOMOTIVE

FORMS/OFFICE SUPPLIES

GENERAL

DATA VOICE

PUBLIC COMMUNICATION EQUIPMENT

PRODUCT IDENTIFIER		DESCRIPTION					
ITEM NUMBER	ORD. MULT.	SELL UNIT	STD. PKG. STOCK AVAILABILITY / PA	LEAD TIME	MIN. ORD.	A C	
260407390		CARD INSTRUCTION WI LOWER	29				
N		EA	1		1		
260407317		CARD INSTRUCTION WI UPPER	21				
N		EA	1		1		
260407325		CARD INSTRUCTION WI UPPER	22				
N		EA	1		1		
260407333		CARD INSTRUCTION WI UPPER	23				
N		EA	1		1		
260407341		CARD INSTRUCTION WI UPPER	24				
N		EA	1		1		
260412812		CARD INSTRUCTION WI UPPER	121				
N		EA	1		1		
260412820		CARD INSTRUCTION WI UPPER	122				
N		EA	1		1		
260412838		CARD INSTRUCTION WI UPPER	123				
N		EA	1		1		
260412846		CARD INSTRUCTION WI UPPER	124				
N		EA	1		1		
280052077		CHASSIS ASSEMBLY CTR400MTG4					
1950105	1	EA	IL IN MI OH WI				
			59				
260344247		CHASSIS ASSEMBLY CTR400MTG5					
1950196	1	EA	IL IN MI OH WI				
			59				
260388384		CHASSIS COIN 32C					
1964197	1	EA	IL IN MI OH WI				
			59 59 59 59 59				
			Replacement for Chassis Coin 32B.				
260422779		CHASSIS COIN 434-983					
1979153	1	EA	IL IN MI OH WI				
102279395		CHUTE COIN 20A					
1180935	1	EA	IL IN MI OH WI				
			59 59 59 59 59				
			A new improved coin chute for 1A or 1C coin telephone, BSP 506-401-100.				
105524011		CHUTE COIN 22A ELECTRONIC					
1961029	1	EA	IL IN MI OH WI				
			59 59 59 59 59				
260422795		CHUTE COIN ELECTRONIC 434-984					
1979138	1	EA	IL IN MI OH WI				
			58 58 58 58 58				
260432422		CHUTE COIN ELECTRONIC MARS C/D					
1980599	1	EA	IL IN MI OH WI				
			59 59 59 59 59				
			LPV200WE. Used with Harness C Mars C/D Chute (260432794) and Harness D Mars C/D Chute (260432802) for use in Type 1C & 1D public coin telephones.				

PRODUCT IDENTIFIER		DESCRIPTION					
ITEM NUMBER	ORD. MULT.	SELL UNIT	STD. PKG. STOCK AVAILABILITY / PA	LEAD TIME	MIN. ORD.	A C	
811557305		CHUTE RETURN ASSEMBLY P15E730					
N		EA	36		2	36	
300029337		CLEANER GRAFFITI HEAVY DUTY					
5106393	1	CS	IL IN MI OH WI				
			58 58 58 58 58				
			24oz per can, 12 cans per case.				
811554914		COIN RETURN ASSEMBLY P15E491					
N		EA	17		2	17	
812165462		COIN RETURN ASSEMBLY P21F546					
1222695	1	EA	IL IN MI OH WI				
			58 58 58 58 58				
			Money return assembly for coin telephone.				
260322748		COIN STATION AUDITOR C SET					
N		EA	30		13	30	
260322755		COIN STATION AUDITOR D SET					
N		EA	30		13	30	
260422829		CONNECTOR DIAL/CHASSIS 434-912					
1979104	1	EA	IL IN MI OH WI				
260422894		CONNECTOR INSIDE WIRE 434-919					
1979039	1	EA	IL IN MI OH WI				
400130548		CONTROL LIGHT CK19261 L2					
1311266	1	EA	IL IN MI OH WI				
			58 58 58 58 58				
			Provides automatic control for booth lights. BSP 508-352-100.				
402252498		CONTROL LIGHT CK19261 L5					
N		EA	1		3	1	
101435931		CORD P11C 87 6FT					
1311209	1	EA	IL IN MI OH WI			E	
			12 12 12 12 12				
			Each with 86-CP11 plug & 78S11 socket. Used with 1A1 single slot coin telephone sets.				
403443633		COVER BASE L905594					
N		EA	1		6	1	
			For CK20842 L143.				
101146546		COVER COIN RECEPTACLE 1E					
1333336	1	EA	IL IN MI OH WI				
			58 58 58 58 58				
			For use in coin telephones to collect monies.				
260344189		COVER HDM0019900B PACKAGE OF 100					
1950162	1	PK	IL IN MI OH WI				
			04 04				
811057835		COVER P10E783					
1209940	1	EA	IL IN MI OH WI				
			59 59 59 59 59				
260406517		DECAL PC68 IBT 7 X 7					
1970079	1	EA	IL IN MI OH WI				
			08				

PRODUCT IDENTIFIER		DESCRIPTION				
ITEM NUMBER	ORD. MULT.	SELL UNIT	STD. PKG. STOCK AVAILABILITY / PA	LEAD TIME	MIN. ORD.	A C
260395504		DECAL-NO LOITERING-	IBTNLS			
N		EA	1	5	100	
260363387		DEFUSER LIGHT DOME TOP 245-0121				
N		EA	10	5	10	
A plastic light defuser for the top of PC-7, PC-7-WC and PC-7-RA coin enclosures.						
102445350		DIAL 8WA52				
N		EA	16	2	16	
For use with 1A1, 1C1, 2A1, 2C1 or 1E1 coin telephone set. This dial resists unauthorized removal of the dial finger wheel, BSP 501-162-100.						
104174230		DIAL 70C				
1334219	1	EA	IL 59 IN 59 MI 59 OH 59 WI 59			
260422811		DIAL BOARD INTERFACE 434-908				
1979112	1	EA	IL IN MI OH WI			
260422837		DIAL SWITCHPAD W/CONNECTOR CABLE				
1979096	1	EA	IL IN MI OH WI			
434-902.						
260422225		DIFFUSER 31K B-342 - WI				
N		EA	1	4	1	
260422217		DIFFUSER 31K B-344 - IL				
N		EA	1	4	1	
260404223		DIFFUSER FRONT 115-BF IBT				
N		EA	1	4	1	
260404215		DIFFUSER SIDE 115-BF IBT				
N		EA	1	4	1	
300036423		DIRECTORY BINDER 1 1/2IN DB0150				
8406215	1	EA	IL IN MI OH WI 33			
Wisconsin Bell.						
300009024		DIRECTORY BINDER 3IN DB-0300				
8400606	1	EA	IL IN MI OH WI 33			
Wisconsin Bell.						
300078136		DIRECTORY BINDER 4IN DB0400				
8412734	1	EA	IL IN MI OH WI 33			
Wisconsin Bell.						
300036431		DIRECTORY SWIVEL SGL DH0100 1IN				
1197277	1	EA	IL IN MI OH WI 33			
Wisconsin Bell.						
101002145		DOOR 2A 03				
1201004	1	EA	IL IN MI OH WI 59			

PRODUCT IDENTIFIER		DESCRIPTION				
ITEM NUMBER	ORD. MULT.	SELL UNIT	STD. PKG. STOCK AVAILABILITY / PA	LEAD TIME	MIN. ORD.	A C
101469039		DOOR 2A 44				
1229245	1	EA	IL 58 IN 58 MI 58 OH 58 WI 58			
Chrome doors for cash compartment on 1A1 and 1C coin telephones.						
102508371		DOOR 2B 03 BLACK				
N		EA	1	2	1	
102508389		DOOR 2B 44 CHROME				
N		EA	1	2	1	
101573954		DOOR 5A 67				
N		EA	5	2	5	
280052101		EPROM ICM0127C256-PROGRAM				
N		EA	10	14	10	
260344239		EXTENDER CABLE W1CA100006				
1950188	1	EA	IL IN MI OH WI 59			
840156301		FACEPLATE COIN 1C/1D TT				
1152744	1	EA	IL 59 IN 59 MI 59 OH 59 WI 59			
Chrome faceplate used with 1C2 and 1D2 coin telephones.						
840151872		FINGERWHEEL 840151872				
1161570	1	EA	IL 59 IN 59 MI 59 OH 59 WI 59			
For 1D1 and 2D1 coin telephones.						
002093458		FISHPLATE MOUNTING MEMBER FP R				
1218891	1	EA	IL 58 IN 58 MI 58 OH 58 WI 58			
260317862		FIXTURE LIGHT 748 OAK				
N		EA	1	2	1	
403252273		FIXTURE LIGHT 748 TEAK				
N		EA	1	2	1	
403252281		FIXTURE LIGHT 748 WALNUT				
N		EA	1	2	1	
280093386		FRAME PB-23 CLEAR 520-4580				
1936930	1	EA	IL IN MI OH WI 58			
Mark box invoice & packing slip with our PID.						
260395090		FUSE CARTRIDGE TSD2 125V 375MA				
N		PK	1	5	10	
For use with chassis 32C, pack 10.						
840156350		GROMMET BLUE FOR COIN HANDSET				
N		EA	200	2	200	
260344544		GUIDE CARD READER CTCRDG404				
1950303	1	EA	IL IN MI OH WI 59			

DISTRIBUTION SERVICES

NETWORK SERVICES

TOOLS

BUILDING JANITORIAL

AUTOMOTIVE

FORMS/OFFICE SUPPLIES

GENERAL

DATA VOICE

PUBLIC COMMUNICATION EQUIPMENT

DISTRIBUTION SERVICES

PRODUCT IDENTIFIER		DESCRIPTION						
ITEM NUMBER	ORD. MULT.	SELL UNIT	STD. PKG. STOCK AVAILABILITY / PA	LEAD TIME	MIN. ORD.	A	C	

260432794 HARNESS C MARS C/D CHUTE
 1980581 1 EA IL IN MI OH WI
 59 59 59 59 59
 For use with Chute Coin Electronic Mars C/D LPV200WE (260432422) and Type 1C public coin telephone.

260432802 HARNESS D MARS C/D CHUTE
 1980573 1 EA IL IN MI OH WI
 59 59 59 59 59
 For use with Chute Coin Electronic Mars C/D LPV200WE (260432422) and Type 1D public coin telephone.

260344262 HARNESS INTERFACE W1CA400010
 1950121 1 EA IL IN MI OH WI
 59

260344270 HARNESS INTERFACE W1CA400019
 1950113 1 EA IL IN MI OH WI
 59

996043428 HEAD MAGNETIC CK14652 L2
 N EA 1 2 1

260404132 HOLDER DIRECTORY DH-3
 N EA 1 4 1

260404140 HOLDER DIRECTORY DH-4 1/2
 N EA 1 4 1

260344213 HOOKSWITCH ASSEMBLY HKS0061
 1950147 1 EA IL IN MI OH WI
 59

260344221 HOOKSWITCH HOUSING KIT HKS0001
 1950139 1 EA IL IN MI OH WI
 58 58

102607389 HOPPER 51A
 N EA 12 2 12

811557172 HOPPER COIN ASSEMBLY
 N EA 1 2 1

260355615 HOUSING 2000 213-27M IBT
 N EA 1 5 1
 Complete with Illinois Bell sign art.

260304183 HOUSING 2000 213-39N WI
 1940718 1 EA IL IN MI OH WI
 57
 Complete with Wisconsin Bell sign art.

260355623 HOUSING 2000A 213-27MAL IBT
 N EA 1 5 1
 Complete with Illinois Bell sign art.

402617450 HOUSING CK20842 L31A/60 IL
 1227827 1 EA IL IN MI OH WI
 57

400895777 HOUSING CK20842 L31/60 IL
 1202358 1 EA IL IN MI OH WI
 57

NETWORK SERVICES

TOOLS

BUILDING JANITORIAL

AUTOMOTIVE

FORMS/OFFICE SUPPLIES

GENERAL

DATA VOICE

PRODUCT IDENTIFIER		DESCRIPTION						
ITEM NUMBER	ORD. MULT.	SELL UNIT	STD. PKG. STOCK AVAILABILITY / PA	LEAD TIME	MIN. ORD.	A	C	

260412291 HOUSING CK20842 L31/60 MI
 N EA 1 6 1

401496716 HOUSING CK20842 L31/67 IL
 N EA 1 6 1

401024120 HOUSING CK20842 L33/67 IL
 1150094 1 EA IL IN MI OH WI
 57

401884333 HOUSING CK20842 L35A/61 IL
 N EA 1 6 1

841382021 HOUSING LOWER 841382021
 N EA 1 2 1

401953864 HOUSING PANEL BPH-R
 1139006 1 EA IL IN MI OH WI
 57 57 57 57

402208227 HOUSING PANEL BPH-SR
 N EA 1 5 1

260404116 HOUSING PANEL BPH-SR/1CC
 N EA 1 4 1

280015744 HOUSING PROFILE 213- 39RA1-WI
 N EA 1 4 1
 RA1 phone only, BL/WH bronze porcelain.

280015777 HOUSING PROFILE 213- 39RA2-WI
 N EA 1 4 1
 RA2 phone only, BR/WH bronze porcelain.

280015736 HOUSING PROFILE 252-107R - WI
 N EA 1 4 1
 Wall mount phone only, blue/bronze porcelain.

841382013 HOUSING UPPER 841382013
 N EA 1 2 1

101404465 KEY COIN FOR 29A18 OH
 N EA 1 15 25
 See attached key sign authorization.

101404507 KEY COIN FOR 29A22 IL
 N EA 1 15 25
 See attached key sign authorization.

101404754 KEY COIN FOR 29A47 IN
 N EA 1 15 25
 See attached key sign authorization.

101404770 KEY COIN FOR 29A49 MI
 N EA 1 15 25
 See attached key sign authorization.

101404812 KEY COIN FOR 29A53 WI
 N EA 1 15 25
 See attached key sign authorization.

260337894 KEY COIN KY624650-R101
 N EA 1 7 1

DISTRIBUTION SERVICES

NETWORK SERVICES

TOOLS

BUILDING JANITORIAL

AUTOMOTIVE

FORMS/OFFICE SUPPLIES

GENERAL

DATA VOICE

PRODUCT IDENTIFIER		DESCRIPTION					
ITEM NUMBER	ORD. MULT.	SELL UNIT	STD. PKG. STOCK AVAILABILITY / PA	LEAD TIME	MIN. ORD.	A C	
260337886 KEY COIN KY634650-R101							
N		EA	1	7	1		
401316369 KIT ASSEMBLY CK20842 L 72							
1228577	1	EA	IL IN MI OH WI 04				
Sign mounting assembly bracket.							
260413711 KIT LOW VOLTAGE BN6738							
N		EA	1	2	1		
101467199 KIT OF PARTS D180042							
N		EA	1	2	1		
Coin level detector used in 1C2/1D2 type coin telephone. Requires Kit of Parts D180110 for operation.							
101568350 KIT OF PARTS D180110							
N		EA	1	2	1		
Coin level detector used in 1C2/1D2 type coin telephone. Requires Kit of Parts D180042 for operation.							
102559986 KIT OF PARTS D180567							
1103358	1	EA	IL IN MI OH WI 59 59 59 59 59				
Window, bracket and nuts for number card holder for 1C2/1D2 type coin telephone, BSP 506-410-400.							
103105284 KIT OF PARTS D180848							
1195693	1	EA	IL IN MI OH WI 58 58 58 58				
Magnetic coin stop assembly blocks coin slot for Canadian coin and slug attempts.							
103241857 KIT OF PARTS D180893							
1221713	1	EA	IL IN MI OH WI 58 58 58 58				
Polarity guard for use in DTF Coin Telephone Sets, BSP 506-410-400.							
103868196 KIT OF PARTS D181172							
1152918	1	EA	IL IN MI OH WI 58 58 58 58 58				
Three piece armored cord retainer anchors handset armored cord on 1C/1D type coin telephone.							
105029904 KIT OF PARTS D181388							
N		EA	1	2	1		
Converts 31A/31A2 chassis to be compatible with 70C dial in 1C2/2C2 type coin telephones.							
105063739 KIT OF PARTS D181515							
N		EA	1	4	1		
105364277 KIT OF PARTS D181815 BUTTON LOUD							
1953323	1	EA	IL IN MI OH WI 58 58 58 58 58				
Loud button retrofit kit for 1C/1D type coin telephone.							
108043722 KIT OF PARTS D182303 BUTTON LOUD							
N		EA	1	4	1		
Loud button retrofit kit for 2C2/2D2 type coin telephones.							

PRODUCT IDENTIFIER		DESCRIPTION					
ITEM NUMBER	ORD. MULT.	SELL UNIT	STD. PKG. STOCK AVAILABILITY / PA	LEAD TIME	MIN. ORD.	A C	
260422902 KIT PANEL ADAPTER 434-920							
1979021	1	EA	IL IN MI OH WI				
260441076 KIT RETRO STATION MANAGEMENT CDRFK-2							
N		EA	6	9	6		
280047770 KIT RETROFIT COIN CTR-400I							
N		KT	7	14	7		
260322763 KIT RETROFIT COIN CTR-400IP							
N		KT	1	14	1		
260433230 KIT RETROFIT INMATE 4010RT 11B							
N		EA	1	8	1		
For use with AT&T 10A or 11B public coinless set.							
260433248 KIT RETROFIT INMATE 4010RT 1D							
N		EA	1	8	1		
For use with AT&T 1D short case public coin set.							
260392071 KIT RETROFIT STATION MANAGEMENT CDRFK-1							
N		EA	6	9	6		
401903323 LANYARD 500004 STANDARD 16IN							
N		EA	1	5	52		
001222629 LANYARD 500010 STANDARD 18IN							
8369587	1	EA	IL IN MI OH WI 58 58 58 58				
An 18in standard lanyard for use with directory binders at coin phone locations, BSP 508-710-101.							
402735021 LANYARD 500023 STANDARD 24IN							
N		EA	1	5	41		
401344213 LANYARD 500039 UNIVERSAL MT 16IN							
N		EA	1	5	32		
401344221 LANYARD 500235 UNIVERSAL MT 18IN							
N		EA	1	5	32		
401903331 LANYARD UNIVERSAL 16IN							
5214809	1	EA	IL IN MI OH WI 58 58 58 58 58				
For use with coin telephone installations.							
280015793 LENS DIFFUSER B-152							
N		EA	1	4	1		
280015801 LENS FRONT B-152							
N		EA	1	4	1		
260413117 LENS INSTRUCTION CARD 10A/11B TT 600							
1977603	20	EA	IL IN MI OH WI 58 58 58 58 58				
For Public Telephone Instruction Card. Clear lens to fit over regular C-A-C and the Inmate Instruction Card.							

PUBLIC COMMUNICATION EQUIPMENT

DISTRIBUTION SERVICES

PRODUCT IDENTIFIER		DESCRIPTION						
ITEM NUMBER	ORD. MULT.	SELL UNIT	STD. PKG. STOCK AVAILABILITY / PA	LEAD TIME	MIN. ORD.	A	C	

260348685			LENS INSTRUCTION CARD LOWER 1D2TT					
1977322	50	EA	IL 58	IN 58	MI 58	OH 58	WI 58	
For Public Telephone Instruction Card, H.R. 971.								

260348677			LENS INSTRUCTION CARD UPPER 1D2TT					
1977330	50	EA	IL 58	IN 58	MI 58	OH 58	WI 58	
For Public Telephone Instruction Card, H.R. 971.								

840358725			LEVER COIN RETURN A/K/A SHAFT HOLDER ASY					
1934349	1	EA	IL 58	IN 58	MI 58	OH 58	WI 58	
Coin telephone release lever.								

100317825			LOCK 29A18					
3176701	1	EA	IL 58	IN 58	MI 58	OH 58	WI 58	
Used with 1D and 2D series coin telephones.								

100317866			LOCK 29A22					
1166314	1	EA	IL 58	IN 58	MI 58	OH 58	WI 58	
Coin cover unit IL. See attached lock sign Authorization.								

100318112			LOCK 29A47 COVER UNIT					
N		EA	25		6		25	
See attached lock sign Authorization.								

100318138			LOCK 29A49					
1130658	1	EA	IL 58	IN 58	MI 58	OH 58	WI 58	
See attached lock sign Authorization.								

100318179			LOCK 29A53					
1167874	1	EA	IL 58	IN 58	MI 58	OH 58	WI 04	
See attached lock sign Authorization.								

260337878			LOCK COIN LH12 W/2 KEYS					
N		EA	25		9		25	

260344825			LOCK COIN LH12 W/3 KEYS					
N		EA	25		7		25	

402317143			MAST CK20842 L170 STANDARD					
1440602	1	EA	IL 58	IN 58	MI 58	OH 58	WI 58	

402317150			MAST CK20842 L176 INTERMEDIATE					
5403147	1	EA	IL 57	IN 57	MI 57	OH 57	WI 57	

402317168			MAST CK20842 L177 SHORT					
N		EA	1		6		1	

280018821			MAST CLEAR R4 520-4249					
N		EA	1		12		1	

401780911			MAST MT L					
1192450	1	EA	IL 58	IN 58	MI 58	OH 58	WI 58	
A 10 foot mast for use with housing 107X and impulser sign.								

NETWORK SERVICES

TOOLS

BUILDING JANITORIAL

AUTOMOTIVE

FORMS/OFFICE SUPPLIES

GENERAL

DATA VOICE

PRODUCT IDENTIFIER		DESCRIPTION						
ITEM NUMBER	ORD. MULT.	SELL UNIT	STD. PKG. STOCK AVAILABILITY / PA	LEAD TIME	MIN. ORD.	A	C	

280015827			MODULE WALL MOUNT 220/0M1					
N		EA	1		5		1	

402826655			MOUNTING WALL CK20842 L42A					
1447185	1	EA	IL 04	IN 58	MI 58	OH 58	WI 58	

402317176			MOUNTING WALL CK20842 L42L					
N		EA	1		6		1	
Equipped with control light.								

260422878			NUT RETAINER CHASSIS 434-038					
1979054	1	EA	IL 58	IN 58	MI 58	OH 58	WI 58	

840692313			OSCILLATOR ASSEMBLY 840692313					
N		EA	1		2		1	
Used with rotary coin phone.								

811056886			P10E688 TRAP					
1191767	1	EA	IL 59	IN 59	MI 59	OH 59	WI 59	
A part of the coin trap and trap lever assembly, BSP 506-410-400.								

811554443			P15E444 PLATE COVER					
N		EA	225		2		225	

811559848			P15E984 ARM REJECT ASSEMBLY					
N		EA	1		2		1	

811559970			P15E997 DIME & QUARTER ARM					
N		EA	1		2		1	

811655646			P16E564 CAP ASSEMBLY					
1211409	1	EA	IL 58	IN 58	MI 58	OH 58	WI 58	

811655653			P16E565 CAP ASSEMBLY					
N		EA	100		1		100	

812169472			P21F947 BRACKET CARD HOLDER					
N		EA	1		2		1	

812169480			P21F948 WINDOW					
N		EA	1		2		1	

812260081			P22F008 GROMMET					
N		EA	1		2		1	

812363612			P23F361 STOP ENTRANCE					
N		EA	1		2		1	

812365906			P23F590 SPRING					
N		EA	1		2		1	

812367902			P23F790 SCREW					
1311829	1	EA	IL 58	IN 58	MI 58	OH 58	WI 58	
1/4in-20 X 5/8in right hand machine screw for booths and backboards.								

812450146			P24E014 NICKEL SEPARATOR					
N		EA	1		2		1	

PUBLIC COMMUNICATION EQUIPMENT

PRODUCT IDENTIFIER		DESCRIPTION						
ITEM NUMBER	ORD. MULT.	SELL UNIT	STD. PKG. STOCK AVAILABILITY / PA	LEAD TIME	MIN. ORD.	A	C	
812450153		P24E015	DIME SEPARATOR					
N		EA	1	2	1			
812450161		P24E016	QUARTER SEPARATOR					
N		EA	1	2	1			
812453231		P24E323	QUARTER DIVIDER ASSEMBLY					
N		EA	1	2	1			
812453249		P24E324	DIME DIVIDER ASSEMBLY					
N		EA	1	2	1			
802520262		P252026	ROTARY ARM ASSEMBLY					
1223081	1	EA	IL	IN	OH	WI		
			58	58				
812750412		P27E041	DAMPER ARM ASSEMBLY					
N		EA	1	2	1			
802841486		P284148	WASHER					
1158659	1000	EA	IL	IN	MI	OH	WI	
			58					
834080111		P40Y110	SPRING BOOSTER					
N		EA	1	2	1			
818418527		P84A852	NUMBER PLATE					
N		EA	1	2	1			
260344254		PACK BATTERY CTRBATAY04						
1950089	1	EA	IL	IN	MI	OH	WI	
			58	58				
260365473		PANEL BPH-R-ICC						
N		EA	1	5	1			
400164323		PANEL CK19580 L10 GLASS						
1101899	1	EA	IL	IN	MI	OH	WI	
			04	04	04	04	04	
Tempered glass panels for CK19580 booth. Small side panel 7/32in thick, BSP 508-354-100.								
400164349		PANEL CK19580 L12 GLASS						
1206540	1	EA	IL	IN	MI	OH	WI	
			04	04	04			
Tempered glass panels for CK19580 booth. Large side panel 7/32in thick, BSP 508-354-100.								
260380589		PANEL CLEAR FOR 115-BF						
N		EA	1	3	1			
260317797		PANEL G 8 OAK						
N		EA	1	2	1			
260317805		PANEL G 8 TEAK						
N		EA	1	2	1			
401351507		PANEL G 8 WALNUT						
N		EA	1	2	1			
260317813		PANEL G10 OAK						
N		EA	1	2	1			
260317821		PANEL G10 TEAK						
N		EA	1	2	1			

PRODUCT IDENTIFIER		DESCRIPTION					
ITEM NUMBER	ORD. MULT.	SELL UNIT	STD. PKG. STOCK AVAILABILITY / PA	LEAD TIME	MIN. ORD.	A	C
260317839		PANEL G10 WALNUT					
N		EA	1	2	1		
260317847		PANEL G84 OAK					
N		EA	1	2	1		
260317854		PANEL G84 TEAK					
N		EA	1	2	1		
402443410		PANEL G84 WALNUT					
N		EA	1	2	1		
300045804		PANEL G85 OAK					
N		EA	1	2	1		
402163091		PANEL G85 TEAK					
N		EA	1	2	1		
401351515		PANEL G85 WALNUT					
N		EA	1	2	1		
260404207		PANEL VIEWTEL 115-BF PIZZA HUT					
N		EA	1	4	1		
260380597		PANEL VIEWTEL 115-BF WENDY'S					
N		EA	1	3	1		
280026071		PEDESTAL 230-0M1 FORTEC 2 PIECE					
N		EA	1	4	1		
280002122		PEDESTAL 270-0M1 TRI/QUAD					
N		EA	1	4	1		
280002130		PEDESTAL TRI/QUAD 270-072					
N		EA	1	4	1		
280003294		PEDESTAL 1 PC 2100-0MA					
N		EA	1	4	1		
280015835		PEDESTAL 48IN ASSEMBLY 240-0M1					
1940767	1	EA	IL	IN	MI	OH	WI
							57
Assembled & ship complete.							
260304191		PEDESTAL 54IN 2100-0M1					
1940742	1	EA	IL	IN	MI	OH	WI
							57
260322219		PEDESTAL 54IN FLUSH 2110-0M1					
N		EA	1	5	1		
260317763		PEDESTAL 7000 OAK					
N		EA	1	2	1		
402704290		PEDESTAL 7000 TEAK					
N		EA	1	2	1		
402739106		PEDESTAL 7000 WALNUT					
1131417	1	EA	IL	IN	MI	OH	WI
			57	57	57	57	
For use with 7409 and 8409 shelves.							
260317193		PEDESTAL 7000A OAK					
N		EA	1	2	1		

DISTRIBUTION SERVICES

NETWORK SERVICES

TOOLS

BUILDING JANITORIAL

AUTOMOTIVE

FORMS/OFFICE SUPPLIES

GENERAL

DATA VOICE

DISTRIBUTION SERVICES

NETWORK SERVICES

TOOLS

BUILDING JANITORIAL

AUTOMOTIVE

FORMS/OFFICE SUPPLIES

GENERAL

DATA VOICE

PUBLIC COMMUNICATION EQUIPMENT

PRODUCT IDENTIFIER		DESCRIPTION						
ITEM NUMBER	ORD. MULT.	SELL UNIT	STD. PKG. STOCK AVAILABILITY / PA	LEAD TIME	MIN. ORD.	A	C	
260317201		EA	1	2	1			
PEDESTAL 7000A TEAK								
N		EA	1	2	1			
300045705		EA	1	2	1			
PEDESTAL 8000 OAK								
N		EA	1	2	1			
260317771		EA	1	2	1			
PEDESTAL 8000 TEAK								
N		EA	1	2	1			
260317789		EA	1	2	1			
PEDESTAL 8000 WALNUT COIN								
1946988	1	EA	IL IN MI OH WI 57 57 57 57 57					
260317417		EA	1	2	1			
PEDESTAL 8000A OAK								
N		EA	1	2	1			
260317425		EA	1	2	1			
PEDESTAL 8000A TEAK								
N		EA	1	2	1			
280003278		EA	1	3	1			
PEDESTAL ADCO PSW-2-90L								
N		EA	1	3	1			
280003286		EA	1	3	1			
PEDESTAL ADCO PW-6-90L								
N		EA	1	3	1			
260435847		EA	IL IN MI OH WI					
PEDESTAL AM PEIL 2-1-12 TIX								
1980342		EA	IL IN MI OH WI					
260435862		EA	IL IN MI OH WI 09 09 09 09 09					
PEDESTAL AMPEIL2-1-12 TIXMM								
1980367		EA	IL IN MI OH WI 09 09 09 09 09					
260435870		EA	IL IN MI OH WI					
PEDESTAL AMRPEIL1-1-12 IX								
1980375		EA	IL IN MI OH WI					
260435854		EA	IL IN MI OH WI					
PEDESTAL AMRPEIL2-1-12 TIX								
1980359		EA	IL IN MI OH WI					
260435888		EA	IL IN MI OH WI					
PEDESTAL AMRPEIL2-1-12 TIXMM								
1980383		EA	IL IN MI OH WI					
280002114		EA	1	4	1			
PEDESTAL BACK-TO-BACK 260-0M1								
N		EA	1	4	1			
280026089		EA	1	4	1			
PEDESTAL BACK-TO-BACK 260-0M2								
N		EA	1	4	1			
280002148		EA	1	4	1			
PEDESTAL FLUSH 2110-0M2								
N		EA	1	4	1			
280014101		EA	1	4	1			
PEDESTAL P-45								
N		EA	1	4	1			
280014093		EA	1	4	1			
PEDESTAL P-45-L								
N		EA	1	4	1			
280062522		EA	IL IN MI OH WI 57 57 57 57 57					
PEDESTAL R-4 STEEL BLACK								
1934455	1	EA	IL IN MI OH WI 57 57 57 57 57					
For single installation.								

PRODUCT IDENTIFIER		DESCRIPTION						
ITEM NUMBER	ORD. MULT.	SELL UNIT	STD. PKG. STOCK AVAILABILITY / PA	LEAD TIME	MIN. ORD.	A	C	
834080368		EA	IL IN MI OH WI 58 58 58 58 58					
PIN TRAP P40Y036								
1311753	1	EA	IL IN MI OH WI 58 58 58 58 58					
A part of the coin trap and trap lever assembly, BSP 506-410-400.								
840360358		EA	1	2	1			
PLATE FACE 840360358								
N		EA	1	2	1			
280002221		EA	2	5	2			
PLATE FISH 8IN K-26								
N		EA	2	5	2			
For Fortec profile 2000 series pedestal-buried base.								
840156327		EA	IL IN MI OH WI 59 59 59 59 59					
PLATE INFORMATION 840156327								
2658989	1	EA	IL IN MI OH WI 59 59 59 59 59					
Used on Dial Tone First stations, BSP 506-410-400.								
260404199		EA	1	4	1			
POST ASP-R								
N		EA	1	4	1			
260405576		EA	1	5	1			
POST BUMPER T112-0217								
N		EA	1	5	1			
402377659		EA	1	6	1			
POST CK20842 L105 QUAD								
N		EA	1	6	1			
402965453		EA	1	6	1			
POST CK20842 L118								
N		EA	1	6	1			
402317127		EA	1	6	1			
POST CK20842 L141 DRIVE UP								
N		EA	1	6	1			
402319057		EA	IL IN MI OH WI 57 57 57 57 57					
POST CK20842 L141L								
1162198	1	EA	IL IN MI OH WI 57 57 57 57 57					
Equipped with control light.								
402317135		EA	1	6	1			
POST CK20842 L143 DRIVE UP								
N		EA	1	6	1			
402319065		EA	IL IN MI OH WI 57 57 57 57 57					
POST CK20842 L143L								
1128652	1	EA	IL IN MI OH WI 57 57 57 57 57					
E/W control light.								
402769244		EA	1	6	1			
POST CK20842 L144 FLUSH								
N		EA	1	6	1			
403397904		EA	1	6	1			
POST CK20842 L148 INDOOR								
N		EA	1	6	1			
401494604		EA	IL IN MI OH WI 08 08 08 08 08					
POST MOUNTING SIGN U-CHANNEL 7FT								
4193300	1	EA	IL IN MI OH WI 08 08 08 08 08					
For mounting buried cable signs, green, Urban Areas, BSP 629-200-235N.								
002082600		EA	IL IN MI OH WI 57 57 57 57 57					
POST SSP-R								
1107839	1	EA	IL IN MI OH WI 57 57 57 57 57					

PRODUCT IDENTIFIER		DESCRIPTION						
ITEM NUMBER	ORD. MULT.	SELL UNIT	STD. PKG. STOCK AVAILABILITY / PA	LEAD TIME	MIN. ORD.	A	C	
101903151 RECEPTACLE COIN 1C86								
1333344	1	EA	IL IN MI OH WI 58 58 58 58 58					
400444329		EA	1	4	1			
401955570 REEL CORD ASSEMBLY CK21428 L7								
N		EA	1	12	10			
101755650 RELAY COIN 1A								
1121970	1	EA	IL IN MI OH WI 59 59 59 59 59					
Relay for 1A1 Coin tel set, consists of a switch assembly, coil and core assembly, coin trigger, card selector assembly and a 1000 ohm resistor assembled to an alignment plate.								
101755668		EA	1	2	1			
260422787 RINGER COIN 434-913								
1979146	1	EA	IL IN MI OH WI					
260344205 RINGER HDS408520A								
1950170	1	EA	IL IN MI OH WI 59					
900307042 ROD MOUNTING COIN 18IN W/NUT								
2747261	1	EA	IL IN MI OH WI 58 58 58 58					
Complete with nut screwed on rod, standard package is 100 per box.								
840155600 SCREW 1/4IN CAP FOR COIN COVER								
1144253	4	EA	IL IN MI OH WI 18 18 18 18 18					
840157390		EA	1	2	1			
840153381 SCREW FOR INSTRUCTION CARD 1C/1D								
N								
280015868		PK	1	2	1			
F-264, 50 per package.								
280015876		PK	1	2	1			
F-265, 50 per package.								
280015884		PK	1	2	1			
F-050, Black.								
260345046		EA	1	6	1			
260345053		EA	1	6	1			
260345061		EA	1	6	1			

PRODUCT IDENTIFIER		DESCRIPTION						
ITEM NUMBER	ORD. MULT.	SELL UNIT	STD. PKG. STOCK AVAILABILITY / PA	LEAD TIME	MIN. ORD.	A	C	
280013616 SEAL BAG COIN PUBLIC								
N		PK	1	3	2			
Package of 250.								
401375134 SEAL BAG COIN RED CAP 23IN								
5856504	1	EA	IL IN MI OH WI 31					
For use to secure cloth coin bags.								
260444906 SEAL BAG COIN RED CAP 30IN								
N		EA	2000	8	2000			
For use to secure cloth coin bag.								
900506668 SEAL BAG COIN SECURITY 27IN								
1133124	1	EA	IL IN MI OH WI 33					
Yellow cap.								
260380571 SEAL GASKET GLASS FOR 115-BF								
N		EA	1	3	1			
260422803 SENSOR RELAY HARNESS 434-915								
1979120	1	EA	IL IN MI OH WI 58 58 58 58 58					
260359542 SET HAND G 3AL -03 1FT 6IN CORD								
N		EA	1	5	1			
103057824 SET HAND G 3AL -03 2FT 8IN CORD								
1133553	1	EA	IL IN MI OH WI 59 59 59 59 59					
Used with 10A and 20A Coinless Telephone Set, BSP 506-500-100.								
260344999 SET HAND G 3LE -03 2FT 8IN CORD								
1950683	1	EA	IL IN MI OH WI 59 59 59 59 59					
With bracket.								
260344981 SET HAND G 3LE -03 4FT 6IN CORD								
1950691	1	EA	IL IN MI OH WI 59 59 59 59 59					
With bracket.								
260414198 SET HAND G 3LEDM-03 2FT 8IN CORD								
1972570	1	EA	IL IN MI OH WI 59 59 59 59 59					
428 AMM 2FT 8IN w/bracket.								
260414297 SET HAND G 3LEDM-03 4FT 6IN CORD								
1972588	1	EA	IL IN MI OH WI 59 59 59 59 59					
428AML 4FT 6IN with bracket.								
104084173 SET HAND G13 D-03 BLACK 2FT 8IN								
1169474	1	EA	IL IN MI OH WI 59 59 59 59 59					
H4EH.								
260447743 SET TEL COIN 1D2C-4								
N								
260000310 SET TELEPHONE 10A CARD READER								
1998785	1	EA	IL IN MI OH WI 56					

DISTRIBUTION SERVICES

NETWORK SERVICES

TOOLS

BUILDING JANITORIAL

AUTOMOTIVE

FORMS/OFFICE SUPPLIES

GENERAL

DATA VOICE

PUBLIC COMMUNICATION EQUIPMENT

DISTRIBUTION SERVICES

PRODUCT IDENTIFIER		DESCRIPTION						
ITEM NUMBER	ORD. MULT.	SELL UNIT	STD. PKG. STOCK AVAILABILITY / PA	LEAD TIME	MIN. ORD.	A	C	
260000229		SET TELEPHONE COIN 1C2	03W /LK WS					
1996694	1	EA	IL IN MI OH WI	55				

NETWORK SERVICES

260317870		SET TELEPHONE COIN 1D2	03WO/LK				
N		EA	1	18	1		
Standard black touch-tone set without lock.							
260387733		SET TELEPHONE COIN 1D2C	03WO/LK				
1963975	1	EA	IL IN MI OH WI	55	55		

TOOLS

260414099		SET TELEPHONE COIN 1F2-3	WO/KIT WI				
1972562	1	EA	IL IN MI OH WI	55			
A 1N2 type set less chassis, chute, signal, keypad & 2A44 door. Includes a 2FT 8IN handset with dynamic mic.							

260417274		SET TELEPHONE COIN 1F2-3	W/KT				
1972463	1	EA	IL IN MI OH WI	55			

BUILDING JANITORIAL

102825171		SET TELEPHONE COIN 2D2	67A				
1163774	1	EA	IL IN MI OH WI	55	55	55	55
A touch-tone panel phone with dial tone first.							

260375944		SET TELEPHONE COINLESS	11B				
1957779	1	EA	IL IN MI OH WI	56	56	56	56

AUTOMOTIVE

103552386		SET TELEPHONE COINLESS	2960 BO1-50				
N		EA	6	2	6		

401166780		SHELF	10-S-DP				
N		EA	1	6	1		

260404108		SHELF	16-D				
N		EA	1	4	1		

FORMS/OFFICE SUPPLIES

260404090		SHELF	16-S				
N		EA	1	4	1		

402499941		SHELF	20-L BLUE LEFT				
N		EA	1	5	1		

402174775		SHELF	20-L WALNUT 54IN LEFT MTG				
N		EA	1	5	1		

GENERAL

260365457		SHELF	20-L-SS LEFT				
N		EA	1	5	1		

402499958		SHELF	21-L BLUE LEFT				
N		EA	1	5	1		

402035166		SHELF	21-L WALNUT 54IN RIGHT MTG				
N		EA	1	5	1		

DATA VOICE

260404124		SHELF	21-L-SS RIGHT				
N		EA	1	4	1		

260367883		SHELF	31-K BLACK UNLIMITED #310-27-3IL				
N		EA	1	4	1		

PRODUCT IDENTIFIER		DESCRIPTION						
ITEM NUMBER	ORD. MULT.	SELL UNIT	STD. PKG. STOCK AVAILABILITY / PA	LEAD TIME	MIN. ORD.	A	C	

260404181		SHELF	90-L-D				
N		EA	1	4	1		

260404165		SHELF	90-L-S				
N		EA	1	4	1		

260365465		SHELF	90-L-SS				
N		EA	1	5	1		

260404173		SHELF	90-L-S-D				
N		EA	1	4	1		

002082592		SHELF	107-LT-BF WISCONSIN				
1203547	1	EA	IL IN MI OH WI	57			

260395264		SHELF	115-BF-VT IBT LOGO PIZZA HUT				
N		EA	1	4	1		

260392378		SHELF	115-BF-VT IBT LOGO WENDYS				
N		EA	1	4	1		

260417951		SHELF	31K BLUE LIGHTED 321-27-5 - IL				
N		EA	1	4	1		

260417969		SHELF	31K BLUE UNLIGHTED 320-27-3 - IL				
N		EA	1	4	1		

260421961		SHELF	31K RED LIGHTED 321-27-4 - IL				
N		EA	1	4	1		

260422084		SHELF	31K RED UNLIGHTED 320-27-4 - IL				
N		EA	1	4	1		

260369905		SHELF	31K SILVER UNLIGHTED 320-275 - IL				
N		EA	1	4	1		

260423520		SHELF	7500A-BK-32-C8090 - IL				
N		EA	1	2	1		
Telephone shelf with Burger King and IL Bell logos.							

401331707		SHELF	ADCO 10S				
6155333	1	EA	IL IN MI OH WI	57			

400897187		SHELF	CK20842 L30				
1168674	1	EA	IL IN MI OH WI	57	57	57	57
Basic sentry coin telephone shelf, BSP 508-452-100.							

300045747		SHELF	COIN 7001 OAK				
1930396	1	EA	IL IN MI OH WI	57	57	57	57

280002692		SHELF	COIN 7001 RED				
N		EA	1	2	1		

402165633		SHELF	COIN 7001 TEAK				
N		EA	1	2	1		

401331830		SHELF	COIN 7001 WALNUT				
1146191	1	EA	IL IN MI OH WI	57	57	57	57

PRODUCT IDENTIFIER		DESCRIPTION				
ITEM NUMBER	ORD. MULT.	SELL UNIT	STD. PKG. STOCK AVAILABILITY / PA	LEAD TIME	MIN. ORD.	A C
260317227 SHELF COIN 7002 OAK						
N		EA	1	2	1	
260317235 SHELF COIN 7002 TEAK						
N		EA	1	2	1	
260317243 SHELF COIN 7002 WALNUT						
N		EA	1	2	1	
260317284 SHELF COIN 7009 OAK						
N		EA	1	2	1	
260317292 SHELF COIN 7009 TEAK						
N		EA	1	2	1	
402537245 SHELF COIN 7009 WALNUT						
N		EA	1	2	1	
300045762 SHELF COIN 7050 OAK						
N		EA	1	2	1	
280002528 SHELF COIN 7050 RED						
N		EA	1	2	1	
300045754 SHELF COIN 7050 TEAK						
N		EA	1	2	1	
401463054 SHELF COIN 7050 WALNUT						
N		EA	1	2	1	
260317334 SHELF COIN 7401 OAK						
N		EA	1	2	1	
260377940 SHELF COIN 7401 RED						
N		EA	1	2	1	
260317342 SHELF COIN 7401 TEAK						
N		EA	1	2	1	
401858642 SHELF COIN 7401 WALNUT						
5248641	1	EA	IL IN MI OH WI 57 57 57 57			
280071671 SHELF COIN 7409 OAK						
N		EA	1	2	1	
402532162 SHELF COIN 7409 TEAK						
5218164	1	EA	IL IN MI OH WI 57 57 57 57			
402532170 SHELF COIN 7409 WALNUT						
5218180	1	EA	IL IN MI OH WI 57 57 57 57			
260317359 SHELF COIN 7450 OAK						
N		EA	1	2	1	
260317367 SHELF COIN 7450 TEAK						
N		EA	1	2	1	
260317375 SHELF COIN 7450 WALNUT						
N		EA	1	2	1	

PRODUCT IDENTIFIER		DESCRIPTION				
ITEM NUMBER	ORD. MULT.	SELL UNIT	STD. PKG. STOCK AVAILABILITY / PA	LEAD TIME	MIN. ORD.	A C
300045770 SHELF COIN 8001 OAK						
1930388	1	EA	IL IN MI OH WI 57 57			
280002718 SHELF COIN 8001 RED						
N		EA	1	2	1	
401821756 SHELF COIN 8001 TEAK						
N		EA	1	2	1	
401331855 SHELF COIN 8001 WALNUT						
8162586	1	EA	IL IN MI OH WI 57 57			
Used in place of the KS19267 shelf in coin telephone installations.						
260317565 SHELF COIN 8009 OAK						
N		EA	1	2	1	
402537278 SHELF COIN 8009 TEAK						
N		EA	1	2	1	
402537286 SHELF COIN 8009 WALNUT						
N		EA	1	2	1	
300045796 SHELF COIN 8050 OAK						
N		EA	1	2	1	
280002650 SHELF COIN 8050 RED						
N		EA	1	2	1	
300045788 SHELF COIN 8050 TEAK						
N		EA	1	2	1	
401491600 SHELF COIN 8050 WALNUT						
N		EA	1	2	1	
260317607 SHELF COIN 8053WC OAK						
N		EA	1	2	1	
260317615 SHELF COIN 8053WC TEAK						
N		EA	1	2	1	
260317623 SHELF COIN 8053WC WALNUT						
N		EA	1	2	1	
260317631 SHELF COIN 8059 OAK						
N		EA	1	2	1	
260317649 SHELF COIN 8059 TEAK						
N		EA	1	2	1	
280002684 SHELF COIN 8059 WALNUT						
N		EA	1	2	1	
260317656 SHELF COIN 8096 OAK						
N		EA	1	2	1	
260317664 SHELF COIN 8096 TEAK						
N		EA	1	2	1	
260317672 SHELF COIN 8096 WALNUT						
N		EA	1	2	1	

DISTRIBUTION SERVICES

NETWORK SERVICES

TOOLS

BUILDING JANITORIAL

AUTOMOTIVE

FORMS/OFFICE SUPPLIES

GENERAL

DATA VOICE

PUBLIC COMMUNICATION EQUIPMENT

DISTRIBUTION SERVICES

PRODUCT IDENTIFIER DESCRIPTION

ITEM	ORD.	SELL	STD. PKG.	LEAD TIME	MIN.	A
NUMBER	MULT.	UNIT	STOCK AVAILABILITY / PA		ORD.	C

280002726 SHELF COIN 8301 OAK
N EA 1 2 1

280002577 SHELF COIN 8301 RED
N EA 1 2 1

280002585 SHELF COIN 8301 TEAK
N EA 1 2 1

280002593 SHELF COIN 8301 WALNUT
N EA 1 2 1

260317706 SHELF COIN 8401 OAK
1946962 1 EA IL IN MI OH WI
57

402166664 SHELF COIN 8401 TEAK
N EA 1 2 1

401858659 SHELF COIN 8401 WALNUT
5248567 1 EA IL IN MI OH WI
57

280002601 SHELF COIN 8409 OAK
N EA 1 2 1

402532188 SHELF COIN 8409 TEAK
5218289 1 EA IL IN MI OH WI
57 57 57 57

402532196 SHELF COIN 8409 WALNUT
1144832 1 EA IL IN MI OH WI
57 57 57 57

A coin telephone mounting with wood grained walnut finish.

260317714 SHELF COIN 8450 OAK
N EA 1 2 1

260317722 SHELF COIN 8450 TEAK
N EA 1 2 1

260317730 SHELF COIN 8450 WALNUT
N EA 1 2 1

260317748 SHELF COIN 9001 OAK
N EA 1 2 1

260317755 SHELF COIN 9001 TEAK
N EA 1 2 1

401821772 SHELF COIN 9001 WALNUT
N EA 1 2 1

300045713 SHELF DIRECTORY 8110 OAK
N EA 1 2 1

260317680 SHELF DIRECTORY 8110 TEAK
N EA 1 2 1

260317698 SHELF DIRECTORY 8110 WALNUT
N EA 1 2 1

NETWORK SERVICES

TOOLS

BUILDING JANITORIAL

AUTOMOTIVE

FORMS/OFFICE SUPPLIES

GENERAL

DATA VOICE

PRODUCT IDENTIFIER DESCRIPTION

ITEM	ORD.	SELL	STD. PKG.	LEAD TIME	MIN.	A
NUMBER	MULT.	UNIT	STOCK AVAILABILITY / PA		ORD.	C

280014184 SHELF DIRECTORY TDS-90L
N EA 1 4 1

300032133 SHELF PCI BLUE OH
6501031 1 EA IL IN MI OH WI
57 57

260404082 SHELF PCI BPGRN P193-17-04 OH
N EA 1 6 1

300091485 SHELF PCI BRONZE OH
1920942 1 EA IL IN MI OH WI
57 57

260392386 SHELF PCI RED IL
N EA 1 4 1

402537310 SIGN 720 HEADSET
N EA 1 2 1

002074458 SIGN 726 RED OUTGOING CALLS ONLY
1448381 1 EA IL IN MI OH WI
58 58

002074474 SIGN 730 RED EQUIPPED W/EXTENSION
N EA 1 2 1

260345269 SIGN AC MAIN SWITCH
N EA 1 6 100

400268587 SIGN CK16422 L 1
N EA 1 2 1

Uses a 15 watt fluorescent lamp, 110V AC, intended for indoor use, comes without dome or mounting bracket, BSP 508-810-100.

260348172 SIGN CK20063 L 1 MOD IL
N EA 5 9 25

260345103 SIGN CK20063 L 1 MOD OH
1950881 1 EA IL IN MI OH WI
58

260348222 SIGN CK20063 L 1 MOD DR - IN
N EA 5 8 25

260348230 SIGN CK20063 L 1 MOD DR - MI
N EA 5 8 25

260348248 SIGN CK20063 L 1 MOD DR - OH
N EA 5 8 25

260348255 SIGN CK20063 L 1 MOD DR - WI
N EA 5 8 25

260348180 SIGN CK20063 L 1 MOD - IN
N EA 5 8 25

260348198 SIGN CK20063 L 1 MOD - MI
N EA 5 8 25

260348206 SIGN CK20063 L 1 MOD - WI
N EA 5 8 25

DISTRIBUTION SERVICES

NETWORK SERVICES

TOOLS

BUILDING JANITORIAL

AUTOMOTIVE

FORMS/OFFICE SUPPLIES

GENERAL

DATA VOICE

PRODUCT IDENTIFIER		DESCRIPTION						
ITEM NUMBER	ORD. MULT.	SELL UNIT	STD. PKG. STOCK AVAILABILITY / PA	LEAD TIME	MIN. ORD.	A	C	
260345129 SIGN CK20063 L 2 DR OHIO								
1950907	1	EA	IL IN MI OH WI	58				
260348263 SIGN CK20063 L 2 MOD IL								
N		EA	5	9		25		
260345111 SIGN CK20063 L 2 MOD OH								
1950899	1	EA	IL IN MI OH WI	58 58				
260348305 SIGN CK20063 L 2 MOD DR - IL								
N		EA	5	8		25		
260348313 SIGN CK20063 L 2 MOD DR - IN								
N		EA	5	8		25		
260348321 SIGN CK20063 L 2 MOD DR - MI								
N		EA	5	8		25		
260348339 SIGN CK20063 L 2 MOD DR - WI								
N		EA	5	8		25		
260348271 SIGN CK20063 L 2 MOD - IN								
N		EA	5	8		25		
260348289 SIGN CK20063 L 2 MOD - MI								
N		EA	5	8		25		
260348347 SIGN CK20063 L 3 MOD IL								
N		EA	5	9		25		
260347802 SIGN CK20063 L 3 MOD DR OH								
1951517	1	EA	IL IN MI OH WI	58				
260348446 SIGN CK20063 L 3 MOD DR - IL								
N		EA	5	8		25		
260348453 SIGN CK20063 L 3 MOD DR - IN								
N		EA	5	8		25		
260348461 SIGN CK20063 L 3 MOD DR - MI								
N		EA	5	8		25		
260348354 SIGN CK20063 L 3 MOD - IN								
N		EA	5	8		25		
260348362 SIGN CK20063 L 3 MOD - MI								
N		EA	5	8		25		
400321402 SIGN CK20125 L 1								
7157362	1	EA	IL IN MI OH WI	58 58				
The word, PHONE, appears in white letters against a blue background.								
402600191 SIGN COIN CK20031 L 3								
1175935	1	EA	IL IN MI OH WI	58				
An illuminated, 3 sided, 16in high sign with white handset on a blue field with white border.								

PRODUCT IDENTIFIER		DESCRIPTION						
ITEM NUMBER	ORD. MULT.	SELL UNIT	STD. PKG. STOCK AVAILABILITY / PA	LEAD TIME	MIN. ORD.	A	C	
260348297 SIGN COIN CK20063 L 2 18IN SQUARE								
1953109	1	EA	IL IN MI OH WI	58				
Wisconsin Bell Modified.								
260348370 SIGN COIN CK20063 L 3 24IN SQUARE								
1953604	5	EA	IL IN MI OH WI	58				
Ohio Bell Modified.								
260348388 SIGN COIN CK20063 L 3 24IN SQUARE								
1953117	5	EA	IL IN MI OH WI	58				
Wisconsin Bell Modified.								
260348479 SIGN COIN CK20063 L 3 24IN SQUARE								
1953125	5	EA	IL IN MI OH WI	58				
Wisconsin Bell Modified. DR								
402179006 SIGN COIN CK20063 L 6								
N		EA	1	7		5		
400329538 SIGN COIN CK20064 L 4								
N		EA	1	7		5		
2.7in X 7in, double sided, nonreflective with white arrow on a blue field.								
401942248 SIGN COIN CK20064 L 8								
N		EA	1	7		25		
A single-faced, pressure sensitive, vinyl decal for amplified handset coin phone installations, BSP 508-810-205.								
400321410 SIGN COIN CK20125 L 2								
1260802	1	EA	IL IN MI OH WI	58 58 58 58 58				
Sign displays the word, PHONE, with an arrow in white on a blue field.								
260345509 SIGN FLOOR ARROW 2FT X 5FT								
N		SE	1	6		100		
260345376 SIGN FUSE PULLER 7IN X 5IN								
N		EA	1	6		100		
260441225 SIGN KIT MOD 101C-IL								
N		EA	1	8		10		
260441233 SIGN KIT MOD 101C-IN								
N		EA	1	8		10		
260441241 SIGN KIT MOD 101C-MI								
N		EA	1	8		10		
260441258 SIGN KIT MOD 101C-OH								
N		EA	1	8		10		
260441266 SIGN KIT MOD 101C-WI								
N		EA	1	8		10		
260441274 SIGN KIT MOD 101FS - IL								
N		EA	1	8		10		
260441282 SIGN KIT MOD 101FS - IN								
N		EA	1	8		10		

PUBLIC COMMUNICATION EQUIPMENT

DISTRIBUTION SERVICES

NETWORK SERVICES

TOOLS

BUILDING JANITORIAL

AUTOMOTIVE

FORMS/OFFICE SUPPLIES

GENERAL

DATA VOICE

PRODUCT IDENTIFIER		DESCRIPTION					
ITEM NUMBER	ORD. MULT.	SELL UNIT	STD. PKG. STOCK AVAILABILITY / PA	LEAD TIME	MIN. ORD.	A C	
260441290		SIGN KIT MOD 101FS - MI					
N		EA	1	8	10		
260441308		SIGN KIT MOD 101FS - OH					
N		EA	1	8	10		
260441316		SIGN KIT MOD 101FS - WI					
N		EA	1	8	10		
260441324		SIGN KIT MOD 101FSV - IL					
N		EA	1	8	10		
260441332		SIGN KIT MOD 101FSV - IN					
N		EA	1	8	10		
260441340		SIGN KIT MOD 101FSV - MI					
N		EA	1	8	10		
260441357		SIGN KIT MOD 101FSV - OH					
N		EA	1	8	10		
260441365		SIGN KIT MOD 101FSV - WI					
N		EA	1	8	10		
401877758 SIGN KIT MODULAR 101C							
1191684	1	KT	IL IN MI OH WI 58 58 58 58				
Kit contains various decals including company name and logo for IL, MI, OH & WI.							
001121250		SIGN KIT MODULAR 101FS IL					
N		KT	1	8	25		
402899249		SIGN KIT MODULAR 101FSV					
N		KT	1	8	25		
260395512		SIGN NO LOITERING IBTNL 12 X 12					
N		EA	1	5	100		
260324066 SIGN PANEL 540-1178							
1944595	1	SE	IL IN MI OH WI 58				
260324074 SIGN PANEL 540-1179							
1944587	1	SE	IL IN MI OH WI 58				
280018854		SIGN PHONE 18IN 247-3920-05					
N							
300040490		SIGN SPIN LOGO IBT					
N		EA	50	8	1000		
260435185		SIGN TRIANGULAR LTD BN7600P IL					
N		EA	1	2	1		
260423512		SIGN TRIANGULAR LTD W/ADAPTER BN7600 -IL					
N		EA	1	2	1		
Lighted triangular sign w/IL Bell logo that can mount to various telephone booths. May require ADAPTER SIGN BN7172 (260423504) to mount.							

PRODUCT IDENTIFIER		DESCRIPTION					
ITEM NUMBER	ORD. MULT.	SELL UNIT	STD. PKG. STOCK AVAILABILITY / PA	LEAD TIME	MIN. ORD.	A C	
002074466		SIGN VOL-CONTROL HEADSET 729					
N		EA	1	2	1		
103287538 SIGNAL 47A2							
1133736	1	EA	IL IN MI OH WI 58 58 58 58				
Coin transducer which mounts to a 20A chute to detect the passage of coins in their appropriate channels, BSP 506-410-401.							
260433297		SOFTWARE 4010RT PIN SOFT & FIRM					
N		EA	1	8	1		
260433313		SOFTWARE 4010RT REPORT WRITER					
N		EA	1	8	1		
260433305		SOFTWARE 4010RT SECURITY NET					
N		EA	1	8	1		
840157333 SPRING TRAP LEVER 840157333							
2792606	1	EA	IL IN MI OH WI 59 59 59 59				
Provides the proper tension on the Coin Trap. See Coin Trap and Associated Parts in BSP, BSP 506-410-400.							
260413075 STICKER LARGE ACT/OPTICOM						52	
1977561	20	SH	IL IN MI OH WI 58 58 58 58				
For Public Telephone Instruction Card, H.R. 971.							
260407440 STICKER LARGE AMERICALL						34	
1977389	20	SH	IL IN MI OH WI 58 58 58 58				
For Public Telephone Instruction Card, H.R. 971.							
260413034 STICKER LARGE CABLE & WIRELESS						48	
1977520	20	SH	IL IN MI OH WI 58 58 58 58				
For Public Telephone Instruction Card, H.R. 971.							
260407507 STICKER LARGE CHARTER NETWORK						40	
1977447	20	SH	IL IN MI OH WI 58 58 58 58				
For Public Telephone Instruction Card, H.R. 971.							
260407465 STICKER LARGE ITI						36	
1977405	20	SH	IL IN MI OH WI 58 58 58 58				
For Public Telephone Instruction Card, H.R. 971.							
260413091 STICKER LARGE ITT/METROMEDIA CC						54	
1977587	20	SH	IL IN MI OH WI 58 58 58 58				
For Public Telephone Instruction Card, H.R. 971.							
260413059 STICKER LARGE LITEL						50	
1977546	20	SH	IL IN MI OH WI 58 58 58 58				
For Public Telephone Instruction Card, H.R. 971.							
260407408 STICKER LARGE MCI						30	
1977348	20	SH	IL IN MI OH WI 58 58 58 58				
For Public Telephone Instruction Card, H.R. 971.							

PRODUCT IDENTIFIER		DESCRIPTION					MIN.	A
ITEM NUMBER	ORD. MULT.	SELL UNIT	STD. PKG. STOCK AVAILABILITY / PA	LEAD TIME		ORD.	C	
260407481	20	SH	IL IN MI OH WI 58 58 58 58 58	STICKER LARGE ONE CALL/OPTICOM		38		
For Public Telephone Instruction Card, H.R. 971.								
260407548	20	SH	IL IN MI OH WI 58 58 58 58 58	STICKER LARGE TELECOM USA		44		
For Public Telephone Instruction Card, H.R. 971.								
260407424	20	SH	IL IN MI OH WI 58 58 58 58 58	STICKER LARGE TELESPHERE		32		
For Public Telephone Instruction Card, H.R. 971.								
260407564	20	SH	IL IN MI OH WI 58 58 58 58 58	STICKER LARGE US SPRINT HMG		46		
For Public Telephone Instruction Card, H.R. 971.								
260407523	20	SH	IL IN MI OH WI 58 58 58 58 58	STICKER LARGE US SPRINT PUBLICFON		42		
For Public Telephone Instruction Card, H.R. 971.								
260413083	20	SH	IL IN MI OH WI 58 58 58 58 58	STICKER SMALL ACT/OPTICOM		53		
BILINGUAL For Public Telephone Instruction Card, H.R. 971.								
260407457	20	SH	IL IN MI OH WI 58 58 58 58 58	STICKER SMALL AMERICALL BILINGUAL		35		
For Public Telephone Instruction Card, H.R. 971.								
260413042	20	SH	IL IN MI OH WI 58 58 58 58 58	STICKER SMALL BI CABLE & WIRELESS		49		
BILINGUAL For Public Telephone Instruction Card, H.R. 971.								
260407515	20	SH	IL IN MI OH WI 58 58 58 58 58	STICKER SMALL CHARTER NETWORK		41		
BILINGUAL For Public Telephone Instruction Card, H.R. 971.								
260407473	20	SH	IL IN MI OH WI 58 58 58 58 58	STICKER SMALL ITI BILINGUAL		37		
For Public Telephone Instruction Card, H.R. 971.								
260413109	20	SH	IL IN MI OH WI 58 58 58 58 58	STICKER SMALL ITT/METROMEDIA CC		55		
BILINGUAL For Public Telephone Instruction Card, H.R. 971.								
260413087	20	SH	IL IN MI OH WI 58 58 58 58 58	STICKER SMALL LITEL BILINGUAL		51		
For Public Telephone Instruction Card, H.R. 971.								
260407416	20	SH	IL IN MI OH WI 58 58 58 58 58	STICKER SMALL MCI BILINGUAL		31		
For Public Telephone Instruction Card, H.R. 971.								

PRODUCT IDENTIFIER		DESCRIPTION					MIN.	A
ITEM NUMBER	ORD. MULT.	SELL UNIT	STD. PKG. STOCK AVAILABILITY / PA	LEAD TIME		ORD.	C	
260407499	20	SH	IL IN MI OH WI 58 58 58 58 58	STICKER SMALL ONE CALL/OPTICOM		39		
BILINGUAL For Public Telephone Instruction Card, H.R. 971.								
260407556	20	SH	IL IN MI OH WI 58 58 58 58 58	STICKER SMALL TELECOM USA		45		
BILINGUAL For Public Telephone Instruction Card, H.R. 971.								
260407432	20	SH	IL IN MI OH WI 58 58 58 58 58	STICKER SMALL TELESPHERE BILINGUAL		33		
For Public Telephone Instruction Card, H.R. 971.								
260407572	20	SH	IL IN MI OH WI 58 58 58 58 58	STICKER SMALL US SPRINT HMG		47		
BILINGUAL For Public Telephone Instruction Card, H.R. 971.								
260407531	20	SH	IL IN MI OH WI 58 58 58 58 58	STICKER SMALL US SPRINT PUBLICFON		43		
BILINGUAL For Public Telephone Instruction Card, H.R. 971.								
834080616	1	EA	IL IN MI OH WI 58 58 58 58 58	STUD SECURITY P40Y061				
Security stud for coin telephone.								
834080608	1	EA	IL IN MI OH WI 58 58 58 58 58	STUD SECURITY P40Y061				
Security stud for coin telephone.								
840358303	1	EA	IL IN MI OH WI 59 59 59 59 59	SWITCH HOOK COIN 1C/1D				
841012297	N	EA	12	2	12			
SWITCH & BRACKET ASSY FOR COIN DIAL HSNQ								
260344197	1	EA	IL IN MI OH WI 58 58	SWIVEL ASSEMBLY ASYSTN4004				
401903356	N	EA	1	5	264			
SWIVEL BINDER SHEET METAL 500912								
101774164	1	EA	IL IN MI OH WI 59 59 59 59 59	TOTALIZER 1A M/D				
811057033	1	EA	IL IN MI OH WI 59 59 59 59 59	TRAP LEVER P10E703				
A part of the coin trap and trap lever assembly, BSP 506-410-400.								
102859725	N	EA	1	2	1			
UNIT COIN COVER 70A1 03								

DISTRIBUTION SERVICES

NETWORK SERVICES

TOOLS

BUILDING JANITORIAL

AUTOMOTIVE

FORMS/OFFICE SUPPLIES

GENERAL

DATA VOICE

PUBLIC COMMUNICATION EQUIPMENT

DISTRIBUTION SERVICES

NETWORK SERVICES

TOOLS

BUILDING JANITORIAL

AUTOMOTIVE

FORMS/OFFICE SUPPLIES

GENERAL

DATA VOICE

PRODUCT IDENTIFIER		DESCRIPTION						
ITEM NUMBER	ORD. MULT.	SELL UNIT	STD. PKG. STOCK AVAILABILITY / PA	LEAD TIME	MIN. ORD.	A	C	
102859758	N	EA	1	2	1			
UNIT COIN COVER 70A2 03								
102819901	N	EA	1	2	1			
UNIT COIN COVER 70A3 03								
102819935	N	EA	1	2	1			
UNIT COIN COVER 71A3 03								
104187174	1334185	1	EA	IL 59	IN 59	MI 59	OH 59	WI 59
Cover assembly for 1C2-3 touchtone coin telephone wired for dial tone first.								
104187190	N	EA	1	2	1			
UNIT COIN COVER 71A5 03								
103322632	N	EA	1	2	1			
UNIT COIN DIAL 60B1 44								
103325775	1191197	1	EA	IL 59	IN 59	MI 59	OH 59	WI 59
Dial and housing assembly for DTF 1C1 and 2C1 coin telephone sets using rotary dial, BSP 506-410-400.								
103325783	1199943	1	EA	IL	IN	MI	OH 59	WI
UNIT COIN DIAL 60B3 44								
260323720	1944181	1	EA	IL 59	IN 59	MI 59	OH 59	WI 59
Electronic dial used in coin telephone sets.								
104187141	1334201	1	EA	IL 59	IN 59	MI 59	OH 59	WI 59
Dial and housing for 1C2 and 2C2 coin telephone, BSP 506-410-400.								
104187158	1334078	1	EA	IL 59	IN 59	MI 59	OH 59	WI 59
Dial unit used in 2D2-67 touch-tone panel coin telephones.								
260317250	N	EA	1	2	1			
UNIT LEG 27IN 7002WCS OAK								
260317268	N	EA	1	2	1			
UNIT LEG 27IN 7002WCS TEAK								
402626733	N	EA	1	2	1			
UNIT LEG 27IN 7002WCS WALNUT								
402626758	1189613	1	EA	IL 57	IN	MI	OH	WI
UNIT LEG 27IN 8002WCS WALNUT								
300045812	N	EA	1	2	1			
UNIT LEG 36IN 7002 OAK								

PRODUCT IDENTIFIER		DESCRIPTION						
ITEM NUMBER	ORD. MULT.	SELL UNIT	STD. PKG. STOCK AVAILABILITY / PA	LEAD TIME	MIN. ORD.	A	C	
402151989	N	EA	1	2	1			
UNIT LEG 36IN 7002 TEAK								
401491634	N	EA	1	2	1			
UNIT LEG 36IN 7002 WALNUT								
300045820	N	EA	1	2	1			
UNIT LEG 36IN 8002 OAK								
402151997	N	EA	1	2	1			
UNIT LEG 36IN 8002 TEAK								
401491642	N	EA	1	2	1			
UNIT LEG 36IN 8002 WALNUT								
840698252	N	EA	1	2	1			
WEIGHT HANDSET								

P NUMBERED PARTS

811062165	N	EA	1	2	1			
P10F216 COIL								
821020088	N	EA	1	7	1			
P10K008 SCREW								
811174465	N	EA	1	2	1			
P11G446 SPRING For Magnetic Card Reader.								
811177419	N	EA	1	20	1			
P11G741 WASHER PLAIN Package of 50.								
811177625	N	EA	1	13	1			
P11G762 PISTON RING								
801540261	N	EA	1	2	1			
P154026 STUD								
801608837	N	EA	300	13	300			
P160883 SCREW								
811758630	1217661	1	EA	IL 08	IN 08	MI 08	OH 08	WI 08
P17E863 SCREW A 3/8in X 16in X 2in hex head screw.								
811758689	1222356	1	EA	IL 08	IN 08	MI 08	OH 08	WI 08
P17E868 NUT HEX WITH WAX COATING 3/8IN-16IN 18-8 used by outside forces.								
811911569	N	EA	200	9	200			
P19A156 STRIP DESIGNATION								
802018895	N	EA	1	2	1			
P201889 STRIP FACE								
802837161	N	EA	1	2	1			
P283716 WASHER								

DISTRIBUTION SERVICES

NETWORK SERVICES

TOOLS

BUILDING JANITORIAL

AUTOMOTIVE

FORMS/OFFICE SUPPLIES

GENERAL

DATA VOICE

PRODUCT IDENTIFIER DESCRIPTION

ITEM NUMBER	ORD. MULT.	SELL UNIT	STD. PKG. STOCK AVAILABILITY / PA	LEAD TIME	MIN. ORD.	A C
-------------	------------	-----------	-----------------------------------	-----------	-----------	-----

803534478 P353447 SCREW
N EA 6400 2 1

812262319 P376420 BRACKET & SNAP ASSEMBLY

2689307	1	EA	IL 18	IN 18	MI 18	OH 18	WI 18
---------	---	----	-------	-------	-------	-------	-------

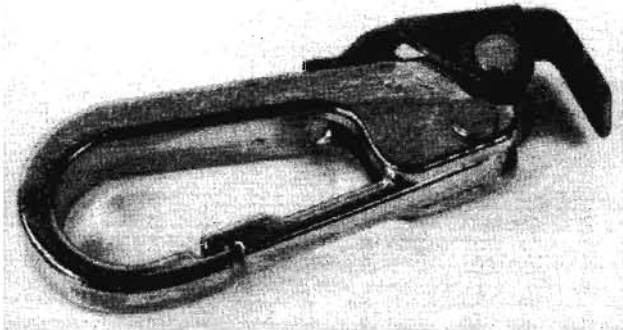

2689307

260341284 P376420 GROMMET

1949560	1	EA	IL 08	IN 08	MI 08	OH 08	WI 08
---------	---	----	-------	-------	-------	-------	-------

Replacement for original, used in 105 type Terminals when lost or worn out.

803880798 P388079 WIRE BF 22 GA PAIR

N FT 1 2 1

804034692 P403469 BOLT

5229567	1	EA	IL 18	IN	MI	OH	WI 18
---------	---	----	-------	----	----	----	-------

804034700 P403470 BOLT STEEL, PIGS EYE

N EA 500 2 1
289A .375-16X1.688.

804034734 P403473 CLAMP

N EA 1 2 1

824129563 P41K956 CARD APPARATUS ASSEMBLY

N EA 5 6 5

814257093 P42E709 SCREW CAP M/D

N EA 100 4 100
WILL BE DISCONTINUED 06/92.

814259057 P42E905 COUPLING BAND ASSMEMBLY

N EA 6 5 6

814628889 P462888 COVER

N EA 1 15 1

824635809 P46L580 NUT HEX

1198432	1	PK	IL 18	IN	MI	OH 18	WI 18
---------	---	----	-------	----	----	-------	-------

Package of 400. Brass 3/8in AF-.120T-.190D-.32 For binding posts of various terminals.

804740108 P474010 GUIDE

N EA 20 8 20

804828705 P482870 PIN HINGE

N EA 1 6 1

PRODUCT IDENTIFIER DESCRIPTION

ITEM NUMBER	ORD. MULT.	SELL UNIT	STD. PKG. STOCK AVAILABILITY / PA	LEAD TIME	MIN. ORD.	A C
-------------	------------	-----------	-----------------------------------	-----------	-----------	-----

834855751 P48V575 TUBE ASSEMBLY
N EA 1 2 1

814934923 P49C492 WIRE/CM

N FT 1350 2 1350
1987 UL LIST MATERIAL REQUIRED

105046775 P72C22 WIRE SHIELD COUPLER

N FT 1 1

840485809 P86D780 FACE PLATE

N EA 1 2 1

RACEWAY

402028310 RACEWAY 200 1 PIECE 5FT LENGTH

1136812 1 FT

RACK

260405741 RACK UNEQUAL FLANGE ACCESSORY

N EA 1 4 1
TRS-93-12. Homaco.

RACK CABLE

400216164 RACK CABLE 8 HOLE CA06784

1187716 1 EA



400216164

400216172 RACK CABLE 14 HOLE CA06784

1229963	1	EA	IL 35	IN 35	MI 35	OH 35	WI 35
---------	---	----	-------	-------	-------	-------	-------

Used with cable hooks for supporting cable in manholes, BSP 622-520-100.

400216180 RACK CABLE 18 HOLE CA06784

1229989	1	EA	IL 35	IN 35	MI 35	OH 35	WI 35
---------	---	----	-------	-------	-------	-------	-------

28 1/2IN between holes, 30IN long.

400216198 RACK CABLE 37 HOLE CA06784

1102673	1	EA	IL 35	IN 35	MI 35	OH 35	WI 35
---------	---	----	-------	-------	-------	-------	-------

55 1/4IN long.

400836268 RACK CABLE 47 HOLE CA06784

2762484	1	EA	IL 35	IN 35	MI 35	OH 35	WI 35
---------	---	----	-------	-------	-------	-------	-------

Used with cable hooks for supporting cables in manholes. Not equipped with bolt holes. BSP 622-520-100.

RACK CABLE

PRODUCT IDENTIFIER		DESCRIPTION				
ITEM NUMBER	ORD. MULT.	SELL UNIT	STD. PKG. STOCK AVAILABILITY / PA	LEAD TIME	MIN. ORD.	A C

260355748 RACK CABLE BEFRK
 1954784 1 EA IL IN MI OH WI
 35 35
 Single or double sided frame.

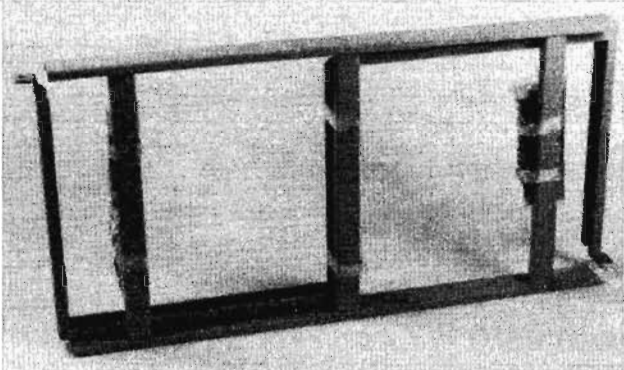

1954784

PRODUCT IDENTIFIER		DESCRIPTION				
ITEM NUMBER	ORD. MULT.	SELL UNIT	STD. PKG. STOCK AVAILABILITY / PA	LEAD TIME	MIN. ORD.	A C

400541785 REDUCER STRAND B 6.6M TO 6M YELLOW
 2663708 1 EA IL IN MI OH WI
 08 08 08 08 08

300040938 REDUCER STRAND B 6.6M TO 10M
 1217372 1 EA IL IN MI OH WI
 08 08 08 08 08
 Special size 1/4in-3/8in LSR2125, Yellow orange.

401075650 REDUCER STRAND B10M TO 16M ORANGE
 N EA 25 12 25

REGULATOR GAS C & TEST PRES C

SEE SECTION 3-TOOLS - PRESSURIZATION AIR CABLE EQUIPMENT.

RETAINER

104411277 RETAINER JR1A
 N EA 1 6 1
 NOW AVAILABLE THROUGH TOUCH-TONE ORDER ENTRY.

104436092 RETAINER JR2A PACKAGE 2
 N PK 1 6 1

RIBBON BONDING

SEE BOND RIBBON.

RING BRIDLE

400260360 RING BRIDLE B CA07873
 N PK 25 4 800

400260378 RING BRIDLE C 7/8IN CA07912
 1303727 25 EA IL IN MI OH WI
 18 18 18 18 18
 Used as intermediate support for insulated wires on frame structures, when insulated building attachments are not required, BSP 080-720-140.



1303727

400260386 RING BRIDLE C 1 1/4IN CA07912
 1100099 25 EA IL IN MI OH WI
 18 18 18 18 18

DISTRIBUTION SERVICES

NETWORK SERVICES

TOOLS

BUILDING JANITORIAL

AUTOMOTIVE

FORMS/OFFICE SUPPLIES

GENERAL

DATA VOICE

RACK RELAY

260405733 RACK RELAY 19-84-T1S
 N EA 1 4 1

260405683 RACK RELAY 19-84-T2S
 N EA 1 4 1
 Homaco.

260405956 RACK RELAY 23-84-T2-SGEX
 N EA 1 4 1
 Homaco.

260405725 RACK RELAY ACCESSORY GB-93
 N EA 1 4 1

260405709 RACK RELAY ACCESSORY JH-93
 N EA 1 4 1
 Homaco.

260405691 RACK RELAY ACCESSORY PS-93
 N EA 1 4 1
 Homaco, package of 100.

RECTIFIER

260466927 RECTIFIER 336A1 POWER UNIT
 N
 For 80A cabinet assembly.

REDUCER STRAND

CA08516. Used for joining galvanized strand of different sizes. BSP 627-230-210.
400541744 REDUCER STRAND B 6M TO 10M BLACK
 1332890 1 EA



400541744

DISTRIBUTION SERVICES

NETWORK SERVICES

TOOLS

BUILDING JANITORIAL

AUTOMOTIVE

FORMS/OFFICE SUPPLIES

GENERAL

DATA VOICE

PRODUCT IDENTIFIER DESCRIPTION

ITEM NUMBER	ORD. MULT.	SELL UNIT	STD. PKG. STOCK AVAILABILITY / PA	LEAD TIME	MIN. ORD.	A C
-------------	------------	-----------	-----------------------------------	-----------	-----------	-----

400260394 RING BRIDLE C 1 5/8IN CA07912						
1100107	25	EA	IL 18 IN 18 MI 18 OH 18 WI 18			

400260402 RING BRIDLE C 3 IN CA07912						
N		PK	100	4	300	
NOW AVAILABLE THROUGH TOUCH-TONE ORDER ENTRY.						

400497202 RING BRIDLE K 3/4IN CA08518						
1237149	1	EA	IL 18 IN 18 MI 18 OH 18 WI 18			
3/4in bridle ring threaded on one end, BSP 080-720-139.						



1237149

400497186 RING BRIDLE M 1 1/4IN CA08518						
1237164	1	EA	IL 18 IN 18 MI 18 OH 18 WI 18			
1 1/4in bridle ring threaded on one end, BSP 080-720-139.						

RING CABLE

401163803 RING CABLE N 3 1/2IN REGULAR						
5241729	1	EA				CA06768.

RING DISTRIBUTING

100666692 RING DISTRIBUTING 13A						
1237321	1	EA				
1 7/8in X 2 3/4in for use in holding cross connecting wires in building cable terminals, BSP 642-230-201.						

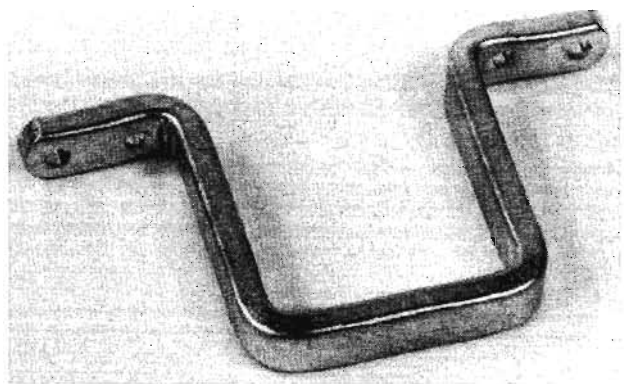

100666692

PRODUCT IDENTIFIER DESCRIPTION

ITEM NUMBER	ORD. MULT.	SELL UNIT	STD. PKG. STOCK AVAILABILITY / PA	LEAD TIME	MIN. ORD.	A C
-------------	------------	-----------	-----------------------------------	-----------	-----------	-----

100666700 RING DISTRIBUTING 13B						
1237347	1	EA	IL 08 IN 08 MI 08 OH 08 WI 08			
3 1/8in X 3 3/4in.						

100666718 RING DISTRIBUTING 13C						
1237362	1	EA	IL 08 IN 08 MI 08 OH 08 WI 08			
3 3/4in X 5 3/4in.						

100666759 RING DISTRIBUTING 17A						
1102699	1	EA	IL 08 IN 08 MI 08 OH 08 WI 08			
Metal ring having gray insulating finish and used in building terminals where pic cable ready access principle is used. For 100 PR cable.						

100666767 RING DISTRIBUTING 17B						
1100115	1	EA	IL 08 IN 08 MI 08 OH 08 WI 08			
For 200 PR cable.						

100666775 RING DISTRIBUTING 17C						
1110213	1	EA	IL 08 IN 08 MI 08 OH 08 WI 08			
For 400 PR cable.						

RING DRIVE

400260584 RING DRIVE 1/2IN CA06835						
1182857	50	EA				
Used as intermediate supports of insulated wire on frame buildings when porcelain insulated attachments are not required, BSP 080-720-142.						



400260584

400260600 RING DRIVE 5/8IN LONG CA06835						
5241901	1	EA	IL 18 IN 18 MI 18 OH 18 WI 18			
Inner package has 25 pieces.						

400260618 RING DRIVE 7/8IN LONG						
5241927	1	EA	IL 18 IN 18 MI 18 OH 18 WI 18			
A 7/8 inch drive ring with long shaft.						

400260634 RING DRIVE 1 1/4IN LONG						
1100131	1	EA	IL 18 IN 18 MI 18 OH 18 WI 18			
Inner package has 25 pieces.						

RING MOUNTING

PRODUCT IDENTIFIER		DESCRIPTION				
ITEM NUMBER	ORD. MULT.	SELL UNIT	STD. PKG. STOCK AVAILABILITY / PA	LEAD TIME	MIN. ORD.	A C

RING MOUNTING

300096153 RING MOUNTING 1/KIT 4056
 N KT 1 2 N 1

280057027 RING MOUNTING 4256E

1962605 1 EA IL IN MI OH WI
 08 08 08 08 08
 For E Cabinets.

300014354 RING MOUNTING 4256HD

1936864 1 EA IL IN MI OH WI
 08 08 08 08 08
 Metal frame used to anchor 4200 type cabinets on a concrete slab. The kit contains 1 mounting ring, 4 concrete inserts and 4 nylon screws.

RING RETAINING

997021589 RING RETAINING Y-5133-6-OD
 N PK 1 2 4
 Waldes.

RINGER

300081080 RINGER HALF 919
 4212787 1 EA
 A half ringer equivalent designed for use in the combination SNI/EB network interface with the 1800 upgrade kit.

300076601 RINGER ISOLATOR TII 816W

1110676 1 EA IL IN MI OH WI
 18

ROD GROUND

260395199 ROD GROUND 5/8IN X 5FT UNTHREADED
 1970954 1 EA
 For a longer rod, use two rods with coupling, bronze 5/8IN unthreaded (PID 260395207, item 1970947).

260395199

001001577 ROD GROUND 5/8IN X 8FT CECO384198

8181388 1 EA IL IN MI OH WI
 14
 Used for special requirements, other than the 1/2in X 10ft ground rod, lead. FOR ILLINOIS BELL USE ONLY.

402658926 ROD GROUND E CA08985

1437467 15 EA IL IN MI OH WI
 08 08 08 08 08
 A 1/2 X 5IN steel ground rod used as a grounding electrode.

PRODUCT IDENTIFIER		DESCRIPTION				
ITEM NUMBER	ORD. MULT.	SELL UNIT	STD. PKG. STOCK AVAILABILITY / PA	LEAD TIME	MIN. ORD.	A C

ROD GUY

FOR ANCHORING POLES AND POLE STUBS AT CORNERS AND DEAD ENDS. S FOR SINGLEYE, D FOR DOUBLEYE, AND T FOR TRIPLEYE. TO BE USED WITH ANCHOR EXPANSION B. BSP 621-415-200.

400260998 ROD GUY D 3/4IN X 9FT CA07082

1237982 1 EA
 For use with ANCHOR EXPANSION B 8IN (1102038) or ANCHOR EXPANSION B 10IN (1100875).



400260998

400261012 ROD GUY D 1 1/4IN X 10IN CA07082

N EA 1 6 1

400261004 ROD GUY D 1IN X 10FT CA07082

5242446 1 EA IL IN MI OH WI
 14 14 14 14 14
 For use with ANCHOR EXPANSION B 12IN.

400260980 ROD GUY D 5/8IN X 8FT

N EA 5 6 5
 For use with Anchor Expansion B 8IN (1102038). NOW AVAILABLE THROUGH TOUCH-TONE ORDER ENTRY.

400261020 ROD GUY S 1/2IN X 7FT CA07082

N EA 10 8 10
 For use with ANCHOR EXPANSION B 6IN.

400261038 ROD GUY T 3/4IN X 9FT CA07082

N EA 3 6 3
 For use with ANCHOR EXPANSION B 8IN (1102038) or ANCHOR EXPANSION B 10IN (1102038).

400261046 ROD GUY T 1 IN X 10FT

N EA 2 6 2
 For use with ANCHOR EXPANSION B 12IN.

400261053 ROD GUY T 1 1/4IN X 10FT

N EA 1 6 1
 For use with ANCHOR EXPANSION B 12IN.

ROD PLUG

280026410 ROD PLUG END 1IN EPR-1

1930982 1 EA
 Used with xaga closures.

DISTRIBUTION SERVICES

NETWORK SERVICES

TOOLS

BUILDING JANITORIAL

AUTOMOTIVE

FORMS/OFFICE SUPPLIES

GENERAL

DATA VOICE

PRODUCT IDENTIFIER DESCRIPTION

ITEM NUMBER	ORD. MULT.	SELL UNIT	STD. PKG. STOCK AVAILABILITY / PA	LEAD TIME	MIN. ORD.	A C
-------------	------------	-----------	-----------------------------------	-----------	-----------	-----

280026428 ROD PLUG END 2IN EPR-2

1930990	1	EA	IL 08 08	IN 08 08	MI 08 08	OH 08 08	WI 08 08
---------	---	----	----------	----------	----------	----------	----------

Used with xaga closures.



1930990

SCALE

401062153 SCALE R8550 6IN CF-634-E

1146654	1	EA					
---------	---	----	--	--	--	--	--

General Hardware type 4R.

SCREW

260300389 SCREW BRASS BEAM CLAMP

1938233	1	EA					
---------	---	----	--	--	--	--	--

280043084 SCREW LAG GALVANIZED 2IN X 1/4IN

1924928	1	EA	IL 08	IN 08	MI 08	OH 08	WI 08
---------	---	----	-------	-------	-------	-------	-------

803539592 SCREW P0353959 4-40 X 3/16 FH

N	EA	22500	2	1			
---	----	-------	---	---	--	--	--

289A machine.

400262507 SCREW SUSPENSION CABLE

5243006	1	EA	IL 08	IN 08	MI 08	OH 08	WI 08
---------	---	----	-------	-------	-------	-------	-------



5243006

SCREW ANGLE

400262051 SCREW ANGLE 3/8IN PACKAGE 10

1923052	1	PK					
---------	---	----	--	--	--	--	--

CA06432 - Used with the S knob attachment for drop wires to building. Used with the T porcelain knob as first attachment, accomodates 2 drop wires, BSP 080-720-133.

PRODUCT IDENTIFIER DESCRIPTION

ITEM NUMBER	ORD. MULT.	SELL UNIT	STD. PKG. STOCK AVAILABILITY / PA	LEAD TIME	MIN. ORD.	A C
-------------	------------	-----------	-----------------------------------	-----------	-----------	-----

400262044 SCREW ANGLE 5/16IN PACKAGE 10

1238642	1	PK	IL 18	IN 18	MI 18	OH 18	WI 18
---------	---	----	-------	-------	-------	-------	-------

Used with the S knob attachment for drop wires to building, CA06432 - BSP 080-720-133.

SCREW COACH

400262135 SCREW COACH 1/2IN X 4 1/2IN

N	EA	200	8	200			
---	----	-----	---	-----	--	--	--

Used by construction to mount various back plates on poles.

400262093 SCREW COACH 1/4IN X 2IN

1238667	25	EA	IL 08	IN 08	MI 08	OH 08	WI 08
---------	----	----	-------	-------	-------	-------	-------

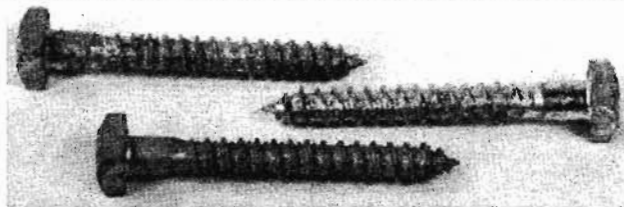

1238667

400262127 SCREW COACH 3/8IN X 4IN CA06337

N	EA	500	8	500			
---	----	-----	---	-----	--	--	--

400262101 SCREW COACH 5/16IN X 2 1/2IN

1238683	25	EA	IL 08	IN 08	MI 08	OH 08	WI 08
---------	----	----	-------	-------	-------	-------	-------

400262119 SCREW COACH 5/16IN X 3IN CA06337

N	EA	1000	8	1000			
---	----	------	---	------	--	--	--

SCREW DRIVE

900161142 SCREW DRIVE 1/2IN X 3 1/2IN

5242701	250	EA					
---------	-----	----	--	--	--	--	--

Used in outside plant construction to make attachments to poles.

400262176 SCREW DRIVE 1/2IN X 4 1/2IN

1238782	1	EA	IL 14	IN 14	MI 14	OH 14	WI 14
---------	---	----	-------	-------	-------	-------	-------

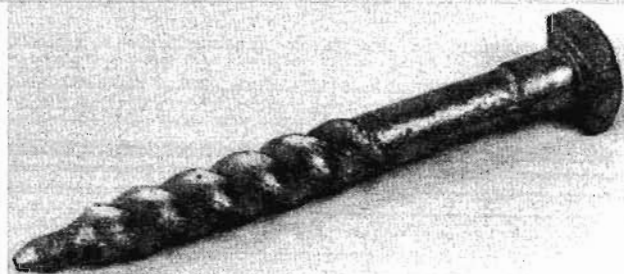

1238782

400262184 SCREW DRIVE 1/2IN X 6 1/2IN

1238808	1	EA	IL 08	IN 08	MI 08	OH 08	WI 08
---------	---	----	-------	-------	-------	-------	-------

DISTRIBUTION SERVICES

NETWORK SERVICES

TOOLS

BUILDING JANITORIAL

AUTOMOTIVE

FORMS/OFFICE SUPPLIES

GENERAL

DATA VOICE

SCREW DRIVE

PRODUCT IDENTIFIER		DESCRIPTION						
ITEM NUMBER	ORD. MULT.	SELL UNIT	STD. PKG. STOCK AVAILABILITY / PA	LEAD TIME		MIN. ORD.	A C	
400262143 SCREW DRIVE			1/4IN X 2 1/2IN					
1238725	1	EA	IL 08 IN 08 MI 08 OH 08 WI 08					
400262168 SCREW DRIVE			3/8IN X 4IN					
1238766	500	EA	IL 14 IN 14 MI 14 OH 14 WI 14					
400262192 SCREW DRIVE			5/8IN X 6IN CA06281					
N		EA	100	8		100		
400262150 SCREW DRIVE			5/16IN X 3IN					
1238741	800	EA	IL 14 IN 14 MI 14 OH 14 WI 14					

SCREW HEX HEAD

260354675 SCREW HEX HEAD WASHER			8 X 1/2IN					
1952390	1	PK	Slotted AB, package of 20.					
260354683 SCREW HEX HEAD WASHER			8 X 3/4IN					
1952382	1	PK	IL 18 IN 18 MI 18 OH 18 WI 18	Slotted AB, package of 20.				
260354691 SCREW HEX HEAD WASHER			8 X 1 IN					
1952374	1	PK	IL 18 IN 18 MI 18 OH 18 WI 18	Slotted AB, package of 20.				
260354717 SCREW HEX HEAD WASHER			8 X 1 1/2IN					
1952358	1	PK	IL 18 IN 18 MI 18 OH 18 WI 18	Slotted AB, package of 12.				
260354709 SCREW HEX HEAD WASHER			8 X 1 1/4IN					
1952366	1	PK	IL 18 IN 18 MI 18 OH 18 WI 18	Slotted AB, package of 20.				
260354725 SCREW HEX HEAD WASHER			8 X 2 IN					
1952333	1	PK	IL 18 IN 18 MI 18 OH 18 WI 18	Slotted AB, package of 12.				
260354733 SCREW HEX HEAD WASHER			8 X 2 1/2IN					
1952341	1	PK	IL 18 IN 18 MI 18 OH 18 WI 18	Slotted AB, package of 8.				
260354741 SCREW HEX HEAD WASHER			10 X 1/2IN					
1952325	1	PK	IL 18 IN 18 MI 18 OH 18 WI 18	Slotted AB, package of 8.				
260354758 SCREW HEX HEAD WASHER			10 X 1 IN					
1952317	1	PK	IL 18 IN 18 MI 18 OH 18 WI 18	Slotted AB, package of 8.				
260354766 SCREW HEX HEAD WASHER			10 X 1 1/2IN					
1952309	1	PK	IL 18 IN 18 MI 18 OH 18 WI 18	Slotted AB, package of 8.				

PRODUCT IDENTIFIER		DESCRIPTION						
ITEM NUMBER	ORD. MULT.	SELL UNIT	STD. PKG. STOCK AVAILABILITY / PA	LEAD TIME		MIN. ORD.	A C	
260354774 SCREW HEX HEAD WASHER			10 X 2 IN					
1952291	1	PK	IL 18 IN 18 MI 18 OH 18 WI 18	Slotted AB, package of 8.				
260354782 SCREW HEX HEAD WASHER			10 X 2 1/2IN					
1952283	1	PK	IL 18 IN 18 MI 18 OH 18 WI 18	Slotted AB, package of 8.				
260354667 SCREW HEX HEAD WASHER			14 X 3/4IN					
1952275	1	PK	IL 18 IN 18 MI 18 OH 18 WI 18	Slotted AB, package of 8.				
260354790 SCREW HEX HEAD WASHER			14 X 1 IN					
1952267	1	PK	IL 18 IN 18 MI 18 OH 18 WI 18	Slotted AB, package of 8.				
260354808 SCREW HEX HEAD WASHER			14 X 1 1/4IN					
1952259	1	PK	IL 18 IN 18 MI 18 OH 18 WI 18	Slotted AB, package of 8.				
260354816 SCREW HEX HEAD WASHER			14 X 1 3/4IN					
1952242	1	PK	IL 18 IN 18 MI 18 OH 18 WI 18	Slotted AB, package of 8.				
260354626 SCREW HEX HEAD WASHER			14 X 2 IN					
1952432	1	PK	IL 18 IN 18 MI 18 OH 18 WI 18	Slotted AB, package of 8.				
260354659 SCREW HEX HEAD WASHER			14 X 2 1/2IN					
1952424	1	PK	IL 18 IN 18 MI 18 OH 18 WI 18	Slotted AB, package of 8.				
260354634 SCREW HEX HEAD WASHER			14 X 3 IN					
1952416	1	PK	IL 18 IN 18 MI 18 OH 18 WI 18	Slotted AB, package of 8.				
260354642 SCREW HEX HEAD WASHER			14 X 3 1/2IN					
1952408	1	PK	IL 18 IN 18 MI 18 OH 18 WI 18	Slotted AB, package of 8.				
260354824 SCREW HEX HEAD WASHER			14 X 4 IN					
1952226	1	PK	IL 18 IN 18 MI 18 OH 18 WI 18	Slotted AB, package of 8.				
260354832 SCREW HEX HEAD WASHER			18 X 1 IN					
1952234	1	PK	IL 18 IN 18 MI 18 OH 18 WI 18	Slotted AB, package of 8.				
260354840 SCREW HEX HEAD WASHER			18 X 1 1/2IN					
1952218	1	PK	IL 18 IN 18 MI 18 OH 18 WI 18	Slotted AB, package of 8.				

PRODUCT IDENTIFIER		DESCRIPTION					
ITEM NUMBER	ORD. MULT.	SELL UNIT	STD. PKG. STOCK AVAILABILITY / PA	LEAD TIME	MIN. ORD.	A C	
260354857		SCREW HEX HEAD WASHER 18 X 2 IN					
1952200	1	PK	IL IN MI OH WI 18 18 18 18				
Slotted AB, package of 8.							
260354865		SCREW HEX HEAD WASHER 18 X 2 1/2IN					
1952192	1	PK	IL IN MI OH WI 18 18 18				
Slotted AB, package of 8.							

SCREW HEX SOCKET

996035630		SCREW HEX SOCKET BUTTON HEAD				
N		EA	1	20	1	
Cap Steel B183 .190-32 NF X 3/4 Long, Cadmium plated for 1A card.						
996035697		SCREW HEX SOCKET BUTTON HEAD				
N		EA	100	2	100	
Cap steel .190-32 X 1/4 USA Standard, cadmium plated.						
996786083		SCREW HEX SOCKET LOCKING SET				
N		EA	1	13	1	
Stainless steel 8-32 X 15/64, with nylon insert.						

SCREW MACHINE

900250259		SCREW MACHINE 6-32 X 1/2IN				
1836148	1	BX				
Bright round head.						
900210816		SCREW MACHINE 6-32 X 3/4IN				
5242867	1	BX	IL IN MI OH WI 18 18 18 18			
Brass round head, box of 100.						
900213216		SCREW MACHINE 6-32 X 1 IN				
1185272	1	BX	IL IN MI OH WI 18 18 18 18			
Bright round head, box of 100.						
900210824		SCREW MACHINE 6-32 X 1 1/2IN				
1175026	1	BX	IL IN MI OH WI 18 18 18 18			
Bright round head, box of 100.						
900213224		SCREW MACHINE 6-32 X 2 IN				
5242883	1	BX	IL IN MI OH WI 18 18 18 18			
Brass round head, box of 100.						
900283649		SCREW MACHINE 8-32 X 1 IN				
1160010	1	BX	IL IN MI OH WI 18 18 18 18			
Bright round head, box of 100.						
900210857		SCREW MACHINE 8/32 X 1 1/2IN				
5242925	100	EA	IL IN MI OH WI 18 18 18 18			
Bright round head.						

PRODUCT IDENTIFIER		DESCRIPTION					
ITEM NUMBER	ORD. MULT.	SELL UNIT	STD. PKG. STOCK AVAILABILITY / PA	LEAD TIME	MIN. ORD.	A C	
900209826		SCREW MACHINE 8/32 X 1 3/4IN					
7351825	100	EA	IL IN MI OH WI 18 18 18 18				
Steel round head.							
900210840		SCREW MACHINE 8-32 X 1 3/8IN					
5242909	1	BX	IL IN MI OH WI 18 18 18 18				
Steel round head, box of 100.							
900210865		SCREW MACHINE 10-24 X 5/8IN					
1238824	1	BX	IL IN MI OH WI 18 18 18 18				
Brass round head, box of 100.							
900209842		SCREW MACHINE 10-24 X 1 IN					
1186999	1	BX	IL IN MI OH WI 18 18 18 18				
Bright flat head, box of 100.							
900209867		SCREW MACHINE 10-24 X 1 1/2IN					
5242941	1	BX	IL IN MI OH WI 18 18 18 18				
Bright round head, box of 100.							
900209875		SCREW MACHINE 10-24 X 2 IN					
5242966	100	EA	IL IN MI OH WI 18 18 08 18				
Bright round head, box of 100.							
900210741		SCREW MACHINE 1/4IN 20 X 1 1/4IN					
1179978	100	EA	IL IN MI OH WI 18 18 18 18				
Bright round head.							
900209743		SCREW MACHINE 1/4IN 20 X 1 1/4IN					
5242826	1	BX	IL IN MI OH WI 18 18 18 18				
Bright flat head, box of 100.							
900283557		SCREW MACHINE 1/4IN 20 X 2 IN					
5242842	1	BX	IL IN MI OH WI 18 18 18 18				
Bright flat head, box of 100.							
900213091		SCREW MACHINE 1/4IN-20 X 1 IN					
5127043	1	BX	IL IN MI OH WI 18 18 18 18				
Brass round head, box of 100.							
900209859		SCREW MACHINE RH 10-24 X 1IN SLOTTED					
1105411	1	BX	IL IN MI OH WI 18 18 18 18				
Zinc, 100/Box Bright P100.							

SCREW SELF-TAP

300051430		SCREW SELF-TAP 7 X 1/2IN HW A				
N		PK	1	4	1	
Hex head washer A, Package of 100.						
002078814		SCREW SELF-TAP 8 X 1/2IN HW A				
8154369	1	PK	IL IN MI OH WI 18 18 18 18			
Hex head washer A, Package of 8.						

DISTRIBUTION SERVICES
 NETWORK SERVICES
 TOOLS
 BUILDING JANITORIAL
 AUTOMOTIVE
 FORMS/OFFICE SUPPLIES
 GENERAL
 DATA VOICE

DISTRIBUTION SERVICES

NETWORK SERVICES

TOOLS

BUILDING JANITORIAL

AUTOMOTIVE

FORMS/OFFICE SUPPLIES

GENERAL

DATA VOICE

SCREW SELF-TAP

PRODUCT IDENTIFIER		DESCRIPTION					
ITEM NUMBER	ORD. MULT.	SELL UNIT	STD. PKG. STOCK AVAILABILITY / PA	LEAD TIME	MIN. ORD.	A	C
300051398 SCREW SELF-TAP 8 X 3/4IN HW A							
N		PK	1	4	1		
Hex head washer A, slotted screw, to be used to place various telephone hardware, package of 100.							
002078830 SCREW SELF-TAP 8 X 1 IN HW A							
N		PK	1	4	1		
Hex head washer A, package of 100.							
002078848 SCREW SELF-TAP 8 X 1 1/4IN HW A							
N		PK	1	4	1		
Hex head washer A, package of 100.							
002078871 SCREW SELF-TAP 14 X 3/4IN HW A							
N		PK	1	3	50		
Hex head washer A, package of 50.							
300051422 SCREW SELF-TAP 14 X 1 1/4IN HW A							
N		PK	1	3	50		
Hex head washer, package of 50.							
002078897 SCREW SELF-TAP 14 X 2 IN HW A							
N		PK	1	4	1		
Hex head washer A, package of 25.							
280054669 SCREW SELF-TAP 800-C							
N		PK	2	12	1000		

SEAL

260367479 SEAL END SLIC ES2 2 PORT 2IN							
1956268	1	EA					



260367479

260431465 SEAL END SLIC ES2-SC							
1978940	1	EA	IL 08	IN 08	MI 08	OH 08	WI 08
2IN, Single Port.							

260367487 SEAL END SLIC ES3 3 PORT 3IN							
1956235	1	EA	IL 08	IN 08	MI 08	OH 08	WI 08

260431077 SEAL END SLIC ES3-DC							
1978924	1	EA	IL 08	IN 08	MI 08	OH 08	WI 08
3IN, 2 Port.							

PRODUCT IDENTIFIER		DESCRIPTION					
ITEM NUMBER	ORD. MULT.	SELL UNIT	STD. PKG. STOCK AVAILABILITY / PA	LEAD TIME	MIN. ORD.	A	C
260431085 SEAL END SLIC ES3-SC							
1978932	1	EA	IL 08	IN 08	MI 08	OH 08	WI 08
3IN, Single Port.							
260367495 SEAL END SLIC ES5 3 PORT 5IN							
1956292	1	EA	IL 08	IN 08	MI 08	OH 08	WI 08
260367511 SEAL END SLIC ES5-DC 2 PORT 5IN							
1956250	1	EA	IL 08	IN 08	MI 08	OH 08	WI 08
260367503 SEAL END SLIC ES7 3 PORT 7IN							
1956276	1	EA	IL 08	IN 08	MI 08	OH 08	WI 08
260367529 SEAL END SLIC ES7-DC 2 PORT 7IN							
1956243	1	EA	IL 08	IN 08	MI 08	OH 08	WI 08

SEALANT

400494811 SEALANT B 3OZ TUBE CA08502							
1240564	1	TU					
Clear premixed thixotropic formulation used to insulate the ends of spare cable pairs in D.O.P. and to waterproof B wire connector joints in F cable closures.							

260425053 SEALANT TERMINAL PEDESTAL							
1976944	1	BX	IL 08	IN 08	MI 08	OH 08	WI 08
Replacement grease for termination ports of the AMP QUIET Front Terminal Block. 40 tubes per box.							

SEALANT DUCT

400264800 SEALANT DUCT PLASTIC 1LB CA07760X							
1100230	1	CT					
Plastic duct seal is a putty-like compound which retains a degree of plasticity, for sealing ducts under limited conditions. Not for use with polyethelene cable, BSP 628-220-224.							

400264818 SEALANT DUCT PLASTIC 5LB CA07760X							
1333682	1	PK	IL 35	IN 35	MI 35	OH 35	WI 35

SECTION TERMINAL

100667575 SECTION TERMINAL CABLE 1A1							
N		EA	1	2	1		
Accommodates one or two 1A4A or 1A4A16 terminal blocks or one 1A4A25 terminal block.							

100667583 SECTION TERMINAL CABLE 2A1							
N		BX	2	2	2		
Consists of a light olive gray sheet metal flat section, arranged for closing the ends of one or a group of No. 1A1 cable terminal sections, box of 2.							

DISTRIBUTION SERVICES

NETWORK SERVICES

TOOLS

BUILDING JANITORIAL

AUTOMOTIVE

FORMS/OFFICE SUPPLIES

GENERAL

DATA VOICE

PRODUCT IDENTIFIER DESCRIPTION

ITEM NUMBER	ORD. MULT.	SELL UNIT	STD. PKG. STOCK AVAILABILITY / PA	LEAD TIME	MIN. ORD.	A C
-------------	------------	-----------	-----------------------------------	-----------	-----------	-----

103115036 SECTION TERMINAL CABLE 3AA1 1952
 5439240 1 EA IL IN MI OH WI
 08 08 08 08
 DISCONTINUE, ORDER NON STOCK UPON STOCK DEPLETION

103115044 SECTION TERMINAL CABLE 3AA1-19/72
 N EA 1 2 1
 DISCONTINUE, ORDER NON STOCK UPON STOCK DEPLETION

103115051 SECTION TERMINAL CABLE 4A1 52
 1143990 1 BX IL IN MI OH WI
 08 08 08 08
 Box of 2, DISCONTINUE, ORDER NON STOCK UPON STOCK DEPLETION

103115069 SECTION TERMINAL CABLE 4A1 72
 N BX 2 2 2
 Box of 2.

100667591 SECTION TERMINAL CABLE H102
 N EA 1 2 1
 An open sided sheet metal housing e/w a lift out type door. For terminating feeder cables in buildings where protection is not needed, BSP 631-420-100.

100667609 SECTION TERMINAL CABLE H202
 N EA 1 2 1

100667617 SECTION TERMINAL CABLE H303
 N EA 1 2 1

402681316 SECTION TERMINAL CABLE HM202B
 N EA 1 2 1
 To be replaced by-section terminal cable 3A retrofit 52. Used where facilities are designed using the colored backboard concept and mech protection is required, BSP 631-400-901N.

402707079 SECTION TERMINAL CABLE HM303B
 N EA 1 2 1

002089555 SECTION TERMINAL CABLE HM52B
 N EA 1 2 1
 An alternative to the H202 section where greater cabinet depth is required.

300077898 SECTION TERMINAL CABLE HM72B
 N EA 1 2 1

002090314 SECTION TERMINAL CABLE HMJ52
 N BX 1 2 1
 Side section of enclosure for a building terminal, box of 2.

300077914 SECTION TERMINAL CABLE HMJ72
 N BX 2 2 2
 Box of 2.

100667625 SECTION TERMINAL CABLE J102
 N BX 1 2 1
 Box of 2.

PRODUCT IDENTIFIER DESCRIPTION

ITEM NUMBER	ORD. MULT.	SELL UNIT	STD. PKG. STOCK AVAILABILITY / PA	LEAD TIME	MIN. ORD.	A C
-------------	------------	-----------	-----------------------------------	-----------	-----------	-----

100667633 SECTION TERMINAL CABLE J202
 N BX 1 2 1
 Box of 2.

100667641 SECTION TERMINAL CABLE J303
 1141457 2 BX IL IN MI OH WI
 08 08 08 08
 Box of 2, DISCONTINUE, ORDER NON STOCK UPON STOCK DEPLETION

SENSOR MOISTURE

260403027 SENSOR MOISTURE CABLE
 N EA 1 4 4
 Sparton 530162.

SEPARATOR CABLE

401684782 SEPARATOR CABLE 4061
 1140525 1 EA
 Designed to isolate feeder and distribution pairs in 3M cross connect cabinet, snaps into slots on the inside of the frame, between modules.

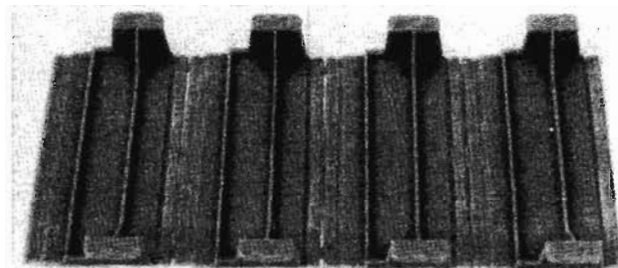

401684782

SET MANHOLE FRAME & COVER

SEE MANHOLE FRAME & COVER.

SHEATH REPAIR

260339114 SHEATH REPAIR ARMORCAST 4560
 N RO 5 3 5
 Bulk, 15FT. NOW AVAILABLE THROUGH TOUCH-TONE ORDER ENTRY.

260339122 SHEATH REPAIR ARMORCAST 4561
 N KT 1 3 1

SHEAVE SUPPORT

SEE SUPPORT.

SHELF

260405469 SHELF COMBINATION LSCIU 24/5
 N EA 1 2 1

105389548 SHELF LSC1U-024/05
 N EA 1 2 1

DISTRIBUTION SERVICES

NETWORK SERVICES

TOOLS

BUILDING JANITORIAL

AUTOMOTIVE

FORMS/OFFICE SUPPLIES

GENERAL

DATA VOICE

SHELF

PRODUCT IDENTIFIER		DESCRIPTION					
ITEM NUMBER	ORD. MULT.	SELL UNIT	STD. PKG. STOCK AVAILABILITY / PA	LEAD TIME	MIN. ORD.	A C	
105335798		SHELF	LSC1U-144/21				
N		EA	1	2	1		
260442249		SHELF	LSC2U 024/5 LIGHTGUIDE				
N		EA	1	3	1		
105361430		SHELF	LSR1U-072/12				
N		EA	1	2	1		
105361422		SHELF	LSR1U-144/19				
N		EA	1	2	1		
105335806		SHELF	LSS1U-072/05				
N		EA	1	2	1		
105335772		SHELF	LSS1U-144/07				
N		EA	1	2	1		
105335871		SHELF	LST1U-072/07				
N		EA	1	2	1		
106015662		SHELF	LST1U-072/07-A-A E/W 50F				
N		EA	1	2	1		
			Prewired. NOW AVAILABLE THROUGH TOUCH-TONE ORDER ENTRY.				
106015670		SHELF	LST1U-072/07-A-A E/W 100				
N		EA	1	2	1		
			Prewired.				
106015688		SHELF	LST1U-072/07-A-A E/W 150				
N		EA	1	2	1		
			Prewired.				
106015761		SHELF	LST1U-072/07-A-A E/W 200				
N		EA	1	2	1		
			Prewired.				
106016066		SHELF	LST1U-072/07-A-C E/W 50F				
N		EA	1	2	1		
			Prewired.				
106016082		SHELF	LST1U-072/07-A-C E/W 100				
N		EA	1	2	1		
			Prewired.				
106016090		SHELF	LST1U-072/07-A-C E/W 150				
N		EA	1	2	1		
			Prewired.				
106016108		SHELF	LST1U-072/07-A-C E/W 200				
N		EA	1	2	1		
			Prewired.				
106015944		SHELF	LST1U-072/07-B-B E/W 100				
N		EA	1	2	1		
			Prewired.				
106015951		SHELF	LST1U-072/07-B-B E/W 150				
N		EA	1	2	1		
			Prewired.				
106015977		SHELF	LST1U-072/07-B-B E/W 200				
N		EA	1	2	1		
			Prewired.				

PRODUCT IDENTIFIER		DESCRIPTION					
ITEM NUMBER	ORD. MULT.	SELL UNIT	STD. PKG. STOCK AVAILABILITY / PA	LEAD TIME	MIN. ORD.	A C	
106016116		SHELF	LST1U-072/07-B-D E/W 50F				
N		EA	1	2	1		
			Prewired.				
106016124		SHELF	LST1U-072/07-B-D E/W 100				
N		EA	1	2	1		
			Prewired.				
106016132		SHELF	LST1U-072/07-B-D E/W 150				
N		EA	1	2	1		
			Prewired.				
106016140		SHELF	LST1U-072/07-B-D E/W 200				
N		EA	1	2	1		
			Prewired.				
106015985		SHELF	LST1U-072/07-C-A E/W 50F				
N		EA	1	2	1		
			Prewired.				
106015993		SHELF	LST1U-072/07-C-A E/W 100				
N		EA	1	2	1		
			Prewired.				
106016009		SHELF	LST1U-072/07-C-A E/W 150				
N		EA	1	2	1		
			Prewired.				
106016017		SHELF	LST1U-072/07-C-A E/W 200				
N		EA	1	2	1		
			Prewired.				
106016157		SHELF	LST1U-072/07-C-C E/W 50F				
N		EA	1	2	1		
			Prewired.				
106016165		SHELF	LST1U-072/07-C-C E/W 100				
N		EA	1	2	1		
			Prewired.				
106016173		SHELF	LST1U-072/07-C-C E/W 150				
N		EA	1	2	1		
			Prewired.				
106016181		SHELF	LST1U-072/07-C-C E/W 200				
N		EA	1	2	1		
			Prewired.				
106016025		SHELF	LST1U-072/07-D-B E/W 50F				
N		EA	1	2	1		
			Prewired.				
106016033		SHELF	LST1U-072/07-D-B E/W 100				
N		EA	1	2	1		
			Prewired.				
106016041		SHELF	LST1U-072/07-D-B E/W 150				
N		EA	1	2	1		
			Prewired.				
106016058		SHELF	LST1U-072/07-D-B E/W 200				
N		EA	1	2	1		
			Prewired.				

PRODUCT IDENTIFIER		DESCRIPTION				
ITEM NUMBER	ORD. MULT.	SELL UNIT	STD. PKG. STOCK AVAILABILITY / PA	LEAD TIME	MIN. ORD.	A C

106016207		SHELF	LST1U-072/07-D-D E/W	50F		
N		EA	1	2	1	
Prewired.						

106016215		SHELF	LST1U-072/07-D-D E/W	100		
N		EA	1	2	1	
Prewired.						

106016231		SHELF	LST1U-072/07-D-D E/W	150		
N		EA	1	2	1	
Prewired.						

106016249		SHELF	LST1U-072/07-D-D E/W	200		
N		EA	1	2	1	
Prewired.						

SHELF REPEATER

103815684		SHELF REPEATER	27A			
N		EA	1	2	1	
Accommodates 25 protected T1 repeaters, plug-in fault locate filter, plug-in load coil, and 105 #208A protectors. Initial use: #841B Repeater Case.						

260422555		SHELF REPEATER	27A W/3M CONNECTORS			
1975706		EA	IL IN MI OH WI			
To be used in the assembly of 6200 cabinets.						

103815692		SHELF REPEATER	27B			
N		EA	1	6	1	

SHIELD

104436894		SHIELD	81A			
N		EA	1	2	1	

104436902		SHIELD	82A			
N		EA	1	2	1	

PRODUCT IDENTIFIER		DESCRIPTION				
ITEM NUMBER	ORD. MULT.	SELL UNIT	STD. PKG. STOCK AVAILABILITY / PA	LEAD TIME	MIN. ORD.	A C

SHIELD MANHOLE

401584552	1	EA				
A steel rim with a channel at each end to accept an inflatable rubber tube (1141911) which when inflated provides a seal to manhole, BSP 081-215-100.						

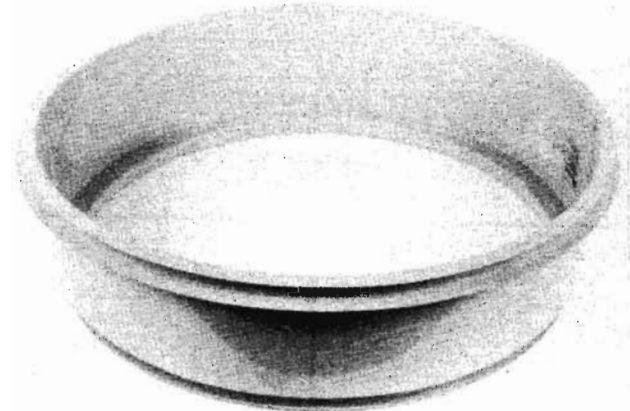

401584552

SHOULDER REST

SEE REST SHOULDER.

SIGN CABLE

400268215	1	EA				
A sign with black lettering on an orange background. Marked, CABLE ROUTE, with, two arrows, BSP 629-200-235.						

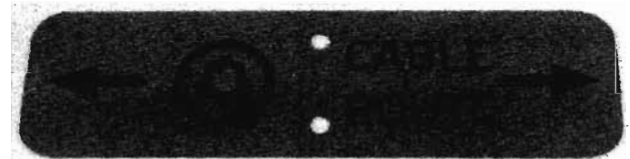

400268215

401503172	1	EA	IL IN MI OH WI			
2608406			08 08 08			



2608406

SIGN CABLE

PRODUCT IDENTIFIER DESCRIPTION

ITEM NUMBER	ORD. MULT.	SELL UNIT	STD. PKG. STOCK AVAILABILITY / PA	LEAD TIME	MIN. ORD.	A C
-------------	------------	-----------	-----------------------------------	-----------	-----------	-----

280099656 SIGN CABLE BURIED NO. 1 ORANGE

1937730 1 EA IL IN MI OH WI
08
BEFORE DIGGING CALL MISS DIG
1-800-482-7171, Toll Free, 3 5/8in wide x 10in
high, orange background color, black copy,
Michigan Bell sign only.

280079005 SIGN CABLE BURIED NO. 6 FIBER

1935593 1 EA IL IN MI OH WI
08
CAUTION, BURIED FIBER CABLE, BEFORE
DIGGING CALL MISS DIG 1-800-482-7171, toll
free, 2 3/4in wide x 4 1/2in high, black copy
on an orange background, Michigan Bell Sign
only.

002075216 SIGN CABLE CAUTION 10IN X 14IN

4237503 1 EA IL IN MI OH WI
08
Indiana 'only' item. A polyethylene sign used for
marking location of buried cables.

001170216 SIGN CABLE W1160 SMALL

5412221 1 EA IL IN MI OH WI
08 08



5412221

001171131 SIGN CABLE W1161 CROSSING

1173039 1 EA IL IN MI OH WI
08



1173039

PRODUCT IDENTIFIER DESCRIPTION

ITEM NUMBER	ORD. MULT.	SELL UNIT	STD. PKG. STOCK AVAILABILITY / PA	LEAD TIME	MIN. ORD.	A C
-------------	------------	-----------	-----------------------------------	-----------	-----------	-----

001171222 SIGN CABLE W1162 LARGE

5412007 1 EA IL IN MI OH WI
08

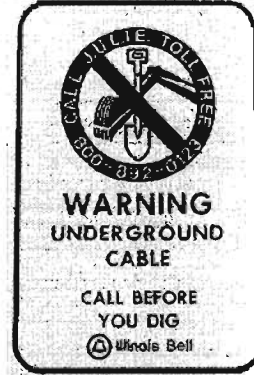

5412007

280054685 SIGN CABLE WARNING BURIED

1929521 1 EA IL IN MI OH WI
08
12IN x 18IN sign with black lettering on an
orange background. WARNING
UNDERGROUND CABLE, with Diggers Hotline
Logo and toll free and local telephone numbers,
Wisconsin Bell.

280054693 SIGN CABLE WARNING FIBER OPTIC

1929539 1 EA IL IN MI OH WI
08
12IN x 18IN sign with black lettering on an
orange background. WARNING FIBER OPTIC
CABLE, with Diggers Hot Line Logo and toll free
and local telephone numbers, Wisconsin Bell.

002047041 SIGN CABLE W-1160 DECAL

1220491 1 PK IL IN MI OH WI
08 08

260322961 SIGN DECAL W1159R DIGGER

1944066 1 PK IL IN MI OH WI
08
Package of 25.

260322953 SIGN DECAL W1160R CALL JULIE

1944074 1 PK IL IN MI OH WI
08
Package of 25.

SIGN CONSTRUCTION

SEE TOOL SECTION - SIGNS & ACCESSORIES

SIGN BURIED CABLE WARNING

260440748 SIGN BURIED CABLE WARNING - IL

N EA 1 1 1
3 1/2 X 7 1/4IN.

260440755 SIGN BURIED CABLE WARNING - IL

N EA 1 1 1
10 X 14IN.

DISTRIBUTION SERVICES

NETWORK SERVICES

TOOLS

BUILDING JANITORIAL

AUTOMOTIVE

FORMS/OFFICE SUPPLIES

GENERAL

DATA VOICE

DISTRIBUTION SERVICES

NETWORK SERVICES

TOOLS

BUILDING JANITORIAL

AUTOMOTIVE

FORMS/OFFICE SUPPLIES

GENERAL

DATA VOICE

PRODUCT IDENTIFIER		DESCRIPTION				
ITEM NUMBER	ORD. MULT.	SELL UNIT	STD. PKG. STOCK AVAILABILITY / PA	LEAD TIME	MIN. ORD.	A C
260440763			SIGN BURIED CABLE WARNING - IN			
N		EA	1	1	1	
			3 1/2 X 7 1/4IN.			
260440771			SIGN BURIED CABLE WARNING - IN			
N		EA	1	1	100	
			10 X 14IN.			
260440797			SIGN BURIED CABLE WARNING - MI			
N		EA	1	1	100	
			10 X 14IN.			
260440789			SIGN BURIED CABLE WARNING - MI			
N		EA	50	1	100	
			3 1/2 X 7 1/4IN.			
260440813			SIGN BURIED CABLE WARNING - OH			
N		EA	1	1	100	
			10 X 14IN.			
260440805			SIGN BURIED CABLE WARNING - OH			
N		EA	50	1	100	
			3 1/2 X 7 1/4IN.			
260440821			SIGN BURIED CABLE WARNING - WI			
N		EA	50	1	1	
			3 1/2 X 7 1/4IN.			
260440839			SIGN BURIED CABLE WARNING - WI			
N		EA	1	1	100	
			10 X 14IN.			

SILICONE
SEE LUBRICANT.

SLEEVE

300050846 SLEEVE FIBER PROTECTOR
1333351 1 PK
A heat shrinkable sleeve used to protect fusion splices on and optical fiber. Package of 50.

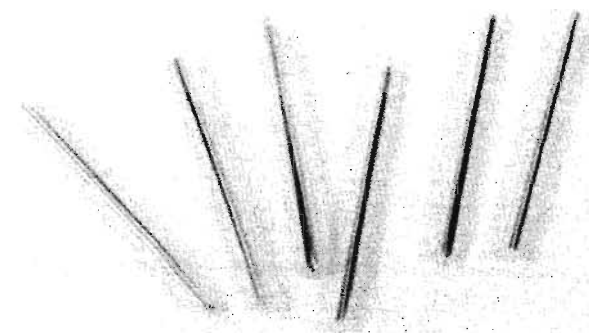

300050846

105058309 SLEEVE FUSION SP1
N EA 1 2 1
Package of 50.

PRODUCT IDENTIFIER		DESCRIPTION				
ITEM NUMBER	ORD. MULT.	SELL UNIT	STD. PKG. STOCK AVAILABILITY / PA	LEAD TIME	MIN. ORD.	A C
280079013			SLEEVE INSULATION 4467			
1934505	1	RO	IL IN MI OH WI			
			08			
			Insulation sleeve to be used with the 25T grounding braid. DISCONTINUE, ORDER NON STOCK UPON STOCK DEPLETION			

260346929			SLEEVE K&B FIRE SHIELD 6IN-7IN			
N		EA	1	2	1	
			78-8044-9130-2. NOW AVAILABLE THROUGH TOUCH-TONE ORDER ENTRY.			

260346937			SLEEVE K&B FIRE SHIELD 10IN			
N		EA	1	2	1	
			78-8044-9132-8.			

260346945			SLEEVE K&B FIRE SHIELD 12IN			
N		EA	1	2	1	
			78-8044-9133-6.			

260401880			SLEEVE SPLIT 10DS-26			
1969659	1	KT	IL IN MI OH WI			
			08 08			
			Fire Retardant, BSP 633-660-101.			

SLEEVE LEAD CA08419

400348611			SLEEVE LEAD CALCIUM B 3/4 X 15IN			
N		EA	6	2	6	
			Lead - calcium sleeves used to enclose splices or repaired sections in cable.			

400348629			SLEEVE LEAD CALCIUM B 3/4 X 72IN			
1157123	1	EA	IL IN MI OH WI			
			08 08			

400348637			SLEEVE LEAD CALCIUM B 1 X 15IN			
1100271	1	EA	IL IN MI OH WI			
			08 08 08 08 08			

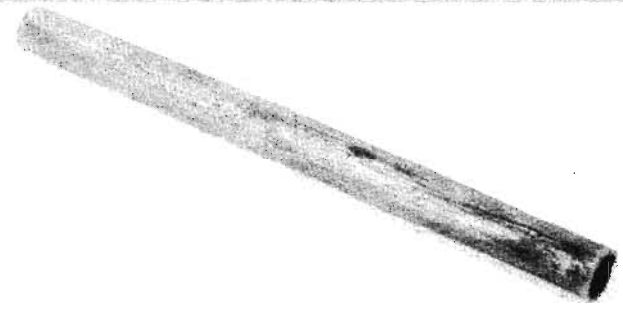

1100271

400348645			SLEEVE LEAD CALCIUM B 1 X 72IN			
1261768	1	EA	IL IN MI OH WI			
			08 08 08 08 08			

400348686			SLEEVE LEAD CALCIUM B 1 1/2 X 72IN			
1261727	1	EA	IL IN MI OH WI			
			08 08 08 08 08			

400348652			SLEEVE LEAD CALCIUM B 1 1/4 X 15IN			
N		EA	6	2	6	
			DISCONTINUE, ORDER NON STOCK UPON STOCK DEPLETION			

DISTRIBUTION SERVICES

NETWORK SERVICES

TOOLS

BUILDING JANITORIAL

AUTOMOTIVE

FORMS/OFFICE SUPPLIES

GENERAL

DATA VOICE

PRODUCT IDENTIFIER		DESCRIPTION						
ITEM NUMBER	ORD. MULT.	SELL UNIT	STD. PKG. STOCK AVAILABILITY / PA	LEAD TIME	MIN. ORD.	A	C	
400348660		SLEEVE LEAD CALCIUM B	1 1/4 X 72IN					
1102756	1	EA	IL IN MI OH WI 08 08 08 08 08					
400348694		SLEEVE LEAD CALCIUM B	1 3/4 X 17IN					
N		EA	6	2	6			
400348702		SLEEVE LEAD CALCIUM B	1 3/4 X 72IN					
1102772	1	EA	IL IN MI OH WI 08 08 08 08 08					
400348710		SLEEVE LEAD CALCIUM B	2 X 17IN					
7280545	1	EA	IL IN MI OH WI 08 08 08 08 08					
DISCONTINUE, ORDER NON STOCK UPON STOCK DEPLETION								
400348728		SLEEVE LEAD CALCIUM B	2 X 72IN					
1261826	1	EA	IL IN MI OH WI 08 08 08 08 08					
400348751		SLEEVE LEAD CALCIUM B	2 1/2 X 20IN					
N		EA	6	2	6			
400348769		SLEEVE LEAD CALCIUM B	2 1/2 X 72IN					
1261867	1	EA	IL IN MI OH WI 08 08 08 08 08					
400348736		SLEEVE LEAD CALCIUM B	2 1/4 X 17IN					
N		EA	6	2	6			
400348744		SLEEVE LEAD CALCIUM B	2 1/4 X 72IN					
1102798	1	EA	IL IN MI OH WI 08 08 08 08 08					
400348777		SLEEVE LEAD CALCIUM B	2 3/4 X 20IN					
N		EA	6	2	6			
400348785		SLEEVE LEAD CALCIUM B	2 3/4 X 72IN					
1102806	1	EA	IL IN MI OH WI 08 08 08 08 08					
400348793		SLEEVE LEAD CALCIUM B	3 X 20IN					
1172296	1	EA	IL IN MI OH WI 08 08 08 08 08					
DISCONTINUE, ORDER NON STOCK UPON STOCK DEPLETION								
400348801		SLEEVE LEAD CALCIUM B	3 X 72IN					
1261701	1	EA	IL IN MI OH WI 08 08 08 08 08					
400348835		SLEEVE LEAD CALCIUM B	3 1/2 X 20IN					
N		EA	1	2	1			
400348843		SLEEVE LEAD CALCIUM B	3 1/2 X 72IN					
1261842	1	EA	IL IN MI OH WI 08 08 08 08 08					
400348819		SLEEVE LEAD CALCIUM B	3 1/4 X 20IN					
N		EA	3	2	3			
400348827		SLEEVE LEAD CALCIUM B	3 1/4 X 72IN					
N		EA	1	2	1			

PRODUCT IDENTIFIER		DESCRIPTION						
ITEM NUMBER	ORD. MULT.	SELL UNIT	STD. PKG. STOCK AVAILABILITY / PA	LEAD TIME	MIN. ORD.	A	C	
400348850		SLEEVE LEAD CALCIUM B	4 X 24IN					
N		EA	1	2	1			
400348868		SLEEVE LEAD CALCIUM B	4 X 72IN					
1261925	1	EA	IL IN MI OH WI 08 08 08 08 08					
400348876		SLEEVE LEAD CALCIUM B	4 1/2 X 24IN					
N		EA	1	2	1			
400348884		SLEEVE LEAD CALCIUM B	4 1/2 X 72IN					
1261743	1	EA	IL IN MI OH WI 08 08 08 08 08					
400348892		SLEEVE LEAD CALCIUM B	5 X 24IN					
N		EA	1	2	1			
400348900		SLEEVE LEAD CALCIUM B	5 X 72IN					
1261883	1	EA	IL IN MI OH WI 08 08 08 08 08					
400348918		SLEEVE LEAD CALCIUM B	5 1/2 X 27IN					
N		EA	1	2	1			
400348926		SLEEVE LEAD CALCIUM B	5 1/2 X 72IN					
1261909	1	EA	IL IN MI OH WI 08 08 08 08 08					
401699814		SLEEVE LEAD CALCIUM B	6 X 72IN					
1261941	1	EA	IL IN MI OH WI 08 08 08 08 08					
400348967		SLEEVE LEAD CALCIUM B	6 1/2 X 60IN					
N		EA	1	2	1			
400488482		SLEEVE LEAD CALCIUM B	7 X 27IN					
N		EA	1	2	1			
400348983		SLEEVE LEAD CALCIUM B	7 X 60IN					
1261800	1	EA	IL IN MI OH WI 08 08 08 08 08					
400349007		SLEEVE LEAD CALCIUM B	7 1/2 X 60IN					
N		EA	1	2	1			
400349015		SLEEVE LEAD CALCIUM B	8 X 27IN					
N		EA	1	2	1			
400349023		SLEEVE LEAD CALCIUM B	8 X 60IN					
N		EA	1	2	1			
400349031		SLEEVE LEAD CALCIUM B	9 X 27IN					
N		EA	1	2	1			
400349049		SLEEVE LEAD CALCIUM B	9 X 60IN					
N		EA	1	2	1			
400349056		SLEEVE LEAD CALCIUM B	10 X 27IN					
N		EA	1	2	1			
400349064		SLEEVE LEAD CALCIUM B	10 X 60IN					
N		EA	1	2	1			

DISTRIBUTION SERVICES

NETWORK SERVICES

TOOLS

BUILDING JANITORIAL

AUTOMOTIVE

FORMS/OFFICE SUPPLIES

GENERAL

DATA VOICE

PRODUCT IDENTIFIER		DESCRIPTION				
ITEM NUMBER	ORD. MULT.	SELL UNIT	STD. PKG. STOCK AVAILABILITY / PA	LEAD TIME	MIN. ORD.	A C

SLEEVE REPAIR

280079021 SLEEVE REPAIR AUTOFIT 220/150- 8

1939264 1 EA
An electrically shrinkable sleeving for use with all types of lead or polyethylene jacketed cables.

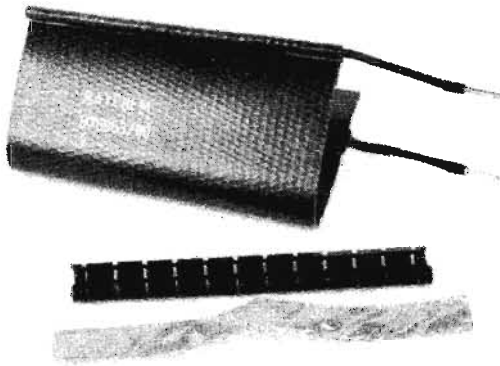

280079021

280079039 SLEEVE REPAIR AUTOFIT 220/150-16

1939272 1 EA IL IN MI OH WI
08 08 08 08 08

280079047 SLEEVE REPAIR AUTOFIT 300/200- 8

1939280 1 EA IL IN MI OH WI
08 08 08 08 08

280079054 SLEEVE REPAIR AUTOFIT 300/200-16

1939298 1 EA IL IN MI OH WI
08 08 08 08 08

280079062 SLEEVE REPAIR AUTOFIT 390/250- 8

1939306 1 EA IL IN MI OH WI
08 08 08 08 08

280079070 SLEEVE REPAIR AUTOFIT 390/250-16

1939314 1 EA IL IN MI OH WI
08 08 08 08 08

260422605 SLEEVE REPAIR AUTOFIT PCRS 220/150- 8

N EA 5 6 5
NOW AVAILABLE THROUGH TOUCH-TONE ORDER ENTRY.

260422613 SLEEVE REPAIR AUTOFIT PCRS 220/150-16

N EA 5 6 5

260422621 SLEEVE REPAIR AUTOFIT PCRS 300/200-08

N EA 5 6 5

260422639 SLEEVE REPAIR AUTOFIT PCRS 300/200-16

N EA 5 6 5

260422647 SLEEVE REPAIR AUTOFIT PCRS 390/250-08

N EA 5 6 5

260422654 SLEEVE REPAIR AUTOFIT PCRS 390/250-16

N EA 5 6 5

260422688 SLEEVE REPAIR AUTOFIT UTD

N EA 2 6 2

PRODUCT IDENTIFIER		DESCRIPTION				
ITEM NUMBER	ORD. MULT.	SELL UNIT	STD. PKG. STOCK AVAILABILITY / PA	LEAD TIME	MIN. ORD.	A C

260360037 SLEEVE REPAIR WRST 35/170-48

1953646 1 EA IL IN MI OH WI
08 08 08 08 08
A heat shrinkable tubing for sheath repair of both lead and poly jacketed aerial cable.

260360029 SLEEVE REPAIR WRST 60-300-48

1953638 1 EA IL IN MI OH WI
08 08 08 08 08

260360011 SLEEVE REPAIR WRST 120-500-48

1953620 1 EA IL IN MI OH WI
08 08 08 08 08

260360003 SLEEVE REPAIR WRST KIT OVERLAP

1953612 1 EA IL IN MI OH WI
08 08 08 08 08

SLEEVE SERVING

401070941 SLEEVE SERVING STRAND B 1/2IN

N EA 100 8 100
CA08322.

401093034 SLEEVE SERVING STRAND B 1/4IN

1185371 1 EA IL IN MI OH WI
14 14 14 14 14
Used for serving or securing tails of guys when the guy clamp method is used, for 6.6M strand, BSP 621-410-200.

400488342 SLEEVE SERVING STRAND B 3/8IN

1262121 1 EA IL IN MI OH WI
14 14 14 14 14

400488334 SLEEVE SERVING STRAND B 5/16IN

1262105 1 EA IL IN MI OH WI
14 14 14 14 14

400488326 SLEEVE SERVING STRAND B 7/16IN

N EA 100 8 100
CA08322.

SLEEVE VAULT

260346200 SLEEVE VAULT SOLID 2IN X 24IN

N EA 1 2 1
78-8026-7400-8 SJ. NOW AVAILABLE THROUGH TOUCH-TONE ORDER ENTRY.

260346218 SLEEVE VAULT SOLID 3IN X 24IN

N EA 1 2 1
78-8026-7402-4 SJ.

260346226 SLEEVE VAULT SOLID 4IN X 24IN

N EA 1 2 1
78-8026-7404-0 SJ.

260346234 SLEEVE VAULT SOLID 5IN X 26IN

N EA 1 2 1
78-8026-7407-3 SJ.

DISTRIBUTION SERVICES

NETWORK SERVICES

TOOLS

BUILDING JANITORIAL

AUTOMOTIVE

FORMS/OFFICE SUPPLIES

GENERAL

DATA VOICE

SLEEVE VAULT

PRODUCT IDENTIFIER		DESCRIPTION				
ITEM NUMBER	ORD. MULT.	SELL UNIT	STD. PKG. STOCK	LEAD TIME AVAILABILITY / PA	MIN. ORD.	A C
260346242		SLEEVE VAULT SOLID	6IN X 26IN			
N		EA	1	2	1	
		78-8026-7412-3 SJ.				
260346259		SLEEVE VAULT SOLID	7IN X 26IN			
N		EA	1	2	1	
		78-8026-7417-2 SJ.				
260346267		SLEEVE VAULT SOLID	8IN X 26IN			
N		EA	1	2	1	
		78-8011-1781-9 SJ.				
260346275		SLEEVE VAULT SOLID	9IN X 26IN			
N		EA	1	2	1	
		78-8011-1782-7 SJ.				
260346283		SLEEVE VAULT SOLID	10IN X 26IN			
N		EA	1	2	1	
		78-8013-0188-4 SJ.				
260346291		SLEEVE VAULT SOLID	10IN X 34IN			
N		EA	1	2	1	
260346309		SLEEVE VAULT SOLID	12IN X 28IN			
N		EA	1	2	1	
260346317		SLEEVE VAULT SPLIT	2IN X 24IN			
N		EA	1	2	1	
		2DS-24. NOW AVAILABLE THROUGH TOUCH-TONE ORDER ENTRY.				
260346325		SLEEVE VAULT SPLIT	3IN X 24IN			
N		EA	1	2	1	
		3DS-24.				
260346333		SLEEVE VAULT SPLIT	4IN X 24IN			
N		EA	1	2	1	
		4DS-24.				
260346341		SLEEVE VAULT SPLIT	5IN X 24IN			
N		EA	1	2	1	
		5DS-24.				
260346358		SLEEVE VAULT SPLIT	6IN X 26IN			
N		EA	1	2	1	
		6DS-26.				
260322482		SLEEVE VAULT SPLIT	7DS-26			
N		EA	1	2	1	
260322490		SLEEVE VAULT SPLIT	8DS-26			
N		EA	1	2	1	
260322508		SLEEVE VAULT SPLIT	9DS-26			
N		EA	1	2	1	
260322474		SLEEVE VAULT SPLIT	10DS-26			
N		EA	1	2	1	
260346366		SLEEVE VAULT SPLIT	10IN X 34IN			
N		EA	1	2	1	
		10DS-34.				

PRODUCT IDENTIFIER		DESCRIPTION				
ITEM NUMBER	ORD. MULT.	SELL UNIT	STD. PKG. STOCK	LEAD TIME AVAILABILITY / PA	MIN. ORD.	A C

260346374		SLEEVE VAULT SPLIT	12IN X 28IN			
N		EA	1	2	1	
		12SS-28.				

SLEEVING

401929856		SLEEVING 8 RED 3FT CK07851				
N		EA	1	2	1	

400303491 SLEEVING COTTON PLAIN 5/32IN

1100297	1	LB	IL	IN	MI	OH	WI
			08	08	08	08	08
CA06839. Used to cover twisted spliced wire.							

SLIDER TAPER BOOT

280052796		SLIDER TAPER BOOT TERMAX C2293				
N		EA	24	4	120	

SOLDER

401154281 SOLDER PASTE 2 OZ CAN

1208868	1	EA				
---------	---	----	--	--	--	--

400303632 SOLDER ROSIN CORE C 1LB SPOOL

1263368	1	SL	IL	IN	MI	OH	WI
			18	18	18	18	18
CA07076. For making soldered wire connections on equipment wiring. BSP 633-020-011.							

400303640 SOLDER ROSIN CORE C 5LB SPOOL

1263400	1	SL	IL	IN	MI	OH	WI
			18	18	18	18	18
CA07076. Same as 1LB.							

400303707 SOLDER SEAM D .5 LB BAR CA7318

1263483	1	BR	IL	IN	MI	OH	WI
			08	08	08	08	08
An alloy consisting of 50% tin and 50% lead. Used for running seams on split lead sleeves and for miscellaneous soldering on lead sheath or sleeves, BSP 633-020-011.							

260422597 SOLDER SLEEVE MTR-1-3000X

N		EA	100	6	200	
NOW AVAILABLE THROUGH TOUCH-TONE ORDER ENTRY.						

400303673 SOLDER STEARINE CORE B 5LB SPOOL

1263384	1	SL	IL	IN	MI	OH	WI
			08	08	08	08	08
CA07241. Used for soldering pressure testing flange to lead sheath, BSP 633-020-011.							

400409223 SOLDER WIPING E 4LB BR CA07161

1263525	1	EA	IL	IN	MI	OH	WI
			08	08	08	08	08
4 3/4 x 1 3/8 x 2 5/8 IN wedge used for wiping joints in lead sheath cables, BSP 633-020-011.							

PRODUCT IDENTIFIER		DESCRIPTION				
ITEM NUMBER	ORD. MULT.	SELL UNIT	STD. PKG. STOCK AVAILABILITY / PA	LEAD TIME	MIN. ORD.	A C

PRODUCT IDENTIFIER		DESCRIPTION				
ITEM NUMBER	ORD. MULT.	SELL UNIT	STD. PKG. STOCK AVAILABILITY / PA	LEAD TIME	MIN. ORD.	A C

SOLUTION

400303749 SOLUTION TEST E CA08287
 1310441 1 BT
 Pint Bottle. An all purpose concentrate which is equally suitable for use on lead and polyethylene jacketed cables. Use with Sprayer 5910 W/Adapter (3319343).

SOLVENT CABLE CLEANER

002051837 SOLVENT FILLED CABLE CLEANER 3GAL
 1139550 1 PL
 Gel-off filled cable and tool cleaner. Used to clean petrolatum compound from filled cables.

300067766 SOLVENT FILLED CABLE CLEANER 4413L
 1129957 1 KT IL IN MI OH WI
 08 08 08 08 08
 Cleaning solvent for cleaning grease and flex-gel filling compound from filled core cable without damaging connectors, cable or individual conductors. Up to 600 pair cable.

300067774 SOLVENT FILLED CABLE CLEANER 4413S
 6512046 8 KT IL IN MI OH WI
 08 08 08 08 08
 Used on smaller flexgel cable.

260338215 SOLVENT FILLED CABLE CLEANER 4413SX
 1948026 1 KT IL IN MI OH WI
 08 08 08 08 08
 Used for cleaning the filling compound from Flexgel Cables in Cev's. Huts and X-boxes. Bag is 12ft. in length.

300097110 SOLVENT FILLED CABLE CLEANER 4413XL
 1922641 1 KT IL IN MI OH WI
 08 08 08 08 08
 Over 600 pair cable.

300072238 SOLVENT FILLED CABLE CLEANER 4414
 5123471 1 KT IL IN MI OH WI
 08 08 08 08 08

002051811 SOLVENT FILLED CABLE CLEANER GOW12
 1214551 1 GR IL IN MI OH WI
 08 08 08 08 08
 Kit consists of a cloth wipe saturated with GEL-OFF cleaning fluid packed in a ziplock plastic bag. To be used to clean the filling compound from filled buried drops and tools.

SOLVENT CEMENT

002011112 SOLVENT CEMENT PVC
 1163790 1 EA
 One pint of plastic cement with applicator, used to cement together PVC conduit and plastic connectors and couplings.

SPACER

840850457 SPACER 840850457
 N EA 1 15 1
 NOW AVAILABLE THROUGH TOUCH-TONE ORDER ENTRY.

843780636 SPACER 843780636
 N EA 1 7 1

260439294 SPACER INTERMEDIATE DUCT 1.5IN SM CORE
 N
 Smooth core.

260339627 SPACER WEB TBTSW
 1980508 1 RO IL IN MI OH WI
 08
 Used with Thomas & Betts Kold & Klose.

300015583 SPACER CABLE STACKABLE
 1333278 200 EA IL IN MI OH WI
 08 08 08 08 08
 Used to support cable to strand. Spacers snap together to increase spacer height by # increment.

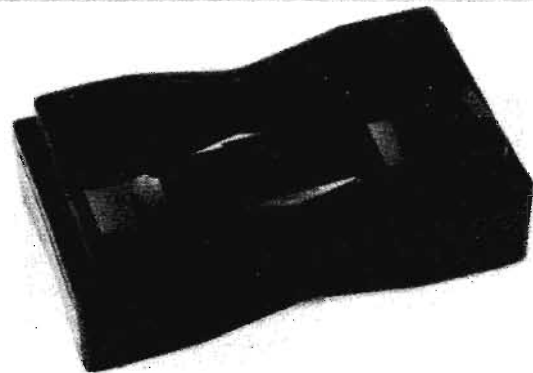

1333278

SPLICE

260365424 SPLICE 2525 FIBER OPTIC
 1954990 50 EA



260365424

DISTRIBUTION SERVICES

SPLICE

PRODUCT IDENTIFIER		DESCRIPTION				
ITEM NUMBER	ORD. MULT.	SELL UNIT	STD. PKG. STOCK AVAILABILITY / PA	LEAD TIME	MIN. ORD.	A C

260432927 SPLICE 2590 FIBER OPTIC
N EA 50 3 50
250 X 900.

260432935 SPLICE 2599 FIBER OPTIC
N EA 50 3 50
900 X 900.

SPLICE CASE

SEE CASE SPLICE.

SPLICE DROP WIRE

SEE CONNECTOR.

SPLITTER

105277792 SPLITTER UNIT D181683
N EA 1 2 1
NOW AVAILABLE THROUGH TOUCH-TONE ORDER ENTRY.

280052804 SPLITTER WIRE TERMAX C2298
N EA 25 4 50

SPOOL

260431523 SPOOL PLUGGING LX-K
1979005 1 EA

260404033 SPOOL PLUGGING MX-K
1979013 1 EA IL IN MI OH WI
08 08

SPRAY RESTORATION

300097011 SPRAY RESTORATION PIC 5301
N EA 1 2 1

SPRING

840736417 SPRING ASSEMBLY
N EA 1 12 1

842047029 SPRING COMB 221CP
N EA 1 2 1

STAKE

900214008 STAKE WOOD 4FT PAINTED ORANGE
6211060 1000 EA

900213992 STAKE WOOD 18IN PAINTED ORANGE 60/PK
6256743 1440 EA IL IN MI OH WI
08 08 08 08 08

NETWORK SERVICES

TOOLS

BUILDING JANITORIAL

AUTOMOTIVE

FORMS/OFFICE SUPPLIES

GENERAL

DATA VOICE

PRODUCT IDENTIFIER		DESCRIPTION				
ITEM NUMBER	ORD. MULT.	SELL UNIT	STD. PKG. STOCK AVAILABILITY / PA	LEAD TIME	MIN. ORD.	A C

260430764 STAKE WOOD 18IN PAINTED WHITE
1979161 1440 EA IL IN MI OH WI
08 08 08 08 08
Package of 60.

STAKE HARDWARE

900220872 STAKE HARDWARE DM SERIES
2756387 1 EA
Mounting package for a joint mount.

STAPLE

260355680 STAPLE 18 SIZE 7/16IN
1952523 1 PK
Package of 1000.

400270237 STAPLE B 3/4IN CA07307
N PK 50 4 50
1LB Package. A U shaped steel staple used primarily for securing wire and strand to wood.

400270252 STAPLE B 2IN CA07307
1102830 1 PK IL IN MI OH WI
08 08 08 08 08
1LB Package.

300077633 STAPLE CABLE .8IN
1171777 1 PC IL IN MI OH WI
08 08
Box of 400. DISCONTINUE UPON STOCK DEPLETION.

300068137 STAPLE CABLE 1.0IN
N BX 10 8 100
Box of 300.

300080173 STAPLE CABLE 1.3IN
1333369 1 PC IL IN MI OH WI
08 08
Box of 200. DISCONTINUE UPON STOCK DEPLETION.

400445813 STAPLE H CA08506
1159590 1 PK IL IN MI OH WI
18 18 18
Package of 1000. Used to attach station wire D indoors, BSP 080-720-109.

400451860 STAPLE J CA08507
1100354 1 PK IL IN MI OH WI
18 18 18 18
Package of 1000. Intended for fastening D station wire or small gauge ground wire using the E stapler, BSP 080-720-109.

400451936 STAPLE T-18 3/8IN
1265009 1 PK IL IN MI OH WI
18 18 18 18 18
Package of 1000. Staple for use in T18 and TM Stapler. Inside use only, BSP 080-110-101.

400451944 STAPLE T-25 3/8IN
1265140 1 PK IL IN MI OH WI
18 18 18 18 18
Package of 1000.

PRODUCT IDENTIFIER DESCRIPTION

ITEM NUMBER	ORD. MULT.	SELL UNIT	STD. PKG. STOCK AVAILABILITY / PA	LEAD TIME	MIN. ORD.	A C
-------------	------------	-----------	-----------------------------------	-----------	-----------	-----

400451951 STAPLE T-25 7/16IN
 1314294 1 PK IL IN MI OH WI
 18 18 18 18 18
 Package of 1000.

455033571 STAPLE T-75 5/8IN
 1265082 1 BX IL IN MI OH WI
 18 18 18 18 18
 Package of 1000. A 5/8in staple designed to be used in the D stapler. May be used to fasten inside wiring cable up to 25 pair.

401336367 STAPLE T-75 7/8IN
 1265108 1 PK IL IN MI OH WI
 18 18 18 18 18
 Package of 1000. Use on soft wood, BSP 080-110-101.

STEARINE

400270344 STEARINE CA04320
 1265462 1 EA
 For use in soldering to protect surfaces of lead sleeves and cable sheath from oxidation, BSP 632-020-100.

STEP MANHOLE

400270369 STEP MANHOLE CA06759
 1207332 1 EA

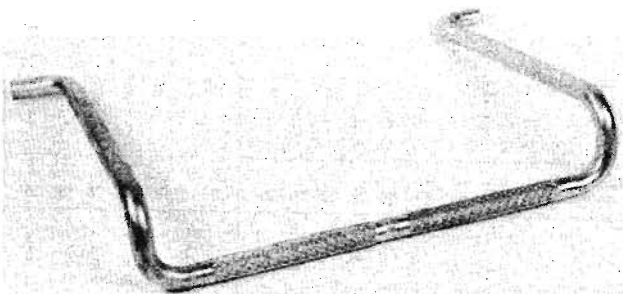

400270369

STEP POLE

400270377 STEP POLE B CA07183
 1265546 1 EA
 Detachable pole step provides a foothold below the first permanent step on wooden poles, BSP 081-735-600.

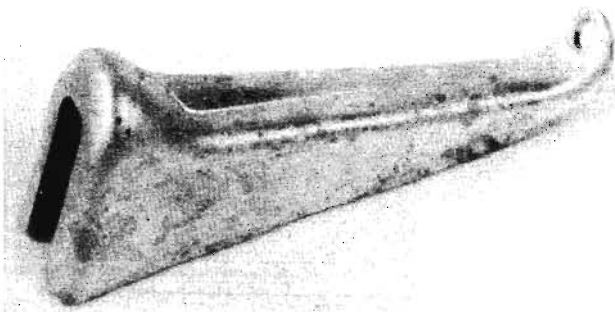

400270377

PRODUCT IDENTIFIER DESCRIPTION

ITEM NUMBER	ORD. MULT.	SELL UNIT	STD. PKG. STOCK AVAILABILITY / PA	LEAD TIME	MIN. ORD.	A C
-------------	------------	-----------	-----------------------------------	-----------	-----------	-----

400314688 STEP POLE SPIKE HEAD CA06140
 1265561 1 EA IL IN MI OH WI
 14 14 14 14 14
 The permanent steps used above detachable step, package of 50, BSP 621-210-011.

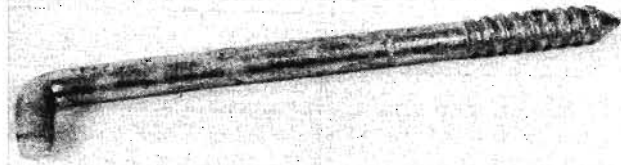

1265561

STICKER WARNING

STOPPER RUBBER

280027038 STOPPER RUBBER 5 W 1/2IN HOLE
 N EA 1 2 1
 NOW AVAILABLE THROUGH TOUCH-TONE ORDER ENTRY.

280027053 STOPPER RUBBER 5 W 5/8IN HOLE
 N EA 1 2 1

280027046 STOPPER RUBBER 5 W 7/16IN HOLE
 N EA 1 2 1

280027061 STOPPER RUBBER 5 W 9/16IN HOLE
 N EA 1 2 1

280027087 STOPPER RUBBER 7 W 5/8IN HOLE
 N EA 1 2 1

280027079 STOPPER RUBBER 7 W 9/16IN HOLE
 N EA 1 2 1

STRAND GALVANIZED

400468393 STRAND GALVANIZED A 2.2M 250FT
 N FT 250 3 250

401296538 STRAND GALVANIZED A 2.2M 500FT
 1146290 500 FT IL IN MI OH WI
 08 08 08 08 08
 For supporting aerial cables and for guying, BSP 621-410-200, BSP 627-230-201.

401296645 STRAND GALVANIZED A 6.6M 2500FT
 1333294 2500 FT IL IN MI OH WI
 08 08 08 08 08

401296652 STRAND GALVANIZED A 6.6M 5000FT
 1333286 5000 FT IL IN MI OH WI
 08 08 08 08 08

400468351 STRAND GALVANIZED A 10M 250FT
 7314989 250 FT IL IN MI OH WI
 08 08 08 08 08

DISTRIBUTION SERVICES
 NETWORK SERVICES
 TOOLS
 BUILDING JANITORIAL
 AUTOMOTIVE
 FORMS/OFFICE SUPPLIES
 GENERAL
 DATA VOICE

STRAND GALVANIZED

PRODUCT IDENTIFIER		DESCRIPTION						
ITEM NUMBER	ORD. MULT.	SELL UNIT	STD. PKG. STOCK AVAILABILITY / PA	LEAD TIME	MIN. ORD.	A	C	
401170394 STRAND GALVANIZED A 10M 2500FT								
1226894	2500	FT	IL 08 IN 08 MI 08 OH 08 WI 08					
400468385 STRAND GALVANIZED A 10M 5000FT								
1117010	5000	FT	IL 08 IN 08 MI 08 OH 08 WI 08					
STRANDLINK REDUCER								
260331897 STRANDLINK REDUCER 10M- 6M 5022								
N		EA	50	5	50			
260331905 STRANDLINK REDUCER 16M-10M 5023								
N		EA	50	5	50			
260331913 STRANDLINK REDUCER 6M-6.6M 5087								
N		EA	25	5	25			
STRANDWISE								
401421391 STRANDWISE BAIL LONG 5149 2.2M								
N		EA	50	5	50			
			3/16 inch.					
401421409 STRANDWISE BAIL LONG 5150 6.6M								
1940601	1	EA	IL 08 IN 08 MI 08 OH 08 WI 08					
			1/4 inch.					
401896907 STRANDWISE BAIL LONG 5151 6.0M								
1332999	1	EA	IL 08 IN 08 MI 08 OH 08 WI 08					
			5/16 inch. For use in installing guys and for dead ending suspension strand. Bail is a steel loop and is not made of strand, BSP 627-240-212.					
401896915 STRANDWISE BAIL LONG 5152 10.0M								
1180570	1	EA	IL 08 IN 08 MI 08 OH 08 WI 08					
			3/8 inch.					
401896923 STRANDWISE BAIL LONG 5253 16.0M								
1174458	1	EA	IL 08 IN 08 MI 08 OH 08 WI 08					
			7/16 inch.					
401073879 STRANDWISE BAIL SHORT 5100 6.6M								
1265843	1	EA	IL 08 IN 08 MI 08 OH 08 WI 08					
			1/4 inch.					
401896873 STRANDWISE BAIL SHORT 5101 6.0M								
1451286	1	EA	IL 08 IN 08 MI 08 OH 08 WI 08					
			5/16 inch.					
401896881 STRANDWISE BAIL SHORT 5102 10.0M								
1265884	1	EA	IL 08 IN 08 MI 08 OH 08 WI 08					
			3/8 inch.					

PRODUCT IDENTIFIER		DESCRIPTION						
ITEM NUMBER	ORD. MULT.	SELL UNIT	STD. PKG. STOCK AVAILABILITY / PA	LEAD TIME	MIN. ORD.	A	C	
400271961 STRANDWISE BAIL SHORT 5203 16.0M								
N		EA	25	5	25			
			7/16 inch.					
401896964 STRANDWISE FALSE DEADEND 5262 6.6M								
N		EA	25	5	25			
			1/4 inch.					
401896972 STRANDWISE FALSE DEADEND 5263 6.0M								
1230060	1	EA	IL 08 IN 08 MI 08 OH 08 WI 08					
			5/16 inch. For holding tension in strand at false deadends. Bail is made of extra high strength galvanized steel strand, BSP 627-240-213.					
401896980 STRANDWISE FALSE DEADEND 5264 10.0M								
N		EA	25	5	25			
			3/8 inch.					
401896998 STRANDWISE FALSE DEADEND 5269 6.0M								
N		EA	20	5	25			
			5/16 inch.					
401897004 STRANDWISE FALSE DEADEND 5270 10.0M								
N		EA	25	5	25			
			3/8 inch.					
STRAP								
841084064 STRAP BOND ASSEMBLY								
N		EA	1	1	1			
400952925 STRAP BOND D 11IN CA8688								
2791863	1	EA	IL 08 IN 08 MI 08 OH 08 WI 08					
			11IN ground strap, stranded copper wire and two tinned copper terminals.					
400952917 STRAP BOND D 6IN CA8688								
2791848	1	EA	IL 08 IN 08 MI 08 OH 08 WI 08					
			6IN ground strap, stranded copper wire and two tinned copper terminals.					
400952933 STRAP BOND D18 CA08688								
5228106	1	EA	IL 08 IN 08 MI 08 OH 08 WI 08					
			An 18IN #6 ground/bond strap with factory eyelets.					

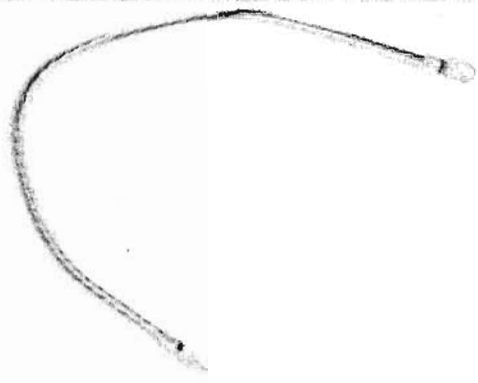

5228106

PRODUCT IDENTIFIER		DESCRIPTION				
ITEM NUMBER	ORD. MULT.	SELL UNIT	STD. PKG. STOCK AVAILABILITY / PA	LEAD TIME	MIN. ORD.	A C
400374401	N	EA	10	8	10	
STRAP CORNER WALL B CA08534						
401370606	N	EA	25	8	25	
STRAP FOR U GUARD 8IN X 8IN X 5FT						
260355813	N	EA	1	6	1	
STRAP GROUND P5933 NOW AVAILABLE THROUGH TOUCH-TONE ORDER ENTRY.						
400314738	N	EA	25	8	1000	
STRAP GUY B CA07083 Used for reinforcing B Guy Bolts and with 10,000 & 16,000lb guys. BSP 621-410-200.						
400314746	N	EA	25	8	25	
STRAP GUY L CA07083						
400305298	1160853	1	EA	IL 35 IN 35 MI 35 OH 35 WI 35		
STRAP PIPE S 3 1/2IN CA06178 Consists of a U-shaped galvanized mild steel strap 1in wide. Used for attaching lateral pipes to a pole or wall, BSP 622-400-211.						
401071006	1184432	1	EA	IL 35 IN 35 MI 35 OH 35 WI 35		
STRAP PIPE S 4IN CA06178						
400314803	1100396	1	EA	IL 08 IN 08 MI 08 OH 08 WI 08		
STRAP REINFORCING C CA06648 Used to support a 3/4in cable suspension bolt supporting 10M strand and cable, BSP 627-220-200.						
400314811	1266460	1	EA	IL 08 IN 08 MI 08 OH 08 WI 08		
STRAP REINFORCING S CA06648 Used to support a cable suspension screw or a 5/8IN cable suspension bolt on a straight pole lead, package of 200, BSP 627-220-200.						
400302386	1100412	1	EA	IL 08 IN 08 MI 08 OH 08 WI 08		
STRAP SLEEVE ADJUSTABLE B CA07114 For clamping large sleeves to walls. 1/32in thick x 1in wide x 19in long with 25 holes, BSP 632-020-100.						
400314829	3255521	1	EA	IL 08 IN 08 MI 08 OH 08 WI 08		
STRAP TIE STRAND B14 CA07230 A 14IN tie strap used to connect strands in mid-span to prevent cable dancing. BSP 627-390-205.						
400314837	1174953	1	EA	IL 08 IN 08 MI 08 OH 08 WI 08		
STRAP TIE STRAND B20 CA07230 A tie strap to connect to strands in mid-span to prevent cable dancing.						
400314845	N	EA	5	8	5	
STRAP TIE STRAND B26 CA07230						

PRODUCT IDENTIFIER		DESCRIPTION				
ITEM NUMBER	ORD. MULT.	SELL UNIT	STD. PKG. STOCK AVAILABILITY / PA	LEAD TIME	MIN. ORD.	A C
400302394	1266502	1	EA	IL 08 IN 08 MI 08 OH 08 WI 08		
STRAP WALL 1/2IN CA06568 Steel, hot-dip galvanized straps in various shapes, used in attaching suspension strand. Used to deadend 2200lb strand on masonry or frame buildings, BSP 627-610-220.						
400302402	1266528	1	EA	IL 08 IN 08 MI 08 OH 08 WI 08		
STRAP WALL 5/8IN CA06568 6M or larger strand.						
400272340	1266544	1	EA	IL 08 IN 08 MI 08 OH 08 WI 08		
STRAP WALL U CA06568 Used to deadend at 90 degree angle to wall or building.						

STRAP CABLE

400272084	1265926	25	EA	9	13/32IN	CA06344
STRAP CABLE 9 Used to secure cable, conduit, and U-guards to poles and or buildings, BSP 627-610-200.						
400272092	1265942	25	EA	11	9/15IN	CA06344
STRAP CABLE 11 IL 08 IN 08 MI 08 OH 08 WI 08						
400272100	1265967	25	EA	13	11/16IN	CA06344
STRAP CABLE 13 IL 08 IN 08 MI 08 OH 08 WI 08						
400272118	1265983	25	EA	16	7/8IN	CA06344
STRAP CABLE 16 IL 08 IN 08 MI 08 OH 08 WI 08						
400272126	1266007	25	EA	20	1 1/16IN	CA06344
STRAP CABLE 20 IL 08 IN 08 MI 08 OH 08 WI 08						
400272134	1266023	25	EA	24	1 5/16IN	CA06344
STRAP CABLE 24 IL 08 IN 08 MI 08 OH 08 WI 08						
400272142	1266049	25	EA	30	1 5/8IN	CA06344
STRAP CABLE 30 IL 08 IN 08 MI 08 OH 08 WI 08						
400272159	1266064	25	EA	36	2 IN	CA06344
STRAP CABLE 36 IL 08 IN 08 MI 08 OH 08 WI 08						
400272167	1266080	25	EA	42	2 3/8IN	CA06344
STRAP CABLE 42 IL 08 IN 08 MI 08 OH 08 WI 08						
400272175	1266106	25	EA	56	3 IN	CA06344
STRAP CABLE 56 IL 08 IN 08 MI 08 OH 08 WI 08						
400272183	N	EA	25	64	4 IN	CA06344
STRAP CABLE 64 N EA 25 6 200						

DISTRIBUTION SERVICES
NETWORK SERVICES
TOOLS
BUILDING JANITORIAL
AUTOMOTIVE
FORMS/OFFICE SUPPLIES
GENERAL
DATA VOICE

DISTRIBUTION SERVICES
 NETWORK SERVICES
 TOOLS
 BUILDING JANITORIAL
 AUTOMOTIVE
 FORMS/OFFICE SUPPLIES
 GENERAL
 DATA VOICE

STRAP GUARD

PRODUCT IDENTIFIER		DESCRIPTION						
ITEM NUMBER	ORD. MULT.	SELL UNIT	STD. PKG.		LEAD TIME		MIN. ORD.	A C
			STOCK AVAILABILITY / PA					

STRAP GUARD

400314753 STRAP GUARD CABLE U 0 CA06789
 1268221 1 EA
 A (U) shaped galvanized steel strap with a hole on each end for fastening cables and cable guards to walls, poles, etc., BSP 629-200-206.

400314092 STRAP GUARD CABLE U 1 CA06789
 1104240 1 EA
 IL IN MI OH WI
 08 08 08 08 08

400314761 STRAP GUARD CABLE U 1A CA06789
 1266247 1 EA
 IL IN MI OH WI
 08 08 08 08 08

400314779 STRAP GUARD CABLE U 2 CA06789
 1266262 1 EA
 IL IN MI OH WI
 08 08 08 08 08

400314787 STRAP GUARD CABLE U 3 CA06789
 1266288 1 EA
 IL IN MI OH WI
 08 08 08 08 08

400314795 STRAP GUARD CABLE U 4 CA06789
 1266304 1 EA
 IL IN MI OH WI
 08 08 08 08 08

STRAP JUMPER

403065246 STRAP JUMPER 4000D 36PTJ
 1441121 1 EA
 Package of 12.

260302310 STRAP JUMPER 4005DPM 36PTJ
 1939157 1 EA
 IL IN MI OH WI
 08 08 08 08 08
 Package of 12.

STRIP

103671269 STRIP FILLER 710FS-25
 1935148 1 EA
 Used on all 710BC125 bridging connectors before encapsulating.

280038613 STRIP H PLASTIC 0841
 N FT 1 2 1

401839154 STRIP MARKER 66M 1-50 WHITE
 N EA 50 4 150
 Adhesive strip used to mark 66M 150 connecting blocks in terminals and cross-connecting boxes, BSP 631-040-211N.

401839188 STRIP MARKER 66M51-100 YELLOW
 4200949 1 PK
 IL IN MI OH WI
 08
 Adhesive strip used to mark 66M 150 connecting blocks in terminals and cross-connecting boxes.

PRODUCT IDENTIFIER		DESCRIPTION						
ITEM NUMBER	ORD. MULT.	SELL UNIT	STD. PKG.		LEAD TIME		MIN. ORD.	A C
			STOCK AVAILABILITY / PA					

400292017 STRIP TERMINAL GROUND CA06133
 N EA 150 1 150
 A brass strip with 5 binding posts, for use on indoor cable terminals, BSP 461-615-201.

STRIP DESIGNATION

100727395 STRIP DESIGNATION 6F
 N EA 1 2 1

100729649 STRIP DESIGNATION 98A
 N EA 25 7 25

100729789 STRIP DESIGNATION 104A
 N EA 70 2 70

100729797 STRIP DESIGNATION 105A
 N EA 12 2 12
 Used for all manual PBX switchboards with 11 3/16in face opening.

102579802 STRIP DESIGNATION 188AG 1/100
 N PK 1 1 1

841852239 STRIP DESIGNATION 841852239
 N EA 1 2 1

400328258 STRIP DESIGNATION CA8448
 N EA 1 13 1
 NOW AVAILABLE THROUGH TOUCH-TONE ORDER ENTRY.

STRIP FANNING

100730506 STRIP FANNING 19B
 N EA 32 2 32
 Molded insulating material. 20 wire holes or slots.

100730514 STRIP FANNING 20A
 N EA 1 13 1
 For use with terminal strips in the ED32152-01 Line Finder Unit in Step-By-Step systems.

100730522 STRIP FANNING 20B
 N EA 1 14 1
 For use with #252 type terminal strips in the J53125, #608A switchboard of PBX System.

100730589 STRIP FANNING 24A
 N EA 30 10 30
 Intended to mount directly on #251 type terminal strips used in the local AMA translator frame of the #5 Crossbar System.

100730597 STRIP FANNING 25A
 N EA 200 7 200
 Intended to mount directly on the #262 type terminal strips of the ED31274 selector frame.

DISTRIBUTION SERVICES

NETWORK SERVICES

TOOLS

BUILDING JANITORIAL

AUTOMOTIVE

FORMS/OFFICE SUPPLIES

GENERAL

DATA VOICE

PRODUCT IDENTIFIER							DESCRIPTION						
ITEM NUMBER	ORD. MULT.	SELL UNIT	STD. PKG. STOCK AVAILABILITY / PA	LEAD TIME	MIN. ORD.	A C							
100730613 STRIP FANNING 27A													
N		EA	32	2	32		Consists of a slotted strip of insulating material. Initial use with #251 type term strips on the J278536 number group frame in the #5 crossbar system.						
STRIP GROUND													
100730654 STRIP GROUND 2A													
1267047	1	EA					Consists of a plate equipped with two binding posts, washers and nuts. Has a (U) shaped slot for mounting in inside cable terminal sections, BSP 460-100-400.						
100730662 STRIP GROUND 2B													
N		EA	200	1	1		REPLACED BY STRIP GROUND 2A						
100730712 STRIP GROUND 6A													
N		EA	300	1	1								
STUB CABLE													
260439658			STUB CABLE 10D	50 PAIR	40FT	N							
260439666			STUB CABLE 10D	50 PAIR	50FT	N							
260439674			STUB CABLE 10D	100 PAIR	40FT	N							
260439682			STUB CABLE 10D	100 PAIR	50FT	N							
260439690			STUB CABLE 10D	200 PAIR	40FT	N							
260439708			STUB CABLE 10D	300 PAIR	50FT	N							
260439716			STUB CABLE 10D	600 PAIR	40FT	N							
260439724			STUB CABLE 10D	600 PAIR	50FT	N							
260439732			STUB CABLE 10D	900 PAIR	30FT	N							
260439740			STUB CABLE 10D	900 PAIR	40FT	N							
260439765			STUB CABLE 10D	1200 PAIR	40FT	N							
260439773			STUB CABLE 10D	1200 PAIR	50FT	N							

PRODUCT IDENTIFIER							DESCRIPTION							
ITEM NUMBER	ORD. MULT.	SELL UNIT	STD. PKG. STOCK AVAILABILITY / PA	LEAD TIME	MIN. ORD.	A C								
280046681			STUB CABLE 10D	1500 PAIR	30FT	N								
260439799			STUB CABLE 10D	1500 PAIR	50FT	N								
280046699			STUB CABLE 10D	1800 PAIR	30FT	N								
260439807			STUB CABLE 10D	1800 PAIR	40FT	N								
300051554			STUB CABLE 10D1	50 PAIR	30FT									
4207191	1	EA	IL	IN MI OH WI	08 08 08		Cable stub with air core cable on one side of plug & a compound filled core on opposite side. Conductors are color coded. BSP 622-520-101.							
300051562			STUB CABLE 10D1	100 PAIR	30FT									
4207209	1	EA	IL	IN MI OH WI	08 08 08									
300051570			STUB CABLE 10D1	200 PAIR	30FT									
4207217	1	EA	IL	IN MI OH WI	08 08 08									
104010699			STUB CABLE 10D1	600 PAIR	30FT									
1936070	1	EA	IL	IN MI OH WI	08 08 08									
104010715			STUB CABLE 10D1	900 PAIR	30FT									
1936062	1	EA	IL	IN MI OH WI	08 08 08									
104010731			STUB CABLE 10D1	1200 PAIR	30FT									
1939470	1	EA	IL	IN MI OH WI	08 08 08									
260439757			STUB CABLE 10DB	900 PAIR	50FT	N								
260439815			STUB CABLE 10DB	1800 PAIR	50FT	N								
104139258			STUB CABLE 10E	50 PAIR	20FT	N	EA	1	3	1				
104139266			STUB CABLE 10E	50 PAIR	30FT									
1927681	1	EA	IL	IN MI OH WI	08 08 08 08 08									
104139274			STUB CABLE 10E	50 PAIR	40FT	N	EA	1	3	1				
104139282			STUB CABLE 10E	50 PAIR	50FT	N	EA	1	3	1				
104139340			STUB CABLE 10E	100 PAIR	20FT	N	EA	1	3	1				
104139357			STUB CABLE 10E	100 PAIR	30FT									
1927673	1	EA	IL	IN MI OH WI	08 08 08 08 08									

DISTRIBUTION SERVICES

NETWORK SERVICES

TOOLS

BUILDING JANITORIAL

AUTOMOTIVE

FORMS/OFFICE SUPPLIES

GENERAL

DATA VOICE

STUB CABLE

PRODUCT IDENTIFIER		DESCRIPTION							MIN. A
ITEM NUMBER	ORD. MULT.	SELL UNIT	STD. PKG. STOCK AVAILABILITY / PA	LEAD TIME			MIN. ORD.	A C	
104139365		STUB CABLE	10E 100 PAIR	40FT					
N		EA	1	3	1				
104139373		STUB CABLE	10E 100 PAIR	50FT					
N		EA	1	3	1				
104138094		STUB CABLE	10E 200 PAIR	20FT					
N		EA	1	3	1				
104138102		STUB CABLE	10E 200 PAIR	30FT					
1927665	1	EA	IL 08	IN 08	MI 08	OH 08	WI 08		
104138110		STUB CABLE	10E 200 PAIR	40FT					
N		EA	1	3	1				
104138128		STUB CABLE	10E 200 PAIR	50FT					
N		EA	1	3	1				
104138185		STUB CABLE	10E 300 PAIR	20FT					
N		EA	1	3	1				
104138193		STUB CABLE	10E 300 PAIR	30FT					
1927657	1	EA	IL 08	IN 08	MI 08	OH 08	WI 08		
104138201		STUB CABLE	10E 300 PAIR	40FT					
N		EA	1	3	1				
104138219		STUB CABLE	10E 300 PAIR	50FT					
N		EA	1	3	1				
104138276		STUB CABLE	10E 400 PAIR	20FT					
N		EA	1	3	1				
104138284		STUB CABLE	10E 400 PAIR	30FT					
1927640	1	EA	IL 08	IN 08	MI 08	OH 08	WI 08		
104138292		STUB CABLE	10E 400 PAIR	40FT					
N		EA	1	3	1				
104138300		STUB CABLE	10E 400 PAIR	50FT					
N		EA	1	3	1				
104138367		STUB CABLE	10E 600 PAIR	20FT					
N		EA	1	3	1				
104138375		STUB CABLE	10E 600 PAIR	30FT					
1927632	1	EA	IL 08	IN 08	MI 08	OH 08	WI 08		
104138383		STUB CABLE	10E 600 PAIR	40FT					
N		EA	1	3	1				
104138391		STUB CABLE	10E 600 PAIR	50FT					
N		EA	1	3	1				
104138409		STUB CABLE	10E 900 PAIR	20FT					
N		EA	1	3	1				
104138417		STUB CABLE	10E 900 PAIR	30FT					
1927624	1	EA	IL 08	IN 08	MI 08	OH 08	WI 08		

PRODUCT IDENTIFIER		DESCRIPTION							MIN. A
ITEM NUMBER	ORD. MULT.	SELL UNIT	STD. PKG. STOCK AVAILABILITY / PA	LEAD TIME			MIN. ORD.	A C	
104138425		STUB CABLE	10E 900 PAIR	40FT					
N		EA	1	3	1				
104138433		STUB CABLE	10E 900 PAIR	50FT					
N		EA	1	3	1				
104138441		STUB CABLE	10E 1200 PAIR	20FT					
N		EA	1	3	1				
104138458		STUB CABLE	10E 1200 PAIR	30FT					
1927616	1	EA	IL 08	IN 08	MI 08	OH 08	WI 08		
104138466		STUB CABLE	10E 1200 PAIR	40FT					
N		EA	1	3	1				
104138474		STUB CABLE	10E 1200 PAIR	50FT					
N		EA	1	3	1				
104138482		STUB CABLE	10E 1500 PAIR	20FT					
N		EA	1	3	1				
104138490		STUB CABLE	10E 1500 PAIR	30FT					
1927608	1	EA	IL 08	IN 08	MI 08	OH 08	WI 08		
104138508		STUB CABLE	10E 1500 PAIR	40FT					
N		EA	1	3	1				
104260005		STUB CABLE	10E 1500 PAIR	50FT					
N		EA	1	3	1				
104138524		STUB CABLE	10E 1800 PAIR	30FT					
1927582	1	EA	IL 08	IN 08	MI 08	OH 08	WI 08		
104138532		STUB CABLE	10E 1800 PAIR	40FT					
N		EA	1	3	1				
104139449		STUB CABLE	12E 600 PAIR	30FT					
1927574	1	EA	IL 08	IN 08	MI 08	OH 08	WI 08		
Designed for use between two pressurized cables or between a pressurized and non-pressurized cable to keep cables separated pneumatically.									
104139001		STUB CABLE	12E 900 PAIR	30FT					
1927541	1	EA	IL 08	IN 08	MI 08	OH 08	WI 08		
104139043		STUB CABLE	12E 1200 PAIR	30FT					
1927533	1	EA	IL 08	IN 08	MI 08	OH 08	WI 08		
104139084		STUB CABLE	12E 1500 PAIR	30FT					
1927517	1	EA	IL 08	IN 08	MI 08	OH 08	WI 08		
104139118		STUB CABLE	12E 1800 PAIR	30FT					
1927491	1	EA	IL 08	IN 08	MI 08	OH 08	WI 08		

PRODUCT IDENTIFIER		DESCRIPTION				
ITEM NUMBER	ORD. MULT.	SELL UNIT	STD. PKG. STOCK AVAILABILITY / PA	LEAD TIME	MIN. ORD.	A C

PRODUCT IDENTIFIER		DESCRIPTION				
ITEM NUMBER	ORD. MULT.	SELL UNIT	STD. PKG. STOCK AVAILABILITY / PA	LEAD TIME	MIN. ORD.	A C

STUB TERMINAL

100735927 STUB TERMINAL 1B1 25 FT
 N EA 1 1
 Lead sheath, used in conjunction with a #49A1 cable terminal.

SUPPORT

840890909 SUPPORT BRACKET ASSEMBLY
 N EA 1 14 1

400273074 SUPPORT CLAMP B CA07941
 1268706 1 EA IL IN MI OH WI
 08 08 08 08 08
 Used for all galvanized strand at maximum span lengths for in-line poles. Also when placing a second aerial cable on an existing 5/8in type A Suspension Bolt, BSP 627-220-204.

400273090 SUPPORT DEAD END CA07674
 1268763 1 EA IL IN MI OH WI
 14 14 14 14 14
 Used in supporting C rural wire where a dead end attachment is required, BSP 624-700-200.

400402483 SUPPORT RACK CABLE B CA08557
 1100503 1 EA IL IN MI OH WI
 35 35 35 35 35
 A steel support for use when mounting cable racks at corners in manholes 12FT long or longer, BSP 622-520-100.

400273215 SUPPORT RACK CABLE L CA06389
 N EA 25 8 25

400273223 SUPPORT RACK CABLE S CA06389
 1268904 1 EA IL IN MI OH WI
 35 35 35 35 35
 Short support, used to support cable racks in loading manholes, package of 50, BSP 622-520-100.

400315024 SUPPORT SHEAVE B CA07975
 1269027 1 PK IL IN MI OH WI
 08
 10 per package.

400315032 SUPPORT SHEAVE C CA07975
 N EA 1 4 2

900317587 SUPPORT SPLICE RC100
 N SE 1 2 1
 Permits fast multi-positioning of manhole racks or unistretts and hooks to facilitate supports of a closure.

401683537 SUPPORT TANGENT B CA08851
 2622688 1 EA IL IN MI OH WI
 18 18 18 18 18
 For use in supporting, F, multiple drop at intermediate poles, BSP 462-500-011.

SUPPORT CABLE

SEE TIE CABLE.

SUPPORT INSULATOR

400273108 SUPPORT INSULATOR B CA07772 951
 1268805 50 EA
 Consists of a cast iron or aluminum frame, 3/4in flange, with a set screw for securing the support in place. Intended for use as an intermediate attachment, BSP 080-720-136.

400273124 SUPPORT INSULATOR D CA07772
 1268821 15 EA IL IN MI OH WI
 08 08 08 08 08
 Consists of a cast iron frame, 3/4in or less flange, set screw for securing support, also provided with a 3/8in clean and two 10-24 tapped holes, BSP 627-610-200, BSP 462-350-213.

SUPPORT WIRE

400273272 SUPPORT WIRE C CA07758
 N EA 400 4 400
 For securing C rural wire at cross attachments, BSP 624-700-200, BSP 624-700-205.

400273280 SUPPORT WIRE D CA07758
 1268987 1 EA IL IN MI OH WI
 08 08 08 08 08
 For securing C rural wire to in-line-poles.

400273298 SUPPORT WIRE E CA07758
 N EA 400 4 400

SYSTEM

260422696 SYSTEM PRESSURE BLOCKING (PBSS) A
 N EA 10 6 10
 For forming a pressure dam in telecommunication cable. NOW AVAILABLE THROUGH TOUCH-TONE ORDER ENTRY.

260422704 SYSTEM PRESSURE BLOCKING (PBSS) B
 N EA 10 6 10
 For forming a pressure dam in telecommunication cable. NOW AVAILABLE THROUGH TOUCH-TONE ORDER ENTRY.

TAG

300060290 TAG 'CAUTION - FIBER OPTIC' DG6070
 1197558 1 EA
 Orange with black lettered tags will be used in the underground to tag innerducts for fiber optic cable installations. Tag is 2in x 3 1/2in.

260302989 TAG 'DEFECTIVE POLE B/C'
 1940072 1 EA IL IN MI OH WI
 14 14 14 14 14

DISTRIBUTION SERVICES

NETWORK SERVICES

TOOLS

BUILDING JANITORIAL

AUTOMOTIVE

FORMS/OFFICE SUPPLIES

GENERAL

DATA VOICE

DISTRIBUTION SERVICES

NETWORK SERVICES

TOOLS

BUILDING JANITORIAL

AUTOMOTIVE

FORMS/OFFICE SUPPLIES

GENERAL

DATA VOICE

TAG

PRODUCT IDENTIFIER		DESCRIPTION				
ITEM NUMBER	ORD. MULT.	SELL UNIT	STD. PKG. STOCK AVAILABILITY / PA	LEAD TIME	MIN. ORD.	A C

260429469 TAG 'WARNING - FIBER OPTIC'
 N EA 1000 4 1000
 Self-laminating orange vinyl cable tag for fiber optic cable.

401195870 TAG 'WARNING - PROTECTOR'
 1107391 1 EA IL IN MI OH WI
 08

260440268 TAG 'WARNING - SELF-LAMINATING'
 N EA 1000 4 5
 Orange vinyl cable tag used to identify underground cable.

TAG CABLE

400274247 TAG 'CABLE STRAP M' CA07270
 N EA 250 2 250
 Tag straps are for use on cables 1IN to 2 5/8IN in diameter. NOW AVAILABLE THROUGH TOUCH-TONE ORDER ENTRY.

300061108 TAG 'CABLE STRAP - LIGHTGUIDE RED'
 5118091 50 EA IL IN MI OH WI
 08
 Stamped (LIGHTGUIDE CABLE ILLINOIS BELL).

400274239 TAG 'CABLE STRAP' CA07270
 1100511 1 EA IL IN MI OH WI
 08 08 08 08 08
 For tagging large underground cables and load coils with stubs.

300061090 TAG 'CABLE STRAP' PLASTIC GRAY
 5118075 1 EA IL IN MI OH WI
 08
 CM4SP76LB.

400274262 TAG 'CABLE TERMINAL M' CA07270
 N EA 500 2 500
 For use on cables less than 1 inch in diameter.

400274254 TAG 'CABLE TERMINAL' CA07270
 N EA 500 2 500

400274213 TAG 'CABLE - OCTAGONAL' CA07270
 1270223 1 EA IL IN MI OH WI
 08 08 08 08 08
 For tagging underground toll and trunk cables, package of 50.

400274221 TAG 'CABLE - ROUND' CA07270
 1270249 1 EA IL IN MI OH WI
 08 08 08 08 08
 For tagging underground cables, package of 500, BSP 632-020-100.

PRODUCT IDENTIFIER		DESCRIPTION				
ITEM NUMBER	ORD. MULT.	SELL UNIT	STD. PKG. STOCK AVAILABILITY / PA	LEAD TIME	MIN. ORD.	A C

TAG IDENTIFICATION BINDER GROUP

Provides a method for binder group identification in pulp insulated cable. Yellow with black numerals and adhesive backed. Prenumbered 1 thru 30. Supplied in booklet of 6 of each numbered tag.

300037256 TAG IDENTIFICATION 1 TO 18 PC1800
 1194613 1 EA

300041175 TAG IDENTIFICATION 1 TO 24 PC2400
 5112219 1 BK IL IN MI OH WI
 08

401829924 TAG IDENTIFICATION 1 TO 27 PC2700
 1180323 1 BK IL IN MI OH WI
 08 08 08 08 08

300041183 TAG IDENTIFICATION 1 TO 30 PC3000
 5112177 1 BK IL IN MI OH WI
 08 08

300041191 TAG IDENTIFICATION 1 TO 36 PC3600
 5112151 1 BK IL IN MI OH WI
 08 08 08 08 08

TAG POLE

401427927 TAG POLE 7 PER DRAWING 2C425
 3261362 1 EA
 Zinc pole tag style #7, .024in thick, 1 7/8in X 5 7/8in, embossed with: O.B.T. CO., CONTACT.

401428008 TAG POLE CEI SPL NO0
 3261388 100 EA IL IN MI OH WI
 14

401428016 TAG POLE CEI SPL NO1
 3261404 100 EA IL IN MI OH WI
 14

401428024 TAG POLE CEI SPL NO2
 3261420 100 EA IL IN MI OH WI
 14

401428032 TAG POLE CEI SPL NO3
 3261446 100 EA IL IN MI OH WI
 14

401428040 TAG POLE CEI SPL NO4
 3261461 100 EA IL IN MI OH WI
 14

401203872 TAG POLE CEI SPL NO5
 1168534 100 EA IL IN MI OH WI
 14

401428065 TAG POLE CEI SPL NO6 OR 9
 3261503 100 EA IL IN MI OH WI
 14

401428073 TAG POLE CEI SPL NO7
 1166801 100 EA IL IN MI OH WI
 14

PRODUCT IDENTIFIER		DESCRIPTION					
ITEM NUMBER	ORD. MULT.	SELL UNIT	STD. PKG. STOCK AVAILABILITY / PA	LEAD TIME	MIN. ORD.	A C	
401428081 TAG POLE CEI SPL NO8							
3261545	100	EA	IL IN MI OH WI				
3261545 100 EA IL IN MI OH WI 14							
260449319 TAG POLE IDENTIFICATION - INDIANA BELL							
N							
TAPE							
400275582 TAPE ALUMINUM B 2IN X 40FT CA07165							
1102871	1	RO					
Prevents the polyethylene from melting and oozing in wire mesh when copper is applied in soldering the sleeves to wire cloth, BSP 081-869-101.							
401245543 TAPE ALUMINUM B 4IN X 40FT CA07165							
2805788	1	RO	IL IN MI OH WI				
2805788 1 RO IL IN MI OH WI 08 08 08 08 08							
260395686 TAPE BARRICADE CAUTION 3IN X 1000FT							
1975425	1	RL	IL IN MI OH WI				
1975425 1 RL IL IN MI OH WI 18 18 18 18 18							
Yellow with black letters. Tape is used as a hazard warning around pits that have been excavated for splicing.							
260331699 TAPE BINDER 4IN X 25FT ROLL							
1947424	1	RO	IL IN MI OH WI				
1947424 1 RO IL IN MI OH WI 08 08 08 08 08							
A Nylon screen material used to spiral wrap cable conductors. Used to improve housekeeping in closures and terminals.							
260428784 TAPE BURIED CABLE CAUTION 3IN							
N		EA		1	1	1	
5000FT Roll.							
260412614 TAPE BURIED CABLE CAUTION 3IN							
N		EA		8	1	8	
1000FT Roll.							
400275616 TAPE COTTON 1/2IN X 18YD ROLL							
1100537	1	RO	IL IN MI OH WI				
1100537 1 RO IL IN MI OH WI 08 08 08 08 08							
For protecting the core from the sheath at cable openings, BSP 632-020-120.							
400275624 TAPE COTTON 1IN X 18YD ROLL							
1270546	1	RO	IL IN MI OH WI				
1270546 1 RO IL IN MI OH WI 08 08 08 08 08							
Heavyweight, CA06684.							
401502794 TAPE CR 36							
N		RO		1	4	4	
NOW AVAILABLE THROUGH TOUCH-TONE ORDER ENTRY.							
400275632 TAPE CROSS 28IN X 20FT ROLL CA07144							
1168866	1	RO	IL IN MI OH WI				
1168866 1 RO IL IN MI OH WI 08 08 08 08 08							
Provides temporary protection of uncompleted splices, trouble openings, splices, etc., at locations where cable is exposed to moisture, BSP 081-869-101.							

PRODUCT IDENTIFIER		DESCRIPTION					
ITEM NUMBER	ORD. MULT.	SELL UNIT	STD. PKG. STOCK AVAILABILITY / PA	LEAD TIME	MIN. ORD.	A C	
280003039 TAPE DETECTABLE MARKING 2							
N		RO		1	7	1	
Must specify length.							
900198839 TAPE DIAPER 4							
N		EA		50	4	50	
900198847 TAPE DIAPER 18							
N		CT		1			
900198821 TAPE DIAPER C1230 2 1/2IN X 6FT							
N		CT		100		100	
100 rolls per carton.							
900246893 TAPE DOUBLE COATED FOAM 2IN X 36YD							
1150979	1	RO	IL IN MI OH WI				
1150979 1 RO IL IN MI OH WI 18 18 18 18							
401195896 TAPE DOUBLE FOAM BLACK 4416							
1299263	1	RO	IL IN MI OH WI				
1299263 1 RO IL IN MI OH WI 18 18							
996235461 TAPE DR 3/4IN X 15FT ROLL							
1270462	1	RO	IL IN MI OH WI				
1270462 1 RO IL IN MI OH WI 18 18 18 18 18							
For use in splicing cable, CA06863 - BSP 081-869-101.							
400275657 TAPE DR 2IN X 15FT ROLL							
1270488	1	RO	IL IN MI OH WI				
1270488 1 RO IL IN MI OH WI 08 08 08 08 08							
CA06863.							
002084481 TAPE DUCT TDC-2 2IN X 60YD ROLL							
1190173	1	RO	IL IN MI OH WI				
1190173 1 RO IL IN MI OH WI 08 08 08 08 08							
Used to anchor under the carpet cable at required intervals.							
401008172 TAPE FLEXIDUCT B 2IN X 75FT							
7373027	1	RO	IL IN MI OH WI				
7373027 1 RO IL IN MI OH WI 32 32 32 32 32							
A double-back adhesive tape. Used to hold rubber flex duct to the floor.							
002075083 TAPE FOAM P032W2R1							
1138396	1	RL	IL IN MI OH WI				
1138396 1 RL IL IN MI OH WI 18 18 18							
300067881 TAPE GLASS CLOTH 691 1IN X 25YD							
6511931	1	RO	IL IN MI OH WI				
6511931 1 RO IL IN MI OH WI 08 08 08 08 08							
300067899 TAPE HEAT REACTIVE 6000-2							
N		RO		1	2	1	
260323274 TAPE LR 3/4IN X 30FT							
N		RO		1	2	1	
Linerless Rubber.							
260323282 TAPE LR 2IN X 30FT							
N		RO		1	2	1	
Linerless Rubber.							
260344676 TAPE MASTIC D181777							
1950436	1	EA	IL IN MI OH WI				
1950436 1 EA IL IN MI OH WI 08 08 08							

DISTRIBUTION SERVICES
 NETWORK SERVICES
 TOOLS
 BUILDING JANITORIAL
 AUTOMOTIVE
 FURNIS/OFFICE SUPPLIES
 GENERAL
 DATA VOICE

DISTRIBUTION SERVICES

NETWORK SERVICES

TOOLS

BUILDING JANITORIAL

AUTOMOTIVE

FORMS/OFFICE SUPPLIES

GENERAL

DATA VOICE

TAPE

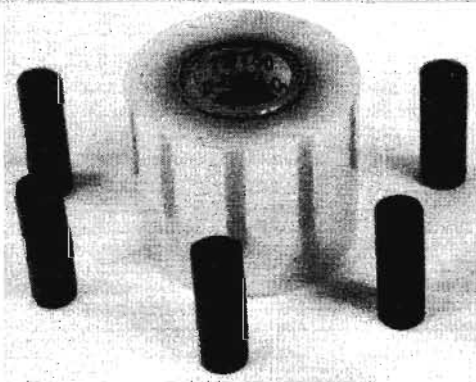
PRODUCT IDENTIFIER		DESCRIPTION						
ITEM NUMBER	ORD. MULT.	SELL UNIT	STD. PKG. STOCK AVAILABILITY / PA	LEAD TIME	MIN. ORD.	A C		
300067618 TAPE MASTIC SEALANT STRIP TBT20								
1225110	1	BX	IL IN MI OH WI 08 08 08 08 08					
A sealant tape 2in X 12in for use with the Kold-N-Klose sleeve in repairs to plastic sheath cables.								
400328233 TAPE PAPER B 1/2IN X 20YD ROLL								
1270785	1	RO	IL IN MI OH WI 08 08 08 08 08					
For repairing cable conductor insulation and for various marking and binding purposes in splicing cable, BSP 633-300-200.								
400277216 TAPE PAPER B 3/8IN X 20YD ROLL								
1270769	1	RO	IL IN MI OH WI 08 08 08 08 08					
401349584 TAPE PERFORATED 50 FLEX 1IN X 75FT								
7223529	1	RO	IL IN MI OH WI 18 18					
400278651 TAPE POLYETHYLENE B 3IN X 35FT								
1102897	1	RO	IL IN MI OH WI 08 08 08 08 08					
Used for wrapping splices in coaxial, polyethylene insulated and other high dielectric type cables.								
996771465 TAPE POLYETHYLENE B 3IN X 100FT								
1270926	1	RO	IL IN MI OH WI 08 08 08 08 08					
CA07209.								
300067915 TAPE PRESSURE TBT50 2IN X 40YD ROLL								
1183376	1	RO	IL IN MI OH WI 08 08 08 08 08					
A roll of mylar tape used for repairs in pressurized plastic cables. To be used in conjunction with Kold-N-Klose sleeving and sealant tape.								
								
1183376								
280043563 TAPE RE-ENTERABLE RTW-36								
N		RL	1	4	60			
400278883 TAPE SERV LEAD 1LB CA06631								
1271023	1	RO	IL IN MI OH WI 08 08 08 08 08					
Primarily to protect small lead covered cables from damage where adjustable grade clamps or copper lashing wire is installed. BSP 081-869-101.								

PRODUCT IDENTIFIER		DESCRIPTION						
ITEM NUMBER	ORD. MULT.	SELL UNIT	STD. PKG. STOCK AVAILABILITY / PA	LEAD TIME	MIN. ORD.	A C		
401823430 TAPE THONG D CA08475								
N		EA	6	1	6			
TAPE FRICTION								
400275665 TAPE FRICTION 3/4IN X 36FT BLACK								
1270603	1	RO	CA06747.					
995910882 TAPE FRICTION 2IN X 75FT BLACK								
N		RO	30	4	60			
Used as outer wrapping on aerial cable and other miscellaneous usage, BSP 081-869-101.								
400275681 TAPE FRICTION 2IN BLACK								
1224394	1	RO	IL IN MI OH WI 18 18 18 18 18					
TAPE PULLING								
260381793 TAPE PULLING POLYESTER 2500LB								
N		FT	1	2	1			
260381785 TAPE PULLING PRELUBE 1250LB JACKET								
N		FT	5000	1	5000			
260381827 TAPE PULLING PRELUBE 1250LB WOVEN								
N		FT	1	3	1			
260426820 TAPE PULLING PRELUBE 1500LB								
1977868	5000	FT	IL IN MI OH WI 35 35 35 35 35					
Blended woven.								
280055765 TAPE PULLING PRELUBE 2000LB								
1930271	3000	FT	IL IN MI OH WI 35 35 35 35 35					
Tape used for pulling fiber-optic cable.								
TAPE SEALING								
260365440 TAPE SEALING 2900R 1 1/2IN								
1955013	1	RL						
260423843 TAPE SEALING 2900R3 3IN								
N		RO	1	3	160			
401799275 TAPE SEALING B 40IN CA07601								
2825844	1	PK	IL IN MI OH WI 08 08 08 08 08					
.75in wide x .25in thick x 32.05in long, used with the 2 type cable closure, package of 2.								
401799283 TAPE SEALING B 72IN CA07601								
2823765	1	RO	IL IN MI OH WI 08 08 08 08 08					
Black tape used to close splice cases.								

TERMINAL AERIAL POLE MOUNT

DISTRIBUTION SERVICES

NETWORK SERVICES

TOOLS

BUILDING JANITORIAL

AUTOMOTIVE

FORMS/OFFICE SUPPLIES

GENERAL

DATA VOICE

PRODUCT IDENTIFIER		DESCRIPTION					
ITEM NUMBER	ORD. MULT.	SELL UNIT	STD. PKG. STOCK AVAILABILITY / PA	LEAD TIME	MIN. ORD.	A C	
280043555 TAPE SEALING REENTER RTE 36							
1930404	1	RO	IL IN MI OH WI				
			08 08 08 08 08				
3/4in X 36in roll. DISCONTINUE AND FORWARD TO TAPE SEAL R RTE 46X3/4 UPON STOCK DEPLETION							
300074283 TAPE SEALING REENTER RTE 46							
5121533	1	RO	IL IN MI OH WI				
			08 08 08 08 08				
A 3/4in X 46in petroleum resistant tape to be used when sealing closures or splice cases.							
280041153 TAPE SEALING REENTER RTE 62							
1924621	1	RO	IL IN MI OH WI				
			08 08 08 08 08				
3/4in X 62in roll.							
300074275 TAPE SEALING REENTER RTW 72							
5121558	1	RO	IL IN MI OH WI				
			08 08 08 08 08				
1 1/2 X 72in roll.							

TAPE VINYL

260417761 TAPE VINYL	1/2IN X	20FT	35 GRAY
1973842	1	RO	
3M electrical tape.			
260391040 TAPE VINYL	1/2IN X	20FT	35 YELLOW
N	RO	10	2 10
3M electrical tape.			
300036225 TAPE VINYL	3/4IN X	36FT	
1313023	1	PK	IL IN MI OH WI
			18 18 18 18 18
All weather, used for general purposes, 5 rolls per package.			
300036233 TAPE VINYL	1 1/2IN X	44FT	
1313015	1	PK	IL IN MI OH WI
			18 18 18 18 18
All weather. needed to wrap entire 2 type closure or larger closures on a double sheath cable when a plug has been made, 5 rolls per package.			
400278909 TAPE VINYL C	3/8IN X	15YD	
1102905	1	RO	IL IN MI OH WI
			08 08 08 08 08
Gray tape intended only for indoor use in splicing plastic jacketed station wire, 144 rolls per package.			
400278941 TAPE VINYL E	2IN X	100FT	
1271122	1	RO	IL IN MI OH WI
			08 08 08 08 08
A 2in wide black pigmented pressure sensitive vinyl tape used as a protective wrapping for buried and underground cable splices, BSP 633-020-205.			
002047108 TAPE VINYL MASTIC	1 1/2IN X	20FT	
1333484	1	RO	IL IN MI OH WI
			18 18 18 18 18

PRODUCT IDENTIFIER		DESCRIPTION					
ITEM NUMBER	ORD. MULT.	SELL UNIT	STD. PKG. STOCK AVAILABILITY / PA	LEAD TIME	MIN. ORD.	A C	
300051711 TAPE VINYL MASTIC 4 IN X 10FT							
1333492	1	RO	IL IN MI OH WI				
			18 18 18 18				
900364605 TAPE VINYL MASTIC 6 IN X 10FT							
N	RO	1		3	1		

TEE

843080276 TEE COVER
N EA 1 10 1

TERMINAL AERIAL POLE MOUNT

102483286 TERMINAL CABLE 53A4 50 12FT STUB	
1100578 1 EA	
A Terminal equipped with 2C1 terminal blocks in a weatherproof galvanized metal box with a hinged cover used as an unprotected distribution terminal, BSP 231-210-211.	

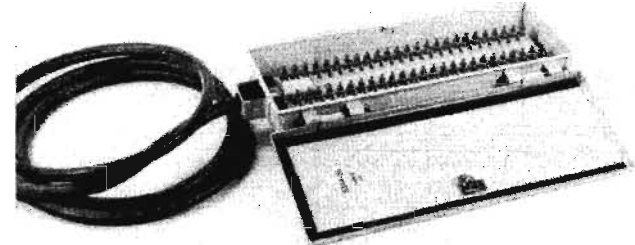

102483286

102308483 TERMINAL CABLE 53A4 50 25FT STUB	
5150847 1 EA IL IN MI OH WI	
	08 08 08 08 08
A non protected distribution terminal.	
102483807 TERMINAL CABLE 53A4 50P 12FT STUB	
1190777 1 EA IL IN MI OH WI	
	08 08 08 08 08
A weatherproof box e/w a 3C1 Block Terminal and a plastic sheath cable stub. A non-protected distribution terminal, BSP 631-210-211.	
102308491 TERMINAL CABLE 53A4 50P 25FT STUB	
N EA 1 1 1	
NOW AVAILABLE THROUGH TOUCH-TONE ORDER ENTRY.	
103066981 TERMINAL CABLE 53A4E-50 12FT STUB	
N EA 1 4 1	
Lead sheath stub.	
102979093 TERMINAL CABLE 53A4E-50 25FT STUB	
N EA 1 4 1	
NOW AVAILABLE THROUGH TOUCH-TONE ORDER ENTRY.	
103719886 TERMINAL CABLE NCA25A1 12FT	
1457507 1 EA IL IN MI OH WI	
	08 08 08 08 08
100746221 TERMINAL CABLE NF25 12FT	
7220145 1 EA IL IN MI OH WI	
	08 08 08 08 08

DISTRIBUTION SERVICES

NETWORK SERVICES

TOOLS

BUILDING JANITORIAL

AUTOMOTIVE

FORMS/OFFICE SUPPLIES

GENERAL

DATA VOICE

TERMINAL AERIAL POLE MOUNT

PRODUCT IDENTIFIER		DESCRIPTION					
ITEM NUMBER	ORD. MULT.	SELL UNIT	STD. PKG. STOCK AVAILABILITY / PA	LEAD TIME	MIN. ORD.	A	C
100746239		EA	1	25FT	1		
103719969 TERMINAL CABLE NFA25A1 12							
1109215	1	EA	IL 08	IN 08	MI 08	OH 08	WI 08
Unprotected type terminals, intended for use where cable protection is not required.							
103719977 TERMINAL CABLE NFA25A1 25							
1146571	1	EA	IL 08	IN 08	MI 08	OH 08	WI 08
100746288 TERMINAL CABLE NHE25 12FT							
1174516	1	EA	IL 08	IN 08	MI 08	OH 08	WI 08
Protected type terminal similar to NC 25 except that it has no ground terminal outside the housing and has the 2A1B protectors, BSP 631-210-101.							
100746296 TERMINAL CABLE NHE25 25FT							
6263640	1	EA	IL 08	IN 08	MI 08	OH 08	WI 08
Distribution terminals can be mounted directly on the cable and strand, walls or poles, BSP 631-210-101.							

TERMINAL AERIAL STRAND

280052739		EA	1	C2880AS	4		2
Strand Mounted, Termax.							
102773785 TERMINAL CABLE 105A2 12							
1100586	1	EA	IL 08	IN 08	MI 08	OH 08	WI 08
Non-protected weatherproof terminal for outside use on polyethylene insulated cables, BSP 631-250-100.							
280071655 TERMINAL CABLE 105A2 12E							
1935445	1	EA	IL 08	IN 08	MI 08	OH 08	WI 08
A 12pr fixed count terminal used on PIC cable sizes up to 1.8 inches O.D. Can be pole or wall mounted with use of 51A bracket, BSP 631-250-100.							
102773793 TERMINAL CABLE 105A2 25							
1100594	1	EA	IL 08	IN 08	MI 08	OH 08	WI 08
280071648 TERMINAL CABLE 105A2 25E							
1935452	1	EA	IL 08	IN 08	MI 08	OH 08	WI 08
A 25 pair fixed count terminal, BSP 631-250-100.							
102902905 TERMINAL CABLE 105A2B10							
		EA	4		1		1
103203246 TERMINAL CABLE 105B1 10							
1170233	1	EA	IL 08	IN 08	MI 08	OH 08	WI 08

PRODUCT IDENTIFIER		DESCRIPTION					
ITEM NUMBER	ORD. MULT.	SELL UNIT	STD. PKG. STOCK AVAILABILITY / PA	LEAD TIME	MIN. ORD.	A	C
100746031		EA	1	12FT	1		1
With hinged metal cover, containing terminals & a lead covered polyvinyl chloride insulated non quaded stub cable molded in a gas-tight terminal block. 16 prs of conductors, 32 #2A1B protectors.							
102389624 TERMINAL CABLE NC16P 12FT							
1333690	1	EA	IL 08	IN 08	MI 08	OH 08	WI 08
Hinged cover, containing terminals & an alpeth sheath non-quaded stub cable molded in a gas-tight terminal block. 16 prs of conductors, 32 #2A1B protectors.							

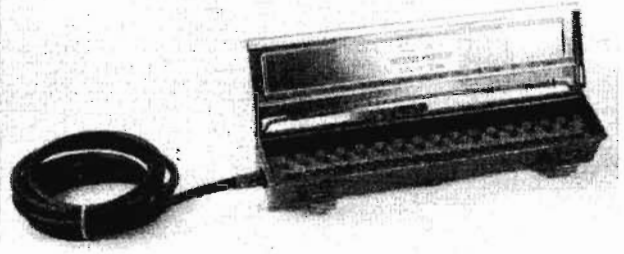

1333690

103719860 TERMINAL CABLE NCA10A1 12FT							
5322529	1	EA	IL 08	IN 08	MI 08	OH 08	WI 08
Hinged cover, containing terminal block having an alpeth sheath cable stub arranged for 10 prs of conductors. Has binding posts and 20 #2A1B protector units.							
100746155 TERMINAL CABLE NF16 6FT							
		EA	1		1		1
100746171 TERMINAL CABLE NF16 12FT							
1220426	1	EA	IL 08	IN 08	MI 08	OH 08	WI 08
Each consists essentially of a cast metal housing having a hinged metal cover. Used on strand supported cable or mounted to walls or poles with a 45A bracket.							
102389731 TERMINAL CABLE NF16P 6FT							
2303305	1	EA	IL 08	IN 08	MI 08	OH 08	WI 08
102389756 TERMINAL CABLE NF16P 12FT							
2790741	1	EA	IL 08	IN 08	MI 08	OH 08	WI 08
Alpeth sheath stub.							
102389764 TERMINAL CABLE NF16P 25FT							
		EA	1		1		1
NOW AVAILABLE THROUGH TOUCH-TONE ORDER ENTRY.							

DISTRIBUTION SERVICES

NETWORK SERVICES

TOOLS

BUILDING JANITORIAL

AUTOMOTIVE

FORMS/OFFICE SUPPLIES

GENERAL

DATA VOICE

PRODUCT IDENTIFIER DESCRIPTION

ITEM NUMBER	ORD. MULT.	SELL UNIT	STD. PKG. STOCK AVAILABILITY / PA	LEAD TIME	MIN. ORD.	A C
-------------	------------	-----------	-----------------------------------	-----------	-----------	-----

103719936 TERMINAL CABLE NFA10A1 06
 1446724 1 EA IL IN MI OH WI
 08 08 08 08 08
 Hinged aluminum cover. Term block consists of raised binding posts and an alpeth sheath cable stub arranged for 16 prsof conductors. 6 ft stub, unprotected.

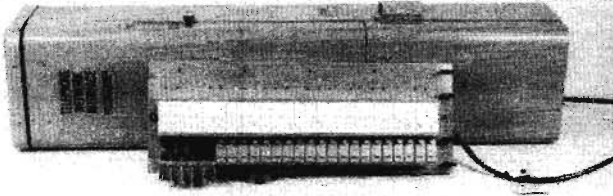

1446724

103719944 TERMINAL CABLE NFA10A1 12
 1446708 1 EA IL IN MI OH WI
 08 08 08 08 08

100746247 TERMINAL CABLE NHE16 12FT
 3263921 1 EA IL IN MI OH WI
 08 08 08 08 08

280052747 TERMINAL CABLE TERMAX 5PR BLOCK C2881AS
 N EA 1 4 2

280029455 TERMINAL CABLE TERMAX 15PR BLOCK
 1923003 1 EA IL IN MI OH WI
 08 08 08 08 08

280052762 TERMINAL CABLE TERMAX 20PR BLOCK C2884AS
 N EA 1 4 1

TERMINAL BET

260334685 TERMINAL BUILDING INDOOR NO STUB 100PR
 1948760 1 EA
 A 100 pair indoor modular building terminal, with cover, with 100 3B1E protector modules, input MS2, output 66 block.

260334594 TERMINAL BUILDING INDOOR NO STUB 25PR
 1948786 1 EA IL IN MI OH WI
 08 08 08 08 08
 A 25 pair indoor modular building terminal, with cover, with 25 3B1E protector modules, input MS2, output 66 block.

260334644 TERMINAL BUILDING INDOOR NO STUB 50PR
 1948794 1 EA IL IN MI OH WI
 15 15 15
 A 50 pair indoor modular building terminal, with cover, with 50 3B1E protector modules, input MS2, output 66 block.

260376033 TERMINAL BUILDING INDOOR W/STUB 25PR
 1960922 1 EA IL IN MI OH WI
 08 08 08 08 08
 A 25 pair indoor stubbed building terminal e/w 25 3B1E unit protectors, a 66-type terminal block and a 15ft 26GA stub. REPLACES PROTECTOR 189BC1A3 25 PAIR.

PRODUCT IDENTIFIER DESCRIPTION

ITEM NUMBER	ORD. MULT.	SELL UNIT	STD. PKG. STOCK AVAILABILITY / PA	LEAD TIME	MIN. ORD.	A C
-------------	------------	-----------	-----------------------------------	-----------	-----------	-----

260376058 TERMINAL BUILDING INDOOR W/STUB 50PR
 1960948 1 EA IL IN MI OH WI
 08 08 08 08 08
 A 50-pair indoor stubbed building terminal e/w 50 3B1E unit protectors, a 66-type terminal block and a 15ft 26GA stub. REPLACES PROTECTOR 189BC1A3 50 PAIR.

260376041 TERMINAL BUILDING INDOOR W/STUB 100PR
 1960930 1 EA IL IN MI OH WI
 15 15 15 15 15
 A 100 pair indoor stubbed building terminal e/w 100 3B1E unit protectors, a 66-type terminal block and a 15ft 26GA stub. REPLACES PROTECTOR 189BC1A3 100 PAIR.

260362934 TERMINAL BUILDING OTD 25/ 50
 1956193 1 EA IL IN MI OH WI
 15 15 15 15 15
 WALLMOUNT. E/W 25 pair preconnectorized MS2 stubbed gas tube protector and a 50 pair non-stubbed ALS terminal block BET2550VMM, SEE AM631-201-006.

260363106 TERMINAL BUILDING OTD 25/ 50 PED
 1956185 1 EA IL IN MI OH WI
 08 08 08 08 08
 A ground line pedestal style building terminal, e/w a 25 pair preconnectorized MS2 stubbed gas tube protector and a 50 pair non-stubbed ALS terminal block OBT2550VMM, SEE AM631-260-901.

260362942 TERMINAL BUILDING OTD 50/100
 1956201 1 EA IL IN MI OH WI
 15 15 15 15 15
 WALLMOUNT. E/W 50 pair preconnectorized MS2 stubbed gas tube protector and a 100 pair non-stubbed ALS terminal block BET50100VMM, SEE AM631-201-006.

260363114 TERMINAL BUILDING OTD 50/100 PED
 1956177 1 EA IL IN MI OH WI
 08 08 08 08 08
 A ground line pedestal style building terminal, e/w a 50 pair preconnectorized MS2 stubbed gas tube protector and a 100 pair non-stubbed ALS terminal block OBT50100VMM, SEE AM631-260-901.

260362959 TERMINAL BUILDING OTD 100/200
 1956219 1 EA IL IN MI OH WI
 15 15 15 15 15
 WALLMOUNT. E/W 100 pair preconnectorized MS2 stubbed gas tube protector and a 200 pair non-stubbed ALS terminal block BET100200VMM, SEE AM631-201-006.

260363189 TERMINAL BUILDING OTD BASE PLATE
 N EA 1 6 1
 WALLMOUNT.

260396536 TERMINAL BUILDING OTD SKIRT 100
 1967679 1 EA IL IN MI OH WI
 08 08 08 08 08
 WALLMOUNT. An outdoor metallic skirt placed below a 100 pair outdoor wallmount. Used for additional conduit entrances and/or wire storage.

TERMINAL BET

PRODUCT IDENTIFIER		DESCRIPTION						
ITEM NUMBER	ORD. MULT.	SELL UNIT	STD. STOCK	PKG. AVAILABILITY	LEAD TIME / PA	MIN. ORD.	A C	
260396544 TERMINAL BUILDING OTD SKIRT 25/50								
1967687	1	EA	IL	IN	MI	OH	WI	
			08		08	08		
WALLMOUNT. An outdoor metallic skirt placed below a 25 or 50 pair outdoor wallmount. Used for additional conduit entrances and/or wire storage.								
300040854 TERMINAL CABLE PROTECTED WP50VIBT								
N		EA	1		8		1	
Outdoor building entrance terminal, wallmount.								

PRODUCT IDENTIFIER		DESCRIPTION						
ITEM NUMBER	ORD. MULT.	SELL UNIT	STD. STOCK	PKG. AVAILABILITY	LEAD TIME / PA	MIN. ORD.	A C	
260390513 TERMINAL BET/NI 189F1E4 -050M								
1965194	1	EA	IL	IN	MI	OH	WI	
					15	15		
Terminal Building Entrance/Network Interface, indoor w/protectors & cover, CC 106276462.								
260390521 TERMINAL BET/NI 189F1E4 -100M								
1965202	1	EA	IL	IN	MI	OH	WI	
					15	15		
Terminal Building Entrance/Network Interface, indoor w/protectors & cover, CC 106276470.								
260390992 TERMINAL BET/NI 730F1 -050M								
N		EA	1		1		1	
Terminal Building Entrance Network Interface, BTNI jack, indoor non-protected w/unique MBT lock, CC 106280928.								
260390539 TERMINAL BET/NI 730F1 -100M								
1965210	1	EA	IL	IN	MI	OH	WI	
					15			
Terminal Building Entrance/Network Interface, BTNI jack, indoor non-protected, w/unique MBT lock, CC 106280936.								

TERMINAL BET/NI

260424668 TERMINAL BET/NI 189F							
1977173	1	EA	Terminal Building Entrance/Network Interface, MBT indoor lock.				
260424676 TERMINAL BET/NI 189F -025							
1977181	1	EA	IL	IN	MI	OH	WI
			08		08	08	
Terminal Building Entrance/Network Interface, indoor lock kit.							
260424684 TERMINAL BET/NI 189F -050							
1977199	1	EA	IL	IN	MI	OH	WI
			08				
Terminal Building Entrance/Network Interface, indoor lock kit.							
260424700 TERMINAL BET/NI 189F -050							
1977215	1	EA	IL	IN	MI	OH	WI
					15		
Terminal Building Entrance/Network Interface, repair parts.							
260424692 TERMINAL BET/NI 189F -100							
1977207	1	EA	IL	IN	MI	OH	WI
					08		
Terminal Building Entrance/Network Interface, indoor lock kit.							
260424643 TERMINAL BET/NI 189F1E3 -025A							
1977140	1	EA	IL	IN	MI	OH	WI
					15		
Terminal Building Entrance/Network Interface, indoor with protectors and cover.							
260424635 TERMINAL BET/NI 189F1E3 -050A							
1977157	1	EA	IL	IN	MI	OH	WI
Terminal Building Entrance/Network Interface, indoor with protectors and cover.							
260424650 TERMINAL BET/NI 189F1E3 -100A							
1977165	1	EA	IL	IN	MI	OH	WI
			15		15	15	
Terminal Building Entrance/Network Interface, indoor with protectors and cover.							
260391024 TERMINAL BET/NI 189F1E4 -025M							
1966796	1	EA	IL	IN	MI	OH	WI
					15		
Terminal Building Entrance/Network Interface, indoor w/protectors and cover.							

260430715 TERMINAL BUILDING/NI OTD 100/200PR							
N		EA	1		6		1
WALLMOUNT. A 200 PR cabinet E/W 100 network interfaces and 5-pin protection. (OBET/NID-100/200R)							
260432414 TERMINAL BUILDING/NI OTD PEDESTAL							
N		EA	1		2		1
25PR Panel. Used w/260394234 to upgrade to 50PR.							
260432414 TERMINAL BUILDING/NI OTD PEDESTAL							
N		EA	1		2		1
25PR PANEL. Used with 260394234 to upgrade to 50 pr.							
260341185 TERMINAL CABLE 189PAM1E4- 25							
1949537	1	EA	IL	IN	MI	OH	WI
					15		
Protector.							
260341201 TERMINAL CABLE 189PAM1E4- 50							
1949529	1	EA	IL	IN	MI	OH	WI
					15		
Protector.							
260341193 TERMINAL CABLE 189PAM1E4-100							
1949511	1	EA	IL	IN	MI	OH	WI
					15		
Protector.							
260341219 TERMINAL CABLE 289TPMA 25 PAIR							
N		EA	1		1		1
260341227 TERMINAL CABLE 289TPMA 50 PAIR							
N		EA	1		1		1
260341235 TERMINAL CABLE 289TPMA 100 PAIR							
N		EA	1		1		1
260348073 TERMINAL CABLE MLS-925-8AA 25 PAIR							
1952143	1	EA	IL	IN	MI	OH	WI
					15		

DISTRIBUTION SERVICES

NETWORK SERVICES

TOOLS

BUILDING JANITORIAL

AUTOMOTIVE

FORMS/OFFICE SUPPLIES

GENERAL

DATA VOICE

PRODUCT IDENTIFIER		DESCRIPTION					
ITEM NUMBER	ORD. MULT.	SELL UNIT	STD. PKG. STOCK AVAILABILITY / PA	LEAD TIME	MIN. ORD.	A C	
260348081 TERMINAL CABLE MLS-950-8AA 50 PAIR							
1952135	1	EA	IL IN MI OH WI 15				
260430707 TERMINAL OTD BUILDING WALLMOUNT NI 100PR							
N		EA	1	6	1		
A 100 PR cabinet E/W 100 network interfaces and 5-pin protection. (OBET/NID-100R).							
260394242 TERMINAL, OUTDOOR BUILDING PEDESTAL NI							
1979922	1	EA	IL IN MI OH WI 15 15 15 15				
50 pair e/w network interfaces with 5-pin protectors, 60-706-10.							
260394234 TERMINAL, OUTDOOR BUILDING PEDESTAL NI							
1879914	1	EA	IL IN MI OH WI 15 15 15 15				
Network interface 25 5-pin protection.							

TERMINAL BLOCK
SEE BLOCK TERMINAL

TERMINAL CABLE

100744861 TERMINAL CABLE 45A 15FT						
N		EA	1	2	1	
Intended for terminating video pairs in central offices or program pick-up points. Gas-tight.						
402373591 TERMINAL CABLE SPLICE 1T20A1 16						
1132225	1	EA	IL IN MI OH WI 08 08 08			
402373609 TERMINAL CABLE SPLICE 1T20B1 16						
1132282	1	EA	IL IN MI OH WI 08 08 08			
401429998 TERMINAL CABLE SPLICE T20C1 16						
1330928	1	EA	IL IN MI OH WI 08 08 08			
ND2.						
300061249 TERMINAL CABLE SPLICE T20D1 16						
1330936	1	EA	IL IN MI OH WI 08 08 08			
260440573 TERMINAL CABLE UG HHT25 AIRCORE STUB						
N		EA	1	6	5	
25 pair.						
260422472 TERMINAL CABLE UG HHT-25 FILLED STUB						
1975581	1	EA	IL IN MI OH WI 08 08 08 08 08			
D-Terminator, 25 Pair.						
300083797 TERMINAL CABLE VW8 MB 25-050 OBT						
1334045	1	EA	IL IN MI OH WI 08 08 08			
300080959 TERMINAL CABLE VW8 MB 50-100 OBT						
1333773	1	EA	IL IN MI OH WI 08 08 08			

PRODUCT IDENTIFIER		DESCRIPTION					
ITEM NUMBER	ORD. MULT.	SELL UNIT	STD. PKG. STOCK AVAILABILITY / PA	LEAD TIME	MIN. ORD.	A C	
TERMINAL CROSS CONNECT							
842360562 TERMINAL CROSS CONNECT 303 CONN							
N		EA	1	1	1		
842360810 TERMINAL CROSS CONNECT 305 CONN							
N		EA	1	9	1		

TERMINAL SOLDERLESS

401352075 TERMINAL SOLDERLESS 32054						
1179606	1	EA				
401172085 TERMINAL SOLDERLESS 32562						
5128645	1	EA	IL IN MI OH WI 18			

TERMINAL WIRE

300040268 TERMINAL WIRE 101B CAC						
4204677	1	EA				
Wire terminal used as a connecting device between drop and block wire and cable, E/W a hinged cover.						
101233179 TERMINAL WIRE 104B3 6						
1140319	1	EA	IL IN MI OH WI 08 08 08 08 08			
For use with B multiple drop wire and B rural distributing wire. Cast metal housing containing a connecting block eqpd w/8PP of binding posts & 2 terms for ringing ground connections. BSP 624-300-100.						
100747575 TERMINAL WIRE 107A2						
1273664	1	EA	IL IN MI OH WI 08 08 08 08 08			
A Pair of phenolic blocks each equipped with a binding post for making subscriber line connections without removing insulation from C rural wire, BSP 624-730-100.						
100747583 TERMINAL WIRE 108A1 16						
1147223	1	EA	IL IN MI OH WI 16 16 16 16 16			
Is equipped for mounting on aerial cable or support wire of multiple line wire for use with multiple line wires. 16 pair non-protected, BSP 624-300-103.						
100747591 TERMINAL WIRE 108A1B 16						
1145037	1	EA	IL IN MI OH WI 16 16 16 16 16			
16 pair protected, for terminating C, D, E, rural wire, BSP 624-300-103.						
400279436 TERMINAL WIRE BURIED D CA07849						
1273763	1	EA	IL IN MI OH WI 08 08 08 08 08			
Made from bonderized steel with dark green enamel finish and used to terminate splices on buried cable. To mount on a steel post, BSP 629-720-215.						

DISTRIBUTION SERVICES

NETWORK SERVICES

TOOLS

BUILDING JANITORIAL

AUTOMOTIVE

FORMS/OFFICE SUPPLIES

GENERAL

DATA VOICE

DISTRIBUTION SERVICES

NETWORK SERVICES

TOOLS

BUILDING JANITORIAL

AUTOMOTIVE

FORMS/OFFICE SUPPLIES

GENERAL

DATA VOICE

TERMINAL WIRE

PRODUCT IDENTIFIER		DESCRIPTION						
ITEM NUMBER	ORD. MULT.	SELL UNIT	STD. PKG. STOCK AVAILABILITY / PA	LEAD TIME	MIN. ORD.	A	C	
400279444 TERMINAL WIRE BURIED E CA07849								
1223876	1	EA	IL 08 IN 08 MI 08 OH 08 WI 08					
Made from bonderized steel with dark green enamel finish and used to terminate splices on buried cable. Pole or wall mounting with a 13in back, BSP 629-720-215.								
260348065 TERMINAL WIRE-FED MLS-912-8BB 12 PAIR								
N								

260348065 TERMINAL WIRE-FED MLS-912-8BB 12 PAIR							
N							

TERMINATION

104196290 TERMINATION 6A1							
N		EA	1	1	1		
100747716 TERMINATION 504A							
N		EA	1	8	1		
Consists of section WR-159 size waveguide equipped with an unpressurized flange at one end and a shorting plate at the other. Provided with a No. 218 type resistor.							
100747823 TERMINATION 510A							
N		EA	1	8	1		
Consists of section of WR90 waveguide equipped with a pressurized flange at one end and an endplate at the other.							
100747997 TERMINATION 520A							
N		EA	1	8	1		
Consists of a section of WR229 waveguide having an unpressurized flange at one end and a shorting plate on the other. Equipped with a KS 19757 vane.							
101420677 TERMINATION 524A							
N		EA	1	9	1		
A straight piece of WC75 waveguide having a pressurized flange and a shorting plate at the other. Shorting plate supports a cylindrical resistor coaxial within the waveguide. ORDER THRU TOUCH-TONE.							

TERMSEAL

SEE CAP TERMINAL

TESTER

260447842 TESTER 1PR REPLACEMENT DISH							
N							
For use in Reliable self-strip cross-connect cabinets.							
260447834 TESTER 1PR W/LEADS FOR RLS CABINET							
N							
For permanent placement in Reliable cross-connect cabinet.							
260441514 TESTER 50 PAIR							
N		EA	1	6	1		
For Reliable self-strip cabinets.							

PRODUCT IDENTIFIER		DESCRIPTION						
ITEM NUMBER	ORD. MULT.	SELL UNIT	STD. PKG. STOCK AVAILABILITY / PA	LEAD TIME	MIN. ORD.	A	C	
260441498 TESTER POCKET 1 PAIR								
N		EA	1	4	1			
For Reliable self-strip cabinets.								

THERMOSTAT

260435680 THERMOSTAT STC120							
1970250		EA					

TIE CABLE

400412094 TIE CABLE B 7 GREEN							
3378844	1	PK					
Package of 10.							
401682265 TIE CABLE CK20986 L1							
1204511	1	PK	IL 08 IN 08 MI 08 OH 08 WI 08				
8.0in self-locking cable tie used to bundle wire and cable up to 2 inches in diameter, light olive gray. Package of 100.							
401675251 TIE CABLE CK20986 L1X							
1189779	1	PK	IL 08 IN 08 MI 08 OH 08 WI 08				
8.0in black cable tie for outdoor use by cable forces. Package of 100.							
401682281 TIE CABLE CK20986 L2							
1190058	1	PK	IL 08 IN 08 MI 08 OH 08 WI 08				
11.5in self-locking cable tie used to bundle wire and cable up to 3 inches in diameter, light olive gray. Package of 100.							
401682323 TIE CABLE CK20986 L4							
1165407	1	PK	IL 08 IN 08 MI 08 OH 08 WI 08				
3.75in self-locking cable tie used to bundle wire and cable up to 5/8 inch in diameter, light olive gray. Package of 100.							
401684287 TIE CABLE CK20986 L5							
1154112	1	PK	IL 08 IN 08 MI 08 OH 08 WI 08				
5.5in self-locking cable tie used to bundle wire and cable up to 1 1/4 inches in diameter, light olive gray. Package of 100.							
401682364 TIE CABLE CK20986 L7							
1138875	1	PK	IL 08 IN 08 MI 08 OH 08 WI 08				
14.5in self-locking cable tie used to bundle wire and cable up to 4 inches in diameter, natural. Package of 100.							
401737929 TIE CABLE CK20986 L8							
1143412	1	PK	IL 08 IN 08 MI 08 OH 08 WI 08				
7.75in self-locking cable tie used to bundle wire and cable up to 1 3/4 inches in diameter, light olive gray. Package of 100.							

DISTRIBUTION SERVICES

NETWORK SERVICES

TOOLS

BUILDING JANITORIAL

AUTOMOTIVE

FORMS/OFFICE SUPPLIES

GENERAL

DATA VOICE

PRODUCT IDENTIFIER		DESCRIPTION					
ITEM NUMBER	ORD. MULT.	SELL UNIT	STD. PKG. STOCK AVAILABILITY / PA	LEAD TIME	MIN. ORD.	A C	
260317951 TIE CABLE DELTEC CSS-135							
1941104	1	EA	IL IN MI OH WI 08 08 08 08 08				
Consists of a pre-made up 13 1/2in X 1/2in strapping material.							
260317979 TIE CABLE DELTEC CSS-270							
1941112	1	EA	IL IN MI OH WI 08 08 08 08 08				
Consists of a pre-made up 27in X 1/2in strapping material.							
							
1941112							
280054420 TIE CABLE DELTEC CSS-50R							
1929885	1	RL	IL IN MI OH WI 08 08 08 08 08				
Cable support system consists of 1/2 inch strapping material packaged in a 50ft reel, used for permanently supporting outdoor facilities such as cable terminals and closures.							
260405295 TIE CABLE FLAME RETARDANT 7.4IN HALAR							
1969329	1	EA	IL IN MI OH WI 08 08 08 08 08				
P/NPLT2S-C702. For use with fire retardant cable and wire in air return plenums.							
400272985 TIE CABLE LASHED B16 CA07169							
1332981	1	EA	IL IN MI OH WI 08 08 08 08 08				
A 3/4in metal strap equipped for a wire tie strap for fastening to messenger. Also used in lashed cable construction to support cable and splices from strand, BSP 627-340-101.							
400272993 TIE CABLE LASHED B22 CA07169							
1268607	1	EA	IL IN MI OH WI 08 08 08 08 08				
To support cables from strand and to support main and stub cables at splices.							
400273017 TIE CABLE LASHED B34 CA07169							
1268623	1	EA	IL IN MI OH WI 08 08 08 08 08				
To support cables from strand and to support main and stub cables at splices.							
400273025 TIE CABLE LASHED B45 CA07169							
1268649	1	EA	IL IN MI OH WI 08 08 08 08 08				
To support cables from strand and to support main and stub cables at splices.							
400273041 TIE CABLE LASHED B78 CA07169							
1268680	1	EA	IL IN MI OH WI 08 08 08 08 08				
To support cables from strand and to support main and stub cables at splices.							

PRODUCT IDENTIFIER		DESCRIPTION					
ITEM NUMBER	ORD. MULT.	SELL UNIT	STD. PKG. STOCK AVAILABILITY / PA	LEAD TIME	MIN. ORD.	A C	
300066016 TIE CABLE PLT1M L BLACK							
1133744	1	PK	IL IN MI OH WI 08 08 08 08 08				
Used to permanently identify binder groups on ready access terminals, closures and splice locations, package of 50.							
300066750 TIE CABLE PLT1M L1 0 BROWN/BLACK							
1113613	1	PK	IL IN MI OH WI 08 08 08 08 08				
300066859 TIE CABLE PLT1M L1 4 YELLOW/BROWN							
1152884	1	PK	IL IN MI OH WI 08 08 08 08 08				
300066909 TIE CABLE PLT1M L1 7 VIOLET/BROWN							
1139329	1	PK	IL IN MI OH WI 08 08 08 08 08				
300066958 TIE CABLE PLT1M L1 10 WHITE/BROWN							
1132092	1	PK	IL IN MI OH WI 08 08 08 08 08				
300066065 TIE CABLE PLT1M L2 RED							
1228072	1	PK	IL IN MI OH WI 08 08 08 08 08				
300066115 TIE CABLE PLT1M L3 0 BLACK/ORANGE							
1193748	1	PK	IL IN MI OH WI 08 08 08 08 08				
300066164 TIE CABLE PLT1M L3 2 RED/ORANGE							
1152777	1	PK	IL IN MI OH WI 08 08 08 08 08				
300066214 TIE CABLE PLT1M L3 4 YELLOW/ORANGE							
1144873	1	PK	IL IN MI OH WI 08 08 08 08 08				
300066263 TIE CABLE PLT1M L3 7 VIOLET/ORANGE							
1171041	1	PK	IL IN MI OH WI 08 08 08 08 08				
300066313 TIE CABLE PLT1M L3 10 WHITE/ORANGE							
1179291	1	PK	IL IN MI OH WI 08 08 08 08 08				
300066610 TIE CABLE PLT1M L6 0 BLACK/BLUE							
1218008	1	PK	IL IN MI OH WI 08 08 08 08 08				
300066669 TIE CABLE PLT1M L6 2 RED/BLUE							
1181917	1	PK	IL IN MI OH WI 08 08 08 08 08				
300066719 TIE CABLE PLT1M L6 4 YELLOW/BLUE							
1149809	1	PK	IL IN MI OH WI 08 08 08 08 08				
300066768 TIE CABLE PLT1M L6 7 VIOLET/BLUE							
1152090	1	PK	IL IN MI OH WI 08 08 08 08 08				
300066818 TIE CABLE PLT1M L6 10 WHITE/BLUE							
1165852	1	PK	IL IN MI OH WI 08 08 08 08 08				

TIE CABLE

PRODUCT IDENTIFIER		DESCRIPTION						
ITEM NUMBER	ORD. MULT.	SELL UNIT	STD. PKG. STOCK AVAILABILITY / PA	LEAD TIME	MIN. ORD.	A	C	
300066867 TIE CABLE PLT1M L8 0 BLACK/SLATE								
1217422	1	PK	IL IN MI OH WI 08 08 08 08 08					
300066917 TIE CABLE PLT1M L8 2 RED/SLATE								
1203398	1	PK	IL IN MI OH WI 08 08 08 08 08					
300066966 TIE CABLE PLT1M L8 4 YELLOW/SLATE								
1175166	1	PK	IL IN MI OH WI 08 08 08 08 08					
300037383 TIE CABLE PLT1M L8 7 SLATE/VIOLET								
8407643	1	PK	IL IN MI OH WI 08 08 08 08 08					
300066024 TIE CABLE PLT1M L8 10 WHITE/SLATE								
1193920	1	PK	IL IN MI OH WI 08 08 08 08 08					
300066222 TIE CABLE PRT 12EH MISC 40IN								
1188698	1	PK	IL IN MI OH WI 08 08					
300066800 TIE CABLE STRIPED 4IN BROWN/RED								
1137364	1	PK	IL IN MI OH WI 08 08 08 08 08					
300066362 TIE CABLE STRIPED 4IN GREEN/BLACK								
1181255	1	PK	IL IN MI OH WI 08 08 08 08 08					
300066511 TIE CABLE STRIPED 4IN GREEN/PURPLE								
1220764	1	PK	IL IN MI OH WI 08 08 08 08 08					
300066412 TIE CABLE STRIPED 4IN GREEN/RED								
1212241	1	PK	IL IN MI OH WI 08 08 08 08 08					
300066560 TIE CABLE STRIPED 4IN GREEN/WHITE								
1157792	1	PK	IL IN MI OH WI 08 08 08 08 08					
300066481 TIE CABLE STRIPED 4IN YELLOW/GREEN								
1178032	1	PK	IL IN MI OH WI 08 08 08 08 08					
400898318 TIE CABLE SUPPORT LASHED C								
1140459	1	PK	IL IN MI OH WI 08 08 08 08 08					
27 1/2IN - 31IN - Used with cable spacers to separate support strand from cable or to separate two cables, package of 25.								
400898300 TIE CABLE SUPPORT LASHED C								
1183285	1	PK	IL IN MI OH WI 08 08 08 08 08					
13 1/2IN - 15IN. May be used with cable spacers in place of 16, 22, 28 and 34in sizes, package of 50.								
401561113 TIE CABLE WE TC345A								
5112136	1	PK	IL IN MI OH WI 08 08					
Package of 100.								

PRODUCT IDENTIFIER		DESCRIPTION						
ITEM NUMBER	ORD. MULT.	SELL UNIT	STD. PKG. STOCK AVAILABILITY / PA	LEAD TIME	MIN. ORD.	A	C	
403561962 TIE CABLE WRAP DEMARC 4IN ORANGE								
N		BG	1	3	1			
Bag of 25.								
TIE WRAP								
SEE TIE CABLE								
TOPPER VENT								
402777114 TOPPER VENT CABLE C-2401								
N		EA	100	4	100			
TROUGH								
260355847 TROUGH BOTTOM JUMPER P60257								
1971077	1	EA						
For building entrance frame, BSP 916-559-950AM.								
260355839 TROUGH TOP JUMPER P60256								
1971069	1	EA	IL IN MI OH WI 31					
For building entrance frame, BSP 916-559-950AM.								
TUBE GAS								
SEE UNIT PROTECTOR								
TUBING								
260437967 TUBING 604 HEAT RECOVERABLE 10FT								
N		RL	100	3	100			
400282448 TUBING PLASTIC B 1/2IN X 6IN								
3273284	5	EA	IL IN MI OH WI 18 18 18 18 18					
CA07185 - A white plastic tube with a shank on one end.								
400282455 TUBING PLASTIC B 1/2IN X 8IN								
3273300	1	EA	IL IN MI OH WI 18 18 18 18 18					
CA07185.								
400282406 TUBING PLASTIC B 3/8IN X 6IN								
1283168	1	EA	IL IN MI OH WI 18 18 18 18 18					
CA07185.								
400282414 TUBING PLASTIC B 3/8IN X 8IN								
1196170	1	EA	IL IN MI OH WI 18 18 18 18 18					
CA07185.								
400282422 TUBING PLASTIC B 3/8IN X 12IN								
1283200	1	EA	IL IN MI OH WI 18 18 18 18 18					
CA07185.								

DISTRIBUTION SERVICES
 NETWORK SERVICES
 TOOLS
 BUILDING JANITORIAL
 AUTOMOTIVE
 FORMS/OFFICE SUPPLIES
 GENERAL
 DATA VOICE

DISTRIBUTION SERVICES

PRODUCT IDENTIFIER		DESCRIPTION					
ITEM NUMBER	ORD. MULT.	SELL UNIT	STD. PKG. STOCK AVAILABILITY / PA	LEAD TIME	MIN. ORD.	A C	
400282497		TUBING PLASTIC B 5/8IN X 8IN					
1283309	5	EA	IL 18 IN 18 MI 18 OH 18 WI 18				
CA07185.							
400282505		TUBING PLASTIC B 5/8IN X 12IN					
1224451	1	EA	IL 18 IN 18 MI 18 OH 18 WI 18				
CA07185.							

PRODUCT IDENTIFIER		DESCRIPTION					
ITEM NUMBER	ORD. MULT.	SELL UNIT	STD. PKG. STOCK AVAILABILITY / PA	LEAD TIME	MIN. ORD.	A C	
300077161		UNIT PROTECTOR MODULAR TII 530-4L					
1153791	1	EA	IL 08 IN 08 MI 08 OH 08 WI 08				

NETWORK SERVICES

TWINE							
401008909		TWINE HEAVY 4 PLY 1 LB					
1160531	1	BA					
401732243		TWINE LIGHT VRY 1/6LB					
5658088	1	EA	IL 18 IN 18 MI 18 OH 18 WI 18				
900525072		TWINE NYLON 21 8OZ					
1163071	1	EA	IL 18 IN 18 MI 18 OH 18 WI 18				
900486747		TWINE POLISHED WAX 9PLY 1/2LB					
1410043	1	TU	IL 18 IN 18 MI 18 OH 18 WI 18				
A waxed twine used for securing cables.							

UNIT TERMINAL							
260347919		UNIT TERMINAL PL/SSMSR6000/3AB					
1951095	1	EA					
Unit is remotely powered and provides a 3 tone slope and termination.							

TOOLS

UNIT							
260446901		UNIT FAN CF 660-01					
N							
For the 80A cabinet assembly.							
002075075		UNIT LINE TERMINATION SE 3A					
1192898	1	EA	IL 18 IN MI OH WI				

VALVE							
280060245		VALVE FVA 11K PSI					
N		PK	1	4	10		

BUILDING JANITORIAL

UNIT PROTECTOR							
260441548		UNIT PROTECTOR 2A1D DUMMY					
N		EA	1	5	5000		
300068319		UNIT PROTECTOR 349 1L					
1172916	1	EA	IL 08 IN MI OH WI 08 08				
103003968		UNIT PROTECTOR GAS TUBE 1/2INX20					
1176891	50	EA	IL 08 IN 08 MI 08 OH 08 WI 08				
APP 1 Provides gas tube protection and is a direct replacement for carbon block gaps in any well type terminal protector with threaded protector well, BSP 460-100-400N.							
103003950		UNIT PROTECTOR GAS TUBE 7/16INX20					
1445106	1	EA	IL 08 IN 08 MI 08 OH 08 WI 08				
APP 1 Provides gas tube protection and is a direct replacement for carbon block gaps in any well type terminal protector with threaded protector well, BSP 460-100-400N.							

VALVE CHECK							
260344684		VALVE CHECK D181544					
1950493	1	PK					
260344452		VALVE CHECK D181545 CLAMP					
1950428	1	PK	IL 08 IN MI OH WI 08 08				
Package of 10.							

AUTOMOTIVE

WASHER BEVELED							
260418934		WASHER BEVELED P/N 82100101					
1973826	1	PK					

FORMS/OFFICE SUPPLIES

WASHER CURVED							
400285011		WASHER CURVED B CA06150					
1290023	1	EA					
Used with bolts and pins in pole line construction. 3/4in X 3 1/4in used with 5/8in bolts on 6M strand construction, BSP 627-220-200.							
400285029		WASHER CURVED C CA06150					
1290049	1	EA	IL 14 IN 14 MI 14 OH 14 WI 14				
1 1/4in X 3 1/2in.							

GENERAL

400285037		WASHER CURVED E CA06150					
N		EA	50	4	50		

DATA VOICE

WASHER ROUND							
400285169		WASHER ROUND 1/2IN X 1 3/8IN					
1290122	1000	EA					
For general purpose in plant and construction work. A galvanized mild steel washer, BSP 627-220-200.							
400285144		WASHER ROUND 1/4IN X 3/4IN					
1290080	6400	EA	IL 14 IN 14 MI 14 OH 14 WI 14				

DISTRIBUTION SERVICES

WASHER ROUND

PRODUCT IDENTIFIER		DESCRIPTION					
ITEM NUMBER	ORD. MULT.	SELL UNIT	STD. PKG. STOCK AVAILABILITY / PA	LEAD TIME	MIN. ORD.	A C	
400285185			WASHER ROUND 3/4IN X	2 IN			
1290163	400	EA	IL IN MI OH WI				
			14 14 14 14 14				

400285151			WASHER ROUND 3/8IN X	1 IN		
1290106	3200	EA	IL IN MI OH WI			
			14 14 14 14 14			

NETWORK SERVICES

WASHER SEALING

400825956			WASHER SEALING F 3 PACKAGE OF 4			
2763425	1	PK				

400825964			WASHER SEALING F 4 PACKAGE OF 4			
2763466	1	PK	IL IN MI OH WI			
			08 08 08 08			

400825998			WASHER SEALING F 7 PACKAGE OF 4			
2763508	1	PK	IL IN MI OH WI			
			08 08 08 08			

400826004			WASHER SEALING F 8 PACKAGE OF 4			
2763524	1	PK	IL IN MI OH WI			
			08 08 08 08			

400826012			WASHER SEALING F 9 PACKAGE OF 4			
2763540	1	PK	IL IN MI OH WI			
			08 08 08 08			

400891396			WASHER SEALING G 5 PACKAGE OF 4			
2774703	1	PK	IL IN MI OH WI			
			08 08 08 08			
DISCONTINUE UPON STOCK DEPLETION.						

401513759			WASHER SEALING HX PACKAGE OF 2	M/D		
2694067	1	PK	IL IN MI OH WI			
			08 08 08 08			
DISCONTINUE UPON STOCK DEPLETION.						

401513767			WASHER SEALING JX PACKAGE OF 2	M/D		
2694083	1	PK	IL IN MI OH WI			
			08 08 08 08			
DISCONTINUE UPON STOCK DEPLETION.						

401513775			WASHER SEALING KX PACKAGE OF 2	M/D		
2694109	1	PK	IL IN MI OH WI			
			08 08 08 08			
DISCONTINUE UPON STOCK DEPLETION.						

300074341			WASHER SEALING UNIVERSAL FS			
5121590	1	PK	IL IN MI OH WI			
			08 08 08 08			
A slotted washer used for sealing cables having diameters of .4in to 1.0in in splice case entrances. The washer cutter WCT11K is required for cutting washer. Package of 2.						

300074309			WASHER SEALING UNIVERSAL GS			
5121582	1	PK	IL IN MI OH WI			
			08 08 08 08			
.4in to 1.6in diameter. Package of 2.						

300074325			WASHER SEALING UNIVERSAL HS			
5121616	1	PK	IL IN MI OH WI			
			08 08 08 08			
.4in to 2.2in diameter. Package of 2.						

TOOLS

BUILDING JANITORIAL

AUTOMOTIVE

FORMS/OFFICE SUPPLIES

GENERAL

DATA VOICE

PRODUCT IDENTIFIER		DESCRIPTION					
ITEM NUMBER	ORD. MULT.	SELL UNIT	STD. PKG. STOCK AVAILABILITY / PA	LEAD TIME	MIN. ORD.	A C	

300074317			WASHER SEALING UNIVERSAL JS			
5121574	1	PK	IL IN MI OH WI			
			08 08 08 08			
.4in to 2.8in diameter. Package of 2.						

300074333			WASHER SEALING UNIVERSAL KS			
1128868	1	PK	IL IN MI OH WI			
			08 08 08 08			
.4in to 3.4in diameter. Package of 2.						

280094111			WASHER SEALING UNIVERSAL LS			
1937391	1	EA	IL IN MI OH WI			
			08 08 08 08			
.4in to 4.0in diameter. Package of 2.						

280099961			WASHER SEALING UNIVERSAL MS			
1975250	1	EA	IL IN MI OH WI			
			08 08 08 08			
Package of 2.						

WASHER SQUARE

400285698			WASHER SQUARE 3/4IN X 2 1/4IN			
1291161	200	EA				
Used generally with thimble guy rods and plank or log anchors. Galvanized mild steel square washer, CA06150 - BSP 621-415-211.						

400314894			WASHER SQUARE 3/4IN X 3IN			
1291187	100	EA	IL IN MI OH WI			
			14 14 14 14			
CA06150, Used for down guys.						

400285680			WASHER SQUARE 5/8IN X 2 1/4IN			
1291146	1	EA	IL IN MI OH WI			
			08 08 08 08			
Used with crossarm and cable suspension clamp bolts, CA06150. DISCONTINUE AND FORWARD TO WASHER SQ 3/4 X 2 1/4 UPON STOCK DEPLETION.						

400285706			WASHER SQUARE 7/8IN X 3 1/2IN			
N		EA	40	8	40	
CA06150.						

400285714			WASHER SQUARE 1 1/8IN X 4IN			
N		EA	25	8	25	
CA06150.						

400285722			WASHER SQUARE 1 1/8IN X 6IN			
5274746	1	EA	IL IN MI OH WI			
			14 14			
CA06150. DISCONTINUE, ORDER NON STOCK UPON STOCK DEPLETION.						

400285730			WASHER SQUARE 1 3/8IN X 6IN			
N		EA	15	8	15	
CA06150.						

WEDGE

260413265			WEDGE CHW-C20			
N		BE	1	2	1	
100 per bag.						

DISTRIBUTION SERVICES

NETWORK SERVICES

TOOLS

BUILDING JANITORIAL

AUTOMOTIVE

FORMS/OFFICE SUPPLIES

GENERAL

DATA VOICE

PRODUCT IDENTIFIER		DESCRIPTION					
ITEM NUMBER	ORD. MULT.	SELL UNIT	STD. PKG. STOCK AVAILABILITY / PA	LEAD TIME	MIN. ORD.	A	C
WEDGE LEAD							
996179115 WEDGE LEAD 0 CA06783							
1291385	1	EA					
Used for obtaining separation between cables entering a splice. All but #10 are used in Y joints. #10 is used in 3 way joints, BSP 633-210-200.							
996179172 WEDGE LEAD 1 CA06783							
1291401	1	EA	IL 08 IN 08 MI 08 OH 08 WI 08				
996179180 WEDGE LEAD 2 CA06783							
1105114	1	EA	IL 08 IN 08 MI 08 OH 08 WI 08				
996179206 WEDGE LEAD 4 CA06783							
1209981	1	EA	IL 08 IN 08 MI 08 OH 08 WI 08				
4 inch wedge.							
996179149 WEDGE LEAD 10 CA06783							
1291583	1	EA	IL 08 IN 08 MI 08 OH 08 WI 08				
WIPER							
280022740 WIPER SCRIM TERI 34790							
1953976	1	CS					
WIPES							
280008814 WIPES SOLVENT CLEANING ISW-10							
1921429	1	CT					
For cleaning cable end plate and cover for 2 type closure preparation and use.							
WIRE							
260447354 WIRE 126 4C 2PR 24 GAUGE							
N							
900369661 WIRE 30GA MES42163 G1 3IN SOL							
N		FT	1000	13	1000		
260449616 WIRE 4PR 24 GAUGE NONSHLD PVC LEVEL4 UTP							
N							
400287322 WIRE APPLIANCE B 50FT SPOOL							
N		SP	1				
CA08315.							
280015702 WIRE BAIL 3/8IN C-172							
N		PK	25	2	25		
25 Per Package.							
280015710 WIRE BAIL C-171 10IN							
N		PK	25	2	25		

PRODUCT IDENTIFIER		DESCRIPTION					
ITEM NUMBER	ORD. MULT.	SELL UNIT	STD. PKG. STOCK AVAILABILITY / PA	LEAD TIME	MIN. ORD.	A	C
103848206 WIRE BF 22GA PAIR P388079							
6328849	1600	FT	IL 08 IN 08 MI 08 OH 08 WI 08				
For general use where a shielded wire is required in carrier telephone installation.							
843745407 WIRE BH2 22GA QUAD Y/YG/R/RG							
N		FT	1	1	1		
NOW AVAILABLE THROUGH TOUCH-TONE ORDER ENTRY.							
400292124 WIRE BLOCK E PAIR CA08100							
1170076	24001	FT	IL 08 IN 08 MI 08 OH 08 WI 08				
Black plastic wire used outside for station connections, BSP 461-200-100.							
401689153 WIRE BLOCK E QUAD CA08100							
1179333	250	FT	IL 08 IN 08 MI 08 OH 08 WI 08				
4 conductor, color coded wire, used outside for station connections, BSP 462-030-100.							
104304167 WIRE CABLE ELECTRIC SHIELD							
N		FT	4600	2	4000		
400287363 WIRE CONSTRUCTION STEEL 134							
1292649	1	LB	IL 08 IN MI OH WI 08				
55 pound coil.							
280043795 WIRE COPPER BARE #6 200FT							
1925081	200	FT	IL 18 IN 18 MI 18 OH 18 WI 18				
280071440 WIRE COPPER BARE #6 2000FT							
1935130	2000	FT	IL IN MI OH WI 08 08				
400025383 WIRE DI 6PR 16700FT DISP RL/CMR							
N		FT	16700	1	16700		
1987 UL list material required.							
400025391 WIRE DI 12PR 10800FT DISP/CMR							
N		FT	10800	1	10800		
1987 UL list material required.							
400025409 WIRE DI 16PR 10800FT DISP/CMR							
N		FT	10800	1	10800		
1987 UL list material required.							
400025425 WIRE DI 25PR 6780FT DISP/CMR							
N		FT	6780	1	6780		
1987 UL list material required.							
400025433 WIRE DI 50PR 4155FT DISP/CMR							
N		FT	4000	1	4000		
1987 UL list material required.							
400025458 WIRE DI 100PR 2087FT DISP REEL							
N		FT	2000	1	2000		
300097094 WIRE JUMPER 250FT SPOOL PIC							
N		EA	1	2	1		
.5MM AWG orange/white 4069.							

DISTRIBUTION SERVICES
 NETWORK SERVICES
 TOOLS
 BUILDING JANITORIAL
 AUTOMOTIVE
 FORMS/OFFICE SUPPLIES
 GENERAL
 DATA VOICE

WIRE

PRODUCT IDENTIFIER		DESCRIPTION					
ITEM NUMBER	ORD. MULT.	SELL UNIT	STD. PKG. STOCK AVAILABILITY / PA	LEAD TIME	MIN. ORD.	A C	
300073749		WIRE JUMPER	800FT 4268				
N		EA	1	3	1		
300097086		WIRE JUMPER	800FT SPOOL PIC				
N		EA	1	2	1		
.5MM 24AWG orange/white 4068.							
260370325		WIRE JUMPER	Y2-5C/24 GAUGE 1000FT SPOOL				
1955997	1	FT	IL 09	IN 09	MI 09	OH WI 09 09	
260447156		WIRE KS 13385	L1 12 GAUGE BLACK				
N							
260447164		WIRE KS 13385	L1 14 GAUGE BLACK				
N							
260447172		WIRE KS 13385	L1 14 GAUGE RED				
N							
400287777		WIRE LINE STEEL	H CLA 19				
1143875	155	LB	IL IN MI OH WI 08 08				
A steel line wire covered with a light zinc coating, BSP 623-030-105.							
105071013		WIRE MUSIC	4/PKG				
N		EA	1	2	1		
300032026		WIRE PIPE	12-119				
1217869	1	CT	IL IN MI OH WI 08 08 08 08				
Carton of 30. Used in the protection of telephone drop wire and ground wire installations against wind, snagging and vandalism.							
260438049		WIRE POWER	10AWG BLACK 6G-1001-02				
N		EA	1	2	1		
15FT cuts.							
260438031		WIRE POWER	10AWG RED 6G-1001-03				
N		EA	1	2	1		
15FT cuts.							
260438064		WIRE POWER	18AWG BLACK 6G-1801-02				
N		EA	1	2	1		
50FT cuts.							
260438056		WIRE POWER	18AWG RED 6G-1801-03				
N		EA	1	2	1		
40FT cuts.							
260443338		WIRE POWER	2/0 KS23814 L9				
N		FT	1	4	1		
260443379		WIRE POWER	350 MCM KS23814 L11				
N		FT	1	4	1		
260443361		WIRE POWER	4/0 KS23814 L10				
N		FT	1	4	1		
260443387		WIRE POWER	500 MCM KS23814 L12				
N		FT	1	4	1		

PRODUCT IDENTIFIER		DESCRIPTION					
ITEM NUMBER	ORD. MULT.	SELL UNIT	STD. PKG. STOCK AVAILABILITY / PA	LEAD TIME	MIN. ORD.	A C	
260443395		WIRE POWER	750 MCM KS23814 L13				
N		FT	1	4	1		
260443312		WIRE POWER	KS23814 L8				
N		FT	1	4	1		
260447370		WIRE TIW	25PR 24 GAUGE				
N							
260447396		WIRE TIW	4PR 24 GAUGE				
N							
260447362		WIRE TIW	50PR 24 GAUGE				
N							
260447388		WIRE TIW	6PR 24 GAUGE				
N							
102540929		WIRE Y-1	THREE PAIR				
1334003	660	FT	IL IN MI OH WI 08 08 08 08 08				
A three pair wire used in cross connecting terminals. For central office use.							
WIRE AERIAL SERVICE							
103893640		WIRE ASW	1 PAIR 18 1/2 GAUGE F DROP				
1332924	1	FT					
Aerial Service Wire, 1000ft dispensing carton. Used to extend circuits from terminals to subscriber stations.							
103893657		WIRE ASW	1 PAIR 18 1/2 GAUGE F DROP				
1333245	1100	FT	IL IN MI OH WI 08 08 08 08 08				
Aerial Service Wire, 1100ft coil.							
260323183		WIRE ASW	2 PAIR 22 GAUGE 600FT COIL				
1943274	1	FT	IL IN MI OH WI 08 08 08 08 08				
A 2 pair Aerial Service Wire supported by .083 Wire Messenger.							
103867636		WIRE ASW	2 PAIR 22 GAUGE F DROP				
N		FT	5000	1	5000		
5000ft reel. NOW AVAILABLE THROUGH TOUCH-TONE ORDER ENTRY.							
260302443		WIRE ASW	6 PAIR 22 GAUGE 500FT REEL				
1939371	1	FT	IL IN MI OH WI 08 08 08 08 08				
103867651		WIRE ASW	6 PAIR 22 GAUGE F DROP				
1302018	3500	FT	IL IN MI OH WI 08 08 08 08 08				
Aerial Service Wire, 3500ft reel.							
260321500		WIRE ASW	6 PAIR 22 GAUGE F DROP				
1942607	1	FT	IL IN MI OH WI 08 08 08 08 08				
300ft coil.							

DISTRIBUTION SERVICES

NETWORK SERVICES

TOOLS

BUILDING JANITORIAL

AUTOMOTIVE

FORMS/OFFICE SUPPLIES

GENERAL

DATA VOICE

PRODUCT IDENTIFIER		DESCRIPTION				
ITEM NUMBER	ORD. MULT.	SELL UNIT	STD. PKG. STOCK AVAILABILITY / PA	LEAD TIME	MIN. ORD.	A C

WIRE BURIED DISTRIBUTION

103867669 WIRE BDW 1 PAIR 19 GAUGE GRE 1200FT
 1302000 12000 FT
 Buried Distribution Wire, 12000ft reel.

103867677 WIRE BDW 1 PAIR 19 GAUGE GRE 1200FT
 1225177 1200 FT IL IN MI OH WI
 08 08 08 08
 Buried Distribution Wire, 1200ft reel.

103867693 WIRE BDW 2 PAIR 19 GAUGE GRF 700FT
 8408401 700 FT IL IN MI OH WI
 08 08
 Buried Distribution Wire intended for direct burial without added mechanical protection. Poly insulated with bronze tape armor and a PVC jacket, BSP 629-030-115.

105291983 WIRE BDW 2 PAIR 19 GAUGE GRF 1600FT
 8411058 1600 FT IL IN MI OH WI
 08 08 08 08
 Buried Distribution Wire, 1600ft reel.

103867685 WIRE BDW 2 PAIR 19 GAUGE GRF 7000FT
 N FT 7000 1 7000

105308522 WIRE BDW 3 PAIR 22 GAUGE 5000FT
 N FT 5000 1 5000

104215397 WIRE BDW 3 PAIR 22 GAUGE C 900FT
 N FT 900 1 900

260329941 WIRE BDW 3 PAIR 22 GAUGE -C 5000FT
 1946756 5000 FT IL IN MI OH WI
 08 08 08 08
 Buried Distribution Wire, 5000ft reel.

105308571 WIRE BDW 3 PAIR 22 GAUGE FFC 900FT
 N FT 900 1 900

WIRE BU

814615621 WIRE BU 24 GAUGE SINGLE P46A562
 1292342 1 FT
 Hook-up wire green unshielded.

814615639 WIRE BU 24 GAUGE SINGLE P46A563
 N FT 446 1 446
 Hook-up wire brown unshielded.

814615654 WIRE BU 24 GAUGE SINGLE P46A565
 1292383 1 FT IL IN MI OH WI
 18 18 18 18
 Hook-up wire white unshielded.

814615662 WIRE BU 24 GAUGE SINGLE P46A566
 1292409 1 FT IL IN MI OH WI
 18 18 18 18
 Hook-up wire red unshielded.

PRODUCT IDENTIFIER		DESCRIPTION				
ITEM NUMBER	ORD. MULT.	SELL UNIT	STD. PKG. STOCK AVAILABILITY / PA	LEAD TIME	MIN. ORD.	A C

814615670 WIRE BU 24 GAUGE SINGLE P46A567
 1292425 1 FT IL IN MI OH WI
 18 18 18 18
 Hook-up wire black unshielded.

814658803 WIRE BU 24 GAUGE SINGLE P46E880
 N FT 1890 2 1890
 Hook-up wire black/white unshielded.

WIRE BURIED SERVICE

103867701 WIRE BSW 2 PAIR 22GA 800FT COIL
 1459867 800 FT
 A two pair and five pair filled wire for buried connections to subscribers premises, BSP 629-030-115.

103867735 WIRE BSW 2 PAIR 22GA 1200FT REEL
 1459883 1200 FT IL IN MI OH WI
 08 08 08 08

260380308 WIRE BSW 2 PAIR 22GA C 18FT
 1980567 1 FT IL IN MI OH WI

103867719 WIRE BSW 2 PAIR 22GA C 8000FT REEL
 1303735 8000 FT IL IN MI OH WI
 08 08 08 08
 The 2 and 5 pair Buried Service Wire is intended for use in providing buried service connections and is approved for building entrances.

260421797 WIRE BSW 3 PAIR 22GA 800FT COIL
 1975557 800 FT IL IN MI OH WI
 08 08 08 08

260421805 WIRE BSW 3 PAIR 22GA 1000FT REEL
 1975540 1 FT IL IN MI OH WI
 08 08 08 08

260421813 WIRE BSW 3 PAIR 22GA 7000FT REEL
 1975532 1 FT IL IN MI OH WI
 08 08 08 08

103919387 WIRE BSW 5 PAIR 22GA 600FT COIL
 1947515 1 FT IL IN MI OH WI
 50

260421821 WIRE BSW 5 PAIR 22GA 600FT COIL
 1975524 1 FT IL IN MI OH WI
 50 50

103867750 WIRE BSW 5 PAIR 22GA 800FT REEL
 1147769 800 FT IL IN MI OH WI
 08 08 08 08

260421839 WIRE BSW 5 PAIR 22GA 900FT REEL
 1975516 1 FT IL IN MI OH WI
 08 08 08 08

103867743 WIRE BSW 5 PAIR 22GA 5000FT REEL
 1301994 5000 FT IL IN MI OH WI
 08 08 08 08

DISTRIBUTION SERVICES

NETWORK SERVICES

TOOLS

BUILDING JANITORIAL

AUTOMOTIVE

FORMS/OFFICE SUPPLIES

GENERAL

DATA VOICE

WIRE BURIED SERVICE

PRODUCT IDENTIFIER		DESCRIPTION						
ITEM NUMBER	ORD. MULT.	SELL UNIT	STD. PKG. STOCK AVAILABILITY / PA	LEAD TIME	MIN. ORD.	A C		
260421847 WIRE BSW 5 PAIR 22GA 5000FT REEL								
1975508	1	FT	IL 08 IN 08 MI 08 OH 08 WI 08					
260380290 WIRE BSW 5 PAIR 22GA C 18FT								
1960559	1	FT	IL IN MI OH WI					
WIRE CROSS CONNECT								
841506579 WIRE CROSS CONNECT F 2PR 841506579								
1212001	1150	FT				1987 UL listed material required. Designed for inside buildings only. BSP 461-200-100.		
841506587 WIRE CROSS CONNECT F 3PR 841506587								
1292722	660	FT	IL 18 IN 18 MI 18 OH 18 WI 18			Designed for inside buildings only. Phalo part 229-006-70102-01 4in X 6 1/2in 660ft.		
842691222 WIRE CROSS CONNECT F 600FT								
1968073	600	FT	IL 18 IN 18 MI 18 OH 18 WI 18			A 1 pair wire used in cross connecting terminals. Designed for use inside buildings only, BSP 461-200-100.		
841506561 WIRE CROSS CONNECT F TRIPLE								
N		FT	600			1987 listed material required.		
402176093 WIRE CROSS CONNECT G PAIR 400FT								
1452789	400	FT	IL 08 IN 08 MI 08 OH 08 WI 08			A 1 pair wire used in cross connecting terminals. Designed for outside applications, BSP 461-200-100.		
WIRE FRAME DISTRIBUTION								
102448982 WIRE FRAME DISTRBTION 2PR 22GA W/BL/R/G								
N		FT	6000	1	6000	NOW AVAILABLE THROUGH TOUCH-TONE ORDER ENTRY.		
260371547 WIRE FRAME DISTRIBUTION 20 GAUGE SINGLE								
1957647	1	FT	IL 09 IN 09 MI 09 OH 09 WI 09			Brown.		
260371513 WIRE FRAME DISTRIBUTION 22 GAUGE								
1957613	1	FT	IL 09 IN 09 MI 09 OH 09 WI 09			Yellow/Red. See #104234190 for cost.		
260371463 WIRE FRAME DISTRIBUTION 22 GAUGE								
1957563	1	FT	IL 09 IN 09 MI 09 OH 09 WI 09			White/Orange.		
260371554 WIRE FRAME DISTRIBUTION 22 GAUGE								
1957654	1	FT	IL 09 IN 09 MI 09 OH 09 WI 09			Black/Violet.		

PRODUCT IDENTIFIER		DESCRIPTION						
ITEM NUMBER	ORD. MULT.	SELL UNIT	STD. PKG. STOCK AVAILABILITY / PA	LEAD TIME	MIN. ORD.	A C		
260371471 WIRE FRAME DISTRIBUTION 22 GAUGE								
1957571	1	FT	IL 09 IN 09 MI 09 OH 09 WI 09			White/Red.		
260371497 WIRE FRAME DISTRIBUTION 22GA								
1957597	1	FT	IL 09 IN 09 MI 09 OH 09 WI 09			White/Blue/Red.		
260371489 WIRE FRAME DISTRIBUTION 22GA								
1957589	1	FT	IL 09 IN 09 MI 09 OH 09 WI 09			White/Blue/Red/Green.		
102337870 WIRE FRAME DISTRIBUTION 22GA PAIR								
N		FT	12000	1	12000	White/Blue. NOW AVAILABLE THROUGH TOUCH-TONE ORDER ENTRY.		
260371430 WIRE FRAME DISTRIBUTION 22GA WHITE/BLUE								
1957530	1	FT	IL 09 IN 09 MI 09 OH 09 WI 09			See RG58162, PID 104234117 for cost.		
260371539 WIRE FRAME DISTRIBUTION 22GA WHITE/BLUE								
1957639	1	FT	IL 09 IN 09 MI 09 OH 09 WI 09			500FT. See RG58162, PID 106208333.		
260371455 WIRE FRAME DISTRIBUTION 22GA WHITE/GREEN								
1957555	1	FT	IL 09 IN 09 MI 09 OH 09 WI 09			See RG58162, PID 104234349 for cost.		
260371521 WIRE FRAME DISTRIBUTION 24 GAUGE								
1957621	1	FT	IL 09 IN 09 MI 09 OH 09 WI 09			Yellow/Orange.		
260371505 WIRE FRAME DISTRIBUTION 24 GAUGE								
1957605	1	FT	IL 09 IN 09 MI 09 OH 09 WI 09			Yellow/Green.		
103252573 WIRE FRAME DISTRIBUTION 24GA PAIR								
N		FT	5000	1	5000	Yellow/Orange.		
260371448 WIRE FRAME DISTRIBUTION 24GA YELLOW/BLUE								
1957548	1	FT	IL 09 IN 09 MI 09 OH 09 WI 09			See RG58162, PID 104234166 for cost.		
102421922 WIRE FRAME DISTRIBUTION 2PR 22GA W/GRN								
N		FT	12000	1	12000	NOW AVAILABLE THROUGH TOUCH-TONE ORDER ENTRY.		

DISTRIBUTION SERVICES

NETWORK SERVICES

TOOLS

BUILDING JANITORIAL

AUTOMOTIVE

FORMS/OFFICE SUPPLIES

GENERAL

DATA VOICE

PRODUCT IDENTIFIER		DESCRIPTION					
ITEM NUMBER	ORD. MULT.	SELL UNIT	STD. PKG. STOCK AVAILABILITY / PA	LEAD TIME	MIN. ORD.	A C	
102421930 WIRE FRAME DISTRIBUTION 2PR 22GA W/ORNGE							
N		FT	12000	1	12000		
NOW AVAILABLE THROUGH TOUCH-TONE ORDER ENTRY.							
102421948 WIRE FRAME DISTRIBUTION 2PR 22GA W/RED							
N		FT	12000	1	12000		
NOW AVAILABLE THROUGH TOUCH-TONE ORDER ENTRY.							
102379195 WIRE FRAME DISTRIBUTION 2PR 24GA Y/BLU							
N		FT	15000	1	15000		
NOW AVAILABLE THROUGH TOUCH-TONE ORDER ENTRY.							
WIRE GROUND							
001109008 WIRE GROUND 6 50FT SOLID							
1293027	50	FT					
401352422 WIRE GROUND 6 50FT STRAND							
1293001	50	FT	IL IN MI OH WI 08 08 08 08 08				
10 Pieces of 50ft per carton.							
001075829 WIRE GROUND 6 200FT COIL							
1176875	1	FT	IL IN MI OH WI 08 08 08 08 08				
Plastic covered for grounding protected terminals, protector mountings, groups of station protectors and bonding of separate grounding electrodes, BSP 461-100-201, BSP 638-210-100.							
401172341 WIRE GROUND 6 600FT							
N		FT	600	3	6000		
401172424 WIRE GROUND 6 600FT COIL							
4235846	600	FT	IL IN MI OH WI 08 08 08 08 08				
Bare copper ground wire primarily used on joint pole construction.							
400292199 WIRE GROUND 6 4000FT REEL							
1102954	4000	FT	IL IN MI OH WI 08 08 08 08 08				
260413794 WIRE GROUND 6 RHH-RHW-USE							
N		FT	1000	2	1		
260339221 WIRE GROUND 6 W/EYELET							
1948687	1	EA	IL IN MI OH WI 08 08 08 08 08				
400292207 WIRE GROUND 10 200FT COIL							
1293084	200	FT	IL IN MI OH WI 08 08 08 08 08				
A single conductor wire used for grounding purposes, BSP 460-100-201.							
002028025 WIRE GROUND 10 STRANDED							
N		FT	1	3	2500		
Green jacketed, intended for use as a coupled bonding conductor on Key and PBX systems. Not for use as station or protector ground wire. DISCONTINUE UPON STOCK DEPLETION							

PRODUCT IDENTIFIER		DESCRIPTION					
ITEM NUMBER	ORD. MULT.	SELL UNIT	STD. PKG. STOCK AVAILABILITY / PA	LEAD TIME	MIN. ORD.	A C	
400292215 WIRE GROUND 12 300FT COIL							
1293100	300	FT	IL IN MI OH WI 08 08 08 08 08				
A single conductor wire used for grounding purposes, BSP 460-100-201.							
WIRE LASHING							
400292249 WIRE LASHING COPPER 1LB SPOOL							
1293183	1	LB					
For supporting aerial cable splices & for other permanent ties used in aerial & block cable construction. CA06157.							
400287579 WIRE LASHING LD 1 1/2LB CA06634							
1293209	1	SP	IL IN MI OH WI 08 08 08 08 08				
Lead, used as an alternate material for lashing cables in manholes. BSP 633-020-201.							
400287603 WIRE LASHING STEEL C065 450FT COIL							
1293266	1	CL	IL IN MI OH WI 08 08 08 08 08				
Used for lashing aerial cable to suspension strand where corrosion conditions are severe. BSP 627-310-100.							
400287611 WIRE LASHING STEEL C065 650FT COIL							
N		CL	6	4	120		
Used for lashing aerial cable to suspension strand, BSP 627-310-100.							
280071630 WIRE LASHING STEEL .038							
1935403	1	CL	IL IN MI OH WI 08 08 08 08 08				
Super Lash 302 for use in lashing Aerial Cable to suspension strand and is used where corrosion conditions are severe.							
WIRE RURAL C							
400287967 WIRE RURAL C 5500FT REEL							
1293381	6000	FT					
400287975 WIRE RURAL C 19000FT REEL							
1154310	19000	FT	IL IN MI OH WI 08 08 08 08 08				
401809934 WIRE RURAL C 1000FT COIL							
4218883	1000	FT	IL IN MI OH WI 08 08 08 08 08				
An insulated self supporting wire used in rural areas to extend cable leads. Not to be used as a drop wire, BSP 624-020-100.							
WIRE STATION							
401836598 WIRE STATION D QUAD CM RATED 22GA							
2665463	3600	FT					
For general use in station wiring, BSP 461-200-180.							

DISTRIBUTION SERVICES

WIRE STATION

PRODUCT IDENTIFIER		DESCRIPTION						
ITEM NUMBER	ORD. MULT.	SELL UNIT	STD. PKG. STOCK AVAILABILITY / PA	LEAD TIME	MIN. ORD.	A	C	
103729182 WIRE STATION H 3 PAIR 1500FT								
1134601	1	CL	IL IN MI OH WI 18 18 18 18 18					
Intended for pre-wiring homes and apartments.								

NETWORK SERVICES

WIRELINK							
401709472 WIRELINK 5057 .083							
N		EA	100	5	100		
NOW AVAILABLE THROUGH TOUCH-TONE ORDER ENTRY.							

TOOLS

401684824 WIRELINK 5057N .083 CA0766X							
2622720	1	EA	IL IN MI OH WI 08 08 08 08 08				
Used for splicing F multiple drop wire, BSP 624-230-200.							

400288437 WIRELINK 5059 .109							
1293324	100	EA	IL IN MI OH WI 16 16 16 16 16				
Used for joining all grades of 109 steel line wire, BSP 623-030-205.							

BUILDING JANITORIAL

400288452 WIRELINK 5059N .109							
N		EA	100	5	400		

400288445 WIRELINK 5063 .120							
1293340	100	EA	IL IN MI OH WI 16 16 16 16 16				
For use in joining the support wire of D urban and E rural wires only, BSP 623-030-205.							

AUTOMOTIVE

400288460 WIRELINK 5063N .120							
N		EA	100	5	400		

WIREWISE

400288494 WIREWISE 5056 .083							
1293621	1	EA					
Used to fasten (F) multiple drop wire to structures and poles.							

401897038 WIREWISE 5058 .109							
1293589	1	EA	IL IN MI OH WI 16 16 16 16 16				
Used for deadending all grades of 109 steel line wire, BSP 623-230-201.							

400288486 WIREWISE 5062 .120							
1293605	1	EA	IL IN MI OH WI 08 08 08 08 08				
For use in deadending the support wires of D urban and E rural wires only, BSP 623-230-201.							

WOOL STEEL

996295671 WOOL STEEL 2 - 1LB ROLL							
1134270	1	LB					
Case of 12 rolls.							

DATA VOICE

PRODUCT IDENTIFIER		DESCRIPTION						
ITEM NUMBER	ORD. MULT.	SELL UNIT	STD. PKG. STOCK AVAILABILITY / PA	LEAD TIME	MIN. ORD.	A	C	

WRAP

300072519 WRAP CABLE MESH C-1241 4IN X 96FT							
5122986	1	EA					

280079104 WRAP CLEAR TBT04							
N		RO	8	4	64		

280028101 WRAP EZ SPLICE 1.5 MIL 2176							
N		RO	16	3	16		
A clear stretchable plastic wrap for wrapping the cable core or a splice to prevent the leaking of encapsulant, 4in X 160ft. FORWARD TO WRAP SPLICE. NOW AVAILABLE THROUGH TOUCH-TONE ORDER ENTRY.							

300083805 WRAP EZ SPLICE 3.0 MIL 2183							
N		RO	12	3	12		

403139470 WRAP PAIR SAVER 4458							
4239327	1	RO	IL IN MI OH WI 08 08 08 08 08				
Protect cable pairs from the sharp edges of the shield and terneplate.							

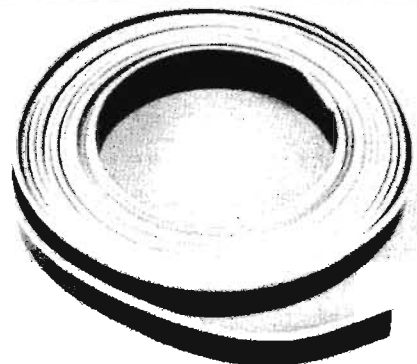

4239327

260327994 WRAP PAIR SAVER 4458W							
1951061	1	RO	IL IN MI OH WI 08 08 08 08 08				
Protects cable pairs from sheath edges and wider for tab cutting.							

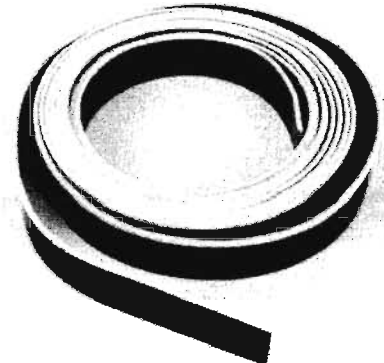

1951061

PRODUCT IDENTIFIER		DESCRIPTION				
ITEM NUMBER	ORD. MULT.	SELL UNIT	STD. PKG. STOCK AVAILABILITY / PA	LEAD TIME	MIN. ORD.	A C
WRAP SPLICE						
300034089 WRAP SPLICE 3.0 MIL 4IN X 100FT						
1333310	1	CS				
A 3 mil Vinyl Splice Wrap.						
402393300 WRAP SPLICE B 2IN CA08907						
N		RO	10	2	10	
For use in building and vault splices to provide a fire retardant wrap in heat shrinking and wiping operations, BSP 632-490-220, BSP 633-506-205. NOW AVAILABLE THROUGH TOUCH-TONE ORDER ENTRY.						
402393318 WRAP SPLICE B 4IN CA08907						
1100776	1	RO	IL IN MI OH WI 08 08 08 08			
For use in building and vault splices to provide a fire retardant wrap in heat shrinking and wiping operations, BSP 632-490-220.						
260324967 WRAP SPLICE ENVELOPE 18IN X 20IN						
1944975	1	RO	IL IN MI OH WI 08 08 08 08			
260324959 WRAP SPLICE ENVELOPE 36IN X 20IN						
1944983	1	RO	IL IN MI OH WI 08 08 08 08			
260339619 WRAP SPLICE ENVELOPE TBTENV 12						
N		RO	1	4	10	
260357801 WRAP SPLICE EZ 1.5 MIL						
N		CS	1		1	
16 rolls per case.						
260357819 WRAP SPLICE EZ 3.0 MIL						
N		CS	1		1	
10 rolls per case.						
WRAP THERMAL						
ADC USAGE ONLY.						
260360623 WRAP THERMAL 15IN						
1953927	1	RO				
260360607 WRAP THERMAL 25 3/8IN						
1953919	1	RO	IL IN MI OH WI			
260360615 WRAP THERMAL 39 3/4IN						
1953901	1	RO	IL IN MI OH WI			

PRODUCT IDENTIFIER		DESCRIPTION				
ITEM NUMBER	ORD. MULT.	SELL UNIT	STD. PKG. STOCK AVAILABILITY / PA	LEAD TIME	MIN. ORD.	A C

DISTRIBUTION SERVICES

NETWORK SERVICES

TOOLS

BUILDING JANITORIAL

AUTOMOTIVE

FORMS/OFFICE SUPPLIES

GENERAL

DATA VOICE

NOTES

SECTION 2 - NETWORK SERVICES **MATERIAL INCLUDED**

- C.O. POWER APPARATUS & SUPPORT
- C.O. SWITCHING APPARATUS & SUPPORT
- C.O. TRANSMISSION APPARATUS & SUPPORT
- BAY AND ASSOCIATED HARDWARE

We are concerned and value your ideas. Please contact the Ameritech Bell Group Catalog Department direct on (708) 248-8313 with questions, corrections and ideas.

Catalog Format

PRODUCT IDENTIFIER		DESCRIPTION				
ITEM NUMBER	ORD. MULT.	SELL UNIT	STD. PKG.	LEAD TIME	MIN. ORD.	A C

Stock Material

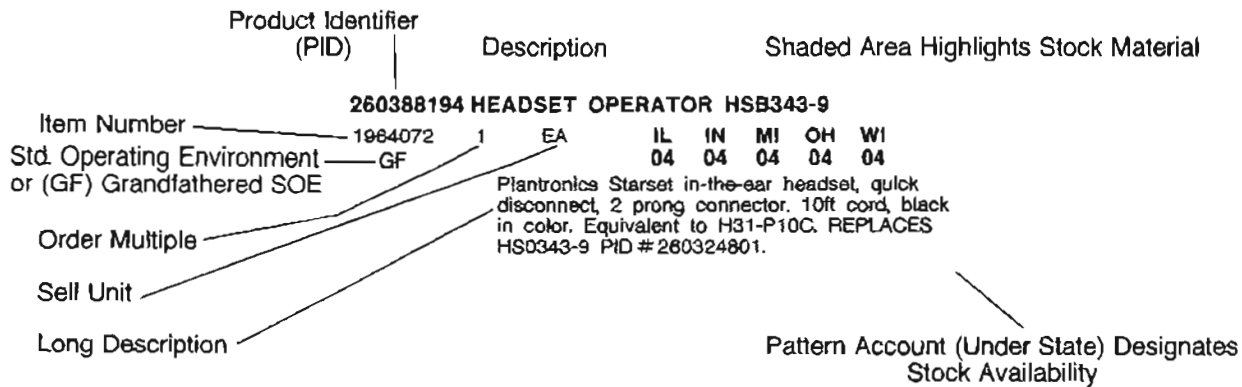

Non-Stock Material

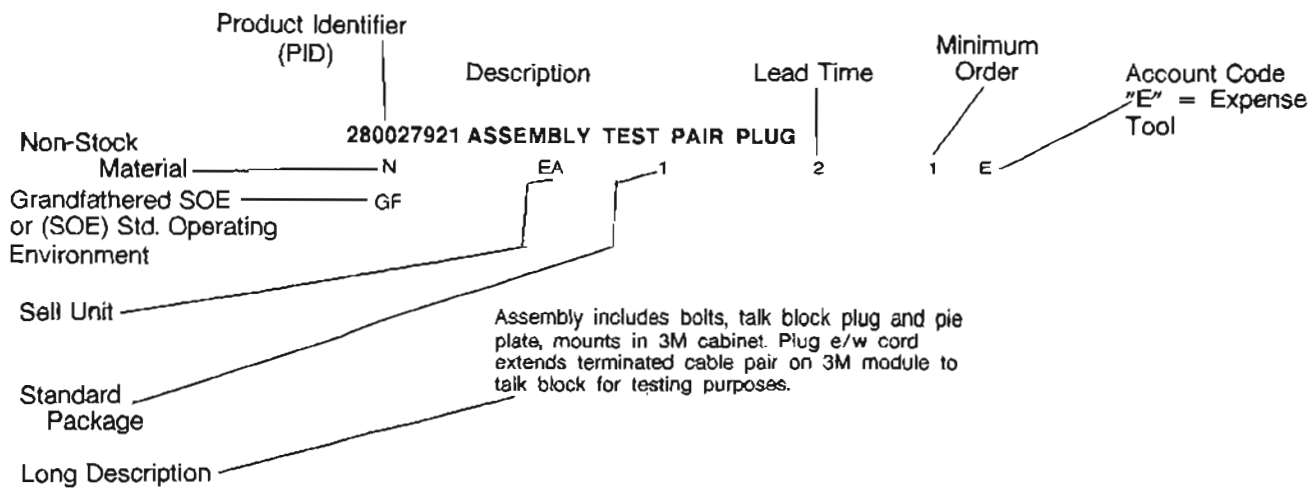

ADAPTER BRIDGING

PRODUCT IDENTIFIER							DESCRIPTION						
ITEM NUMBER	ORD. MULT.	SELL UNIT	STD. PKG. STOCK AVAILABILITY / PA	LEAD TIME	MIN. ORD.	A C							
ACTUATOR													
996226486	N	EA	1	20	1		ACTUATOR JV-15						
ADAPTER													
260032495	1231480	1	EA				31MK04						
100000298	N	EA	1	14	1		123A						
100000660	N	EA	20	2	1		158A						
101213262	N	EA	1	9	1		176A 3 PCS/ADAPTER						
102808516	5376046	1	EA	IL 18 IN 18 MI OH WI 18			275 A Used to mount a Block Connecting 86A in a standard wall outlet. BSP 461-604-104.						
105219455	N	EA	1	14	1		364A POWER AC 120V						
105246953	N	EA	1	14	1		364B POWER AC 220V						
300005873	1132191	1	EA	IL 18 IN 18 MI OH WI 18			829AD 2						
260964440	N	EA	1	4	1		829AD2						
260381009	N	EA	1	1	1		2021 NTT FCN/D3						
260323787	1944132	1	EA	IL 09 IN MI OH WI 09			A7197-2 FUSE MOUNTING						
260323654	1944157	1	EA	IL 09 IN MI OH WI 09			A7197-5 TERMINAL MOUNTING						
842448128	N	EA	1	2	1		ASSEMBLY CHANNEL UNIT TEST						
260360409	1953752	1	EA	IL 75 IN MI OH WI 75			CABLE CASSETTE						
400830956	N	EA	1	10	1		CK14169 L 7						
400558250	N	EA	1	13	1		CK20482 L 1						

PRODUCT IDENTIFIER							DESCRIPTION						
ITEM NUMBER	ORD. MULT.	SELL UNIT	STD. PKG. STOCK AVAILABILITY / PA	LEAD TIME	MIN. ORD.	A C							
401312087	1175737	1	EA	IL 59 IN 59 MI OH WI 59			ADAPTER CK21253 L 1						
401955430	1183954	1	EA	IL 59 IN 59 MI OH WI 59			ADAPTER CK21253 L 5						
401272646	N	EA	1	2	1		ADAPTER CK21386 L 1 PLUG BANTA						
260386701	N	EA	1	8	1		ADAPTER CK21387 PLUG						
260382361	N	EA	1	3	1		ADAPTER COUPLER DYNATEL						
402095079	N	EA	1	7	1		ADAPTER CUR LOOP NO 012-0						
260971171	1247148		EA	IL IN MI OH WI			ADAPTER DMA 1831						
260342373	N	EA	1	17	1		ADAPTER EDA NO						
260426622	N	EA	1	6	1		ADAPTER FUSE TPL-TA						
260380621	N	EA	1	1	1		ADAPTER KIT 6361-369 FLANGE						
260964481	N	EA	1	2	1		ADAPTER NETWORK INTERFACE 0562						
260382320	N	EA	1	1	1		ADAPTER SQUARE BORE 1130 3/4in x 4in.						
260382312	N	EA	1	1	1		ADAPTER SQUARE BORE 1136 SPLIT 3/4in x 4in.						
260383351	N	EA	1	1	1		ADAPTER TEL49491005-1113						
260382650	N	EA	1	1	1		ADAPTER TERMINAL QUAD TPI-108-30						
260030820	1226282	1	EA	IL 08 IN MI OH WI 08			ADAPTER WTLL 31MK03						
ADAPTER BRIDGING													
400776407	1130930	1	EA				ADAPTER BRIDGING 283-53-1						

DISTRIBUTION SERVICES

NETWORK SERVICES

TOOLS

BUILDING JANITORIAL

AUTOMOTIVE

FORMS/OFFICE SUPPLIES

GENERAL

DATA VOICE

DISTRIBUTION SERVICES

NETWORK SERVICES

TOOLS

BUILDING JANITORIAL

AUTOMOTIVE

FORMS/OFFICE SUPPLIES

GENERAL

DATA VOICE

ADAPTER BRIDGING

PRODUCT IDENTIFIER		DESCRIPTION					
ITEM	ORD.	SELL	STD. PKG.	LEAD TIME	MIN.	A	
NUMBER	MULT.	UNIT	STOCK AVAILABILITY / PA			ORD.	C

400591582 ADAPTER BRIDGING 283-95-1

1228056	1	EA	IL	IN	MI	OH	WI
			18	18			

Amphenol, consists of 2 sets of CK16672 L3 connector & 2 sets of 5 each CK16671 L1 plug bridged together pair to pair. Used to bridge 100 pair cables to 2-30 line Call Directors.

400000220 ADAPTER BRIDGING CK19252 L 1

1100685	1	EA	IL	IN	MI	OH	WI
			18	18	18	18	18

Equipped with 2 connectors and one plug to receive an A-type connector cable for a two plug-ended telephone set, BSP 461-200-182.

400000238 ADAPTER BRIDGING CK19252 L 2

1100701	1	EA	IL	IN	MI	OH	WI
			59	59	59	59	59

Equipped with 2 plugs and one connector to receive an incoming and outgoing A-type connector cable for a one plug-ended telephone set, BSP 461-200-182.

ADJUSTER

260386909 ADJUSTER CK19355 L 3

N		EA	1	13	1		
---	--	----	---	----	---	--	--

ALERT

AMPLIFIER

101420651 AMPLIFIER 227F

N		EA	1	13	1		
			VRA0200AAA.				

101928067 AMPLIFIER 241B

N		EA	1	2	1		
---	--	----	---	---	---	--	--

260964499 AMPLIFIER 4008

N		EA	1	4	1		
---	--	----	---	---	---	--	--

260013636 AMPLIFIER CA19220 L2

N		EA	1	2	1		
---	--	----	---	---	---	--	--

997622998 AMPLIFIER CK19219 L1

N		EA	1	13	1		
---	--	----	---	----	---	--	--

997622790 AMPLIFIER CK19220 L2

N		EA	1	12	1		
---	--	----	---	----	---	--	--

997622782 AMPLIFIER CK19221 L1 M/D REPLACED BY

N		EA	1	12	1		
			PID 406220186.				

260444914 AMPLIFIER CK19221 L-2 REPLACEMENT FOR

N			Amplifier CK19221 L-1.				
---	--	--	------------------------	--	--	--	--

997622725 AMPLIFIER CK19328 L1

N		EA	1	4	1		
---	--	----	---	---	---	--	--

PRODUCT IDENTIFIER		DESCRIPTION					
ITEM	ORD.	SELL	STD. PKG.	LEAD TIME	MIN.	A	
NUMBER	MULT.	UNIT	STOCK AVAILABILITY / PA			ORD.	C

997622709 AMPLIFIER CK19739 L1

N		EA	1	3	1		
---	--	----	---	---	---	--	--

400533204 AMPLIFIER CK20449 L1

N		EA	1	10	1		
---	--	----	---	----	---	--	--

260380944 AMPLIFIER HEARING W 6KM IVORY

N		EA	1		1		
---	--	----	---	--	---	--	--

260380936 AMPLIFIER HEARING W6500M WHITE

N		EA	1	2	1		
---	--	----	---	---	---	--	--

260422738 AMPLIFIER HEARING W6500M00 BLACK

N		EA	1	1	1		
---	--	----	---	---	---	--	--

260422720 AMPLIFIER HEARING W6500M09 IVORY

N		EA	1	1	1		
---	--	----	---	---	---	--	--

260422712 AMPLIFIER HEARING W6500M13 BEIGE

N		EA	1	1	1		
---	--	----	---	---	---	--	--

280013335 AMPLIFIER J11501 L03

N		EA	1	13	1		
---	--	----	---	----	---	--	--

260027826 AMPLIFIER J87322 C1 L1

1216549	1	EA	IL	IN	MI	OH	WI
---------	---	----	----	----	----	----	----

260380969 AMPLIFIER SPEECH W7500M BEIGE

N		EA	1	2	1		
---	--	----	---	---	---	--	--

260380977 AMPLIFIER SPEECH W7500M WHITE

N		EA	1	2	1		
---	--	----	---	---	---	--	--

ANGLE GUARD

842313934 ANGLE GUARD LH

N		EA	1	9	1		
---	--	----	---	---	---	--	--

842314015 ANGLE GUARD RH

N		EA	1	9	1		
---	--	----	---	---	---	--	--

ANNOUNCER

260449699 ANNOUNCER ANA-2000A2 HECI MTPMM1F

N							
---	--	--	--	--	--	--	--

ARRESTOR

280019027 ARRESTOR 7800-10KV

N		EA	1	4	1		
			A 10KV lighting arrestor in secured grounded enclosure.				

280019035 ARRESTOR 7800-15KV LIGHTNING

1969113	1	EA	IL	IN	MI	OH	WI
			04	04		04	

A 15KV lighting arrestor in secured grounded enclosure.

PRODUCT IDENTIFIER		DESCRIPTION					
ITEM NUMBER	ORD. MULT.	SELL UNIT	STD. PKG. STOCK AVAILABILITY / PA	LEAD TIME	MIN. ORD.	A	C
ASSEMBLY							
402092282	N	EA	1	7	1		
ASSEMBLY B32627 BRUSH RING							
997811153	N	EA	1	2	1		
ASSEMBLY CK15800 L 1 BLOWER RM781115.							
995204229	N	EA	1	2	1		
ASSEMBLY CK20085 L 4 BUS 10FT ITE 2510.							
840060982	N	EA	1	9	1		
ASSEMBLY CUP & COIL							
300095916	1225078	1	EA	IL 39 IN 39 MI OH WI			
ASSEMBLY D TMS0006-02 LDX NCTE interface.							
300095908	1227090	1	EA	IL 39 IN 39 MI OH WI			
ASSEMBLY D TMS0006-02 LXX NCTE interface unwired.							
300095882	1167577	1	EA	IL 39 IN 39 MI OH WI			
ASSEMBLY D TMS0012-00 LDX NCTE interface.							
300095890	1110718	1	EA	IL 39 IN 39 MI OH WI			
ASSEMBLY D TMS0012-00 LXX Unwired.							
300095874	1147777	1	EA	IL 39 IN 39 MI OH WI			
ASSEMBLY D TMS0024-00 LDX							
300095866	1157438	1	EA	IL 39 IN 39 MI OH WI			
ASSEMBLY D TMS0024-00 LXX NCTE interface unwired.							
843049883	N	EA	1	1	1		
ASSEMBLY DUCT							
843080391	N	EA	1	10	1		
ASSEMBLY ELBOW							
842316374	N	EA	1	12	1		
ASSEMBLY FRAME MOUNTING BAR							
840235865	N	EA	1	9	1		
ASSEMBLY FUSE POST							
300062718	1194977	1	EA	IL 39 IN MI OH WI			
ASSEMBLY MOUNTING 248A One-slot mounting, desk or wall mount, for use with 4424 and 4425 coils or with 4008 program amplifier.							

PRODUCT IDENTIFIER		DESCRIPTION					
ITEM NUMBER	ORD. MULT.	SELL UNIT	STD. PKG. STOCK AVAILABILITY / PA	LEAD TIME	MIN. ORD.	A	C
300062734	N	EA	1	4	1		
ASSEMBLY MOUNTING 248D							
260964267	N	EA	1	14	1		
ASSEMBLY MOUNTING 4402DE							
260961925	N	EA	1	4	1		
ASSEMBLY MOUNTING 44D6U-11							
260964283	N	EA	1	16	1		
ASSEMBLY MOUNTING 97078-00							
260964242	1238097	1	EA	IL IN MI OH WI			
ASSEMBLY MOUNTING 97113-00 SMH							
401871611	N	EA	1	13	1		
ASSEMBLY PRECISION TAPE GUIDE							
841562036	N	EA	1	14	1		
ASSEMBLY REAR COVER							
260392279	N	EA	1	12	1		
ASSEMBLY RT HA01B-0006-A011 Network bay, rack with 3CB's & with F BRS LC & FL/OW panel.							
843282526	N	EA	1	12	1		
ASSEMBLY SEPARATOR							
105348320	N	EA	1	14	1		
ASSEMBLY SHIELD REAR F87AK8640							
842711038	N	EA	1	9	1		
ASSEMBLY SKIRT							
843083007	N	EA	1	10	1		
ASSEMBLY SUPPORT							
843054057	N	EA	1	1	1		
ASSEMBLY SUPPORT							
844533042	N	EA	1	9	1		
ASSEMBLY T HANDLE							
840291264	N	EA	1	2	1		
ASSEMBLY THUMB LATCH							
260978101	N	EA	1	4	1		
ASSEMBLY TLTD DDA 19-11							
260381694	N	EA	1	12	1		
ASSEMBLY WRITER ENABLE L-502502							
ASSEMBLY BRACKET							
SEE BRACKET ASSEMBLY.							
ASSEMBLY CABLE							
840531511	N	EA	1	2	1		
ASSEMBLY CABLE 840531511							

DISTRIBUTION SERVICES
 NETWORK SERVICES
 TOOLS
 BUILDING JANITORIAL
 AUTOMOTIVE
 FORMS/OFFICE SUPPLIES
 GENERAL
 DATA VOICE

DISTRIBUTION SERVICES

NETWORK SERVICES

TOOLS

BUILDING JANITORIAL

AUTOMOTIVE

FORMS/OFFICE SUPPLIES

GENERAL

DATA VOICE

ASSEMBLY CABLE

PRODUCT IDENTIFIER		DESCRIPTION					
ITEM NUMBER	ORD. MULT.	SELL UNIT	STD. PKG. STOCK AVAILABILITY / PA	LEAD TIME	MIN. ORD.	A C	

840531529			ASSEMBLY CABLE 840531529			
N		EA	1	2	1	
840531594			ASSEMBLY CABLE 840531594			
N		EA	1	2	1	
840531602			ASSEMBLY CABLE 840531602			
N		EA	1	2	1	
840543912			ASSEMBLY CABLE 840543912			
N		EA	1	9	1	
840862312			ASSEMBLY CABLE 840862312			
N		EA	1	9	1	
840896468			ASSEMBLY CABLE 840896468			
N		EA	1	2	1	
840916167			ASSEMBLY CABLE 840916167			
N		EA	1	8	1	
840949721			ASSEMBLY CABLE 840949721			
N		EA	1	2	1	
840949861			ASSEMBLY CABLE 840949861			
N		EA	1	8	1	
840956239			ASSEMBLY CABLE 840956239			
N		EA	1	2	1	
840957823			ASSEMBLY CABLE 840957823			
N		EA	1	2	1	
841126493			ASSEMBLY CABLE 841126493			
N		EA	1	9	1	
841598683			ASSEMBLY CABLE 841598683			
N		EA	1	2	1	
841598691			ASSEMBLY CABLE 841598691			
N		EA	1	2	1	
841826712			ASSEMBLY CABLE 841826712			
N		EA	1	8	1	
842729030			ASSEMBLY CABLE 842729030			
N		EA	1	2	1	
842730046			ASSEMBLY CABLE 842730046			
N		EA	1	2	1	
842730053			ASSEMBLY CABLE 842730053			
N		EA	1	8	1	

ATTENUATOR

260357256			ATTENUATOR H-PAD DC ISOLATED			
1952697	1	EA				
			25 circuit.			

PRODUCT IDENTIFIER		DESCRIPTION					
ITEM NUMBER	ORD. MULT.	SELL UNIT	STD. PKG. STOCK AVAILABILITY / PA	LEAD TIME	MIN. ORD.	A C	

260357249			ATTENUATOR H-PAD DC ISOLATED 3DB			
1952689	1	EA	IL IN MI OH WI			
			66 block mount.			
260971742			ATTENUATOR K-PAD 3.4DB PDOK034			
N		EA	1	4	20	

BACKPLATE STIFFNER

842093619			BACKPLATE STIFFNER GEC 6516			
N		EA	1	2	1	

BAFFLE

260380373			BAFFLE 3777-624			
1973412	1	EA				
260442025			BAFFLE HEAT DEFLECTOR 76006			
N		EA	1	4	2	

260406459			BAFFLE HEAT HA15B-0001-B006			
1969998	1	EA	IL IN MI OH WI			
			09 09 09			

BALL BEARING

997078308			BALL BEARING STEEL .259IN			
N		EA	1	13	1	

BAR

840026702			BAR DESIGN			
N		EA	1	18	1	

260972385			BAR EXTENDER 31MK23			
1248609	1	EA	IL IN MI OH WI			

842147753			BAR GROUND 842-147-753			
N		EA	1	13	1	

900044421			BAR MOUNTING 303 ALUMINUM			
N		EA	1	8	1	

842448078			BAR MOUNTING LEFT HAND			
N		EA	1	9	1	

842448086			BAR MOUNTING RIGHT HAND			
N		EA	1	9	1	

842388498			BAR MOUNTING TERMINAL STRIP			
N		EA	1	15	1	

840891451			BAR RETAINING			
N		EA	1	15	1	

840982250			BAR SUPPORT JUMPER 840982250			
N		EA	1	15	1	

BAY AND ASSOCIATED HARDWARE

PRODUCT IDENTIFIER		DESCRIPTION				
ITEM NUMBER	ORD. MULT.	SELL UNIT	STD. PKG. STOCK AVAILABILITY / PA	LEAD TIME	MIN. ORD.	A C
BASE						
260381181	N	EA	1	2	1	
260381181 BASE STYLE CP3035X						
BATTERY						
280011115	N	EA	1	5	3	
280011115 BATTERY 77-811-10 RELIANCE This is a 1 amp, 6 volt battery used with STU-4, STU-4B, STU-5 and STU-ESS AML Systems. R-TEC.						
280011123	N	EA	1	5	3	
280011123 BATTERY 77-860-00 RELIANCE This is a 1 amp, 6 volt battery used with STU-7 AML Systems. R-TEC.						
280019837	N	EA	1	2	1	
280019837 BATTERY 9.6 VOLTS 1508 GOULD 918500016.						
260427893	1977793	1	EA	IL 18 IN 18 MI 18 OH 18 WI 18		
260427893 BATTERY 0820-2012 CK21906L4 12V 25AMP digital loop carrier system slick 6SLC96 Series 5.						
300085149	N	EA	1	2	1	
300085149 BATTERY 12.0 VOLTS TTI 10860 Used as power supply with hy/guard equipment.						
402269583	1935353	1	EA	IL 18 IN 18 MI 18 OH 18 WI 18		
402269583 BATTERY 12.0V CK21906 L4 FOR SLC-96 983141. Sealed rechargeable 12 volt batteries, for Pair Gain System. Must order 4ea to make 48volt battery string. BSP 363-303-100.						
260449681	N					
260449681 BATTERY 3VB13						
260466935	N					
260466935 BATTERY 6.0V 3VB11 NEED TO ORDER STRING OF 8.						
400694352	N	EA	1	10	1	
400694352 BATTERY CK20390 L1						
401644539	N	EA	1	14	1	
401644539 BATTERY CK20390 L6 Used to provide talk battery and ringing capability to the derived set and to power the SLC-1C subscriber unit, BSP 502-240-100.						
401785258	N	EA	1	8	30	
401785258 BATTERY CK20390 L9						
402242234	1939827	1	EA	IL 18 IN MI OH WI 18		
402242234 BATTERY CK21906 L1 Used with the Enhanced E911 Emergency Reporting System.						

PRODUCT IDENTIFIER		DESCRIPTION				
ITEM NUMBER	ORD. MULT.	SELL UNIT	STD. PKG. STOCK AVAILABILITY / PA	LEAD TIME	MIN. ORD.	A C
300085115	N	EA	1	4	1	
300085115 BATTERY JC619-1 GLOBE GEL/CELL						
280025461	N	EA	1	2	7	
280025461 BATTERY RB-20 REPLACEMENT						
401526686	2790840	1	EA	IL 09 IN 09 MI OH WI 09		
401526686 BATTERY STU 4B71-811-10						
401814462	1159483	1	EA	IL 18 IN 18 MI OH WI 18		
401814462 BATTERY STU 7 77-860-00						
300031945	N	EA	1	4	1	
300031945 BATTERY U131-A SLC Single battery without diode assembly. To be used in conjunction with the Subscriber Loop Carrier Systems.						
BATTERY FILLER						
SEE FILLER BATTERY.						
BAY						
401231113	N	EA	1	13	1	
401231113 BAY DC CONT CK21114 L2 DIST The control & distribution center between charging rectifiers, battery, and fuses to which the battery supply is furnished. E/W 8 30 amp & 8 20 amp discharge circuit breakers with filler blanks in 16.						
401220496	N	EA	1	13	1	
401220496 BAY DC CONT KS21114 L1 The control & distribution center between charging rectifiers, battery, and fuses to which the battery supply is furnished. E/W ten 100 amp discharge circuit breakers.						
BAY AND ASSOCIATED HARDWARE						
260440334	N	EA	1	3	4	
260440334 BAY NETWORK 0243-01FT49 7FT BLUE						
260441985	N	EA	1	3	30	
260441985 BAY NETWORK 7FT 12416-01F +50						
260405386	1969725	1	EA	IL 09 IN MI OH WI 09		
260405386 BAY NETWORK 7FT HMW02043-01 GRAY						
260436977	N	EA	1	3	4	
260436977 BAY NETWORK 9FT 02043-04FT49 BLUE						
260439518	N	EA	1	2	1	
260439518 DOOR REAR LGX DF ED6C321-50 G3						
260439534	N	EA	1	4	1	
260439534 EXTENSIONS END GUARD 11FT 6IN ED6C172-30 G10.						

DISTRIBUTION SERVICES

NETWORK SERVICES

TOOLS

BUILDING JANITORIAL

AUTOMOTIVE

FORMS/OFFICE SUPPLIES

GENERAL

DATA VOICE

DISTRIBUTION SERVICES

NETWORK SERVICES

TOOLS

BUILDING JANITORIAL

AUTOMOTIVE

FORMS/OFFICE SUPPLIES

GENERAL

DATA VOICE

BAY AND ASSOCIATED HARDWARE

PRODUCT IDENTIFIER		DESCRIPTION					
ITEM NUMBER	ORD. MULT.	SELL UNIT	STD. PKG. STOCK AVAILABILITY / PA	LEAD TIME	MIN. ORD.	A	C
260439617			EXTENSIONS END GUARD ED6C172-30	G9			
N		EA	1	4	1		
260439609			FRAME BAY NETWORK LGX DF 11FT 6IN				
N		EA	1	2	1		
			ED8C504-50	G5.			
260439500			FRAME BAY NETWORK LGX DF 7FT				
N		EA	1	2	1		
			ED6C321-50				
			G-1.				
260441555			FRAME LGX DF METAL PARTS ED6C321-50	G2			
N		EA	1	2	1		
260439526			GUARD END LGX DF ED6C321-50	G4			
N		EA	1	2	1		
260439567			GUIDELINE JUMPER LGX DISTRIBUTION SYSTEM				
N		EA	1	2	1		
260439542			LABEL SET 11B				
N		EA	1	2	1		
260439559			LABEL SET 12B				
N		EA	1	2	1		
103921961			ORGANIZER LIGHTGUIDE UC-RR				
N		EA	1	2	1		
			Ribbon to ribbon fusion splice organizer. NOW AVAILABLE THROUGH TOUCH-TONE ORDER ENTRY.				

104325055 ORGANIZER LIGHTGUIDE UC-RS/F1
 1939520 1 EA IL IN MI OH WI
 21 21 21 21
 Ribbon to stranded fusion splice organizer.

104325063 ORGANIZER LIGHTGUIDE UC-SS/F1
 1921502 1 EA IL IN MI OH WI
 21 21 21 21 21
 Fusion splicing organizer trays for use in a UCB1 lightguide closure.

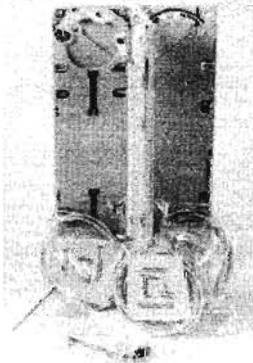

1921502

105040661 ORGANIZER LIGHTGUIDE UC-SS/M1
 N EA 1 2 1

PRODUCT IDENTIFIER		DESCRIPTION					
ITEM NUMBER	ORD. MULT.	SELL UNIT	STD. PKG. STOCK AVAILABILITY / PA	LEAD TIME	MIN. ORD.	A	C
260358551			ORGANIZER LIGHTGUIDE UC-SS/M1				
1953265	1	EA	IL IN MI OH WI	21			
105339899			ORGANIZER LT1A-F/F				
N		EA	1	2	1		
104325683			OUTLET LIGHTGUIDE 10S2A 1 POSITION				
N		EA	1	4	1		
104325741			OUTLET LIGHTGUIDE 12S2A 2 POSITION				
N		EA	1	4	1		
260439583			RETAINER JUMPER (PAIR) JR2A				
N		EA	1	6	1		
260370309			SHELF LSC1U-024/05 LIGHTGUIDE C				
1955948	1	EA	IL IN MI OH WI	18 08 09 09			
260439575			SHELF TERMINATION LG LST1U-072-7				
N		EA	1	2	1		

BELT

260387295			BELT DISC FILE 11029147	M/D			
N		EA	1	2	1		
			Replaced by 260367891.				
260367891			BELT GATES 5M1220				
N		EA	1	2	3		
			For 1AESS disk file, REPLACES BURROUGHS (MEMOREX) PART 1102-9147.				

BINDER CLAMP

842314403			BINDER CLAMP 842314403				
N		EA	1	12	1		

BLOCK CONNECTOR

101144731			BLOCK CONNECTOR 78A1	64			
N		EA	1	1	1		
101144749			BLOCK CONNECTOR 78B1	64			
N		EA	1	6	1		
102371770			BLOCK CONNECTOR 78C1A	50			
N		EA	1	1	1		
102371788			BLOCK CONNECTOR 78C1A	64			
N		EA	1	1	1		
102371796			BLOCK CONNECTOR 78C1A	100			
N		EA	1	1	1		
102371804			BLOCK CONNECTOR 78C1B	100			
N		EA	1	1	1		
102371838			BLOCK CONNECTOR 78C2A	64			
N		EA	1	1	1		

DISTRIBUTION SERVICES

NETWORK SERVICES

TOOLS

BUILDING JANITORIAL

AUTOMOTIVE

FORMS/OFFICE SUPPLIES

GENERAL

DATA VOICE

PRODUCT IDENTIFIER		DESCRIPTION				
ITEM NUMBER	ORD. MULT.	SELL UNIT	STD. PKG. STOCK AVAILABILITY / PA	LEAD TIME	MIN. ORD.	A C
103815528		BLOCK CONNECTOR	78C2E	100		
N		EA	1	6	1	
104017355		BLOCK CONNECTOR	78C2F	64		
N		EA	1	6	1	
104146071		BLOCK CONNECTOR	89E1A	90		
N		EA	1	1	1	
104213921		BLOCK CONNECTOR	89E1E	120		
N		EA	1	6	1	
104024757		BLOCK CONNECTOR	89E1E	128		
N		EA	1	1	1	
260419106		BLOCK CONNECTOR	89E1E	256		
1973958	1	EA	IL IN MI OH WI 03			
Connector block for miscellaneous trunk, toll and special services. Single wire wrap, 16 X 32IN, beige fanning strip. Replacement for 93 type blocks.						
105500268		BLOCK CONNECTOR	89E7A	128		
N		EA	1	6	1	
104024773		BLOCK CONNECTOR	89F1F	100		
N		EA	1	1	1	
105500219		BLOCK CONNECTOR	89M1CH	21 128		
N		EA	1	6	1	
104438635		BLOCK CONNECTOR	89M1DD	21 128		
N		EA	1	1	1	
105529101		BLOCK CONNECTOR	89M1HE	21		
N		EA	1	1	1	
103815510		BLOCK CONNECTOR	112C2E	100		
N		EA	1	9	1	
103288288		BLOCK CONNECTOR	112E1A	128		
N		EA	1	9	1	
103634879		BLOCK CONNECTOR	112E1D	128		
N		EA	1	1	1	
104394648		BLOCK CONNECTOR	800A2	A1		
N		EA	1	1	1	
104394713		BLOCK CONNECTOR	800G2	C1		
N		EA	1	1	1	
260441563		BLOCK CONNECTOR	89F1F-100			
N		EA	1	2	1	
260380548		BLOCK CONNECTOR	DM6048C	HI VALUE		
N		EA	1	1	1	
260382296		BLOCK CONNECTOR	F200			
N		EA	1	1	1	

PRODUCT IDENTIFIER		DESCRIPTION				
ITEM NUMBER	ORD. MULT.	SELL UNIT	STD. PKG. STOCK AVAILABILITY / PA	LEAD TIME	MIN. ORD.	A C
260392253		BLOCK CONNECTOR PANEL	1000			
1965798	1	EA	IL IN MI OH WI 08 08 08 08			
BLOCK CONNECTORIZED						
260448949		BLOCK CONNECTORIZED PUNCH DOWN TYPE				
N						
S66M1-50. 3 per subrack, Inmate Services Equipment.						
260448956		BLOCK CONNECTORIZED WIRE WRAP (TELZON)				
N						
424-2006-001. 1 per subrack. Inmate Services Equipment.						
BLOCK FUSE						
100010362		BLOCK FUSE	12E			
N		EA	1	14	1	
100010388		BLOCK FUSE	13A			
N		EA	1	15	1	
100010404		BLOCK FUSE	15A			
N		EA	1	14	1	
100010412		BLOCK FUSE	15B			
N		EA	1	14	1	
100010420		BLOCK FUSE	18A			
N		EA	1	2	1	
102261062		BLOCK FUSE	18C			
N		EA	1	7	1	
100010438		BLOCK FUSE	19A			
N		EA	1	2	1	
100010446		BLOCK FUSE	20A			
N		EA	1	2	1	
100010453		BLOCK FUSE	21A			
N		EA	1	2	1	
Intended to mount a #70 type fuse associated with a 756A PBX.						
100010461		BLOCK FUSE	22A			
N		EA	1	2	1	
100010479		BLOCK FUSE	22B			
N		EA	1	2	1	
100010487		BLOCK FUSE	23A			
N		EA	1	2	1	
100010495		BLOCK FUSE	23B			
N		EA	1	2	1	
100010503		BLOCK FUSE	24A			
N		EA	1	7	1	

DISTRIBUTION SERVICES

NETWORK SERVICES

TOOLS

BUILDING JANITORIAL

AUTOMOTIVE

FORMS/OFFICE SUPPLIES

GENERAL

DATA VOICE

BLOCK FUSE

PRODUCT IDENTIFIER		DESCRIPTION					
ITEM NUMBER	ORD. MULT.	SELL UNIT	STD. PKG. STOCK AVAILABILITY / PA	LEAD TIME	MIN. ORD.	A C	
100010511			BLOCK FUSE 24B				
N		EA	1	2	1		
102261070			BLOCK FUSE 24C				
N		EA	1	7	1		
100010529			BLOCK FUSE 25A				
N		EA	1	7	1		
102545647			BLOCK FUSE 25B				
N		EA	1	7	1		
102547221			BLOCK FUSE 25C				
N		EA	1	7	1		
100010537			BLOCK FUSE 26A				
N		EA	1	2	1		
100010545			BLOCK FUSE 27A				
N		EA	1	2	1		
100730621			BLOCK FUSE 28A				
N		EA	1	7	1		
102712825			BLOCK FUSE 29A				
N		EA	1	2	1		
100730647			BLOCK FUSE 30A				
N		EA	1	7	1		
102979937			BLOCK FUSE 30A				
N		EA	1	7	1		
102980489			BLOCK FUSE 30B				
N		EA	1	7	1		
103294666			BLOCK FUSE 34C				
N		EA	1	7	1		
103324919			BLOCK FUSE 37A				
N		EA	1	7	1		
997024930			BLOCK FUSE CK14169 L 1 MOLDED				
N		EA	1	2	1		
997122304			BLOCK FUSE CK14169 L 6				
N		EA	20	2	20		
997024948			BLOCK FUSE CK14170 L 1				
N		EA	1	8	1		

BLOCK PROTECTOR

100010594			BLOCK PROTECTOR 26			
1112227	100	EA				
			1 1/4IN X 3/8IN. Plain carbon block used at stations and in central office on protective mountings having 1/2in centers. Used with No. 27 protector blocks, BSP 638-400-200.			

PRODUCT IDENTIFIER		DESCRIPTION					
ITEM NUMBER	ORD. MULT.	SELL UNIT	STD. PKG. STOCK AVAILABILITY / PA	LEAD TIME	MIN. ORD.	A C	

100010602 BLOCK PROTECTOR 27

1112243	100	EA				
			IL	IN	MI	OH
			09	09	09	09
			Grooved white porcelain frame with a carbon insert. Used on protective mountings having 1/2in centers, BSP 638-400-200, BSP 201-206-101.			

100010610 BLOCK PROTECTOR 28

1112268	100	EA				
			IL	IN	MI	OH
			09	09	09	09
			Plain carbon block 1in long and 9/32in wide. Used on protector mountings having 3/8in centers, BSP 638-400-200, BSP 201-206-101.			

100010628 BLOCK PROTECTOR 29

1112284	100	EA				
			IL	IN	MI	OH
			09	09	09	09
			Grooved white porcelain frame with carbon insert. Used on protector mountings having 3/8in centers, BSP 638-400-200, BSP 201-206-101.			

100010644 BLOCK PROTECTOR 30

N		EA	25	3	25	
			Grooved blue porcelain frame with carbon insert. (.006in GAP cable protection.) BSP 638-400-200.			

100010693 BLOCK PROTECTOR 32B

1112342	100	EA				
			IL	IN	MI	OH
			09	09	09	09
			Carbon block forms a part of the 1A1C protector unit, BSP 201-220-102.			

100010719 BLOCK PROTECTOR 33B

1112383	1	EA				
			IL	IN	MI	OH
			09	09	09	09
			A white porcelain block used with 2A type protector unit, BSP 201-220-102, BSP 638-400-205.			

100010735 BLOCK PROTECTOR 34A1

N		EA	1	6	1	
---	--	----	---	---	---	--

260380738 BLOCK PROTECTOR T1

1960799	1	EA				
			IL	IN	MI	OH
			09	09	09	09
			HA660-0001-T071. Electronic equipment components to be assembled within a Fujitsu 6200 cabinet.			

260380746 BLOCK PROTECTOR VF CABLE

1960781	1	EA				
			IL	IN	MI	OH
			09	09	09	09
			HA660-0001-T070. Electronic equipment components to be assembled within a Fujitsu 6200 cabinet.			

BLOCK TERMINAL**260392287 BLOCK GW 10 X 20 LINE BLOCK TERMINAL**

1965830	1	EA				
---------	---	----	--	--	--	--

400468781 BLOCK TERMINAL BARRIER 10-140

N		EA	1	14	1	
---	--	----	---	----	---	--

DISTRIBUTION SERVICES

NETWORK SERVICES

TOOLS

BUILDING JANITORIAL

AUTOMOTIVE

FORMS/OFFICE SUPPLIES

GENERAL

DATA VOICE

PRODUCT IDENTIFIER		DESCRIPTION				
ITEM NUMBER	ORD. MULT.	SELL UNIT	STD. PKG. STOCK AVAILABILITY / PA	LEAD TIME	MIN. ORD.	A C
260446687			BLOCK CONN PUNCH-DOWN TYPE S66M1-50			
N			1 per 24 lines.			
260446695			BLOCK CONN WIREWRAP (TELZON) 424-2006001			
N			1 per system.			

BLOWER

403020324			BLOWER CK22100 L 1			
1229054	1	EA				

BOARD

841734759			BOARD CONTROL SP4			
N		EA	1	2	1	
For J87435A Rectifier.						
260387154			BOARD DEPLEXTION 80001082			
N		EA	1	2	1	
260394135			BOARD POWER EQUIPMENT 5821-105-15			
1971606	1	EA	IL	IN	MI	OH WI
09 Used in Controlled Environment Vault						
401871314			BOARD PRINTED WIRING L-502681			
N		EA	1	1	1	

BRACE

260392204			BRACE HORIZONTAL P47555T			
N		EA	1	8	1	

BRACKET

101213718			BRACKET 86A			
N		EA	1	9	1	
260413455			BRACKET 8982-01			
1971432	1	EA	IL	IN	MI	OH WI
09						
843079930			BRACKET 843079930			
N		EA	1	14	1	
843282369			BRACKET 843282369			
N		EA	1	15	1	
260436571			BRACKET BK-310			
1980813	1	EA	IL	IN	MI	OH WI
09						
841762768			BRACKET CABLE 841762768			
N		EA	1	15	1	
842354136			BRACKET CONNECTOR MOUNTING 305-310			
N		EA	1	1	1	

PRODUCT IDENTIFIER		DESCRIPTION				
ITEM NUMBER	ORD. MULT.	SELL UNIT	STD. PKG. STOCK AVAILABILITY / PA	LEAD TIME	MIN. ORD.	A C
840850002			BRACKET DESIGNATION STRIP			
N		EA	1	10	1	
260445101			BRACKET FILTER AIR (LEFT)			
N			Used in LTS-21130D Terminal.			
260445119			BRACKET FILTER AIR (RIGHT)			
N			Used in LTS-21130D Terminal.			
840048839			BRACKET LEFT 840048839			
N		EA	1	10	1	

402446504			BRACKET SERVICE CK22325 L1			
1979286	1	EA	IL	IN	MI	OH WI
09 Used when splicing an AT-9049 B or C Protector and Cable Enclosure.						

260418561			BRACKET SOCKET MOUNTING 3716-732			
1973446	1	EA	IL	IN	MI	OH WI
09						

260392196			BRACKET SWIVEL MOUNT P29735			
N		EA	1	8	1	

260304159			BRACKET WALL MOUNT 10 81.1779			
1942334	1	EA	IL	IN	MI	OH WI
08 Wall-mount bracket kit Hi-Cap.						

BRACKET ASSEMBLY

841610850			BRACKET ASSEMBLY 841610850			
N		EA	1	8	1	
842389124			BRACKET ASSEMBLY 842389124			
N		EA	1	10	1	
843050873			BRACKET ASSEMBLY 843050873			
N		EA	1	9	1	
843050881			BRACKET ASSEMBLY 843050881 LEFT			
N		EA	1	9	1	

BRACKET MOUNTING

841779663			BRACKET MOUNTING 841779663			
N		EA	1	13	1	
842388423			BRACKET MOUNTING TERMINAL STRIP			
N		EA	1	9	1	

BREAKER

260435656			BREAKER TRIP ALARM 20 AMP #2566102			
1980524	1	EA				

BREAKER

DISTRIBUTION SERVICES

PRODUCT IDENTIFIER		DESCRIPTION					
ITEM NUMBER	ORD. MULT.	SELL UNIT	STD. PKG. STOCK AVAILABILITY / PA	LEAD TIME	MIN. ORD.	A C	
260435664 BREAKER TRIP ALARM 60 AMP #2566172							
1980516	1	EA	IL IN MI OH WI	09			

NETWORK SERVICES

BREAKER CIRCUIT						
260394184 BREAKER CIRCUIT 15A 2566-094						
1973479	1	EA				
260418637 BREAKER CIRCUIT 100 AMP BR2100						
1973511	1	EA	IL IN MI OH WI	09		

TOOLS

260418603 BREAKER CIRCUIT MOUNTING 4835-636						
N		EA	1			1

BUILDING JANITORIAL

BRIDGE						
402491310 BRIDGE DATA 4449						
1222786	1	EA				
260323662 BRIDGE DIST DBS23-140						
1943993	1	EA	IL IN MI OH WI	09	09	

AUTOMOTIVE

BRUSH						
401871207 BRUSH CAPSTAN CP1 L-502600-1						
N		EA	1	1		1
400442869 BRUSH CK05555 L110 GRADE 255						
N		EA	1			1
Used with the WEC0 Voltage Regulator and Motor Generator.						

FORMS/OFFICE SUPPLIES

400442885 BRUSH KS 5555 L340 WITH LINERS						
1117846	1	EA	IL IN MI OH WI	09	09	
Tone commutator brush. Used with CK5546 and CK5659 ringing machines.						

GENERAL

401871488 BRUSH MOTOR CAP 0002-6						
N		EA	1	12		1
Used in tape transport CK20571.						
401871470 BRUSH MOTOR REEL 2-1820						
N		EA	1	1		1

DATA VOICE

BULB						
SEE LAMP						
BULB RUBBER						
402427645 BULB RUBBER CK05499						
N		EA	1	5		1

PRODUCT IDENTIFIER		DESCRIPTION					
ITEM NUMBER	ORD. MULT.	SELL UNIT	STD. PKG. STOCK AVAILABILITY / PA	LEAD TIME	MIN. ORD.	A C	

BUS BAR

840727929 BUS BAR 840727929 COPPER						
N		EA	1	7		1
841656861 BUS BAR 841656861						
N		EA	1	9		1
841669930 BUS BAR 841669930						
N		EA	1	7		1
843036658 BUS BAR 843036658						
N		EA	1	14		1
843036690 BUS BAR 843036690						
N		EA	1	7		1
843037433 BUS BAR 843037433						
N		EA	1	9		1
843779208 BUS BAR 843779208						
N		EA	1	14		1
843779786 BUS BAR 843779786						
N		EA	1	15		1
843780602 BUS BAR 843780602						
N		EA	1	7		1

BUS DUCT

995204195 BUS DUCT CK20085 L2						
N		EA	1	2		1
402198873 BUS DUCT PLUG-IN CK15696 L451A						
N		EA	1	14		1
402198881 BUS DUCT PLUG-IN CK15696 L452A						
N		EA	1	14		1
402198899 BUS DUCT PLUG-IN CK15696 L453A						
N		EA	1	14		1
402198907 BUS DUCT PLUG-IN CK15696 L454A						
N		EA	1	13		1
402093199 BUS DUCT PLUG-IN CK15696 L455A						
N		EA	1	14		1
402198915 BUS DUCT PLUG-IN CK15696 L456A						
N		EA	1	14		1
402060321 BUS DUCT PLUG-IN CK15696 L457A						
N		EA	1	14		1
402198923 BUS DUCT PLUG-IN CK15696 L471A						
N		EA	1	14		1
402302848 BUS DUCT PLUG-IN CK15696 L472A						
N		EA	1	14		1

PRODUCT IDENTIFIER		DESCRIPTION				
ITEM NUMBER	ORD. MULT.	SELL UNIT	STD. PKG. STOCK AVAILABILITY / PA	LEAD TIME	MIN. ORD.	A C
402198931	N	EA	1	13	1	
BUS DUCT PLUG-IN CK15696 L473A						
402093207	N	EA	1	14	1	
BUS DUCT PLUG-IN CK15696 L474A						
402198949	N	EA	1	13	1	
BUS DUCT PLUG-IN CK15696 L475A						
402198956	N	EA	1	4	1	
BUS DUCT PLUG-IN CK15696 L476A						
402198964	N	EA	1	14	1	
BUS DUCT PLUG-IN CK15696 L477A						
401286828	N	EA	1	14	1	
BUS DUCT PLUG-IN CK15696 L478A						
402060339	N	EA	1	14	1	
BUS DUCT PLUG-IN CK15696 L479A						
402198972	N	EA	1	14	1	
BUS DUCT PLUG-IN CK15696 L480A						

CABINET

260012695	N	CABINET 6919					
260012687	N	CABINET 6919					
260974878	N	EA	1	8	1		
CABINET ASSEMBLY USAFC-481							
260440557	N	EA	1	6	1		
CABINET DISTRIBUTION NT6C14BH							
280051392	1926998	1	EA	IL IN MI OH WI	04		
CABINET LSCIE 102054							
300062981	1152215	1	EA	IL IN MI OH WI	04		
CABINET LSCIT 102052							
1 Net Light Guide Str Cable.							
260360581	N	EA	1	14	1		
CABINET MUSTANG CPU-135-L BEIGE							
280051368	1927004	1	EA	IL IN MI OH WI	08		
CABINET POWER PE96KEG12 468039							
For 36 type cabinets.							
260961693	N	EA	1	4	1		
CABINET TELABS 0262P048							
260961701	N	EA	1	4	1		
CABINET TELABS 0262P084							

PRODUCT IDENTIFIER		DESCRIPTION					
ITEM NUMBER	ORD. MULT.	SELL UNIT	STD. PKG. STOCK AVAILABILITY / PA	LEAD TIME	MIN. ORD.	A C	
CABLE							
260448964	N	CABLE 100FT 25PR TINNED-MISC CONNECTION					
1 per system, Inmate Services Equipment.							
260419320	1974238	1	EA	IL IN MI OH WI	09		
CABLE 734A SMZ 10M							
260419338	1974246	1	EA	IL IN MI OH WI	09 09		
CABLE 734A SMZ 20M							
260419346	1974253	1	EA	IL IN MI OH WI	09 09		
CABLE 734A SMZ 40M							
300095924	5126797	1	EA	IL IN MI OH WI	39 39 39		
CABLE ADAPTER RJ2HX-RJ2DX							
TELZON #800-0005-444.							
843397084	N	EA	1	13	1		
CABLE ASSEMBLY DUAL PORT MONITOR							
843397092	N	EA	1	13	1		
CABLE ASSEMBLY DUAL PORT MONITOR							
260369228	N	EA	1	4	1		
CABLE ASSEMBLY 740-00053-06 7FT							
SIX TO EIGHT POSITION. Used with remote access units M-106, M-486.							
260380993	N	EA	1	1	1		
CABLE ASSEMBLY 1220							
260383385	N	EA	1	1	1		
CABLE ASSEMBLY 12301-0J							
260418520	1973404	1	EA	IL IN MI OH WI	09 09 09		
CABLE BULK RINGING 18FT							
HA660-0001-T601							
260384540	1962555	1	EA	IL IN MI OH WI	09 09 09		
CABLE CHANNEL BANK SET							
HA15B-0001-C003. To be used for assembly into Fujitsu 6200 cabinet.							
300095932	5126813	1	EA	IL IN MI OH WI	39 39		
CABLE CONNECTOR NCTE PACKAGE 2FT							
260447859	N	CABLE CONNECTORIZD 100FT 360375-501 L100					
6 per system, Inmate Services Equipment.							

DISTRIBUTION SERVICES

NETWORK SERVICES

TOOLS

BUILDING JANITORIAL

AUTOMOTIVE

FORMS/OFFICE SUPPLIES

GENERAL

DATA VOICE

CABLE

PRODUCT IDENTIFIER		DESCRIPTION						
ITEM NUMBER	ORD. MULT.	SELL UNIT	STD. PKG. STOCK AVAILABILITY / PA	LEAD TIME	MIN. ORD.	A	C	
260447867			CABLE CONNECTORIZD 150FT 360375-501 L150					
N			6 per system, Inmate Service Equipment.					
260448766			CABLE CONNECTORIZED 100FT 360373-501L100					
N			3 per system. Inmate Services Equipment.					
260448774			CABLE CONNECTORIZED 150FT 360373-501L150					
N			3 per system. Inmate Services Equipment.					
260448758			CABLE CONNECTORIZED 50FT 360373-501-L050					
N			6 per system. Inmate Services Equipment.					
260447495			CABLE CONNECTORIZED 50FT 360375-501 L050					
N			6 per system.					
842391831			CABLE COVER TAP 842391831					
N		CT	1	6			1	
260426069			CABLE DAISY CHAIN 360335-501					
N		EA	1	13			1	
			One per subrack expansion.					
260448899			CABLE DAISY CHAIN 360335-502					
N			1 per syste, Inmate Services Equipment.					
260435763			CABLE DS-3 NT7H01LT					
1980268	1	EA	IL 09 IN 09 MI 09 OH 09 WI 09					
260405428			CABLE HARNESS BATTERY X9943617					
1969758	1	EA	IL 09 IN MI OH WI 09 09 09					
260418512			CABLE INTERCONNECT 18FT					
1973396	1	EA	IL 09 IN MI OH WI 09 09 09					
			HA15B-0001-C063.					
901174961			CABLE KS-5482 L-28FR					
N								
260344866			CABLE NT7H18BE E2A					
1950782	1	EA	IL 09 IN 09 MI 09 OH 09 WI 7X					
			INTERSHELF.					
260344890			CABLE NT7H18BF					
1950758	1	EA	IL 09 IN 09 MI 09 OH 09 WI					
			ALARM DAISY CHAIN.					
260344874			CABLE NT7H18BG E2A					
1950790	1	EA	IL 09 IN 09 MI 09 OH 09 WI					
			INTERSHELF CUSTOM.					

PRODUCT IDENTIFIER		DESCRIPTION						
ITEM NUMBER	ORD. MULT.	SELL UNIT	STD. PKG. STOCK AVAILABILITY / PA	LEAD TIME	MIN. ORD.	A	C	
260392360			CABLE NT7H18BL					
1965954	1	EA	IL 09 IN MI OH WI 09					
			CUSTOM TELEMETRY. Used with the Northern Telecom Multiplexer.					
260402854			CABLE NT7H18BM					
1968545	1	EA	IL 09 IN MI OH WI 09					
			F/A POWER 5M					
260344882			CABLE NT7H18EJ E2A					
1950733	1	EA	IL 09 IN MI OH WI 09					
			INTERSHELF CUSTOM 20M.					
260344833			CABLE NT7H18EK ALARM					
1950808	1	EA	IL 09 IN MI OH WI 09					
260344858			CABLE NT7H18EL I10 20M					
1950774	1	EA	IL 09 IN MI OH WI 09 09 09 09					
			CUSTOM TELMETRY.					
260344908			CABLE NT7H18EM					
1950766	1	EA	IL 09 IN MI OH WI 09 09 09 09					
			CUSTOM POWER INPUT.					
260344841			CABLE NT7H18FA					
1950741	1	EA	IL 09 IN MI OH WI 09 09 09 09					
			CONNECTOR DS-1 15M					
260419577			CABLE NT7H18FL OS-1 15M					
1974436	1	EA	IL 09 IN MI OH WI 09 09 09 09					
260419148			CABLE NT7H18FM DS-1 4SM					
1974006	1	EA	IL 09 IN MI OH WI 09 09 09 09					
			Two required for FMT 150B.					
260364831			CABLE NT7H19BB					
1954701	1	EA	IL 09 IN MI OH WI 09 09 09 09					
			POWER FRONT ACCESS.					
260438015			CABLE NTNX36QA MODEM					
N		EA	1	4			1	
260442298			CABLE NY7H18CF					
N		EA	1	8			1	
842391823			CABLE POSITION TAPE 842391823					
N		PK	1	6			1	
260445028			CABLE POWER FAN (REGENERATOR)					
N			Used in LTS-21130D Terminal.					
260444997			CABLE POWER FAN (TERMINAL)					
N			Used in LTS-21130D Terminal.					

PRODUCT IDENTIFIER		DESCRIPTION				
ITEM NUMBER	ORD. MULT.	SELL UNIT	STD. PKG. STOCK AVAILABILITY / PA	LEAD TIME	MIN. ORD.	A C
260400908			CABLE RELAY INTERFACE 20M			
N						
260445002			CABLE SERVICE CHANNEL EXTENDER (ROUTE DIVERSITY). Used in LTS-21130D Terminal.			
N						
260438007		EA	1	4	1	
N						
260447784			CABLE TINNED 100FT 25PR 1 PER SYSTEM			
N						

CABLE CONNECTOR

260413448			CABLE CONNECTOR 003-297210			
1971424	1	EA				
260413430			CABLE CONNECTOR 003-297220			
1971416	1	EA	IL	IN	MI	OH
			09	09	09	WI
260368717			CABLE CONNECTOR 003-297230			
1955492	1	EA	IL	IN	MI	OH
			09	09	09	WI
			30 pair, 30ft, shielded.			

260394671		EA	1	4	1	
N						
260394689		EA	1	4	1	
N						
260394713		EA	1	4	1	
N						
260394697		EA	1	4	1	
N						
260394655		EA	1	4	1	
N						
260394721		EA	1	4	1	
N						
260394663		EA	1	4	1	
N						
260394606		EA	1	4	1	
N						
260394739		EA	1	4	1	
N						
260394929		EA	1	4	1	
N						
260394614		EA	1	4	1	
N						
260394622		EA	1	4	1	
N						

PRODUCT IDENTIFIER		DESCRIPTION				
ITEM NUMBER	ORD. MULT.	SELL UNIT	STD. PKG. STOCK AVAILABILITY / PA	LEAD TIME	MIN. ORD.	A C
260394556		EA	1	4	1	
N						
260394705		EA	1	4	1	
N						
260394531		EA	1	4	1	
N						
260394895		EA	1	4	1	
N						
260394564		EA	1	4	1	
N						
260394630		EA	1	4	1	
N						
260394572		EA	1	4	1	
N						
260394523		EA	1	4	1	
N						
260394580		EA	1	4	1	
N						
260394648		EA	1	4	1	
N						
260394598		EA	1	4	1	
N						
260394549		EA	1	4	1	
N						
260394861		EA	1	4	1	
N						
260394879		EA	1	4	1	
N						
260394887		EA	1	4	1	
N						
260394754		EA	1	4	1	
N						
260394762		EA	1	4	1	
N						
260394903		EA	1	4	1	
N						
260394770		EA	1	4	1	
N						
260394788		EA	1	4	1	
N						
260394796		EA	1	4	1	
N						

DISTRIBUTION SERVICES

NETWORK SERVICES

TOOLS

BUILDING JANITORIAL

AUTOMOTIVE

FORMS/OFFICE SUPPLIES

GENERAL

DATA VOICE

CABLE CONNECTOR

DISTRIBUTION SERVICES

PRODUCT IDENTIFIER DESCRIPTION

ITEM NUMBER	ORD. MULT.	SELL UNIT	STD. PKG. STOCK AVAILABILITY / PA	LEAD TIME	MIN. ORD.	A C
-------------	------------	-----------	-----------------------------------	-----------	-----------	-----

260394804 CABLE CONNECTOR 803-0165-235
N EA 1 4 1

260394812 CABLE CONNECTOR 803-0165-236
N EA 1 4 1

260394820 CABLE CONNECTOR 803-0185-235
N EA 1 4 1

260394838 CABLE CONNECTOR 803-0185-236
N EA 1 4 1

260394846 CABLE CONNECTOR 803-0200-235
N EA 1 4 1

260394853 CABLE CONNECTOR 803-0200-236
N EA 1 4 1

260394911 CABLE CONNECTOR 807-0075-115
N EA 1 4 1

260394747 CABLE CONNECTOR 808-0050-100
N EA 1 4 1

260405188 CABLE CONNECTOR A25BS2 100FT SE
1969402 1 EA IL IN MI OH WI
09
AT&T cable only.

260405196 CABLE CONNECTOR A25DSA 80FT SE
1969410 1 EA IL IN MI OH WI
09

NETWORK SERVICES

TOOLS

BUILDING JANITORIAL

AUTOMOTIVE

FORMS/OFFICE SUPPLIES

GENERAL

DATA VOICE

CABLE DATA

840531669 CABLE DATA ASSEMBLY 840531669
N EA 1 8 1

840531677 CABLE DATA ASSEMBLY 840531677
N EA 1 2 1

840531685 CABLE DATA ASSEMBLY 840531685
N EA 1 2 1

840896450 CABLE DATA ASSEMBLY 840896450
N EA 1 2 1

840945703 CABLE DATA ASSEMBLY 840945703
N EA 1 2 1

840945711 CABLE DATA ASSEMBLY 840945711
N EA 1 2 1

840949853 CABLE DATA ASSEMBLY 840949853
N EA 1 8 1

841598675 CABLE DATA ASSEMBLY 841598675
N EA 1 2 1

841598709 CABLE DATA ASSEMBLY 841598709
N EA 1 2 1

PRODUCT IDENTIFIER DESCRIPTION

ITEM NUMBER	ORD. MULT.	SELL UNIT	STD. PKG. STOCK AVAILABILITY / PA	LEAD TIME	MIN. ORD.	A C
-------------	------------	-----------	-----------------------------------	-----------	-----------	-----

841832769 CABLE DATA ASSEMBLY 841832769
N EA 1 8 1

841833460 CABLE DATA ASSEMBLY 841833460
N EA 1 8 1

842725111 CABLE DATA ASSEMBLY 842725111
N EA 1 10 1

842732265 CABLE DATA ASSEMBLY 842732265
N EA 1 2 1

CAGE CARD

300071271 CAGE CARD 23IN 12 POSITION VERTICAL
1953794 1 EA

CAM

260381389 CAM L-502525-1
N EA 1 12 1

811110394 CAM NORMAL POST DOUBLE
N EA 1 1 1

CAP

843080300 CAP 843080300
N EA 1 9 1

996833083 CAP CK20085 L 7
N EA 1 2 1
ITE TEC310.

996833000 CAP CK20085 L 8
N EA 1 2 1
ITE PEP250.

101948784 CAP LAMP 79B
N EA 1 1 1

260380282 CAP TERMINAL WIRE-WRAP 545-1137
N EA 100 1 100

CAPACITOR

100026798 CAPACITOR 40BA
1124867 1 EA
Consists of four 442B capacitors mounted in two groups. Used to protect subscribers against radio interference, standard package 12, BSP 501-130-100, BSP 500-150-100.

101866523 CAPACITOR 437E MYLAR
N EA 1 6 1

260441399 CAPACITOR 437QA
N EA 1 2 1

PRODUCT IDENTIFIER		DESCRIPTION					
ITEM NUMBER	ORD. MULT.	SELL UNIT	STD. PKG. STOCK AVAILABILITY / PA	LEAD TIME	MIN. ORD.	A	C
260382486		CAPACITOR	441M .05YF				
N		EA	1	6	1		
100046960		CAPACITOR	542F				
N		EA	1	6	1		
100046978		CAPACITOR	542G				
N		EA	1	6	1		
100047018		CAPACITOR	542L				
N		EA	1	1	1		
100056126		CAPACITOR	602A				
N		EA	1	13	1		
100056399		CAPACITOR	610A				
N		EA	1	13	1		
997640669		CAPACITOR	CK13814 L2 .01UF				
1125369	1	EA	IL IN MI OH WI 09 09 09 09 09				
150 Volt .4375IN D .8125IN L Fixed/Polyester Non-Polarized.							
997432414		CAPACITOR	CK14595 1000UF				
1140251	1	EA	IL IN MI OH WI 09 09 09 09 09				
Provides a low impedance path across the insulating joint in lead or plastic sheath, BSP 633-320-201, BSP 633-320-202.							
260440698		CAPACITOR	CK14980 L26				
N		EA	1	2	1		
997431531		CAPACITOR	CK19292 L 1 3500UF				
N		EA	1	1	1		
260440706		CAPACITOR	CK20133 L90				
N		EA	1	2	1		
260367560		CAPACITOR	CK20133 L92				
N		EA	1	2	1		
260440714		CAPACITOR	CK20443 L49				
N		EA	1	2	1		
260440730		CAPACITOR	CK22663 L1				
N		EA	1	2	1		
260440722		CAPACITOR	CK22663 L2				
N		EA	1	2	1		
997641543		CAPACITOR	.02UF CK13814 L7				
1125401	1	EA	IL IN MI OH WI 09 09 09 09 09				
Used in 147 amplifier.							
CAPSTAN							
401871215		CAPSTAN	L-502601-1 REF				
N		EA	1	1	1		
401871280		CAPSTAN	L-502610-1 DIAGRAM CP-11				
N		EA	1	1	1		

PRODUCT IDENTIFIER		DESCRIPTION					
ITEM NUMBER	ORD. MULT.	SELL UNIT	STD. PKG. STOCK AVAILABILITY / PA	LEAD TIME	MIN. ORD.	A	C
CARD							
260367099		CARD	7501-03 DC TRANSMISSION				
1969089	1	EA					
260384789		CARD	7501-03A DC TRANSMISSION				
1969071	1	EA	IL IN MI OH WI				
260418959		CARD	7501-15A 2WIRE AC/DC				
1973859	1	EA	IL IN MI OH WI 08				
For standard AC/DC pilot wire systems and/or DC trip systems, -24 VDC input power supply.							
260392733		CARD	ALARM CEAM				
N		EA	1	4	1		
260392741		CARD	FUSE ALARM CEAM-FA				
N		EA	1	4	1		
260442017		CARD	FUSE & ALARM 76251011				
N		EA	1	4	1		
280025545		CARD	ISOLATOR TELELINE 7501-04				
N		EA	1	4	1		
280025552		CARD	ISOLATOR TELELINE 7501-06A				
N		EA	1	4	1		
280011198		CARD	ISOLATOR TELELINE 7501-16A				
N		EA	1	4	1		
260341938		CARD	MASS STORAGE 20 MEG				
N		EA	1	17	1		
101267375		CARD	MEMORY 1A				
N		EA	1	2	1		
101267383		CARD	MEMORY 2A				
N		EA	1	2	1		
260392782		CARD	MONITOR CEMO				
N		EA	1	4	1		
260330840		CARD	MXA C91G32000				
N		EA	1	13	1		
260445085		CARD	ORDERWIRE BLANK				
N							
Used in LTS-21130D Terminal.							
260392832		CARD	PROCESSOR CEPP-S1				
N		EA	1	4	1		
260392840		CARD	PROCESSOR CEPR				
N		EA	1	4	1		
260392949		CARD	REDUNDANT 3500-112-I				
N		EA	1	4	1		
60IPM option.							

DISTRIBUTION SERVICES

NETWORK SERVICES

TOOLS

BUILDING JANITORIAL

AUTOMOTIVE

FORMS/OFFICE SUPPLIES

GENERAL

DATA VOICE

CARD

PRODUCT IDENTIFIER		DESCRIPTION						
ITEM	ORD.	SELL	STD. PKG.	LEAD TIME	MIN.	A		
NUMBER	MULT.	UNIT	STOCK AVAILABILITY / PA		ORD.	C		
260392758			CARD RELAY 3500-112 CEME-L1					
N		EA	1	4		1		
260392766			CARD RELAY 3500-112I CEME-L1T1					
N		EA	1	4		1		
260392964			CARD RELAY 3500-112-2FP					
N		EA	1	4		1		
260392774			CARD RELAY PULSE CEME-S4					
N		EA	1	4		1		
260392881			CARD RING CEWT-RP100H					
N		EA	1	4		1		
260392899			CARD RING GENERATOR CEWT-RP2324					
N		EA	1	4		1		
260392873			CARD RING GENERATOR CEWT-RP2324-H2					
N		EA	1	4		1		
260392816			CARD RING TONE MONITOR CEPM-S2R0					
N		EA	1	4		1		
260392824			CARD RING TONE MONITOR CEPM-S2R2					
N		EA	1	4		1		
260435094			CARD STREAKER HA16B6001J100					
1979542	1	EA	IL	IN	MI	OH	WI	
					09	09		
260418983			CARD SUPPLY POWER 115V AC 7501 34					
1973891	1	EA	IL	IN	MI	OH	WI	
					08			
Small capacity power supply card for 7501-27 shelf, 115V AC, -24V DC, 1 amp standby batteries.								
260418975			CARD SUPPLY POWER 130V DC 7501 35					
1973883	1	EA	IL	IN	MI	OH	WI	
					08			
Small capacity power supply card for 7501-27 shelf, 130V DC, -24V DC, no standby power.								
260392790			CARD SUPPLY POWER CEOP-H1					
N		EA	1	4		1		
260445093			CARD TELEMETRY BLANK					
N			Used in LTS-21130D Terminal.					
260382445			CARD TIMER MEMORY LC262C					
N		EA	1	4		1		
260382437			CARD TIMER MEMORY LC268					
N		EA	1	4		1		
260392865			CARD TONE AMPLIFIER CETA					
N		EA	1	4		1		
260392857			CARD TONE GENERATOR CEPT-S1					
N		EA	1	4		1		
260392907			CARD TONE TRANSFORMER CEXF-S1					
N		EA	1	4		1		

PRODUCT IDENTIFIER		DESCRIPTION						
ITEM	ORD.	SELL	STD. PKG.	LEAD TIME	MIN.	A		
NUMBER	MULT.	UNIT	STOCK AVAILABILITY / PA		ORD.	C		
CARD FILE								
SEE FILE CARD.								
CASE								
260961370			CASE WESCOM 12D					
1233940	1	EA						
CASE APPARATUS								
300038700			CASE APPARATUS 263A L5					
N		EA	1	1		1		
402661912			CASE APPARATUS 1911					
N		EA	1	4		1		
300030095			CASE APPARATUS 1913					
N		EA	1	4		1		
300030103			CASE APPARATUS 1913 WIR PER 92-0303					
N		EA	1	1		1		
CASE CARRYING								
300055027			CASE CARRYING SLC-96 PRO POTS					
N		EA	1	5		1		
300055035			CASE CARRYING SLC-96 PRO SP SV					
N		EA	1	5		1		
260441571			CASE REPEATER 819B2					
N		EA	1	4		1		
CHANNEL								
843080367			CHANNEL 843080367					
N		EA	1	10		1		
843080292			CHANNEL COVER					
N		EA	1	9		1		
840048755			CHANNEL TRACK					
N		EA	1	10		1		
CHANNEL SERVICE UNIT								
SEE UNIT.								
CHART								
260345616			CHART POWER FLOOR 1 ROW					
N		EA	1	6		200		
260345608			CHART POWER FLOOR 2 ROW					
N		EA	1	6		200		

DISTRIBUTION SERVICES
 NETWORK SERVICES
 TOOLS
 BUILDING JANITORIAL
 AUTOMOTIVE
 FORMS/OFFICE SUPPLIES
 GENERAL
 DATA VOICE

PRODUCT IDENTIFIER		DESCRIPTION				
ITEM NUMBER	ORD. MULT.	SELL UNIT	STD. PKG. STOCK AVAILABILITY / PA	LEAD TIME	MIN. ORD.	A C
260345590			CHART POWER FLOOR 4 ROW			
N		EA	1	6	200	

PRODUCT IDENTIFIER		DESCRIPTION				
ITEM NUMBER	ORD. MULT.	SELL UNIT	STD. PKG. STOCK AVAILABILITY / PA	LEAD TIME	MIN. ORD.	A C
400949772			CLEANER TAPE ASSEMBLY L502061			
N		EA	1	4	1	
For CK20017 L 3.						

CHASSIS

260413315			CHASSIS UNLOADED DSX-4H-W3C			
1971317	1	EA	24 circuit, 23in.			

CLIP

401853643			CLIP INSULATOR H CA08860			
N		PK	1	13	25	
Package of 100.						

CHIP

405023052			CHIP SET 512K			
N		EA	1	4	1	

402510622			CLIP LOCK B CA08950			
1217380	1	PK	IL IN MI OH WI	08 08 08 08		
Package of 10.						

CIRCUIT

260367248			CIRCUIT 4 WIRE AC DATA 7501-53			
N		EA	1	11	1	
260382338			CIRCUIT BOARD PRINTED ASSEMBLY A1			
N		EA	1	14	1	
KS20816 L201						
260380381			CIRCUIT BREAKER 4835-815			
N		EA	1	8	1	
260380431			CIRCUIT BREAKER 4863-825			
N		EA	1	8	1	
102719333			CIRCUIT INTEGRATED 146C			
N		EA	1	13	25	
102853934			CIRCUIT INTEGRATED 559C			
N		EA	1	2	1	

CLOCK

897821093			CLOCK CK19049 L2			
N		EA	1	5	1	

CIRCUIT PACK

SEE PACK CIRCUIT.

CLOTH

260395538			CLOTH POLISHING W/CLEANING AGENT			
1966903	1	EA				
Used to clean 310 plugs, connectors, relays, patch cords, headsets, mics, and switchboard connections in Central Offices.						

CLAMP

840801997			CLAMP ASSEMBLY			
N		EA	1	14	1	
841884364			CLAMP CONNECTOR			
N		EA	1	14	1	
804490233			CLAMP CORK HOOK D449023			
N		EA	1	8	1	

COIL HEAT

100106822			COIL HEAT 40			
N		EA	1	1	1	
100106830			COIL HEAT 72A M/D			
N		EA	1	3	1	
Used as insulating dummy heat coil for marking lines temporarily opened at the main distributing frame in common battery central offices. Package of 500. MANUFACTURER DISCONTINUED.						
100106848			COIL HEAT 74A			
N		EA	1	10	1	
100106780			COIL HEAT 75A			
N		EA	1	1	1	

CLEANER

280011248			CLEANER CONNECTOR ULTRA JET 13034			
N		CS	1	4	1	
Case of 12.						
260386891			CLEANER MAGNETIC TAPE HEAD FS200			
N		EA	12	5	12	

100106798			COIL HEAT 76A BLACK SHELL			
1131524	1	EA	IL IN MI OH WI	08 08 08 08 08		
Used on main frames for lines requiring protection. When operated, grounds line.						

100106806			COIL HEAT 77A1			
N		EA	1	6	1	
100999143			COIL HEAT 80A			
N		EA	1	2	1	
101752731			COIL HEAT 81A			
N		EA	1	14	1	

COIL REPEATING

PRODUCT IDENTIFIER		DESCRIPTION					
ITEM NUMBER	ORD. MULT.	SELL UNIT	STD. PKG. STOCK AVAILABILITY / PA	LEAD TIME	MIN. ORD.	A	C

COIL REPEATING

100107812			COIL REPEATING 94E				
N		EA	1	10	1		

100108166			COIL REPEATING 111C				
1139790	1	EA	IL 09 IN 09 MI OH WI 09				
For use with the regulating and non-regulating repeaters for program transmissions over long 16 gauge cable circuits equipped B22 loading, BSP 320-145-501.							

COMPENSATOR

260324108			COMPENSATOR IMPEDENCE W/SLOPE CORRECTION				
1944512	1	EA	Active slope equalizer, ASE, L1.				

COMPRESSION SPRING

996973160			COMPRESSION SPRING LC 032 C7				
N		EA	1	13	1		

CONDENSER

260380654			CONDENSER MICROPHONE YM31				
N		EA	1	3	1		

CONDUCTOR

841633779			CONDUCTOR STRAP 841633779				
N		EA	1	15	1		

841633787			CONDUCTOR STRAP 841633787				
N		EA	1	15	1		

841633795			CONDUCTOR STRAP 841633795				
N		EA	1	15	1		

841633803			CONDUCTOR STRAP 841633803				
N		EA	1	15	1		

CONNECTOR

260436563			CONNECTOR 20 AMP AC 3-PRONG 5369C				
N		EA	1	2	10		

842367823			CONNECTOR 3 BEAM				
N		EA	1	9	1		

101642817			CONNECTOR 302A1 -100 30FT STUB				
N		EA	1	1	1		

101642825			CONNECTOR 302A1 -100 50FT STUB				
N		EA	1	1	1		

PRODUCT IDENTIFIER		DESCRIPTION					
ITEM NUMBER	ORD. MULT.	SELL UNIT	STD. PKG. STOCK AVAILABILITY / PA	LEAD TIME	MIN. ORD.	A	C

101642841			CONNECTOR 302A1 -100 100FT STUB				
N		EA	1	1	1		

102759826			CONNECTOR 302A1 -100 150FT STUB				
N		EA	1	1	1		

103904728			CONNECTOR 302A4 -100 50FT STUB				
N		EA	1	1	1		

103904736			CONNECTOR 302A4 -100 80FT STUB				
N		EA	1	5	1		

103904744			CONNECTOR 302A4 -100 100FT STUB				
N		EA	1	1	1		

101642874			CONNECTOR 302B1 -100 80FT STUB				
N		EA	1	1	1		

101642882			CONNECTOR 302B1 -100 100FT STUB				
N		EA	1	1	1		

103904777			CONNECTOR 302B4 -100 50FT STUB				
N		EA	1	9	1		

103904793			CONNECTOR 302B4 -100 100FT STUB				
N		EA	1	9	1		

102861614			CONNECTOR 302E1 -100 LESS STUB				
N		EA	1	1	1		

103046074			CONNECTOR 302E3 -100 LESS STUB				
N		EA	1	1	1		

103760815			CONNECTOR 303A4 -100 30FT STUB				
N		EA	1	1	1		

103900023			CONNECTOR 303A4 -100 50FT STUB				
6500876	1	EA	IL 08 IN 08 MI 08 OH 08 WI 08				
Used to terminate outside cable pairs in a Central Office.							

103900031			CONNECTOR 303A4 -100 80FT STUB				
N		EA	1	1	1		

103900049			CONNECTOR 303A4 -100 100FT STUB				
N		EA	1	1	1		

103900056			CONNECTOR 303A4 -100 150FT STUB				
N		EA	1	1	1		

103047825			CONNECTOR 303B3 - 50 30FT STUB				
N		EA	1	1	1		

103047833			CONNECTOR 303B3 - 50 50FT STUB				
N		EA	1	6	1		

260382460			CONNECTOR 303B3 - 50 80FT STUB				
N		EA	1	5	1		

102869385			CONNECTOR 303B3 - 50 250FT STUB				
N		EA	1	9	1		

DISTRIBUTION SERVICES

NETWORK SERVICES

TOOLS

BUILDING JANITORIAL

AUTOMOTIVE

FORMS/OFFICE SUPPLIES

GENERAL

DATA VOICE

DISTRIBUTION
SERVICESNETWORK
SERVICES

TOOLS

BUILDING
JANITORIAL

AUTOMOTIVE

FORMS/OFFICE
SUPPLIES

GENERAL

DATA
VOICE

PRODUCT IDENTIFIER		DESCRIPTION						
ITEM NUMBER	ORD. MULT.	SELL UNIT	STD. PKG. STOCK AVAILABILITY / PA	LEAD TIME			MIN. ORD.	A C
103760823 CONNECTOR 303B4 -100 30FT STUB								
4200279	1	EA	IL IN MI OH WI 08 08 08 08 08					
Unit protector 4A5C.								
103900072 CONNECTOR 303B4 -100 50FT STUB								
6500884	1	EA	IL IN MI OH WI 08 08 08 08 08					
103900080 CONNECTOR 303B4 -100 80FT STUB								
N		EA	1	1				1
103900098 CONNECTOR 303B4 -100 100FT STUB								
N		EA	1	1				1
103900106 CONNECTOR 303B4 -100 150FT STUB								
N		EA	1	1				1
103048005 CONNECTOR 303D3 -100 100FT STUB								
N		EA	1	1				1
103046132 CONNECTOR 303E3 -100 LESS STUB								
1973966	1	EA	IL IN MI OH WI 03 03					
Electrical connector.								
102816014 CONNECTOR 305C1 -100 30FT STUB								
N		EA	1	9				1
102816022 CONNECTOR 305C1 -100 50FT STUB								
N		EA	1	9				1
102816030 CONNECTOR 305C1 -100 80FT STUB								
N		EA	1	9				1
102816071 CONNECTOR 305D1 -100 30FT STUB								
N		EA	1	9				1
260427810 CONNECTOR 307C2 - 100 30FT								
1977710	1	EA	IL IN MI OH WI 08 08 08 08 08					
260419031 CONNECTOR 307C2 -100								
1973941	1	EA	IL IN MI OH WI					
103835120 CONNECTOR 307C2 -100 LESS STUB								
1136358	1	EA	IL IN MI OH WI 09 09 09 09 09					
Electrical connector.								
103318309 CONNECTOR 307D1 -100 LESS STUB								
N		EA	1	1				1
103111837 CONNECTOR 308A1 -100 50FT STUB								
N		EA	1	1				1
103111845 CONNECTOR 308A1 -100 80FT STUB								
N		EA	1	1				1
103111852 CONNECTOR 308A1 -100 100FT STUB								
N		EA	1	1				1
103111878 CONNECTOR 308A1 -100 200FT STUB								
N		EA	1	1				1

PRODUCT IDENTIFIER		DESCRIPTION						
ITEM NUMBER	ORD. MULT.	SELL UNIT	STD. PKG. STOCK AVAILABILITY / PA	LEAD TIME			MIN. ORD.	A C
103111910 CONNECTOR 308B1 -100 100FT STUB								
N		EA	1	5				1
103550679 CONNECTOR 308E1 -100								
N		EA	1	1				1
103283503 CONNECTOR 308E2 -100								
N		EA	1	1				1
104407309 CONNECTOR 310A1 -100 30FT STUB MTB								
N		EA	1	9				1
105267454 CONNECTOR 310A1 -100 50FT STUB M								
N		EA	1	3				1
105314371 CONNECTOR 310A1 -100 50FT STUB MBW								
N		EA	1	1				1
105267470 CONNECTOR 310A1 -100 100FT STUB M								
N		EA	1	1				1
103760872 CONNECTOR 310A2 -100 30FT STUB								
N		EA	1	1				1
103868972 CONNECTOR 310A2 -100 50FT STUB								
N		EA	1	1				1
NOW AVAILABLE THROUGH TOUCH-TONE ORDER ENTRY.								
103868980 CONNECTOR 310A2 -100 80FT STUB								
N		EA	1	1				1
260383419 CONNECTOR 310A2 -100 80FT STUB								
N		EA	1	1				1
103868998 CONNECTOR 310A2 -100 100FT STUB								
N		EA	1	1				1
103869004 CONNECTOR 310A2 -100 150FT STUB								
N		EA	1	1				1
103725339 CONNECTOR 310B1 - 50 50FT STUB								
N		EA	1	9				1
103725354 CONNECTOR 310B1 - 50 100FT STUB								
N		EA	1	9				1
104287305 CONNECTOR 310B1 -100 50FT STUB BW								
N		EA	1	9				1
105267504 CONNECTOR 310B1 -100 50FT STUB M								
N		EA	1	9				1
103760880 CONNECTOR 310B2 -100 30FT STUB								
N		EA	1	1				1
103869020 CONNECTOR 310B2 -100 50FT STUB								
N		EA	1	1				1
103869038 CONNECTOR 310B2 -100 80FT STUB								
N		EA	1	1				1

CONNECTOR

PRODUCT IDENTIFIER		DESCRIPTION					
ITEM NUMBER	ORD. MULT.	SELL UNIT	STD. PKG. STOCK AVAILABILITY / PA	LEAD TIME	MIN. ORD.	A C	
103869046		CONNECTOR	310B2 -100	100FT STUB			
N		EA	1	1	1		
103869053		CONNECTOR	310B2 -100	150FT STUB			
N		EA	1	1	1		
103623476		CONNECTOR	310C1 -100	100FT STUB			
N		EA	1	1	1		
103623500		CONNECTOR	310D1 -100	50FT STUB			
N		EA	1	1	1		
103551867		CONNECTOR	310E1 -100	NS ELECTRICAL			
1973974	1	EA	IL IN MI OH WI 08				
104401575		CONNECTOR	310MA1-100	30FT STUB			
N		EA	1	1	1		
105267488		CONNECTOR	310MA1-100	150FT STUB			
N		EA	1	1	1		
260381801		CONNECTOR	310MB1-100	80FT STUB			
N		EA	1	1	1		
105267520		CONNECTOR	310MB1-100	100FT STUB			
N		EA	1	1	1		
104401591		CONNECTOR	310ME1-100				
N		EA	1	1	1		
105356596		CONNECTOR	311A1 -100	50FT STUB			
N		EA	1	5	1		
105356646		CONNECTOR	311B1 -100	50FT STUB			
N		EA	1	5	1		
260376017		CONNECTOR	503 PN22075				
N		EA	1	8	1		
260375993		CONNECTOR	503 PN2480D				
N		EA	1	6	1		
100115401		CONNECTOR	905B				
N		EA	4	2	1		
100115567		CONNECTOR	912A				
N		EA	1	1	1		
260381132		CONNECTOR	931A				
N		EA	1	11	1		
102607728		CONNECTOR	950C				
N		EA	1	14	1		
102434958		CONNECTOR	959A				
N		EA	1	14	1		
102434966		CONNECTOR	959B				
N		EA	1	14	1		
102814456		CONNECTOR	977B				
N		EA	1	10	1		

PRODUCT IDENTIFIER		DESCRIPTION					
ITEM NUMBER	ORD. MULT.	SELL UNIT	STD. PKG. STOCK AVAILABILITY / PA	LEAD TIME	MIN. ORD.	A C	
102814472		CONNECTOR	977D				
N		EA	1	14	1		
260980941		CONNECTOR	982CF BULK				
N		EA	1	13	1		
			For Lightguide Transmitter. Dimensions A - 1,750IN. B - 1,475IN.				
260980958		CONNECTOR	982CG BULK				
N		EA	1	13	1		
			For Lightguide Cable. Dimensions A - 1,750IN. B - 1,475IN.				
260979554		CONNECTOR	982FH BULK				
N		EA	1	2	1		
841628381		CONNECTOR ASSEMBLY	FRAME GROUND				
N		EA	1	14	1		
841221823		CONNECTOR	BLOCK				
N		EA	1	12	1		
260436662		CONNECTOR	BLUE 1327G8				
N		EA	1	2	1		
260386818		CONNECTOR	BULKHEAD FEED-THRU BNC B083				
N		EA	1	3	1		
			Female to female, two lug TRC bayonet.				
260422589		CONNECTOR	C TAP BLUE				
1976100	1	EA	IL IN MI OH WI 08				
260395496		CONNECTOR	C TAP GRAY 54715				
1976092	1	EA	IL IN MI OH WI 08				
			NOW AVAILABLE THROUGH TOUCH-TONE ORDER ENTRY.				
400685426		CONNECTOR	CK05537 L 270				
N		EA	1	13	1		
400687042		CONNECTOR	CK05537 L 276				
N		EA	1	2	1		
997082318		CONNECTOR	CK14671 L 2				
N		EA	1	1	1		
997082789		CONNECTOR	CK14672 L 2				
N		EA	1	1	1		
996586640		CONNECTOR	CK15977 L 41				
N		EA	1	3	1		
995082575		CONNECTOR	CK15977 L 63				
N		EA	1	3	1		
995082930		CONNECTOR	CK15977 L 302				
N		EA	1	3	1		
995084787		CONNECTOR	CK15977 L 325				
N		EA	1	3	1		
406338400		CONNECTOR	CK15977L 43				
N		EA	1	3	1		

DISTRIBUTION SERVICES
 NETWORK SERVICES
 TOOLS
 BUILDING JANITORIAL
 AUTOMOTIVE
 FORMS/OFFICE SUPPLIES
 GENERAL
 DATA VOICE

PRODUCT IDENTIFIER DESCRIPTION

ITEM NUMBER	ORD. MULT.	SELL UNIT	STD. PKG. STOCK AVAILABILITY / PA	LEAD TIME	MIN. ORD.	A C
-------------	------------	-----------	-----------------------------------	-----------	-----------	-----

401021217 CONNECTOR CK20863 L 11
N EA 1 4 1

402210959 CONNECTOR CK21479 L7
N EA 1 13 1

401815485 CONNECTOR CK21500 L 11
N EA 1 1 1

842936130 CONNECTOR INSERT
N EA 1 11 1

280017252 CONNECTOR MINI JUMP BERG 65771-001
N EA 500 2 500
Capstone Electronics, 500 per bag.

260436654 CONNECTOR POWER POLE 1452G3
N EA 1 2 1

260436670 CONNECTOR RED 1327
N EA 1 2 1

260435813 CONNECTOR SLOT FILL-PAN
1980300 1 EA IL IN MI OH WI
09 09 09 09 09
Block cover AT9059B. Used to cover splices and blank 307 block positions on the AT9049B, C, & D protector & cable enclosures. Used w/SLC96 & Series 5 in various huts & cabinets.

104148028 CONNECTOR COUPLING C-2000A-2
1965806 1 EA IL IN MI OH WI
09

CONSOLE

260330824 CONSOLE ENHANCED POSITION B93G36200
N EA 1 2 1

260330816 CONSOLE SUPERVISOR B93G36300
N EA 1 4 1

CONTACTOR

841068778 CONTACTOR 841068778 SINGLE
N EA 1 2 1

997783394 CONTACTOR CK19598 L 2
N EA 1 13 1

401808357 CONTACTOR CK21677 L 2 AC
N EA 1 3 1
Eaton Corp Milwaukee, WI C30DNY1BB sub for C30DNY1B.

401808365 CONTACTOR CK21677 L 3
N EA 1 4 1

PRODUCT IDENTIFIER DESCRIPTION

ITEM NUMBER	ORD. MULT.	SELL UNIT	STD. PKG. STOCK AVAILABILITY / PA	LEAD TIME	MIN. ORD.	A C
-------------	------------	-----------	-----------------------------------	-----------	-----------	-----

CONTROLLER

260429444 CONTROLLER 1174-60R-WBT CONFIGURATION
N EA 1 2 1
For Wisconsin Bell Central Office Modernization Project only.

260429436 CONTROLLER 1174-90R-WBT CONFIGURATION
N EA 1 2 1
For Wisconsin Bell Central Office Modernization Project only.

250011871 CONTROLLER 40C303/AD
N

260417134 CONTROLLER BANK HA15B-0001-C065
1972273 1 EA IL IN MI OH WI
09 09 09 09

260435979 CONTROLLER NT6C25FA
1980466 1 EA IL IN MI OH WI
09 09 09 09 09
Font access controller 25A-500 plant.

260440540 CONTROLLER NT6C25FB
N EA 1 4 1

CONVERTER

103630463 CONVERTER 1A-50
1311100 1 EA
Used to adapt D4BU mounting cord to 404B, 493A, 548A and 549A jacks, 4 pin, BSP 503-100-100.

280016122 CONVERTER AC/DC 11-6403-00
N EA 1 2 1

280025941 CONVERTER ASC-2 1319723
N EA 1 2 1

402615249 CONVERTER CK22434 L1
N EA 1 6 1
REPLACEMENT FOR 401148051

260393020 CONVERTER DC/DC 3500-272
N EA 1 4 1

260404777 CONVERTER LEVEL HA15B-0001-B034 ASSEMBLY
1969170 1 EA IL IN MI OH WI
09 09 09 09

260404843 CONVERTER LEVEL HA15B-0001-B046 ASSEMBLY
1969246 1 EA IL IN MI OH WI
09 09 09 09

260402862 CONVERTER LEVEL HA15B-0001-B047
1968552 1 EA IL IN MI OH WI
09 09 09 09

CONVERTER

PRODUCT IDENTIFIER		DESCRIPTION						
ITEM NUMBER	ORD. MULT.	SELL UNIT	STD. PKG. STOCK AVAILABILITY / PA	LEAD TIME			MIN. ORD.	A C
260431614 CONVERTER LEVEL HA15B-0001-B077								
1979252	1	EA	IL IN MI OH WI 09 09 09 09					
260417126 CONVERTER LEVEL HA15B-0001-C068								
1972265	1	EA	IL IN MI OH WI 09 09 09 09					
260384565 CONVERTER LEVEL LC2R FC9604L2R1								
1962530	1	EA	IL IN MI OH WI 09 09 09 09					
To be used for assembly into Fujitsu 6200 cabinet.								

PRODUCT IDENTIFIER		DESCRIPTION						
ITEM NUMBER	ORD. MULT.	SELL UNIT	STD. PKG. STOCK AVAILABILITY / PA	LEAD TIME			MIN. ORD.	A C
260413372 CORD CROSS-CONNECT DSX4MCJB 10								
1971374	1	EA	IL IN MI OH WI 09 09 09 09	10ft BNC connector.				
260413380 CORD CROSS-CONNECT DSX4MCJB 12								
1971382	1	EA	IL IN MI OH WI 09 09 09 09	12ft BNC connector.				
280079906 CORD CROSS-CONNECT DSX4MCJBM 1								
1936310	1	EA	IL IN MI OH WI 04 04 04 04					

CORD

402316293 CORD CK21161 L4 6IN								
N		EA	1		11			1
402316079 CORD CK21161 L5								
N		EA	1		8			1

300095957 CORD ADAPTER 8/50 PIN 71021200								
5126854	1	EA	IL IN MI OH WI 39 39					

300095940 CORD ADAPTER RJ11 8 PIN 71021100								
5126862	1	EA	IL IN MI OH WI 39 39					

996326302 CORD CK14532 L20 10FT								
N		EA	1		8			10
Used in conjunction with Panel Power 1A1 (1178616).								

401957576 CORD CK16935 L30 24FT								
N		EA	1		8			10
Used in conjunction with Panel Power 1A1 (1168616).								

100150895 CORD COAXIAL P2AW 6								
N		EA	1		8			1

260383450 CORD MODULE TEST POINT 508-32-3835								
N		EA	1		3			1

260330832 CORD PSL 120 VAL A91G32500								
N		EA	1		13			1

260382668 CORD SIGNAL TPI-108-2								
N		EA	1		1			1

260342100 CORD TERMINATOR X/Y BUS								
N		EA	1		17			1

CORD CROSS CONNECT

260413364 CORD CROSS-CONNECT DSX4MCJB 6								
1971366	1	EA	6ft BNC connector.					

CORD CROSS-CONNECT DSX4MCJBM 2

1936328	1	EA	IL IN MI OH WI 09 09 09 09					
---------	---	----	-------------------------------	--	--	--	--	--

280079930 CORD CROSS-CONNECT DSX4MCJBM 3
1936336 4 EA IL IN MI OH WI
09 09 09 09
Patch cord for DSX, DS3 rate 6ft long. Used for turn up and to bypass lightguide failure at DSX.

280079922 CORD CROSS-CONNECT DSX4MCJBM 4								
1936344	4	EA	IL IN MI OH WI 09 09 09 09					

280079948 CORD CROSS-CONNECT DSX4MCJBM 6								
1936351	4	EA	IL IN MI OH WI 09 09 09 09					

280079955 CORD CROSS-CONNECT DSX4MCJBM 8								
1936369	4	EA	IL IN MI OH WI 09 09 09 09					

280079963 CORD CROSS-CONNECT DSX4MCJBM10								
1936377	4	EA	IL IN MI OH WI 09 09 09 09					

280079971 CORD CROSS-CONNECT DSX4MCJBM12								
1936385	1	EA	IL IN MI OH WI 09 09 09 09					

280079989 CORD CROSS-CONNECT DSX4MCJBM14								
1936393	1	EA	IL IN MI OH WI 09 09 09 09					

280079997 CORD CROSS-CONNECT DSX4MCJBM16								
1936401	1	EA	IL IN MI OH WI 09 09 09 09					

280080003 CORD CROSS-CONNECT DSX4MCJBM18								
1936419	1	EA	IL IN MI OH WI 09 09 09 09					

280080011 CORD CROSS-CONNECT DSX4MCJBM20								
1936427	1	EA	IL IN MI OH WI 09 09 09 09					

280080029 CORD CROSS-CONNECT DSX4MCJBM22								
1936435	1	EA	IL IN MI OH WI 09 09 09 18					

DISTRIBUTION SERVICES

NETWORK SERVICES

TOOLS

BUILDING JANITORIAL

AUTOMOTIVE

FORMS/OFFICE SUPPLIES

GENERAL

DATA VOICE

DISTRIBUTION SERVICES

NETWORK SERVICES

TOOLS

BUILDING JANITORIAL

AUTOMOTIVE

FORMS/OFFICE SUPPLIES

GENERAL

DATA VOICE

PRODUCT IDENTIFIER		DESCRIPTION						
ITEM NUMBER	ORD. MULT.	SELL UNIT	STD. PKG. STOCK AVAILABILITY / PA	LEAD TIME			MIN. ORD.	A C
280080037 CORD CROSS-CONNECT DSX4MCJBM24								
1936443	1	EA	IL IN MI OH WI 09 09 09 09					
280080045 CORD CROSS-CONNECT DSX4MCJBM26								
1936450	1	EA	IL IN MI OH WI 09 09 09 09					
280080052 CORD CROSS-CONNECT DSX4MCJBM27								
1936468	1	EA	IL IN MI OH WI 09 09 09 09					
260331657 CORD CROSS-CONNECT DSX4MCJBM30								
1947390	1	EA	IL IN MI OH WI 09 09 09 09					
Coax Cross Connect Cord for DSX 3 or 4 Rear Cross Connect Module, BNC Conn E/W Messenger Wire, 30ft long.								
260331665 CORD CROSS-CONNECT DSX4MCJBM35								
1947408	1	EA	IL IN MI OH WI 09 09 09 09					
Coax Cross Connect Cord for DSX 3 or 4 Rear Cross Connect Module, BNC Conn E/W Messenger Wire, 35ft long.								
260331673 CORD CROSS-CONNECT DSX4MCJBM40								
1947416	1	EA	IL IN MI OH WI 09 09 09 09					
Coax Cross Connect Cord for DSX 3 or 4 Rear Cross Connect Module, BNC Conn E/W Messenger Wire, 40ft long.								
260423413 CORD CROSS-CONNECT MINI COAX								
1976043	1	EA	IL IN MI OH WI 09 09 09 09					
W/BNC 6FT.								
260423405 CORD CROSS-CONNECT MINI COAX 6FT								
1976050	1	EA	IL IN MI OH WI 09 09 09 09					
With BNC and trace.								

CORK RUBBER

402948970	CORK RUBBER CK05499	N	EA	1	5	1
-----------	---------------------	---	----	---	---	---

COUPLING

997938550	COUPLING CK20085 L 6 ITE TC310	N	EA	1	11	1
-----------	--------------------------------	---	----	---	----	---

COVER

840035604	COVER 840035604	N	EA	1	8	1
840215750	COVER 840215750	N	EA	1	9	1
For 303 type Connector.						
842781437	COVER 842781437	N	EA	1	2	1

COVER

PRODUCT IDENTIFIER		DESCRIPTION						
ITEM NUMBER	ORD. MULT.	SELL UNIT	STD. PKG. STOCK AVAILABILITY / PA	LEAD TIME			MIN. ORD.	A C

843049669	COVER 843049669	N	EA	1	8	1
843049768	COVER 843049768	N	EA	1	10	1
843049776	COVER 843049776	N	EA	1	10	1
843049859	COVER 843049859 DUCT END	N	EA	1	1	1
843062001	COVER 843062001	N	EA	1	14	1
843080235	COVER 843080235	N	EA	1	14	1
843080375	COVER 843080375	N	EA	1	10	1
843080425	COVER 843080425 END	N	EA	1	10	1
843080656	COVER 843080656	N	EA	1	14	1
843080797	COVER 843080797	N	EA	1	10	1
843080805	COVER 843080805	N	EA	1	14	1
843080813	COVER 843080813	N	EA	1	14	1
843080821	COVER 843080821	N	EA	1	10	1
843080839	COVER 843080839	N	EA	1	10	1
260386784	COVER BLOCK	N	EA	1	14	1
401808563	COVER BLOCK KS21652 L4	N	EA	1		1
402146427	COVER BLOCK KS21652 L5	N	EA	1		1
260384508 COVER SHELF FMT150D						
1963538	10 EA	IL IN MI OH WI 18 18 18 18 18				
260382304	COVER TRANSDUCER HOUSING	N	EA	1	2	1
Modified 6361-369.						

DISTRIBUTION SERVICES

NETWORK SERVICES

TOOLS

BUILDING JANITORIAL

AUTOMOTIVE

FORMS/OFFICE SUPPLIES

GENERAL

DATA VOICE

DETECTOR

PRODUCT IDENTIFIER		DESCRIPTION					
ITEM NUMBER	ORD. MULT.	SELL UNIT	STD. PKG. STOCK AVAILABILITY / PA	LEAD TIME	MIN. ORD.	A C	

DETECTOR

280019746 DETECTOR POWER 758-4685-015

N		EA	1	2	1	
---	--	----	---	---	---	--

DEVICE

260442207 DEVICE ISOLATION SINGLE CIRCUIT 751221

N		EA	1	3	1	
Positron (7501-52).						

DIE

260381165 DIE KS22214 L5

N		EA	1	4	1	
---	--	----	---	---	---	--

DIODE

100172733 DIODE 400 A

N		EA	1	1	1	
Point contact germanium rectifiers. Used in various telephone equipment, BSP 501-370-100.						

102248606 DIODE 525 A

N		EA	1	1	1	
---	--	----	---	---	---	--

260387253 DIODE 533 B

N		EA	1	2	1	
---	--	----	---	---	---	--

102594900 DIODE 533 E

5417527	1	EA	IL	IN	MI	OH	WI
			09	09	09	09	09

102649001 DIODE 533 F BULK PACKED

2677443	1	EA	IL	IN	MI	OH	WI
			09	09	09	09	09
Each consists of a silicon, diffused-junction diode encapsulated in an axially-leaded molded plastic package. Used with 402A and 404A KTU's and channel units of N carrier.							

102649019 DIODE 533 G BULK PACKED

5392944	1	EA	IL	IN	MI	OH	WI
			09	09	09	09	09

260380555 DIODE 534 D

N		EA	1	2	1	
---	--	----	---	---	---	--

102649027 DIODE 534 D BULK PACKED

N		EA	1	2	1	
---	--	----	---	---	---	--

102696796 DIODE 813 B

N		EA	1	1	1	
---	--	----	---	---	---	--

103245767 DIODE 840 A

8149708	1	EA	IL	IN	MI	OH	WI
			14	14	14	14	14
Matripax - insertable diode package provides fast, easy & convenient common audible diode arrangement. Eliminates time-consuming hand installation of diodes. Makes necessary cross-connection.							

PRODUCT IDENTIFIER		DESCRIPTION					
ITEM NUMBER	ORD. MULT.	SELL UNIT	STD. PKG. STOCK AVAILABILITY / PA	LEAD TIME	MIN. ORD.	A C	

300031937 DIODE ASSEMBLY D 4D

1332569	1	EA	IL	IN	MI	OH	WI
					08		08
To be used with single Battery U128A-SLC in conjunction with the Subscriber Loop Carrier Systems.							

280025644 DIODE BLOCKING CR22 0552721003

N		EA	1	2	1	
---	--	----	---	---	---	--

DISCONNECT

260405212 DISCONNECT LOW VOLT 8004-81-2507

1969436	1	EA	LVL D 48/25-23F.				
---------	---	----	------------------	--	--	--	--

DISK

260387311 DISK OS/2 STANDARD EDITION 1.2 OEIBM34

N		EA	1	2	1	
---	--	----	---	---	---	--

DISPLAY

601216211 DISPLAY NJ00514A1 L4A

N		EA	1	1	1	
---	--	----	---	---	---	--

DUCT

842186256 DUCT 842186256

N		EA	1	11	1	
---	--	----	---	----	---	--

843080284 DUCT 843080284 CHANNEL

N		EA	1	10	1	
---	--	----	---	----	---	--

843080417 DUCT 843080417 END

N		EA	1	10	1	
---	--	----	---	----	---	--

843080748 DUCT 843080748

N		EA	1	10	1	
---	--	----	---	----	---	--

843080755 DUCT 843080755

N		EA	1	10	1	
---	--	----	---	----	---	--

843080763 DUCT 843080763

N		EA	1	14	1	
---	--	----	---	----	---	--

843080771 DUCT 843080771

N		EA	1	10	1	
---	--	----	---	----	---	--

DUCT BUS

SEE BUS DUCT.

ED NUMBERED PARTS

260383377 ED1A480-30 G 3 BUS LOAD

N		EA	1	5	1	
Resistor Assembly.						

PRODUCT IDENTIFIER		DESCRIPTION				
ITEM NUMBER	ORD. MULT.	SELL UNIT	STD. PKG. STOCK AVAILABILITY / PA	LEAD TIME	MIN. ORD.	A C
260386719	N	EA	G25 25PR 16FT	1 3	1	
260386925	N	EA	ED2C829-30 KEY TUBULAR U/O	1 5	1	
600202006	N	EA	ED2H053-30 G 3 RING PWB ASSEMBLY	1 2	1	
600216584	N	EA	ED3C864-30 G 1/GA UNIT ALARM	1 2	1	
600032312	N	EA	ED51567-30 G 1 PROB ASM Y	25 8	25	
600127062	N	EA	ED51568-30 G 2 H PLT Y	25 8	25	
600033542	N	EA	ED63954-70 G 3 D RL ASM	2 6	2	
260383427	N	EA	ED6C136-30 G 2 GROUNDING KIT B	1 2	1	
260383369	N	EA	ED6C136-30 G 3 CABLE Rearrangement facility.	1 1	1	
600359731	1198010	EA	ED7C240-30 G 2 267068 PROTECTOR	IL IN MI OH WI 18 18 18		
601158025	1938332	EA	ED8C007-50 G 1 E/W G 5 & three G 10.	IL IN MI OH WI 18		
601158033	1938340	EA	ED8C008-50 G 1 E/W G 7 & six G 12.	IL IN MI OH WI 18		
600039028	N	EA	ED90097-31 G 1 PLT DET ASM	1 8	1	
600039101	N	EA	ED90273-70 G24 ADAPTER	1 2	1	
600017271	N	EA	ED90370-73 G 4 RELAY RACK	1 6	1	
600231591	N	EA	ED91689-10 D 5A JCT Y	10 2	10	
600041917	N	EA	ED92774-11 G 8 PR CA CONN	50 8	50	
600042287	N	EA	ED94859-40 G62 AP	1 8	1	
300062999	N	EA	ED97162-52 G 3 FRAME 7FT 10IN E/W G43, G61, G16, G19 G16-G19 frame 7ft.	1 26	1	

PRODUCT IDENTIFIER		DESCRIPTION				
ITEM NUMBER	ORD. MULT.	SELL UNIT	STD. PKG. STOCK AVAILABILITY / PA	LEAD TIME	MIN. ORD.	A C
260309000	1940825	EA	ED97162-53 G 3 099999	IL IN MI OH WI 18		
600251516	N	EA	ED97986-30 G 1	1 2	1	
600049384	N	EA	ED99654-30 G 1	9 17	1	
ELECTRON TUBE						
SEE TUBE ELECTRON.						
ENCLOSURE						
260413497	1971630	EA	ENCLOSURE 97061 VOICE COUPLER	Keptel/Comfab, used to house dial page test circuits associated with IBT #5 ESS Switch.		
403249147	1151910	EA	ENCLOSURE CABLE 099999 PROTECTOR	IL IN MI OH WI 08 08		
260966684	1241653	EA	ENCLOSURE DE-1	IL IN MI OH WI		
260380258	1973603	EA	ENCLOSURE IB48 BATTERY STAND	IL IN MI OH WI 09		
EQUALIZER						
996956108	1173138	EA	EQUALIZER CK20159 L 3	Unit will equalize nonloaded cable pairs used for local program circuits to 5, 8, or 15KHZ, BSP 024-175-110.		
260328257	1946095	EA	EQUALIZER DELAY 4041	IL IN MI OH WI 39		
EXTENDER						
260382288	N	EA	EXTENDER 14A	1 13	1	
FACILITY						
260392246	1965780	EA	FACILITY CABLE REARRANGEMENT CRF66A	6600 pair.		
260383302	N	EA	FACILITY CABLE REARRANGEMENT F90 OH0025	1 8	1	

DISTRIBUTION SERVICES

NETWORK SERVICES

TOOLS

BUILDING JANITORIAL

AUTOMOTIVE

FORMS/OFFICE SUPPLIES

GENERAL

DATA VOICE

DISTRIBUTION SERVICES	FAN								FILLER BATTERY							
	PRODUCT IDENTIFIER				DESCRIPTION				PRODUCT IDENTIFIER				DESCRIPTION			
	ITEM NUMBER	ORD. MULT.	SELL UNIT	STD. PKG. STOCK AVAILABILITY / PA	LEAD TIME	MIN. ORD.	A	C	ITEM NUMBER	ORD. MULT.	SELL UNIT	STD. PKG. STOCK AVAILABILITY / PA	LEAD TIME	MIN. ORD.	A	C
NETWORK SERVICES	FAN								FILLER BATTERY							
	260445077 FAN ASSEMBLY 48V N Used in LTS-21130D Terminal.								280010869 FILLER BATTERY ASSEMBLY N EA 1 2 1 MR50DP/HEDS. Used for filling wet cell batteries.							
	402269591 FAN CK22099 L 5 N EA 1 1 1								400472643 FILLER BATTERY JUG #74 1156067 1 EA IL IN MI OH WI 09 09 09 09 Edelman.							
TOOLS	260392337 FAN FRAME FOR #5 ESS 1965897 1 EA IL IN MI OH WI 09 Used to cool switch frames.								FILTER							
	403834609 FAN REPLACEMENT PD48B2BDL N EA 1 15 1								100185792 FILTER 207D FOR N EA 1 1 1							
	260446539 FAN THERMISTOR KS23912 L1 N								100185800 FILTER 207E FOR ALIT N EA 1 1 1							
BUILDING JANITORIAL	260385224 FAN WITH FA11 CK22501 L3A 1962779 1 EA IL IN MI OH WI 09 09 09 #5 ESS fan used to cool switch frames.								102255262 FILTER 1067B N EA 1 14 1							
	FAN BLOCKERS								102448305 FILTER 1097A N EA 1 14 1							
	260336490 FAN BLOCKERS 22785DP 1947630 1 EA For #5 ESS Central Office.								102527090 FILTER 1115H N EA 1 2 1							
AUTOMOTIVE	FANNING STRIP								102569498 FILTER 1119A 1107995 1 EA IL IN MI OH WI 18 18							
	SEE STRIP FANNING.								260387238 FILTER DISK AIR ASSEMBLY 20170999 N EA 1 2 1							
	FILE CARD								260381025 FILTER ELECTRONIC 2017-0999 N EA 1 5 1							
FORMS/OFFICE SUPPLIES	260369244 FILE CARD CF-166-61 RACK MOUNT N EA 1 4 1 Used with 23in Equipment Rack Mount.								260387246 FILTER FILE STORE AIR 20338166 N EA 1 2 1							
	260369285 FILE CARD M-106-100 RACK MOUNT N EA 1 4 1 12 position, 23in mounting.								001075258 FILTER ISOLATOR 71-701-12 1197863 1 EA IL IN MI OH WI 18 18 18 18							
	260369277 FILE CARD M-161- 25 RACK MOUNT N EA 1 4 1 Used with M-166-17 Callpro unit.								260321765 FILTER KS2311 L14 1942672 1 EA IL IN MI OH WI 04 04 04 Filter for #5 ESS Tape Unit.							
GENERAL	260360433 FILE CARD PK1017-01AAA RACK MOUNT 1953760 1 EA IL IN MI OH WI 75								402418594 FILTER PART S1006-5 N EA 1 1 1							
									260387212 FILTER PRESSURE REGULATOR 77029461 N EA 1 1 1							
									260364864 FILTER PRESSURE REGULATOR 95966090 N EA 1 2 2							
DATA VOICE									103953220 FILTER Z101A AT N EA 1 2 1							

DISTRIBUTION SERVICES
 NETWORK SERVICES
 TOOLS
 BUILDING JANITORIAL
 AUTOMOTIVE
 FORMS/OFFICE SUPPLIES
 GENERAL
 DATA VOICE

PRODUCT IDENTIFIER		DESCRIPTION					
ITEM	ORD.	SELL	STD. PKG.	LEAD TIME	MIN.	A	
NUMBER	MULT.	UNIT	STOCK AVAILABILITY / PA		ORD.	C	
FILTER AIR							
260445051 FILTER AIR							
N							Used in LTS-21130D Terminal.
403322266 FILTER AIR 72852570 PRIMARY							
N		EA	1	2	1		7-3/4 X 2-1/2 X 1/8IN.
280014937 FILTER AIR 72852571 PRIMARY							
N		EA	1	2	1		
260383443 FILTER AIR 73045700							
N		EA	1	2	1		9733 16 X 3-1/2 X 1/4IN.
260382452 FILTER AIR 95966090							
N		EA	1	2	1		5-1/2 X 5-1/4 X 5-1/2IN.
260336623 FILTER AIR CDC 72852571							
N		EA	1	2	18		For CDC disk file in WE3B processor.
300085776 FILTER AIR CDC 94358000							
N		EA	1	2	1		A piece for the disk drive of a 3B Processor.
280046954 FILTER AIR PRIMARY 72852571							
1925867	1	EA	IL 09	IN 09	MI 09	OH 09	WI 09
Foam filter for 340 meg bit disk drive for #5ESS office. 8-3/4 X 2-1/2 X 1/4IN. 9715.							
402853576 FILTER AIR UAF 204							
1947770	1	EA	IL 09	IN 09	MI 09	OH 09	WI 09
A piece part for the 3M Processor, 11.30 X 14.10 X .50IN.							
280031022 FILTER AIR UAF 211 AM 5ESS							
1942052	1	EA	IL 09	IN 09	MI 09	OH 09	WI 09
11.25 X 14 X .50IN.							
403282296 FILTER AIR UAF 213							
N		EA	100	3	100		Central Office filter, 3.88 X 4.50 X .50IN, for the #5 ESS Frames.
280031030 FILTER AIR UAF 214							
N		EA	80	3	160		6.50 X 6.88 X .50IN.
403282338 FILTER AIR UAF 218							
N		EA	1	1	100		Central Office filter, 7.00 X 7.37 X .50IN, for the #5 ESS Frames.
300076338 FILTER AIR UAF 233							
5122002	1	EA	IL 31	IN 31	MI 31	OH 31	WI 31
Central office filter for 5ESS frames, 13.87 X 22.75 X .50IN. Size 11.3 X 14.1 X .50IN replaces UAF 202 filter.							

PRODUCT IDENTIFIER		DESCRIPTION					
ITEM	ORD.	SELL	STD. PKG.	LEAD TIME	MIN.	A	
NUMBER	MULT.	UNIT	STOCK AVAILABILITY / PA		ORD.	C	
260336482 FILTER AIR UAF 235							
1947622	1	EA	IL 31	IN 31	MI 31	OH 31	WI 31
5.6 x 17.5 X .50IN.							
260339759 FILTER AIR UAF 237							
1949388	1	EA	IL 09	IN	MI	OH 09	WI 09
16.00 X 23.25 X .50IN.							
260339767 FILTER AIR UAF 238							
1949370	1	EA	IL 09	IN	MI	OH 09	WI
19.75 X 20.50 X .50IN.							
260432653 FILTER AIR UAF 239							
1979443	1	EA	IL	IN	MI	OH	WI
260376066 FILTER AIR UAF 501							
1959684	1	EA	IL	IN	MI	OH	WI
260358171 FILTER AIR UAF A0344437							
1953141	1	EA	IL 09	IN 09	MI 09	OH 09	WI 09
12.75 X 23.75 X .30IN.							
FILTER FAULT							
102526910 FILTER 1114C (REPLACED BY PID 103315131)							
N		EA	1		13	1	
103231148 FILTER FAULT 1068AK							
N		EA	1		2	1	
103231155 FILTER FAULT 1068AL							
N		EA	1		2	1	
103315115 FILTER FAULT 1114AA							
N		EA	1		2	1	
103315123 FILTER FAULT 1114AB							
N		EA	1		13	1	
103315172 FILTER FAULT 1114AG							
N		EA	1		15	1	
103315214 FILTER FAULT 1114AL							
N		EA	1		13	1	
103315222 FILTER FAULT 1114AM							
N		EA	1		13	1	
102526902 FILTER FAULT 1114B							
N		EA	1		14	1	
103315313 FILTER FAULT 1115AJ							
N		EA	1		2	1	
103315321 FILTER FAULT 1115AK							
N		EA	1		2	1	

FILTER FAULT

PRODUCT IDENTIFIER DESCRIPTION

ITEM NUMBER	ORD. MULT.	SELL UNIT	STD. PKG. STOCK AVAILABILITY / PA	LEAD TIME	MIN. ORD.	A C
-------------	------------	-----------	-----------------------------------	-----------	-----------	-----

103315339	N	EA	1	2	1	
103315347 FILTER FAULT 1115AM						
N		EA	1	2	1	
102527074 FILTER FAULT 1115F						
N		EA	1	2	1	
102527116 FILTER FAULT 1115J						
N		EA	1	2	1	
102527132 FILTER FAULT 1115L						
N		EA	1	2	1	
102527140 FILTER FAULT 1115M						
N		EA	1	2	1	

FITTING

260387279 FITTING AIR MINIATURE HANSON 180						
N		EA	8	1	8	
260387287 FITTING AIR MINIATURE HANSON 186						
N		EA	14	1	14	

FLOAT

402843650 FLOAT CK05499						
N		EA	1	5	1	

FRAME

260427802 FRAME DISTRIBUTING 7FT AT9049E						
1977702	1	EA				
260392220 FRAME VERTICAL R399 PY7557T						
1965764	1	EA	IL IN MI OH WI			
			09			

FREON

260381140 FREON CONTACT RE-NUI/MS-230						
N		CN	1	1	1	

FUSE

300085859 FUSE 3AG 312.175 PACK						
N		PK	1	1	32	
000238956 FUSE 12-09070-00 MINI						
N		EA	10	4	10	
100202852 FUSE 24B 3 AMP						
1177667	1	EA	IL IN MI OH WI			
			04 04 04 04 04			

PRODUCT IDENTIFIER DESCRIPTION

ITEM NUMBER	ORD. MULT.	SELL UNIT	STD. PKG. STOCK AVAILABILITY / PA	LEAD TIME	MIN. ORD.	A C
-------------	------------	-----------	-----------------------------------	-----------	-----------	-----

100202860	N	EA	1	9	1	
100202878 FUSE 24C 2 AMP						
1177683	10	EA	IL IN MI OH WI			
			04 04 04 04 04			
100202886 FUSE 24D 3/4 AMP						
1177709	10	EA	IL IN MI OH WI			
			04 04 04 04 04			
100202894 FUSE 24E 1/2 AMP						
1177725	10	EA	IL IN MI OH WI			
			04 04 04 04 04			
100202902 FUSE 24F 5 AMP						
1177741	10	EA	IL IN MI OH WI			
			04 04 04 04 04			

100202910 FUSE 24G 1 1/3 AMP						
1177766	10	EA	IL IN MI OH WI			
			04 04 04 04 04			

100203090 FUSE 35T						
N		EA	1	2	1	

100203199 FUSE 60A						
N		EA	25	2	25	

100203207 FUSE 60D						
1178061	25	EA	IL IN MI OH WI			
			08 08 08 08 08			
Tubular red shell cartridge sneak current fuse. Used in LA and LB protected terminal chambers and in 14A fuse holders, BSP 460-100-400.						

100203215 FUSE 60E						
N		EA	25	2	25	

100203231 FUSE 60G						
N		EA	25	2	25	

100203249 FUSE 60H						
N		EA	25	6	25	

100203272 FUSE 63A DUMMY						
5200766	25	EA	IL IN MI OH WI			
			04 04 04 04 04			
A dummy fuse for use on spare stubs for #35 type fuses. Package of 50.						

100203280 FUSE 64A						
N		EA	10	2	10	

100203298 FUSE 67A						
N		EA	10	2	10	

280045097 FUSE 70A 1 1/3 AMP WHITE IND						
1925255	5	EA	IL IN MI OH WI			
			04 04 04 04 04			
Package of 5, AT&T.						

280045089 FUSE 70B 2 AMP ORANGE IND						
1925263	5	EA	IL IN MI OH WI			
			04 04 04 04 04			
Package of 5, AT&T.						

DISTRIBUTION SERVICES

NETWORK SERVICES

TOOLS

BUILDING JANITORIAL

AUTOMOTIVE

FORMS/OFFICE SUPPLIES

GENERAL

DATA VOICE

DISTRIBUTION SERVICES

NETWORK SERVICES

TOOLS

BUILDING JANITORIAL

AUTOMOTIVE

FORMS/OFFICE SUPPLIES

GENERAL

DATA VOICE

PRODUCT IDENTIFIER		DESCRIPTION						
ITEM NUMBER	ORD. MULT.	SELL UNIT	STD. PKG. STOCK AVAILABILITY / PA	LEAD TIME			MIN. ORD.	A C
280045071 FUSE		70C	3 AMP	BLUE	IND			
1925271	5	EA	IL IN MI OH WI 04 04 04 04 04					
Package of 5, AT&T.								
280045063 FUSE		70D	5 AMP	GREEN	IND			
1925347	5	EA	IL IN MI OH WI 04 04 04 04 04					
Package of 5, AT&T.								
280045055 FUSE		70E	.180 AMP	YELLOW	IND			
1925289	5	EA	IL IN MI OH WI 04 04 04 04 04					
Package of 5, AT&T.								
280045048 FUSE		70F	1/4 AMP	VIOLET	IND			
1925297	5	EA	IL IN MI OH WI 04 04 04 04 04					
Package of 5, AT&T.								
280045030 FUSE		70G	1/2 AMP	RED	IND			
1925305	5	EA	IL IN MI OH WI 04 04 04 04 04					
Package of 5, AT&T.								
280045022 FUSE		70H	3/4 AMP	BROWN	IND			
1925313	5	EA	IL IN MI OH WI 04 04 04 04 04					
Package of 5, AT&T.								
280045014 FUSE		70K	1/4 AMP					
1925321	5	EA	IL IN MI OH WI 04 04 04 04 04					
With violet-white indicator, AT&T. Package of 5.								
280045006 FUSE		70P	.100 AMP					
1925339	5	EA	IL IN MI OH WI 04 04 04 04 04					
With gray-white indicator, AT&T. Package of 5.								
280044991 FUSE		70R	.150 AMP					
1925438	5	EA	IL IN MI OH WI 04 04 04 04 04					
With red-white indicator, AT&T. Package of 5.								
103757977 FUSE		72B						
1964346	1	EA	IL IN MI OH WI 04 04 04 04 04					
260450770 FUSE		74A						
N								
102630308 FUSE		74B	3 AMP					
1938381	5	EA	IL IN MI OH WI 04 04 04 04 04					
Single fuse element soldered on a copper-clad laminated base substrate inclosed in fibre tube. Non-alarming and non-indicator type.								
102630316 FUSE		74C						
1938399	5	EA	IL IN MI OH WI 04 04 04 04 04					
102630324 FUSE		74D						
1938407	5	EA	IL IN MI OH WI 04 04 04 04 04					

PRODUCT IDENTIFIER		DESCRIPTION						
ITEM NUMBER	ORD. MULT.	SELL UNIT	STD. PKG. STOCK AVAILABILITY / PA	LEAD TIME			MIN. ORD.	A C
102630332 FUSE		74E						
1938415	5	EA	IL IN MI OH WI 04 04 04 04 04					
102630340 FUSE		74F						
1938423	5	EA	IL IN MI OH WI 04 04 04 04 04					
103064952 FUSE		74G	2 AMP					
1978452	5	EA	IL IN MI OH WI					
103264669 FUSE		74H						
N		EA		1		7		1
103228425 FUSE		74J						
1938449	5	EA	IL IN MI OH WI 04 04 04 04 04					
102660008 FUSE		75A						
N		EA		1		7		5
102732112 FUSE		75B						
N		EA		1		7		5
102810181 FUSE		76A						
N		EA		1		7		5
102965688 FUSE		76B						
N		EA		1		7		5
103656625 FUSE		76C						
N		EA		1		7		5
103086963 FUSE		77E						
N		EA		1		5		1
103243374 FUSE		77K						
N		EA		1		5		1
103087144 FUSE		78E	OPTOELECTRONIC					
N		EA		1		14		1
103087227 FUSE		78J	OPTOELECTRONIC					
N		EA		1		14		1
103752143 FUSE		80A						
1940874	5	EA	IL IN MI OH WI 04 04 04 04 04					
103752150 FUSE		80B	2 AMP					
1938456	5	EA	IL IN MI OH WI 04 04 04 04 04					
103752168 FUSE		80C	3 AMP					
1938464	5	EA	IL IN MI OH WI 04 04 04 04 04					
103800637 FUSE		80D	5 AMP					
1938480	5	EA	IL IN MI OH WI 04 04 04 04 04					
103839916 FUSE		80G	1/2 AMP					
1938506	1	EA	IL IN MI OH WI 04 04 04 04 04					

FUSE

PRODUCT IDENTIFIER		DESCRIPTION						
ITEM NUMBER	ORD. MULT.	SELL UNIT	STD. PKG. STOCK AVAILABILITY / PA	LEAD TIME			MIN. ORD.	A C
103752176 FUSE		81A 10 AMP						
1938498	5	EA	IL 04 IN 04 MI 04 OH 04 WI 04					
103828141 FUSE		81B 7 1/2 AMP						
1938472	5	EA	IL 09 IN MI OH WI					
280071960 FUSE		70L-1A REPLACES FUSE GKB 1 AMP						
1950261	10	EA	IL 04 IN MI 04 OH WI 04					
260437934 FUSE		A0236226 DUMMY						
N		EA	100	4			100	
401390844 FUSE		A13X 40-1 AMP						
1938555	10	EA	IL 04 IN 04 MI 04 OH 04 WI 04					
Protection for Semiconductors, rectifiers, diodes, DC power supplies, and special applications, AC or DC.								
997964523 FUSE		ABC 1 AMP						
N		EA	5	2			5	
997935440 FUSE		ABC 2 AMP						
N		EA	5	2			5	
402112981 FUSE		ABC 3 AMP						
N		EA	5	2			5	
400503314 FUSE		ABC 5 AMP						
N		EA	5	2			5	
997935457 FUSE		ABC 6 AMP						
N		EA	5	2			15	
280029463 FUSE		ABC 8 AMP						
N		EA	5	2			5	
997301882 FUSE		ABC 10 AMP						
N		EA	5	2			5	
997943261 FUSE		ABC 12 AMP						
N		EA	5	2			5	
997628144 FUSE		ABC 15 AMP						
7286542	5	EA	IL 04 IN 04 MI 04 OH 04 WI 04					
997301908 FUSE		ABC 20 AMP						
N		EA	5	2			5	
402312193 FUSE		ABC 25 AMP						
N		EA	5	2			5	
280029471 FUSE		ABC 30 AMP						
N		EA	5	2			5	
280029489 FUSE		ABS 1 AMP						
N		EA	5	2			5	
401760319 FUSE		ABS 2 AMP						
N		EA	5	2			5	

PRODUCT IDENTIFIER		DESCRIPTION						
ITEM NUMBER	ORD. MULT.	SELL UNIT	STD. PKG. STOCK AVAILABILITY / PA	LEAD TIME			MIN. ORD.	A C
997628672 FUSE		ABS 5 AMP						
N		EA	5	2			5	
402078505 FUSE		ABS 6 AMP						
N		EA	5	2			5	
997841978 FUSE		ABS 8 AMP						
N		EA	5	2			5	
997942925 FUSE		ABS 10 AMP						
1302505	5	EA	IL 04 IN 04 MI 04 OH 04 WI 04					
997942966 FUSE		ABS 15 AMP						
1302521	5	EA	IL 04 IN 04 MI 04 OH 04 WI 04					
997935390 FUSE		ABS 20 AMP						
N		EA	5	2			5	
997935382 FUSE		ABS 25 AMP						
N		EA	5	2			5	
402034755 FUSE		ABS 30 AMP						
N		EA	5	2			5	
997918214 FUSE		ACK 150 AMP						
N		EA	10	2			10	
402440960 FUSE		AGA 10 AMP						
N		EA	5	2			5	
402715627 FUSE		AGC 1/10 AMP						
N		EA	5	2			5	
280011362 FUSE		AGC 1/16 AMP						
N		EA	5	2			5	
997894829 FUSE		AGC 1/2 AMP						
3151423	5	EA	IL 04 IN 04 MI 04 OH 04 WI 04					
A cartridge fuse 1 1/4in long X 1/4in diameter with glass enclosure, 250 volt.								
997894811 FUSE		AGC 1/4 AMP						
1178343	5	EA	IL 04 IN 04 MI 04 OH 04 WI 04					
997304464 FUSE		AGC 1/8 AMP						
N		EA	5	2			5	
280078924 FUSE		AGC 3/10 AMP						
N		EA	5	2			5	
997894837 FUSE		AGC 3/4 AMP						
4166926	5	EA	IL 04 IN 04 MI 04 OH 04 WI 04					
400455143 FUSE		AGC 3/8 AMP						
N		EA	5	2			5	
997894753 FUSE		AGC 1 AMP 250 VOLTS						
3151449	5	EA	IL 04 IN 04 MI 04 OH 04 WI 04					

DISTRIBUTION SERVICES

NETWORK SERVICES

TOOLS

BUILDING JANITORIAL

AUTOMOTIVE

FORMS/OFFICE SUPPLIES

GENERAL

DATA VOICE

DISTRIBUTION SERVICES

NETWORK SERVICES

TOOLS

BUILDING JANITORIAL

AUTOMOTIVE

FORMS/OFFICE SUPPLIES

GENERAL

DATA VOICE

PRODUCT IDENTIFIER		DESCRIPTION						
ITEM NUMBER	ORD. MULT.	SELL UNIT	STD. PKG. STOCK AVAILABILITY / PA	LEAD TIME		MIN. ORD.	A C	
997301874	5	EA	1 1/2 AMP	IL 04	IN 04	MI 04	OH 04	WI 04
1169714	5	EA						
997628151	5	EA	2 AMP	IL 04	IN 04	MI 04	OH 04	WI 04
1178467	5	EA						
280029513	N	EA	2 1/2 AMP			2		5
997628102	5	EA	3 AMP	IL 04	IN 04	MI 04	OH 04	WI 04
1178400	5	EA						
997894852	5	EA	5 AMP	IL 04	IN 04	MI 04	OH 04	WI 04
1102533	5	EA						
997628516	N	EA	6 AMP			2		5
997942370	N	EA	6 1/4 AMP			2		5
280029521	N	EA	7 AMP			2		5
997601026	N	EA	1/2 AMP			2		5
997942362	N	EA	3 AMP			2		5
280078916	N	EA	8 AMP			2		5
997301965	N	EA	10 AMP			2		5
997942727	N	EA	15 AMP			2		5
997942735	5	EA	20 AMP	IL 04	IN 04	MI 04	OH 04	WI 04
1178483	5	EA						
401015060	N	EA	25 AMP			2		5
997628490	N	EA	30 AMP			2		5
997628714	N	EA	1/16 AMP			2		5
997628573	N	EA	1/2 AMP			2		5
280078932	N	EA	1/32 AMP			2		5
280071879	N	EA	1/8 AMP			2		5

PRODUCT IDENTIFIER		DESCRIPTION						
ITEM NUMBER	ORD. MULT.	SELL UNIT	STD. PKG. STOCK AVAILABILITY / PA	LEAD TIME		MIN. ORD.	A C	
280071986	N	EA	3/10 AMP			2		5
997301932	5	EA	3/4 AMP	IL 04	IN 04	MI 04	OH 04	WI 04
1178442	5	EA						
250 volt, glass, for instruments, electronics and small appliance circuits.								
997628698	5	EA	1 AMP	IL 04	IN 04	MI 04	OH 04	WI 04
1178525	5	EA						
997941620	5	EA	2 AMP	IL 04	IN 04	MI 04	OH 04	WI 04
1178541	5	EA						
280029588	N	EA	3 AMP			2		5
401286844	N	EA	250 AMP			2		5
997628383	N	EA	1 AMP			2		10
997840269	N	EA	3 AMP			2		10
997628417	N	EA	5 AMP			2		10
997840178	N	EA	6 AMP			2		10
997942917	N	EA	10 AMP			2		10
997628474	N	EA	15 AMP			2		10
401198080	N	EA	20 AMP			2		10
280071994	N	EA	25 AMP			2		10
280029604	N	EA	10 AMP			2		10
401466503	N	EA	15 AMP			2		10
280029612	N	EA	20 AMP			2		10
401789219	N	EA	25 AMP			2		1
401466529	N	EA	30 AMP			2		10
280078940	N	EA	3 AMP			2		10

DISTRIBUTION SERVICES

NETWORK SERVICES

TOOLS

BUILDING JANITORIAL

AUTOMOTIVE

FORMS/OFFICE SUPPLIES

GENERAL

DATA VOICE

FUSE

PRODUCT IDENTIFIER		DESCRIPTION					
ITEM NUMBER	ORD. MULT.	SELL UNIT	STD. PKG. STOCK AVAILABILITY / PA	LEAD TIME	MIN. ORD.	A C	
280078908		FUSE BBS	5	AMP			
N		EA	10	2	10		
997601059		FUSE CK19392	L14				
N		EA	1	2	1		
400704698		FUSE CK19780	L 6				
N		EA	1	2	1		
997964697		FUSE CK19780	L2 10 AMP				
6303503	1	EA	IL IN MI OH WI 04 04 04 04 04				
Fuses used in Cental Office switching equipment.							
402721682		FUSE CK21938	L 3				
N		EA	1	2	1		
402721690		FUSE CK21938	L 4				
N		EA	1	2	1		
403056732		FUSE CK21938	L 5				
N		EA	1	2	1		
402901755		FUSE CK21938	L 6				
N		EA	1	5	1		
402901763		FUSE CK21938	L 7				
N		EA	1	2	1		
402902969		FUSE CK21938	L 8				
N		EA	1	2	1		
997840145		FUSE FNM	1/2 AMP				
N		EA	10	2	10		
300051380		FUSE FNM	2 1/2 AMP				
N		EA	10	2	10		
997840061		FUSE FNM	5 AMP				
N		EA	10	2	10		
997840723		FUSE FNM	10 AMP				
N		EA	10	2	10		
280071887		FUSE FNM	25 AMP				
N		EA	10	2	10		
997601083		FUSE FNM	30 AMP				
N		EA	10	2	10		
403344211		FUSE FRN-R	1 AMP				
N		EA	10	2	10		
403344229		FUSE FRN-R	1 4/10 AMP				
N		EA	10	2	10		
403344237		FUSE FRN-R	1 6/10 AMP				
N		EA	10	2	10		
403344245		FUSE FRN-R	2 1/2 AMP				
N		EA	10	2	10		

PRODUCT IDENTIFIER		DESCRIPTION					
ITEM NUMBER	ORD. MULT.	SELL UNIT	STD. PKG. STOCK AVAILABILITY / PA	LEAD TIME	MIN. ORD.	A C	
403344252		FUSE FRN-R	3 2/10 AMP				
N		EA	10	2	10		
403344260		FUSE FRN-R	4 AMP				
N		EA	10	2	10		
403344278		FUSE FRN-R	5 AMP				
N		EA	10	2	10		
403344286		FUSE FRN-R	6 1/4 AMP				
N		EA	10	2	10		
403344294		FUSE FRN-R	10 AMP				
N		EA	10	2	10		
403344302		FUSE FRN-R	12 AMP				
N		EA	10	2	10		
402497648		FUSE FRN-R	15 AMP				
N		EA	10	2	10		
403344310		FUSE FRN-R	15 AMP				
N		EA	10	2	10		
403344328		FUSE FRN-R	20 AMP				
N		EA	10	2	10		
403344336		FUSE FRN-R	25 AMP				
N		EA	10	2	10		
402497655		FUSE FRN-R	25 AMP				
N		EA	10	2	10		
403344344		FUSE FRN-R	30 AMP				
N		EA	10	2	10		
403344351		FUSE FRN-R	40 AMP				
N		EA	10	2	10		
403344369		FUSE FRN-R	45 AMP				
N		EA	10	2	10		
403344377		FUSE FRN-R	50 AMP				
N		EA	10	2	10		
403344385		FUSE FRN-R	60 AMP				
N		EA	10	2	10		
403344393		FUSE FRN-R	70 AMP				
N		EA	5	2	5		
403344401		FUSE FRN-R	80 AMP				
N		EA	5	2	5		
403344419		FUSE FRN-R	100 AMP				
N		EA	5	3	5		
403344427		FUSE FRN-R	110 AMP				
N		EA	1	2	1		
403344435		FUSE FRN-R	125 AMP				
N		EA	1	2	1		

PRODUCT IDENTIFIER		DESCRIPTION				
ITEM NUMBER	ORD. MULT.	SELL UNIT	STD. PKG. STOCK AVAILABILITY / PA	LEAD TIME	MIN. ORD.	A C
403344443	N	EA	FRN-R 150	AMP	2	1
403344450	N	EA	FRN-R 200	AMP	2	1
403344468	N	EA	FRN-R 225	AMP	2	1
403344476	N	EA	FRN-R 300	AMP	2	10
403344484	N	EA	FRN-R 400	AMP	2	10
403344492	N	EA	FRS-R 10	AMP	2	10
403344500	N	EA	FRS-R 15	AMP	2	10
403272073	N	EA	FRS-R 200	AMP	2	1
280071952	1949826	10 EA	GBA 1	AMP	IL 04	IN 04 MI OH WI
400540779	N	EA	GBA 2	AMP	2	5
280071846	N	EA	GBA 10	AMP	2	5
280071945	1949834	5 EA	GBA 15	AMP	IL 04	IN MI OH WI
401704598	N	EA	GBB 1	AMP	2	5
401322094	N	EA	GBB 1 1/4	AMP	2	5
401452487	N	EA	GBB 2	AMP	2	5
401210729	N	EA	GBB 3	AMP	2	5
401573647	N	EA	GBB 4	AMP	2	5
401515846	N	EA	GBB 5	AMP	2	5
401573654	N	EA	GBB 6	AMP	2	5
401573662	N	EA	GBB 8	AMP	2	5

PRODUCT IDENTIFIER		DESCRIPTION				
ITEM NUMBER	ORD. MULT.	SELL UNIT	STD. PKG. STOCK AVAILABILITY / PA	LEAD TIME	MIN. ORD.	A C
401466552	N	EA	FUSE GBB 10	AMP	5	2 5
401559943	N	EA	FUSE GBB 15	AMP	5	2 5
401466560	N	EA	FUSE GBB 20	AMP	5	2 5
401207154	N	EA	FUSE GBB 25	AMP	5	2 5
402716799	N	EA	FUSE GBB 30	AMP	5	2 5
280029687	N	EA	FUSE GFA 1/4	AMP	5	2 5
997601075	N	EA	FUSE GJV 1	AMP	5	2 10
401843941	1950279	10 EA	FUSE GKB 10	AMP 70 TYPE	IL 04	IN 04 MI 04 OH WI
997946744	N	EA	FUSE GLD 3/4	AMP	5	2 5
300052776	N	EA	FUSE GLD 1 1/2	AMP	5	2 5
401448188	N	EA	FUSE GLD 4	AMP	5	2 5
280078957	N	EA	FUSE GLD 5	AMP	5	2 5
402800163	N	EA	FUSE GLD 15	AMP	5	2 5
997964622	N	EA	FUSE GLH 10	AMP	5	2 30
401231501	1938530	10 EA	FUSE GMT 1/2	AMP	IL 04	IN 04 MI 04 OH 04 WI 04
Non-time delay visual fuse indicating alarm for telecommunication computer, or control circuits.						
400955365	4211045	10 EA	FUSE GMT 1/4	AMP	IL 04	IN 04 MI 04 OH 04 WI 04
Alarm fuse for Teltrend mountings.						
280029703	N	EA	FUSE GMT 3/4	AMP	10	2 10
402328926	8411397	10 EA	FUSE GMT .180	AMP	IL 04	IN 04 MI 04 OH 04 WI 04
For use in the connectorized fuse panel assembly associated with Chatlos cable air pressure monitoring systems.						

DISTRIBUTION SERVICES
 NETWORK SERVICES
 TOOLS
 BUILDING JANITORIAL
 AUTOMOTIVE
 FORMS/OFFICE SUPPLIES
 GENERAL
 DATA VOICE

DISTRIBUTION SERVICES

NETWORK SERVICES

TOOLS

BUILDING JANITORIAL

AUTOMOTIVE

FORMS/OFFICE SUPPLIES

GENERAL

DATA VOICE

FUSE

PRODUCT IDENTIFIER								PRODUCT IDENTIFIER											
ITEM		ORD.	SELL	STD. PKG.		LEAD TIME		MIN.	A	ITEM		ORD.	SELL	STD. PKG.		LEAD TIME		MIN.	A
NUMBER	MULT.	UNIT	UNIT	STOCK AVAILABILITY / PA		ORD.	C	ORD.	C	NUMBER	MULT.	UNIT	UNIT	STOCK AVAILABILITY / PA		ORD.	C	ORD.	C
401841473			FUSE	GMT	1	AMP				401917018			FUSE	CAA	1	AMP			
1938571	10	EA			IL	IN	MI	OH	WI	N		EA		10		2		10	
					04	04	04	04	04										
			A 1 amp fuse designed for use on a Lynch office repeater.																
280029711			FUSE	GMT	1 1/2	AMP				402283394			FUSE	CAA	2	AMP			
N		EA			10		2		10	N		EA		10		2		10	
400994604			FUSE	GMT	1 1/3	AMP				401917026			FUSE	CAA	3	AMP			
4211037	10	EA			IL	IN	MI	OH	WI	N		EA		10		2		10	
					04	04	04	04	04										
			Alarm fuse for Teltrend mountings.																
401466594			FUSE	GMT	2	AMP ORANGE				402525547			FUSE	CAA	8	AMP			
1938563	10	EA			IL	IN	MI	OH	WI	N		EA		10		2		10	
					04	04	04	04	04										
			Non-time delay visual fuse indicating alarm for telecommunication computer, or control circuits.																
401231527			FUSE	GMT	3	AMP BLUE				401377650			FUSE	CAA	10	AMP			
1938548	10	EA			IL	IN	MI	OH	WI	N		EA		10		2		10	
					04	04	04	04	04										
			Non-time delay visual indicating alarm, for telecommunication, computer or control circuits.																
280029729			FUSE	GMT	3 1/2	AMP				997918289			FUSE	CAA	15	AMP			
N		EA			10		2		10	N		EA		10		2		10	
280029737			FUSE	GMT	4	AMP				401832720			FUSE	CAA	20	AMP			
N		EA			10		2		10	N		EA		5		2		5	
401231535			FUSE	GMT	5	AMP				997918339			FUSE	CAA	25	AMP			
8410993	10	EA			IL	IN	MI	OH	WI	N		EA		10		2		10	
					04	04	04	04	04										
			Non delay alarm indicating fuse.																
402268338			FUSE	GMT	7 1/2	AMP				401498860			FUSE	CAA	30	AMP			
N		EA			10		2		10	N		EA		10		2		10	
300028008			FUSE	GMT	10	AMP				402342281			FUSE	CAA	200	AMP			
N		EA			10		2		10	N		EA		5		2		5	
402438501			FUSE	GMT	10	AMP RED-WHITE				402342299			FUSE	CAA	225	AMP			
1938597	10	EA			IL	IN	MI	OH	WI	N		EA		1		2		1	
					04	04	04	04	04										
			Non-time delay visual fuse indicating alarm for telecommunication computer, or control circuits.																
402439764			FUSE	GMW	1/2	AMP				402440895			FUSE	CAA	250	AMP			
N		EA			10		2		10	N		EA		5		2		5	
401143094			FUSE	HBO	20	AMP				402161624			FUSE	CAA	300	AMP			
N		EA			10		2		10	N		EA		5		2		5	
280071929			FUSE	JHC	30	AMP				402342307			FUSE	CAA	350	AMP			
N		EA			10		2		10	N		EA		5		2		5	
402327498			FUSE	JHC	100	AMP				997943717			FUSE	CAA	400	AMP			
N		EA			1		2		1	N		EA		5		2		5	
402464689			FUSE	JJS	250	AMP				402440903			FUSE	CAA	450	AMP			
N		EA			1		2		1	N		EA		1		2		1	
280071895			FUSE	JKS	20	AMP				997943527			FUSE	CAA	1000	AMP			
N		EA			10		2		10	N		EA		1		2		1	
										402762660			FUSE	KAB	3	AMP			
										N		EA		10		2		10	
										997842000			FUSE	KAB	5	AMP			
										N		EA		10		2		10	
										400954814			FUSE	KAB	10	AMP			
										N		EA		10		2		10	
										402670210			FUSE	KAB	15	AMP			
										N		EA		10		2		10	

PRODUCT IDENTIFIER							DESCRIPTION						
ITEM NUMBER	ORD. MULT.	SELL UNIT	STD. PKG. STOCK AVAILABILITY / PA	LEAD TIME	MIN. ORD.	A C							
997964598	N	FUSE KAB	20	AMP									
		EA	10	2	10								
997964937	N	FUSE KAB	30	AMP									
		EA	10	2	10								
400613535	N	FUSE KAB	100	AMP									
		EA	5	2	5								
280029760	N	FUSE KAH	40	AMP									
		EA	10	2	10								
402078893	N	FUSE KAH	60	AMP									
		EA	10	2	10								
402289649	N	FUSE KAJ	40	AMP									
		EA	10	2	10								
997842059	N	FUSE KAJ	60	AMP									
		EA	10	2	10								
997964994	N	FUSE KAW	15	AMP									
		EA	10	2	10								
997840624	N	FUSE KLM	15	AMP									
		EA	10	2	10								
997949367	N	FUSE KLM	30	AMP									
		EA	10	2	10								
402284749	N	FUSE KRP-C2000		AMP									
		EA	1	2	1								
402284756	N	FUSE KRP-C3000		AMP									
		EA	1	2	1								
402024384	N	FUSE KTK	1/2	AMP									
		EA	10	2	10								
400527164	N	FUSE KTK	1	AMP									
		EA	10	2	10								
402024392	N	FUSE KTK	2	AMP									
		EA	10	2	10								
280029778	N	FUSE KTK	3	AMP									
		EA	10	2	10								
997943550	N	FUSE KTK	4	AMP									
		EA	10	2	10								
400527172	N	FUSE KTK	5	AMP									
		EA	10	2	10								
401865068	N	FUSE KTK	6	AMP									
		EA	10	2	10								
402252951	N	FUSE KTK	7	AMP									
		EA	10	2	10								
997840863	N	FUSE KTK	8	AMP									
		EA	10	2	10								

PRODUCT IDENTIFIER							DESCRIPTION						
ITEM NUMBER	ORD. MULT.	SELL UNIT	STD. PKG. STOCK AVAILABILITY / PA	LEAD TIME	MIN. ORD.	A C							
280029786	N	FUSE KTK	10	AMP									
		EA	10	2	10								
997601133	N	FUSE KTK	15	AMP									
		EA	10	2	10								
401521398	N	FUSE KTK	20	AMP									
		EA	10	2	10								
401795927	N	FUSE KTK	30	AMP									
		EA	10	2	10								
402497002	N	FUSE KTN-R	20	AMP									
		EA	10	2	10								
402497663	N	FUSE KTN-R	30	AMP									
		EA	10	2	10								
402525331	N	FUSE KTN-R	200	AMP									
		EA	1	2	1								
402696983	N	FUSE LKN	60	AMP									
		EA	20	2	20								
402078646	N	FUSE LKN	100	AMP									
		EA	10	2	10								
402078653	N	FUSE LKN	125	AMP									
		EA	5	2	5								
402440507	N	FUSE LKN	225	AMP									
		EA	5	2	5								
402440515	N	FUSE LKN	350	AMP									
		EA	5	2	5								
402671697	N	FUSE LPN-R	15	AMP									
		EA	10	2	10								
402671705	N	FUSE LPN-R	20	AMP									
		EA	10	2	10								
402671713	N	FUSE LPN-R	25	AMP									
		EA	10	2	10								
402762975	N	FUSE LPN-R	50	AMP									
		EA	10	2	10								
402799563	N	FUSE LPN-R	60	AMP									
		EA	10	2	10								
402525372	N	FUSE LPN-R	100	AMP									
		EA	5	2	5								
280071911	N	FUSE LPN-R	200	AMP									
		EA	1	2	1								
402801807	N	FUSE LPN-R	250	AMP									
		EA	1	2	1								
402762629	N	FUSE LPN-R	400	AMP									
		EA	1	2	1								

DISTRIBUTION SERVICES

NETWORK SERVICES

TOOLS

BUILDING JANITORIAL

AUTOMOTIVE

FORMS/OFFICE SUPPLIES

GENERAL

DATA VOICE

DISTRIBUTION SERVICES

NETWORK SERVICES

TOOLS

BUILDING JANITORIAL

AUTOMOTIVE

FORMS/OFFICE SUPPLIES

GENERAL

DATA VOICE

FUSE

PRODUCT IDENTIFIER		DESCRIPTION				
ITEM NUMBER	ORD. MULT.	SELL UNIT	STD. PKG. STOCK AVAILABILITY / PA	LEAD TIME	MIN. ORD.	A C
402256200		FUSE LPS	3 2/10	AMP		
N		EA	10	2	10	
402286033		FUSE LPS	15	AMP		
N		EA	10	2	10	
402286041		FUSE LPS	25	AMP		
N		EA	10	2	10	
402285324		FUSE LPS	50	AMP		
N		EA	10	2	10	
402520449		FUSE LPS	200	AMP		
N		EA	1	2	1	
402698500		FUSE LPS-R	12	AMP		
N		EA	10	2	10	
402519284		FUSE LPS-R	15	AMP		
N		EA	10	2	10	
402519276		FUSE LPS-R	25	AMP		
N		EA	10	2	10	
402698492		FUSE LPS-R	50	AMP		
N		EA	10	2	10	
402522932		FUSE LPS-R	60	AMP		
N		EA	10	2	10	
402842363		FUSE LPS-R	200	AMP		
N		EA	1	2	1	
401163340		FUSE MBO	2	AMP		
N		EA	5	2	5	
401163357		FUSE MBO	6	AMP		
N		EA	5	2	5	
401706270		FUSE MBO	8	AMP		
N		EA	5	2	5	
400994612		FUSE MBO	10	AMP		
N		EA	5	2	5	
400994620		FUSE MBO	15	AMP		
N		EA	5	2	5	
402286272		FUSE MDA	1 1/2	AMP		
N		EA	5	2	5	
402539852		FUSE MDA	1 6/10	AMP		
N		EA	5	2	5	
401517107		FUSE MDA	3	AMP		
N		EA	5	2	5	
402289656		FUSE MDA	3 2/10	AMP		
N		EA	5	2	5	
401854971		FUSE MDA	4	AMP		
N		EA	5	2	5	

PRODUCT IDENTIFIER		DESCRIPTION				
ITEM NUMBER	ORD. MULT.	SELL UNIT	STD. PKG. STOCK AVAILABILITY / PA	LEAD TIME	MIN. ORD.	A C
401241757		FUSE MDA	5	AMP		
1944124	5	EA	IL 09	IN 09	MI 09	OH WI
401802483		FUSE MDA	6 1/4	AMP		
N		EA	5	2	5	
997919212		FUSE MDA	10	AMP		
N		EA	5	2	5	
401185368		FUSE MDA	15	AMP		
1949842	5	EA	IL 04	IN 04	MI 04	OH WI
997964929		FUSE MDA	30	AMP		
N		EA	5	2	5	
402310445		FUSE MDF	15	AMP		
N		EA	5	2	5	
400833158		FUSE MDL	1/10	AMP		
N		EA	5	2	5	
997943428		FUSE MDL	1/16	AMP		
N		EA	5	2	5	
400717690		FUSE MDL	1/2	AMP		
1178863	5	EA	IL 04	IN 04	MI 04	OH WI 04
997943410		FUSE MDL	1/32	AMP		
N		EA	5	2	5	
997816434		FUSE MDL	1/4	AMP		
3152488	5	EA	IL 04	IN 04	MI 04	OH WI 04
997947247		FUSE MDL	1/8	AMP		
N		EA	5	2	5	
280071903		FUSE MDL	2/10	AMP		
N		EA	5	2	5	
997841200		FUSE MDL	3/10	AMP		
N		EA	5	2	10	
997841226		FUSE MDL	3/4	AMP		
N		EA	5	2	10	
997816467		FUSE MDL	6/10	AMP		
N		EA	5	2	10	
997655824		FUSE MDL	8/10	AMP		
N		EA	5	2	10	
997943402		FUSE MDL	1/100	AMP		
N		EA	5	2	5	
997942149		FUSE MDL	1	AMP SLOW BLOW		
1178889	5	EA	IL 04	IN 04	MI 04	OH WI 04
997949052		FUSE MDL	1 1/2	AMP		
N		EA	5	2	5	

PRODUCT IDENTIFIER		DESCRIPTION					
ITEM NUMBER	ORD. MULT.	SELL UNIT	STD. PKG. STOCK AVAILABILITY / PA	LEAD TIME	MIN. ORD.	A C	
997628128	N	FUSE MDL EA	1 1/4 AMP 5	2	10		
997655816	N	FUSE MDL EA	1 6/10 AMP 5	2	10		
997628243	N	FUSE MDL EA	15/100 AMP 5	2	5		
997840186	1178905	FUSE MDL EA	2 AMP IL IN MI OH WI 04 04 04 04 04				
A slow blowing cartridge fuse.							
997655774	N	FUSE MDL EA	2 1/2 AMP 5	2	10		
997841234	1178921	FUSE MDL EA	3 AMP IL IN MI OH WI 04 04 04 04 04				
400833257	1201830	FUSE MDL EA	4 AMP IL IN MI OH WI 04 04 04 04 04				
400415121	1178962	FUSE MDL EA	5 AMP IL IN MI OH WI 04 04 04 04 04				
997840111	N	FUSE MDL EA	10 AMP 5	2	10		
900155581	5201665	FUSE MDL EA	15 AMP IL IN MI OH WI 04 04 04 04 04				
997840210	N	FUSE MDL EA	20 AMP 5	2	10		
997964739	N	FUSE MDM EA	1/10 AMP 5	2	10		
997943220	N	FUSE MDM EA	1/2 AMP 5	2	5		
402137772	N	FUSE MDM EA	3/4 AMP 5	2	5		
997816475	N	FUSE MDM EA	1 AMP 5	2	5		
280071853	N	FUSE MDM EA	1 6/10 AMP 5	2	5		
997964820	N	FUSE MDM EA	2 AMP 1	2	1		
997840558	6203380	FUSE MDM EA	3 AMP IL IN MI OH WI 04 04 04 04 04				
997840970	N	FUSE MDM EA	5 AMP 5	2	10		

PRODUCT IDENTIFIER		DESCRIPTION					
ITEM NUMBER	ORD. MULT.	SELL UNIT	STD. PKG. STOCK AVAILABILITY / PA	LEAD TIME	MIN. ORD.	A C	
997840996	N	FUSE MDM EA	15 AMP 5	2	10		
997935465	N	FUSE MDX EA	2 AMP 5	2	10		
997840244	N	FUSE MDX EA	3 AMP 5	2	10		
997840236	N	FUSE MDX EA	4 AMP 5	2	10		
997935200	N	FUSE MDX EA	5 AMP 5	2	5		
997840541	N	FUSE MDX EA	6 1/4 AMP 5	2	10		
997966171	N	FUSE MIN EA	5 AMP 5	2	5		
997841663	N	FUSE MTH EA	4 AMP 5	2	20		
997628029	N	FUSE MTH EA	6 AMP 5	2	20		
997945209	1178566	FUSE NON EA	1 AMP IL IN MI OH WI 04 04 04 04 04				
Cartridge, 250 volt.							
997945225	N	FUSE NON EA	2 AMP 10	2	10		
280078965	N	FUSE NON EA	3 AMP 10	2	10		
997945381	N	FUSE NON EA	5 AMP 10	2	10		
997945407	N	FUSE NON EA	6 AMP 10	2	10		
997945449	N	FUSE NON EA	8 AMP 10	2	10		
997945480	N	FUSE NON EA	10 AMP 10	2	10		
997944681	1178608	FUSE NON EA	10 AMP IL IN MI OH WI 04 04 04 04 04				
250V Protective Device.							
997945522	1432047	FUSE NON EA	15 AMP IL IN MI OH WI 04 04 04 04 04				
Universal fuse for one-time general purpose.							
997945548	1120147	FUSE NON EA	20 AMP IL IN MI OH WI 04 04 04 04 04				
Cartridge fuse for protecting electrical circuits.							

DISTRIBUTION SERVICES
 NETWORK SERVICES
 TOOLS
 BUILDING JANITORIAL
 AUTOMOTIVE
 FORMS/OFFICE SUPPLIES
 GENERAL
 DATA VOICE

DISTRIBUTION SERVICES	FUSE								FUSE											
	PRODUCT IDENTIFIER				DESCRIPTION				PRODUCT IDENTIFIER				DESCRIPTION							
	ITEM NUMBER	ORD. MULT.	SELL UNIT	STD. PKG. STOCK AVAILABILITY / PA	LEAD TIME	MIN. ORD.	A	C	ITEM NUMBER	ORD. MULT.	SELL UNIT	STD. PKG. STOCK AVAILABILITY / PA	LEAD TIME	MIN. ORD.	A	C				
NETWORK SERVICES	997945563	FUSE	NON	25	AMP					997946215	FUSE	NON	500	AMP						
	N		EA	10	2	10			N		EA	1	2	1						
	997945589	FUSE	NON	30	AMP				997946256	FUSE	NON	600	AMP							
	1178681	10	EA	IL	IN	MI	OH	WI	N		EA	1	2	1						
				04	04	04	04	04	997944798	FUSE	NOS	50	AMP							
				A cartridge fuse 2in long 1/2in in diameter.							N		EA	10	2	10				
		997945605	FUSE	NON	35	AMP				402166466	FUSE	NOS	60	AMP						
	N		EA	10	2	10			N		EA	10	2	10						
TOOLS	997943758	FUSE	NON	40	AMP				402521587	FUSE	NOS	200	AMP							
	1186957	10	EA	IL	IN	MI	OH	WI	N		EA	1	2	1						
				04	04	04	04	04	402329619	FUSE	NOS	350	AMP							
				A cartridge fuse 2in long 1/2in in diameter.							N		EA	1	2	1				
		997946595	FUSE	NON	45	AMP				997628011	FUSE	PLUG	15	AMP	125V					
	5201269	10	EA	IL	IN	MI	OH	WI	N		EA	4	2	12						
				04	04	04	04	04												
BUILDING JANITORIAL	997945688	FUSE	NON	50	AMP				401950050	FUSE	QFF1A	1 1/3	AMP							
	N		EA	10	2	10			1949982	1	EA	IL	IN	MI	OH	WI				
				04	04	04	04	04				04	04	04						
				3in long X 1in diameter. Used to power rept. for D4 carrier.							401950068	FUSE	QFF1B	2	AMP					
		997945779	FUSE	NON	60	AMP				N		EA	10	4	10					
	N		EA	10	2	10			401779459	FUSE	QFF1G	.500	AMP							
									N		EA	10	4	10						
AUTOMOTIVE	997945803	FUSE	NON	70	AMP				401970736	FUSE	QFFIC	3	AMP							
	N		EA	5	2	5			N		EA	10	4	10						
									401970744	FUSE	QFFID	5	AMP							
		997945928	FUSE	NON	100	AMP				N		EA	10	4	10					
	N		EA	5	2	5			401970751	FUSE	QFFIE	.180	AMP							
									N		EA	10	4	10						
		997945993	FUSE	NON	125	AMP				401950076	FUSE	QFFIF	.25	AMP						
N		EA	1	2	1			N		EA	10	4	10							
FORMS/OFFICE SUPPLIES	997946025	FUSE	NON	150	AMP				401970769	FUSE	QFFIH	.75	AMP							
	N		EA	1	2	1			N		EA	10	4	10						
									260401070	FUSE	QFFIJ	7 1/2	AMP							
		997946041	FUSE	NON	175	AMP				N		EA	10	4	10					
	N		EA	1	2	1			997816863	FUSE	S	1/2	AMP							
									N		EA	4	2	4						
		997946066	FUSE	NON	200	AMP				997816772	FUSE	S	3/10	AMP						
N		EA	1	2	1			N		EA	4	2	4							
GENERAL	997946082	FUSE	NON	225	AMP				997816723	FUSE	S	6/10	AMP							
	N		EA	1	2	1			N		EA	4	2	4						
									997816699	FUSE	S	8/10	AMP							
		997946140	FUSE	NON	300	AMP				N		EA	4	2	4					
	N		EA	1	2	1			997816996	FUSE	S	1 1/4	AMP							
									N		EA	4	2	4						
		997946173	FUSE	NON	350	AMP														
N		EA	1	2	1															
DATA VOICE	997946223	FUSE	NON	400	AMP															
	N		EA	1	2	1														
		997946231	FUSE	NON	450	AMP														
	N		EA	1	2	1														

PRODUCT IDENTIFIER							DESCRIPTION						
ITEM NUMBER	ORD. MULT.	SELL UNIT	STD. PKG. STOCK AVAILABILITY / PA	LEAD TIME	MIN. ORD.	A C							
997840913		FUSE S	1 1/8 AMP										
N		EA	4	2	4								
997816707		FUSE S	1 6/10 AMP										
N		EA	4	2	4								
997816889		FUSE S	2 AMP										
N		EA	4	2	4								
997816806		FUSE S	2 1/2 AMP										
N		EA	4	2	4								
997840095		FUSE S	3 2/10 AMP										
N		EA	4	2	4								
997943725		FUSE S	5 6/10 AMP										
N		EA	4	2	4								
997816830		FUSE S	10 AMP										
N		EA	4	2	4								
997816970		FUSE S	15 AMP										
N		EA	4	2	8								
997943451		FUSE S	20 AMP										
N		EA	4	2	8								
401188966		FUSE SC	1 AMP										
N		EA	4	2	4								
402113682		FUSE SC	6 AMP										
N		EA	4	2	4								
401892971		FUSE SC	15 AMP										
N		EA	4	2	4								
402063945		FUSE SC	20 AMP										
N		EA	4	2	4								
402765440		FUSE SC	25 AMP										
N		EA	4	2	4								
402519482		FUSE SC	30 AMP										
N		EA	4	2	4								
402126049		FUSE SC	60 AMP										
N		EA	2	2	2								
260367602		FUSE SCP-1											
N		EA	1	2	10								
							Protector Sneak Current Fuse, mount on 66 type blocks, replaces 60D fuse, current protection 350 Milliamps 600 Volts, ITW.						
997941927		FUSE T	1 AMP										
N		EA	4	2	4								
997823414		FUSE T	1 6/10 AMP										
N		EA	4	2	4								
997823463		FUSE T	2 1/2 AMP										
N		EA	4	2	4								

PRODUCT IDENTIFIER							DESCRIPTION						
ITEM NUMBER	ORD. MULT.	SELL UNIT	STD. PKG. STOCK AVAILABILITY / PA	LEAD TIME	MIN. ORD.	A C							
997819982		FUSE T	3 2/10 AMP										
N		EA	4	2	4								
997655758		FUSE T	10 AMP										
N		EA	4	2	4								
997655840		FUSE T	15 AMP										
N		EA	4	2	8								
260426788		FUSE TPL-BB	80 AMP										
N		EA	5	6	5								
260426796		FUSE TPL-BD	100 AMP										
N		EA	5	6	5								
260426804		FUSE TPL-BF	150 AMP										
N		EA	5	6	5								
260428719		FUSE TPL-BK	225 AMP										
N		EA	5	6	5								
260426754		FUSE TPL-BL	250 AMP										
N		EA	5	6	5								
260426762		FUSE TPL-CN	300 AMP										
N		EA	1	6	1								
260426770		FUSE TPL-CR	400 AMP										
N		EA	1	6	1								
260426713		FUSE TPL-CU	500 AMP										
N		EA	1	6	1								
260426721		FUSE TPL-CZ	600 AMP										
N		EA	1	6	1								
260426739		FUSE TPL-TA	80 AMP										
N		EA	1	6	1								
260426689		FUSE TPL-TA	100 AMP										
N		EA	1	6	1								
260426697		FUSE TPL-TA	150 AMP										
N		EA	1	6	1								
260426705		FUSE TPL-TA	225 AMP										
N		EA	1	6	1								
260426655		FUSE TPL-TA	300 AMP										
N		EA	1	6	1								
260426663		FUSE TPL-TA	400 AMP										
N		EA	1	6	1								
260426671		FUSE TPL-TA	500 AMP										
N		EA	1	6	1								
260428727		FUSE TPL-TA	600 AMP										
N		EA	1	6	1								
260426630		FUSE TPN	15 AMP										
N		EA	10	6	10								

DISTRIBUTION SERVICES
 NETWORK SERVICES
 TOOLS
 BUILDING JANITORIAL
 AUTOMOTIVE
 FORMS/OFFICE SUPPLIES
 GENERAL
 DATA VOICE

DISTRIBUTION SERVICES
 NETWORK SERVICES
 TOOLS
 BUILDING JANITORIAL
 AUTOMOTIVE
 FORMS/OFFICE SUPPLIES
 GENERAL
 DATA VOICE

FUSE

PRODUCT IDENTIFIER		DESCRIPTION					
ITEM NUMBER	ORD. MULT.	SELL UNIT	STD. PKG. STOCK AVAILABILITY / PA	LEAD TIME	MIN. ORD.	A C	
260426648		FUSE TPN	20	AMP			
N		EA	10	6	10		
260426598		FUSE TPN	25	AMP			
N		EA	10	6	10		
260426606		FUSE TPN	30	AMP			
N		EA	10	6	10		
260426614		FUSE TPN	35	AMP			
N		EA	10	6	10		
260426564		FUSE TPN	40	AMP			
N		EA	10	6	10		
260426572		FUSE TPN	45	AMP			
N		EA	10	6	10		
260426580		FUSE TPN	50	AMP			
N		EA	10	6	10		
260426531		FUSE TPN	60	AMP			
N		EA	10	6	10		
260426549		FUSE TPN	80	AMP			
N		EA	5	6	5		
260426556		FUSE TPN	100	AMP			
N		EA	5	6	5		
260426473		FUSE TPN	150	AMP			
N		EA	1	6	1		
260426481		FUSE TPN	225	AMP			
N		EA	1	6	1		
260426499		FUSE TPN	300	AMP			
N		EA	1	6	1		
260426507		FUSE TPN	400	AMP			
N		EA	1	6	1		
260426515		FUSE TPN	500	AMP			
N		EA	1	6	1		
260426523		FUSE TPN	600	AMP			
N		EA	1	6	1		
402128375		FUSE W	10	AMP			
N		EA	4	2	8		

GASKET

840440648		GASKET 840440648				
2798645	1	EA				
840441406		GASKET 840441406 TOP				
N		EA	1	13	1	
840442693		GASKET 840442693 TOP				
N		EA	1	2	1	

PRODUCT IDENTIFIER		DESCRIPTION					
ITEM NUMBER	ORD. MULT.	SELL UNIT	STD. PKG. STOCK AVAILABILITY / PA	LEAD TIME	MIN. ORD.	A C	
842301137		GASKET 842301137	BASE COVER				
N		EA	1	2	1		
842301509		GASKET 842301509					
N		EA	1	2	1		

GAUGE

996698239		GAUGE TENSION INDICATOR KS6660				
1184705	1	EA				

GENERATOR

401517115		GENERATOR AT610	LEVEL W E			
N		EA	1	13	1	
102805363		GENERATOR FREQUENCY 117B				
N		EA	1	2	1	
Replacement part for Unit Power 20B2, BSP 167-440-201.						

102264777 GENERATOR FREQUENCY 118A

1224055	1	EA	IL 04	IN 04	MI 04	OH 04	WI 04
Used with 551C key service unit to provide common audible ringing. Mounting bracket 841720857 must be ordered separately, BSP 518-215-407.							

102915816 GENERATOR FREQUENCY 123A

1939819	1	EA	IL 04	IN 04	MI 04	OH 04	WI 04
---------	---	----	-------	-------	-------	-------	-------

402094999 GENERATOR PULSE PG 502

N		EA	1	7	1	
---	--	----	---	---	---	--

260421177 GENERATOR RING & TONE PLANT

N		EA	1	6	1	
100 VOLT/AMP 3500115T						

103116976 GENERATOR RINGING 1A

N		EA	1	22	1	
---	--	----	---	----	---	--

002090595 GENERATOR RINGING 8505

1187732	1	EA	IL 39	IN 39	MI 39	OH 39	WI 39
10WATT, 75VOLT, 20HZ. An industry standard 400 size module used with network terminating equipment.							

GUARD

102478062		GUARD 20A				
N		EA	1	9	1	
401829536		GUARD CK20107 L5				
N		PK	1	2	1	
10 guards 20 KS20309 L1 hinges per package.						

PRODUCT IDENTIFIER DESCRIPTION

ITEM NUMBER	ORD. MULT.	SELL UNIT	STD. PKG. STOCK AVAILABILITY / PA	LEAD TIME	MIN. ORD.	A C
-------------	------------	-----------	-----------------------------------	-----------	-----------	-----

401391826 GUARD CK21369 L1 M/D
 1146274 1 PK IL IN MI OH WI
 59 59 59 59 59
 Package of 10. Used to indicate SSM lines on test side of 300 type connectors on Central Office Distributing Frames. BSP 069-120-801. MANUFACTURE DISCONTINUED UPON STOCK DEPLETION.

402800627 GUARD CK22596 L 1
 N EA 1 3 1
 Package of 10.

401545421 GUARD LABEL CK21528 L 2
 N CT 1 4 1

GUARD RAIL ASSEMBLY

842744559	N	EA	1	1	1	
842744575	N	EA	1	6	1	
842744609	N	EA	1	9	1	
842744617	N	EA	1	1	1	
842744641	N	EA	1	1	1	
842744666	N	EA	1	7	1	
842744674	N	EA	1	9	1	
842744740	N	EA	1	1	1	
842744971	N	EA	1	8	1	
842744989	N	EA	1	8	1	
842745044	N	EA	1	9	1	
842745291	N	EA	1	9	1	
842745317	N	EA	1	1	1	
842750424	N	EA	1	9	1	
842750457	N	EA	1	9	1	

PRODUCT IDENTIFIER DESCRIPTION

ITEM NUMBER	ORD. MULT.	SELL UNIT	STD. PKG. STOCK AVAILABILITY / PA	LEAD TIME	MIN. ORD.	A C
-------------	------------	-----------	-----------------------------------	-----------	-----------	-----

842750473 GUARD RAIL ASSEMBLY 842750473
 N EA 1 1 1

842750481 GUARD RAIL ASSEMBLY 842750481
 N EA 1 6 1

842750515 GUARD RAIL ASSEMBLY 842750515
 N EA 1 9 1

842750572 GUARD RAIL ASSEMBLY 842750572
 N EA 1 6 1

842750739 GUARD RAIL ASSEMBLY 842750739
 N EA 1 9 1

842750895 GUARD RAIL ASSEMBLY 842750895
 N EA 1 9 1

842750929 GUARD RAIL ASSEMBLY 842750929
 N EA 1 9 1

842750952 GUARD RAIL ASSEMBLY 842750952
 N EA 1 7 1

842750978 GUARD RAIL ASSEMBLY 842750978
 N EA 1 1 1

842751018 GUARD RAIL ASSEMBLY 842751018
 N EA 1 15 1

842751174 GUARD RAIL ASSEMBLY 842751174
 N EA 1 8 1

842752255 GUARD RAIL ASSEMBLY 842752255
 N EA 1 14 1

842752552 GUARD RAIL ASSEMBLY 842752552
 N EA 1 14 1

843773508 GUARD RAIL ASSEMBLY 843773508
 N EA 1 15 1

843773524 GUARD RAIL ASSEMBLY 843773524
 N EA 1 14 1

GUARD RAIL COVER

840239339 GUARD RAIL COVER 840239339
 N EA 1 6 1

HANDLE

841224637 HANDLE 841224637
 N EA 1 14 1

HANGER

996030862 HANGER CK20085 L9 ITE H710
 N EA 1 2 1

DISTRIBUTION SERVICES
 NETWORK SERVICES
 TOOLS
 BUILDING JANITORIAL
 AUTOMOTIVE
 FORMS/OFFICE SUPPLIES
 GENERAL
 DATA VOICE

DISTRIBUTION SERVICES

HARDWARE

PRODUCT IDENTIFIER		DESCRIPTION				
ITEM NUMBER	ORD. MULT.	SELL UNIT	STD. PKG. STOCK AVAILABILITY / PA	LEAD TIME	MIN. ORD.	A C

PRODUCT IDENTIFIER		DESCRIPTION				
ITEM NUMBER	ORD. MULT.	SELL UNIT	STD. PKG. STOCK AVAILABILITY / PA	LEAD TIME	MIN. ORD.	A C

NETWORK SERVICES

HARDWARE

260376892	N	EA	1	4	1	
HARDWARE LINEFINDER MOUNTING						
M-166-05 BASIC UNITS						

HOOK CORD

100209915	1	EA				
HOOK CORD 9A						
Gray finish metal hook used to hold patching cords and operating telephone sets when not in use, 3-1/2 X 3IN.						

TOOLS

HARNESS

260357298	1	EA				
HARNESS WIRE SHELF NT7H19BA						
1952754						

INDUCTOR

100214261	N	EA	1	1	1	
INDUCTOR 274L						
Consists of a metal case containing a core type coil having a silicon steel straight core, BSP 510-110-400.						

HEAD ASSEMBLY

260380704	N	EA	3	4	3	
HEAD ASSEMBLY L-504303						

102900081	N	EA	1	9	1	
INDUCTOR 1126A						

BUILDING JANITORIAL

HEAD DISK DRIVE

260386800	N	EA	1	2	1	
HEAD DISK DRIVE 1B						

102481066	N	EA	1	11	1	
INDUCTOR 1181A						

HEAT COIL

SEE COIL HEAT.

102855582	N	EA	1	20	1	
INDUCTOR 1181B						

AUTOMOTIVE

HINGE

841564057	N	EA	1	2	1	
HINGE 841564057						

104146238	N	EA	1	9	1	
INDUCTOR 1181N						

HOLDER

997525571	N	EA	1	1	1	
HOLDER FILLER SYRINGE CK5499						

103058855	N	EA	1	11	1	
INDUCTOR 1196A						

FORMS/OFFICE SUPPLIES

100208412	N	EA	1	1	1	
HOLDER FUSE 14A						

102970894	1215715	1	EA	IL 18	IN 18	MI 18	OH 18	WI 18
INDUCTOR 1542AM								
Intended to suppress radio broadcast interference in a telephone set. Use instead of a 42A connecting block, BSP 500-150-100.								

841159874	1938514	1	EA	IL 09	IN 09	MI 09	OH 09	WI 09
HOLDER FUSE 841159874								

101492882	1180679	1	EA	IL 04	IN 04	MI 04	OH 04	WI 04
INDUCTOR 1633F								
Used in the junctor circuit of an ESS office to supply talk battery for local calls.								

GENERAL

997132261	N	EA	10	2	10	
HOLDER FUSE BUSS HKP						

101492890	5252841	1	EA	IL 04	IN 04	MI 04	OH 04	WI 04
INDUCTOR 1633G								

997787353	N	EA	10	2	10	
HOLDER FUSE BUSS HRJ						

101492908	5252866	1	EA	IL 04	IN 04	MI 04	OH 04	WI 04
INDUCTOR 1633H								
Used in a 2B ESS office and is part of the trunk network circuit pack.								

260386867	N	EA	1	7	1	
HOLDER KEY						

101492916	1117218	1	EA	IL 04	IN 04	MI 04	OH 04	WI 04
INDUCTOR 1633J								

DATA VOICE

401871694	N	EA	1	12	1	
HOLDER SPRING L-502625						

101492924	5252924	1	EA	IL 04	IN 04	MI 04	OH 04	WI 04
INDUCTOR 1633K								
Used in the junctor circuit of an ESS office to supply talk battery for local calls.								

PRODUCT IDENTIFIER		DESCRIPTION				
ITEM NUMBER	ORD. MULT.	SELL UNIT	STD. PKG. STOCK AVAILABILITY / PA	LEAD TIME	MIN. ORD.	A C
INHIBITOR						
402523849	1	GL	CK21923 L1 GALLON CAN			
5420505	1	GL	An additive for use in fuel oil storage tanks to retard corrosion and bacterial growth, BSP 665-320-301.			
INSULATOR						
996246641			INSULATOR LC9188-1 TIP			
N		EA	1	14	1	
845353002			INSULATOR PS			
N		EA	1	6	1	
INTERFACE						
260341870			INTERFACE CABLE ETHERNET			
N		EA	1	17	1	
300030160			INTERFACE DATA CHANNEL 829-YE1			
1146670	1	EA	IL IN MI OH WI 18 18 18 18			
260359732			INTERFACE DATA CHANNEL 829-YM1			
1953562	1	EA	IL IN MI OH WI 18 18 18 18			
260338017			INTERFACE DATA CHANNEL 7306-41B			
1948588	1	EA	IL IN MI OH WI 18 18 18 18			
400 type plug-in module for 2/4 wire modem on 4 wire line.						
300005857			INTERFACE DATA CHANNEL 7306-45			
1184036	1	EA	IL IN MI OH WI 18 18 18 18			
260384573			INTERFACE FEEDER DISTRIBUTION SS-1350			
N		EA	1	4	5	
To be used for assembly into Fujitsu 6200 cabinet.						
INTERRUPTER						
997951306			INTERRUPTER CK15634 L2			
N		EA	1	18	1	
JACK						
100275437			JACK 285C			
N		EA	1	2	1	
102118874			JACK 560B			
N		EA	1	13	1	
101562684			JACK 572C			
N		EA	1	2	1	

PRODUCT IDENTIFIER		DESCRIPTION				
ITEM NUMBER	ORD. MULT.	SELL UNIT	STD. PKG. STOCK AVAILABILITY / PA	LEAD TIME	MIN. ORD.	A C
102281193			JACK 632CM			
N		EA	1	2	1	
101584266			JACK DSX 1 241AM			
N		EA	1	2	1	
JACK MOUNTING						
SEE MOUNTING JACK.						
JUMPER						
260420161			JUMPER AC INPUT 4216-195			
1974550	1	EA				
260420161			JUMPER AC INPUT 4216-195			
N		EA	1	4	1	
260418587			JUMPER CABLE DC OUTPUT 4218334			
1973461	1	EA	IL IN MI OH WI 09			
280021460			JUMPER SINGLE MODE NT3E42AA			
N		EA	1	2	1	
JUMPER QUAD DDS						
840897219			JUMPER QUAD DDS 2.0FT RED			
N		EA	1	4	1	
840897227			JUMPER QUAD DDS 2.5FT WHITE			
N		EA	1	4	1	
840897235			JUMPER QUAD DDS 3.0FT LIGHT BLUE			
N		EA	1	4	1	
840897243			JUMPER QUAD DDS 3.5FT BLACK			
N		EA	1	4	1	
840897250			JUMPER QUAD DDS 4.0FT YELLOW			
N		EA	1	4	1	
840897268			JUMPER QUAD DDS 4.5FT MAROON			
N		EA	1	4	1	
840897276			JUMPER QUAD DDS 5.0FT GREEN			
N		EA	1	4	1	
840897284			JUMPER QUAD DDS 5.5FT BLUE			
N		EA	1	4	1	
840897292			JUMPER QUAD DDS 6.0FT TAN			
N		EA	1	4	1	
840897300			JUMPER QUAD DDS 6.5FT LIGHT GREY			
N		EA	1	4	1	
840897318			JUMPER QUAD DDS 7.0FT MOSS GREEN			
N		EA	1	4	1	

DISTRIBUTION SERVICES

NETWORK SERVICES

TOOLS

BUILDING JANITORIAL

AUTOMOTIVE

FORMS/OFFICE SUPPLIES

GENERAL

DATA VOICE

JUMPER QUAD DDS

DISTRIBUTION SERVICES

PRODUCT IDENTIFIER DESCRIPTION

ITEM NUMBER	ORD. MULT.	SELL UNIT	STD. PKG. STOCK AVAILABILITY / PA	LEAD TIME	MIN. ORD.	A C
-------------	------------	-----------	-----------------------------------	-----------	-----------	-----

840897326	N	EA	JUMPER QUAD DDS 7.5FT RED	1	4	1
-----------	---	----	---------------------------	---	---	---

840897334	N	EA	JUMPER QUAD DDS 8.0FT WHITE	1	4	1
-----------	---	----	-----------------------------	---	---	---

840897342	N	EA	JUMPER QUAD DDS 8.5FT LIGHT BLUE	1	4	1
-----------	---	----	----------------------------------	---	---	---

840897359	N	EA	JUMPER QUAD DDS 9.0FT BLACK	1	4	1
-----------	---	----	-----------------------------	---	---	---

840897367	N	EA	JUMPER QUAD DDS 9.5FT YELLOW	1	4	1
-----------	---	----	------------------------------	---	---	---

840897375	N	EA	JUMPER QUAD DDS 10.0FT MAROON	1	4	1
-----------	---	----	-------------------------------	---	---	---

840897383	N	EA	JUMPER QUAD DDS 10.5FT GREEN	1	4	1
-----------	---	----	------------------------------	---	---	---

840897391	N	EA	JUMPER QUAD DDS 11.0FT BLUE	1	4	1
-----------	---	----	-----------------------------	---	---	---

840897409	N	EA	JUMPER QUAD DDS 11.5FT TAN	1	4	1
-----------	---	----	----------------------------	---	---	---

840897417	N	EA	JUMPER QUAD DDS 12.0FT LIGHT GREY	1	4	1
-----------	---	----	-----------------------------------	---	---	---

840897425	N	EA	JUMPER QUAD DDS 12.5FT MOSS GREEN	1	4	1
-----------	---	----	-----------------------------------	---	---	---

841825003	N	EA	JUMPER QUAD DDS 13.0FT RED	1	4	1
-----------	---	----	----------------------------	---	---	---

841825011	N	EA	JUMPER QUAD DDS 13.5FT WHITE	1	4	1
-----------	---	----	------------------------------	---	---	---

841825029	N	EA	JUMPER QUAD DDS 14.0FT LIGHT BLUE	1	4	1
-----------	---	----	-----------------------------------	---	---	---

841825037	N	EA	JUMPER QUAD DDS 14.5FT BLACK	1	4	1
-----------	---	----	------------------------------	---	---	---

841825045	N	EA	JUMPER QUAD DDS 15.0FT YELLOW	1	4	1
-----------	---	----	-------------------------------	---	---	---

841825052	N	EA	JUMPER QUAD DDS 15.5FT MAROON	1	4	1
-----------	---	----	-------------------------------	---	---	---

841825060	N	EA	JUMPER QUAD DDS 16.0FT GREEN	1	4	1
-----------	---	----	------------------------------	---	---	---

841825078	N	EA	JUMPER QUAD DDS 16.5FT BLUE	1	4	1
-----------	---	----	-----------------------------	---	---	---

841825086	N	EA	JUMPER QUAD DDS 17.0FT TAN	1	4	1
-----------	---	----	----------------------------	---	---	---

841825094	N	EA	JUMPER QUAD DDS 17.5FT LIGHT GREY	1	4	1
-----------	---	----	-----------------------------------	---	---	---

NETWORK SERVICES

TOOLS

BUILDING JANITORIAL

AUTOMOTIVE

FORMS/OFFICE SUPPLIES

GENERAL

DATA VOICE

PRODUCT IDENTIFIER DESCRIPTION

ITEM NUMBER	ORD. MULT.	SELL UNIT	STD. PKG. STOCK AVAILABILITY / PA	LEAD TIME	MIN. ORD.	A C
-------------	------------	-----------	-----------------------------------	-----------	-----------	-----

841825102	N	EA	JUMPER QUAD DDS 18.0FT MOSS GREEN	1	4	1
-----------	---	----	-----------------------------------	---	---	---

841825110	N	EA	JUMPER QUAD DDS 18.5FT RED	1	4	1
-----------	---	----	----------------------------	---	---	---

841825128	N	EA	JUMPER QUAD DDS 19.0FT WHITE	1	4	1
-----------	---	----	------------------------------	---	---	---

841825136	N	EA	JUMPER QUAD DDS 19.5FT LIGHT BLUE	1	4	1
-----------	---	----	-----------------------------------	---	---	---

841825144	N	EA	JUMPER QUAD DDS 20.0FT BLACK	1	4	1
-----------	---	----	------------------------------	---	---	---

841825151	N	EA	JUMPER QUAD DDS 20.5FT YELLOW	1	4	1
-----------	---	----	-------------------------------	---	---	---

841825169	N	EA	JUMPER QUAD DDS 21.0FT MAROON	1	4	1
-----------	---	----	-------------------------------	---	---	---

841825177	N	EA	JUMPER QUAD DDS 21.5FT GREEN	1	4	1
-----------	---	----	------------------------------	---	---	---

841825185	N	EA	JUMPER QUAD DDS 22.0FT BLUE	1	4	1
-----------	---	----	-----------------------------	---	---	---

841825193	N	EA	JUMPER QUAD DDS 22.5FT TAN	1	4	1
-----------	---	----	----------------------------	---	---	---

841825201	N	EA	JUMPER QUAD DDS 23.0FT LIGHT GREY	1	4	1
-----------	---	----	-----------------------------------	---	---	---

841825219	N	EA	JUMPER QUAD DDS 23.5FT MOSS GREEN	1	4	1
-----------	---	----	-----------------------------------	---	---	---

841825227	N	EA	JUMPER QUAD DDS 24.0FT RED	1	4	1
-----------	---	----	----------------------------	---	---	---

841825235	N	EA	JUMPER QUAD DDS 24.5FT WHITE	1	4	1
-----------	---	----	------------------------------	---	---	---

841825243	N	EA	JUMPER QUAD DDS 25.0FT LIGHT BLUE	1	4	1
-----------	---	----	-----------------------------------	---	---	---

841825250	N	EA	JUMPER QUAD DDS 25.5FT BLACK	1	4	1
-----------	---	----	------------------------------	---	---	---

841825268	N	EA	JUMPER QUAD DDS 26.0FT YELLOW	1	4	1
-----------	---	----	-------------------------------	---	---	---

841825276	N	EA	JUMPER QUAD DDS 26.5FT MAROON	1	4	1
-----------	---	----	-------------------------------	---	---	---

841825284	N	EA	JUMPER QUAD DDS 27.0FT GREEN	1	4	1
-----------	---	----	------------------------------	---	---	---

841825292	N	EA	JUMPER QUAD DDS 27.5FT BLUE	1	4	1
-----------	---	----	-----------------------------	---	---	---

841825300	N	EA	JUMPER QUAD DDS 28.0FT TAN	1	4	1
-----------	---	----	----------------------------	---	---	---

PRODUCT IDENTIFIER		DESCRIPTION				
ITEM NUMBER	ORD. MULT.	SELL UNIT	STD. PKG. STOCK AVAILABILITY / PA	LEAD TIME	MIN. ORD.	A C
841825318	N	EA	1	4	1	
JUMPER QUAD DDS 28.5FT LIGHT GREY						
841825326	N	EA	1	4	1	
JUMPER QUAD DDS 29.0FT MOSS GREEN						
841825334	N	EA	1	4	1	
JUMPER QUAD DDS 29.5FT RED						
841825342	N	EA	1	4	1	
JUMPER QUAD DDS 30.0FT WHITE						

J NUMBERED PARTS

600371264	1135012	1	EA			
J1C141AK-1 L1 TERMINAL 102131						
600357487	N	EA	1	2	1	
J53050 F-2 L1,4 ATTIS						
600100119	N	EA	1	2	1	
J58833 A-2 L1,A,K FUSE PANEL						
600070882	N	EA	1	6	1	
J59013 E-4 L4 CORD ASSEMBLY						
600189864	N	EA	1	2	1	
J70177AT-1 L2 REPEATER SHELF						
600098289	N	EA	1	2	1	
J87214 C-2 L3						
600220420	N	EA	1	2	1	
J99343RA-1 L4						
600202980	N	EA	1	16	1	
J99380 J-1 LB PWR DIST PNL						

KEY

101153542	N	EA	1	8	1	
KEY 630N4						
260435839	1980334	1	EA	IL 09 IN 09 MI 09 OH 09 WI 09		
KEY DOOR FUJITSU						
260386743	N	EA	1	6	1	
KEY DOVE TAIL CK20760 L6						

KIT

260393004	N	EA	1	4	1	
KIT 3500-115T						
260421904	1974691	1	EA	IL 09 IN 09 MI 09 OH 09 WI 09		
KIT CABLE NT7HO1LJ FMT-150 B/C						

PRODUCT IDENTIFIER		DESCRIPTION				
ITEM NUMBER	ORD. MULT.	SELL UNIT	STD. PKG. STOCK AVAILABILITY / PA	LEAD TIME	MIN. ORD.	A C
260421912	1974683	1	EA	IL 09 IN 09 MI 09 OH 09 WI 09		
KIT CABLE NT7HO1LL FMT-150B						
260421896	1974709	1	EA	IL 09 IN 09 MI 09 OH 09 WI 09		
KIT CABLE NT7HO1LM FMT-150 B/B						
260421888	1974717	1	EA	IL 09 IN 09 MI 09 OH 09 WI 09		
KIT CABLE NT7HO1LN FMT-150 B/B D/C						

260445069 KIT CONNECTOR

N Used in LTS-21130D Terminal.

845864693 KIT DOOR LATCH

N EA 1 8 1

260392329 KIT INSTALLATION FMT-150

1965871 1 EA IL 09 IN 09 MI 09 OH 09 WI 09
 HA210-0001T052. Panel is required to cover the splicing area to accommodate the FMT-150 in fiber fed cabinet applications. One kit is required for every fiber cabinet.

260357306 KIT INTERCONNECT 150 B/C NT7H01LB

1952739 1 EA IL 09 IN 09 MI 09 OH 09 WI 09

260368741 KIT INTERCONNECT 150 D/C NT7H01LD

1956045 1 EA IL 09 IN 09 MI 09 OH 09 WI 05

260422506 KIT INTERFACE CABLE NT7H17EB

1975656 1 EA IL 09 IN 09 MI 09 OH 09 WI 09
 To be used in the assembly of 6200 cabinets. Used for new FMT-150 B&C shelves.

260420187 KIT MNTG CIRCUIT BREAKER 5821-10540

1974576 1 EA IL 09 IN 09 MI 09 OH 09 WI 09

260387071 KIT PLUGS LOGIC 95573202

N EA 1 13 1

260449251 KIT TEST HA15B-0001-C124

N

260392972 KIT TONE GENERATOR 3500-112T

N EA 1 4 1

KIT FUSE

845047430 KIT FUSE 5 SERIES

N EA 1 2 1

845047448 KIT FUSE 39E

N EA 1 3 1

845047455 KIT FUSE 39F

N EA 1 3 1

DISTRIBUTION SERVICES

KIT FUSE

PRODUCT IDENTIFIER		DESCRIPTION						
ITEM NUMBER	ORD. MULT.	SELL UNIT	STD. PKG. STOCK AVAILABILITY / PA	LEAD TIME	MIN. ORD.	A	C	

260368758 KIT FUSE 150 NT7H01FA							
1956052	1	EA	IL 09 IN 09 MI 09 OH 09 WI				

260423421 KIT FUSE A97-001204							
1976035	1	EA	IL IN MI 09 OH WI				

845047406 KIT FUSE D5 40A							
N		EA	1	13			1

260374087 KIT FUSE MPS HA15B-0001-A050							
1956375	1	EA	IL 09 IN 09 MI 09 OH 09 WI 09				

260417118 KIT FUSE REPLACEMENT HA15B-0001-A049							
1972257	1	EA	IL 09 IN MI 09 OH 09 WI				

260422514 KIT FUSE REPLACEMENT HA15B-0001-A051							
1975664	1	EA	IL 09 IN MI 09 OH 09 WI 09				
For 6200 cabinets.							

260405410 KIT FUSE & LAMP NT7H01FA							
1969741	1	EA	IL 09 IN MI OH WI				

KIT OF PARTS

106658479 KIT OF PARTS 24A 189 TYPE P							
N		EA	1	5			1

102343761 KIT OF PARTS D180492							
1216713	1	EA	IL 59 IN 59 MI 59 OH 59 WI 59				
Conversion kit be used to provide speakerphone service on Touch-A-Matic telephones, BSP 503-603-101.							

102964723 KIT OF PARTS D180810							
N		EA	1	2			1

103349759 KIT OF PARTS D181090							
N		EA	10	3			10

103349767 KIT OF PARTS D181091							
N		EA	10	3			10

103886537 KIT OF PARTS D181231							
N		EA	1	1			1

105541841 KIT OF PARTS D182103							
N		EA	1	9			1

LABEL

104059449 LABEL 3A							
N		EA	1	13			1

843416165 LABEL DESIGNATION 843416165							
N		EA	1	7			1

NETWORK SERVICES

TOOLS

BUILDING JANITORIAL

AUTOMOTIVE

FORMS/OFFICE SUPPLIES

GENERAL

DATA VOICE

PRODUCT IDENTIFIER		DESCRIPTION						
ITEM NUMBER	ORD. MULT.	SELL UNIT	STD. PKG. STOCK AVAILABILITY / PA	LEAD TIME	MIN. ORD.	A	C	

843416173 LABEL DESIGNATION 843416173							
N		EA	1	7			1

846148807 LABEL DSX 846148807							
N		EA	1	1			1

LABEL SET

300095965 LABEL SET NETWORK INTERFACE TMS							
5126839	1	PK	Set of 8 labels, packaged as a set.				

LAMP

260386933 LAMP 703296 C0058102							
N		EA	1	4			1
Lamp for tape drive and A8DS.							

260387006 LAMP CABINET 65-82296H02 AMBER							
N		EA	1	4			1
Incandescent, 125 volts, .080 amps, Motorola.							

260387014 LAMP CABINET 65-83183G04 RED MOTOROLA							
N		EA	1	4			1
Incandescent, 125 volts, .080 amps.							

260387345 LAMP INCANDESCENT 120PSB							
N		EA	1	1			1
Slide base T2.							

260380647 LAMP INCANDESCENT 5V 913800060							
N		EA	21	2			21
T1 flange base.							

LAMP MINIATURE

997753223 LAMP 5W S14 60V GREEN							
1197889	1	EA	A 5 Watt bulb, 14/8in in diameter, 3 1/2in long, medium base. For use in the central office for various signal circuits.				

997623590 LAMP 6S6 GE							
1198267	1	EA	IL 31 IN 31 MI 31 OH 31 WI 31	6 Watt, candelabra screw base, 1 7/8in max. length X 6/8in diameter lamp used in Bryant. 427 flush lamp receptacle on equipment frames, transformer vault switches, etc.			

400789442 LAMP MINIATURE 388 24 VOLTS							
1153536	1	EA	IL 31 IN 31 MI 31 OH 31 WI 31	Used as indicator lite in switching & toll offices.			

400861860 LAMP MINIATURE 1823 48 VOLTS							
1940189	1	EA	IL 31 IN 31 MI 31 OH 31 WI 31	Lamp used in switching and transmission systems.			

260367578 LAMP MINIATURE 48PSB							
N		EA	10	2			20

PRODUCT IDENTIFIER		DESCRIPTION				
ITEM NUMBER	ORD. MULT.	SELL UNIT	STD. PKG. STOCK AVAILABILITY / PA	LEAD TIME	MIN. ORD.	A C
260382627 LAMP MINIATURE 48PSB5 48 VOLT						
N		EA	1	2	1	
1/4IN X 1IN.						
260387188 LAMP MINIATURE 48PSB6						
N		EA	1	2	1	

LAMP RESISTANCE

100317239 LAMP RESISTANCE 13A						
N		EA	1	1	1	
Tungsten filament lamp equipped with a molded base having two soldering terminals. Used with E, R or U relays.						
100317254 LAMP RESISTANCE 13C						
N		EA	1	1	1	
Tungsten filament lamp equipped with a molded base having two soldering terminals. Used with E, R or U relays.						
100317262 LAMP RESISTANCE 13D						
N		EA	1	1	1	
Tungsten filament lamp equipped with a molded base having two soldering terminals. Used with E, R or U relays.						
260386685 LAMP RESISTANCE 22A INDIVIDUAL						
N		EA	1	14	1	

LENS INDICATOR

101540730 LENS INDICATOR 1A						
2751388	1					
101540748 LENS INDICATOR 1B M/D						
2751404	1	EA	IL 04	IN 04	MI 04	OH 04 WI 04
DISCONTINUED - NO REPLACEMENT.						
101540763 LENS INDICATOR 1D						
2751446	1	EA	IL 04	IN 04	MI 04	OH 04 WI 04
102023041 LENS INDICATOR 1F						
2751487	1	EA	IL 04	IN 04	MI 04	OH 04 WI 04

PRODUCT IDENTIFIER		DESCRIPTION				
ITEM NUMBER	ORD. MULT.	SELL UNIT	STD. PKG. STOCK AVAILABILITY / PA	LEAD TIME	MIN. ORD.	A C

LOOP CONVERSION

SEE UNIT.

LUBRICANT

002088912 LUBRICANT MS 181						
1132258	1	EA				
Lubricant for all type central office switches requiring lubricating of mechanical devices.						
900565250 LUBRICANT SILICONE OIL SF-1147-200						
N		LB	35	13	35	

LUG

260380449 LUG 2456-127						
N		EA	1	8	1	
260380365 LUG 2456-326						
1973420	1	EA	IL 09	IN	MI	OH 09 WI

MACHINE RING

401215637 MACHINE RING CK15804 L6						
N		EA	1	2	1	
KS-15804 Ringing machines are plug-in, single-frame, 1200 RPM, enclosed units arranged to operate from a 48V DC source or a 115V 60HZ AC source.						

MAGNET

840021885 MAGNET HOLD 840021885						
N		EA	1	1	1	
840021869 MAGNET SELECT 840021869						
N		EA	1	1	1	
841186893 MAGNET SELECT 841186893						
N		EA	1	4	1	

MANUAL

401874219 MANUAL CK21113 L505						
N		EA	1	13	1	
401874227 MANUAL CK21114 L505						
N		EA	1	13	1	

MARKER

280013442 MARKER BRADY ESS-1						
N		BX	1	2	1	
Card of 6, Box of 25.						

DISTRIBUTION SERVICES
 NETWORK SERVICES
 TOOLS
 BUILDING JANITORIAL
 AUTOMOTIVE
 FORMS/OFFICE SUPPLIES
 GENERAL
 DATA VOICE

DISTRIBUTION SERVICES

NETWORK SERVICES

TOOLS

BUILDING JANITORIAL

AUTOMOTIVE

FORMS/OFFICE SUPPLIES

GENERAL

DATA VOICE

MARKER

PRODUCT IDENTIFIER		DESCRIPTION						
ITEM NUMBER	ORD. MULT.	SELL UNIT	STD. PKG. STOCK AVAILABILITY / PA	LEAD TIME	MIN. ORD.	A	C	
260386974		MARKER	MAGNETIC TAPE BOT-250					
N		BX	1	2	1			
260387113		MARKER	MARCO METAL S-1141					
N		QT	1	2	1			
280062548		MARKER	SPECIAL SERVICE C675 RED					
1934125	1	EA	IL IN MI OH WI 08 08 08 08					
Marking cap for 4A Protector Unit.								
280062530		MARKER	SPECIAL SERVICE C675C RED					
1934133	1	EA	IL IN MI OH WI 08 08 08 08					
Marking cap for 4C Protector Unit.								
260442173		MARKER	SPECIAL SERVICE C-675 CENG 1.544					
N		EA	100	3	100			
RED.								
260383476		MARKER	SPECIAL SERVICE C-675-AENG 1.544					
N		EA	1	2	1			
A red marking cap for Protector Unit 4A.								
260357181		MARKER	WARNING TYPE E CA08590					
N		EA	1	2	20			
Substitute for 302, 303, 305, 308 & 310 Protector Unit for high voltage-avoid test, red, BSP-074-238-115.								
MODEM								
260441027		MODEM	048P033-001					
N		EA	1	1	1			
Digital unit used on DDS facilities (sync & async).								
260441043		MODEM	053P001-004					
N		EA	1	6	1			
4-wire private line modem used for Voice Mail applications.								
260441035		MODEM	071P001-001					
N		EA	1	2	1			
Dial-up 1200 bps modem used in Central Office applications.								
260448907		MODEM	1200 BAUD UDS-212A/D					
N								
2 per system, Inmate Services Equipment.								
260446646		MODEM	BAUD 1200 UDS-212A/D 1 PER SYSTEM					
N								
For Central Office.								
MODULE								
260448808		MODULE	4 CHANNEL ANNOUNCER 700643-501					
N								
Standard, 1 per 64 lines. Inmate Services Equipment.								

PRODUCT IDENTIFIER		DESCRIPTION						
ITEM NUMBER	ORD. MULT.	SELL UNIT	STD. PKG. STOCK AVAILABILITY / PA	LEAD TIME	MIN. ORD.	A	C	
260448816		MODULE	4 CHANNEL ANNOUNCER 700736-501					
N								
Bi-lingual, 1 per 64 lines. Inmate Services Equipment.								
402281158		MODULE	4255					
N		EA	1	4	1			
280003203		MODULE	4445 DUAL 5 WAY					
N		EA	1	1	1			
Active Data Bridge.								
280003211		MODULE	4449 DUAL 9 WAY					
N		EA	1	1	1			
Active Data Bridge.								
260971270		MODULE	9021					
N		EA	1	6	1			
260413398		MODULE	ALARM 3192-9F101					
1971390	1	EA	IL IN MI OH WI 09					
260448790		MODULE	ALARM 610106-501					
N								
1 per 64 lines. Inmate Services Equipment.								
002073997		MODULE	AMLII BDP77-131-04					
1107508	1	EA	IL IN MI OH WI 18 18 18 18					
0020247932		MODULE	AMLII HVR77-231-04					
1220236	1	EA	IL IN MI OH WI 18 18 18 18					
DISCONTINUE UPON STOCK DEPLETION - REPLACED BY MODULE AMLIII HRV77-431-04.								
260962279		MODULE	AMLIII 77-210-00 CO					
N		EA	1	4	1			
260962402		MODULE	AMLIII 77-331-04 SUB BD					
N		EA	1	4	1			
260404884		MODULE	AMLIII HRV77-431-04					
1969287	1	EA	IL IN MI OH WI 18 18 18 18					
104032677		MODULE	CIRCUIT 205A					
N		EA	1	14	1			
260448824		MODULE	DATABASE CONTROL 7000738-501					
N								
7,000 pins, 1 per system. Inmate Services Equipment.								
260448832		MODULE	DATABASE CONTROL 7000738-502					
N								
3,500 pins, 1 per system. Inmate Services Equipment.								
260419098		MODULE	DS3 DSX-4H-MBRC					
N		EA	1	4	1			
24 terminal, rear x-connect, mid-size, 75 ohm BNC connector.								

PRODUCT IDENTIFIER		DESCRIPTION					
ITEM NUMBER	ORD. MULT.	SELL UNIT	STD. PKG. STOCK AVAILABILITY / PA	LEAD TIME	MIN. ORD.	A	C
260413323 MODULE DS3 DSX-4H-SBRC							
1971325	1	EA	IL IN MI OH WI 09 09				
24 terminal, rear x-connect, standard, 75 ohm BNC connector.							
260417977 MODULE DS3 REAR CROSS-CONNECT							
N		EA	1	4	1		
Mid-size, 18 terminal per shelf, 75 Ohm BNC LEDs.							
260427752 MODULE DS3 RR X-CONN STANDARD BNC							
1977611	1	EA	IL IN MI OH WI 04 04 04 04				
260986310 MODULE FAN 23IN CPR# 001826							
N		EA	1	4	1		
260442090 MODULE FUSE & DISTRIBUTION 4285-00							
N		EA	1	4	1		
Used inside a rack mount shelf in a CO, hut, or remote terminal, etc.							
260330808 MODULE INTERFACE 4WDLT B91G35100							
N		EA	1	13	1		
260442199 MODULE MUTUAL DRAINAGE REACTOR							
N		EA	1	3	1		
Positron 751300.							
260969852 MODULE NCDLT30 7002A							
1245530	1	EA	IL IN MI OH WI				
260413356 MODULE PATCH MPOP-3							
1971358	1	EA	IL IN MI OH WI 09				
402036206 MODULE POWER DPM 716CP 30							
N		EA	1	6	1		
260330782 MODULE POWER SUPPLY 48 VOLT DC							
N		EA	1	13	1		
A97GAL492.							
260448840 MODULE QUAD LINE 700740-501							
N							
1 per 4 lines. Inmate Services Equipment.							
260448857 MODULE QUAD LINE I/O FAIL IN-SVC 610123-							
N							
503. 1 per 4 lines. Inmate Services Equipment.							
260448865 MODULE QUAD LINE I/O FAIL OUT-SVC 610123							
N							
-504. 1 per 4 lines, Inmate Services Equipment.							
280040486 MODULE RING DETECT							
1953786	1	EA	IL IN MI OH WI 75				
300025756 MODULE SIGNAL SFS5260							
1193813	1	EA	IL IN MI OH WI 39 39				

PRODUCT IDENTIFIER		DESCRIPTION					
ITEM NUMBER	ORD. MULT.	SELL UNIT	STD. PKG. STOCK AVAILABILITY / PA	LEAD TIME	MIN. ORD.	A	C
300030194 MODULE SIGNAL SFT 5670							
1222059	1	EA	IL IN MI OH WI 39 39				
260986575 MODULE SLAVE PROCESSOR 815375							
N		EA	1	2	1		
260448782 MODULE SUBRACK CONTROL 700748-501							
N							
1 per 64 lines. Inmate Services Equipment.							
260341474 MODULE X-CONN DSX-4M-SBRC							
1949859	1	EA	IL IN MI OH WI 04 04 04 04				
18 terminal per shelf, 75 Ohm BNC LEDs.							
MOTOR							
400512000 MOTOR ASSEMBLY SYNCHRONOUS							
N		EA	1	14	1		
401871181 MOTOR CAPSTAN L502558							
N		EA	1	13	1		
997069349 MOTOR CK19686 L 1							
N		EA	1	2	1		
997069471 MOTOR DC FOR SINGLE CARD							
N		EA	1	20	1		
402248686 MOTOR GE5KH19FGR353							
N		EA	1	6	1		
401871173 MOTOR REEL L502554							
N		EA	1	13	1		
MOUNTING							
260962857 MOUNTING 97060-00							
N		EA	1	10	1		
841168388 MOUNTING ANGLE							
N		EA	1	15	1		
260961941 MOUNTING COMFAB 4412U							
N		EA	1	11	1		
260961933 MOUNTING COMFAB 4424U							
N		EA	1	11	1		
100324599 MOUNTING JK 230A							
N		EA	2	2	2		
100324656 MOUNTING JK 231A							
N		EA	2	2	2		
100324821 MOUNTING JK 237A							
N		EA	1	1	1		
842310773 MOUNTING PLATE 842310773 23IN							
N		EA	1	2	1		

DISTRIBUTION SERVICES
 NETWORK SERVICES
 TOOLS
 BUILDING JANITORIAL
 AUTOMOTIVE
 FORMS/OFFICE SUPPLIES
 GENERAL
 DATA VOICE

MOUNTING

PRODUCT IDENTIFIER DESCRIPTION

ITEM NUMBER	ORD. MULT.	SELL UNIT	STD. PKG. STOCK AVAILABILITY / PA	LEAD TIME	MIN. ORD.	A C
-------------	------------	-----------	-----------------------------------	-----------	-----------	-----

260435789 MOUNTING RECTIFIER
 N EA 1 4 1

260963467 MOUNTING TELABS 263E1
 1237057 1 EA IL IN MI OH WI

002090678 MOUNTING TL 4002
 1149716 1 EA IL IN MI OH WI
 04 04 04

002091783 MOUNTING TL 4004
 1160556 1 EA IL IN MI OH WI
 04 04 04

002090645 MOUNTING TL 4005
 1178657 1 EA IL IN MI OH WI
 04 04 04

002090652 MOUNTING TL 4007
 1214510 1 EA IL IN MI OH WI
 04 04 04

002090686 MOUNTING TL 4016
 1179895 1 EA IL IN MI OH WI
 04 04 04

300033685 MOUNTING TL 4017
 1214031 1 EA IL IN MI OH WI
 04 04 04

260032461 MOUNTING WSCM 829MA-8
 1231449 1 EA IL IN MI OH WI

MOUNTING APPARATUS

100321249 MOUNTING APPARATUS 9A
 N EA 1 6 1

100321264 MOUNTING APPARATUS 11A
 N EA 1 2 1

100321306 MOUNTING APPARATUS 15A
 N EA 1 6 1

103157277 MOUNTING APPARATUS 36C
 N EA 1 13 1

101286185 MOUNTING APPARATUS 68B
 N EA 1 13 1

103038618 MOUNTING APPARATUS 108A
 N EA 1 13 1

103038626 MOUNTING APPARATUS 108B
 N EA 1 13 1

102960622 MOUNTING APPARATUS 110A
 N EA 1 4 1

PRODUCT IDENTIFIER DESCRIPTION

ITEM NUMBER	ORD. MULT.	SELL UNIT	STD. PKG. STOCK AVAILABILITY / PA	LEAD TIME	MIN. ORD.	A C
-------------	------------	-----------	-----------------------------------	-----------	-----------	-----

NETWORK

260387089 NETWORK 177K
 N EA 1 6 1
 Used for contact protection of relays and switches in telephone switching systems.

100331412 NETWORK 178A
 N EA 1 1 1
 Package of 15.

100331461 NETWORK 185A
 1193714 1 EA IL IN MI OH WI
 09 09 09 09 09

100331479 NETWORK 185C
 N EA 1 1 1

100331487 NETWORK 186A
 1203240 1 EA IL IN MI OH WI
 09 09 09 09 09

100331495 NETWORK 186B
 5158147 1 EA IL IN MI OH WI
 09 09 09 09 09

102858180 NETWORK 1016B
 N EA 1 6 1

100346121 NETWORK 4042A
 N EA 1 1 1

260383336 NETWORK 4228F
 N EA 1 2 1

102739562 NETWORK 4270A
 N EA 1 14 1

401789425 NETWORK CK21567 L1
 N EA 1 8 1

401789433 NETWORK CK21567 L2
 N EA 1 18 1

NODE

260341839 NODE LINK CARD WITH COAX POCKET
 N EA 1 17 1

260341821 NODE LINK CARD WITHOUT COAX POCKET
 N EA 1 17 1

NUT

841064793 NUT 841064793
 N EA 1 2 1
 Hexagon nut 1/2IN - 13. Outside UNC-2B, steel zinc (universal item) used everywhere.

DISTRIBUTION SERVICES

NETWORK SERVICES

TOOLS

BUILDING JANITORIAL

AUTOMOTIVE

FORMS/OFFICE SUPPLIES

GENERAL

DATA VOICE

DISTRIBUTION SERVICES

NETWORK SERVICES

TOOLS

BUILDING JANITORIAL

AUTOMOTIVE

FORMS/OFFICE SUPPLIES

GENERAL

DATA VOICE

PRODUCT IDENTIFIER		DESCRIPTION				
ITEM NUMBER	ORD. MULT.	SELL UNIT	STD. PKG. STOCK AVAILABILITY / PA	LEAD TIME	MIN. ORD.	A C
OIL						
260386768 OIL CK16326 L1						
N		EA	8	2	8	
400163150 OIL CK16729 L1 PINT CAN						
1204701	1	EA	IL 08 IN 08 MI 08 OH 08 WI 08			
ORGANIZER						
260380837 ORGANIZER SPLICE ASSEMBLY LT1AF/F						
1960849	1	EA	Electronic equipment components to be assembled within a Fujitsu 6200 cabinet.			
OSCILLATOR						
300041001 OSCILLATOR MODEL 1						
4204982	1	EA	Broadcast circuit oscillator.			
O-RING						
996065868 O-RING 1/4IN X 3/8IN X 1/16IN						
N		EA	1	13	1	
PACK BATTERY						
260320809 PACK BATTERY FOR MODEL 7856-BP						
N		EA	1	4	1	
PACK CIRCUIT						
600216675 E-911 PACK CIRCUIT ED69933-30 G1						
1939942	1	EA	Used with the enhanced E911 Emergency Reporting System.			
600216683 E-911 PACK CIRCUIT ED69934-30 G1						
1939959	1	EA	IL 18 IN 18 MI OH WI 18	Used with the enhanced E911 Emergency Reporting System.		
600216691 E-911 PACK CIRCUIT ED69935-30 G1						
1939967	1	EA	IL 18 IN MI OH WI 18	Used with the enhanced E911 Emergency Reporting System.		
103228458 E-911 PACK CIRCUIT LC 266						
1939926	1	EA	IL 18 IN MI OH WI	Used with the Enhanced E911 Emergency Reporting System.		

PRODUCT IDENTIFIER		DESCRIPTION				
ITEM NUMBER	ORD. MULT.	SELL UNIT	STD. PKG. STOCK AVAILABILITY / PA	LEAD TIME	MIN. ORD.	A C
260391313 PACK CIRCUIT LC262C						
1965921	1	EA	IL IN MI OH WI 18 18	Line circuit.		
100352301 PACK CIRCUIT A 6						
N		EA	1	3	1	
101425742 PACK CIRCUIT A 338						
N		EA	1	7	1	
101162675 PACK CIRCUIT A 656						
N		EA	1	6	1	
101215085 PACK CIRCUIT A 745						
N		EA	1	14	1	
101664878 PACK CIRCUIT A 831						
N		EA	1	13	1	
101911915 PACK CIRCUIT A 963						
N		EA	1	13	1	
103659298 PACK CIRCUIT AEL 25						
N		EA	1	1	1	
104391222 PACK CIRCUIT AHG 15						
N		EA	1	1	1	
102284304 PACK CIRCUIT AR 659						
N		EA	1	27	1	
102284312 PACK CIRCUIT AR 660						
N		EA	1	2	1	
102538725 PACK CIRCUIT AR 754						
N		EA	1	14	1	
102915881 PACK CIRCUIT AR 906						
N		EA	1	2	1	
101215515 PACK CIRCUIT CF 1						
N		EA	1	2	1	
100355387 PACK CIRCUIT D 3						
N		EA	1	2	1	Series-1-5 CLEI XSPQOO.
100355395 PACK CIRCUIT D 4						
N		EA	1	2	1	
260977277 PACK CIRCUIT ENPQ67A NT3X16BB						
N		EA				
102574076 PACK CIRCUIT FA 15						
N		EA	1	2	1	
102574084 PACK CIRCUIT FA 18						
N		EA	1	2	1	
102574480 PACK CIRCUIT FA 82						
N		EA	1	2	1	

PACK CIRCUIT

DISTRIBUTION SERVICES

NETWORK SERVICES

TOOLS

BUILDING JANITORIAL

AUTOMOTIVE

FORMS/OFFICE SUPPLIES

GENERAL

DATA VOICE

PRODUCT IDENTIFIER		DESCRIPTION				
ITEM NUMBER	ORD. MULT.	SELL UNIT	STD. PKG. STOCK AVAILABILITY / PA	LEAD TIME	MIN. ORD.	A C
102574597		PACK	CIRCUIT FA 121			
N		EA	1	2	1	
102574985		PACK	CIRCUIT FA 176			
N		EA	1	2	1	
103670741		PACK	CIRCUIT FA 208B			
N		EA	1	2	1	
102575396		PACK	CIRCUIT FA 244			
N		EA	1	2	1	
103323507		PACK	CIRCUIT FA1810			
N		EA	1	2	1	
102648417		PACK	CIRCUIT FB 367			
N		EA	1	2	1	
102692332		PACK	CIRCUIT FB 372			
N		EA	1	2	1	
102648466		PACK	CIRCUIT FB 383			
N		EA	1	2	1	
102605870		PACK	CIRCUIT FB 428			
N		EA	1	2	1	
102692449		PACK	CIRCUIT FB 500			
N		EA	1	8	1	
102692456		PACK	CIRCUIT FB 501			
N		EA	1	8	1	
102692464		PACK	CIRCUIT FB 502			
N		EA	1	8	1	
102692472		PACK	CIRCUIT FB 504			
N		EA	1	8	1	
102692480		PACK	CIRCUIT FB 505			
N		EA	1	12	1	
102692498		PACK	CIRCUIT FB 506			
N		EA	1	8	1	
102692506		PACK	CIRCUIT FB 507			
N		EA	1	8	1	
102692514		PACK	CIRCUIT FB 508			
N		EA	1	8	1	
102692522		PACK	CIRCUIT FB 509			
N		EA	1	8	1	
102692530		PACK	CIRCUIT FB 510			
N		EA	1	7	1	
102692548		PACK	CIRCUIT FB 511			
N		EA	1	8	1	
102692555		PACK	CIRCUIT FB 512			
N		EA	1	8	1	

PRODUCT IDENTIFIER		DESCRIPTION				
ITEM NUMBER	ORD. MULT.	SELL UNIT	STD. PKG. STOCK AVAILABILITY / PA	LEAD TIME	MIN. ORD.	A C
102692563		PACK	CIRCUIT FB 513			
N		EA	1	8	1	
102692589		PACK	CIRCUIT FB 515			
N		EA	1	8	1	
102692605		PACK	CIRCUIT FB 517			
N		EA	1	8	1	
102726817		PACK	CIRCUIT FB 518			
N		EA	1	8	1	
102692613		PACK	CIRCUIT FB 519			
N		EA	1	8	1	
102692621		PACK	CIRCUIT FB 521			
N		EA	1	8	1	
102692639		PACK	CIRCUIT FB 522			
N		EA	1	8	1	
102692670		PACK	CIRCUIT FB 526			
N		EA	1	8	1	
102692688		PACK	CIRCUIT FB 527			
N		EA	1	8	1	
102692696		PACK	CIRCUIT FB 528			
N		EA	1	8	1	
102692704		PACK	CIRCUIT FB 529			
N		EA	1	8	1	
103244679		PACK	CIRCUIT FB 669			
N		EA	1	13	1	
103729315		PACK	CIRCUIT FB 698			
N		EA	1	2	1	
102692712		PACK	CIRCUIT FC 182			
N		EA	1	16	1	
102692720		PACK	CIRCUIT FC 183			
N		EA	1	16	1	
102692738		PACK	CIRCUIT FC 184			
N		EA	1	7	1	
103715512		PACK	CIRCUIT FC 661			
N		EA	1	2	1	
103323556		PACK	CIRCUIT FC 664			
N		EA	1	2	1	
103323564		PACK	CIRCUIT FC 665			
N		EA	1	2	1	
103323572		PACK	CIRCUIT FC 666			
N		EA	1	2	1	
103657037		PACK	CIRCUIT FC 675			
N		EA	1	8	1	

PRODUCT IDENTIFIER		DESCRIPTION					MIN. A
ITEM NUMBER	ORD. MULT.	SELL UNIT	STD. PKG. STOCK AVAILABILITY / PA	LEAD TIME	MIN. ORD.	A C	
103657052		EA	1	8	1		
103657052 PACK CIRCUIT FC 677							
N		EA	1	8	1		
103730628		EA	1	18	1		
103730628 PACK CIRCUIT FE 101							
N		EA	1	18	1		
103705612		EA	1	10	1		
103705612 PACK CIRCUIT FE 126							
N		EA	1	10	1		
103060182		EA	4	2	1		
103060182 PACK CIRCUIT FG 68							
N		EA	4	2	1		
102300548		EA	1	13	1		
102300548 PACK CIRCUIT JM 1							
N		EA	1	13	1		
102300225		EA	1	22	1		
102300225 PACK CIRCUIT JT 1							
N		EA	1	22	1		
102300241		EA	1	13	1		
102300241 PACK CIRCUIT JT 2							
N		EA	1	13	1		
102300233		EA	1	2	1		
102300233 PACK CIRCUIT JT 3							
N		EA	1	2	1		
102300290		EA	1	2	1		
102300290 PACK CIRCUIT JT 4							
N		EA	1	2	1		
102396538		EA	1	10	1		
102396538 PACK CIRCUIT JW 72							
N		EA	1	10	1		
102394863		EA	1	10	1		
102394863 PACK CIRCUIT JW 80							
N		EA	1	10	1		
103763702		EA	1	10	1		
103763702 PACK CIRCUIT JW 101B							
N		EA	1	10	1		
300039187		EA	1	6	1		
300039187 PACK CIRCUIT LB00386CC1B							
N		EA	1	6	1		
102658119		EA	1	13	1		
102658119 PACK CIRCUIT LC 154							
N		EA	1	13	1		
103152237		EA	1	8	1		
103152237 PACK CIRCUIT LC 169 MC 5A1							
N		EA	1	8	1		
260391339 PACK CIRCUIT LC 264AT							
1965913	1	EA	IL IN MI OH WI	18	18		
260392352 PACK CIRCUIT LC 268							
1965947	1	EA	IL IN MI OH WI	18	18		
103202867		EA	1	8	1		
103202867 PACK CIRCUIT LC 337							
N		EA	1	8	1		
103195947		EA	1	8	1		
103195947 PACK CIRCUIT LC 412 V2							
N		EA	1	8	1		
103152229		EA	1	8	1		
103152229 PACK CIRCUIT LC 445							
N		EA	1	8	1		

PRODUCT IDENTIFIER		DESCRIPTION					MIN. A
ITEM NUMBER	ORD. MULT.	SELL UNIT	STD. PKG. STOCK AVAILABILITY / PA	LEAD TIME	MIN. ORD.	A C	
260976899		EA	1		1		
260976899 PACK CIRCUIT PWPQ660 SP7B S2							
N		EA	1		1		
260013719		EA	1	13	1		
260013719 PACK CIRCUIT RSPQ05C FE101 S26							
N		EA	1	13	1		
AT&T COMCODE 103730628							
405105644 PACK CIRCUIT SM 250							
1939983	1	EA	IL IN MI OH WI	22			
104178264 PACK CIRCUIT SN 101B							
N		EA	1	9	1		
104193511		EA	1	2	1		
104193511 PACK CIRCUIT SP 1C							
N		EA	1	2	1		
102857919		EA	1	2	1		
102857919 PACK CIRCUIT SP 4							
N		EA	1	2	1		
104052816		EA	1	2	1		
104052816 PACK CIRCUIT TN1001B							
N		EA	1	2	1		
102996006		EA	1	2	1		
102996006 PACK CIRCUIT UD 1							
N		EA	1	2	1		
102996014		EA	1	2	1		
102996014 PACK CIRCUIT UD 2							
N		EA	1	2	1		
PACKET							
260341904		EA	1	17	1		
260341904 PACKET BUS TERMINATOR CARD							
N		EA	1	17	1		
PACKS							
841351455		EA	1	7	1		
841351455 PACKS TERMINATION 841351455							
N		EA	1	7	1		
841351471		EA	1	7	1		
841351471 PACKS TERMINATION 841351471							
N		EA	1	7	1		
841351497		EA	1	7	1		
841351497 PACKS TERMINATION 841351497							
N		EA	1	7	1		
841351539		EA	1	7	1		
841351539 PACKS TERMINATION 841351539							
N		EA	1	7	1		
841351570		EA	1	7	1		
841351570 PACKS TERMINATION 841351570							
N		EA	1	7	1		
841351604		EA	1	7	1		
841351604 PACKS TERMINATION 841351604							
N		EA	1	7	1		
841351646		EA	1	7	1		
841351646 PACKS TERMINATION 841351646							
N		EA	1	7	1		
841351687		EA	1	7	1		
841351687 PACKS TERMINATION 841351687							
N		EA	1	7	1		
947 type connector.							

DISTRIBUTION SERVICES
 NETWORK SERVICES
 TOOLS
 BUILDING JANITORIAL
 AUTOMOTIVE
 FORMS/OFFICE SUPPLIES
 GENERAL
 DATA VOICE

PACKS

PRODUCT IDENTIFIER		DESCRIPTION				
ITEM NUMBER	ORD. MULT.	SELL UNIT	STD. PKG. STOCK AVAILABILITY / PA	LEAD TIME	MIN. ORD.	A C

841351729		PACKS	TERMINATION	841351729		
N		EA	1	7	1	

PAD

842593584		PAD	HEATER SHELF BATTERY			
N		EA	1	4	1	
			EFH335-129.			

280015678		PAD	PADDLE MPS-27275 DET 2-3			
N		EA	51	2	1	

403339351		PAD	PADDLE MPS-27275 DET 5			
1938373	1	EA	IL IN MI OH WI			
			09 09 09 09 09			

260387055		PAD	PADDLE NPS-27275 DET 5			
N		EA	1	4	1	

260387105		PAD	POCKET MARCO INSPECTOR #10			
N		EA	1	2	1	

260338777		PAD	SPAN T CARRIER 7.5DB			
1948646	1	EA	IL IN MI OH WI			
			09 09 09 09 09			

260344791		PAD	SPAN T CARRIER 9.0DB			
1950667	1	EA	IL IN MI OH WI			
			09 09 09 09 09			

260344783		PAD	SPAN T CARRIER 10.5DB			
1950659	1	EA	IL IN MI OH WI			
			09 09 09 09 09			

260344775		PAD	SPAN T CARRIER 12.0DB			
1950642	1	EA	IL IN MI OH WI			
			09 09 09 09 09			

PANEL

101822930		PANEL	603A			
N		EA	1	6	1	

260393012		PANEL	3500-115X			
N		EA	1	4	1	

260380423		PANEL	4377-154			
N		EA	1	8	1	

840981666		PANEL	840981666			
N		EA	1	16	1	

260430426		PANEL	AC OUTLET			
1978726	1	EA	IL IN MI OH WI			
			09 09 09 09 09			

260421128		PANEL	ALARM AUXILIARY			
N		EA	1	6	1	

260392923		PANEL	ALARM AUXILIARY 3500-112A			
N		EA	1	4	1	

PRODUCT IDENTIFIER		DESCRIPTION				
ITEM NUMBER	ORD. MULT.	SELL UNIT	STD. PKG. STOCK AVAILABILITY / PA	LEAD TIME	MIN. ORD.	A C

260394978		PANEL	ALARM INTERFACE	120444		
N		EA	1	4	1	

845196930		PANEL	ASSEMBLY	845196930		
N		EA	1	3	1	

260380845		PANEL	BATTERY CONTROL	HA15B-0001-C007		
1960773	1	EA	IL IN MI OH WI			
			09 09 09 09 09			
Electronic equipment components to be assembled within a Fujitsu 6200 cabinet.						

260448881		PANEL	BLANK BOARD FOR OPEN SLOTS	610121-		
N						
			501			

260964358		PANEL	CHANNEL PROTECTION	97040-00		
1238287	1	EA	IL IN MI OH WI			

260448915		PANEL	CIRCUIT BREAKER	400267-501-7-16-20		
N						
(7)-22. 1 per system, Inmate Services Equipment.						

260376124		PANEL	COMMUNICATION			
1961458	1	EA	IL IN MI OH WI			
			09 09 09 09 09			
9 dual lines, comp-2.						

260439591		PANEL	COMMUNICATION	E-501 L140		
N		EA	1	3	1	

260401138		PANEL	CROSS AISLE	DSX-CAP-BEST		
N		EA	1	4	1	

260382429		PANEL	DISTRIBUTION	10-BANK 18314		
N		EA	1	4	1	

260401039		PANEL	DMS-1U SMALL RECTIFIER	BROWN		
N						

260431499		PANEL	DS1 3-SHELF	D1M-1E1003		
1978981	1	EA	IL IN MI OH WI			

260431069		PANEL	DS1 TEST ACCESS			
1978908	1	EA	IL IN MI OH WI			
			09 09 09 09 09			

260437975		PANEL	DSX 60 PORT	D05-R430-605		
N		EA	1	4	1	

260421870		PANEL	DSX-1/3 W/3	MPOP		
N		EA	1	4	1	

260371562		PANEL	DSX-4M-W9C	18CKT		
1956136	1	EA	IL IN MI OH WI			
			09 09 09 09 09			

300078128		PANEL	DSX-BEST-56			
1192971	1	EA	IL IN MI OH WI			
			09 09 09 09 09			

ADC 424419-0030.

DISTRIBUTION SERVICES

NETWORK SERVICES

TOOLS

BUILDING JANITORIAL

AUTOMOTIVE

FORMS/OFFICE SUPPLIES

GENERAL

DATA VOICE

PRODUCT IDENTIFIER		DESCRIPTION					
ITEM NUMBER	ORD. MULT.	SELL UNIT	STD. STOCK	PKG. AVAILABILITY / PA	LEAD TIME	MIN. ORD.	A C
260384557 PANEL FAULT LOCATE 005-0010-0002							
1962548	1	EA	IL 09	IN 09	MI 09	OH 09	WI
WECO & EIA. To be used for assembly into Fujitsu 6200 cabinet.							
260438023 PANEL FAULT LOCATE/OW HA15B-0001-078							
N		EA	1		12		1
260438650 PANEL FAULT LOCATE/OW HA15B-0001-B011							
N		EA	1		12		1
260405154 PANEL FILLER 4027-6							
1969378	1	EA	IL 09	IN	MI	OH	WI
260441589 PANEL FLFDSX-28							
N		EA	1		4		1
Flow finder panel.							
260436753 PANEL FLOW FINDER GAUGE 9800-3050							
N		EA	1		3		1
260353685 PANEL FMT150 NT7H46DA							
1952010	1	EA	IL 09	IN 09	MI 09	OH 09	WI
260427844 PANEL FUSE & ALARM 009-0112-1002							
N		EA	1		4		1
260376173 PANEL HORIZONTAL RING DSX-PNLHR-23C							
N							
260421169 PANEL ISOLATION 3500 115X							
N		EA	1		6		1
260392980 PANEL ISOLATION TRANSFORMER							
N		EA	1		4		1
3500-112X.							
260371570 PANEL JACK DSX 64							
1956144	1	EA	IL 09	IN	MI 09	OH 09	WI
260371596 PANEL JACK DSX-BEST-1 23IN							
1956169	1	EA	IL 09	IN	MI 09	OH	WI
260371588 PANEL JACK DSX-BEST-60							
1956151	1	EA	IL 09	IN 09	MI 09	OH	WI
260431507 PANEL JACK DSX-CEV-56							
1978999	1	EA	IL	IN	MI	OH 09	WI
260413331 PANEL JACK DSX-DR 56CKT							
1971333	1	EA	IL 09	IN	MI 09	OH	WI
56 terminal front x-connect.							
260344403 PANEL JACK DSX-MSC-AMTCH							
1949867	1	EA	IL 05	IN	MI	OH	WI

PRODUCT IDENTIFIER		DESCRIPTION					
ITEM NUMBER	ORD. MULT.	SELL UNIT	STD. STOCK	PKG. AVAILABILITY / PA	LEAD TIME	MIN. ORD.	A C
260394960 PANEL MODULAR MP-248 120407							
N		EA	1		4		1
260413349 PANEL PATCH MPOP-3-3 7IN							
1971341	1	EA	IL	IN	MI 09	OH	WI
102592557 PANEL POWER 1A1							
1178616	1	EA	IL 04	IN 04	MI 04	OH 04	WI
The 1A1 power panel is intended for mounting on 23IN cabinets or frames. It consists of 9 AC receptacles & 1 male base receptacle. Currently a 402489645 cable is required to make the unit functional.							
300662510 PANEL POWER DIST DML45							
1230052	1	EA	IL	IN 04	MI	OH	WI
MS406-235.							
103810651 PANEL POWER JACK 1B 367075							
1106435	1	EA	IL 09	IN 09	MI	OH	WI
1B power and jack panel used with RT SLC for power distribution.							
260431044 PANEL T1 FIELD INTERFACE 4 INCH							
1978882	1	EA	IL 09	IN 09	MI 09	OH 09	WI
260431051 PANEL T1 FIELD INTERFACE 6 INCH							
1978890	1	EA	IL 09	IN 09	MI 09	OH 09	WI
W/2 support bars.							
260376322 PANEL TERMINATION WW-223-50X19							
1961474	1	EA	IL 09	IN 09	MI	OH	WI
401824461 PANEL TEST/TALK CK21316 L4							
N		EA	1		9		1
260394994 PANEL WIRE WRAP TCCS-23-20							
N		EA	1		4		1
260394986 PANEL WIRE WRAP TCCS-23-25							
N		EA	1		4		1
PANEL FUSE							
260323746 PANEL FUSE 19A W/5AMP FUSE							
1944140	1	EA					
260964382 PANEL FUSE 97021-00							
N		EA	1		4		1
260376157 PANEL FUSE DSX-FP20A							
1971531	1	EA	IL	IN	MI 09	OH	WI
280004052 PANEL FUSE FILTER J87266J-2L-1							
N		EA	1		2		1

DISTRIBUTION SERVICES
 NETWORK SERVICES
 TOOLS
 BUILDING JANITORIAL
 AUTOMOTIVE
 FORMS/OFFICE SUPPLIES
 GENERAL
 DATA VOICE

PANEL FUSE

PRODUCT IDENTIFIER		DESCRIPTION						
ITEM NUMBER	ORD. MULT.	SELL UNIT	STD. PKG. STOCK AVAILABILITY / PA	LEAD TIME		MIN. ORD.	A C	
260432497 PANEL FUSE & ALARM 4282-146								
1979294	1	EA	IL IN MI OH WI 09 09 09 09					
260413406 PANEL FUSE & ALARM 848108101								
1971408	1	EA	IL IN MI OH WI 09 09 09 09					
260380852 PANEL FUSE & ALARM FC9604FA31								
1960765	1	EA	IL IN MI OH WI 09 09 09 09					
Electronic equipment components to be assembled within a Fujitsu 6200 cabinet. HA15B-5101-B042.								
260432596 PANEL FUSE & ALARM HA15B0001 B088								
1979336	1	EA	IL IN MI OH WI 09 09 09 09					

PAPER CLEANING

995872322 PAPER CLEANING CK07187							
1207662	1	EN					

PATCH CORD

280019886 PATCH CORD 916-400-179 5FT							
N		EA	1	2		1	
Mini plug to alligator clip.							

PEDESTAL

280013061 PEDESTAL TV 1024 UTILITY PR							
N		EA	1	2		1	

PIN

401922059 PIN DESIGNATION CK14174 L 1							
N		EA	1	2		1	
401922067 PIN DESIGNATION CK14174 L 2							
N		EA	1	2		1	
401922075 PIN DESIGNATION CK14174 L 3							
N		EA	1	2		1	
401922083 PIN DESIGNATION CK14174 L 4							
N		EA	1	2		1	
401922091 PIN DESIGNATION CK14174 L 5							
N		EA	1	2		1	
401922109 PIN DESIGNATION CK14174 L 7							
N		EA	1	2		1	
401922125 PIN DESIGNATION CK14174 L10							
N		EA	1	2		1	

PRODUCT IDENTIFIER		DESCRIPTION						
ITEM NUMBER	ORD. MULT.	SELL UNIT	STD. PKG. STOCK AVAILABILITY / PA	LEAD TIME		MIN. ORD.	A C	
260419049 PIN DESIGNATION KS14174 L 1								
1973990	1	EA	IL IN MI OH WI					
Nylon, white, 1.33 AMP.								

PLATE

841656408 PLATE 841656408 ASSEMBLY							
N		EA	1	15		1	
841876741 PLATE 841876741 JUNCTION							
N		EA	1	2		1	
842038937 PLATE 842038937 CEILING							
N		EA	1	1		1	
843063405 PLATE 843063405							
N		EA	1	14		1	
843078155 PLATE 843078155							
N		EA	1	11		1	
843080409 PLATE 843080409							
N		EA	1	10		1	

PLATE MOUNTING

100371905 PLATE MOUNTING 189A DR CD 4251							
N		EA	1	14		1	
102988466 PLATE MOUNTING 1049A							
N		EA	1	2		1	
842532541 PLATE MOUNTING 842532541							
N		EA	1	8		1	
842989451 PLATE MOUNTING 842989451							
N		EA	1	4		1	

PLATE NUMBER

100385756 PLATE NUMBER 30A							
N		EA	1	15		1	
100388701 PLATE NUMBER 141AA							
N		EA	1	9		1	
100388719 PLATE NUMBER 141AB							
N		EA	1	9		1	
100388727 PLATE NUMBER 141AC							
N		EA	1	9		1	
100388735 PLATE NUMBER 141AD							
N		EA	1	9		1	
100388743 PLATE NUMBER 141AE							
N		EA	1	9		1	

DISTRIBUTION SERVICES

NETWORK SERVICES

TOOLS

BUILDING JANITORIAL

AUTOMOTIVE

FORMS/OFFICE SUPPLIES

GENERAL

DATA VOICE

PRODUCT IDENTIFIER		DESCRIPTION				
ITEM NUMBER	ORD. MULT.	SELL UNIT	STD. PKG. STOCK AVAILABILITY / PA	LEAD TIME	MIN. ORD.	A C
100388750		EA	1	9	1	
PLATE NUMBER 141AF						
N		EA	1	9	1	
100388248		EA	1	9	1	
PLATE NUMBER 141D						
N		EA	1	9	1	
100389030		EA	1	9	1	
PLATE NUMBER 142A						
N		EA	1	9	1	
100390061		EA	1	9	1	
PLATE NUMBER 142C						
N		EA	1	9	1	
100391762		EA	1	9	1	
PLATE NUMBER 143AB						
N		EA	1	9	1	
100391770		EA	1	9	1	
PLATE NUMBER 143AC						
N		EA	1	9	1	
100391788		EA	1	9	1	
PLATE NUMBER 143AD						
N		EA	1	9	1	
100391796		EA	1	9	1	
PLATE NUMBER 143AE						
N		EA	1	9	1	
100391804		EA	1	9	1	
PLATE NUMBER 143AF						
N		EA	1	9	1	
100392497		EA	1	9	1	
PLATE NUMBER 143AH						
N		EA	1	9	1	
100390475		EA	1	9	1	
PLATE NUMBER 143B						
N		EA	1	9	1	
100390525		EA	1	9	1	
PLATE NUMBER 143D						
N		EA	1	9	1	
100390533		EA	1	9	1	
PLATE NUMBER 143E						
N		EA	1	9	1	
100391739		EA	1	9	1	
PLATE NUMBER 143H						
N		EA	1	9	1	
100393156		EA	1	3	1	
PLATE NUMBER 145C						
N		EA	1	3	1	
401075536		EA	10	11	10	
PLATE NUMBER CK20642 L7P						

PLUG						
100395003		EA	1	10	1	
PLUG 209						
N		EA	1	10	1	
100395144		EA	1	2	1	
PLUG 240A						
N		EA	1	2	1	
100395185		EA	1	10	1	
PLUG 240F						
N		EA	1	10	1	
100395235		EA	1	1	1	
PLUG 241A						
N		EA	1	1	1	

PRODUCT IDENTIFIER		DESCRIPTION				
ITEM NUMBER	ORD. MULT.	SELL UNIT	STD. PKG. STOCK AVAILABILITY / PA	LEAD TIME	MIN. ORD.	A C
100395391		EA	1	1	1	
PLUG 258C DUMMY BLACK SHELL						
N		EA	1	1	1	
Dummy plugs of insulating material intended for use with jacks that take 310 or similar type plugs.						
100395417		EA	1	1	1	
PLUG 258E WHITE SHELL						
N		EA	1	1	1	
101437911		EA	1	1	1	
PLUG 258F						
N		EA	1	1	1	
101634574		EA	1	7	1	
PLUG 258G						
N		EA	1	7	1	
100395433		EA	1	1	1	
PLUG 262B RED SHELL						
N		EA	1	1	1	

100960772 PLUG 310 RED SHELL						
1226373	1	EA	IL 09	IN 09	MI 09	OH 09 WI 09

100960806		EA	1	10	1	
PLUG 310A						
N		EA	1	10	1	
100396019		EA	1	14	1	
PLUG 327A						
N		EA	1	14	1	
100396175		EA	1	10	1	
PLUG 331A						
N		EA	1	10	1	
100396365		EA	1	2	1	
PLUG 346A						
N		EA	1	2	1	
101335131		EA	1	1	1	
PLUG 347D						
N		EA	1	1	1	
Used with 218 or similar type jacks. DISCONTINUE UPON STOCK DEPLETION						
100396522		EA	1	1	1	
PLUG 354A						
N		EA	1	1	1	
100396670		EA	1	10	1	
PLUG 367A						
N		EA	1	10	1	
101638195		EA	1	10	1	
PLUG 371D						
N		EA	1	10	1	
100396738		EA	1	20	1	
PLUG 372A						
N		EA	1	20	1	
100396837		EA	1	19	1	
PLUG 379A						
N		EA	1	19	1	

100396902 PLUG 386B						
1227769	1	EA	IL 09	IN 09	MI 09	OH 09 WI 09

100397108		EA	1	9	1	
PLUG 399A						
N		EA	1	9	1	
100397371		EA	1	6	1	
PLUG 424A						
N		EA	1	6	1	

DISTRIBUTION SERVICES

NETWORK SERVICES

TOOLS

BUILDING JANITORIAL

AUTOMOTIVE

FORMS/OFFICE SUPPLIES

GENERAL

DATA VOICE

DISTRIBUTION SERVICES

NETWORK SERVICES

TOOLS

BUILDING JANITORIAL

AUTOMOTIVE

FORMS/OFFICE SUPPLIES

GENERAL

DATA VOICE

PLUG

PRODUCT IDENTIFIER		DESCRIPTION						
ITEM NUMBER	ORD. MULT.	SELL UNIT	STD. PKG. STOCK AVAILABILITY / PA	LEAD TIME			MIN. ORD.	A C
101544047 PLUG 453A								
2740522	1	EA	IL 09 IN 09 MI 09 OH 09 WI 09					
101638211 PLUG 463A								
1938365	1	EA	IL 09 IN 09 MI 09 OH 09 WI 09					
101765113 PLUG 464A 3								
2648808	1	EA	IL 09 IN 09 MI 09 OH 09 WI 09					
BSP 028-360-811.								
101765212 PLUG 464A 50								
N		EA					1	1
101827343 PLUG 464C 3								
N		EA				14		1
101828523 PLUG 464C 50								
N		EA				10		1
103086591 PLUG 526A								
N		EA				6		1
103657136 PLUG 700 4 / S								
N		EA				6		1
104194725 PLUG 800 A /12								
N		EA				1		1
260391693 PLUG 800 AD/ 3								
N		EA				1		1
260387030 PLUG 800 AD/ 6								
1965376	1	EA	IL 18 IN 18 MI 18 OH 18 WI 18					
800 DSX plug, 6FT duplex cord, equipped with 800 series plugs.								
104198411 PLUG 800 B / 0								
N		EA				1		1
104366885 PLUG 800 E / 1								
N		EA				1		1
104366901 PLUG 800 G /12								
1956029	1	EA	IL 09 IN 09 MI 09 OH 09 WI 09					
800 DSX plug, 12Ft cord, 800 Series male & 310 male plug.								
104366927 PLUG 800 H /12								
N		EA				1		1
260370291 PLUG 800 H/12								
1956003	1	EA	IL 09 IN 09 MI 09 OH 09 WI 09					
800 DSX cord, 12FT, 800 Series male and Bantam male plug.								
260380712 PLUG 800 K2/ 0								
N		EA				1		1

PRODUCT IDENTIFIER		DESCRIPTION						
ITEM NUMBER	ORD. MULT.	SELL UNIT	STD. PKG. STOCK AVAILABILITY / PA	LEAD TIME			MIN. ORD.	A C
400935615 PLUG 1451 KNOCK OUT THOMAS								
N		EA					4	1
400935607 PLUG 1452 KNOCK OUT THOMAS								
N		EA					4	1
400935623 PLUG 1453 SNAP IN BLK 1								
N		EA					6	1
105773980 PLUG 800 GO/12								
N		EA				25	1	25
901003152 PLUG BLANK VAULT 1IN								
N		EA					1	1
260423439 PLUG BNC A0361621								
1976027	1	EA	IL IN MI OH WI					
260430475 PLUG BNC STRAIGHT A0361621								
1978833	1	EA	IL 09 IN 09 MI 09 OH 09 WI 09					
260376884 PLUG CIRCUIT GUARD CJP-S-RED								
1960500	1	BG	IL 18 IN MI OH WI					
401213533 PLUG CK19332 L 1								
N		EA					2	1
995079654 PLUG CK20085 L10 TWIST OUT								
N		EA					4	1
ITE TPG312-3S.								
400379905 PLUG CK20864 L 2								
N		EA					13	1
401014824 PLUG CK20864 L 3								
N		EA					13	1
260432679 PLUG LBE 1447 10-L40								
1979526	1	EA	IL 09 IN MI OH WI					
For transfer of DS3 x-conn.								
105757926 PLUG LOOP BACK 800K2/0								
N		EA					2	1
Connects out to in.								
402139901 PLUG PJ749 900 OHM								
N		EA					4	13
PLUG SIGNAL								
100397926 PLUG SIGNAL 1A								
N		EA					9	1
100397975 PLUG SIGNAL 3A								
N		EA					10	1
100397991 PLUG SIGNAL 4D								
N		EA					10	1

DISTRIBUTION SERVICES

NETWORK SERVICES

TOOLS

BUILDING JANITORIAL

AUTOMOTIVE

FORMS/OFFICE SUPPLIES

GENERAL

DATA VOICE

PRODUCT IDENTIFIER		DESCRIPTION				
ITEM NUMBER	ORD. MULT.	SELL UNIT	STD. PKG. STOCK AVAILABILITY / PA	LEAD TIME	MIN. ORD.	A C
100398049		PLUG	SIGNAL 5B			
N		EA	1	9	1	
100398056		PLUG	SIGNAL 5C			
N		EA	1	9	1	
100398106		PLUG	SIGNAL 10A			
N		EA	1	1	1	
100398114		PLUG	SIGNAL 10B			
N		EA	1	1	1	
100398122		PLUG	SIGNAL 10C			
N		EA	1	10	1	
100398148		PLUG	SIGNAL 10E			
N		EA	1	1	1	

PLUG-IN

280063603		PLUG-IN	REDUNDANT 5716-010			
N		EA	1	1	1	
0.1VA high tone.						

PORT

260448873		PORT	SERIAL MUX 400261-501-23			
N						
1 per system, Inmate Services Equipment.						
260448931		PORT	TELEBYTE SHARE MODEL 31			
N						
1 per system, Inmate Services Equipment.						

POST FUSE

100398528		POST FUSE	5A			
N		EA	1	9	1	
100398536		POST FUSE	5C			
N		EA	1	9	1	
100398544		POST FUSE	5D			
N		EA	1	9	1	
100398551		POST FUSE	5E			
N		EA	1	9	1	
100398569		POST FUSE	5F			
N		EA	1	9	1	
100398577		POST FUSE	6B			
N		EA	1	9	1	
100398585		POST FUSE	6C			
N		EA	1	9	1	
100398593		POST FUSE	6D			
N		EA	1	9	1	

PRODUCT IDENTIFIER		DESCRIPTION				
ITEM NUMBER	ORD. MULT.	SELL UNIT	STD. PKG. STOCK AVAILABILITY / PA	LEAD TIME	MIN. ORD.	A C
100398601		POST FUSE	6E			
N		EA	1	9	1	
100398619		POST FUSE	6F			
N		EA	1	9	1	

POWER BULK

260435938		BAY DISTRIBUTION	SUPPLEMENTAL 1231A2			
1980425	1	EA				
L-2.						

260435961 CABINET DISTRIBUTION

1980458	1	EA	IL	IN	MI	OH	WI
			09	09	09	09	09
Power plant equipment w/24 position breakers, fuse block assembly (8 positions). Includes quantity 14 of 20 amp breakers.							

260435672 RECTIFIER 50 AMP

1980532	1	EA	IL	IN	MI	OH	WI
---------	---	----	----	----	----	----	----

260435995 SHELF POWER NT5C10AB-4 75A

1980318	1	EA	IL	IN	MI	OH	WI
			09	09	09	09	09
Includes AC cable equipment, PIS twist lock 240V flash 30 amp (3/shelf).							

POWER SUPPLY

SEE SUPPLY POWER.

POWER UNIT

SEE UNIT POWER.

PROTECTOR

260432877		PROTECTOR	FRAME L CHANNEL			
1979278	1	EA				

260432869 PROTECTOR FRAME U CHANNEL

1979260	1	EA	IL	IN	MI	OH	WI
			09	09	09	09	09

260402821 PROTECTOR R399AA CEV 25FT

1968511	1	EA	IL	IN	MI	OH	WI
			09				
For Controlled Environment Vaults.							

260422548 PROTECTOR R399AA F249124

1975698		EA	IL	IN	MI	OH	WI
			09				
For Controlled Environment Vaults.							

260402839 PROTECTOR R399AA-20D 20FT

1968529	1	EA	IL	IN	MI	OH	WI
			09				

260392238 PROTECTOR R399BT 20D

1965772	1	EA	IL	IN	MI	OH	WI
			09				
With T-screw cable.							

PULLEY

PRODUCT IDENTIFIER DESCRIPTION

ITEM	ORD.	SELL	STD. PKG.	LEAD TIME	MIN.	A
NUMBER	MULT.	UNIT	STOCK AVAILABILITY / PA		ORD.	C

PULLEY

996999009		PULLEY RM-699900				
N		EA	1	20	1	

P NUMBERED PARTS

800382632		P038263 WASHER				
N		EA	1	7	1	

800494643		P049464 WASHER				
N		EA	1	6	1	

800686164		P068616 FIBER INSULATOR				
N		EA	1	2	1	

800944423		P094442 HEX NUT				
N		EA	1	2	1	

811062041		P106F04 REPLACEMENT COIL				
N		EA	1	6	1	

811062074		P106F07 REPLACEMENT COIL				
N		EA	1	6	1	

811018860		P10A886 ELECTRO				
N		EA	1	2	1	

811018878		P10A887 ELECTRO				
N		EA	1	2	1	

811018894		P10A889 SPRING				
N		EA	1	2	1	

811018910		P10A891 BUSHING				
N		EA	1	19	1	

811019488		P10A948 GUIDE ASSEMBLY				
N		EA	1	2	1	

811037977		P10C797 SPRING				
N		EA	1	6	1	

811037985		P10C798 SPRING				
N		EA	1	2	1	

811038249		P10C824 CAP ASSEMBLY				
N		EA	1	8	1	

811060383		P10F038 VERT U				
N		EA	1	6	1	

811062025		P10F202 REPLACEMENT COIL				
N		EA	1	6	1	

811062033		P10F203 REPLACEMENT COIL				
N		EA	1	6	1	

811062058		P10F205 REPLACEMENT COIL				
N		EA	1	6	1	

PRODUCT IDENTIFIER DESCRIPTION

ITEM	ORD.	SELL	STD. PKG.	LEAD TIME	MIN.	A
NUMBER	MULT.	UNIT	STOCK AVAILABILITY / PA		ORD.	C

811062066		P10F206 REPLACEMENT COIL				
N		EA	1	6	1	

811062082		P10F208 REPLACEMENT COIL				
N		EA	1	2	1	

811062090		P10F209 REPLACEMENT COIL				
N		EA	1	6	1	

811062157		P10F215 COIL				
N		EA	1	6	1	

811062173		P10F217 COIL				
N		EA	1	6	1	

811062181		P10F218 COIL				
N		EA	1	6	1	

811062207		P10F220 COIL				
N		EA	1	6	1	

811062215		P10F221 COIL				
N		EA	1	6	1	

811062223		P10F222 COIL				
N		EA	1	6	1	

811062231		P10F223 COIL				
N		EA	1	6	1	

811062249		P10F224 COIL				
N		EA	1	6	1	

811062256		P10F225 COIL				
N		EA	1	6	1	

811062264		P10F226 COIL				
N		EA	1	6	1	

811062272		P10F227 COIL				
N		EA	1	6	1	

811064138		P10F413 HOLDING				
N		EA	1	5	1	

811065457		P10F545 COVER				
N		EA	1	13	1	

811069079		P10F907 CARD				
N		EA	1	2	1	

821020047		P10K004 GUARD				
N		EA	1	17	1	

821020062		P10K006 REAR HEAD				
N		EA	1	24	1	

821020070		P10K007 FRONT HEAD				
N		EA	1	24	1	

821022456		P10K245 CABLE ASSEMBLY				
N		EA	1	2	1	
		For 3A Card Writer.				

PRODUCT IDENTIFIER DESCRIPTION						
ITEM	ORD.	SELL	STD. PKG.	LEAD TIME	MIN.	A
NUMBER	MULT.	UNIT	STOCK AVAILABILITY / PA		ORD.	C
821022472	P10K247	PLATE				
N	EA	1		9	1	
801113531	P111353	CLAMP				
N	EA	1		13	1	
801154550	P115455	SCREW				
N	EA	1		14	1	
801189051	P118905	SCREW				
N	EA	1		2	1	
801191578	P119157	SCREW				
N	EA	1		7	1	
811112960	P11A296	TERMINAL				
N	EA	1		15	1	
811113109	P11A310	LOCK				
N	EA	1		2	1	
811113133	P11A313	TERMINAL				
N	EA	1		15	1	
811117118	P11A711	ARMATURE				
N	EA	1		1	1	
811117126	P11A712	ARMATURE				
N	EA	1		5	1	
811117134	P11A713	VERT UNIT ASSEMBLY				
N	EA	1		1	1	
811120237	P11B023	KEY BU				
N	EA	1		14	1	
811120310	P11B031	KEY BU				
N	EA	1		14	1	
811129303	P11B930	NORM PST SPG ASSEMBLY				
N	EA	1		13	1	
811129725	P11B972	BUTTON				
N	EA	1		12	1	
811130210	P11C021	COVER				
N	EA	1		9	1	
811150028	P11E002	ARM AND CLAPPER ASSEMBLY				
N	EA	600		2	600	
811173012	P11G301	FINGER ASSEMBLY LEFT H				
N	EA	1		2	1	
811173020	P11G302	FINGER ASSEMBLY RIGHT H				
N	EA	1		2	1	
811173038	P11G303	FINGER ASSEMBLY				
N	EA	1		2	1	
811173046	P11G304	MAGAZINE INDEXING ASSEMBLY				
N	EA	1		20	1	

PRODUCT IDENTIFIER DESCRIPTION						
ITEM	ORD.	SELL	STD. PKG.	LEAD TIME	MIN.	A
NUMBER	MULT.	UNIT	STOCK AVAILABILITY / PA		ORD.	C
811173053	P11G305	MAGNET INDEXING ASSEMBLY				
N	EA	1		13	1	
811173129	P11G312	BLOCK				
N	EA	1		9	1	
811173137	P11G313	PIN				
N	EA	1		24	1	
811173152	P11G315	SOLENOID				
N	EA	1		13	1	
811173178	P11G317	SHAFT				
N	EA	1		9	1	
811173244	P11G324	SCREW				
N	EA	1		17	1	
811173269	P11G326	SHAFT				
N	EA	1		4	1	
811173293	P11G329	PAWL				
N	EA	1		2	1	
811173327	P11G332	SOLENOID GEAR				
N	EA	1		13	1	
811173418	P11G341	CONNECTING PLATE				
N	EA	1		17	1	
811173483	P11G348	PIN BLOCK				
N	EA	1		12	1	
811173491	P11G349	PIN LOCATING BOTTOM				
N	EA	1		13	1	
811173566	P11G356	PISTON				
N	EA	1		17	1	
811173582	P11G358	COVER				
N	EA	1		24	1	
811173590	P11G359	BEARING				
N	EA	1		13	1	
811173830	P11G383	FINGER ACTUATOR ASSEMBLY				
N	EA	1		2	1	
811173848	P11G384	SOLENOID ASSEMBLY				
N	EA	1		2	1	
811173897	P11G389	INSULATOR				
N	EA	1		13	1	
811173905	P11G390	PLATE				
N	EA	1		24	1	
811173913	P11G391	PIN				
N	EA	1		24	1	
811173921	P11G392	SHAFT				
N	EA	1		9	1	

DISTRIBUTION SERVICES
 NETWORK SERVICES
 TOOLS
 BUILDING JANITORIAL
 AUTOMOTIVE
 FORMS/OFFICE SUPPLIES
 GENERAL
 DATA VOICE

P NUMBERED PARTS

DISTRIBUTION SERVICES

PRODUCT IDENTIFIER		DESCRIPTION				
ITEM NUMBER	ORD. MULT.	SELL UNIT	STD. PKG. STOCK AVAILABILITY / PA	LEAD TIME	MIN. ORD.	A C
811173939	P11G393	SHAFT ASSEMBLY				
N		EA	1	2	1	
811173947	P11G394	SHAFT ASSEMBLY				
N		EA	1	2	1	
811173954	P11G395	FINGER ASSEMBLY				
N		EA	1	2	1	
811174077	P11G407	SCREW				
N		EA	1	24	1	
811174085	P11G408	FINGERS				
N		EA	1	2	1	
811174150	P11G415	STOP				
N		EA	1	9	1	
811174200	P11G420	STOP				
N		EA	1	24	1	
811174234	P11G423	SCREW ASSEMBLY				
N		EA	1	2	1	
811174242	P11G424	SCREW ASSEMBLY				
N		EA	1	2	1	
811174333	P11G433	PLATE				
N		EA	1	2	1	
811174408	P11G440	SOLENOID ASSEMBLY				
N		EA	1	2	1	
811174416	P11G441	SOLENOID ASSEMBLY				
N		EA	1	2	1	
811174424	P11G442	ASSEMBLY HOLDING PAWL				
N		EA	1	2	1	
811174432	P11G443	ASSEMBLY INDEXING PAWL				
N		EA	1	2	1	
811174440	P11G444	GEAR				
N		EA	1	24	1	
811174457	P11G445	GEAR				
N		EA	1	24	1	
811175298	P11G529	MOTOR				
N		EA	1	13	1	
811175306	P11G530	MOTOR ASSEMBLY				
N		EA	1	2	1	
811175876	P11G587	BOTTOM				
N		EA	1	9	1	
811175975	P11G597	SPACER				
N		EA	1	17	1	
811176197	P11G619	UPPER SHAFT				
N		EA	1	2	1	

NETWORK SERVICES

TOOLS

BUILDING JANITORIAL

AUTOMOTIVE

FORMS/OFFICE SUPPLIES

GENERAL

DATA VOICE

PRODUCT IDENTIFIER		DESCRIPTION				
ITEM NUMBER	ORD. MULT.	SELL UNIT	STD. PKG. STOCK AVAILABILITY / PA	LEAD TIME	MIN. ORD.	A C
811176221	P11G622	COMPRESSION SPRING				
N		EA	1	2	1	
811176239	P11G623	LOWER SHAFT				
N		EA	1	2	1	
811176411	P11G641	BUSHING				
N		EA	1	1	1	
811176536	P11G653	FRONT SWITCH				
N		EA	1	16	1	
811176841	P11G684	IDLER ASSEMBLY				
N		EA	1	2	1	
811176908	P11G690	ASSEMBLY FORWARD SWITCH				
N		EA	1	2	1	
811176916	P11G691	SWITCH ASSEMBLY				
N		EA	1	2	1	
811176932	P11G693	INSULATOR				
N		EA	1	24	1	
811176999	P11G699	SHAFT				
N		EA	1	24	1	
811177013	P11G701	SOLENOID ASSEMBLY				
N		EA	1	2	1	
811177021	P11G702	SOLENOID ASSEMBLY				
N		EA	1	2	1	
811177054	P11G705	DIAPHRAM				
N		EA	1	2	1	
811177070	P11G707	SPRING				
N		EA	1	2	1	
811177161	P11G716	CONTACT				
N		EA	1	9	1	
811177344	P11G734	SPACER				
N		EA	1	17	1	
811177542	P11G754	FAN				
N		EA	1	2	1	
811177633	P11G763	EXPANDER				
N		EA	1	13	1	
811177658	P11G765	LATCH ASSEMBLY				
N		EA	1	20	1	
811177732	P11G773	CABLE RET				
N		EA	1	2	1	
811177757	P11G775	SPRING				
N		EA	1	24	1	
811177765	P11G776	INTERPOSER				
N		EA	1	13	1	

PRODUCT IDENTIFIER							DESCRIPTION						
ITEM	ORD.	SELL	STD. PKG.	LEAD TIME	MIN.	A	ITEM	ORD.	SELL	STD. PKG.	LEAD TIME	MIN.	A
NUMBER	MULT.	UNIT	STOCK AVAILABILITY / PA		ORD.	C	NUMBER	MULT.	UNIT	STOCK AVAILABILITY / PA		ORD.	C
811177823	P11G782	LEFT INTERLOCK BLOCK	N	EA	1	20	1						
811177831	P11G783	LEFT INTERLOCK ASSEMBLY	N	EA	1	21	1						
811178094	P11G809	COVER	N	EA	1	13	1						
811178144	P11G814	ACTUATOR	N	EA	1	2	1						
811178854	P11G885	SLIDE	N	EA	1	2	1						
811178862	P11G886	SLIDE	N	EA	1	2	1						
811178870	P11G887	CHANNEL	N	EA	1	13	1						
811178912	P11G891	SPRING	N	EA	1	13	1						
811178946	P11G894	CLIP	N	EA	1	24	1						
811178953	P11G895	CLIP	N	EA	1	24	1						
811178979	P11G897	BRACKET	N	EA	1	24	1						
811178987	P11G898	BRACKET	N	EA	1	24	1						
811179027	P11G902	CARD	N	EA	1	13	1						
811179167	P11G916	LEVER ASSEMBLY	N	EA	1	2	1						
811179225	P11G922	WASHER	N	EA	1	24	1						
811179233	P11G923	SPRING	N	EA	1	13	1						
811179936	P11G993	CONTACT ASSEMBLY	N	EA	1	2	1						
801259532	P125953	HEX NUT	N	EA	1	2	1						
811238245	P12C824	BAR	N	EA	1	14	1						
811261601	P12F160	FUSE CAP	N	EA	1	2	1						
811265610	P12F561	COIL ASSEMBLY	N	EA	1	5	1						

PRODUCT IDENTIFIER							DESCRIPTION						
ITEM	ORD.	SELL	STD. PKG.	LEAD TIME	MIN.	A	ITEM	ORD.	SELL	STD. PKG.	LEAD TIME	MIN.	A
NUMBER	MULT.	UNIT	STOCK AVAILABILITY / PA		ORD.	C	NUMBER	MULT.	UNIT	STOCK AVAILABILITY / PA		ORD.	C
811265628	P12F562	SELECTING COIL ASSEMBLY	N	EA	1	5	1						
		240 Ohms.											
811265800	P12F580	LEFT HAND SELECT BAR ASSEM	N	EA	1	5	1						
811265834	P12F583	RIGHT HAND SELECT BAR ASSEM	N	EA	1	5	1						
811266279	P12F627	BRACKET	N	EA	1	5	1						
811266287	P12F628	RETENTION SPRING	N	EA	1	5	1						
811267327	P12F732	HOLDING COIL ASSEMBLY	N	EA	1	5	1						
811267335	P12F733	COIL ASSEMBLY	N	EA	1	5	1						
801394693	P139469	HEX NUT	N	EA	1	7	1						
		For NC and NF type terminal cables, 10 and 16 pair, BSP 631-210-101.											
811319359	P13A935	SHAFT	N	EA	1	2	1						
811323542	P13B354	CLIP	N	EA	1	12	1						
811431147	P14C114	NUT	N	EA	1	6	1						
811533058	P15305C	BLOCK	N	EA	1	13	1						
801540394	P154039	CONTROL SPRING ASSEMBLY	N	EA	1	9	1						
801545534	P154553	SPUR GEAR	N	EA	1	9	1						
801549031	P154903	WASHER	N	EA	1	9	1						
801592411	P159241	CAM	N	EA	1	9	1						
811511575	P15A157	STOP BRACKET	N	EA	1	13	1						
811514132	P15A413	ADAPTER	N	EA	1	9	1						
811519768	P15A976	ARMATURE CAP	N	EA	1	2	1						
811533876	P15C387	COIL CONTACT	N	EA	1	7	1						

DISTRIBUTION SERVICES

NETWORK SERVICES

TOOLS

BUILDING JANITORIAL

AUTOMOTIVE

FORMS/OFFICE SUPPLIES

GENERAL

DATA VOICE

P NUMBERED PARTS

DISTRIBUTION SERVICES

PRODUCT IDENTIFIER		DESCRIPTION				
ITEM NUMBER	ORD. MULT.	SELL UNIT	STD. PKG. STOCK AVAILABILITY / PA	LEAD TIME	MIN. ORD.	A C

811536515 P15C651 MOUNTING BRACKET
N EA 1 13 1

NETWORK SERVICES

811576941 P15G694 BRACKET
N EA 1 15 1

801600610 P160061 CONDUIT CLAMP
N EA 1 10 1

801657354 P165735 TERMINAL
N EA 1 10 1

801658667 P165866 RHM SC
N EA 1 9 1

801680836 P168083 ARMATURE BACKSTOP
N EA 1 9 1

801687831 P168783 BRACKET
N EA 1 15 1

801689530 P168953 PIN
N EA 1 24 1

TOOLS

811610708 P16A070 BUFFER SPRING
N EA 1 2 1

811610914 P16A091 COIL ASSEMBLY
N EA 1 1 1

811611011 P16A101 OPERATING CARD
N EA 1 1 1

811611029 P16A102 OPERATING CARD
N EA 1 1 1

811611037 P16A103 OPERATING CARD
N EA 1 1 1

BUILDING JANITORIAL

811611441 P16A144 COVER
N EA 100 2 100

811611805 P16A180 CONTACT
N EA 1 4 1

811611896 P16A189 CONTACT
N EA 100 2 100

811611912 P16A191 WIRE GUIDE
N EA 1 1 1

811612225 P16A222 CONTACT
N EA 100 2 100

811612795 P16A279 BUFFER SPRING
1211243 1 EA IL IN MI OH WI
58 58 58 58 58

AUTOMOTIVE

811616002 P16A600 CAP
N EA 1 2 1

811655257 P16E525 CORD TIP
N EA 1500 8 1500

FORMS/OFFICE SUPPLIES

GENERAL

DATA VOICE

PRODUCT IDENTIFIER		DESCRIPTION				
ITEM NUMBER	ORD. MULT.	SELL UNIT	STD. PKG. STOCK AVAILABILITY / PA	LEAD TIME	MIN. ORD.	A C

811655638 P16E563 CAP ASSEMBLY
N EA 100 4 100

801711938 P171193 BUS BAR
N EA 1 9 1

801724253 P172425 CONTACT
N EA 1 9 1

801726035 P172603 SPUR GEAR
N EA 1 9 1

801728387 P172838 ROTOR
N EA 1 9 1

801728437 P172843 BRUSH
N EA 1 9 1

801728551 P172855 ROTOR
N EA 1 9 1

801734526 P173452 SCREW
N EA 1 9 1

801737214 P173721 SFHM SCREW
N EA 1 9 1

801737297 P173729 CAM
N EA 1 9 1

801737495 P173749 SPIRAL GEAR
N EA 1 9 1

801737545 P173754 GEAR/CASE ASSEMBLY
N EA 1 9 1

801737552 P173755 SPIRAL GEAR
N EA 1 9 1

811751940 P17E194 SPRING
N EA 1 2 1

840058226 P180921 SCREW BHM
N EA 1 13 1

801809229 P180922 SCREW
N EA 1 9 1

801809286 P180928 SCREW
N EA 1 2 1

801812512 P181251 SCREW
N EA 1 13 1

801812546 P181254 SCREW
N EA 1 13 1

801821422 P182142 SCREW
N EA 1 13 1

801829672 P182967 LOCKWASHER
N EA 1 2 1

PRODUCT IDENTIFIER		DESCRIPTION					
ITEM NUMBER	ORD. MULT.	SELL UNIT	STD. PKG. STOCK AVAILABILITY / PA	LEAD TIME	MIN. ORD.	A	C
801831496 P183149 LOCKWASHER							
1978676	1	EA	IL IN MI OH WI	09			
801838772 P183877 MOUNTING							
N		EA	1	9	1		
801851155 P185115 CABLE ASSEMBLY							
N		EA	1	14	1		
801865163 P186516 COVER PLATE ASSEMBLY							
N		EA	5	15	5		
801881822 P188182 SPACER							
N		EA	1	9	1		
811816784 P18A678 LUG GROUND ASSEMBLY							
N		EA	1	1	1		
811852870 P18E287 CORDAGE							
N		FT	1	15	1		
811858620 P18E862 O RING							
N		EA	1	1	1		
811910058 P19A005 CATCH							
N		EA	1	6	1		
811911304 P19A130 CARD							
N		EA	1	2	1		
811911338 P19A133 CARD							
N		EA	1	2	1		
811911346 P19A134 CARD							
N		EA	1	2	1		
811911353 P19A135 CARD							
N		EA	1	2	1		
811911361 P19A136 CARD							
N		EA	1	2	1		
811911379 P19A137 CARD							
N		EA	1	2	1		
811911494 P19A149 COVER							
N		EA	1	2	1		
811911502 P19A150 CARD							
N		EA	1	13	1		
811911627 P19A162 COVER							
N		EA	1	1	1		
811913532 P19A353 CONTACT							
N		EA	1	13	1		
811950468 P19E046 T NUT ASSEMBLY							
N		EA	25	9	25		
811951276 P19E127 NUMBER PLATE							
N		EA	1	13	1		

PRODUCT IDENTIFIER		DESCRIPTION					
ITEM NUMBER	ORD. MULT.	SELL UNIT	STD. PKG. STOCK AVAILABILITY / PA	LEAD TIME	MIN. ORD.	A	C
811951284 P19E128 NUMBER PLATE							
N		EA	1	13	1		
811951292 P19E129 NUMBER PLATE							
N		EA	1	13	1		
811951300 P19E130 NUMBER PLATE							
N		EA	1	13	1		
811951318 P19E131 NUMBER PLATE							
N		EA	1	13	1		
811951326 P19E132 NUMBER PLATE							
N		EA	1	13	1		
811951334 P19E133 NUMBER PLATE							
N		EA	1	2	1		
811951342 P19E134 NUMBER PLATE							
N		EA	1	13	1		
802077040 P207704 STRAP							
N		FT	1	2	1		
802101600 P210160 SCREW							
N		EA	1	2	1		
802102350 P210235 SCREW							
1222125	1	EA	IL IN MI OH WI	18 18			
802103176 P210237 SCREW							
N		EA	1	2	1		
802102491 P210249 SCREW							
N		EA	1	8	1		
802102525 P210252 SCREW							
N		EA	1	6	1		
802102921 P210292 COTTER PIN							
N		EA	1	2	1		
802108100 P210810 SCREW 16							
N		EA	1	9	1		
802108571 P210857 WASHER							
5108845	1	EA	IL IN MI OH WI	18			
802109231 P210923 SCREW							
N		EA	1	14	1		
812156081 P21E608 BRACKET							
N		EA	1	10	1		
812159309 P21E930 CONTAINER							
N		EA	1	2	1		
812159325 P21E932 CONTAINER							
N		EA	1	13	1		

DISTRIBUTION SERVICES

NETWORK SERVICES

TOOLS

BUILDING JANITORIAL

AUTOMOTIVE

FORMS/OFFICE SUPPLIES

GENERAL

DATA VOICE

DISTRIBUTION SERVICES

NETWORK SERVICES

TOOLS

BUILDING JANITORIAL

AUTOMOTIVE

FORMS/OFFICE SUPPLIES

GENERAL

DATA VOICE

P NUMBERED PARTS

PRODUCT IDENTIFIER		DESCRIPTION						
ITEM NUMBER	ORD. MULT.	SELL UNIT	STD. PKG. STOCK AVAILABILITY / PA	LEAD TIME	MIN. ORD.	A	C	
802235127 P223512 WASHER								
7376368	1	EA	IL IN MI OH WI 18 18					
DISCONTINUE, ORDER NON STOCK UPON STOCK DEPLETION								
802285726 P228572 WASHER								
N		EA	1	9		1		
812250058 P22E005 CONTAINER								
N		EA	1	2		1		
One piece for 468A apparatus case.								
812250066 P22E006 CONTAINER ASSEMBLY								
N		EA	1	2		1		
812263259 P22F325 HOOK HANDLE ASSEMBLY								
N		EA	1	13		1		
812263267 P22F326 HOOK HANDLE ASSEMBLY								
N		EA	1	13		1		
802333401 P233340 WASHER								
N		EA	1	9		1		
802349670 P234967 WASHER								
N		EA	1	14		1		
812365948 P23F594 BUTTON STOP								
N		EA	1	2		1		
802421321 P242132 WASHER								
5351601	1	EA	IL IN MI OH WI 58 58					
DISCONTINUE, ORDER NON STOCK UPON STOCK DEPLETION								
802436550 P243655 FEELER								
N		EA	1	14		1		
802436568 P243656 FEELER								
N		EA	1	9		1		
802436576 P243657 FEELER								
N		EA	1	14		1		
802436584 P243658 FEELER								
N		EA	1	9		1		
802436618 P243661 FEELER								
N		EA	1	9		1		
802436626 P243662 FEELER								
N		EA	1	14		1		
802436634 P243663 FEELER								
N		EA	1	13		1		
802436741 P243674 FEELER								
N		EA	1	9		1		
802436758 P243675 FEELER								
N		EA	1	14		1		

PRODUCT IDENTIFIER		DESCRIPTION						
ITEM NUMBER	ORD. MULT.	SELL UNIT	STD. PKG. STOCK AVAILABILITY / PA	LEAD TIME	MIN. ORD.	A	C	
802436774 P243677 FEELER								
N		EA	1	9		1		
802436790 P243679 FEELER								
N		EA	1	14		1		
802436766 P243766 FEELER								
N		EA	1	14		1		
802439539 P243953 KEYRING								
N		EA	1	10		1		
802473439 P247343 FEELER								
N		EA	1	27		1		
802473454 P247345 FEELER								
N		EA	1	9		1		
802473751 P247375 NUT HEX								
N		EA	1	9		1		
802478941 P247894 WASHER								
5108860	1	EA	IL IN MI OH WI 58 58 58 58					
3/16in H X 7/16 OD X 1/64in T. For various types of aerial terminals. For 123 type protector. Package of 100.								
812452019 P24E201 SWITCH ASSEMBLY								
N		EA	50	13		50		
802500090 P250009 CLAMP								
N		EA	1	28		1		
802500181 P250018 SCREW								
N		EA	1	2		1		
802500199 P250019 BEARING PIN								
N		EA	1	7		1		
802500256 P250025 PIN								
N		EA	1	2		1		
802500314 P250031 SCREW								
N		EA	1	6		1		
802500777 P250077 WASHER								
N		EA	1	7		1		
802500835 P250083 ARMATURE PAWL SPRING								
N		EA	1	13		1		
802500918 P250091 WASHER								
N		EA	1	2		1		
802500991 P250099 SCREW								
N		EA	1	2		1		
802502476 P250247 SCREW								
N		EA	1	6		1		

PRODUCT IDENTIFIER		DESCRIPTION							
ITEM	ORD.	SELL	STD. PKG.	LEAD TIME			MIN.	A	
NUMBER	MULT.	UNIT	STOCK AVAILABILITY / PA					ORD.	C
802509794 P250979 COIL ASSEMBLY									
1222661	1	EA	IL	IN	MI	OH	WI		
			58	58	58	58	58		
Used in SxS switching equipment.									
802511725 P251172 INTERRUPTER									
N		EA	1			2		1	
802512335 P251233 WASHER									
N		EA	1			2		1	
802514588 P251458 ARMATURE SPRING									
N		EA	1			13		1	
802515882 P251588 SLEEVE									
4201426	1	EA	IL	IN	MI	OH	WI		
			58	58					
802515874 P251588 SLEEVE									
N		EA	1			2		1	
802516278 P251627 PH TAPPING SCREW									
N		EA	1			2		1	
802516765 P251676 SCREW									
N		EA	1			7		1	
802516856 P251685 COMMUTATOR WIPER ASSEMBLY									
1222901	25	EA	IL	IN	MI	OH	WI		
			58	58					
Verticle wiper for WECO Step-By-Step Switch.									
802517011 P251701 RELEASER ARM									
N		EA	1			7		1	
802517029 P251702 COIL SPRING									
N		EA	1			13		1	
802517219 P251721 VERTICAL ARMATURE ASSEMBLY									
1222984	1	EA	IL	IN	MI	OH	WI		
			05	58					
Used on a step-by-step switch.									
802517268 P251726 TERMINAL									
N		EA	1			9		1	
802518423 P251842 RELEASE LINK									
N		EA	1			2		1	
802518951 P251895 SHAFT SPRING									
N		EA	1			2		1	
802518993 P251899 NORMAL									
N		EA	1			7		1	
802520270 P252027 ROTARY ARM ASSEMBLY									
1720201	1	EA	IL	IN	MI	OH	WI		
			58	58	58	58	58		
Used in SxS offices-switching equipment.									
802525097 P252509 SCREW									
N		EA	1			13		1	
802525139 P252513 SCREW									
N		EA	1			2		1	

PRODUCT IDENTIFIER		DESCRIPTION							
ITEM	ORD.	SELL	STD. PKG.	LEAD TIME			MIN.	A	
NUMBER	MULT.	UNIT	STOCK AVAILABILITY / PA					ORD.	C
802525204 P252520 SHAFT									
N		EA	1			2		1	
802525345 P252534 PAWL PIN									
N		EA	1			2		1	
802525360 P252536 PAWL PIN									
N		EA	1			2		1	
802525378 P252537 PAWL PIN									
N		EA	1			2		1	
802525493 P252549 STATION									
N		EA	1			7		1	
802527234 P252723 BANK WIPER ASSEMBLY									
1223263	15	EA	IL	IN	MI	OH	WI		
			58	58	58	58	58		
Tip & ring wiper used on step-by-step switch.									
802527630 P252763 BASE									
N		EA	1			6		1	
802527747 P252774 COLLAR									
N		EA	1			6		1	
802527853 P252785 WIPER									
N		EA	1			2		1	
802527887 P252788 MAGNET									
N		EA	1			21		1	
802527895 P252789 MAGNET ASSEMBLY									
N		EA	1			2		1	
802527903 P252790 MAGNET RELEASE									
N		EA	1			13		1	
802528778 P252877 SCREW									
N		EA	1			13		1	
802529073 P252907 SCREW									
N		EA	1			13		1	
802531046 P253104 INSULATOR									
N		EA	1			2		1	
802539254 P253925 INSERT									
N		EA	1			8		1	
802579953 P257995 MOUNTING BAR									
N		EA	12			15		12	
802581371 P258137 CABLE BRACKET									
N		EA	1			15		1	
802583153 P258315 FENDER									
N		EA	1			10		1	
802584490 P258449 CLIP									
N		EA	1			2		1	

DISTRIBUTION SERVICES

NETWORK SERVICES

TOOLS

BUILDING JANITORIAL

AUTOMOTIVE

FORMS/OFFICE SUPPLIES

GENERAL

DATA VOICE

P NUMBERED PARTS

DISTRIBUTION SERVICES

PRODUCT IDENTIFIER		DESCRIPTION				
ITEM NUMBER	ORD. MULT.	SELL UNIT	STD. PKG. STOCK AVAILABILITY / PA	LEAD TIME	MIN. ORD.	A C
802594150	P259415	SCREW				
N		EA	1	13	1	
812551208	P25E120	BUTTON COLLAR ASSEMBLY				
N		EA	1	2	1	
812558039	P25E803	CARD RETAINER				
N		EA	1	2	1	
802635961	P263596	MOUNTING BAR				
N		EA	1	8	1	
802649715	P264971	COTTER PIN				
N		EA	1	1	1	
802669838	P266983	SPACER				
N		EA	1	8	1	
802695361	P269536	DESIGNATION TAB				
N		EA	1	2	1	
802695619	P269561	RETAINER CARD				
N		EA	1	2	1	
802841064	P284106	SHELL				
N		EA	1	10	1	
802841395	P284139	PLAIN WASHER 16				
N		EA	1	2	1	
802841452	P284145	WASHER				
N		EA	1	2	1	
802841577	P284157	WASHER PLAIN				
N		EA	1	2	1	
812853828	P28E382	CARD SET				
N		SE	1	1	1	
802902817	P290281	BLADE				
N		EA	1	9	1	
802902957	P290295	WASHER				
N		EA	1	7	1	
802903138	P290313	HOLDING				
N		EA	1	5	1	
802904714	P290471	SEPARATOR				
N		EA	1	9	1	
802907477	P290747	SCREW				
N		EA	1	6	1	
802907600	P290760	SOCKET HEAD SCREW				
N		EA	1	2	1	
802967083	P296708	ROTARY INTERRUPTER ASSEMBLY				
N		EA	1	2	1	
802979039	P297903	NUT				
N		EA	1	2	1	

NETWORK SERVICES

TOOLS

BUILDING JANITORIAL

AUTOMOTIVE

FORMS/OFFICE SUPPLIES

GENERAL

DATA VOICE

PRODUCT IDENTIFIER		DESCRIPTION				
ITEM NUMBER	ORD. MULT.	SELL UNIT	STD. PKG. STOCK AVAILABILITY / PA	LEAD TIME	MIN. ORD.	A C
802980516	P298051	WASHER				
N		EA	1	9	1	
802987545	P298754	SPRING COMB				
N		EA	1	2	1	
802987560	P298756	SPRING COMB				
N		EA	10	10	10	
802993816	P299381	EYE BOLT				
N		EA	1	2	1	
802994095	P299409	BRAKESHOE AND ASSEMBLY				
N		EA	1	1	1	
802994111	P299411	BRAKE LINING				
N		EA	1	2	1	
802994152	P299415	WHEEL ASSEMBLY				
N		EA	1	1	1	
813010006	P30A000	SUPPORT				
N		EA	1	8	1	
813010014	P30A001	CABLE				
N		EA	1	10	1	
813019239	P30A923	SPACER				
N		EA	1	15	1	
813021219	P30B121	BULLETIN HOLDER				
N		EA	1	6	1	
813024155	P30B415	BRACKET				
N		EA	1	9	1	
813024866	P30B486	PLATE				
N		EA	1	1	1	
813024908	P30B490	FORM				
N		EA	1	13	1	
813111218	P31A121	JACK ASSEMBLY				
N		EA	1	18	1	
813111374	P31A137	APPARATUS BLANK				
N		EA	1	1	1	
813114519	P31A451	CARD				
N		EA	1	2	1	
813221264	P32B126	SLEEVE RED				
N		EA	1	1	1	
813225364	P32B536	DESIGNATION				
N		EA	1	10	1	
813225919	P32B591	BRACKET				
N		EA	1	10	1	
813228673	P32B867	BRACKET				
N		EA	1	14	1	

PRODUCT IDENTIFIER							DESCRIPTION						
ITEM	ORD.	SELL	STD. PKG.	LEAD TIME	MIN.	A	ITEM	ORD.	SELL	STD. PKG.	LEAD TIME	MIN.	A
NUMBER	MULT.	UNIT	STOCK AVAILABILITY / PA		ORD.	C	NUMBER	MULT.	UNIT	STOCK AVAILABILITY / PA		ORD.	C
813228830		P32B883	FENDER ASSEMBLY										
N		EA	1	2	1								
260386982		P32B952	INSULATOR										
N		EA	1	2	1								
803302595		P330259	SUPPORT										
N		EA	1	1	1								
803304930		P330493	LADDER WHEEL GUARD										
N		EA	1	1	1								
803306521		P330652	PLATE										
N		EA	1	8	1								
803308568		P330856	PLATE										
N		EA	1	10	1								
813320280		P33B028	ALARM										
N		EA	1	9	1								
803449008		P344900	FUSE CAP										
N		EA	1	2	1								
813417367		P34A736	HANGER										
N		EA	1	9	1								
813417375		P34A737	RECEPTACLE										
N		EA	1	10	1								
813419637		P34A963	BANK GUARD										
N		EA	1	2	1								
824340715		P34M071	CABLE										
N		EA	1	2	1								
803534460		P353446	SCREW 3/8IN										
N		EA	1	2	1								
803534486		P353448	SCREW 12-24 X 5/8IN										
5228882	1	EA	IL	IN	MI	OH	WI						
			58	58									
289A pan head, high tensile, machine screw. DISCONTINUE UPON STOCK DEPLETION													
803568658		P356865	NUT										
N		EA	1	13	1								
813520806		P35B080	DESIGNATION										
N		EA	1	8	1								
813526910		P35B691	ADAPTER										
N		EA	1	9	1								
803690171		P369017	LOCK WASHER										
N		EA	1	2	1								
803738996		P373899	SOLENOID										
N		EA	1	9	1								
803746692		P374669	CLAMP										
N		EA	1	9	1								

PRODUCT IDENTIFIER							DESCRIPTION						
ITEM	ORD.	SELL	STD. PKG.	LEAD TIME	MIN.	A	ITEM	ORD.	SELL	STD. PKG.	LEAD TIME	MIN.	A
NUMBER	MULT.	UNIT	STOCK AVAILABILITY / PA		ORD.	C	NUMBER	MULT.	UNIT	STOCK AVAILABILITY / PA		ORD.	C
803746882		P374688	BRACKET										
N		EA	1	6	1								
803753060		P375306	PIPE										
N		EA	50	1	50								
803753722		P375372	GASKET										
N		EA	10	1	10								
803764208		P376420	GROMMET										
N		EA	1	6	1								
803777473		P377747	PANEL										
N		EA	4	14	8								
803795491		P379549	JUNCTION										
N		EA	1	9	1								
813711751		P37A175	KNOB										
N		EA	1	7	1								
813722048		P37B204	BRACKET										
N		EA	1	14	1								
803858653		P385865	NUT HEX										
N		EA	1	2	1								
803876663		P387666	LOCK WASHER 16										
N		EA	1	2	1								
803877489		P387748	LOCK WASHER										
N		EA	1	2	1								
813830874		P38C087	BRACKET										
N		EA	1	9	1								
804016467		P401646	DESIGNATION CARD										
N		EA	1	2	1								
804017010		P401701	CABLE RACK ASSEMBLY										
N		EA	1	2	1								
804017507		P401750	FOOT										
N		EA	1	1	1								
804019222		P401922	BRACKET										
N		EA	1	10	1								
804020873		P402087	CABLE										
N		EA	1	9	1								
804034718		P403471	BOLT										
N		EA	1	2	1								
804034726		P403472	CLAMP										
N		EA	1	2	1								
804034742		P403474	CLAMP										
N		EA	1	2	1								
804034775		P403477	CLAMP										
N		EA	1	2	1								

DISTRIBUTION SERVICES

NETWORK SERVICES

TOOLS

BUILDING JANITORIAL

AUTOMOTIVE

FORMS/OFFICE SUPPLIES

GENERAL

DATA VOICE

P NUMBERED PARTS

DISTRIBUTION SERVICES

NETWORK SERVICES

TOOLS

BUILDING JANITORIAL

AUTOMOTIVE

FORMS/OFFICE SUPPLIES

GENERAL

DATA VOICE

PRODUCT IDENTIFIER		DESCRIPTION					
ITEM NUMBER	ORD. MULT.	SELL UNIT	STD. PKG. STOCK AVAILABILITY / PA	LEAD TIME	MIN. ORD.	A C	
804039154	P403915	BUS BAR	N	EA	1	13	1
804056281	P405628	SCREW	N	EA	1	7	1
804077113	P407711	CLAMP	N	EA	1	15	1
814011862	P40A186	ADAPTER	N	EA	1	10	1
814012746	P40A274	SUPPORT	N	EA	1	10	1
814012902	P40A290	JUNCTION SPACER	N	EA	1	8	1
814013983	P40A398	CABLE	N	EA	1	6	1
814016242	P40A624	BUS BAR	N	EA	1	7	1
814018206	P40A820	SUPPORT	N	EA	1	9	1
814018545	P40A854	SPACER	N	EA	1	7	1
814019477	P40A947	BUS BAR	N	EA	1	9	1
814020046	P40B004	SUPPORT	N	EA	1	10	1
814020053	P40B005	SUPPORT	N	EA	1	10	1
814023768	P40B376	BUS BAR	N	EA	1	9	1
814023776	P40B377	BUS BAR	N	EA	1	9	1
814023784	P40B378	BUS BAR	N	EA	1	9	1
814023792	P40B379	BUS BAR	N	EA	1	9	1
814023818	P40B381	BUS BAR	N	EA	1	9	1
814026423	P40B642	FIBER INSULATOR	N	EA	1	2	1
814027223	P40B722	SHAFT	N	EA	1	1	1
814030482	P40C048	BUS BAR	N	EA	1	10	1

PRODUCT IDENTIFIER		DESCRIPTION					
ITEM NUMBER	ORD. MULT.	SELL UNIT	STD. PKG. STOCK AVAILABILITY / PA	LEAD TIME	MIN. ORD.	A C	
814035374	P40C537	TERMINAL	N	EA	1	14	1
814038691	P40C869	COVER DESIGNATION CARD	N	EA	1	2	1
814041455	P40D145	CABLE	N	EA	1	8	1
814043899	P40D389	BRACKET	N	EA	1	10	1
814046124	P40D612	BUS BAR	N	EA	1	7	1
814046645	P40D664	PLATE	N	EA	1	14	1
814049268	P40D926	GUARD TE	N	EA	1	14	1
814050977	P40E097	BRACKET	N	EA	1	7	1
814054714	P40E471	NUT	N	EA	1	11	1
814056511	P40E651	CABLE	N	EA	1	8	1
814057188	P40E718	BUS BAR	N	EA	1	7	1
814057360	P40E736	FEEDER	N	EA	1	14	1
814059192	P40E919	BUSBAR	N	EA	1	1	1
814063632	P40F363	BUS BAR	N	EA	1	6	1
814063731	P40F373	BUS BAR	N	EA	1	7	1
814063798	P40F379	BUS BAR	N	EA	1	9	1
814063921	P40F392	SUPPORT	N	EA	1	8	1
814063947	P40F394	SUPPORT	N	EA	1	8	1
814066684	P40F668	BATTERY	N	EA	1	9	1
814066718	P40F671	BATTERY B	N	EA	1	9	1
814071825	P40G182	FORM	N	EA	1	13	1

PRODUCT IDENTIFIER DESCRIPTION						
ITEM	ORD.	SELL	STD. PKG.	LEAD TIME	MIN.	A
NUMBER	MULT.	UNIT	STOCK AVAILABILITY / PA		ORD.	C
814071833		P40G183	CARD			
N		EA	1	7	1	
814071841		P40G184	FORM			
N		EA	1	13	1	
814071858		P40G185	DESIGNATION CARD			
N		EA	1	13	1	
814071866		P40G186	FORM			
N		EA	1	13	1	
814071874		P40G187	BANK CARD			
N		EA	1	13	1	
814071882		P40G188	BANK CARD			
N		EA	1	13	1	
814071890		P40G189	BANK CARD			
N		EA	1	13	1	
814071908		P40G190	BANK CARD			
N		EA	1	13	1	
814071916		P40G191	BANK CARD			
N		EA	1	13	1	
814071924		P40G192	BANK CARD			
N		EA	1	13	1	
814071932		P40G193	BANK CARD			
N		EA	1	13	1	
814071940		P40G194	BANK CARD			
N		EA	1	13	1	
814071957		P40G195	BANK CARD			
N		EA	1	13	1	
814071965		P40G196	BANK CARD			
N		EA	1	13	1	
814075305		P40G530	PLATE			
N		EA	1	9	1	
814075313		P40G531	PLATE			
N		EA	1	9	1	
814087243		P40H724	LATCH			
N		EA	1	1	1	
824019368		P40J936	PLUNGER LEVER			
N		EA	1	12	1	
824019921		P40J992	COVER			
N		EA	1	14	1	
834060154		P40W015	LOOSE PARTS			
N		EA	1	8	1	
834071342		P40X134	BUS BAR			
N		EA	1	9	1	

PRODUCT IDENTIFIER DESCRIPTION						
ITEM	ORD.	SELL	STD. PKG.	LEAD TIME	MIN.	A
NUMBER	MULT.	UNIT	STOCK AVAILABILITY / PA		ORD.	C
834076507		P40X650	BUS BAR			
N		EA	1	10	1	
834076556		P40X655	BUS BAR			
N		EA	1	7	1	
834077745		P40X774	ADAPTER B			
N		EA	1	10	1	
834079410		P40X941	BUS BAR			
N		EA	1	7	1	
834079428		P40X942	BUS BAR			
N		EA	1	1	1	
834079717		P40X971	BUS BAR			
N		EA	1	9	1	
834081010		P40Y101	ARMATURE ASSEMBLY			
N		EA	1	20	1	
804116564		P411656	BINDING			
N		EA	1	15	1	
804117190		P411719	TAG STOCK I/A 1978346			
N		EA	1	1	1	
804137958		P413795	FLOOR FLANGE			
N		EA	1	2	1	
804146397		P414693	TEST SET			
N		EA	1	8	1	
804163228		P416322	CABLE RACK			
N		EA	1	2	1	
804163236		P416323	CABLE RACK ASSEMBLY			
N		EA	1	2	1	
814122909		P41B290	FIXTURE			
N		EA	1	10	1	
814132858		P41C285	FIXTURE			
N		EA	1	14	1	
814167748		P41F774	END GUARD			
N		EA	1	6	1	
814177358		P41G735	BUS BAR			
N		EA	1	7	1	
824134183		P41L418	BUS BAR			
N		EA	1	7	1	
824148241		P41M824	BRACKET			
N		EA	1	14	1	
824194856		P41R485	BRACKET			
N		EA	1	14	1	
824194922		P41R492	COVER			
N		EA	1	15	1	

DISTRIBUTION SERVICES
 NETWORK SERVICES
 TOOLS
 BUILDING JANITORIAL
 AUTOMOTIVE
 FORMS/OFFICE SUPPLIES
 GENERAL
 DATA VOICE

P NUMBERED PARTS

DISTRIBUTION SERVICES

NETWORK SERVICES

TOOLS

BUILDING JANITORIAL

AUTOMOTIVE

FORMS/OFFICE SUPPLIES

GENERAL

DATA VOICE

PRODUCT IDENTIFIER		DESCRIPTION				
ITEM NUMBER	ORD. MULT.	SELL UNIT	STD. PKG. STOCK AVAILABILITY / PA	LEAD TIME	MIN. ORD.	A C
834154841		P41V484	BRACKET			
N		EA	1	10	1	
834155087		P41V508	COVER			
N		EA	1	6	1	
834155780		P41V578	SWING LOCK			
N		EA	1	2	1	
834160715		P41W071	BUS BAR			
N		EA	1	7	1	
834170698		P41X069	BRACKET			
N		EA	1	10	1	
804203776		P420377	MOUNTING			
N		EA	1	1	1	
804203800		P420380	STRAP			
N		EA	1	6	1	
804206027		P420602	CABLE			
N		EA	1	9	1	
804206340		P420634	CABLE RACK ASSEMBLY			
N		EA	1	2	1	
			Issue 7.			
804207702		P420770	BUS BAR			
N		EA	1	10	1	
804212199		P421219	ADAPTER			
N		EA	1	1	1	
804212207		P421220	ADAPTER			
N		EA	2	8	2	
804212223		P421222	ADAPTER			
N		EA	2	1	2	
804213221		P421322	BUS BAR			
N		EA	1	8	1	
804213247		P421324	JACK MOUNTING SUPPORT			
N		EA	1	13	1	
804213759		P421375	NUMBER PLATE			
N		EA	1	10	1	
804214054		P421405	JUNCTION			
N		EA	1	9	1	
804220838		P422083	SCREW			
N		EA	1	2	1	
804224442		P422444	JACK FASTENER			
N		EA	1	9	1	
804227957		P422795	WASHER			
N		EA	1	22	1	
804235711		P423571	ADAPTER			
N		EA	1		1	

PRODUCT IDENTIFIER		DESCRIPTION				
ITEM NUMBER	ORD. MULT.	SELL UNIT	STD. PKG. STOCK AVAILABILITY / PA	LEAD TIME	MIN. ORD.	A C
804239317		P423931	SCREW			
N		EA	1	2	1	
804244028		P424402	MOUNTING BAR			
N		EA	1	15	1	
804244150		P424415	MOUNTING BAR			
N		EA	1	6	1	
804245736		P424573	CABLE BRACKET			
N		EA	1	10	1	
804248201		P424820	ADAPTER			
N		EA	1	2	1	
804248565		P424856	ADAPTER			
N		EA	1	9	1	
804248573		P424857	ADAPTER			
N		EA	1	10	1	
804248581		P424858	ADAPTER			
N		EA	1	10	1	
804248771		P424877	ADAPTER			
N		EA	1	28	1	
804249035		P424903	ADAPTER			
N		EA	1	13	1	
804249043		P424904	ADAPTER			
N		EA	1	10	1	
804265734		P426573	ENVELOPE ASSEMBLY			
N		EA	1	8	1	
804267540		P426754	JUNCTION			
N		EA	1	7	1	
804269918		P426991	BATTERY BUS BAR			
N		EA	1	10	1	
804276103		P427610	ADAPTER			
N		EA	1	2	1	
804276368		P427636	STRAP			
N		EA	1	9	1	
804281533		P428153	GROUND			
N		EA	1	9	1	
804281673		P428167	GROUND			
N		EA	1	9	1	
804284149		P428414	GROUND			
N		EA	1	1	1	
804285195		P428519	EXPANSION SHIELD			
N		EA	1	2	1	
804289643		P428964	BUS BAR			
N		EA	1	9	1	

PRODUCT IDENTIFIER		DESCRIPTION				
ITEM NUMBER	ORD. MULT.	SELL UNIT	STD. PKG. STOCK AVAILABILITY / PA	LEAD TIME	MIN. ORD.	A C
804289650	P428965	BUS BAR				
N		EA	1	9	1	
804293439	P429343	BUS BAR				
N		EA	1	7	1	
804293447	P429344	BUS BAR				
N		EA	1	6	1	
804293462	P429346	BUS BAR				
N		EA	1	7	1	
804293470	P429347	BUS BAR				
N		EA	1	7	1	
804293496	P429349	BUS BAR				
N		EA	1	7	1	
804293694	P429369	BUS BAR				
N		EA	1	7	1	
804294106	P429410	BUS BAR				
N		EA	1	9	1	
804295772	P429577	BUS BAR				
N		EA	1	9	1	
804297752	P429775	BAR GUARD				
N		EA	1	9	1	
804297778	P429777	JUNCTION PLATE				
N		EA	1	1	1	
814220307	P42B030	PLAIN				
N		EA	1	18	1	
814240594	P42D059	SPACER				
N		EA	1	8	1	
814251823	P42E182	PLAIN				
N		EA	1	6	1	
814251930	P42E193	WASHER				
N		EA	1	2	1	
814252672	P42E267	WASHER				
N		EA	1	12	1	
814257481	P42E748	WASHER PLAIN				
N		EA	1	2	1	
814259040	P42E904	COUPLING BAND ASSEMBLY				
N		EA	1	2	1	
824272777	P42P277	DESIGNATION STRIP				
N		EA	1	2	1	
824272785	P42P278	DESIGNATION STRIP				
N		EA	1	2	1	
804308872	P430887	ANGLE				
N		EA	1	9	1	

PRODUCT IDENTIFIER		DESCRIPTION				
ITEM NUMBER	ORD. MULT.	SELL UNIT	STD. PKG. STOCK AVAILABILITY / PA	LEAD TIME	MIN. ORD.	A C
804316255	P431265	BASE				
N		EA	1	14	1	
804312866	P431286	MOUNTING				
N		EA	1	10	1	
804313799	P431379	BAR GUARD				
N		EA	1	7	1	
804313815	P431381	PLATE JUNCTION				
N		EA	1	1	1	
804317139	P431713	BRACKET				
N		EA	1	6	1	
804322386	P432238	CABLE SUPPORT ASSEMBLY				
N		EA	1	8	1	
804323061	P432306	BUS BAR				
N		EA	1	7	1	
804327948	P432794	CLIP				
N		EA	1	10	1	
804345247	P434524	MOUNTING PLATE				
N		EA	1	13	1	
814340196	P43D019	PBX MULTI STRAND TU/100				
N		EA	1	7	1	
814340204	P43D020	PBX MULTI STRAND TU/100				
N		TU	1	7	1	
814340238	P43D023	STRAPPING WIRE				
N		EA	100	11	100	
814340360	P43D036	CABLE				
N		EA	1	14	1	
814341145	P43D114	ADAPTER				
N		EA	1	14	1	
814341855	P43D185	BRACKET				
N		EA	1	1	1	
814341863	P43D186	BRACKET				
N		EA	1	1	1	
814352829	P43E282	CABLE				
N		EA	1	13	1	
814387429	P43H742	MOUNTING SUPPORT ASSEMBLY				
N		EA	1	15	1	
824330450	P43L045	CABLE				
N		EA	1	9	1	
824331094	P43L109	CABLE				
N		EA	1	14	1	
824340517	P43M051	CABLE				
N		EA	1	2	1	

DISTRIBUTION SERVICES
 NETWORK SERVICES
 TOOLS
 BUILDING JANITORIAL
 AUTOMOTIVE
 FORMS/OFFICE SUPPLIES
 GENERAL
 DATA VOICE

P NUMBERED PARTS

DISTRIBUTION SERVICES	PRODUCT IDENTIFIER		DESCRIPTION				
	ITEM	ORD.	SELL	STD. PKG.	LEAD TIME	MIN.	A
	NUMBER	MULT.	UNIT	STOCK AVAILABILITY / PA		ORD.	C
	824340533	P43M053	CABLE				
	N		EA	1	2	1	
	824340541	P43M054	CABLE				
	N		EA	1	2	1	
	824340657	P43M065	CABLE				
	N		EA	1	2	1	
	824355911	P43N591	BRACKET				
	N		EA	1	15	1	
	834362485	P43W248	COIL CONTACT				
	N		EA	1	9	1	
	834372377	P43X237	DISTRIBUTION RING				
	2742122	1	EA	IL	IN	MI	OH
				18	18	18	18
				A distributing ring assembly used with 184 and 185 type backboards, BSP 518-300-100.			
	834374977	P43X497	HOUSING				
	N		EA	1	10	1	
	834374985	P43X498	HOUSING				
	N		EA	1	10	1	
	834374993	P43X499	HOUSING				
	N		EA	1	10	1	
	834375008	P43X500	HOUSING				
	N		EA	1	10	1	
	804422368	P442236	CABLE				
	N		EA	1	7	1	
	804422434	P442243	CABLE				
	N		EA	1	14	1	
	814461950	P44F195	STRAP				
	N		TU	1	5	1	
	814463907	P44F390	DESIGNATION				
	N		EA	1	14	1	
	814463915	P44F391	STRAPPING WIRE				
	N		EA	1	13	1	
	814463923	P44F392	STRAPPING WIRE				
	N		EA	1	13	1	
	814463931	P44F393	STRAPPING WIRE				
	N		EA	1	13	1	
	814463949	P44F394	STRAPPING WIRE				
	N		EA	1	13	1	
	814471421	P44G142	CABLE RETAINER				
	N		EA	1	2	1	
	814472007	P44G200	DESIGNATION CARD				
	N		EA	1	2	1	

NETWORK SERVICES	PRODUCT IDENTIFIER		DESCRIPTION				
	ITEM	ORD.	SELL	STD. PKG.	LEAD TIME	MIN.	A
	NUMBER	MULT.	UNIT	STOCK AVAILABILITY / PA		ORD.	C
	814472015	P44G201	CARD DESIGNATION				
	N		EA	1	1	1	
	814472023	P44G202	CARD DESIGNATION				
	N		EA	1	1	1	
	814472031	P44G203	DESIGNATION CARD				
	N		EA	1	2	1	
	814472049	P44G204	DESIGNATION CARD				
	N		EA	1	2	1	
	814472056	P44G205	CARD DESIGNATION				
	N		EA	1	1	1	
	814472064	P44G206	CARD DESIGNATION				
	N		EA	1	1	1	
	814472072	P44G207	DESIGNATION CARD				
	N		EA	1	2	1	
	814472080	P44G208	DESIGNATION CARD				
	N		EA	1	2	1	
	814472098	P44G209	CARD DESIGNATION				
	N		EA	1	1	1	
	814472619	P44G261	DESIGNATION CARD				
	N		EA	1	2	1	
	814477865	P44G786	DESIGNATION STRIP				
	N		EA	1	2	1	
	814477873	P44G787	DESIGNATION STRIP				
	N		EA	1	2	1	
	814479465	P44G946	WIRE STRAP GREEN				
	N		TU	1	13	1	
	814479473	P44G947	WIRE STRAP BLUE				
	N		TU	1	14	1	
	814479499	P44G949	WIRE				
	N		TU	1	6	1	
	260387121	P44H237	PLATE FACE DESIGNATION				
	N		EA	1	3	1	
	824490833	P44R083	CABLE				
	N		EA	1	8	1	
	824490841	P44R084	CABLE				
	N		EA	1	8	1	
	824490957	P44R095	CABLE				
	N		EA	1	2	1	
	824490965	P44R096	CABLE				
	N		EA	1	2	1	
	824490973	P44R097	CABLE				
	N		EA	1	2	1	

PRODUCT IDENTIFIER							DESCRIPTION								
ITEM NUMBER	ORD. MULT.	SELL UNIT	STD. PKG. STOCK	PKG. AVAILABILITY	LEAD TIME / PA	MIN. ORD.	A C	ITEM NUMBER	ORD. MULT.	SELL UNIT	STD. PKG. STOCK	PKG. AVAILABILITY	LEAD TIME / PA	MIN. ORD.	A C
824491005		P44R100	CABLE	N	EA	1	2	1							
824493787		P44R378	CABLE	N	EA	1	8	1							
824497432		P44R743	CABLE	N	EA	1	8	1							
824497457		P44R745	CABLE	N	EA	1	8	1							
824497820		P44R782	CABLE	N	EA	1	8	1							
824498497		P44R849	MOUNTING	N	EA	1	11	1							
834450181		P44V018	NUT HEX	N	EA	1	13	1							
834459364		P44V936	MOUNTING BAR	N	EA	1	9	1							
834483703		P44Y370	CLIP	N	EA	1	14	1							
804503654		P450365	SPLICE	N	EA	1	2	1							
804503662		P450366	BUSHING	N	EA	1	2	1							
804506079		P450607	GROUND	N	EA	1	9	1							
804507309		P450730	BRACKET	N	EA	1	10	1							
804507457		P450745	MOUNTING BLOCK	N	EA	1	9	1							
804510410		P451041	COVER	N	EA	1	9	1							
804510436		P451043	SPACER	N	EA	1	8	1							
804512408		P451240	BRACKET	N	EA	1	9	1							
804512705		P451270	SHIELD	N	EA	1	10	1							
804512713		P451271	PANEL	N	EA	1	7	1							
804512770		P451277	BAR GROUND	N	EA	1	7	1							
804512788		P451278	BAR GROUND	N	EA	1	9	1							

PRODUCT IDENTIFIER							DESCRIPTION								
ITEM NUMBER	ORD. MULT.	SELL UNIT	STD. PKG. STOCK	PKG. AVAILABILITY	LEAD TIME / PA	MIN. ORD.	A C	ITEM NUMBER	ORD. MULT.	SELL UNIT	STD. PKG. STOCK	PKG. AVAILABILITY	LEAD TIME / PA	MIN. ORD.	A C
804513455		P451345	CLIP	N	EA	1	10	1							
804522878		P452287	CLAMP	N	EA	1	8	1							
804525616		P452561	COVER	N	EA	25	1	25							
804535680		P453568	BRACKET	N	EA	1	10	1							
804536902		P453690	BASE ASSEMBLY	N	EA	1	1	1							
804541753		P454175	SCREW	N	EA	1	5	1							
804542272		P454227	SELECTING BAR ASSEMBLY	N	EA	1	1	1							
804542280		P454228	SELECTING BAR ASSEMBLY	N	EA	1	1	1							
804542736		P454273	SELECTING BAR ASSEMBLY	N	EA	1	1	1							
804542744		P454274	SELECTING BAR ASSEMBLY	N	EA	1	1	1							
804554822		P455482	NORMAL SPRING ASSEMBLY	N	EA	1	1	1							
804554830		P455483	NORMAL SPRING ASSEMBLY	N	EA	1	1	1							
804562254		P456225	CONTACT SPRING ASSEMBLY	N	EA	1	9	1							
804562262		P456226	CONTACT SPRING ASSEMBLY	N	EA	1	9	1							
804562296		P456229	TERMINAL	N	EA	1	9	1							
804562312		P456231	TERMINAL	N	EA	1	9	1							
804562320		P456232	TERMINAL	N	EA	1	9	1							
804574242		P457424	CLIP	N	EA	1	9	1							
804584993		P458499	SELECT	N	EA	1	1	1							
804585008		P458500	SELECT	N	EA	1	1	1							
804585172		P458517	BOTTOM	N	EA	1	12	1							

DISTRIBUTION SERVICES
 NETWORK SERVICES
 TOOLS
 BUILDING JANITORIAL
 AUTOMOTIVE
 FORMS/OFFICE SUPPLIES
 GENERAL
 DATA VOICE

P NUMBERED PARTS

DISTRIBUTION SERVICES

NETWORK SERVICES

TOOLS

BUILDING JANITORIAL

AUTOMOTIVE

FORMS/OFFICE SUPPLIES

GENERAL

DATA VOICE

PRODUCT IDENTIFIER		DESCRIPTION				
ITEM NUMBER	ORD. MULT.	SELL UNIT	STD. PKG. STOCK AVAILABILITY / PA	LEAD TIME	MIN. ORD.	A C
804589810	P458981	CAP				
N		EA	1	2	1	
814510228	P45A022	TAPER PIN				
N		EA	1	12	1	
814570586	P45G058	LATCH				
N		EA	1	15	1	
814571006	P45G100	JACK MOUNTING				
N		EA	1	13	1	
814578381	P45G838	STRAP 100/TUBE				
N		TU	1	13	1	
824530372	P45L037	TERMINAL STRIP				
N		EA	1	7	1	
824538011	P45L801	CABLE SUPPORT				
N		EA	1	1	1	
824541031	P45M103	CONNECTOR				
N		EA	1	13	1	
824541759	P45M175	CABLE				
N		EA	1	2	1	
824557391	P45N739	SPRING				
N		EA	1	7	1	
824558027	P45N802	FACE PLATE				
N		EA	1	8	1	
804615128	P461512	ARMATURE				
N		EA	1	9	1	
804615136	P461513	ARMATURE				
N		EA	1	14	1	
804628337	P462833	FINGER				
N		EA	1	9	1	
804630945	P463094	PUNCH				
N		EA	1	13	1	
804630952	P463095	PUNCH				
N		EA	1	13	1	
804630986	P463098	THROAT				
N		EA	1	1	1	
804630994	P463099	THROAT				
N		EA	1	1	1	
804631075	P463107	LINK				
N		EA	1	14	1	
804631083	P463108	LINK				
N		EA	1	9	1	
804631117	P463111	CONTROL SPRING ASSEMBLY				
N		EA	1	1	1	

PRODUCT IDENTIFIER		DESCRIPTION				
ITEM NUMBER	ORD. MULT.	SELL UNIT	STD. PKG. STOCK AVAILABILITY / PA	LEAD TIME	MIN. ORD.	A C
804631158	P463115	HOOK				
N		EA	1	1	1	
804635498	P463549	SPRING				
N		EA	1	1	1	
804636025	P463602	SPRING ASSEMBLY				
N		EA	1	1	1	
804636090	P463609	SPRING ASSEMBLY				
N		EA	1	1	1	
804636140	P463614	SPRING ASSEMBLY				
N		EA	1	4	1	
804636181	P463618	ARMATURE ASSEMBLY				
N		EA	1	1	1	
804644292	P464429	SELECTING FINGER				
N		EA	1	5	1	
804644441	P464444	CENTERING UNIT				
N		EA	1	1	1	
804644532	P464453	CONTACT				
N		EA	1	7	1	
804645208	P464520	COIL SPRING				
N		EA	1	5	1	
804670131	P467013	WASHER				
N		EA	1	9	1	
804677136	P467713	BUSHING				
N		EA	1	9	1	
804693190	P469319	CONTACT				
N		EA	1	9	1	
804693240	P469324	FIBRE INSULATOR				
N		EA	1	9	1	
814613089	P46A308	WIRE T20				
N		FT	1	14	1	
814617858	P46A785	WIRE P22				
N		FT	1	2	1	
814617916	P46A791	WIRE P22				
N		FT	1	2	1	
814629077	P46B907	COVER				
N		EA	1	2	1	
814638078	P46C807	DISTRIBUTING RING				
N		EA	1	5	1	
814639035	P46C903	BASE				
N		EA	1	10	1	
814649216	P46D921	CLIPS				
N		EA	1	14	1	

DISTRIBUTION SERVICES

NETWORK SERVICES

TOOLS

BUILDING JANITORIAL

AUTOMOTIVE

FORMS/OFFICE SUPPLIES

GENERAL

DATA VOICE

PRODUCT IDENTIFIER		DESCRIPTION				
ITEM NUMBER	ORD. MULT.	SELL UNIT	STD. PKG. STOCK AVAILABILITY / PA	LEAD TIME	MIN. ORD.	A C
814657300		P46E730	WIRE TIN MF			
N		FT	1	14	1	
814660072		P46F007	EXTENSION RING			
N		EA	1	9	1	
814662383		P46F238	TERMINAL			
N		EA	1	9	1	
814663837		P46F383	TERMINAL			
N		EA	1	9	1	
814667507		P46F750	CABLE			
N		EA	1	14	1	
814667531		P46F753	CABLE			
N		EA	1	14	1	
824624118		P46K411	END COVER			
N		EA	1	1	1	
824632111		P46L211	BLADE			
N		EA	1	10	1	
824636427		P46L642	NUMBER PLATE			
N		EA	1	2	1	
824636435		P46L643	NUMBER PLATE			
N		EA	1	2	1	
824636443		P46L644	NUMBER PLATE			
N		EA	100	2	100	
824636450		P46L645	NUMBER PLATE			
N		EA	100	2	100	
824672760		P46P276	LOCK NUT			
N		EA	1	22	1	
824675565		P46P556	CONDUIT SUPPORT BRACKET			
N		EA	1	1	1	
824675672		P46P567	AC PAN			
N		EA	1	14	1	
824690309		P46R030	CARD HOLDER ASSEMBLY			
N		EA	1	6	1	
824690465		P46R046	CARD HOLDER ASSEMBLY			
N		EA	1	6	1	
824693899		P46R389	BRACKET			
N		EA	1	1	1	
824693907		P46R390	CHANNEL			
N		EA	1	1	1	
824695332		P46R533	CABLE ASSEMBLY			
N		EA	1	2	1	
824695340		P46R534	CABLE			
N		EA	1	2	1	

PRODUCT IDENTIFIER		DESCRIPTION				
ITEM NUMBER	ORD. MULT.	SELL UNIT	STD. PKG. STOCK AVAILABILITY / PA	LEAD TIME	MIN. ORD.	A C
804727535		P472753	BAR			
N		EA	1	5	1	
804736189		P473618	TERMINAL			
N		EA	1	15	1	
804743623		P474362	SCREW			
N		EA	1	7	1	
804748861		P474886	SHELL			
N		EA	1	15	1	
804752251		P475225	DISTRIBUTING RING			
N		EA	1	9	1	
804758175		P475817	SHELL			
N		EA	1	15	1	
804764603		P476460	PIN			
N		EA	1	15	1	
804768091		P476809	SPRING			
N		EA	1	7	1	
804780823		P478082	COVER			
N		EA	1	18	1	
804799195		P479919	GUIDE			
N		EA	1	9	1	
804799203		P479920	GUIDE			
N		EA	1	9	1	
814741492		P47D149	PLATE			
N		EA	1	9	1	
260386776		P47D241	MOUNTING STUD			
N		EA	1	13	1	
814743159		P47D315	PLATE			
N		EA	1	13	1	
814743258		P47D325	SPRING			
N		EA	1	13	1	
814743274		P47D327	SPRING			
N		EA	1	13	10	
814743720		P47D372	BRACKET SWITCH ASSEMBLY			
N		EA	1	16	1	
814743951		P47D395	ROLLER ASSEMBLY			
N		EA	1	2	1	
814743969		P47D396	COUPLING			
N		EA	1	2	1	
814744074		P47D407	GEAR			
N		EA	1	13	1	
814763827		P47F382	BLANK			
N		EA	1	1	1	

P NUMBERED PARTS

PRODUCT IDENTIFIER	DESCRIPTION		MIN. ORD.	A
	ITEM	ORD. / PA		
814773628	P47G326	COVER	10	1
N	EA	1		
814773537	P47G353	COVER	8	1
N	EA	1		
814774261	P47G426	MODULE	2	1
N	EA	1		
814775599	P47G559	CABLE RING	2	1
N	EA	1		
814776936	P47G693	SLEEVE	2	1
N	EA	1		
814777066	P47G706	CEILING	10	1
N	EA	1		
814777074	P47G707	CEILING	10	1
N	EA	1		
814780904	P47H090	JUNCTION PLATE	4	1
N	EA	1		
824733109	P47L310	CLIP CONNECTOR	9	1
N	EA	1		
824730626	P47L326	STRIP FANNING	7	1
N	EA	1		
824749311	P47M931	UNIT C	9	1
N	EA	1		
824785737	P47Q573	CABLE ASSEMBLY	2	1
N	EA	1		
824787535	P47Q753	CABLE ASSEMBLY	2	1
N	EA	1		
824787543	P47Q754	CABLE ASSEMBLY	2	1
N	EA	1		
824787550	P47Q755	CABLE ASSEMBLY	2	1
N	EA	1		
824787568	P47Q756	CABLE ASSEMBLY	2	1
N	EA	1		
824787576	P47Q757	CABLE ASSEMBLY	2	1
N	EA	1		
804803740	P480374	GUIDE	9	1
N	EA	1		
804809416	P480941	SCREW	9	1
N	EA	1		
804822658	P482265	GUIDE	9	1
N	EA	1		
804841500	P484150	SCREW	2	1
N	EA	1		

PRODUCT IDENTIFIER	DESCRIPTION		MIN. ORD.	A
	ITEM	ORD. / PA		
804843787	P484378	SPRING	9	1
N	EA	1		
804844322	P484432	SPRING	1	1
N	EA	1		
804847614	P484761	SCREW ASSEMBLY	2	1
N	EA	1		
804847622	P484762	SCREW ASSEMBLY	2	1
N	EA	1		
804851087	P485108	SCREW	2	1
N	EA	1		
804851129	P485112	SPRING ARM	2	1
N	EA	1		
804851491	P485149	GUIDE	9	1
N	EA	1		
804851566	P485156	CLIP	14	1
N	EA	1		
804851582	P485158	WIPING PAD	1	1
N	EA	1		
814842399	P48D239	NUMBERED PARTS	6	1
N	EA	1		
814843785	P48D378	O RING		
1188474	1	EA	IL 08	IN 08
			MI 08	OH 08
			WI 08	
Neoprene gasket used to seal the cover on the 468 apparatus case. Each time an apparatus case is opened, new O Rings must be used.				
814848743	P48D874	STRAP WIRE ST 1000	13	1
N	BX	1		
814863767	P48F376	BRACKET B	13	1
N	EA	1		
814863783	P48F378	CROSS	12	1
N	EA	1		
814869194	P48F919	LENS	13	1
N	EA	1		
814870754	P48G075	FRAME	10	1
N	EA	1		
814870796	P48G079	BAR GROUND	9	1
N	EA	1		
814870804	P48G080	BRACKET	7	1
N	EA	1		
814870820	P48G082	BUS BAR	9	1
N	EA	1		
814880811	P48H081	COVER TOP	3	1
N	EA	1		

DISTRIBUTION SERVICES
 NETWORK SERVICES
 TOOLS
 BUILDING JANITORIAL
 AUTOMOTIVE
 FORMS/OFFICE SUPPLIES
 GENERAL
 DATA VOICE

PRODUCT IDENTIFIER DESCRIPTION						
ITEM	ORD.	SELL	STD. PKG.	LEAD TIME	MIN.	A
NUMBER	MULT.	UNIT	STOCK AVAILABILITY / PA	ORD.	ORD.	C
814881819	P48H181	BRACKET				
N		EA	1	2	1	
824811848	P48J184	TERMINAL				
N		EA	1	13	1	
824814503	P48J450	SLEEVE				
N		EA	1	2	1	
824823272	P48K327	BRACKET				
N		EA	1	1	1	
824827760	P48K776	BUS BAR				
N		EA	1	7	1	
824827778	P48K777	BUS BAR				
N		EA	1	7	1	
824828438	P48K843	RELAY MOUNTING				
N		EA	1	12	1	
824880215	P48O021	CABLE				
N		EA	1	2	1	
824873962	P48P396	WIRE RETAINER				
N		EA	1	13	1	
824894554	P48R455	CABLE				
N		EA	1	2	1	
824894661	P48R466	CABLE				
N		EA	1	2	1	
824894687	P48R468	CABLE				
N		EA	1	8	1	
834851420	P48V142	SCREW				
N		EA	1	2	1	
834881443	P48Y144	KICKPLATE				
N		EA	1	14	1	
834886616	P48Y661	PLUG				
N		EA	1	13	1	
804936862	P493686	PULLEY				
N		EA	1	14	1	
840021893	P493701	HOLD MAGNET				
N		EA	1	5	1	
804965044	P496504	CONTROL SPRING ASSEMBLY				
N		EA	1	9	1	
814932968	P49C296	SCREW				
N		EA	1	6	1	
814934113	P49C411	V BELT				
N		EA	1	9	1	
814947040	P49D704	J BOLT				
N		EA	1	2	1	

PRODUCT IDENTIFIER DESCRIPTION						
ITEM	ORD.	SELL	STD. PKG.	LEAD TIME	MIN.	A
NUMBER	MULT.	UNIT	STOCK AVAILABILITY / PA	ORD.	ORD.	C
814947057	P49D705	J BOLT				
N		EA	1	2	1	
814982997	P49H299	FUSE P				
N		EA	1	14	1	
814986832	P49H683	BUS BAR				
N		EA	1	9	1	
814986956	P49H695	GRID				
N		EA	1	15	1	
814987657	P49H765	BRACKET				
N		EA	1	2	1	
824934434	P49L443	BRACKET				
N		EA	1	13	1	
260386651	P49Q190	ADJUSTING TOOL				
N		EA	1	2	1	
834971509	P49X150	CONNECTOR BRACKET				
N		EA	1	8	1	
400953980	P502177	REGULATOR POWER ASSEM CP2				
N		EA	1	18	1	
		CK20017 L208.				
260387386	P506515	BRAKE SHOE				
N		EA	1	2	1	
818014037	P80A403	NUMBER PLATE				
N		EA	1	1	1	
818014607	P80A460	NUMBER PLATE				
N		EA	1	1	1	
818064511	P80F451	HOUSING ASSEMBLY				
N		EA	1	2	1	
002017515	P81E862	HOUSING IL IPAC				
N		EA	1	6	1	
818645756	P86D575	FACEPLATE				
N		EA	1	13	1	
818645806	P86D580	FACEPLATE 2500-50				
N		EA	1	2	1	
829083856	P90Q385	CABLE				
N		EA	1	12	1	
829182591	P91Q259	CABLE				
N		EA	1	2	1	
829182740	P91Q274	CABLE				
N		EA	1	2	1	
829183789	P91Q378	CABLE				
N		EA	1	9	1	
829184712	P91Q471	CABLE				
N		EA	1	2	1	

DISTRIBUTION SERVICES

NETWORK SERVICES

TOOLS

BUILDING JANITORIAL

AUTOMOTIVE

FORMS/OFFICE SUPPLIES

GENERAL

DATA VOICE

P NUMBERED PARTS

DISTRIBUTION SERVICES

PRODUCT IDENTIFIER		DESCRIPTION					
ITEM NUMBER	ORD. MULT.	SELL UNIT	STD. PKG. STOCK AVAILABILITY / PA	LEAD TIME	MIN. ORD.	A C	

829188077 P91Q807 CABLE DATA ASSEMBLY
N EA 1 2 1

829188085 P91Q808 CABLE DATA ASSEMBLY
N EA 1 2 1

829280429 P92Q042 CABLE DATA ASSEMBLY
N EA 1 2 1

829287390 P92Q739 CABLE
N EA 1 2 1

829344928 P93M492 CABLE
N EA 1 2 1

829348499 P93M849 CABLE ASSEMBLY
N EA 1 2 1

829348507 P93M850 CABLE ASSEMBLY
N EA 1 2 1

829348515 P93M851 CABLE ASSEMBLY
N EA 1 2 1

NETWORK SERVICES

TOOLS

BUILDING JANITORIAL

AUTOMOTIVE

FORMS/OFFICE SUPPLIES

GENERAL

DATA VOICE

RACK

260981279 RACK MOUNT DS24EAH
N EA 1 1 1
Mounting rack.

260982079 RACK MOUNT DS24EAL
N EA 1 1 1
Mounting rack.

260964366 RACK RELAY 97025-00
1238295 1 EA IL IN MI OH WI

260964341 RACK RELAY 97038-00
N EA 1 14 1

260969951 RACK RELAY 97128-00 W/PANELS
N EA 1 14 1

260971635 RACK RELAY 97130-00
N EA 1 12 1

260441068 RACK RELAY MOUNTING DDA23-121
N EA 1 3 1

260986344 RACK RELAY W/5 SHELVES 97145-0
N EA 1 8 1

RECORDER

260360508 RECORDER/ANNOUNCER DIGICEPT
1953778 1 EA
ETC1000-SAC03.

300071305 RECORDER/ANNOUNCER SPEECH
1953802 1 EA IL IN MI OH WI
75

PRODUCT IDENTIFIER		DESCRIPTION					
ITEM NUMBER	ORD. MULT.	SELL UNIT	STD. PKG. STOCK AVAILABILITY / PA	LEAD TIME	MIN. ORD.	A C	

RECTIFIER

260437801 RECTIFIER 25 AMP HARDENED BRWN
NT5C06BB1
N EA 1 4 1

260440516 RECTIFIER 25 AMP HARDENED GRAY
NT5C06BB3
N EA 1 4 1

260435821 RECTIFIER 25A
1980326 1 EA IL IN MI OH WI
Enhanced NT5C06CA-1 (brown) or NT5C06CA-3 (gray) MPR 25 amp plug in.

300010063 RECTIFIER A50F50 LORAIN 50A
1959759 1 EA IL IN MI OH WI
09
48V 1PH Battery Charger 5438-008.

260380886 RECTIFIER BULK 5438-01400
1960807 1 EA IL IN MI OH WI
09 09 09
Electronic equipment components to be assembled within a Fujitsu 6200 cabinet.

400735254 RECTIFIER CK15620 L22
N EA 1 2 1
Semi-conductor type automatic regulation and is used on teletype machines. BSP 169-682-302.

401124755 RECTIFIER CK15620 L23
N EA 1 2 1

401968953 RECTIFIER CK19574 L 4 STACK
N EA 1 13 1

996566626 RECTIFIER CK19642 L 3
N EA 1 1 1

400382099 RECTIFIER CK20575 L 1
N EA 1 2 1
Power supply used in a 27A1 Data Mounting. BSP 590-102-123.

260435953 RECTIFIER MODULES A50B50
1980441 1 EA IL IN MI OH WI
09 09 09 09 09

260405238 RECTIFIER PLUG-IN CD MZ6A50
1969451 1 EA IL IN MI OH WI
09

260405220 RECTIFIER SHELF MZ12CAB
1969444 1 EA IL IN MI OH WI
09

260440524 RECTIFIER SHELF NT5C91CG
N EA 1 6 1

DISTRIBUTION SERVICES

NETWORK SERVICES

TOOLS

BUILDING JANITORIAL

AUTOMOTIVE

FORMS/OFFICE SUPPLIES

GENERAL

DATA VOICE

PRODUCT IDENTIFIER		DESCRIPTION				
ITEM NUMBER	ORD. MULT.	SELL UNIT	STD. PKG. STOCK AVAILABILITY / PA	LEAD TIME	MIN. ORD.	A C

REGISTER MESSAGE

100401108 REGISTER MESSAGE 14 B						
N		EA	1	2	1	
100401124 REGISTER MESSAGE 14 C						
N		EA	1	2	1	
100401165 REGISTER MESSAGE 14 E						
N		EA	1	2	1	
Intended for use in step by step and crossbar dial systems. Single winding, 600 ohm, traffic register, BSP 030-331-701.						
100401181 REGISTER MESSAGE 14 F						
N		EA	1	2	1	
100401231 REGISTER MESSAGE 14 J						
N		EA	1	2	1	
100401249 REGISTER MESSAGE 14 K						
N		EA	1	2	1	
100401355 REGISTER MESSAGE 14 LA						
N		EA	1	9	1	
100401421 REGISTER MESSAGE 14 LE						
N		EA	1	2	1	
Single winding, 1000 ohms, used as a traffic register.						
100401496 REGISTER MESSAGE 14 LK						
N		EA	1	2	1	
100401256 REGISTER MESSAGE 14 M						
N		EA	1	2	1	
Intended for use in step by step and cross dial telephone systems. Single winding traffic register, 600 ohm.						
100401603 REGISTER MESSAGE 15 A						
N		EA	1	2	1	
102548443 REGISTER MESSAGE 19 A						
N		EA	1	2	1	
A five digit non-resettable, electromagnetic counter. BSP 030-311-811.						
102578754 REGISTER MESSAGE 20 A						
N		EA	1	2	1	
103127270 REGISTER MESSAGE 21 A						
N		EA	1	2	1	

RELAY

300045374 RELAY		100AP SOLID STATE				
N		BX	1	2	1	
Box of 1.						
100402627 RELAY		114EA				
N		EA	1	7	1	

PRODUCT IDENTIFIER		DESCRIPTION				
ITEM NUMBER	ORD. MULT.	SELL UNIT	STD. PKG. STOCK AVAILABILITY / PA	LEAD TIME	MIN. ORD.	A C

100402643 RELAY		114KA				
N		EA	1	2	1	
100403500 RELAY		149CE				
N		EA	1	7	1	
100403674 RELAY		162Y				
N		EA	1	2	1	
100404086 RELAY		178BW				
N		EA	1	7	1	
100404359 RELAY		178EK				
N		EA	1	7	1	
100404367 RELAY		186A				
N		EA	1	2	1	
942 OHMS. Return polepiece relay with crosstalk-proof cover. BSP 040-224-701.						
100404383 RELAY		186C				
N		EA	1	2	1	
100404656 RELAY		208C				
N		EA	1	2	1	
100404672 RELAY		208G				
N		EA	1	2	1	
100404797 RELAY		218B				
N		EA	1	7	1	
100405117 RELAY		221BC				
N		EA	1	2	1	
100405240 RELAY		221CA				
N		EA	1	7	1	
100405364 RELAY		221CP				
1159376	1	EA	IL	IN	MI	OH
			09	09		WI
Intended to mount in the left hand drilling of No. 985A or similar type mounting plates. Used in step by step switch, BSP 040-236-711.						
100405372 RELAY		221CR				
1140632	1	EA	IL	IN	MI	OH
			09	09		WI
Intended to mount in the left hand drilling of No. 985A or similar type mounting plates. Used in step by step switch, BSP 040-236-711.						
100405745 RELAY		221FG				
N		EA	1	7	1	
100406685 RELAY		221ME				
N		EA	1	7	1	
100406701 RELAY		221MG				
N		EA	1	7	1	
100406842 RELAY		221ND				
N		EA	1	4	1	

RELAY

DISTRIBUTION SERVICES

PRODUCT IDENTIFIER		DESCRIPTION				
ITEM NUMBER	ORD. MULT.	SELL UNIT	STD. PKG. STOCK AVAILABILITY / PA	LEAD TIME	MIN. ORD.	A C
100406867		RELAY	221NF			
N		EA	1	2	1	

NETWORK SERVICES

100406909		RELAY	221NL			
1217554	1	EA	IL IN MI OH WI			
			09			
Used in Central Office equipment.						
100404888		RELAY	221P			
1202598	1	EA	IL IN MI OH WI			
			09			
Intended to mount in the left hand drilling of No. 985A or similar type mounting plates, package of 25, BSP 040-236-711.						

TOOLS

100404904		RELAY	221T			
N		EA	1	2	1	
100404912		RELAY	221U			
N		EA	1	7	1	

BUILDING JANITORIAL

100407386		RELAY	222AF			
N		EA	1	7	1	
100407535		RELAY	222BH			
N		EA	1	12	1	
100407859		RELAY	222CB			
N		EA	1	7	1	

AUTOMOTIVE

100407733		RELAY	222CM			
N		EA	1	2	1	
100407741		RELAY	222CN			
N		EA	1	2	1	
100407758		RELAY	222CP			
N		EA	1	2	1	

FORMS/OFFICE SUPPLIES

100407766		RELAY	222CU			
N		EA	1	7	1	
100407923		RELAY	222EE			
N		EA	1	7	1	
100407949		RELAY	222EG			
N		EA	1	2	1	

GENERAL

100408087		RELAY	222FE			
N		EA	1	7	1	
100408194		RELAY	222GC			
N		EA	1	7	1	
100408285		RELAY	222GN			
N		EA	1	12	1	
100408301		RELAY	222GR			
N		EA	1	7	1	

DATA VOICE

100408327		RELAY	222GT			
N		EA	1	12	1	

PRODUCT IDENTIFIER		DESCRIPTION				
ITEM NUMBER	ORD. MULT.	SELL UNIT	STD. PKG. STOCK AVAILABILITY / PA	LEAD TIME	MIN. ORD.	A C
100407279		RELAY	222H			
N		EA	1	2	1	
100408582		RELAY	222JH			
N		EA	1	7	1	
100408590		RELAY	222JJ			
N		EA	1	7	1	
100408624		RELAY	222JM			
N		EA	1	7	1	
100408715		RELAY	222KC			
N		EA	1	2	1	

100408806		RELAY	222KM			
N		EA	1	2	1	
100408814		RELAY	222KN			
N		EA	1	2	1	
100407329		RELAY	222T			
N		EA	1	2	1	
100409127		RELAY	223A			
N		EA	1	7	1	
100409325		RELAY	223AC			
N		EA	1	12	1	
100409366		RELAY	223AG			
N		EA	1	12	1	
100409457		RELAY	223BE			
N		EA	1	7	1	
100409523		RELAY	223BN			
N		EA	1	2	1	

100409739		RELAY	223DA			
N		EA	1	7	1	
100409291		RELAY	223Y			
N		EA	1	7	1	
100409945		RELAY	224AB			
N		EA	1	7	1	
100409952		RELAY	224AD			
N		EA	1	7	1	
100410067		RELAY	224BC			
N		EA	1	12	1	
100410141		RELAY	224BN			
N		EA	1	2	1	

100410224		RELAY	224CB			
N		EA	1	7	1	
100410257		RELAY	224CE			
N		EA	1	7	1	

DISTRIBUTION SERVICES

NETWORK SERVICES

TOOLS

BUILDING JANITORIAL

AUTOMOTIVE

FORMS/OFFICE SUPPLIES

GENERAL

DATA VOICE

PRODUCT IDENTIFIER		DESCRIPTION				
ITEM NUMBER	ORD. MULT.	SELL UNIT	STD. PKG. STOCK AVAILABILITY / PA	LEAD TIME	MIN. ORD.	A C
100409820		RELAY	224D			
N		EA	1	13	1	
100409838		RELAY	224E			
N		EA	1	2	1	
100410430		RELAY	225R			
N		EA	1	7	1	
100410448		RELAY	225T			
N		EA	1	7	1	
100410455		RELAY	225U			
N		EA	1	12	1	
100410471		RELAY	225Y			
N		EA	1	2	1	
100410562		RELAY	235D			
N		EA	1	2	1	
100410570		RELAY	235E			
N		EA	1	2	1	
100410729		RELAY	2475			
N		EA	1	6	1	
100410679		RELAY	247C			
N		EA	1	2	1	
100410760		RELAY	248A			
N		EA	1	2	1	
100410828		RELAY	248G			
N		EA	1	2	1	
100410844		RELAY	248J			
N		EA	1	7	1	
100411610		RELAY	260CE			
N		EA	1	5	1	
100411099		RELAY	260L			
N		EA	1	14	1	
100411982		RELAY	261AD			
N		EA	1	3	1	
100412014		RELAY	261AG			
N		EA	1	5	1	
100412089		RELAY	266B			
N		EA	1	2	1	
100412139		RELAY	267A			
N		EA	1	2	1	
100412162		RELAY	268A			
N		EA	1	2	1	
100412170		RELAY	268B			
N		EA	1	2	1	

PRODUCT IDENTIFIER		DESCRIPTION				
ITEM NUMBER	ORD. MULT.	SELL UNIT	STD. PKG. STOCK AVAILABILITY / PA	LEAD TIME	MIN. ORD.	A C
100412196		RELAY	275A			
N		EA	1	1	1	
Non-adjustable relay, BSP 040-263-701.						
100412204		RELAY	275B			
N		EA	1	1	1	
100412212		RELAY	275C			
N		EA	1	11	1	
100412220		RELAY	275D			
N		EA	1	11	1	
100412378		RELAY	276			
N		EA	1	1	1	
100412253		RELAY	276A			
1155614	1	EA		IL 09	IN 09	MI 09
				OH 09	WI 09	
Non-adjustable relay used in SxS C.O., BSP 040-263-701.						
100412444		RELAY	276AA			
1334367	1	EA		IL 09	IN 09	MI 09
				OH 09	WI 09	
101966380		RELAY	276AC			
N		EA	1	13	1	
100412261		RELAY	276B			
N		EA	1	1	1	
100412311		RELAY	276G			
N		EA	1	11	1	
100412337		RELAY	276J			
N		EA	1	1	1	
100412394		RELAY	276S			
N		EA	1	1	1	
100412410		RELAY	276U			
N		EA	1	6	1	
100412451		RELAY	280A			
N		EA	1	2	1	
100412659		RELAY	280AA			
N		EA	1	2	1	
100412709		RELAY	280AF			
N		EA	1	2	1	
100412733		RELAY	280AJ			
N		EA	1	2	1	
100412741		RELAY	280AK			
N		EA	1	2	1	
100412766		RELAY	280AM			
N		EA	1	2	1	
100412774		RELAY	280AN			
N		EA	1	2	1	

RELAY

DISTRIBUTION SERVICES

NETWORK SERVICES

TOOLS

BUILDING JANITORIAL

AUTOMOTIVE

FORMS/OFFICE SUPPLIES

GENERAL

DATA VOICE

PRODUCT IDENTIFIER		DESCRIPTION						
ITEM NUMBER	ORD. MULT.	SELL UNIT	STD. PKG. STOCK	PKG. AVAILABILITY	LEAD TIME / PA	MIN. ORD.	A C	
100412790		RELAY	280AR	N	EA	1	2	1
100412816		RELAY	280AT	N	EA	1	6	1
100412824		RELAY	280AU	N	EA	1	2	1
100412931		RELAY	280BJ	N	EA	1	6	1
100412949		RELAY	280BK	N	EA	1	9	1
100412956		RELAY	280BL	N	EA	1	2	1
100413012		RELAY	280BT	N	EA	1	6	1
100413061		RELAY	280CB	N	EA	1	2	1
100413129		RELAY	280CH	N	EA	1	2	1
100412485		RELAY	280D	N	EA	1	2	1
100412493		RELAY	280E	N	EA	1	2	1
100413491		RELAY	280EE	N	EA	1	7	1
100413640		RELAY	280EY	N	EA	1	6	1
100412501		RELAY	280F	N	EA	1	2	1
100413681		RELAY	280FD	N	EA	1	12	1
100413707		RELAY	280FF	N	EA	1	7	1
100413715		RELAY	280FG	N	EA	1	2	1
100413749		RELAY	280FK	N	EA	1	6	1
100413764		RELAY	280FM	N	EA	1	2	1
100413772		RELAY	280FN	N	EA	1	2	1
100413798		RELAY	280FR	N	EA	1	7	1

PRODUCT IDENTIFIER		DESCRIPTION						
ITEM NUMBER	ORD. MULT.	SELL UNIT	STD. PKG. STOCK	PKG. AVAILABILITY	LEAD TIME / PA	MIN. ORD.	A C	
100413814		RELAY	280FT	N	EA	1	7	1
100413830		RELAY	280FW	N	EA	1	2	1
100413848		RELAY	280FY	N	EA	1	2	1
100412519		RELAY	280G	N	EA	1	2	1
100413855		RELAY	280GA	N	EA	1	6	1
100412527		RELAY	280H	N	EA	1	2	1
100412543		RELAY	280K	N	EA	1	2	1
100412592		RELAY	280R	N	EA	1	2	1
100412634		RELAY	280W	N	EA	1	2	1
100412642		RELAY	280Y	N	EA	1	2	1
100413947		RELAY	282A	N	EA	1	7	1
100413954		RELAY	286A	N	EA	1	1	1
100413970		RELAY	286C	N	EA	1	6	1
100413988		RELAY	286D	N	EA	1	5	1
100414010		RELAY	286G	N	EA	1	1	1
100414028		RELAY	286H	N	EA	1	1	1
100414051		RELAY	286L	N	EA	1	1	1
100414085		RELAY	287A	N	EA	1	1	1
100414093		RELAY	287B	N	EA	1	1	1
100414127		RELAY	287E	N	EA	1	1	1
100414135		RELAY	287F	N	EA	1	1	1

PRODUCT IDENTIFIER		DESCRIPTION				
ITEM NUMBER	ORD. MULT.	SELL UNIT	STD. PKG. STOCK AVAILABILITY / PA	LEAD TIME	MIN. ORD.	A C
100414168		RELAY	288A			
N		EA	1	5	1	
101159887		RELAY	290B			
N		EA	1	13	1	
100414234		RELAY	292A			
1232686	1	EA	IL IN MI OH WI 09 09 09 09 09			
Non-adjustable relay intended for use in the No. 5 crossbar system originating register.						
100414242		RELAY	292B			
N		EA	1	13	1	
100414267		RELAY	293A			
N		EA	1	2	1	
Intended for use in the No. 5 crossbar registers and tandem senders.						
100414283		RELAY	293C			
N		EA	1	13	1	
100414291		RELAY	293D			
N		EA	1	7	1	
100414309		RELAY	293E			
N		EA	1	10	1	
100414317		RELAY	293F			
N		EA	1	11	1	
101159903		RELAY	293J			
N		EA	1	10	1	
100414386		RELAY	295A			
N		EA	1	2	1	
101159937		RELAY	295B			
N		EA	1	6	1	
100414424		RELAY	303A			
1137810	1	EA	IL IN MI OH WI 09 09 09 09 09			
A non-adjustable non-bridging relay. Intended for use in the No. 1A line connectors, BSP 040-263-701.						
100414432		RELAY	303B			
N		EA	1	1	1	
100414440		RELAY	303C			
N		EA	1	1	1	
100414457		RELAY	303D			
N		EA	1	11	1	
100414465		RELAY	303E			
N		EA	1	1	1	
100414473		RELAY	303F			
1144493	1	EA	IL IN MI OH WI 09 09 09 09 09			
Intended for use in the type P carrier system, BSP 040-263-701.						

PRODUCT IDENTIFIER		DESCRIPTION				
ITEM NUMBER	ORD. MULT.	SELL UNIT	STD. PKG. STOCK AVAILABILITY / PA	LEAD TIME	MIN. ORD.	A C
100414481		RELAY	303G			
1224998	1	EA	IL IN MI OH WI 09 09 09 09 09			
Relay used only in toll offices.						
100414515		RELAY	303K			
N		EA	1	8	1	
100414549		RELAY	307B			
N		EA	1	2	1	
100414606		RELAY	310C			
N		EA	1	2	1	
100414648		RELAY	313A			
2747709	1	EA	IL IN MI OH WI 09 09 09 09 09			
Mercury type enclosed unit.						
100414655		RELAY	313B			
N		EA	1	1	1	
100414697		RELAY	316A			
N		EA	1	1	1	
102244365		RELAY	316AH			
N		EA	1	1	1	
100414705		RELAY	316B			
1232884	1	EA	IL IN MI OH WI 09 09 09 09 09			
Non-adjustable polar latching or bias relay, package of 18.						
100414713		RELAY	316C			
N		EA	1	8	1	
100414721		RELAY	316D			
N		EA	1	1	1	
100414739		RELAY	316E			
N		EA	1	1	1	
100414747		RELAY	316F			
N		EA	1	1	1	
100414754		RELAY	318G			
N		EA	1	1	1	
100414762		RELAY	316H			
N		EA	1	8	1	
100414770		RELAY	318J			
N		EA	1	1	1	
100993773		RELAY	318K			
N		EA	1	11	1	
100993781		RELAY	318L			
N		EA	1	1	1	
100993799		RELAY	318M			
N		EA	1	10	1	

DISTRIBUTION SERVICES
 NETWORK SERVICES
 TOOLS
 BUILDING JANITORIAL
 AUTOMOTIVE
 FORMS/OFFICE SUPPLIES
 GENERAL
 DATA VOICE

RELAY

DISTRIBUTION SERVICES

NETWORK SERVICES

TOOLS

BUILDING JANITORIAL

AUTOMOTIVE

FORMS/OFFICE SUPPLIES

GENERAL

DATA VOICE

PRODUCT IDENTIFIER		DESCRIPTION				
ITEM NUMBER	ORD. MULT.	SELL UNIT	STD. PKG. STOCK AVAILABILITY / PA	LEAD TIME	MIN. ORD.	A C
100993807		RELAY	316N			
N		EA	1	1	1	
100993815		RELAY	316P			
N		EA	1	1	1	
100993823		RELAY	316R			
N		EA	1	1	1	
100993856		RELAY	316U			
N		EA	1	1	1	
100987312		RELAY	316W			
N		EA	1	13	1	
101305597		RELAY	326AB			
N		EA	1	13	1	
101927986		RELAY	326B			
N		EA	1	1	1	
100993864		RELAY	330A			
N		EA	1	8	1	
102022704		RELAY	334A			
N		EA	1	10	1	
102472982		RELAY	334C			
N		EA	1	13	1	
102472990		RELAY	334D			
N		EA	1	11	1	
100464809		RELAY	421			
N		EA	1	6	1	
100468578		RELAY AF	3			
N		EA	1	2	1	
100468610		RELAY AF	5			
N		EA	1	6	1	
100468636		RELAY AF	6			
N		EA	1	2	1	
100468651		RELAY AF	8			
N		EA	1	2	1	
100468677		RELAY AF	9			
N		EA	1	2	1	
100468693		RELAY AF	10			
N		EA	1	2	1	
100468719		RELAY AF	11			
N		EA	1	2	1	
100468735		RELAY AF	12			
N		EA	1	2	1	
100468776		RELAY AF	15			
N		EA	1	2	1	

PRODUCT IDENTIFIER		DESCRIPTION				
ITEM NUMBER	ORD. MULT.	SELL UNIT	STD. PKG. STOCK AVAILABILITY / PA	LEAD TIME	MIN. ORD.	A C
100468792		RELAY AF	16			
N		EA	1	2	1	
100468834		RELAY AF	18			
N		EA	1	2	1	
100468859		RELAY AF	19			
N		EA	1	11	1	
100468875		RELAY AF	20			
N		EA	1	2	1	
100468891		RELAY AF	21			
N		EA	1	2	1	
100468917		RELAY AF	22			
N		EA	1	2	1	
100468933		RELAY AF	23			
N		EA	1	2	1	
100468958		RELAY AF	24			
N		EA	1	2	1	
100468974		RELAY AF	25			
N		EA	1	7	1	
100469014		RELAY AF	27			
N		EA	1	2	1	
100469030		RELAY AF	28			
N		EA	1	8	1	
100469055		RELAY AF	30			
N		EA	1	2	1	
100469071		RELAY AF	32			
N		EA	1	2	1	
100469097		RELAY AF	33			
N		EA	1	2	1	
100469113		RELAY AF	34			
N		EA	1	2	1	
100469139		RELAY AF	35			
N		EA	1	2	1	
100469170		RELAY AF	40			
N		EA	1	2	1	
100469196		RELAY AF	42			
N		EA	1	2	1	
100469295		RELAY AF	50			
N		EA	1	2	1	
100469311		RELAY AF	51			
N		EA	1	2	1	
100469337		RELAY AF	52			
N		EA	1	2	1	

PRODUCT IDENTIFIER DESCRIPTION						
ITEM NUMBER	ORD. MULT.	SELL UNIT	STD. PKG. STOCK AVAILABILITY / PA	LEAD TIME	MIN. ORD.	A C
100469352	RELAY AF	53				
N		EA	1	2	1	
100469451	RELAY AF	59				
N		EA	1	2	1	
100469477	RELAY AF	60				
N		EA	1	2	1	
100469519	RELAY AF	63				
N		EA	1	2	1	
100469535	RELAY AF	64				
N		EA	1	2	1	
100469576	RELAY AF	67				
N		EA	1	2	1	
100469691	RELAY AF	77				
N		EA	1	6	1	
100469733	RELAY AF	82				
N		EA	1	2	1	
100469758	RELAY AF	83				
N		EA	1	2	1	
100469774	RELAY AF	84				
N		EA	1	2	1	
100469790	RELAY AF	85				
N		EA	1	6	1	
100469956	RELAY AF	94				
N		EA	1	2	1	
100469972	RELAY AF	95				
N		EA	1	2	1	
100469998	RELAY AF	96				
N		EA	1	2	1	
100470053	RELAY AF	99				
N		EA	1	2	1	
100470178	RELAY AF	105				
N		EA	1	2	1	
100470194	RELAY AF	106				
N		EA	1	1	1	
100470210	RELAY AF	109				
N		EA	1	2	1	
100470236	RELAY AF	110				
N		EA	1	2	1	
100470277	RELAY AF	112				
N		EA	1	2	1	
100470319	RELAY AF	114				
N		EA	1	2	1	

PRODUCT IDENTIFIER DESCRIPTION						
ITEM NUMBER	ORD. MULT.	SELL UNIT	STD. PKG. STOCK AVAILABILITY / PA	LEAD TIME	MIN. ORD.	A C
100470335	RELAY AF	115				
N		EA	1	2	1	
100470350	RELAY AF	116				
N		EA	1	2	1	
100470418	RELAY AF	119				
N		EA	1	11	1	
100470715	RELAY AF	134				
N		EA	1	2	1	
100470731	RELAY AF	135				
N		EA	1	2	1	
100470756	RELAY AF	136				
N		EA	1	2	1	
100470772	RELAY AF	137				
N		EA	1	2	1	
Single - General purpose wire spring relays for normal spring loads. Have 2 or 3 parallel rows of wire contact Springs, each row molded into individual base.						
100470798	RELAY AF	138				
N		EA	1	6	1	
100470905	RELAY AF	144				
N		EA	1	7	1	
100471044	RELAY AF	151				
N		EA	1	6	1	
100471085	RELAY AF	153				
N		EA	1	11	1	
100471101	RELAY AF	154				
N		EA	1	2	1	
100471143	RELAY AF	156				
N		EA	1	2	1	
100471382	RELAY AF	168				
N		EA	1	8	1	
102855038	RELAY AF	175				
N		EA	1	6	1	
100471432	RELAY AF	500				
N		EA	1	6	1	
100471457	RELAY AF	501				
N		EA	1	2	1	
100471473	RELAY AF	502				
N		EA	1	2	1	
100471499	RELAY AF	504				
N		EA	1	2	1	
100471515	RELAY AF	505				
N		EA	1	2	1	

DISTRIBUTION SERVICES

NETWORK SERVICES

TOOLS

BUILDING JANITORIAL

AUTOMOTIVE

FORMS/OFFICE SUPPLIES

GENERAL

DATA VOICE

RELAY

PRODUCT IDENTIFIER		DESCRIPTION					
ITEM NUMBER	ORD. MULT.	SELL UNIT	STD. PKG. STOCK AVAILABILITY / PA	LEAD TIME	MIN. ORD.	A C	
100471531		RELAY AF 506					
N		EA	1	2	1		
100471556		RELAY AF 507					
N		EA	1	2	1		
100471598		RELAY AF 509					
N		EA	1	2	1		
100471630		RELAY AF 511					
N		EA	1	2	1		
100471655		RELAY AF 512					
N		EA	1	2	1		
100471671		RELAY AF 513					
N		EA	1	2	1		
100471697		RELAY AF 514					
N		EA	1	2	1		
100471713		RELAY AF 515					
N		EA	1	2	1		
100471739		RELAY AF 516					
N		EA	1	2	1		
100471754		RELAY AF 517					
N		EA	1	2	1		
100471770		RELAY AF 518					
2746206	1	EA					
			IL	IN	MI	OH	
			09	09	09	09	
			DISCONTINUE UPON STOCK DEPLETION				
100471796		RELAY AF 519					
N		EA	1	2	1		
100471812		RELAY AF 520					
N		EA	1	2	1		
100471838		RELAY AF 521					
N		EA	1	2	1		
100471853		RELAY AF 522					
N		EA	1	2	1		
100471879		RELAY AF 523					
N		EA	1	2	1		
100471895		RELAY AF 524					
N		EA	1	2	1		
100471937		RELAY AF 527					
N		EA	1	2	1		
260386735		RELAY AF 530					
N		EA	1	4	1		
100472018		RELAY AF 531					
N		EA	1	2	1		

PRODUCT IDENTIFIER		DESCRIPTION				
ITEM NUMBER	ORD. MULT.	SELL UNIT	STD. PKG. STOCK AVAILABILITY / PA	LEAD TIME	MIN. ORD.	A C
100472075		RELAY AF 534				
N		EA	1	2	1	
100472117		RELAY AF 536				
N		EA	1	2	1	
100472133		RELAY AG 1				
N		EA	1	2	1	
100472190		RELAY AG 4				
N		EA	1	2	1	
100472273		RELAY AG 9				
N		EA	1	2	1	
100472331		RELAY AG 12				
N		EA	1	2	1	
100472372		RELAY AG 14				
N		EA	1	2	1	
100472398		RELAY AG 15				
N		EA	1	2	1	
100472414		RELAY AG 16				
N		EA	1	2	1	
100472430		RELAY AG 17				
N		EA	1	2	1	
100472497		RELAY AG 20				
N		EA	1	2	1	
100472513		RELAY AG 21				
N		EA	1	2	1	
						Relay used in SxS and X-bar.
100472539		RELAY AG 22				
N		EA	1	2	1	
						Relay used in SxS and X-bar.
100472570		RELAY AG 24				
N		EA	1	2	1	
100472612		RELAY AG 27				
N		EA	1	6	1	
100472653		RELAY AG 29				
N		EA	1	6	1	
100472737		RELAY AG 33				
N		EA	1	2	1	
100472810		RELAY AG 37				
N		EA	1	2	1	
100472836		RELAY AG 38				
N		EA	1	2	1	
100472935		RELAY AG 43				
N		EA	1	2	1	

DISTRIBUTION SERVICES

NETWORK SERVICES

TOOLS

BUILDING JANITORIAL

AUTOMOTIVE

FORMS/OFFICE SUPPLIES

GENERAL

DATA VOICE

PRODUCT IDENTIFIER		DESCRIPTION				
ITEM NUMBER	ORD. MULT.	SELL UNIT	STD. PKG. STOCK AVAILABILITY / PA	LEAD TIME	MIN. ORD.	A C
100472950	RELAY	AG	44			
N		EA	1	2	1	
100472976	RELAY	AG	45			
N		EA	1	2	1	
100473032	RELAY	AG	48			
N		EA	1	2	1	
100473057	RELAY	AG	49			
N		EA	1	2	1	
100473198	RELAY	AG	56			
N		EA	1	6	1	
101284461	RELAY	AG	62			
N		EA	1	7	1	
100473297	RELAY	AJ	1			
N		EA	1	2	1	
100473313	RELAY	AJ	3			
N		EA	1	2	1	
100473339	RELAY	AJ	5			
N		EA	1	2	1	
100473354	RELAY	AJ	7			
N		EA	1	2	1	
100473370	RELAY	AJ	8			
N		EA	1	2	1	
100473396	RELAY	AJ	9			
N		EA	1	2	1	
100473412	RELAY	AJ	10			
N		EA	1	6	1	
100473453	RELAY	AJ	12			
N		EA	1	2	1	
100473479	RELAY	AJ	14			
N		EA	1	2	1	
100473495	RELAY	AJ	15			
N		EA	1	2	1	
100473511	RELAY	AJ	16			
N		EA	1	2	1	
100473545	RELAY	AJ	18			
N		EA	1	7	1	
100473560	RELAY	AJ	19			
N		EA	1	6	1	
100473602	RELAY	AJ	21			
N		EA	1	2	1	
100473628	RELAY	AJ	22			
N		EA	1	2	1	

PRODUCT IDENTIFIER		DESCRIPTION				
ITEM NUMBER	ORD. MULT.	SELL UNIT	STD. PKG. STOCK AVAILABILITY / PA	LEAD TIME	MIN. ORD.	A C
100473669	RELAY	AJ	24			
N		EA	1	2	1	
100473685	RELAY	AJ	25			
N		EA	1	2	1	
100473701	RELAY	AJ	26			
N		EA	1	2	1	
100473743	RELAY	AJ	28			
N		EA	1	2	1	
100473784	RELAY	AJ	30			
N		EA	1	2	1	
100473826	RELAY	AJ	32			
N		EA	1	2	1	
100473966	RELAY	AJ	39			
N		EA	1	2	1	
100474048	RELAY	AJ	43			
N		EA	1	2	1	
100474063	RELAY	AJ	45			
N		EA	1	2	1	
100474105	RELAY	AJ	47			
N		EA	1	2	1	
100474147	RELAY	AJ	49			
N		EA	1	2	1	
100474162	RELAY	AJ	50			
N		EA	1	2	1	
100474204	RELAY	AJ	52			
N		EA	1	2	1	
100474261	RELAY	AJ	55			
N		EA	1	2	1	
100474428	RELAY	AJ	63			
N		EA	1	2	1	
100474469	RELAY	AJ	65			
N		EA	1	8	1	
100474584	RELAY	AJ	72			
N		EA	1	2	1	
100474766	RELAY	AJ	81			
N		EA	1	2	1	
100474808	RELAY	AJ	83			
N		EA	1	2	1	
100474824	RELAY	AJ	84			
N		EA	1	6	1	
100475037	RELAY	AJ	95			
N		EA	1	2	1	

RELAY

DISTRIBUTION SERVICES

NETWORK SERVICES

TOOLS

BUILDING JANITORIAL

AUTOMOTIVE

FORMS/OFFICE SUPPLIES

GENERAL

DATA VOICE

PRODUCT IDENTIFIER	DESCRIPTION		ITEM NUMBER	ORD. MULT.	SELL UNIT	STD. PKG. STOCK AVAILABILITY / PA	LEAD TIME	MIN. ORD.	A C
100475151	RELAY AJ 101		N		EA	1	6	1	
100475177	RELAY AJ 102		N		EA	1	2	1	
100475276	RELAY AJ 107		N		EA	1	2	1	
100475292	RELAY AJ 108		N		EA	1	2	1	
100475433	RELAY AJ 115		N		EA	1	2	1	
100475490	RELAY AJ 118		N		EA	1	2	1	
100475516	RELAY AJ 119		N		EA	1	2	1	
100475631	RELAY AJ 125		N		EA	1	2	1	
100475755	RELAY AJ 131		N		EA	1	2	1	
100475805	RELAY AJ 135		N		EA	1	6	1	
100838143	RELAY AJ 136		N		EA	1	2	1	
100986892	RELAY AJ 138		N		EA	1	2	1	
100986900	RELAY AJ 142		N		EA	1	6	1	
101549442	RELAY AJ 146		N		EA	1	2	1	
101638294	RELAY AJ 147		N		EA	1	2	1	
102209939	RELAY AJ 156		N		EA	1	2	1	
102301017	RELAY AJ 158		N		EA	1	6	1	
100475847	RELAY AJ 202		N		EA	1	2	1	
102054855	RELAY AJ 300		N		EA	1	2	1	
100475920	RELAY AJ 500		N		EA	1	6	1	
100475946	RELAY AJ 501		N		EA	1	2	1	

PRODUCT IDENTIFIER	DESCRIPTION		ITEM NUMBER	ORD. MULT.	SELL UNIT	STD. PKG. STOCK AVAILABILITY / PA	LEAD TIME	MIN. ORD.	A C
100475961	RELAY AJ 502		N		EA	1	2	1	
100475987	RELAY AJ 503		2746248	1	EA	IL IN MI OH WI 09 09			
Wire spring relay AJ general purpose, multicontact, electromagnetic component used as fundamental building blocks for telephone switching systems such as crossbar.									
100476001	RELAY AJ 504		N		EA	1	2	1	
100476043	RELAY AJ 506		N		EA	1	2	1	
100476068	RELAY AJ 507		N		EA	1	2	1	
100476084	RELAY AJ 508		N		EA	1	2	1	
100476100	RELAY AJ 509		N		EA	1	2	1	
100476167	RELAY AJ 512		N		EA	1	2	1	
100476183	RELAY AJ 513		N		EA	1	2	1	
100476241	RELAY AJ 516		N		EA	1	2	1	
102025988	RELAY AJ 525		N		EA	1	2	1	
100476340	RELAY AJ 700		N		EA	1	2	1	
100476365	RELAY AJ 702		N		EA	1	2	1	
102033115	RELAY AJ 704		N		EA	1	2	1	
100476423	RELAY AK 2		N		EA	1	2	1	
100476464	RELAY AK 4		1233627	1	EA	IL IN MI OH WI 09 09 09 09 09			
Relay used in X-bar C.O.									
100476506	RELAY AK 6		N		EA	1	2	1	
BSP-040-504-801.									
100476522	RELAY AK 7		N		EA	1	2	1	
100476548	RELAY AK 8		N		EA	1	2	1	

DISTRIBUTION SERVICES

NETWORK SERVICES

TOOLS

BUILDING JANITORIAL

AUTOMOTIVE

FORMS/OFFICE SUPPLIES

GENERAL

DATA VOICE

PRODUCT IDENTIFIER		DESCRIPTION						
ITEM	ORD.	SELL	STD. PKG.	LEAD TIME			MIN.	A
NUMBER	MULT.	UNIT	STOCK AVAILABILITY / PA			ORD.	C	
100476563		RELAY AK	9					
N		EA	1	6			1	
100476589		RELAY AK	10					
N		EA	1	2			1	
100476621		RELAY AK	12					
N		EA	1	2			1	
100476647		RELAY AK	13					
N		EA	1	2			1	
100476662		RELAY AK	14					
N		EA	1	2			1	
100476829		RELAY AK	22					
2746222	1	EA		IL	IN	MI	OH	WI
				09	09	09	09	09
100476845		RELAY AK	23					
N		EA	1	2			1	
100476860		RELAY AK	24					
N		EA	1	2			1	
100476886		RELAY AK	25					
N		EA	1	7			1	
100476928		RELAY AK	27					
N		EA	1	2			1	
100476969		RELAY AK	29					
N		EA	1	2			1	
100476985		RELAY AK	30					
N		EA	1	2			1	
100477082		RELAY AK	35					
N		EA	1	2			1	
100477124		RELAY AK	37					
N		EA	1	2			1	
100477140		RELAY AK	38					
N		EA	1	6			1	
100477165		RELAY AK	39					
N		EA	1	2			1	
100477207		RELAY AK	41					
N		EA	1	2			1	
100477249		RELAY AK	44					
N		EA	1	2			1	
101143444		RELAY AK	46					
N		EA	1	2			1	
101143477		RELAY AK	47					
N		EA	1	2			1	
101143485		RELAY AK	48					
N		EA	1	2			1	

PRODUCT IDENTIFIER		DESCRIPTION						
ITEM	ORD.	SELL	STD. PKG.	LEAD TIME			MIN.	A
NUMBER	MULT.	UNIT	STOCK AVAILABILITY / PA			ORD.	C	
101317790		RELAY AK	49					
N		EA	1	2			1	
101644771		RELAY AK	56					
N		EA	1	2			1	
101644789		RELAY AK	57					
N		EA	1	2			1	
102315520		RELAY AK	62					
N		EA	1	2			1	
102315538		RELAY AK	63					
N		EA	1	2			1	
102837564		RELAY AK	70					
N		EA	1	2			1	
100409390		RELAY AK	223					
N		EA	1	7			1	
101593549		RELAY AK	502					
N		EA	1	2			1	
101549467		RELAY AK	505					
N		EA	1	2			1	
100477264		RELAY AL	1					
5251181	1	EA		IL	IN	MI	OH	WI
				09	09	09	09	09
Flat type relay intended to mount on mounting plates provided with dust proof covers.								
101160000		RELAY AL	2					
N		EA	1	6			1	
100477272		RELAY AM	1					
N		EA	1	2			1	
100477280		RELAY AM	2					
1167445	1	EA		IL	IN	MI	OH	WI
				09	09	09	09	09
Relay used in #1 ESS. C.O.								
101135937		RELAY AM	3					
N		EA	1	2			1	
101135952		RELAY AM	4					
N		EA	1	2			1	
260392956		RELAY AUXILARY MERC	3500-112R					
N		EA	1	4			1	
100415231		RELAY B	9					
N		EA	1	7			1	
100415512		RELAY B	42					
N		EA	1	7			1	
100415538		RELAY B	45					
N		EA	1	7			1	
100415553		RELAY B	47					
N		EA	1	7			1	

RELAY

DISTRIBUTION SERVICES

NETWORK SERVICES

TOOLS

BUILDING JANITORIAL

AUTOMOTIVE

FORMS/OFFICE SUPPLIES

GENERAL

DATA VOICE

PRODUCT IDENTIFIER		DESCRIPTION				
ITEM NUMBER	ORD. MULT.	SELL UNIT	STD. PKG. STOCK	LEAD TIME AVAILABILITY / PA	MIN. ORD.	A C
100416056		RELAY B	122			
N		EA	1	7	1	
100416098		RELAY B	128			
N		EA	1	9	1	
100416296		RELAY B	165			
N		EA	1	7	1	
100416353		RELAY B	172			
N		EA	1	2	1	
100416502		RELAY B	203			
N		EA	1	7	1	
100416536		RELAY B	209			
N		EA	1	7	1	
100416825		RELAY B	263			
N		EA	1	9	1	
100417039		RELAY B	300			
N		EA	1	2	1	
100417211		RELAY B	336			
N		EA	1	2	1	
100417377		RELAY B	361			
N		EA	1	7	1	
100417427		RELAY B	368			
N		EA	1	7	1	
100417930		RELAY B	468			
N		EA	1	7	1	
100417955		RELAY B	476			
N		EA	1	7	1	
100417971		RELAY B	489			
N		EA	1	2	1	
103245437		RELAY B	524			
N		EA	1	6	1	
100418185		RELAY B	547			
N		EA	1	12	1	
100418565		RELAY B	608			
N		EA	1	2	1	
100418599		RELAY B	611			
N		EA	1	7	1	
100418847		RELAY B	1018			
N		EA	1	2	1	
100418979		RELAY B	1034			
N		EA	1	6	1	
100419118		RELAY B	1048			
N		EA	1	6	1	

PRODUCT IDENTIFIER		DESCRIPTION				
ITEM NUMBER	ORD. MULT.	SELL UNIT	STD. PKG. STOCK	LEAD TIME AVAILABILITY / PA	MIN. ORD.	A C
100419142		RELAY B	1053			
N		EA	1	2	1	
100419159		RELAY B	1055			
N		EA	1	7	1	
100419167		RELAY B	1056			
N		EA	1	2	1	
100419233		RELAY B	1063			
N		EA	1	7	1	
100419316		RELAY B	1072			
N		EA	1	2	1	
100419381		RELAY B	1080			
N		EA	1	2	1	
100419407		RELAY B	1082			
N		EA	1	7	1	
100419514		RELAY B	1095			
N		EA	1	6	1	
100419530		RELAY B	1098			
N		EA	1	7	1	
100419621		RELAY B	1110			
N		EA	1	7	1	
100419662		RELAY B	1114			
N		EA	1	6	1	
100419852		RELAY B	1135			
N		EA	1	7	1	
100420009		RELAY B	1154			
N		EA	1	7	1	
100420025		RELAY B	1156			
N		EA	1	2	1	
100420140		RELAY B	1169			
N		EA	1	7	1	
100420165		RELAY B	1171			
N		EA	1	7	1	
100420256		RELAY B	1180			
N		EA	1	12	1	
100420264		RELAY B	1181			
N		EA	1	7	1	
100420306		RELAY B	1185			
N		EA	1	7	1	
100477298		RELAY BF	1			
N		EA	1	6	1	
102211646		RELAY BF	51			
N		EA	1	6	1	

PRODUCT IDENTIFIER							DESCRIPTION						
ITEM NUMBER	ORD. MULT.	SELL UNIT	STD. PKG. STOCK AVAILABILITY / PA	LEAD TIME	MIN. ORD.	A C							
103245429 RELAY BF 521													
N		EA	1	6	1								
103276887 RELAY BF 527													
N		EA	1	13	1								
103276648 RELAY BF 560													
N		EA	1	6	1								
102584778 RELAY BJ 33													
N		EA	1	6	1								
103245528 RELAY BJ 523													
N		EA	1	6	1								
103245536 RELAY BJ 529													
N		EA	1	6	1								
997833652 RELAY CK05451 L 6													
N		EA	1	8	1								
997861224 RELAY CK07819													
N		EA	1	13	1								
997252317 RELAY CK16022 L 2													
N		EA	1	11	1								
997252820 RELAY CK16615 L 4													
N		EA	1	13	1								
997252861 RELAY CK16615 L 6													
N		EA	1	2	1								
997251541 RELAY CK16615 L 8													
N		EA	1	2	1								
997275383 RELAY CK16615 L14													
N		EA	1	14	1								
997972500 RELAY CK19752 L 1													
N		EA	1	14	6								
401315841 RELAY CK21137 L 1													
N		EA	1	12	1								
401315858 RELAY CK21137 L 2													
N		EA	1	12	1								
401323282 RELAY CK21138 L 1													
N		EA	1	4	1								
260386917 RELAY CK21278 L W													
N		EA	1	14	1								
100405398 RELAY CT 221													
N		EA	1	7	1								
100404821 RELAY D 221													
N		EA	1	7	1								
101236305 RELAY D179812													
N		EA	1	1	1								

PRODUCT IDENTIFIER							DESCRIPTION						
ITEM NUMBER	ORD. MULT.	SELL UNIT	STD. PKG. STOCK AVAILABILITY / PA	LEAD TIME	MIN. ORD.	A C							
101236313 RELAY D179813													
N		EA	1	2	1								
101236321 RELAY D179814													
N		EA	1	2	1								
101917532 RELAY D180296													
N		EA	1	2	1								
100413343 RELAY DK 280													
N		EA	1	7	1								
100420413 RELAY E 34													
N		EA	1	7	1								
100421163 RELAY E 199													
N		EA	1	7	1								
100422260 RELAY E 463													
N		EA	1	7	1								
100422757 RELAY E 569													
N		EA	1	7	1								
100423391 RELAY E 703													
N		EA	1	7	1								
100424878 RELAY E 1032													
N		EA	1	7	1								
100424902 RELAY E 1036													
N		EA	1	7	1								
100425131 RELAY E 1074													
N		EA	1	2	1								
100425313 RELAY E 1114													
N		EA	1	7	1								
100428051 RELAY E 1703													
N		EA	1	7	1								
100430305 RELAY E 6149													
N		EA	1	12	1								
100430925 RELAY E 6258													
N		EA	1	2	1								
100477371 RELAY EA 25													
N		EA	1	2	1								
100477389 RELAY EA 27													
N		EA	1	2	1								
100477397 RELAY EA 28													
N		EA	1	2	1								
100477405 RELAY EA 29													
N		EA	1	2	1								
100477462 RELAY EA 35													
N		EA	1	2	1								

DISTRIBUTION SERVICES
 NETWORK SERVICES
 TOOLS
 BUILDING JANITORIAL
 AUTOMOTIVE
 FORMS/OFFICE SUPPLIES
 GENERAL
 DATA VOICE

RELAY

DISTRIBUTION SERVICES

NETWORK SERVICES

TOOLS

BUILDING JANITORIAL

AUTOMOTIVE

FORMS/OFFICE SUPPLIES

GENERAL

DATA VOICE

PRODUCT IDENTIFIER		DESCRIPTION					
ITEM	ORD.	SELL	STD. PKG.	LEAD TIME	MIN.	A	
NUMBER	MULT.	UNIT	STOCK AVAILABILITY / PA		ORD.	C	
100477470		RELAY EA	36				
N		EA	1	2	1		
100477546		RELAY EA	44				
N		EA	1	2	1		
100477553		RELAY EA	45				
N		EA	1	12	1		
100477587		RELAY EA	48				
N		EA	1	2	1		
100851047		RELAY F	208				
N		EA	1	7	1		
100433028		RELAY G	90				
N		EA	1	12	1		
100433101		RELAY G	98				
N		EA	1	12	1		
100433192		RELAY G	108				
N		EA	1	2	1		
100413897		RELAY GE	280				
N		EA	1	7	1		
100433432		RELAY H	28				
N		EA	1	2	1		
100433887		RELAY H	107				
N		EA	1	7	1		
100433994		RELAY H	119				
N		EA	1	7	1		
100406099		RELAY HL	221				
N		EA	1	7	1		
280002452		RELAY HY-GUARD	10851				
N		EA	1	2	1		
100434075		RELAY J	1				
N		EA	1	7	1		
100434190		RELAY J	20				
N		EA	1	2	1		
100434307		RELAY J	41				
N		EA	1	7	1		
100434380		RELAY J	51				
N		EA	1	2	1		
100434406		RELAY J	53				
N		EA	1	7	1		
100434638		RELAY L	26				
N		EA	1	12	1		
100434646		RELAY L	500				
N		EA	1	7	1		

PRODUCT IDENTIFIER		DESCRIPTION					
ITEM	ORD.	SELL	STD. PKG.	LEAD TIME	MIN.	A	
NUMBER	MULT.	UNIT	STOCK AVAILABILITY / PA		ORD.	C	
100434679		RELAY L	503				
N		EA	1	2	1		
100410638		RELAY M	235				
N		EA	1	7	1		
100477629		RELAY MA	4				
N		EA	1	14	1		
101906964		RELAY MA	7E				
N		EA	1	14	1		
101906949		RELAY MA TYPE					
N		EA	1	14	1		
100478205		RELAY MB	5				
N		EA	1	7	1		
100478254		RELAY MB	10				
N		EA	1	8	1		
100403641		RELAY P	162				
N		EA	1	7	1		
100407030		RELAY PF	221				
N		EA	1	7	1		
100434943		RELAY R	27				
N		EA	1	7	1		
100434984		RELAY R	33				
N		EA	1	7	1		
100435353		RELAY R	81				
N		EA	1	7	1		
100435460		RELAY R	94				
N		EA	1	12	1		
100435544		RELAY R	106				
N		EA	1	7	1		
100435676		RELAY R	122				
N		EA	1	7	1		
100436484		RELAY R	225				
N		EA	1	7	1		
100436955		RELAY R	286				
N		EA	1	2	1		
100436963		RELAY R	287				
N		EA	1	12	1		
100436989		RELAY R	289				
N		EA	1	6	1		
100437383		RELAY R	342				
N		EA	1	7	1		
100437938		RELAY R	418				
N		EA	1	12	1		

DISTRIBUTION SERVICES

NETWORK SERVICES

TOOLS

BUILDING JANITORIAL

AUTOMOTIVE

FORMS/OFFICE SUPPLIES

GENERAL

DATA VOICE

PRODUCT IDENTIFIER DESCRIPTION						
ITEM NUMBER	ORD. MULT.	SELL UNIT	STD. PKG. STOCK AVAILABILITY / PA	LEAD TIME	MIN. ORD.	A C
100438258		RELAY R	453			
N		EA	10	2	1	
100439223		RELAY R	576			
N		EA	1	12	1	
100439900		RELAY R	656			
N		EA	1	2	1	
100440049		RELAY R	674			
N		EA	1	7	1	
100440239		RELAY R	708			
N		EA	1	7	1	
100441112		RELAY R	827			
N		EA	1	2	1	
100441807		RELAY R	910			
N		EA	1	7	1	
100442367		RELAY R	985			
N		EA	1	7	1	
100442888		RELAY R	1042			
N		EA	1	7	1	
100442987		RELAY R	1055			
N		EA	1	7	1	
100444033		RELAY R	1187			
N		EA	1	7	1	
100444447		RELAY R	1234			
N		EA	1	7	1	
100444520		RELAY R	1243			
N		EA	1	7	1	
100444546		RELAY R	1245			
N		EA	1	7	1	
100444678		RELAY R	1262			
N		EA	1	7	1	
100444934		RELAY R	1297			
N		EA	1	7	1	
100445279		RELAY R	1336			
N		EA	1	7	1	
100445451		RELAY R	1356			
N		EA	1	2	1	
100445642		RELAY R	1378			
N		EA	1	13	1	
100445758		RELAY R	1392			
N		EA	1	7	1	
100446020		RELAY R	1422			
N		EA	1	7	1	

PRODUCT IDENTIFIER DESCRIPTION						
ITEM NUMBER	ORD. MULT.	SELL UNIT	STD. PKG. STOCK AVAILABILITY / PA	LEAD TIME	MIN. ORD.	A C
100446160		RELAY R	1442			
N		EA	1	7	1	
100446442		RELAY R	1474			
N		EA	1	7	1	
100447044		RELAY R	1542			
N		EA	1	7	1	
100447051		RELAY R	1543			
N		EA	1	7	1	
100447259		RELAY R	1567			
N		EA	1	7	1	
100447309		RELAY R	1573			
N		EA	1	7	1	
100447754		RELAY R	1624			
N		EA	1	7	1	
100448620		RELAY R	1726			
N		EA	1	7	1	
100448810		RELAY R	1747			
N		EA	1	7	1	
100449057		RELAY R	1779			
N		EA	1	7	1	
100449164		RELAY R	1792			
N		EA	1	7	1	
100449180		RELAY R	1794			
N		EA	1	7	1	
100449982		RELAY R	1886			
N		EA	1	6	1	
100450519		RELAY R	1944			
N		EA	1	7	1	
100451251		RELAY R	2037			
N		EA	1	7	1	
100451459		RELAY R	2061			
N		EA	1	2	1	
100452127		RELAY S	9			
N		EA	1	6	1	
100452218		RELAY S	18			
N		EA	1	7	1	
100452259		RELAY S	27			
N		EA	1	7	1	
100452366		RELAY S	39			
N		EA	1	7	1	
100452424		RELAY S	48			
N		EA	1	7	1	

RELAY

DISTRIBUTION SERVICES

NETWORK SERVICES

TOOLS

BUILDING JANITORIAL

AUTOMOTIVE

FORMS/OFFICE SUPPLIES

GENERAL

DATA VOICE

PRODUCT IDENTIFIER		DESCRIPTION					
ITEM NUMBER	ORD. MULT.	SELL UNIT	STD. PKG. STOCK AVAILABILITY / PA	LEAD TIME	MIN. ORD.	A	C
100452440		RELAY S	51				
N		EA	1	2	1		
100452465		RELAY S	53				
N		EA	1	7	1		
100452556		RELAY S	64				
N		EA	1	6	1		
100452564		RELAY S	65				
N		EA	1	2	1		
100452614		RELAY S	70				
N		EA	1	7	1		
100452721		RELAY S	509				
N		EA	1	2	1		
100452820		RELAY S	520				
N		EA	1	2	1		
100452861		RELAY S	525				
N		EA	1	6	1		
100452895		RELAY S	528				
N		EA	1	7	1		
100452937		RELAY S	532				
N		EA	1	7	1		
100452945		RELAY S	533				
N		EA	1	12	1		
100452952		RELAY S	534				
N		EA	1	2	1		
997670815		RELAY THERMAL CK14082					
N		EA	1	2	1		
300045366		RELAY TSI-3AR					
N		EA	1	2	1		
260300132		RELAY TSI-3WA					
N		EA	1	2	1		
280099979		RELAY TSI-ANI/M					
N		EA	1	2	1		
280099987		RELAY TSI-LM					
N		EA	1	2	1		
300045341		RELAY TSI-WCR					
N		EA	1	2	1		
100453141		RELAY U	54				
N		EA	1	7	1		
100453158		RELAY U	55				
N		EA	1	12	1		
100453224		RELAY U	62				
N		EA	1	12	1		

PRODUCT IDENTIFIER		DESCRIPTION					
ITEM NUMBER	ORD. MULT.	SELL UNIT	STD. PKG. STOCK AVAILABILITY / PA	LEAD TIME	MIN. ORD.	A	C
100453240		RELAY U	64				
N		EA	1	2	1		
100453257		RELAY U	65				
N		EA	1	2	1		
100453273		RELAY U	67				
N		EA	1	2	1		
100453299		RELAY U	69				
N		EA	1	2	1		
100453323		RELAY U	72				
N		EA	1	7	1		
100453406		RELAY U	80				
N		EA	1	7	1		
100479419		RELAY U	83				
N		EA	1	7	1		
100453505		RELAY U	92				
N		EA	1	7	1		
100453687		RELAY U	112				
N		EA	1	2	1		
100453745		RELAY U	118				
N		EA	1	7	1		
100453778		RELAY U	121				
N		EA	1	12	1		
100453786		RELAY U	122				
N		EA	1	2	1		
100453802		RELAY U	125				
N		EA	1	7	1		
100453950		RELAY U	141				
N		EA	1	2	1		
100453984		RELAY U	144				
N		EA	1	2	1		
100454008		RELAY U	147				
N		EA	1	7	1		
100454016		RELAY U	148				
N		EA	1	2	1		
100454099		RELAY U	157				
N		EA	1	2	1		
100454156		RELAY U	165				
N		EA	1	6	1		
100454180		RELAY U	168				
N		EA	1	2	1		
100454198		RELAY U	169				
N		EA	1	7	1		

PRODUCT IDENTIFIER DESCRIPTION						
ITEM NUMBER	ORD. MULT.	SELL UNIT	STD. PKG. STOCK AVAILABILITY / PA	LEAD TIME	MIN. ORD.	A C
100454271	RELAY U	177				
N		EA	1	2	1	
100454354	RELAY U	185				
N		EA	1	2	1	
100454370	RELAY U	187				
N		EA	1	7	1	
100454396	RELAY U	189				
N		EA	1	2	1	
100454420	RELAY U	192				
N		EA	1	2	1	
100454438	RELAY U	193				
N		EA	1	7	1	
100454461	RELAY U	196				
N		EA	1	7	1	
100454503	RELAY U	200				
N		EA	1	12	1	
100454560	RELAY U	206				
N		EA	1	7	1	
100454578	RELAY U	207				
N		EA	1	2	1	
100454644	RELAY U	215				
N		EA	1	12	1	
100454669	RELAY U	217				
N		EA	1	2	1	
100454768	RELAY U	227				
N		EA	1	12	1	
100454842	RELAY U	235				
N		EA	1	2	1	
100454909	RELAY U	241				
N		EA	1	7	1	
100454917	RELAY U	242				
N		EA	1	12	1	
100454958	RELAY U	247				
N		EA	1	2	1	
100454990	RELAY U	254				
N		EA	1	2	1	
100455039	RELAY U	259				
N		EA	1	2	1	
100455054	RELAY U	261				
N		EA	1	2	1	
100455070	RELAY U	264				
N		EA	1	12	1	

PRODUCT IDENTIFIER DESCRIPTION						
ITEM NUMBER	ORD. MULT.	SELL UNIT	STD. PKG. STOCK AVAILABILITY / PA	LEAD TIME	MIN. ORD.	A C
100455104	RELAY U	267				
N		EA	1	2	1	
100455112	RELAY U	268				
N		EA	1	6	1	
100455138	RELAY U	270				
N		EA	1	2	1	
100455146	RELAY U	271				
N		EA	1	7	1	
100455195	RELAY U	276				
N		EA	1	7	1	
100455260	RELAY U	284				
N		EA	1	7	1	
100455286	RELAY U	286				
N		EA	1	2	1	
100455336	RELAY U	291				
N		EA	1	12	1	
100455443	RELAY U	302				
N		EA	1	7	1	
100455484	RELAY U	306				
N		EA	1	2	1	
100455617	RELAY U	320				
N		EA	1	7	1	
100455690	RELAY U	328				
N		EA	1	12	1	
100455724	RELAY U	332				
N		EA	1	7	1	
100455799	RELAY U	340				
N		EA	1	2	1	
100455807	RELAY U	341				
N		EA	1	7	1	
100455831	RELAY U	346				
N		EA	1	2	1	
100455856	RELAY U	349				
N		EA	1	7	1	
100456029	RELAY U	371				
N		EA	1	7	1	
100456094	RELAY U	380				
N		EA	1	7	1	
100456102	RELAY U	381				
N		EA	1	7	1	
100456193	RELAY U	390				
N		EA	1	7	1	

DISTRIBUTION SERVICES

NETWORK SERVICES

TOOLS

BUILDING JANITORIAL

AUTOMOTIVE

FORMS/OFFICE SUPPLIES

GENERAL

DATA VOICE

RELAY

DISTRIBUTION SERVICES

NETWORK SERVICES

TOOLS

BUILDING JANITORIAL

AUTOMOTIVE

FORMS/OFFICE SUPPLIES

GENERAL

DATA VOICE

PRODUCT IDENTIFIER		DESCRIPTION					
ITEM NUMBER	ORD. MULT.	SELL UNIT	STD. PKG. STOCK AVAILABILITY / PA	LEAD TIME	MIN. ORD.	A C	
100456201		RELAY U	391				
N		EA	1	7	1		
100456326		RELAY U	407				
N		EA	1	2	1		
100456425		RELAY U	420				
N		EA	1	7	1		
100456482		RELAY U	426				
N		EA	2	12	1		
100456516		RELAY U	431				
N		EA	1	7	1		
100456532		RELAY U	433				
N		EA	1	2	1		
100456557		RELAY U	435				
N		EA	1	12	1		
100456763		RELAY U	459				
N		EA	1	7	1		
100456797		RELAY U	462				
N		EA	1	2	1		
100456805		RELAY U	463				
N		EA	1	12	1		
100456904		RELAY U	474				
N		EA	1	7	1		
100456938		RELAY U	477				
N		EA	1	7	1		
100456987		RELAY U	482				
N		EA	1	7	1		
100457050		RELAY U	492				
N		EA	1	2	1		
100457100		RELAY U	497				
N		EA	1	2	1		
100457126		RELAY U	500				
N		EA	1	2	1		
100457159		RELAY U	504				
N		EA	1	12	1		
100457175		RELAY U	506				
N		EA	1	2	1		
100457225		RELAY U	513				
N		EA	1	7	1		
100457266		RELAY U	519				
N		EA	1	2	1		
100457274		RELAY U	520				
N		EA	1	2	1		

PRODUCT IDENTIFIER		DESCRIPTION					
ITEM NUMBER	ORD. MULT.	SELL UNIT	STD. PKG. STOCK AVAILABILITY / PA	LEAD TIME	MIN. ORD.	A C	
100457282		RELAY U	521				
N		EA	1	7	1		
100457381		RELAY U	535				
N		EA	1	7	1		
100457399		RELAY U	536				
N		EA	1	7	1		
100457407		RELAY U	540				
N		EA	1	2	1		
100457423		RELAY U	542				
N		EA	1	2	1		
100457431		RELAY U	543				
N		EA	1	2	1		
100457456		RELAY U	546				
N		EA	1	2	1		
100457498		RELAY U	551				
N		EA	1	12	1		
100457563		RELAY U	558				
N		EA	1	7	1		
100457613		RELAY U	563				
N		EA	1	12	1		
100457621		RELAY U	564				
N		EA	1	2	1		
100457647		RELAY U	567				
N		EA	1	2	1		
100457696		RELAY U	572				
N		EA	1	7	1		
100457738		RELAY U	576				
N		EA	1	2	1		
100457795		RELAY U	582				
N		EA	1	2	1		
100457878		RELAY U	591				
N		EA	1	2	1		
100457886		RELAY U	592				
N		EA	1	12	1		
100457902		RELAY U	594				
N		EA	1	2	1		
100457977		RELAY U	601				
N		EA	1	2	1		
100457993		RELAY U	603				
N		EA	1	7	1		
100458025		RELAY U	607				
N		EA	1	2	1		

DISTRIBUTION SERVICES

NETWORK SERVICES

TOOLS

BUILDING JANITORIAL

AUTOMOTIVE

FORMS/OFFICE SUPPLIES

GENERAL

DATA VOICE

PRODUCT IDENTIFIER							DESCRIPTION						
ITEM	ORD.	SELL	STD. PKG.	LEAD TIME	MIN.	A	ITEM	ORD.	SELL	STD. PKG.	LEAD TIME	MIN.	A
NUMBER	MULT.	UNIT	STOCK AVAILABILITY / PA		ORD.	C	NUMBER	MULT.	UNIT	STOCK AVAILABILITY / PA		ORD.	C
100458066		RELAY U	611				100458892		RELAY U	705			
N		EA	1	2	1		N		EA	1	7	1	
100458108		RELAY U	617				100458991		RELAY U	716			
N		EA	1	7	1		N		EA	1	7	1	
100458173		RELAY U	624				100459015		RELAY U	719			
N		EA	1	2	1		N		EA	1	7	1	
100458215		RELAY U	628				100459031		RELAY U	721			
N		EA	1	7	1		N		EA	1	2	1	
100458272		RELAY U	637				100459049		RELAY U	722			
N		EA	1	2	1		N		EA	1	2	1	
100458298		RELAY U	639				100459056		RELAY U	723			
N		EA	1	2	1		N		EA	1	2	1	
100458314		RELAY U	641				100459080		RELAY U	726			
N		EA	1	7	1		N		EA	1	2	1	
100458322		RELAY U	642				100459197		RELAY U	739			
N		EA	1	7	1		N		EA	1	12	1	
100458413		RELAY U	652				100459205		RELAY U	740			
N		EA	1	2	1		N		EA	1	7	1	
100458462		RELAY U	658				100459254		RELAY U	746			
N		EA	1	12	1		N		EA	1	7	1	
100458546		RELAY U	668				100459403		RELAY U	768			
N		EA	1	7	1		N		EA	1	7	1	
100458611		RELAY U	675				100459445		RELAY U	772			
N		EA	1	2	1		N		EA	1	7	1	
100458629		RELAY U	676				100459478		RELAY U	779			
N		EA	1	2	1		N		EA	1	7	1	
100458652		RELAY U	679				100459502		RELAY U	782			
N		EA	1	2	1		N		EA	1	2	1	
100458660		RELAY U	680				100459528		RELAY U	785			
N		EA	1	2	1		N		EA	1	7	1	
100458694		RELAY U	683				100459585		RELAY U	802			
N		EA	1	2	1		N		EA	1	2	1	
100458702		RELAY U	684				100459650		RELAY U	810			
N		EA	1	7	1		N		EA	1	12	1	
100458736		RELAY U	687				100459775		RELAY U	826			
N		EA	1	7	1		N		EA	1	2	1	
100458744		RELAY U	688				100459791		RELAY U	828			
N		EA	1	2	1		N		EA	1	7	1	
100458785		RELAY U	693				100459809		RELAY U	829			
N		EA	1	7	1		N		EA	1	12	1	
100458801		RELAY U	695				100459866		RELAY U	835			
N		EA	1	2	1		N		EA	1	2	1	

RELAY

DISTRIBUTION SERVICES

NETWORK SERVICES

TOOLS

BUILDING JANITORIAL

AUTOMOTIVE

FORMS/OFFICE SUPPLIES

GENERAL

DATA VOICE

PRODUCT IDENTIFIER		DESCRIPTION					
ITEM NUMBER	ORD. MULT.	SELL UNIT	STD. PKG. STOCK	PKG. AVAILABILITY / PA	LEAD TIME	MIN. ORD.	A C
100459882		RELAY U	837				
N		EA	1		2	1	
100459890		RELAY U	838				
N		EA	1		7	1	
100459924		RELAY U	843				
N		EA	1		2	1	
100459932		RELAY U	844				
N		EA	1		2	1	
100460005		RELAY U	874				
N		EA	1		12	1	
100460047		RELAY U	882				
N		EA	1		7	1	
100460062		RELAY U	885				
N		EA	1		17	1	
100460138		RELAY U	892				
N		EA	1		2	1	
100460161		RELAY U	895				
N		EA	1		7	1	
100459916		RELAY U	916				
N		EA	1		7	1	
100460294		RELAY U	921				
N		EA	1		7	1	
100460310		RELAY U	923				
N		EA	1		7	1	
100460427		RELAY U	934				
N		EA	1		2	1	
100460435		RELAY U	935				
N		EA	1		1	1	
100460443		RELAY U	936				
N		EA	1		2	1	
100460450		RELAY U	937				
N		EA	1		2	1	
100460484		RELAY U	940				
N		EA	1		2	1	
100460658		RELAY U	959				
N		EA	1		7	1	
100460740		RELAY U	968				
N		EA	1		7	1	
100460815		RELAY U	975				
N		EA	1		2	1	
100460831		RELAY U	977				
N		EA	1		7	1	

PRODUCT IDENTIFIER		DESCRIPTION					
ITEM NUMBER	ORD. MULT.	SELL UNIT	STD. PKG. STOCK	PKG. AVAILABILITY / PA	LEAD TIME	MIN. ORD.	A C
100460880		RELAY U	982				
N		EA	1		2	1	
100460906		RELAY U	984				
N		EA	1		2	1	
100460930		RELAY U	988				
N		EA	1		2	1	
100461003		RELAY U	995				
N		EA	1		7	1	
100461235		RELAY U	1018				
N		EA	1		2	1	
100461243		RELAY U	1019				
N		EA	1		7	1	
100461250		RELAY U	1020				
N		EA	1		2	1	
100461276		RELAY U	1022				
N		EA	2		2	1	
100461300		RELAY U	1025				
N		EA	1		12	1	
100461532		RELAY U	1051				
N		EA	1		12	1	
100461573		RELAY U	1056				
N		EA	1		7	1	
100461672		RELAY U	1067				
N		EA	1		7	1	
100461680		RELAY U	1068				
N		EA	1		1	1	
100461730		RELAY U	1073				
N		EA	1		2	1	
100461896		RELAY U	1095				
N		EA	1		7	1	
100461904		RELAY U	1096				
N		EA	1		7	1	
100461995		RELAY U	1106				
N		EA	1		7	1	
100479666		RELAY U	1111				
N		EA	1		7	1	
100462050		RELAY U	1112				
N		EA	1		2	1	
100462068		RELAY U	1113				
N		EA	1		2	1	
100462118		RELAY U	1118				
N		EA	1		7	1	

DISTRIBUTION SERVICES

NETWORK SERVICES

TOOLS

BUILDING JANITORIAL

AUTOMOTIVE

FORMS/OFFICE SUPPLIES

GENERAL

DATA VOICE

PRODUCT IDENTIFIER							DESCRIPTION						
ITEM NUMBER	ORD. MULT.	SELL UNIT	STD. PKG. STOCK AVAILABILITY / PA	LEAD TIME	MIN. ORD.	A C							
100462225		RELAY U	1129										
N		EA	1	2	1								
100462241		RELAY U	1132										
N		EA	1	12	1								
100462258		RELAY U	1133										
N		EA	1	2	1								
100462266		RELAY U	1135										
N		EA	1	7	1								
100462282		RELAY U	1137										
N		EA	1	7	1								
100462357		RELAY U	1144										
N		EA	1	2	1								
100462365		RELAY U	1145										
N		EA	1	7	1								
100462373		RELAY U	1146										
N		EA	1	7	1								
100462407		RELAY U	1149										
N		EA	1	2	1								
100462431		RELAY U	1152										
N		EA	1	7	1								
100462514		RELAY U	1160										
N		EA	1	2	1								
100462530		RELAY U	1164										
N		EA	1	2	1								
100462639		RELAY U	1175										
N		EA	1	2	1								
100462746		RELAY U	1186										
N		EA	1	7	1								
100462878		RELAY U	1202										
N		EA	1	7	1								
100462951		RELAY U	1212										
N		EA	1	2	1								
100462985		RELAY U	1217										
N		EA	1	12	1								
100463017		RELAY U	1222										
N		EA	1	2	1								
100463132		RELAY U	1234										
N		EA	1	7	1								
100463165		RELAY U	1237										
N		EA	1	2	1								
100463173		RELAY U	1238										
N		EA	1	2	1								

PRODUCT IDENTIFIER							DESCRIPTION						
ITEM NUMBER	ORD. MULT.	SELL UNIT	STD. PKG. STOCK AVAILABILITY / PA	LEAD TIME	MIN. ORD.	A C							
100463199		RELAY U	1240										
N		EA	1	7	1								
100463231		RELAY U	1244										
N		EA	1	2	1								
100463298		RELAY U	1250										
N		EA	1	2	1								
100463322		RELAY U	1253										
N		EA	1	7	1								
100463330		RELAY U	1254										
N		EA	1	2	1								
100463462		RELAY U	1268										
N		EA	1	7	1								
100463470		RELAY U	1269										
N		EA	1	7	1								
100463512		RELAY U	1273										
N		EA	1	7	1								
100463579		RELAY U	1283										
N		EA	1	2	1								
100463587		RELAY U	1284										
N		EA	1	2	1								
100463595		RELAY U	1286										
N		EA	1	7	1								
100463660		RELAY U	1295										
N		EA	1	6	1								
100463686		RELAY U	1298										
N		EA	1	2	1								
100463694		RELAY U	1299										
N		EA	1	2	1								
100463769		RELAY U	1306										
N		EA	1	2	1								
100463777		RELAY U	1307										
N		EA	1	2	1								
100463793		RELAY U	1309										
N		EA	1	7	1								
100463801		RELAY U	1310										
N		EA	1	11	1								
100463819		RELAY U	1311										
N		EA	1	12	1								
100463918		RELAY U	1321										
N		EA	1	2	1								
100463926		RELAY U	1322										
N		EA	1	2	1								

RELAY

DISTRIBUTION SERVICES

PRODUCT IDENTIFIER		DESCRIPTION				
ITEM NUMBER	ORD. MULT.	SELL UNIT	STD. PKG. STOCK AVAILABILITY / PA	LEAD TIME	MIN. ORD.	A C
100463934		RELAY U	1323			
N		EA	1	2	1	
100463942		RELAY U	1324			
N		EA	1	2	1	
100463959		RELAY U	1325			
N		EA	1	2	1	
100463967		RELAY U	1326			
N		EA	1	2	1	
100463983		RELAY U	1328			
N		EA	1	12	1	
100463991		RELAY U	1329			
N		EA	1	2	1	
100464015		RELAY U	1331			
N		EA	1	7	1	
100464049		RELAY U	1334			
N		EA	1	2	1	
100464163		RELAY U	1347			
N		EA	1	2	1	
100464171		RELAY U	1348			
N		EA	1	2	1	
100464205		RELAY U	1354			
N		EA	1	2	1	
100464221		RELAY U	1356			
N		EA	1	2	1	
100464254		RELAY U	1359			
N		EA	1	12	1	
100464262		RELAY U	1360			
N		EA	1	2	1	
100464270		RELAY U	1361			
N		EA	1	7	1	
100464288		RELAY U	1362			
N		EA	1	2	1	
100464304		RELAY U	1364			
N		EA	1	2	1	
100464312		RELAY U	1365			
N		EA	1	7	1	
100464320		RELAY U	1366			
N		EA	1	2	1	
100464338		RELAY U	1367			
N		EA	1	2	1	
100464379		RELAY U	1371			
N		EA	1	2	1	

NETWORK SERVICES

TOOLS

BUILDING JANITORIAL

AUTOMOTIVE

FORMS/OFFICE SUPPLIES

GENERAL

DATA VOICE

PRODUCT IDENTIFIER		DESCRIPTION				
ITEM NUMBER	ORD. MULT.	SELL UNIT	STD. PKG. STOCK AVAILABILITY / PA	LEAD TIME	MIN. ORD.	A C
100464387		RELAY U	1372			
N		EA	1	2	1	
100464411		RELAY U	1375			
N		EA	1	2	1	
100464429		RELAY U	1377			
N		EA	1	12	1	
100464437		RELAY U	1379			
N		EA	1	2	1	
100464478		RELAY U	1383			
N		EA	1	7	1	
100464486		RELAY U	1384			
N		EA	1	2	1	
100464502		RELAY U	1386			
N		EA	1	8	1	
100464510		RELAY U	1387			
N		EA	1	2	1	
100464528		RELAY U	1389			
N		EA	1	2	1	
100464536		RELAY U	1390			
N		EA	1	12	1	
100464577		RELAY U	1394			
N		EA	1	10	1	
100464601		RELAY U	1399			
N		EA	1	2	1	
100464643		RELAY U	1404			
N		EA	1	2	1	
100464650		RELAY U	1405			
N		EA	1	2	1	
100464676		RELAY U	1407			
N		EA	1	2	1	
100464726		RELAY U	1412			
N		EA	1	2	1	
100464742		RELAY U	1414			
N		EA	1	2	1	
100464858		RELAY U	1426			
N		EA	1	2	1	
100464866		RELAY U	1427			
N		EA	1	12	1	
100464957		RELAY U	1436			
N		EA	1	7	1	
100465038		RELAY U	1445			
N		EA	1	2	1	

PRODUCT IDENTIFIER DESCRIPTION						
ITEM	ORD.	SELL	STD. PKG.	LEAD TIME	MIN.	A
NUMBER	MULT.	UNIT	STOCK AVAILABILITY / PA		ORD.	C
100465053	RELAY U	1447				
N		EA	1	2	1	
100465178	RELAY U	1460				
N		EA	1	12	1	
100465210	RELAY U	6001				
N		EA	1	7	1	
100465376	RELAY U	6019				
N		EA	1	2	1	
100465392	RELAY U	6021				
N		EA	1	2	1	
100465400	RELAY U	6022				
N		EA	1	2	1	
100465467	RELAY U	6028				
N		EA	1	6	1	
100465483	RELAY U	6030				
N		EA	1	2	1	
100465491	RELAY U	6031				
N		EA	1	7	1	
100465509	RELAY U	6032				
N		EA	1	7	1	
100465517	RELAY U	6033				
N		EA	1	12	1	
100465541	RELAY U	6036				
N		EA	1	8	1	
100465574	RELAY U	6039				
N		EA	1	2	1	
100465608	RELAY U	6043				
N		EA	1	2	1	
100465616	RELAY U	6044				
N		EA	1	2	1	
100465863	RELAY U	6071				
N		EA	1	2	1	
100465871	RELAY U	6072				
N		EA	1	2	1	
100465897	RELAY U	6074				
N		EA	1	7	1	
100465913	RELAY U	6079				
N		EA	1	2	1	
100466036	RELAY U	6092				
N		EA	1	7	1	
100466176	RELAY U	6110				
N		EA	1	7	1	

PRODUCT IDENTIFIER DESCRIPTION						
ITEM	ORD.	SELL	STD. PKG.	LEAD TIME	MIN.	A
NUMBER	MULT.	UNIT	STOCK AVAILABILITY / PA		ORD.	C
100466242	RELAY U	6124				
N		EA	1	2	1	
100478700	RELAY UA	1				
N		EA	1	2	1	
100478726	RELAY UA	3				
N		EA	1	2	1	
100478890	RELAY UA	22				
N		EA	1	2	1	
100478924	RELAY UA	29				
N		EA	1	7	1	
100479013	RELAY UA	39				
N		EA	1	2	1	
100479039	RELAY UA	41				
N		EA	1	7	1	
100479047	RELAY UA	42				
N		EA	1	2	1	
100479161	RELAY UA	54				
N		EA	1	7	1	
100479195	RELAY UA	57				
N		EA	1	2	1	
100479286	RELAY UA	66				
N		EA	1	2	1	
100479302	RELAY UA	70				
N		EA	1	7	1	
100479328	RELAY UA	72				
N		EA	1	2	1	
100479336	RELAY UA	74				
N		EA	1	7	1	
100479351	RELAY UA	76				
N		EA	1	7	1	
100479369	RELAY UA	77				
N		EA	1	7	1	
100479377	RELAY UA	78				
N		EA	1	2	1	
100479393	RELAY UA	80				
N		EA	1	2	1	
100479427	RELAY UA	84				
N		EA	1	2	1	
100479435	RELAY UA	86				
N		EA	1	7	1	
100479450	RELAY UA	89				
N		EA	1	6	1	

DISTRIBUTION SERVICES

NETWORK SERVICES

TOOLS

BUILDING JANITORIAL

AUTOMOTIVE

FORMS/OFFICE SUPPLIES

GENERAL

DATA VOICE

RELAY

DISTRIBUTION SERVICES

NETWORK SERVICES

TOOLS

BUILDING JANITORIAL

AUTOMOTIVE

FORMS/OFFICE SUPPLIES

GENERAL

DATA VOICE

PRODUCT IDENTIFIER		DESCRIPTION					
ITEM NUMBER	ORD. MULT.	SELL UNIT	STD. PKG. STOCK AVAILABILITY / PA	LEAD TIME	MIN. ORD.	A C	
100479476		RELAY UA	91				
N		EA	1	2	1		
100479500		RELAY UA	94				
N		EA	1	2	1		
100479534		RELAY UA	97				
N		EA	1	1	1		
100479625		RELAY UA	107				
N		EA	1	2	1		
100479633		RELAY UA	108				
N		EA	1	7	1		
100479690		RELAY UA	115				
N		EA	1	2	1		
100479732		RELAY UA	119				
N		EA	1	7	1		
100479740		RELAY UA	120				
N		EA	1	7	1		
100479815		RELAY UA	129				
N		EA	1	7	1		
100479856		RELAY UA	133				
N		EA	1	7	1		
100479922		RELAY UA	141				
N		EA	1	7	1		
100480052		RELAY UB	3				
N		EA	1	7	1		
100480060		RELAY UB	5				
N		EA	1	2	1		
100480094		RELAY UB	8				
N		EA	1	7	1		
100480110		RELAY UB	12				
N		EA	1	2	1		
100480144		RELAY UB	15				
N		EA	1	2	1		
100480151		RELAY UB	16				
N		EA	1	7	1		
100480177		RELAY UB	18				
N		EA	1	2	1		
100480193		RELAY UB	20				
N		EA	1	2	1		
100480227		RELAY UB	23				
N		EA	1	2	1		
100480276		RELAY UB	28				
N		EA	1	12	1		

PRODUCT IDENTIFIER		DESCRIPTION					
ITEM NUMBER	ORD. MULT.	SELL UNIT	STD. PKG. STOCK AVAILABILITY / PA	LEAD TIME	MIN. ORD.	A C	
100480359		RELAY UB	36				
N		EA	1	2	1		
102419140		RELAY UB	39				
N		EA	1	7	1		
100466390		RELAY Y	59				
N		EA	1	2	1		
100466416		RELAY Y	61				
N		EA	1	7	1		
100466424		RELAY Y	62				
N		EA	1	1	1		
100466432		RELAY Y	63				
N		EA	1	2	1		
100466457		RELAY Y	67				
N		EA	1	2	1		
100466499		RELAY Y	72				
N		EA	1	10	1		
100466507		RELAY Y	73				
N		EA	1	2	1		
100466531		RELAY Y	78				
N		EA	1	2	1		
100466549		RELAY Y	79				
N		EA	1	2	1		
100466572		RELAY Y	82				
N		EA	1	2	1		
100466630		RELAY Y	88				
N		EA	1	12	1		
100466689		RELAY Y	95				
N		EA	1	2	1		
100466739		RELAY Y	103				
N		EA	1	2	1		
100466754		RELAY Y	105				
N		EA	1	7	1		
100466846		RELAY Y	117				
N		EA	1	2	1		
100466895		RELAY Y	123				
N		EA	1	2	1		
100466903		RELAY Y	125				
N		EA	1	7	1		
100467026		RELAY Y	148				
N		EA	1	2	1		
100467083		RELAY Y	155				
N		EA	1	2	1		

PRODUCT IDENTIFIER		DESCRIPTION				
ITEM NUMBER	ORD. MULT.	SELL UNIT	STD. PKG. STOCK AVAILABILITY / PA	LEAD TIME	MIN. ORD.	A C
100467158	N	EA	176	2	1	
100467208	N	EA	183	7	1	
100467273	N	EA	192	7	1	
100467331	N	EA	203	7	1	
100467372	N	EA	207	2	1	
100467414	N	EA	212	7	1	
100467505	N	EA	223	2	1	
100467638	N	EA	237	7	1	
100467661	N	EA	241	2	1	
100467679	N	EA	242	6	1	
100467687	N	EA	243	7	1	
100467778	N	EA	253	12	1	
100467786	N	EA	254	12	1	
100467836	N	EA	259	2	1	
100467844	N	EA	260	2	1	
100467877	N	EA	263	2	1	
100467919	N	EA	267	2	1	
100467943	N	EA	270	7	1	
100467950	N	EA	271	2	1	
100467968	N	EA	272	2	1	
100468065	N	EA	283	7	1	

PRODUCT IDENTIFIER		DESCRIPTION				
ITEM NUMBER	ORD. MULT.	SELL UNIT	STD. PKG. STOCK AVAILABILITY / PA	LEAD TIME	MIN. ORD.	A C
100468107	N	EA	288	2	1	
100468115	N	EA	291	12	1	
100468123	N	EA	292	7	1	
100468214	N	EA	301	2	1	
100468230	N	EA	303	2	1	
100468446	N	EA	328	2	1	
100468487	N	EA	332	7	1	
REMOTE ACCESS						
SEE UNIT.						
REPEATER						
260964143			REPEATER 4024C			
1237958	1	EA				
260964093			REPEATER 5631 44V4 DX/E&M			
1237909	1	EA	IL IN MI OH WI			
260964101			REPEATER 6168			
1237917	1	EA	IL IN MI OH WI			
260964168			REPEATER 7001A			
1237990	1	EA	IL IN MI OH WI			
260964085			REPEATER 7306-51			
1237891	1	EA	IL IN MI OH WI			
260964200			REPEATER 7535-00			
N		EA		24	1	
260963822			REPEATER N7306-54			
N		EA		2	1	
RESISTOR						
260386990			RESISTOR 18BC 470 OHM			
N		EA		13	1	
100487214			RESISTOR 18BM			
N		EA		13	1	
100487834			RESISTOR 18FC			
N		EA		1	1	

DISTRIBUTION SERVICES

NETWORK SERVICES

TOOLS

BUILDING JANITORIAL

AUTOMOTIVE

FORMS/OFFICE SUPPLIES

GENERAL

DATA VOICE

RESISTOR

PRODUCT IDENTIFIER		DESCRIPTION					
ITEM NUMBER	ORD. MULT.	SELL UNIT	STD. PKG. STOCK AVAILABILITY / PA	LEAD TIME	MIN. ORD.	A C	
100488741		RESISTOR	18KR	887 OHM			
N		EA	1	1	1		
100489863		RESISTOR	19EH				
N		EA	1	13	1		
100497411		RESISTOR	89A				
1234682	1	EA	IL IN MI OH WI 04 04 04 04 04				
Consists of a resistor unit potted in a base connected to metal prongs, 0.0DB.							
100497650		RESISTOR	89AD				
N		EA	1	14	1		
100497692		RESISTOR	89AH				
N		EA	1	14	1		
100497817		RESISTOR	89AY				
N		EA	1	14	1		
100498310		RESISTOR	89DK				
N		EA	1	14	1		
100498831		RESISTOR	89GB				
N		EA	1	14	1		
100497502		RESISTOR	89J				
N		EA	1	19	1		
100497544		RESISTOR	89N				
N		EA	1	19	1		
280017245		RESISTOR	47061	600 OHM			
N		EA	1	2	1		
997647862		RESISTOR	CK 8512 L4A	1000 OHM			
N		EA	1	1	1		
997493069		RESISTOR	CK19150 L2				
N		EA	1	1	1		
401496450		RESISTOR	CK19548	.5 OHM			
N		EA	1	1	1		
260381124		RESISTOR	CK20810 L1A	100 OHM			
N		EA	1	13	1		
400747804		RESISTOR	CK20810 L1A	135 OHM			
2687046	1	EA	IL IN MI OH WI 04 04 04 04 04				
400710778		RESISTOR	CK20810 L1A	600 OHM			
2624882	1	EA	IL IN MI OH WI 04 04 04 04 04				
405575077		RESISTOR SET		500 OHM			
N		EA	1	1	1		

RESTRAINER						
996582748		RESTRAINER	CK20009 L1			
N		EA	1	4	1	

PRODUCT IDENTIFIER		DESCRIPTION					
ITEM NUMBER	ORD. MULT.	SELL UNIT	STD. PKG. STOCK AVAILABILITY / PA	LEAD TIME	MIN. ORD.	A C	
RETAINER							
300032240		RETAINER JUMPER WIRE	4 1/2FT				
N		BX	1	2	1		
300064565		RETAINER JUMPER WIRE	6FT				
N		BX	1	2	1		
845980507		RETAINER LOWER	M/D				
N		EA	1	1	1		
MANUFACTURER DISCONTINUED - NO REPLACEMENT.							
842703043		RETAINER STRAP	842703043				
N		EA	1	7	1		
260358205		RETAINER WIRE UPPER					
N		EA	1	2	5		
DIRECT REPLACEMENT FOR PID 840981831							
845980499		RETAINER WIRE UPPER	M/D				
N		EA	1	1	1		
Replaced by PID 260358205.							
RHEOSTAT							
997667134		RHEOSTAT	CK13920 L 1				
N		EA	1	11	1		
997315312		RHEOSTAT	CK13920 L10				
N		EA	1	11	1		
RINGBACK							
260421136		RINGBACK AUDIBLE	3500 115T				
N		EA	1	6	1		
RINGING SUPPLY							
SEE SUPPLY RINGING.							
RINGS							
997020409		RINGS	997020409				
N		EA	1	13	1		
997021654		RINGS	997021654				
N		EA	1	13	1		
ROLLER							
401871868		ROLLER	L-502624				
N		EA	1	13	1		

DISTRIBUTION SERVICES

NETWORK SERVICES

TOOLS

BUILDING JANITORIAL

AUTOMOTIVE

FORMS/OFFICE SUPPLIES

GENERAL

DATA VOICE

DISTRIBUTION SERVICES

NETWORK SERVICES

TOOLS

BUILDING JANITORIAL

AUTOMOTIVE

FORMS/OFFICE SUPPLIES

GENERAL

DATA VOICE

PRODUCT IDENTIFIER DESCRIPTION

ITEM	ORD.	SELL	STD. PKG.	LEAD TIME	MIN.	A
NUMBER	MULT.	UNIT	STOCK AVAILABILITY / PA		ORD.	C

SCANNER

260436597 SCANNER POINT 512

1980839 1 EA

SCREW

842705899 SCREW ASSEMBLY 842705899

5513002 1 EA

260395017 SCREW CABLE CONNECTOR 000-0305-440

N EA 1 4 1

840440572 SCREW CAPTIVE 840440572

N EA 1 1 1

SEAL

996214565 SEAL KAP 996214565

N EA 1 1 1

SELECTOR

100669423 SELECTOR 218B

N EA 1 14 1

300029188 SELECTOR LINE COMMUNICATION CSU24B

1153718 1 EA IL IN MI OH WI
04 04

Switching unit used to connect one of two terminals to one modem or one modem to one of two terminal parts.

SENSOR FERROD

100669498 SENSOR FERROD 1B

1105478 1 EA
A current sensing device used for supervising purposes in No. 1 ESS.

100669506 SENSOR FERROD 1C

N EA 1 1 1

100669514 SENSOR FERROD 1D

N EA 1 1 1

100669522 SENSOR FERROD 1E

N EA 1 1 1

SEPARATOR

840280127 SEPARATOR 840280127

N EA 1 2 1

840280135 SEPARATOR 840280135

N EA 1 2 1

PRODUCT IDENTIFIER DESCRIPTION

ITEM	ORD.	SELL	STD. PKG.	LEAD TIME	MIN.	A
NUMBER	MULT.	UNIT	STOCK AVAILABILITY / PA		ORD.	C

841859572 SEPARATOR 841859572

N EA 1 9 1

101012474 SEPARATOR D178261 360/SP

N SP 360 1 1

SET DATA

260000187 SET DATA 2024 A L1

N

260330626 SET DATA AUX DAS 290 L 5, 7, 12

1947036 1 EA IL IN MI OH WI
37 37 37 37

300062890 SET DATA AUX DST8292

1149112 1 EA IL IN MI OH WI
04

260395520 SET DATA AUX DSTM6U0 SOS5486A

1966853 1 EA IL IN MI OH WI
04 04

260404066 SET DATA AUX SDS9486ALAD

1969147 1 EA IL IN MI OH WI
04

SET JUMPER

260418553 SET JUMPER 4212-045

N EA 1 1

260420179 SET JUMPER 4212-045 LB-E-01462

1974568 1 EA IL IN MI OH WI
09

SET PLUG

280017419 SET PLUG 33705

N EA 1 2 2

SET SUBSCRIBER

101366110 SET SUBSCRIBER 2690 C3

N EA 1 2 1

103258356 SET SUBSCRIBER SLC1C1

1169672 1 EA IL IN MI OH WI
18 18 18 18

The subscriber loop carrier-1C is a single channel subscriber carrier system used to derive an additional single party line on an existing working cable pair, BSP 502-240-100.

SET TEST

300070455 SET TEST AML-II 77-134-10

N EA 1 4 1

SHAFT MAIN

DISTRIBUTION SERVICES

PRODUCT IDENTIFIER		DESCRIPTION					
ITEM NUMBER	ORD. MULT.	SELL UNIT	STD. PKG. STOCK AVAILABILITY / PA	LEAD TIME	MIN. ORD.	A	C

SHAFT MAIN

840375596		SHAFT MAIN 840375596					
N		EA	1	14		1	

SHELF

260384763		SHELF 8 POSITION 751109-1					
1969105	1	EA					Isolator Fiberline (REPLACES 751101/1).

260367271		SHELF 8 POSITION 7511-09/13 CUSTOM					
1969097	1	EA	IL IN MI OH WI	04			Isolator Fiberline.

300071263		SHELF 10 POSITION 19IN					
N		EA	1	6		1	

260441993		SHELF 14 SLOT REPEATER 76224					
N		EA	1	4		1	

260448923		SHELF 23IN MODEM 300297-502					
N							1 per system, Inmate Services Equipment.

280062472		SHELF 303MA02 368406					
N		EA	1	8		1	

260387352		SHELF 400CCS-3					
N		EA	1	1		1	

260435144		SHELF 460 14 POSITION 23IN					
1980169	1	EA	IL IN MI OH WI				A27-03643-00.

840044283		SHELF 840044283					
N		EA	1	2		1	

260382254		SHELF ALARM 0514A					
1961482	1	EA	IL IN MI OH WI	09			

260407630		SHELF ASSEMBLY DCD-ST2					
1969899	1	EA	IL IN MI OH WI	09			

260374111		SHELF BATTERY 4282-130-00					
1956409	1	EA	IL IN MI OH WI	09 09 09			

260321658		SHELF CO REAR E9571A					
N		EA	1	8		1	

260374137		SHELF DL CH BK FC9601SFC2					
1956425	1	EA	IL IN MI OH WI	09 09 09 09			

260441050		SHELF DS1 010B015-001					
N		EA	1	2		1	

NETWORK SERVICES

TOOLS

BUILDING JANITORIAL

AUTOMOTIVE

FORMS/OFFICE SUPPLIES

GENERAL

DATA VOICE

PRODUCT IDENTIFIER		DESCRIPTION					
ITEM NUMBER	ORD. MULT.	SELL UNIT	STD. PKG. STOCK AVAILABILITY / PA	LEAD TIME	MIN. ORD.	A	C

260341557		SHELF DS3 DSX-4M-W4C					
1949875	1	EA	IL IN MI OH WI	04			Rear CXC 6.

260374194		SHELF DS3 DSX-4M-W8C					
1956433	1	EA	IL IN MI OH WI	04			

260420195		SHELF DSX-4M-W12C					
1974584	1	EA	IL IN MI OH WI	05			

300071313		SHELF DUAL HORIZONTAL RACK					
1953810	1	EA	IL IN MI OH WI	75			E/W 23IN Mounting Bracket.

260442033		SHELF EQUALIZEER CIRCUIT ED3C585-30 G4					
N							

260368766		SHELF FAN 150 NT7H38AA					
1956060	1	EA	IL IN MI OH WI	05			

260374103		SHELF FAN 4282-120-00					
1956391	1	EA	IL IN MI OH WI	09 09 09 09			

260418967		SHELF FIBERLINE 7501-27					
1973875	1	EA	IL IN MI OH WI	08			2/3 position, 2 cards with a power supply card, color coded CO and station stubs.

260344924		SHELF FMT150B FRONT NT7H31FB					
1950816	1	EA	IL IN MI OH WI	09 09 09 09			

260405618		SHELF FMT150B FRONT NT7H31FF					
1970103	1	EA	IL IN MI OH WI	09 09 09 09			

260344957		SHELF FMT150B REAR NT7H31BD					
1950725	1	EA	IL IN MI OH WI	09 09 09 09			

260405584		SHELF FMT150B REAR NT7H31BL					
1970137	1	EA	IL IN MI OH WI	09 09 09 09			

260344932		SHELF FMT150C FRONT NT7H31GB					
1950824	1	EA	IL IN MI OH WI	09 09 09 09			

260405626		SHELF FMT150C FRONT NT7H31GF					
1970111	1	EA	IL IN MI OH WI	09 09 09 09			

260344965		SHELF FMT150C REAR NT7H31CC					
1950840	1	EA	IL IN MI OH WI	09 09 09 09			

260405592		SHELF FMT150C REAR NT7H31CL					
1970145	1	EA	IL IN MI OH WI	09 09 09 09			

PRODUCT IDENTIFIER		DESCRIPTION					
ITEM NUMBER	ORD. MULT.	SELL UNIT	STD. PKG. STOCK AVAILABILITY / PA	LEAD TIME	MIN. ORD.	A C	
260344940 SHELF FMT150D FRONT 262214							
1950832	1	EA	IL IN MI OH WI 09 09 09				
260405634 SHELF FMT150D FRONT NT7H31HF							
1970129	1	EA	IL IN MI OH WI				
260344973 SHELF FMT150D REAR NT7H31DC							
1950857	1	EA	IL IN MI OH WI 09 09 09 09				
260405600 SHELF FMT150D REAR NT7H31DL							
1970152	1	EA	IL IN MI OH WI				
260445010 SHELF MAINTENANCE							
N						Used in LTS-21130D Terminal.	
260387378 SHELF MODEL 400CCS-2							
N		EA	1	1	1		
260446679 SHELF MODEM 23IN 300297-502 1 PER SYSTEM							
N						For Central Office Switching System.	
260440532 SHELF MPS E/W FAULT LOCATE/OV 4275-40600							
N		EA	1	12	1		
260442181 SHELF MUTUAL DRAINAGE REACTOR 751201							
N		EA	1	2	1	Positron.	
260380894 SHELF PIX-5-23/12							
N		EA	1	6	1	Electronic equipment components to be assembled within a Fujitsu 6200 cabinet.	
601292808 SHELF POWER J1C182BA-1L1							
N		EA	1	2	1		
260376207 SHELF QRSS M1544-300							
1961466	1	EA	IL IN MI OH WI 09 09				
260445127 SHELF REGENERATOR 1:1							
N						Used in LTS-21130D Terminal.	
260445044 SHELF REGENERATOR ROUTE DIVERSITY							
N						Used in LTS-21130D Terminal.	
260321666 SHELF RIGHT FRONT E9571B							
N		EA	1	8	1		
260405246 SHELF SEISMEC US232019							
1969469	1	EA	IL IN MI OH WI 09			Universal.	

PRODUCT IDENTIFIER		DESCRIPTION					
ITEM NUMBER	ORD. MULT.	SELL UNIT	STD. PKG. STOCK AVAILABILITY / PA	LEAD TIME	MIN. ORD.	A C	
260368709 SHELF SPAN TERMINAL 3192-11 ISSUE 2							
1955484	1	EA	IL IN MI OH WI 09 09 09 09				
260323712 SHELF SPAN TERMINAL J7400AA-1L1							
1944165	1	EA	IL IN MI OH WI 75			Book 103 Practices P0642723.	
260404868 SHELF SYSTEM MODULE POWER 5757-007-00							
1969261	1	EA	IL IN MI OH WI 09 09 09 09				
260445036 SHELF TERMINAL							
N						Used in LTS-21130D Terminal.	
260364336 SHELF T-TERM 220 WIREWRAP							
1954438	1	EA	IL IN MI OH WI				
260422480 SHELF WRITING BLUE 4060-3							
1975607	1	EA	IL IN MI OH WI 03				

SHELF MOUNTING

103114898 SHELF MOUNTING 128A						
1196741	1	EA				Used for SLC 96, 267095.
260964226 SHELF MOUNTING 411A CSU						
1238071	1	EA	IL IN MI OH WI			
260962915 SHELF MOUNTING 4912ILB						
1236257	1	EA	IL IN MI OH WI			
260431481 SHELF MOUNTING 14 POSITION 31MA14 LB						
1978973	1	EA	IL IN MI OH WI 09 09 09 09			
260442074 SHELF MOUNTING 23IN 400-12						
N		EA	1	18	1	Rack mount shelf used to house 12 modules.
260336540 SHELF MOUNTING 31MA -01 11 POSITION						
1947721	1	EA	IL IN MI OH WI 04 04 04 04			For use with the Smart Jack Remote Testing Unit.
260963848 SHELF MOUNTING 31MA -10 8 POSITION						
1237810	1	EA	IL IN MI OH WI			
260391446 SHELF MOUNTING 31MA -11P 12 POSITION						
1965517	1	EA	IL IN MI OH WI 18 18			Used to support the installation of the Westel 3110-70 circuit pack for HICAPS.
260405204 SHELF MOUNTING 31MA -14 14 POSITION						
1969428	1	EA	IL IN MI OH WI 09			

DISTRIBUTION SERVICES

NETWORK SERVICES

TOOLS

BUILDING JANITORIAL

AUTOMOTIVE

FORMS/OFFICE SUPPLIES

GENERAL

DATA VOICE

SHELF MOUNTING

DISTRIBUTION SERVICES

PRODUCT IDENTIFIER DESCRIPTION

ITEM NUMBER	ORD. MULT.	SELL UNIT	STD. PKG. STOCK AVAILABILITY / PA	LEAD TIME	MIN. ORD.	A C
-------------	------------	-----------	-----------------------------------	-----------	-----------	-----

260348966 SHELF MOUNTING 31MA -48 8 POSITION
1951798 1 EA IL IN MI OH WI
18 18

260391461 SHELF MOUNTING 31MA -90 SINGLE POS.
1965533 1 EA IL IN MI OH WI
18

260391453 SHELF MOUNTING 31MA -90P SINGLE POS.
1965525 1 EA IL IN MI OH WI
18

260358692 SHELF MOUNTING 31MA4- 8P
1953281 1 EA IL IN MI OH WI
09 09

260425459 SHELF MOUNTING 5 POSITION 31MA05 L-B
1977025 1 EA IL IN MI OH WI
09 09
5 slot mounting for Westell 400 type T1 Facility Loopback Units.

260442082 SHELF MOUNTING FM 19IN 400-11
N EA 1 2 1
Rack mount shelf used to house 12 modules.

260982749 SHELF MOUNTING SINGLE POSITION 28MA-30
N EA 1 4 1

260425467 SHELF MOUNTING SINGLE POSITION 31MA21
1977009 1 EA IL IN MI OH WI
04
Single slot mounting for Westell 400 type T1 Facility Loopback Units.

SHIELD

260392261 SHIELD 81A
1965814 1 EA
Plastic cable shield to fit LGX frame. Mount to holes of framework. Protects and holds cable in place. 2 shields per package.

SIDE SKIRT

843049933 SIDE SKIRT 843049933
N EA 1 9 1

SIGN

260345228 SIGN AC POWER BOARD
N EA 1 6 200

260354444 SIGN CAUTION AUTO START
N EA 1 4 1

260345236 SIGN DC POWER BOARD
N EA 1 6 200

260345210 SIGN POWER AREA 9 1/2IN OCTAGON
N EA 1 6 250

NETWORK SERVICES

TOOLS

BUILDING JANITORIAL

AUTOMOTIVE

FORMS/OFFICE SUPPLIES

GENERAL

DATA VOICE

PRODUCT IDENTIFIER DESCRIPTION

ITEM NUMBER	ORD. MULT.	SELL UNIT	STD. PKG. STOCK AVAILABILITY / PA	LEAD TIME	MIN. ORD.	A C
-------------	------------	-----------	-----------------------------------	-----------	-----------	-----

260345244 SIGN POWER AREA BASEMENT
N EA 1 6 250

260345285 SIGN POWER BOARD DISCL
N EA 1 6 100

260345293 SIGN POWER BOARD DISCL FLOOR
N EA 1 6 100

260345301 SIGN POWER CONSEQ 9IN X 10IN
N EA 1 6 100

260345319 SIGN POWER FLOOR IL 17IN X 2 1/2IN
N EA 1 6 100

260354469 SIGN POWER FLOOR IN 17IN X 2 1/2IN
N EA 1 6 100

260354485 SIGN POWER FLOOR OH 17IN X 2 1/2IN
N EA 1 6 100

260354493 SIGN POWER FLOOR WI 17IN X 2 1/2IN
N EA 1 6 100

260354477 SIGN POWER FLOOR WI 17IN X 2 1/2IN
N EA 1 6 100

260345350 SIGN POWER SWITCH 302B
N EA 1 6 100

260345335 SIGN POWER SWITCH 326A
N EA 1 6 100

260345368 SIGN POWER SWITCH 702C
N EA 1 6 100

260345327 SIGN POWER SWITCH 1231H
N EA 1 6 100

260345343 SIGN POWER SWITCH 2000
N EA 1 6 100

SLEEVE

260380639 SLEEVE INSULATED OUTER SHIELD
N EA 1 3 1
KON GSR-225.

842367005 SLEEVE TERMINAL FOR 305 CONNECTOR
N EA 1 9 1

SLEEVE FUNNEL

260380480 SLEEVE FUNNEL RECEPTACLE DNF-18-110
N EA 100 2 100
Panduit.

260380472 SLEEVE FUNNEL RECEPTACLE DNF-18-111
N EA 100 2 100
Panduit.

DISTRIBUTION SERVICES

NETWORK SERVICES

TOOLS

BUILDING JANITORIAL

AUTOMOTIVE

FORMS/OFFICE SUPPLIES

GENERAL

DATA VOICE

PRODUCT IDENTIFIER		DESCRIPTION				
ITEM NUMBER	ORD. MULT.	SELL UNIT	STD. PKG. STOCK AVAILABILITY / PA	LEAD TIME	MIN. ORD.	A C
260380464 SLEEVE FUNNEL RECEPTACLE DNF-18-187						
N		EA	100	2	100	
Panduit.						
260380456 SLEEVE FUNNEL RECEPTACLE DNF-18-250						
N		EA	100	2	100	
Panduit.						

SOCKET

101939148 SOCKET LAMP 67C						
N		EA	1	1	1	

SOFTWARE

260369251 SOFTWARE CALLPRO M-166-42						
N		EA	1	4	1	
Used when ordering Software for all program applications of the M-166-05,07, 25, 27 Callpro units.						
260369269 SOFTWARE INITIAL PROGRAM M-166-40						
N		EA	1	4	1	
Used to initiate a custom program for specific applications.						

SPEAKER

401815790 SPEAKER CONE C-10-T70						
1189159	1	EA				
300036464 SPEAKER LOUD AMPLIFIER V1022C						
1175232	1	EA	IL IN MI OH WI	04 04		

SPRAY

403929342 SPRAY CA09062 7OZ CAN						
N		EA	1	5	1	

SPRING

996973178 SPRING 996973178						
N		EA	1	13	1	
841632763 SPRING EXTENSION 841632763						
N		EA	1	6	1	
405444183 SPRING EXTENSION LE-055E-12HMW						
N		EA	1	1	1	
811175355 SPRING FOR MEMORY CARD WRITER						
N		EA	1	24	1	
APR COST100						
844532960 SPRING HOLDER 844532960						
N		EA	1	14	1	

PRODUCT IDENTIFIER		DESCRIPTION				
ITEM NUMBER	ORD. MULT.	SELL UNIT	STD. PKG. STOCK AVAILABILITY / PA	LEAD TIME	MIN. ORD.	A C

STAND

260435771 STAND BATTERY 6SSS 20-20						
1980276	1	EA				
Stackable Sliding Shelves 9 x 6IN used CEV or Hut. 20 X 20IN is pan size.						
260443320 STAND BATTERY 6-SSS20-20TS						
N		EA	1	3	1	

STATION DATA

260963962 STATION DATA 4412C TERM						
N		EA	1	4	1	
260963954 STATION DATA 5436C-M1						
1237743	1	EA	IL IN MI OH WI			
260962410 STATION DATA 97072-00						
1235473	1	EA	IL IN MI OH WI	99		
260963947 STATION DATA 97072-00						
1237735	1	EA	IL IN MI OH WI			

STATION TERMINATION

260964010 STATION TERMINATION DATA 4416B						
N		EA	1	2	1	
260964028 STATION TERMINATION DATA 4417B						
N		EA	1	2	1	

STRAP

401613443 STRAP 30GA CK21336 L 1						
N		FT	1	1	1	
996855664 STRAP 4160 CONDUIT T&B						
N		EA	1	4	1	
842757254 STRAP TIE DOWN						
N		EA	1	1	1	
842394439 STRAP WIRE 3IN						
N		TU	1	2	1	
842394454 STRAP WIRE 4IN						
N		TU	1	2	1	
842394470 STRAP WIRE 5IN						
N		TU	1	2	1	

DISTRIBUTION SERVICES

NETWORK SERVICES

TOOLS

BUILDING JANITORIAL

AUTOMOTIVE

FORMS/OFFICE SUPPLIES

GENERAL

DATA VOICE

STRIP ADHESIVE

PRODUCT IDENTIFIER		DESCRIPTION				
ITEM NUMBER	ORD. MULT.	SELL UNIT	STD. PKG. STOCK AVAILABILITY / PA	LEAD TIME	MIN. ORD.	A C

--	--	--	--	--	--	--

STRIP ADHESIVE

900244617 STRIP ADHESIVE 57P

1308809	1	PK				
Package of 10.						

STRIP DESIGNATION

260383484 STRIP DESIGNATION 845627454

N		EA	1	14		1
---	--	----	---	----	--	---

102744315 STRIP DESIGNATION 91K

N		EA	1	2		1
---	--	----	---	---	--	---

260387337 STRIP DESIGNATION P0637673

N		EA	1	2		1
---	--	----	---	---	--	---

260387329 STRIP DESIGNATION P0660224

N		EA	1	2		1
---	--	----	---	---	--	---

STRIP FANNING

840982441 STRIP FANNING 840982441

N		EA	1	15		1
---	--	----	---	----	--	---

841087901 STRIP FANNING 841087901

N		EA	1	9		1
---	--	----	---	---	--	---

841087919 STRIP FANNING 841087919

N		EA	1	9		1
---	--	----	---	---	--	---

841088081 STRIP FANNING 841088081

N		EA	1	9		1
---	--	----	---	---	--	---

841639917 STRIP FANNING 841639917

N		EA	1	9		1
---	--	----	---	---	--	---

841639933 STRIP FANNING 841639933

N		EA	1	9		1
---	--	----	---	---	--	---

841639974 STRIP FANNING 841639974

N		EA	1	9		1
---	--	----	---	---	--	---

842358830 STRIP FANNING 842358830

N		EA	1	2		1
---	--	----	---	---	--	---

842391062 STRIP FANNING 842391062

N		EA	1	9		1
---	--	----	---	---	--	---

STRIP TERMINAL

260406525 STRIP TERMINAL 211AL

1970087	1	EA				
---------	---	----	--	--	--	--

260323761 STRIP TERMINAL 581-0264-041

1944017	1	EA	IL 09	IN	MI	OH 09	WI
---------	---	----	----------	----	----	----------	----

PRODUCT IDENTIFIER		DESCRIPTION				
ITEM NUMBER	ORD. MULT.	SELL UNIT	STD. PKG. STOCK AVAILABILITY / PA	LEAD TIME	MIN. ORD.	A C

--	--	--	--	--	--	--

260405451 STRIP TERMINAL BARRIER 6-542

1969782	1	EA	IL 09	IN	MI	OH	WI
Cinch, 28F1043.							

260405162 STRIP TERMINAL BARRIER 8-141

1969386	1	EA	IL 09	IN	MI	OH	WI
---------	---	----	----------	----	----	----	----

SUPPLY POWER

260336524 SUPPLY POWER 48 VOLT DC 1 1/4AM

1947697	1	EA					
A power supply used to power the loop back unit smart jack when using the local powering option for multiple unit applications.							

260032503 SUPPLY POWER 48 VOLT DC 2A 6060-04

1231498	1	EA	IL	IN	MI	OH	WI
RG48109.							

260964390 SUPPLY POWER 183

N		EA	1	10		1
---	--	----	---	----	--	---

260983242 SUPPLY POWER 846

N		EA	1	24		1	
Wescom.							

260985288 SUPPLY POWER 041P033-001

N		EA	1	3		1
---	--	----	---	---	--	---

260425442 SUPPLY POWER 48V 6060-03

1977033	1	EA	IL	IN	MI	OH	WI
39 Provides 48 volts for Westell 31MA05 Mounting Assembly 6060-03.							

280019068 SUPPLY POWER 7715 2

1969063	1	EA	IL 04	IN	MI 04	OH	WI 04
---------	---	----	----------	----	----------	----	----------

260336532 SUPPLY POWER 7715-3 48 VOLT

1947705	1	EA	IL 04	IN 04	MI 04	OH 04	WI
A power supply used to power the loop back unit smart jack when using the local powering option for a single unit. For 31MA21 mounting assembly.							

260384771 SUPPLY POWER 7856 3

1969055	1	EA	IL 09	IN 09	MI 09	OH 09	WI
120 volt AC input 124 volt DC output.							

260367420 SUPPLY POWER 7885 1

N		EA	1	4		1	
120 volt AC input -48 volt DC output.							

260367438 SUPPLY POWER 7885 2

N		EA	1	4		1	
120 volt AC input 48 volt DC output.							

260961404 SUPPLY POWER 8410 48

N		EA	1	8		1
---	--	----	---	---	--	---

DISTRIBUTION SERVICES

NETWORK SERVICES

TOOLS

BUILDING JANITORIAL

AUTOMOTIVE

FORMS/OFFICE SUPPLIES

GENERAL

DATA VOICE

PRODUCT IDENTIFIER DESCRIPTION

ITEM NUMBER	ORD. MULT.	SELL UNIT	STD. PKG. STOCK AVAILABILITY / PA	LEAD TIME	MIN. ORD.	A C
-------------	------------	-----------	-----------------------------------	-----------	-----------	-----

260961347 SUPPLY POWER 8411 48
 1233940 1 EA IL IN MI OH WI

260961289 SUPPLY POWER 841124
 N

260967286 SUPPLY POWER 8548 00 I02
 N EA 1 1 1

280048810 SUPPLY POWER 99158
 1928010 1 EA IL IN MI OH WI
 59
 Power unit for Block Smart.

260387147 SUPPLY POWER BOARD HIGH VOLTAGE
 N EA 1 2 1
 55500005.

401499009 SUPPLY POWER CK20159 L 8
 N EA 1 2 1

400718037 SUPPLY POWER CK20850 L 1
 N EA 1 11 1

280004045 SUPPLY POWER ED2P186-30 G2
 N EA 1 2 1
 Used in J92621EL2.

260387139 SUPPLY POWER LOW VOLTAGE 55500012
 N EA 1 2 1

300076775 SUPPLY POWER TELTREND WPS2008
 1154435 1 EA IL IN MI OH WI
 04 04

280021049 SUPPLY POWER TII-10755
 N EA 1 3 1

SUPPLY RINGING

260374079 SUPPLY RINGING BULK 585100800
 1956367 1 EA

260418504 SUPPLY RINGING BULK HA15B-0001-B048
 1973388 1 EA IL IN MI OH WI
 09 09 09 09

SWAB

260387220 SWAB 7147
 N EA 1 1 1
 Used to clean magnetic tape drives.

260432646 SWAB TEXWIPES CRUSHTUBE TX726
 1979393 1 PK IL IN MI OH WI
 09
 Package of 50. Used for cleaning older type biconic connectors.

PRODUCT IDENTIFIER DESCRIPTION

ITEM NUMBER	ORD. MULT.	SELL UNIT	STD. PKG. STOCK AVAILABILITY / PA	LEAD TIME	MIN. ORD.	A C
-------------	------------	-----------	-----------------------------------	-----------	-----------	-----

SWITCH

401375530 SWITCH 211 BRYANT
 N EA 1 8 1

100738335 SWITCH 241A
 1148494 1 EA IL IN MI OH WI
 09 09 09 09 09
 Contains eight individual crosspoints. For use on the No. 1 ESS on J1A028.

100738343 SWITCH 241B
 N EA 1 20 1

101193506 SWITCH 241C
 N EA 1 9 1

100738350 SWITCH 242A
 5163089 1 EA IL IN MI OH WI
 09 09 09 09 09
 For use on J1A028 line switching frame, J1A029 junctor switching frame and J1A030 trunk switching frame No. 1 ESS.

100738368 SWITCH 242B
 N EA 1 2 1

100738376 SWITCH 242C
 N EA 1 2 1

100738392 SWITCH 242E
 N EA 1 2 1

100738657 SWITCH 259A
 N EA 1 2 1

840454276 SWITCH ASSEMBLY
 N EA 1 2 1

842711491 SWITCH ASSEMBLY 23F1922 MICRO2AC6
 N EA 1 2 1

401872064 SWITCH ASSEMBLY L502568
 N EA 1 13 1

401872072 SWITCH ASSEMBLY L502570
 N EA 1 12 1

260386859 SWITCH CK05189-03 L121
 N EA 1 13 1
 Emergency lighting serial #06399.

260387048 SWITCH CK13674 L 12 TOGGLE
 N EA 1 13 1
 48 volt rectifier.

260387048 SWITCH CK13674 L12 TOGGLE 48V RECTIFIER
 N EA

401126529 SWITCH CK20738 L 4 POWER
 N EA 1 13 1

SWITCH

DISTRIBUTION SERVICES

PRODUCT IDENTIFIER		DESCRIPTION				
ITEM NUMBER	ORD. MULT.	SELL UNIT	STD. PKG. STOCK AVAILABILITY / PA	LEAD TIME	MIN. ORD.	A C

402065411 SWITCH CK20738 L 6 POWER
N EA 1 1 1

NETWORK SERVICES

401126594 SWITCH CK20901 L 11
N EA 1 13 9

401128095 SWITCH CK20901 L 17
N EA 1 13 1

401265665 SWITCH CK20901 L 21
N EA 1 13 1

402163240 SWITCH CK20901 L102
N EA 1 8 1

TOOLS

402163380 SWITCH CK20901 L118
N EA 1 8 1

402163422 SWITCH CK20901 L122
N EA 1 10 1

BUILDING JANITORIAL

402162853 SWITCH CK20902 L103
N EA 1 12 1

402163257 SWITCH CK20902 L103
N EA 1 8 1

402163323 SWITCH CK20902 L110
N EA 1 8 1

AUTOMOTIVE

402163372 SWITCH CK20902 L116
N EA 1 8 1

000238816 SWITCH PAPER 74-12424-00
1154724 1 EA IL IN MI OH WI
09 09

997108840 SWITCH V3-601
N EA 1 20 1

FORMS/OFFICE SUPPLIES

SYNTHESIZER

260392725 SYNTHESIZER TONE CE4T
N EA 1 4 1

SYRINGE

996506416 SYRINGE WATERFILL CK05499 L1401
N EA 1 5 1

996506465 SYRINGE WATERFILL CK05499 L1402
N EA 1 5 1

GENERAL

SYSTEM POWER

260374095 SYSTEM POWER MODULAR 15B2
N EA 1 12 1

DATA VOICE

PRODUCT IDENTIFIER		DESCRIPTION				
ITEM NUMBER	ORD. MULT.	SELL UNIT	STD. PKG. STOCK AVAILABILITY / PA	LEAD TIME	MIN. ORD.	A C

TAPE

260386966 TAPE DC600A
N EA 1 1 1

TAPE TRANSPORT

400824934 TAPE TRANSPORT CK20571 L 1
N EA 1 1 1

TEMPLATE

260344114 TEMPLATE BASE METAL
N EA 1 4 1
For pad mounted cabinets. NOW AVAILABLE THROUGH TOUCH-TONE ORDER ENTRY.

260419304 TEMPLATE EVERGOOD
1974212 1 EA IL IN MI OH WI
09

For Evergood pedestal.

260382502 TEMPLATE P40129 STEEL PAD MTG
N EA 1 4 1

TERMINAL

103087755 TERMINAL 76S1-900HA/H-T.B.
N EA 1 1 1

100744192 TERMINAL 208A
N EA 1 2 1

840272272 TERMINAL ASSEMBLY
N EA 1 1 1

260380522 TERMINAL FORK TONGUE MINIATURE P22-2R
N EA 100 2 100
Panduit

814648622 TERMINAL GROUND FOR 303 CONNECTOR
N EA 1 9 1

841634207 TERMINAL PLATE
N EA 1 10 1

841053242 TERMINAL QUICK CONNECTOR 841053242
N EA 1 12 1

841678279 TERMINAL QUICK CONNECTOR 841678279
N EA 1 12 1

260380498 TERMINAL SPLICE PARALLEL NYLON PSN16
N EA 100 2 100
Insulated Panduit.

260380506 TERMINAL SPLICE PARALLEL NYLON PSN18
N EA 100 2 100
Insulated panduit.

DISTRIBUTION SERVICES

NETWORK SERVICES

TOOLS

BUILDING JANITORIAL

AUTOMOTIVE

FORMS/OFFICE SUPPLIES

GENERAL

DATA VOICE

PRODUCT IDENTIFIER		DESCRIPTION				
ITEM NUMBER	ORD. MULT.	SELL UNIT	STD. PKG. STOCK AVAILABILITY / PA	LEAD TIME	MIN. ORD.	A C
843830506		TERMINAL TEST	843830506			
N		EA	1	9	1	
260380530		TERMINAL TONGUE P22-2F MINIATURE RING				
N		EA	1		1	
Panduit.						
260964135		TERMINAL TRANSMISSION 5817				
1237941	1	EA	IL IN MI OH WI			
103183281		TERMINAL WIRE 1000A				
1175034	1	EA	IL IN MI OH WI	08 08 08 08 08		
Used to establish a talk circuit for maintenance operations.						

TERMINAL STRIP
SEE STRIP TERMINAL.

PRODUCT IDENTIFIER		DESCRIPTION				
ITEM NUMBER	ORD. MULT.	SELL UNIT	STD. PKG. STOCK AVAILABILITY / PA	LEAD TIME	MIN. ORD.	A C
840272264		TERMINATION ASSEMBLY	840272264			
N		EA	1	2	1	
841166804		TERMINATION BLOCK ASSEMBLY	841166804			
N		EA	1	8	1	
840280275		TERMINATION TEST QUALITY	840280275			
N		EA	1	18	1	

TEST SET
SEE SET TEST.

PRODUCT IDENTIFIER		DESCRIPTION				
ITEM NUMBER	ORD. MULT.	SELL UNIT	STD. PKG. STOCK AVAILABILITY / PA	LEAD TIME	MIN. ORD.	A C
997251863		THERMAL TIMING ELEMENT				
N		EA	1	1	1	

PRODUCT IDENTIFIER		DESCRIPTION				
ITEM NUMBER	ORD. MULT.	SELL UNIT	STD. PKG. STOCK AVAILABILITY / PA	LEAD TIME	MIN. ORD.	A C
260360078		TIMER	4A SOLID STATE			
N		EA	1	5	1	
100749811		TIMER	4A UNMOUNTED			
N		EA	1	1	1	
280003070		TIMER	36917			
N		EA	1	4	1	
997823067		TIMER	CK14799 L1			
N		EA	1	2	1	
997218219		TIMER	CK14799 L2			
N		EA	1	14	1	

PRODUCT IDENTIFIER		DESCRIPTION				
ITEM NUMBER	ORD. MULT.	SELL UNIT	STD. PKG. STOCK AVAILABILITY / PA	LEAD TIME	MIN. ORD.	A C
997220496		TIMER	CK14799 L3			
5171868	1	EA	IL IN MI OH WI	09 09 09 09		
HZ Time 985 Cam.						
997218185		TIMER	CK16663 L1			
1226951	1	EA	IL IN MI OH WI	09 09 09 09		
60HZ 2.7 Watt RPM 21V.						
300081049		TIMER	NPS 25030 L1			
1334227	1	EA	IL IN MI OH WI	09 09 09 09 09		
Intended for use in the master timing equipment associated with automatic message accounting in the No. 1 and No. 5 Crossbar Dial Systems.						
300081056		TIMER	NPS 25030 L2			
1334235	1	EA	IL IN MI OH WI	09 09 09 09 09		
Intended for use in the master timing equipment associated with automatic message accounting in the No 1 and No. Crossbar Dial Systems, BSP 030-141-701.						

PRODUCT IDENTIFIER		DESCRIPTION				
ITEM NUMBER	ORD. MULT.	SELL UNIT	STD. PKG. STOCK AVAILABILITY / PA	LEAD TIME	MIN. ORD.	A C
260421151		TONE	LOW BUSY & BT120	3500 115T		
N		EA	1	6	1	
260421144		TONE	TOUCH DIAL TONE	3500 115T		
N		EA	1	6	1	

PRODUCT IDENTIFIER		DESCRIPTION				
ITEM NUMBER	ORD. MULT.	SELL UNIT	STD. PKG. STOCK AVAILABILITY / PA	LEAD TIME	MIN. ORD.	A C
102223559		TRANSFORMER	410D			
1939835	1	EA				
Used with the Enhanced E911 Emergency Reporting System.						
102805447		TRANSFORMER	2200B			
N		EA	1	9	1	
101756013		TRANSFORMER	2239A ISOLATION			
7161000	1	EA	IL IN MI OH WI	04		
102829116		TRANSFORMER	2270D			
N		EA	1	11	1	
100767151		TRANSFORMER	2536D			
N		EA	1	20	1	
100770809		TRANSFORMER	2583A			
N		EA	1	7	1	
100770817		TRANSFORMER	2583B			
N		EA	1	7	1	
100770825		TRANSFORMER	2583C			
N		EA	1	10	1	
102754959		TRANSFORMER	2639J			
N		EA	1	9	1	

DISTRIBUTION SERVICES

TRANSFORMER

PRODUCT IDENTIFIER		DESCRIPTION				
ITEM NUMBER	ORD. MULT.	SELL UNIT	STD. PKG. STOCK AVAILABILITY / PA	LEAD TIME	MIN. ORD.	A C
102812237		TRANSFORMER	3043A			
N		EA	1	9	1	
102915766		TRANSFORMER	3043B			
N		EA	1	12	1	
102857935		TRANSFORMER	3044A			
N		EA	1	12	1	
402405203		TRANSFORMER	8015			
1149757	1	EA	IL IN MI OH WI 18 18			
Transformer, 117 Volt A.C. in, 26 Volt A.C., 7.5 Volt A.C. out, used for tellabs 1 and 2 slot program mountings.						

NETWORK SERVICES

TOOLS

BUILDING JANITORIAL

AUTOMOTIVE

FORMS/OFFICE SUPPLIES

GENERAL

DATA VOICE

PRODUCT IDENTIFIER		DESCRIPTION				
ITEM NUMBER	ORD. MULT.	SELL UNIT	STD. PKG. STOCK AVAILABILITY / PA	LEAD TIME	MIN. ORD.	A C
280002833		TRANSFORMER ISOLATION	TTI-10014			
N		EA	1	3	1	
7.5KV.						
280002841		TRANSFORMER ISOLATION	TTI-10015			
N		EA	1	3	1	
280002858		TRANSFORMER ISOLATION	TTI-10039			
N		EA	1	3	1	
4KV.						
260428818		TRANSFORMER	P13120			
N		EA	1	2	1	

PRODUCT IDENTIFIER		DESCRIPTION				
ITEM NUMBER	ORD. MULT.	SELL UNIT	STD. PKG. STOCK AVAILABILITY / PA	LEAD TIME	MIN. ORD.	A C
TRANSISTOR						
100993914		TRANSISTOR	17C			
N		EA	1	13	1	
100788439		TRANSISTOR	34A M/D			
N		EA	1	1	1	
MANUFACTURER DISCONTINUED - NO REPLACEMENT.						

PRODUCT IDENTIFIER		DESCRIPTION				
ITEM NUMBER	ORD. MULT.	SELL UNIT	STD. PKG. STOCK AVAILABILITY / PA	LEAD TIME	MIN. ORD.	A C
TRAY						
843080227		TRAY	843080227 ELBOW			
N		EA	1	14	1	
843080243		TRAY	843080243 COVER			
N		EA	1	14	1	
843080250		TRAY	843080250			
N		EA	1	14	1	

PRODUCT IDENTIFIER		DESCRIPTION				
ITEM NUMBER	ORD. MULT.	SELL UNIT	STD. PKG. STOCK AVAILABILITY / PA	LEAD TIME	MIN. ORD.	A C
TROLLEY						
280019019		TROLLEY PORTA-IRON	500-32-3015			
N		EA	1	2	1	

PRODUCT IDENTIFIER		DESCRIPTION				
ITEM NUMBER	ORD. MULT.	SELL UNIT	STD. PKG. STOCK AVAILABILITY / PA	LEAD TIME	MIN. ORD.	A C
400958096		TROLLEY TERMINAL	CK20085 L12			
2756585	1	EA	IL IN MI OH WI 18 18 18 18 18			
Trolley for 110V power, associated with rolling ladders in Central Offices, BSP 065-115-801.						

PRODUCT IDENTIFIER		DESCRIPTION				
ITEM NUMBER	ORD. MULT.	SELL UNIT	STD. PKG. STOCK AVAILABILITY / PA	LEAD TIME	MIN. ORD.	A C
TROUGH						
403249253		TROUGH CABLE	AT-9050B			
N		EA	1	13	1	
End guard cover for use in huts.						

PRODUCT IDENTIFIER		DESCRIPTION				
ITEM NUMBER	ORD. MULT.	SELL UNIT	STD. PKG. STOCK AVAILABILITY / PA	LEAD TIME	MIN. ORD.	A C
TRUNK INTERFACE						
260360524		TRUNK INTERFACE	F & FG			
1953745	1	EA				

PRODUCT IDENTIFIER		DESCRIPTION				
ITEM NUMBER	ORD. MULT.	SELL UNIT	STD. PKG. STOCK AVAILABILITY / PA	LEAD TIME	MIN. ORD.	A C
TUBE						
900495680		TUBE OFFSET RIGID	CK05499			
N		EA	1	5	1	

PRODUCT IDENTIFIER		DESCRIPTION				
ITEM NUMBER	ORD. MULT.	SELL UNIT	STD. PKG. STOCK AVAILABILITY / PA	LEAD TIME	MIN. ORD.	A C
TUBE ELECTRON						
997670054		TUBE ELECTRON	0D3VR150			
1137539	1	EA				
Voltage regulator discharge diode.						
997319314		TUBE ELECTRON	2D21			
N		EA	1	4	1	
260378195		TUBE ELECTRON	2E26			
N		EA	1	4	5	
260377361		TUBE ELECTRON	5R4GYB			
N		EA	1	4	10	

PRODUCT IDENTIFIER		DESCRIPTION				
ITEM NUMBER	ORD. MULT.	SELL UNIT	STD. PKG. STOCK AVAILABILITY / PA	LEAD TIME	MIN. ORD.	A C
997846662		TUBE ELECTRON	5U4GB			
1279729	1	EA	IL IN MI OH WI 59 59 59 59 59			
Rectifier tube - full wave high vacuum rectifier.						

PRODUCT IDENTIFIER		DESCRIPTION				
ITEM NUMBER	ORD. MULT.	SELL UNIT	STD. PKG. STOCK AVAILABILITY / PA	LEAD TIME	MIN. ORD.	A C
001040385		TUBE ELECTRON	5Y3GTGTG			
N		EA	1		1	

PRODUCT IDENTIFIER		DESCRIPTION				
ITEM NUMBER	ORD. MULT.	SELL UNIT	STD. PKG. STOCK AVAILABILITY / PA	LEAD TIME	MIN. ORD.	A C
997248992		TUBE ELECTRON	6BA6			
1280404	1	EA	IL IN MI OH WI 09 09 09 09 09			
Remote cutoff RF Pentode.						
997253448		TUBE ELECTRON	6BE6			
N		EA	1	2	1	

PRODUCT IDENTIFIER		DESCRIPTION				
ITEM NUMBER	ORD. MULT.	SELL UNIT	STD. PKG. STOCK AVAILABILITY / PA	LEAD TIME	MIN. ORD.	A C
400281481		TUBE ELECTRON	6L6GC			
1279984	1	EA	IL IN MI OH WI 59 59 59 59 59			
Beam power amplifier tube.						
997111117		TUBE ELECTRON	6V6GTA			
1280040	1	EA	IL IN MI OH WI 59 59 59 59 59			

PRODUCT IDENTIFIER		DESCRIPTION				
ITEM NUMBER	ORD. MULT.	SELL UNIT	STD. PKG. STOCK AVAILABILITY / PA	LEAD TIME	MIN. ORD.	A C
997669338		TUBE ELECTRON	12AT7			
N		EA	1	2	1	

PRODUCT IDENTIFIER		DESCRIPTION					
ITEM NUMBER	ORD. MULT.	SELL UNIT	STD. PKG. STOCK AVAILABILITY / PA	LEAD TIME	MIN. ORD.	A	C
997253711 TUBE ELECTRON 12AU7A							
1280826	1	EA	IL IN MI OH WI 59 59 59 59 59				
High-MU twin triode.							
997846100 TUBE ELECTRON 50L6GT							
N		EA	1	1	1		
260377346 TUBE ELECTRON 121B							
N		EA	1	4	1		
100792407 TUBE ELECTRON 275 A							
N		EA	1	4	1		
100792522 TUBE ELECTRON 300 B - TRIODE							
1281345	1	EA	IL IN MI OH WI 59 59 59 59 59				
100792555 TUBE ELECTRON 310 A PENTODE							
1281360	1	EA	IL IN MI OH WI 59 59 59 59 59				
Pentode.							
100792589 TUBE ELECTRON 313 C COLD CATHODE							
1281428	1	EA	IL IN MI OH WI 59 59 59 59 59				
100792639 TUBE ELECTRON 323 B THYRATRON							
5268300	1	EA	IL IN MI OH WI 59 59 59 59				
100792746 TUBE ELECTRON 350 B PENTODE							
1281600	1	EA	IL IN MI OH WI 59 59 59 59 59				
100792977 TUBE ELECTRON 396 A MINIATURE TWIN TRIO							
1281824	1	EA	IL IN MI OH WI 59 59 59 59 59				
DE							
100793058 TUBE ELECTRON 403 B							
N		EA	1	4	1		
100793124 TUBE ELECTRON 412A 130 VOLT							
N		EA	1	1	1		
Pos Rect.							
100793181 TUBE ELECTRON 420A							
N		EA	1	1	1		
100793199 TUBE ELECTRON 421A							
N		EA	1	4	3		
100793215 TUBE ELECTRON 423C 130 VOLT							
N		EA	1	1	1		
Pos Rect.							
102190667 TUBE ELECTRON 430 C							
N		EA	1	4	1		
997669759 TUBE ELECTRON 5651							
N		EA	1	4	10		

PRODUCT IDENTIFIER		DESCRIPTION					
ITEM NUMBER	ORD. MULT.	SELL UNIT	STD. PKG. STOCK AVAILABILITY / PA	LEAD TIME	MIN. ORD.	A	C
260377320 TUBE ELECTRON 5894A							
N		EA	1	4	1		
260377338 TUBE ELECTRON 6146							
N		EA	1	4	6		
260388392 TUBE ELECTRON 6681							
N		EA	1	4	1		
280025727 TUBE ELECTRON 7558							
N		EA	1	3	6		
260386883 TUBE ELECTRON 8560AS							
N		EA	1	1	1		
UNIT							
280040429 UNIT ANNOUNCER 688							
1953828	1	EA	Automatic Number Announcer Model 44167940.				
103197919 UNIT APPARATUS 30AM							
N		EA	1	14	1		
260963939 UNIT CUSTOMER PREMISE 97094-00 DC							
1237727	1	EA	IL IN MI OH WI				
260964317 UNIT CUSTOMER SERVICE 97028-00							
1238220	1	EA	IL IN MI OH WI				
Standalone.							
260964309 UNIT CUSTOMER SERVICE 97045-00							
1238212	1	EA	IL IN MI OH WI				
260401062 UNIT DISPLAY MAINTENANCE							
N		EA	1		1		
260389408 UNIT DS1/DS1C MONITOR DMXR 531							
N		EA	1		1		
260970934 UNIT DSU 9000-LJ-T1							
N		EA	1	4	1		
260435169 UNIT EXTENDER 9440-00 M1							
1980185	1	EA	IL IN MI OH WI				
402670764 UNIT INTERFACE CK22566 L3							
N		EA	1	8	1		
260391479 UNIT INTERFACE NETWORK 3110-70							
1965541	1	EA	IL IN MI OH WI 18 18 18				
Westell circuit pack used to support HICAPS circuits. T1 Facility Loopback Unit.							
260369301 UNIT LOOP CONVERSION M-161-49							
N		EA	1	4	1		
-48 Volts DC, all purpose.							

DISTRIBUTION SERVICES
 NETWORK SERVICES
 TOOLS
 BUILDING JANITORIAL
 AUTOMOTIVE
 FORMS/OFFICE SUPPLIES
 GENERAL
 DATA VOICE

DISTRIBUTION SERVICES

NETWORK SERVICES

TOOLS

BUILDING JANITORIAL

AUTOMOTIVE

FORMS/OFFICE SUPPLIES

GENERAL

DATA VOICE

UNIT

PRODUCT IDENTIFIER		DESCRIPTION				
ITEM NUMBER	ORD. MULT.	SELL UNIT	STD. PKG. STOCK AVAILABILITY / PA	LEAD TIME	MIN. ORD.	A C
400790259		UNIT	MAGNI-FOCUSER CK19916	L1		
N		EA	1	3	1	
260369236		UNIT	REMOTE ACCESS M-106-02			
N		EA	1	4	1	
24 Volts DC with Amplifier.						
260379615		UNIT	REMOTE ACCESS M-106-05			
N		EA	1	4	1	
48 Volts.						
260369293		UNIT	REMOTE ACCESS M-106-63			
N		EA	1	4	1	
-48 Volts -24 Volts DC with Voice Amplifier.						
260392915		UNIT	RESIDUAL RING 3500-112			
N		EA	1	4	1	
260392931		UNIT	RESIDUAL RING 3500-112H			
N		EA	1	4	1	
100W.						
260392998		UNIT	RESIDUAL RING 3500-115			
N		EA	1	4	1	
260962527		UNIT	SERVICE 7480-03			
1235697	1	EA	IL	IN	MI	OH
WI						
102633765		UNIT	SERVICE CHANNEL 150A			
1218479	1	EA	IL	IN	MI	OH
WI						
The 150A CSU is a passive device which provides a 2-wire interface between voiceband data station equipment and a 2-wire private line service, BSP 590-101-000.						
260964325		UNIT	SERVICE CHANNEL 97051-00			
N		EA	1	17	1	
Multi-mount.						
280055153		UNIT	SERVICE CHANNEL CSU 4110			
1942318	1	EA	IL	IN	MI	OH
WI						
04 04 04 04 04						
102234515		UNIT	SERVICE DATA 500A L1/3			
N						
250019304		UNIT	SERVICE DATA 500B L1/4			
N						
260319843		UNIT	T1 FACILITY LOOPBACK 3100-25			
1941658	1	EA	IL	IN	MI	OH
WI						
18						
260348974		UNIT	T1 FACILITY LOOPBACK 3100-27			
1951780	1	EA	IL	IN	MI	OH
WI						
18 18 18						
260417753		UNIT	T1 FACILITY LOOPBACK 3117-00			
N		EA	1	4	1	
260431663		UNIT	T1 FACILITY LOOPBACK W/PERF MONITOR			
N		EA	1	4	1	

PRODUCT IDENTIFIER		DESCRIPTION				
ITEM NUMBER	ORD. MULT.	SELL UNIT	STD. PKG. STOCK AVAILABILITY / PA	LEAD TIME	MIN. ORD.	A C
260986930		UNIT	T1 FACILITY LOOPBACK/PM 3110-01			
N		EA	1	4	1	
103292454		UNIT	TERMINAL NETWORK 4289A			
1942029	1	EA	IL	IN	MI	OH
WI						
08 08 08						
260032479		UNIT	WSCM 854800102			
1231456	1	EA	IL	IN	MI	OH
WI						

UNIT CHANNEL

001207455		UNIT	CHANNEL PROTECTION 500Z			
1178418	1	EA				
A passive device designed to protect the facilities against hazardous voltage and longitudinal imbalance, BSP 314-410-312.						
280046327		UNIT	CHANNEL PROTECTOR 500Z 4W			
1927996	1	EA	IL	IN	MI	OH
WI						
04 04 04 04 04						
AC/DC						
099018434		UNIT	CHANNEL PROTECTOR 500Z L1			
1159400	1	EA	IL	IN	MI	OH
WI						
09 09 09						
A passive device designed to protect the facilities against hazardous voltage and longitudinal imbalance, BSP 314-410-312.						
099018442		UNIT	CHANNEL PROTECTOR 500Z L5			
N		EA	1	2	1	
300069796		UNIT	CHANNEL PROTECTOR D500Z DC			
5121012	1	EA	IL	IN	MI	OH
WI						
09 09 09 09						
260963921		UNIT	CHANNEL PROTECTOR 9702000			
N		EA	1	16	1	
250009032		UNIT	CHANNEL SERVICE 550A L1/5			
N						

UNIT POWER

103232781		UNIT	POWER 34 B2			
N		EA	1	2	1	
102570140		UNIT	POWER 130 B			
1939785	1	EA	IL	IN	MI	OH
WI						
04 04						
Used with the enhanced E911 emergency reporting system.						
103235644		UNIT	POWER 131 L1A			
1939793	1	EA	IL	IN	MI	OH
WI						
04 04						
Used with the enhanced E911 emergency reporting system.						
103235651		UNIT	POWER 131 N1A			
N		EA	1	2	1	

PRODUCT IDENTIFIER		DESCRIPTION					
ITEM NUMBER	ORD. MULT.	SELL UNIT	STD. PKG. STOCK AVAILABILITY / PA	LEAD TIME	MIN. ORD.	A	C
102507365 UNIT POWER 132 J							
1939801	1	EA	IL IN MI OH WI 04 04				
Used with the enhanced E911 emergency reporting system.							
260381017 UNIT POWER NJ03510 DB1 L1							
N		EA	1	13		1	
UNIT PROTECTOR							
103832945 UNIT PROTECTOR 1B 1F							
N		EA	100	4		100	
104155502 UNIT PROTECTOR 1B 3F							
N		EA	1	4		1	
102381779 UNIT PROTECTOR 3B 1A							
1228932	1	EA	IL IN MI OH WI 08 08 08 08 08				
Five pin, plug-in type protector unit. For use in 189 & 190 cable terminals and frame type 303 connectors. Black, carbon, standard circuit protection, BSP 636-300-050.							
103090395 UNIT PROTECTOR 3B 1E							
1106211	1	EA	IL IN MI OH WI 08 08 08 08 08				
Black, gas tube, standard circuit protection.							
102381787 UNIT PROTECTOR 3B 2A							
N		EA	1	5		1	
103090403 UNIT PROTECTOR 3B 2E							
N		EA	1	1		1	
102381795 UNIT PROTECTOR 3B 3A							
4213041	1	EA	IL IN MI OH WI 08 08 08 08 08				
Red carbon, special circuit protection.							
103090411 UNIT PROTECTOR 3B 3E							
1179242	1	EA	IL IN MI OH WI 08 08 08 08 08				
Red gas, special circuit protection.							
260379557 UNIT PROTECTOR 3B 3E T1							
1959742	1	EA	IL IN MI OH WI 59 59 59				
Red, no protection, continuity only, Central office use only.							
102381803 UNIT PROTECTOR 3B 4A							
1947648	1	EA	IL IN MI OH WI 08 08 08 08				
Yellow, carbon, digital phone protection.							
103090429 UNIT PROTECTOR 3B 4E M/D							
N		EA	1	1		1	
Yellow, gas tube, digital phone protection. DISCONTINUED AVAILABILITY - REPLACED BY 104410170.							
260406475 UNIT PROTECTOR 3C 1E							
1970012	1	EA	IL IN MI OH WI 08 08 08 08				

PRODUCT IDENTIFIER		DESCRIPTION					
ITEM NUMBER	ORD. MULT.	SELL UNIT	STD. PKG. STOCK AVAILABILITY / PA	LEAD TIME	MIN. ORD.	A	C
260406483 UNIT PROTECTOR 3C 3E							
1970020	1	EA	IL IN MI OH WI 08 08 08 08				
For assembly of Fujitsu 6200 cabinets.							
102904893 UNIT PROTECTOR 4B 1C							
1165217	100	EA	IL IN MI OH WI 08 08 08 08				
103090437 UNIT PROTECTOR 4B 1E							
1333542	1	EA	IL IN MI OH WI 08 08 08 08				
103550992 UNIT PROTECTOR 4B 1F							
N		EA	1	2		1	
102904901 UNIT PROTECTOR 4B 2C							
1189860	1	EA	IL IN MI OH WI 08 08 08 08 08				
BSP 636-320-100, BSP 201-208-100.							
103090445 UNIT PROTECTOR 4B 2E							
N		EA	1	1		1	
103551016 UNIT PROTECTOR 4B 2F							
N		EA	1	4		1	
102904919 UNIT PROTECTOR 4B 3C							
1100651	1	EA	IL IN MI OH WI 08 08 08 08 08				
Red, carbon, heat coil, special circuit protection.							
103090452 UNIT PROTECTOR 4B 3E							
1312967	1	EA	IL IN MI OH WI 08 08 08 08 08				
104401872 UNIT PROTECTOR 4B 3EW							
N		EA	1	2		1	
103551024 UNIT PROTECTOR 4B 3F							
N		EA	1	4		1	
102904927 UNIT PROTECTOR 4B 4C							
1947663	1	EA	IL IN MI OH WI 08 08 08 08 08				
Yellow carbon, heat coil, digital phone protection.							
103090460 UNIT PROTECTOR 4B 4E							
1947671	1	EA	IL IN MI OH WI 08 08 08 08				
Yellow, gas tube, heat coil, digital phone protection.							
103551032 UNIT PROTECTOR 4B 4F							
N		EA	1	4		1	
102904976 UNIT PROTECTOR 4B 9C							
N		EA	1	5		1	
103551040 UNIT PROTECTOR 4B 9F							
N		EA	1	4		1	
103626016 UNIT PROTECTOR 4B 12C							
N		EA	1	1		1	

DISTRIBUTION SERVICES
 NETWORK SERVICES
 TOOLS
 BUILDING JANITORIAL
 AUTOMOTIVE
 FORMS/OFFICE SUPPLIES
 GENERAL
 DATA VOICE

UNIT PROTECTOR

DISTRIBUTION SERVICES

NETWORK SERVICES

TOOLS

BUILDING JANITORIAL

AUTOMOTIVE

FORMS/OFFICE SUPPLIES

GENERAL

DATA VOICE

PRODUCT IDENTIFIER		DESCRIPTION						
ITEM NUMBER	ORD. MULT.	SELL UNIT	STD. PKG. STOCK AVAILABILITY / PA	LEAD TIME	MIN. ORD.	A	C	
103051470 UNIT PROTECTOR 4C 1C								
1154674	1	EA	IL 08 IN 08 MI 08 OH 08 WI 08					
103324034 UNIT PROTECTOR 4C 1F								
1956318	1	EA	IL 08 IN 08 MI 08 OH 08 WI 08					
103051488 UNIT PROTECTOR 4C 2C								
N		EA	1	1			1	
103324059 UNIT PROTECTOR 4C 2F								
N		EA	1	1			1	
104401914 UNIT PROTECTOR 4C 3EW								
N		EA	1	1			1	
103324067 UNIT PROTECTOR 4C 3F								
N		EA	1	1			1	
103051504 UNIT PROTECTOR 4C 4C								
N		EA	1	1			1	
103324075 UNIT PROTECTOR 4C 4F								
N		EA	1	1			1	
103324083 UNIT PROTECTOR 4C 9F								
N		EA	1	1			1	
102869500 UNIT PROTECTOR 4C 11E M/D								
N		EA	1	1			1	
REPLACED BY PID 106622996 UNIT PROTECTOR 4C11F.								
103324042 UNIT PROTECTOR 4C 11F								
N		EA	1	1			1	
103290755 UNIT PROTECTOR 4C 12C								
N		EA	1	2			1	
100828268 UNIT PROTECTOR 5A 1D								
1101089	100	EA	IL 08 IN 08 MI 08 OH 08 WI 08					
Grey, no protection, continuity only, Central office use only.								
100828284 UNIT PROTECTOR 5A 3D								
1193995	100	EA	IL 08 IN 08 MI 08 OH 08 WI 08					
100828318 UNIT PROTECTOR 6B 1A								
5163287	1	EA	IL 08 IN 08 MI 08 OH 08 WI 08					
A gas tube protector unit used in T1 carrier 468-type apparatus cases, BSP 631-005-050.								
103810321 UNIT PROTECTOR 12A 1F								
N		EA	1	4			1	
280011271 UNIT PROTECTOR 35BCN								
N		EA	1	4			1	
260446547 UNIT PROTECTOR 3B4EW								
N								

PRODUCT IDENTIFIER		DESCRIPTION						
ITEM NUMBER	ORD. MULT.	SELL UNIT	STD. PKG. STOCK AVAILABILITY / PA	LEAD TIME	MIN. ORD.	A	C	
260446661 UNIT PROTECTOR 4C 11F								
N								
260446653 UNIT PROTECTOR 4C 3F								
N								
106622996 UNIT PROTECTOR 4C11F								
N		EA	1	1			1	
260419023 UNIT PROTECTOR AT-9049C								
1973933	1	EA	IL 08 IN MI OH WI					
260419007 UNIT PROTECTOR KA-9049A								
1973917	1	EA	IL 03 IN MI OH WI					
260419015 UNIT PROTECTOR KA-9049B								
1973925	1	EA	IL 03 IN MI OH WI					
280047713 UNIT PROTECTOR R1B 1E								
1926204	1	EA	IL 08 IN MI OH WI					
VACUUM								
260344759 VACUUM MODEL AC80704-06 W/TOOL KIT								
N		EA	1	2			1	
Vacuum cleaner for Central Office environment.								
VARISTOR								
100829399 VARISTOR 100A								
N		EA	1	2			1	
VENT								
001134659 VENT PORTABLE MOUNTING HOLE								
N		DZ	1				1	
4IN DIAMETER								
VIEWER								
260386958 VIEWER CK21774 L60								
N		EA	1	1			1	
For Tape Magnetic B1O22								
WASH								
403892003 WASH AEROSAL 5 OZ CAN CA09065								
N		EA	1	3			1	
WIPER								
402175780 WIPER L504777								
N		EA	1	13			1	

PRODUCT IDENTIFIER DESCRIPTION

ITEM NUMBER	ORD. MULT.	SELL UNIT	STD. PKG. STOCK AVAILABILITY / PA	LEAD TIME	MIN. ORD.	A C
-------------	------------	-----------	-----------------------------------	-----------	-----------	-----

WIRE

260386792 WIRE 11N 30 GAUGE 30-B-50-010
 N PK 20 4 20
 For wire wrapping. 50 per package.

280054727 WIRE DSX CROSS-CONNECT 5 CONDUCTOR
 1929810 1 EA IL IN MI OH WI
 09 09 09 09 09
 CCW/2000ft spool.

103361200 WIRE DSX JUMPER Y2 24 GAUGE
 N FT 1350 2 1350
 1350ft spool. NOW AVAILABLE THROUGH TOUCH-TONE ORDER ENTRY.

WIRE RETAINER

842388670 WIRE RETAINER 842388670 UPPER
 N EA 1 15 1

842388688 WIRE RETAINER 842388688 LOWER
 N EA 1 15 1

842703076 WIRE RETAINER 842703076
 N EA 1 7 1

PRODUCT IDENTIFIER DESCRIPTION

ITEM NUMBER	ORD. MULT.	SELL UNIT	STD. PKG. STOCK AVAILABILITY / PA	LEAD TIME	MIN. ORD.	A C
-------------	------------	-----------	-----------------------------------	-----------	-----------	-----

DISTRIBUTION SERVICES

NETWORK SERVICES

TOOLS

BUILDING JANITORIAL

AUTOMOTIVE

FORMS/OFFICE SUPPLIES

GENERAL

DATA VOICE

NOTES

SECTION 3 - TOOLS **MATERIAL INCLUDED**

- STATIC CONTROL PRODUCTS
- TEST EQUIPMENT
- TOOLS
- SAFETY AND WEARING APPAREL

We are concerned and value your ideas. Please contact the Ameritech Bell Group Catalog Department direct on (708) 248-8313 with questions, corrections and ideas.

Catalog Format

PRODUCT IDENTIFIER		DESCRIPTION				
ITEM NUMBER	ORD. MULT.	SELL UNIT	STD. PKG.	LEAD TIME	MIN. ORD.	A C
			STOCK AVAILABILITY / PA			

Stock Material

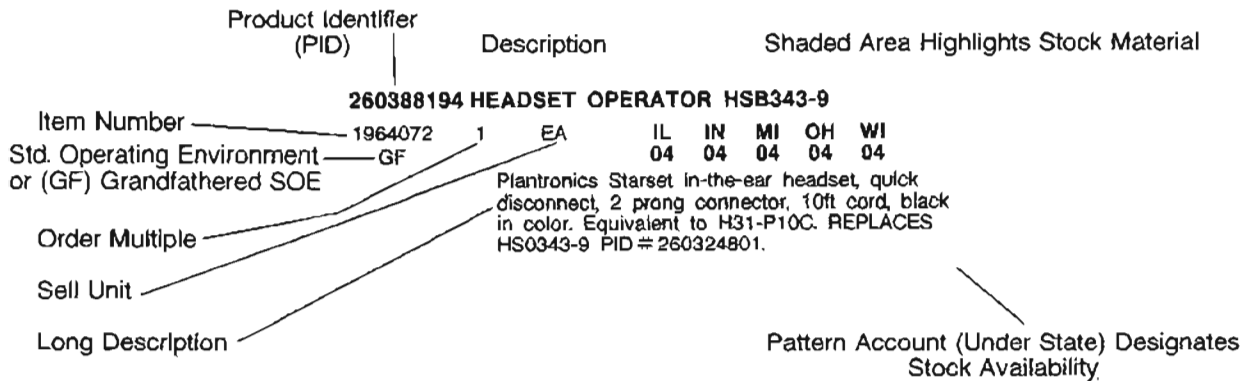

Non-Stock Material

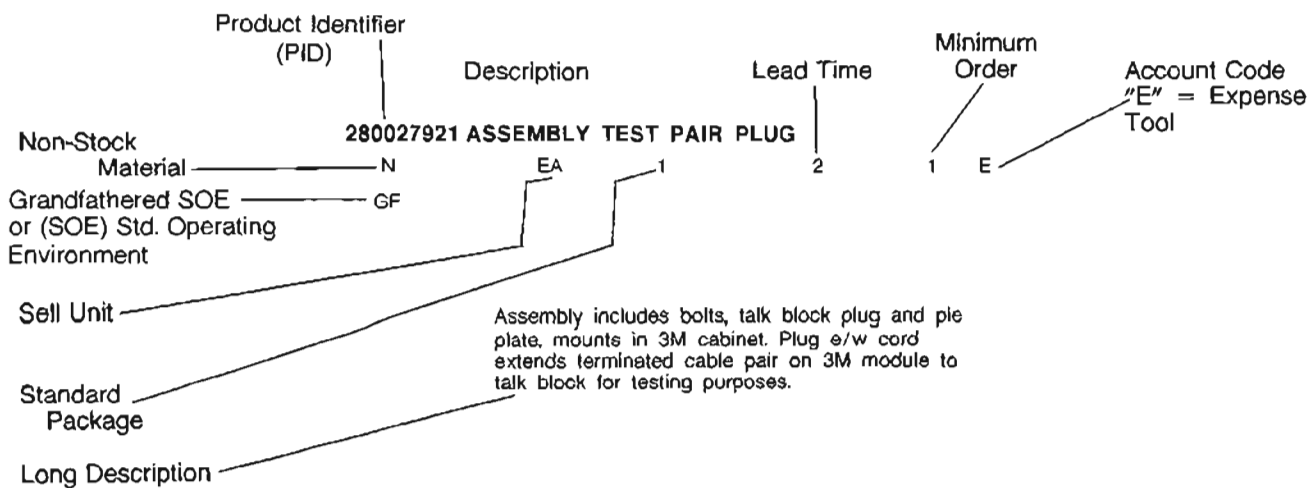

DISTRIBUTION SERVICES

NETWORK SERVICES

TOOLS

BUILDING JANITORIAL

AUTOMOTIVE

FORMS/OFFICE SUPPLIES

GENERAL

DATA VOICE

PRODUCT IDENTIFIER		DESCRIPTION				
ITEM NUMBER	ORD. MULT.	SELL UNIT	STD. PKG. STOCK AVAILABILITY / PA	LEAD TIME	MIN. ORD.	A C

ADAPTER

260322052 ADAPTER AC LIGHT UV SL-100 82049						
N		EA	1	3	1	E
An AC Adapter for Light UV SL-100 81013 (PID260322045).						
402613681 ADAPTER CK22424 L 5						
N		EA	1	20	1	E
402613699 ADAPTER CK22424 L 6						
N		EA	1	20	1	E
402853139 ADAPTER CK22424 L 7						
N		EA	1	20	1	E
402853725 ADAPTER CK22424 L 8						
N		EA	1	20	1	E
300071651 ADAPTER FRAME 4044						
N		EA	1	2	1	E
300014404 ADAPTER FRAME 4344						
N		EA	1	3	1	E
A frame adaptor to hold a splice head when terminating cable in the 3M cross connect system.						
402851109 ADAPTER MODULAR 10113-000						
1333047	1	EA	IL IN MI OH WI 12 12 12 12 12			E

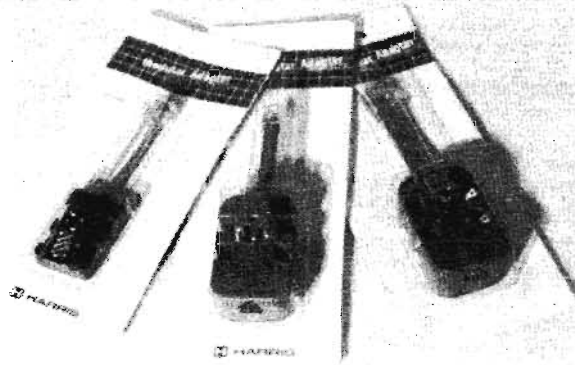

1333047

300023132 ADAPTER MODULAR 10220-000 INLINE						
1116574	1	EA	IL IN MI OH WI 12 12 12 12 12			E
Six wire in-line modular adapter. Allows circuit access without disconnecting equipment.						
280003781 ADAPTER MODULAR 10230-000 INLINE						
1921304	1	EA	IL IN MI OH WI 12 12 12 12 12			E
Eight wire in-line modular adapter. Allows circuit access with out disconnecting equipment.						
845543792 ADAPTER PLUG H2C						
N		EA	1	11	10	E
Price per 100.						

PRODUCT IDENTIFIER		DESCRIPTION				
ITEM NUMBER	ORD. MULT.	SELL UNIT	STD. PKG. STOCK AVAILABILITY / PA	LEAD TIME	MIN. ORD.	A C

260321831 ADAPTER PRUNING HEAD PHA-11						
N		EA	6	2	6	E
260321823 ADAPTER PRUNING HEAD PHA-12						
N		EA	6	2	6	E
260395082 ADAPTER SCREW-IN 7569						
N		EA	1	2	1	E

AMPLIFIER

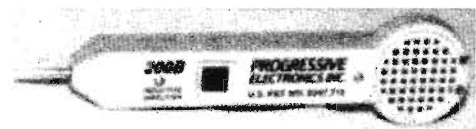
280080334 AMPLIFIER 200 B						
1936542	1	EA				E
						
280080334						
260432505 AMPLIFIER 200 EP						
N		EA	1	2	1	
280017492 AMPLIFIER MACOM TA-25						
N		EA	1	2	1	E
102264694 AMPLIFIER MT147 C						
1104174	1	EA	IL IN MI OH WI 12 12 12 12 12			E
A solid state, dry battery amplifier, part of Set Test 91A.						

260439062 AMPLIFIER PL99						
N		EA	1	2	1	
280011073 AMPLIFIER PROGRAM DISTRIBUTION 4018						
N		EA	1	4	1	E
Module used for low distortion, wideband amplifier. Intended for use in audio program circuits. Single input, eight output splitting amplifier. 600 OHMS output.						

ANALOG

280015579 ANALOG FLUKE 75 DIGITAL						
N		EA	1	2	1	E
Hand held Multi-Meter W/C71 soft case.						

DISTRIBUTION SERVICES

APRON

PRODUCT IDENTIFIER		DESCRIPTION						
ITEM NUMBER	ORD. MULT.	SELL UNIT	STD. PKG. STOCK AVAILABILITY / PA	LEAD TIME	MIN. ORD.	A	C	

APRON

900206863 APRON ICEMAN RUBBER 72

1126649	1	EA					E
---------	---	----	--	--	--	--	---

For use in battery rooms.

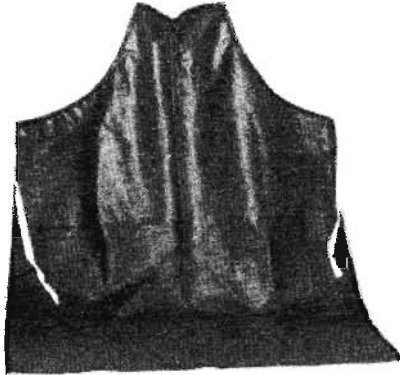

900206863

400004131 APRON INSTALLER B CA07523

1100925	1	EA	IL	IN	MI	OH	WI	E
			12	12	12	12	12	

Canvas apron with pockets and a loop for carrying a hammer.



1100925

ASSEMBLY

845543784 ASSEMBLY ADAPTER H2B LIP

N		EA	1	6	1	E
---	--	----	---	---	---	---

260439930 ASSEMBLY AIR CHUCK #823

N		EA	1	2	1	
---	--	----	---	---	---	--

Air impact tool parts.

260436605 ASSEMBLY CONNECTOR PLUG

1980847	1	EA	IL	IN	MI	OH	WI
---------	---	----	----	----	----	----	----

402383467 ASSEMBLY HEAD CUT INST CA08764

N		EA	1	8	10	E
---	--	----	---	---	----	---

300096146 ASSEMBLY IMPACT TOOL 4055-A

N		EA	1	2	1	E
---	--	----	---	---	---	---

NETWORK SERVICES

TOOLS

BUILDING JANITORIAL

AUTOMOTIVE

FORMS/OFFICE SUPPLIES

GENERAL

DATA VOICE

PRODUCT IDENTIFIER		DESCRIPTION						
ITEM NUMBER	ORD. MULT.	SELL UNIT	STD. PKG. STOCK AVAILABILITY / PA	LEAD TIME	MIN. ORD.	A	C	

841693997 ASSEMBLY JUMPER CORD

N		EA	1	17	1	
---	--	----	---	----	---	--

Price per 100.

280019340 ASSEMBLY LIGHT COMP 450-0152

N		EA	1	2	1	E
---	--	----	---	---	---	---

845484443 ASSEMBLY PAD SHOULDER

N		EA	1	13	1	E
---	--	----	---	----	---	---

260439948 ASSEMBLY QUICK WHIP #824

N		EA	1	2	1	
---	--	----	---	---	---	--

Air impact tool parts.

260328109 ASSEMBLY TEST PAIR CLIP 4347A

N		EA	1	3	1	E
---	--	----	---	---	---	---

280027921 ASSEMBLY TEST PAIR PLUG 4047A

N		EA	1	2	1	E
---	--	----	---	---	---	---

Assembly includes bolts, talk block plug and pie plate, mounts in 3M cabinet. Plug e/w cord extends terminated cable pair on 3M module to talk block for testing purposes.

AUGER

300085057 AUGER 813A

N		EA	1	2	1	E
---	--	----	---	---	---	---

Auger telescopic standard with extension handle for boring guy anchor holes.

AXE

400005724 AXE 4LB CA07769

1102079	1	EA				E
---------	---	----	--	--	--	---

Has 4LB head and 35in hickory handle, for use in felling trees and general heavy chopping, BSP 081-745-100.



400005724

DISTRIBUTION SERVICES

NETWORK SERVICES

TOOLS

BUILDING JANITORIAL

AUTOMOTIVE

FORMS/OFFICE SUPPLIES

GENERAL

DATA VOICE

PRODUCT IDENTIFIER		DESCRIPTION					A
ITEM NUMBER	ORD. MULT.	SELL UNIT	STD. PKG. STOCK AVAILABILITY / PA	LEAD TIME	MIN. ORD.	PA	C

BAG

400006078 BAG CANVAS JUNK CA06265
 1105940 1 EA E
 Used for the removal of recovered waste and junk materials, 8in x 16in x 18in, BSP 620-310-100.



400006078

280011016 BAG CANVAS TOOL OVAL W/S
 N EA 1 2 1 E
 Klein P/NAC-007536.

300064649 BAG FRAME 9168
 N EA 1 6 1 E

900208083 BAG FRAME PROTECTION 90194
 N EA 1 4 12 E
 ED01-509.

400006045 BAG GLOVE B CA08338
 1105924 1 EA E
 IL IN MI OH WI
 12 12 12 12 12
 For protection while carrying and storing insulating gloves and leather/ fabric glove liners, BSP 081-710-200.

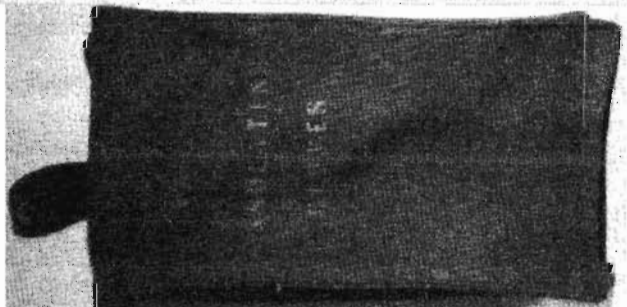

1105924

900208018 BAG INSTALLER 2092 COMMERCIAL
 N EA 1 4 12 E
 For installers to carry materials when climbing poles, 9in long x 7in deep.

PRODUCT IDENTIFIER		DESCRIPTION					A
ITEM NUMBER	ORD. MULT.	SELL UNIT	STD. PKG. STOCK AVAILABILITY / PA	LEAD TIME	MIN. ORD.	PA	C

400006086 BAG INSTALLER MATERIAL BLUE P/N 5810-B
 1105965 1 EA E
 IL IN MI OH WI
 12 12 12 12 12
 CA06480, 13in x 3 3/4in, has four compartments.

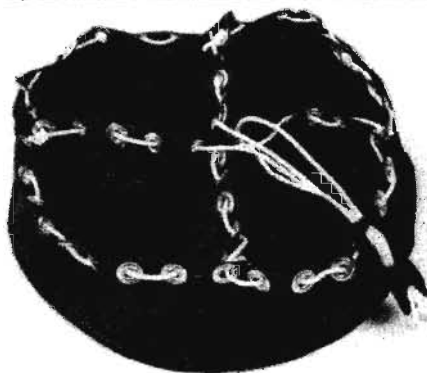

1105965

900208059 BAG LADDER 5114B W/O FRAME 12IN
 N EA 1 3 12 E
 A canvas utility bag that snaps onto a steel frame which hooks on a ladder step.

401334131 BAG LADDER CANVAS 12IN W/FRAME
 N EA 1 3 12 E
 A steel framed canvas utility bag which hooks onto a ladder step.

280055666 BAG LADDER MATE
 1930354 1 EA E
 IL IN MI OH WI
 12 12 12 12 12
 A plastic zippered bag designed to accommodate the storing of ladder mate straps.



1930354

DISTRIBUTION SERVICES

NETWORK SERVICES

TOOLS

BUILDING JANITORIAL

AUTOMOTIVE

FORMS/OFFICE SUPPLIES

GENERAL

DATA VOICE

BAG

PRODUCT IDENTIFIER

DESCRIPTION

ITEM NUMBER	ORD. MULT.	SELL UNIT	STD. PKG. STOCK AVAILABILITY / PA	LEAD TIME	MIN. ORD.	A	C
-------------	------------	-----------	-----------------------------------	-----------	-----------	---	---

002040947 BAG RAINUIT

1143560	1	EA	IL 12	IN 12	MI 12	OH 12	WI 12	E
---------	---	----	----------	----------	----------	----------	----------	---

For use in inclement weather by outside forces.

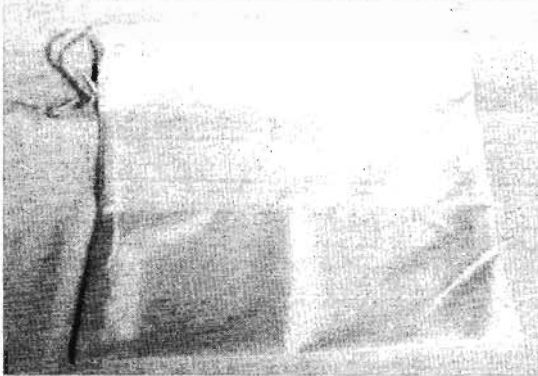

1143560

300085107 BAG STORAGE 996309

N	EA	1	3	3	E
---	----	---	---	---	---

A storage bag which is in effect a sign holder. The sign it holds is the sign - LEFT LANE CLOSED - .

402380216 BAG STORAGE C CA8924

1101014	1	EA	IL 12	IN 12	MI 12	OH 12	WI 12	E
---------	---	----	----------	----------	----------	----------	----------	---

Canvas bag to accomodate Set Test 188A (1163958) and Bond Temporary B (1181891), BSP 081-701-101.



1101014

900208141 BAG TOOL 292 COMMERCIAL

N	EA	1	4	3	E
---	----	---	---	---	---

Used by the installation and repair forces for carrying tools, repair parts, etc. Size: 16in X 6in X 12in.

PRODUCT IDENTIFIER

DESCRIPTION

ITEM NUMBER	ORD. MULT.	SELL UNIT	STD. PKG. STOCK AVAILABILITY / PA	LEAD TIME	MIN. ORD.	A	C
-------------	------------	-----------	-----------------------------------	-----------	-----------	---	---

401875521 BAG TOOL B CA06068

1102111	1	EA	IL 12	IN 12	MI 12	OH 12	WI 12	E
---------	---	----	----------	----------	----------	----------	----------	---

Used by outside plant forces, such as splicers and section linemen. 20in x 6in x 17in, dark brown duck, with reinforced leather bottom.

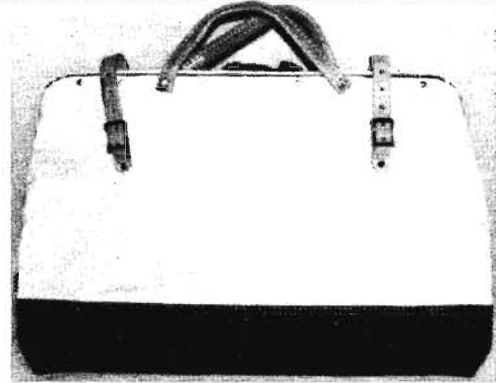

1102111

401130729 BAG TOOL CANVAS 299-16

N	EA	1	4	12	E
---	----	---	---	----	---

Commercial.

900208158 BAG TOOL CBL REPAIRMAN WM 128 COMMERCIAL

N	EA	1	4	1	E
---	----	---	---	---	---

300052107 BAG TORCH TB-100

6509745	1	EA	IL 12	IN 12	MI 12	OH 12	WI 12	E
---------	---	----	----------	----------	----------	----------	----------	---

Equipped with four pockets and cylinder securing feature.



6509745

BAG TENT

SEE TENT.

BAR

260421979 BAR DIGGING 40IN SPECIAL

N	EA	1	2	1
---	----	---	---	---

PRODUCT IDENTIFIER DESCRIPTION

ITEM NUMBER	ORD. MULT.	SELL UNIT	STD. PKG. STOCK AVAILABILITY / PA	LEAD TIME	MIN. ORD.	A C
-------------	------------	-----------	-----------------------------------	-----------	-----------	-----

400006623 BAR DIGGING 6FT CA06715
 1106500 1 EA IL IN MI OH WI 12 12 12 12 12 E
 Used in digging trenches and anchor, man & pole holes, for loosening top soil of frozen ground.

400006631 BAR DIGGING 8FT CA06715
 N EA 1 3 1 E



400006631

400006649 BAR DIGGING 9 1/2FT CA06715
 N EA 1 6 50 E
 Same as PID400006623.

400006805 BAR PRY B CA07668
 1106567 1 EA IL IN MI OH WI 12 12 12 12 12 E
 For use in prying the lower case of the large mechanical splice closure from cable when removing a splice closure, BSP 633-460-210.



1106567

900208232 BAR PRY CHISEL STRAIGHT 36IN
 N EA 1 4 1 E
 All steel pry bar, tapered at one end. Dickie Tool.

260439872 BAR PRY #808
 N EA 1 2 1
 Air impact tool parts.

400006847 BAR TAMPING CURVED HEAD CA06891
 1106583 1 EA IL IN MI OH WI 12 12 12 12 12 E
 Used for tamping around small poles and pole holes in rural lines.



1106583

900208166 BAR WRECKING 3/4IN X 24IN
 1101030 1 EA IL IN MI OH WI 12 12 12 12 12 E
 For use in removing brackets from poles, bags from cable reels and opening packing boxes.



1101030

BATTERY

002086999 BATTERY 1.35 VOLT MERCURY RM12R
 1228064 1 EA E

PRODUCT IDENTIFIER DESCRIPTION

ITEM NUMBER	ORD. MULT.	SELL UNIT	STD. PKG. STOCK AVAILABILITY / PA	LEAD TIME	MIN. ORD.	A C
-------------	------------	-----------	-----------------------------------	-----------	-----------	-----

996444808 BATTERY 1.4 VOLTS MERCURY AA
 N EA 24 3 144

402188023 BATTERY 1.5 VOLTS ALKALINE AA
 1178574 1 EA IL IN MI OH WI 12 12 12 12 12 E
 For use with Bellboy units.

402425052 BATTERY 1.5 VOLTS ALKALINE AAA
 1966804 1 EA IL IN MI OH WI 12 12 12 12 12 E

401743398 BATTERY 1.5 VOLTS ALKALINE C
 4191064 1 EA IL IN MI OH WI 12 12 12 12 12 E
 For use in test sets.

402856033 BATTERY 1.5 VOLTS ALKALINE D
 1216614 1 EA IL IN MI OH WI 12 12 12 12 12 E
 To be used in test sets also as heavy duty replacement battery for use with the flashlight, heavy duty, DFF.

997764949 BATTERY 1.5 VOLTS CK14495
 1108225 1 EA IL IN MI OH WI 12 12 12 12 12 E
 Supplies the bias voltage and filament current for Set Test 99B, BSP 157-421-101.

401130794 BATTERY 1.5 VOLTS GP 8
 2671040 1 EA IL IN MI OH WI 12 12 12 12 12 E
 A heavy duty battery used in negative superimposed ringing plants. Used in lieu of CK06542 battery when a heavy duty battery is required.

997326814 BATTERY 1.5 VOLTS GP N
 1218305 1 EA IL IN MI OH WI 12 12 12 12 12 E
 Used in various test sets and for transistor radios. Size 1 1/8in long by 7/16in diameter.

997801006 BATTERY 4.5 VOLTS CK06569
 N EA 10 9 60 E

997801634 BATTERY 4.5 VOLTS CK06570
 1107920 1 EA IL IN MI OH WI 12 12 12 12 12 E
 For test set service. Equipped with thread and nut terminals, package of 60, BSP 157-421-101.

400650008 BATTERY 4.5 VOLTS GP DRY
 2658260 1 EA IL IN MI OH WI 12 12 12 12 12 E
 For use in the Dynatel 710 test set.

401457916 BATTERY 5.6 VOLTS E164 MERCURY
 1136101 1 EA IL IN MI OH WI 12 12 12 12 12 E
 Used with the Hewlett-Packard quik-search hand wand model # 18002-63801.

DISTRIBUTION SERVICES

NETWORK SERVICES

TOOLS

BUILDING JANITORIAL

AUTOMOTIVE

FORMS/OFFICE SUPPLIES

GENERAL

DATA VOICE

DISTRIBUTION SERVICES

NETWORK SERVICES

TOOLS

BUILDING JANITORIAL

AUTOMOTIVE

FORMS/OFFICE SUPPLIES

GENERAL

DATA VOICE

BATTERY

PRODUCT IDENTIFIER DESCRIPTION

ITEM NUMBER	ORD. MULT.	SELL UNIT	STD. PKG. STOCK AVAILABILITY / PA	LEAD TIME	MIN. ORD.	A C
-------------	------------	-----------	-----------------------------------	-----------	-----------	-----

400470787 BATTERY 6.0 VOLTS GP NEDA 915
 1443747 1 EA IL IN MI OH WI E
 12 12 12 12 12

Screw terminal.



1443747

401328968 BATTERY 6.0 VOLTS GP NEDA 920
 6147124 1 EA IL IN MI OH WI E
 12 12 12 12 12

995042207 BATTERY 6.0 VOLTS HD CK14371
 1108209 1 EA IL IN MI OH WI E
 12 12 12 12 12

Transmitter battery two used with 172A test set.
 Also used with hand lantern, package of 25,
 BSP 634-315-502, BSP 157-421-101.

402402515 BATTERY 8.4 VOLTS MERCURY
 1167551 1 EA IL IN MI OH WI E
 12 12 12 12 12

402179139 BATTERY 9.0 VOLTS ALKALINE
 1434068 1 EA IL IN MI OH WI E
 12 12 12 12 12

General purpose for use in transistor radio, used
 in the 188A test set.



1434068

400470761 BATTERY 9.0 VOLTS GP NEDA 1600
 1107821 1 EA IL IN MI OH WI E
 12 12 12 12 12

Round, terminals on both ends (one end
 positive, one end negative), used in transmission
 test set No. 4TTS.

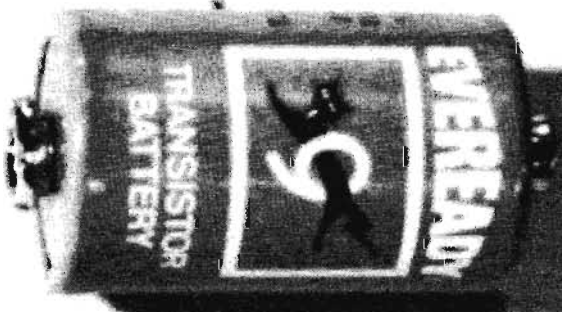

1107821

PRODUCT IDENTIFIER DESCRIPTION

ITEM NUMBER	ORD. MULT.	SELL UNIT	STD. PKG. STOCK AVAILABILITY / PA	LEAD TIME	MIN. ORD.	A C
-------------	------------	-----------	-----------------------------------	-----------	-----------	-----

400973616 BATTERY 9.0 VOLTS GP NEDA 1602
 2670422 1 EA IL IN MI OH WI E
 12 12 12 12 12

For use as B battery in Set Test 146A, BSP
 634-200-504.



2670422

400981304 BATTERY 9.0 VOLTS GP NEDA 1603
 1102137 1 EA IL IN MI OH WI E
 12 12 12 12 12

Used as A Battery in Set Test 146A, BSP
 634-200-504.



1102137

997326806 BATTERY 9.0 VOLTS GP NEDA 1604
 1101055 1 EA IL IN MI OH WI E
 12 12 12 12 12

Used as C battery in the 146A test set, BSP
 634-200-504. DISCONTINUE AND FORWARD
 TO BATTERY 9.0V ALKA UPON STOCK
 DEPLETION



1101055

DISTRIBUTION SERVICES

NETWORK SERVICES

TOOLS

BUILDING JANITORIAL

AUTOMOTIVE

FORMS/OFFICE SUPPLIES

GENERAL

DATA VOICE

PRODUCT IDENTIFIER		DESCRIPTION				
ITEM NUMBER	ORD. MULT.	SELL UNIT	STD. PKG. STOCK AVAILABILITY / PA	LEAD TIME	MIN. ORD.	A C

400902938 BATTERY 9.0 VOLTS GP NEDA 1611
 2774240 1 EA IL IN MI OH WI E
 12 12 12 12 12
 Intended for use in the Pencil Probe Test Set CA8629 L1.



2774240

400470779 BATTERY 9.0 VOLTS GP NEDA 1612
 1101071 1 EA IL IN MI OH WI E
 12 12 12 12 12
 Used for electronic applications.

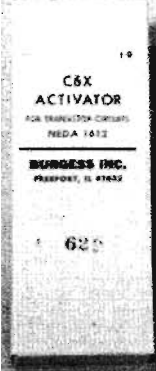

1101071

997326970 BATTERY 15.0 VOLTS GP NEDA 208
 5248146 1 EA IL IN MI OH WI E
 12 12 12 12 12
 Used to power C. O. test equipment.

300035847 BATTERY 22.5 VOLTS ELECTRONIC
 1312579 1 EA IL IN MI OH WI E
 12 12 12 12 12
 Recommended for the plate supply of the 147 type amplifier associated with the 91A test set, BSP 157-421-101.

995042215 BATTERY 22.5 VOLTS GP CK15936
 1108282 1 EA IL IN MI OH WI E
 12 12 12 12 12
 Used with test sets, BSP 157-421-101.

997884309 BATTERY 24.0 VOLTS GP CK06571
 1107946 1 EA IL IN MI OH WI E
 12 12 12 12 12
 For plate battery service equipped with fahnestock terminals, spring clip, package of 20, BSP 157-421-101.

PRODUCT IDENTIFIER		DESCRIPTION				
ITEM NUMBER	ORD. MULT.	SELL UNIT	STD. PKG. STOCK AVAILABILITY / PA	LEAD TIME	MIN. ORD.	A C

997326830 BATTERY 45 VOLT GP
 1107847 1 EA IL IN MI OH WI E
 12 12 12 12 12
 Radio B battery has a female receptacle for a 5 prong male plug built into the battery.

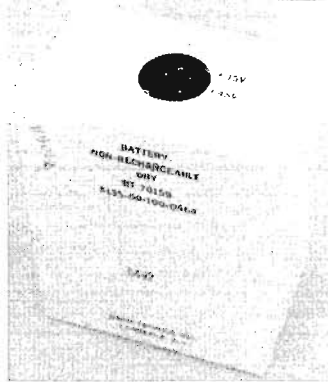

1107847

997326749 BATTERY 45 VOLTS GP
 1169557 1 EA IL IN MI OH WI E
 12 12 12 12 12
 Used with Voltohmmilliameter CK16979 L1.

997300835 BATTERY 45.0 VOLTS CK14370
 1108183 1 EA IL IN MI OH WI E
 12 12 12 12 12
 Plate supply for various portable test sets. Used with B warning flasher, package of 12, BSP 157-421-101.



1108183

400007183 BATTERY 45.0 VOLTS GP CK14196
 1108126 1 EA IL IN MI OH WI E
 12 12 12 12 12
 For use in test sets. Has two 45volt jack contacts, one 22 1/2volt jack contact and two negative commons, 2in X 3in X 4in, BSP 157-421-101.

300040896 BATTERY 45.0 VOLTS GP CK14369
 1313791 1 EA IL IN MI OH WI E
 12 12 12 12 12
 For use in 99B and CK8455 L1 test sets. Has snap type terminals. Size 2 1/2in X 1in X 3 1/2in, BSP 157-421-101.

DISTRIBUTION SERVICES

NETWORK SERVICES

TOOLS

BUILDING JANITORIAL

AUTOMOTIVE

FORMS/OFFICE SUPPLIES

GENERAL

DATA VOICE

BATTERY

PRODUCT IDENTIFIER

DESCRIPTION

ITEM NUMBER	ORD. MULT.	SELL UNIT	STD. PKG. STOCK AVAILABILITY / PA	LEAD TIME	MIN. ORD.	A C
-------------	------------	-----------	-----------------------------------	-----------	-----------	-----

400973624 BATTERY 45.0 VOLTS GP NEDA 213

2658245	1	EA	IL 12	IN 12	MI 12	OH 12	WI 12	E
---------	---	----	-------	-------	-------	-------	-------	---

For use in the Dynatel 710 test set and the Throwmaster test set.



2658245

300031416 BATTERY 67.5 VOLTS GP

1310896	1	EA	IL 12	IN 12	MI 12	OH 12	WI 12	E
---------	---	----	-------	-------	-------	-------	-------	---

Used to power Throwmaster test set.



1310896

300031952 BATTERY KIT SLC-96 BLACK

N	KT	1		4	1			
---	----	---	--	---	---	--	--	--

Kit of 4 batteries with diode assembly. Used in conjunction with the Subscriber Loop Carrier Systems.

BATTERY RECHARGEABLE**260329925 BATTERY RECHARGEABLE 7.2 VOLTS DC**

1946731	1	EA						E
---------	---	----	--	--	--	--	--	---

A rechargeable battery used with Drill Cordless 3/8in Makita 6073DW and Charger Battery Auto 7.2 Volts (1946749). Makita P/N632002-4.

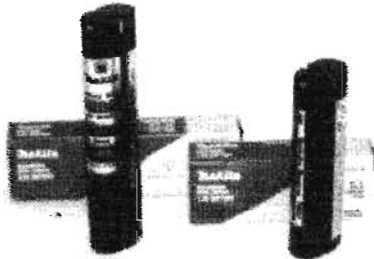

260329925

260377601 BATTERY RECHARGEABLE 9.6 VOLTS DC

1959841	1	EA	IL 12	IN 12	MI 12	OH 12	WI 12	E
---------	---	----	-------	-------	-------	-------	-------	---

A rechargeable battery used with Drill Cordless 3/8in Makita 6093DW (1945723) and Charger Battery Auto 9.6 Volts (1959833).

PRODUCT IDENTIFIER

DESCRIPTION

ITEM NUMBER	ORD. MULT.	SELL UNIT	STD. PKG. STOCK AVAILABILITY / PA	LEAD TIME	MIN. ORD.	A C
-------------	------------	-----------	-----------------------------------	-----------	-----------	-----

BELT**900502139 BELT BUCKET OP 9005 LARGE 46**

1115766	1	EA				E
---------	---	----	--	--	--	---

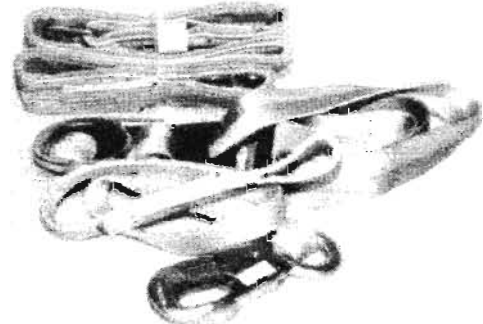

900502139

280021148 BELT ELECTRICIAN WAIST 5207-L

N		EA	6	3	6	E
---	--	----	---	---	---	---

300085156 BELT LANYARD 3834

N		EA	1	2	2	E
---	--	----	---	---	---	---

1/2in X 4in nylon rope lanyard used with Belt Worker Aerial 3808 Large (300085164).

400010229 BELT POUCH B CA07397

1108803	1	EA	IL 12	IN 12	MI 12	OH 12	WI 12	E
---------	---	----	-------	-------	-------	-------	-------	---

For use by station installers and repairmen for carrying a tool pouch and a handset.



1108803

300080454 BELT TOOL J300

1333427	1	EA	IL 12	IN 12	MI 12	OH 12	WI 12	E
---------	---	----	-------	-------	-------	-------	-------	---



1333427

300085164 BELT WORKER AERIAL 3808 LARGE

N		EA	1	2	1	E
---	--	----	---	---	---	---

Belt used in aerial bucket.

DISTRIBUTION SERVICES

NETWORK SERVICES

TOOLS

BUILDING JANITORIAL

AUTOMOTIVE

FORMS/OFFICE SUPPLIES

GENERAL

DATA VOICE

PRODUCT IDENTIFIER		DESCRIPTION				
ITEM NUMBER	ORD. MULT.	SELL UNIT	STD. PKG. STOCK AVAILABILITY / PA	LEAD TIME	MIN. ORD.	A C

BELT BODY

280018615			BELT BODY 960-28 RT			
N		EA	1	2	1	E

BELT BODY D

CA08426 L3. BSP 081-721-101.

401655212			BELT BODY D LEFT SIDE 18IN			
N		EA	6	3	6	E
401655220			BELT BODY D LEFT SIDE 20IN			
N		EA	6	3	6	E
401655238			BELT BODY D LEFT SIDE 22IN			
N		EA	6	3	6	E
401655246			BELT BODY D LEFT SIDE 24IN			
N		EA	6	3	6	E
401655253			BELT BODY D LEFT SIDE 26IN			
N		EA	6	3	6	E
401655261			BELT BODY D LEFT SIDE 28IN			
N		EA	6	3	6	E
400471181			BELT BODY D RIGHT SIDE 18IN			
N		EA	6	3	6	E

400471207			BELT BODY D RIGHT SIDE 20IN			
3346767	1	EA	IL IN MI OH WI 12 12 12 12 12			E

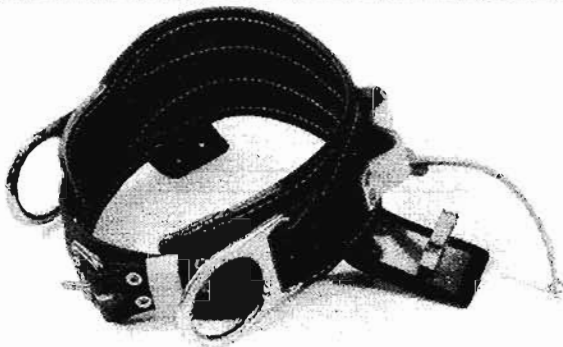

3346767

400974192			BELT BODY D RIGHT SIDE 26IN			
N		EA	6	3	6	E
400974200			BELT BODY D RIGHT SIDE 28IN			
N		EA	6	3	6	E

BELT BODY E

CA08426 L3. Has 4 small D-Rings for use with Suspenders 6258 Adjustable (PID900315110), BSP 081-721-101.

401655279			BELT BODY E LEFT SIDE 18IN			
N		EA	6	3	6	E

PRODUCT IDENTIFIER		DESCRIPTION				
ITEM NUMBER	ORD. MULT.	SELL UNIT	STD. PKG. STOCK AVAILABILITY / PA	LEAD TIME	MIN. ORD.	A C

401655287			BELT BODY E LEFT SIDE 20IN			
N		EA	6	3	6	E
401655295			BELT BODY E LEFT SIDE 22IN			
N		EA	6	3	6	E
401655303			BELT BODY E LEFT SIDE 24IN			
N		EA	6	3	6	E
401655311			BELT BODY E LEFT SIDE 26IN			
N		EA	6	3	6	E
401655329			BELT BODY E LEFT SIDE 28IN			
N		EA	6	3	6	E
400471074			BELT BODY E RIGHT SIDE 18IN			
N		EA	6	3	6	E

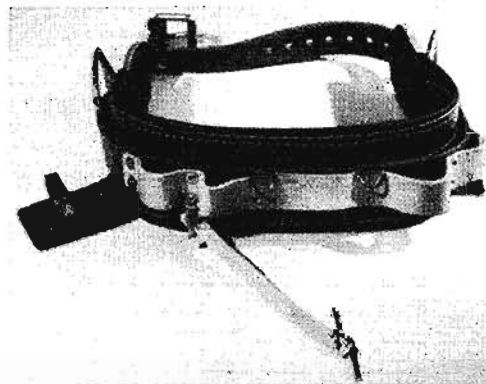

400471074

400471082			BELT BODY E RIGHT SIDE 20IN			
1969980	1	EA	IL IN MI OH WI 12 12 12 12 12			E

400471090			BELT BODY E RIGHT SIDE 22IN			
1170878	1	EA	IL IN MI OH WI 12 12 12 12 12			E

400471108			BELT BODY E RIGHT SIDE 24IN			
1153296	1	EA	IL IN MI OH WI 12 12 12 12 12			E

400974218			BELT BODY E RIGHT SIDE 26IN			
5286708	1	EA	IL IN MI OH WI 12 12 12 12 12			E

400974226			BELT BODY E RIGHT SIDE 28IN			
N		EA	6	3	6	E

BELT BODY F

CA08444. A light weight belt made of six ply nylon cloth impregnated with neoprene and bonded together, used by installation and repair forces only. NOT TO BE USED BY LINE FORCES

BSP 081-721-101.

400471140			BELT BODY F SIZE 22IN			
N		EA	6	3	6	E

DISTRIBUTION SERVICES

BELT BODY F

PRODUCT IDENTIFIER		DESCRIPTION					
ITEM NUMBER	ORD. MULT.	SELL UNIT	STD. PKG. STOCK AVAILABILITY / PA	LEAD TIME	MIN. ORD.	A	C
400471157		BELT BODY F SIZE 24IN					
N		EA	6	3	6	E	
400979159		BELT BODY F SIZE 26IN					
N		EA	6	3	6	E	

NETWORK SERVICES

BIT

400996468		BIT BELL HANGER 824T 1/2IN					
N		EA	6	3	18	E	
900207580		BIT BELL HANGER C 818T 1/4IN					
1937458	1	EA	IL IN MI OH WI			E	
			12 12 12 12 12				

A Carbide Tipped Bit for use in a Hand Brace,



1937458

TOOLS

402377477		BIT DRILL MASONRY .195 X 4 1/2IN					
1404129	1	EA	IL IN MI OH WI			E	
			12 12 12 12 12				

CA08900, 1/2in drive.

400011078		BIT EXPANSIVE LARGE CA06394					
1110007	1	EA	IL IN MI OH WI			E	
			12 12 12 12 12				

Package of 2. Furnished with two cutters for boring 7/8in, 1 3/4in, and 3in holes through boards, BSP 074-205-114.

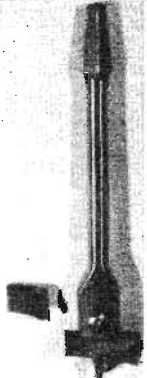

1110007

BUILDING JANITORIAL

400011060		BIT EXPANSIVE SMALL CA06394					
N		EA	6	3	18	E	

401330964		BIT EXTENSION 24IN					
1143933	1	EA	IL IN MI OH WI			E	
			12 12 12 12 12				

Greenlee 902. For extending the length of the auger, BSP 630-310-100.



1143933

GENERAL

400011094		BIT INSULATOR 11/16IN CA06393					
N		EA	6	3	24	E	

400011102		BIT INSULATOR 1 1/4IN CA06393					
N		EA	3	3	15	E	

DATA VOICE

PRODUCT IDENTIFIER		DESCRIPTION					
ITEM NUMBER	ORD. MULT.	SELL UNIT	STD. PKG. STOCK AVAILABILITY / PA	LEAD TIME	MIN. ORD.	A	C

002047116		BIT MASONRY 3/16IN HEAVY DUTY					
4195925	1	PK	IL IN MI OH WI			E	
			12 12 12 12 12				

Carbon Tipped Bit. Use with a Drill Automatic B (1215491) or with a Yankee Drill.

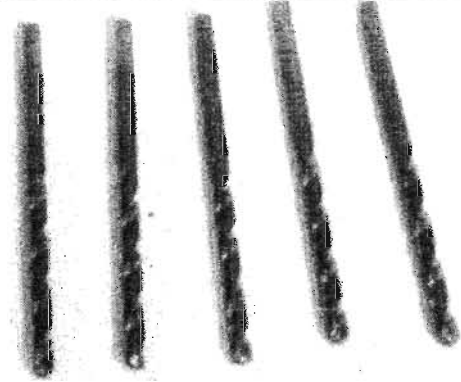

4195925

402377444		BIT MASONRY .164 X 3IN					
1404103	1	EA	IL IN MI OH WI			E	
			12 12 12 12 12				

1/2in drive.

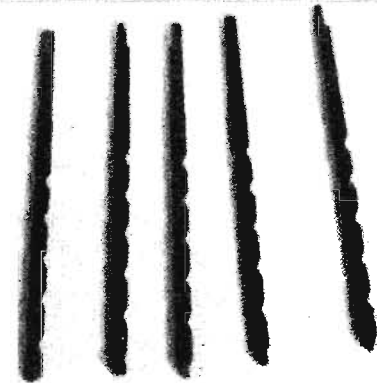

1404103

260353453		BIT REPLACEMENT 950C					
1951897	1	EA	IL IN MI OH WI			E	
			12 12 12 12 12				

Replacement Head for Tool 950C (1951889).



1951897

DISTRIBUTION SERVICES

NETWORK SERVICES

TOOLS

BUILDING JANITORIAL

AUTOMOTIVE

FORMS/OFFICE SUPPLIES

GENERAL

DATA VOICE

PRODUCT IDENTIFIER		DESCRIPTION						
ITEM NUMBER	ORD. MULT.	SELL UNIT	STD. PKG. STOCK AVAILABILITY / PA	LEAD TIME	MIN. ORD.	A C		
400011292 BIT SCREWDRIVER 3/8IN CA06597								
1101170	1	EA	IL 12	IN 12	MI 12	OH 12	WI 12	E
Use with Brace Ratchet (1168955) for placing and/or removing large screws, BSP 074-205-114.								



1101170

400011300	N	EA	6	3	18	E	
-----------	---	----	---	---	----	---	--

PRODUCT IDENTIFIER		DESCRIPTION						
ITEM NUMBER	ORD. MULT.	SELL UNIT	STD. PKG. STOCK AVAILABILITY / PA	LEAD TIME	MIN. ORD.	A C		
400010773 BIT AUGER SOLID CENTER 16/16IN								
N		EA	6	3	24	E		
400010781 BIT AUGER SOLID CENTER 20/16IN								
N		EA	3	3	18	E		

BIT CONSTRUCTION

900113978 BIT CONSTRUCTION CARBON #7							
N		EA	6	3	18	E	Electric 35T.

BIT AUGER

CA06396. Standard wood boring bits for pole steps and general use, BSP 081-745-105.

900208877 BIT AUGER SC 312R12 PIT 16							
1181750	1	EA					E



900208877

900304635 BIT AUGER SC 512R12 PIT 16							
N		EA	6	3	12	E	Short round shank.

PRODUCT IDENTIFIER		DESCRIPTION						
ITEM NUMBER	ORD. MULT.	SELL UNIT	IL	IN	MI	OH	WI	A C
400010666 BIT AUGER SOLID CENTER 04/16IN								
1109447	1	EA	12	12	12	12	12	E



1109447

400010674	N	EA	6	3	30	E	
-----------	---	----	---	---	----	---	--

400010690	N	EA	6	3	30	E	
-----------	---	----	---	---	----	---	--

PRODUCT IDENTIFIER		DESCRIPTION						
ITEM NUMBER	ORD. MULT.	SELL UNIT	IL	IN	MI	OH	WI	A C
400010708 BIT AUGER SOLID CENTER 08/16IN								
1109504	1	EA	12	12	12	12	12	E

400010716	N	EA	6	3	30	E	
-----------	---	----	---	---	----	---	--

400010724	N	EA	6	3	24	E	
-----------	---	----	---	---	----	---	--

400010732	N	EA	6	3	24	E	
-----------	---	----	---	---	----	---	--

400010740	N	EA	6	3	24	E	
-----------	---	----	---	---	----	---	--

400010757	N	EA	6	3	24	E	
-----------	---	----	---	---	----	---	--

400010765	N	EA	6	3	24	E	
-----------	---	----	---	---	----	---	--

BIT CONSTRUCTION HC

CA06392. HC - Means that auger has a Hollow Center.

400010799 BIT CONSTRUCTION HC 6/16 X 12IN							
N		EA	6	3	18	E	

400010815 BIT CONSTRUCTION HC 8/16 X 12IN							
N		EA	6	3	18	E	

400010849 BIT CONSTRUCTION HC 11/16 X 12IN							
N		EA	6	3	18	E	

400010807 BIT CONSTRUCTION HC 6/16 X 18IN							
N		EA	6	3	18	E	

400010823 BIT CONSTRUCTION HC 8/16 X 18IN							
N		EA	6	3	18	E	

400010856 BIT CONSTRUCTION HC 11/16 X 18IN							
N		EA	6	3	18	E	

400010864 BIT CONSTRUCTION HC 12/16 X 18IN							
N		EA	6	3	18	E	

400010880 BIT CONSTRUCTION HC 13/16 X 18IN							
N		EA	6	3	18	E	

BIT CONSTRUCTION SC

CA06392. SC - Means that auger has a Solid Center, BSP 081-745-105.

400010898 BIT CONSTRUCTION SC 4/16 X 12IN							
N		EA	6	3	24	E	

400010914 BIT CONSTRUCTION SC 6/16 X 12IN							
N		EA	6	3	24	E	

400010930 BIT CONSTRUCTION SC 7/16 X 12IN							
N		EA	6	3	24	E	

400010948 BIT CONSTRUCTION SC 8/16 X 12IN							
N		EA	6	3	24	E	

400010989 BIT CONSTRUCTION SC 11/16 X 12IN							
N		EA	6	3	18	E	

BIT CONSTRUCTION SC

PRODUCT IDENTIFIER		DESCRIPTION					A
ITEM NUMBER	ORD. MULT.	SELL UNIT	STD. PKG. STOCK AVAILABILITY / PA	LEAD TIME	MIN. ORD.		C
400011003			BIT CONSTRUCTION SC	12/16 X 12IN			
N		EA	6	3	18		E
400010906			BIT CONSTRUCTION SC	4/16 X 18IN			
N		EA	6	3	18		E
400010922			BIT CONSTRUCTION SC	6/16 X 18IN			
N		EA	6	3	18		E
400010955			BIT CONSTRUCTION SC	8/16 X 18IN			
1109801	1	EA	IL IN MI OH WI 12 12 12 12 12				E

Used for 3/8in drop wire entry plastic tubes. BSP 081-745-105.



1109801

400010963			BIT CONSTRUCTION SC	9/16 X 18IN			
N		EA	6	3	18		E
400010971			BIT CONSTRUCTION SC	10/16 X 18IN			
1109843	1	EA	IL IN MI OH WI 12 12 12 12 12				E

Used for 1/2in drop wire entry plastic tubes. BSP 081-745-105.

400010997			BIT CONSTRUCTION SC	11/16 X 18IN			
1156695	1	EA	IL IN MI OH WI 12 12 12 12 12				E

Used for 5/8in bolts, BSP 081-745-105.

400011011			BIT CONSTRUCTION SC	12/16 X 18IN			
1109926	1	EA	IL IN MI OH WI 12 12 12 12 12				E

Used for 3/8in drop wire entry porcelain tubes and 5/8in plastic tubes, BSP 081-745-105.

400011037			BIT CONSTRUCTION SC	13/16 X 18IN			
N		EA	6	3	18		E
400011045			BIT CONSTRUCTION SC	17/16 X 18IN			
N		EA	6	3	12		E
400011052			BIT CONSTRUCTION SC	20/16 X 18IN			
N		EA	3	3	9		E

BIT EXTENSION D

CA07764. Drill bits for boring holes in wood where other material such as metal, lath, nails etc., may be encountered, BSP 081-745-105.

400137774			BIT EXTENSION D	1/2IN X 18IN			
1102368	1	EA					E



400137774

PRODUCT IDENTIFIER		DESCRIPTION					A
ITEM NUMBER	ORD. MULT.	SELL UNIT	STD. PKG. STOCK AVAILABILITY / PA	LEAD TIME	MIN. ORD.		C
400137709			BIT EXTENSION D	1/4IN X 18IN			
1192559	1	EA	IL IN MI OH WI 12 12 12 12 12				E
400137717			BIT EXTENSION D	1/4IN X 24IN			
1173385	1	EA	IL IN MI OH WI 12 12 12 12 12				E
400137725			BIT EXTENSION D	1/4IN X 30IN			
1204974	1	EA	IL IN MI OH WI 12 12 12 12 12				E
400137782			BIT EXTENSION D	3/4IN X 18IN			
1104075	1	EA	IL IN MI OH WI 12 12 12 12 12				E
400137741			BIT EXTENSION D	3/8IN X 18IN			
1102376	1	EA	IL IN MI OH WI 12 12 12 12 12				E
400137758			BIT EXTENSION D	3/8IN X 24IN			
1215996	1	EA	IL IN MI OH WI 12 12 12 12 12				E

BIT EXTENSION E

CA07764. IS2. Drill bits used with the Drill Electric B, is not equipped with a shank (known as installers drills), BSP 081-745-105.

400137824			BIT EXTENSION E	1/2IN X 18IN			
1189852	1	EA					E



400137824

400137808			BIT EXTENSION E	1/4IN X 18IN			
1158436	1	EA	IL IN MI OH WI 12 12 12 12 12				E

400137832			BIT EXTENSION E	3/4IN X 18IN			
1136879	1	EA	IL IN MI OH WI 12 12 12 12 12				E

400137816			BIT EXTENSION E	3/8IN X 18IN			
1175455	1	EA	IL IN MI OH WI 12 12 12 12 12				E

BIT POWER

001186246			BIT POWER	11/16IN X 18IN			
4262782	1	EA					E

Power construction bit equipped with 5/8in Hex Shank used to bore holes in wooden poles.



001186246

DISTRIBUTION SERVICES

NETWORK SERVICES

TOOLS

BUILDING JANITORIAL

AUTOMOTIVE

FORMS/OFFICE SUPPLIES

GENERAL

DATA VOICE

DISTRIBUTION SERVICES

NETWORK SERVICES

TOOLS

BUILDING JANITORIAL

AUTOMOTIVE

FORMS/OFFICE SUPPLIES

GENERAL

DATA VOICE

PRODUCT IDENTIFIER		DESCRIPTION				
ITEM NUMBER	ORD. MULT.	SELL UNIT	STD. PKG. STOCK AVAILABILITY / PA	LEAD TIME	MIN. ORD.	A C

BIT POWER B

CA08123. Used with a Wrench Impact for boring holes through poles and log anchors. Each bit has a single spur and cutter, lead shank to fit the wrench.

400011110			BIT POWER B SOLID 7/16 X 12			
N		EA	6	3	12	E
400011151			BIT POWER B SOLID 11/16 X 18			
N		EA	6	3	12	E
400011169			BIT POWER B SOLID 13/16 X 12			
N		EA	6	3	12	E
400011177			BIT POWER B SOLID 13/16 X 18			
N		EA	6	3	12	E

BIT POWER C

CA08123. Used with Wrench Impact C for boring holes through poles and log anchors. Each bit has a single spur and cutter, lead shank to fit the wrench.

400011201			BIT POWER C HOLLOW 7/16 X 12			
N		EA	6	3	12	E
 400011201						
400011227			BIT POWER C HOLLOW 8/16 X 12			
N		EA	6	3	12	E
400011235			BIT POWER C HOLLOW 11/16 X 12			
N		EA	6	3	12	E
400011243			BIT POWER C HOLLOW 11/16 X 18			
N		EA	6	3	12	E
400011268			BIT POWER C HOLLOW 13/16 X 18			
N		EA	6	3	12	E

BIT WIREWRAP

996811378			BIT WIREWRAP 22-24 GAUGE CK16734 L1			
1110429	1	EA				E
Used in making solderless wrapped connections on 22&24GA wire, has a red band, Use with Tool Wire Wrap CK16363 L3 (1135467) and Sleeve Wirewrap 22-24 Gauge CK20963 L2 (2786285), BSP 074-205-114.						

996811378

400011334			BIT WIREWRAP 26 GAUGE CK16903 L1			
1110445	1	EA	IL IN MI OH WI			E
 12 12 12 12 12						
For use in making solderless wrapped connections on 26 gauge wire, has a green band, BSP 074-205-114.						

PRODUCT IDENTIFIER		DESCRIPTION				
ITEM NUMBER	ORD. MULT.	SELL UNIT	STD. PKG. STOCK AVAILABILITY / PA	LEAD TIME	MIN. ORD.	A C

900207432 BIT WIREWRAP 26-36 GAUGE 507100

1174771	1	EA	IL IN MI OH WI			E
 12 12 12 12 12						

1174771

280027293 BIT WIREWRAP 28 GAUGE WB28SHM

N		EA	1	2	1	E
---	--	----	---	---	---	---

280020702 BIT WIREWRAP 30 GAUGE 501381

N		EA	1	2	1	E
---	--	----	---	---	---	---

A solderless wrapping bit used with Sleeve Wirewrap 24-26 Gauge 512056 (PID# 280020884). 30 AWG Horseshoe C bore type-modified wrap.

280020710 BIT WIREWRAP 30 GAUGE 507063

N		EA	1	2	1	E
---	--	----	---	---	---	---

A solderless wrapping bit used with Sleeve Wirewrap 28-32 Gauge 507100 (PID280020892). 30 AWG Horseshoe C bore type-modified wrap.

300085172 BIT WIREWRAP 30 GAUGE SB30MSH-B

N		EA	1	2	1	E
---	--	----	---	---	---	---

An accessory used with Tool Wire Wrap 27600 (1951087).

280026923 BIT WIREWRAP 30 GAUGE WB30SHM

N		EA	1	2	1	E
---	--	----	---	---	---	---

260446968 BIT WIREWRAP R3711

N						
---	--	--	--	--	--	--

BLADE

100751239 BLADE 266C WIRE BURNISHING

1275503	1	EA				E
---------	---	----	--	--	--	---

DISCONTINUE UPON STOCK DEPLETION

842330458 BLADE 1A

N		EA	1	3	1	E
---	--	----	---	---	---	---

260300421 BLADE CENTER PUNCH

N		EA	1	3	1	E
---	--	----	---	---	---	---

260436787 BLADE CUTTER AIR PIPE

N		PK	1	3	1	
---	--	----	---	---	---	--

Replacement blades for the Air Pipe Cutter. 2 per pack.

401915855 BLADE FOR SLITTER WEB B

1403220	1	EA	IL IN MI OH WI			E
 12 12 12 12 12						

CA08273. Steel replacement blade for Slitter Web B (1262287). It is used to cut the web between the strand and the jacketed core of a self supporting cable.

1403220

DISTRIBUTION SERVICES

NETWORK SERVICES

TOOLS

BUILDING JANITORIAL

AUTOMOTIVE

FORMS/OFFICE SUPPLIES

GENERAL

DATA VOICE

BLADE

PRODUCT IDENTIFIER DESCRIPTION

ITEM NUMBER	ORD. MULT.	SELL UNIT	STD. PKG. STOCK AVAILABILITY / PA	LEAD TIME	MIN. ORD.	A C
-------------	------------	-----------	-----------------------------------	-----------	-----------	-----

400011466 BLADE HACKSAW 18 TEETH KEYHOLE
 1101196 1 EA IL IN MI OH WI 12 12 12 12 12 E
 7726. Used for cutting hard and soft woods, nonferrous metals and rubber floor duct.

900114059 BLADE HACKSAW 24 TEETH 10IN
 1110502 1 EA IL IN MI OH WI 12 12 12 12 12 E
 Hacksaw blade has 24 teeth per inch and is effective on thin sections of metal, BSP 074-520-101.

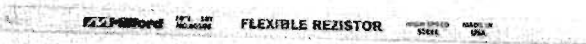

1110502

400011441 BLADE HACKSAW B 18 TEETH
 1110486 1 EA IL IN MI OH WI 12 12 12 12 12 E
 CA08176. Hacksaw blade has 18 teeth per inch, BSP 074-520-101.

402024681 BLADE NO 8762D 66 CA08762
 1121608 1 EA IL IN MI OH WI 12 12 12 12 12 E
 Use with Handle Tool Impact D814, to make connections on 66 type blocks, BSP 080-127-100.



1121608

402024699 BLADE NO 8762D 88 CA08762
 1102145 1 EA IL IN MI OH WI 12 12 12 12 12 E
 Use with Handle Tool Impact D814, to make connections on 88/108 type blocks, BSP 080-127-100.

402024707 BLADE NO 8762D 630 CA08762
 1121624 1 EA IL IN MI OH WI 12 12 12 12 12 E
 Use with Handle Tool Impact D814, to make connections on 630 type blocks, BSP 080-127-100.



1121624

300077179 BLADE REPLACEMENT KIT WCB-11K
 5124016 1 EA IL IN MI OH WI 12 12 12 12 12 E
 Replacement blades used with the Tool Cutter Washer WCT-11K (5124024).



5124016

280020728 BLADE REPLACEMENT L-7486
 N PK 1 2 1 E
 Package of 2. For Ideal Stripper 45-127, 45-128 & 45-129.

PRODUCT IDENTIFIER DESCRIPTION

ITEM NUMBER	ORD. MULT.	SELL UNIT	STD. PKG. STOCK AVAILABILITY / PA	LEAD TIME	MIN. ORD.	A C
-------------	------------	-----------	-----------------------------------	-----------	-----------	-----

260392162 BLADE REPLACEMENT STRIPPER FIBER OPTIC
 N EA 1 4 1 E
 Used with Stripper Fibre Optic OCS-100 (PID260392147) or OCS-200 (PID260392154).

002057651 BLADE SAFETY WIRE SLITTER 5/PK
 1225151 1 PK IL IN MI OH WI 12 12 12 12 12 E
 Additional blades for Slitter Wire Drop (1220293).

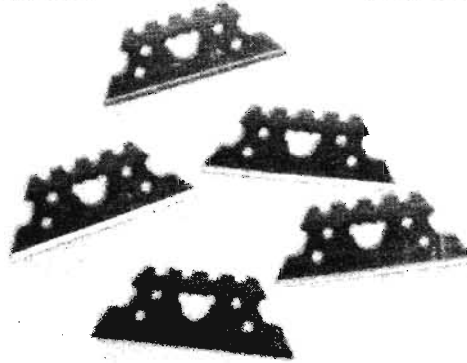

1225151

260324025 BLADE SAW PRUNING SB NO 2
 1944546 1 EA IL IN MI OH WI 12 12 12 12 12 E
 Attaches to Pruner Tree B, BSP 620-310-100.



1944546

002047009 BLADE SEGMENTED C-7330
 N EA 1 6 3 E
 Segmented blade used in 710 modular cutter pressers.

900684697 BLADE UP-5047
 5320861 1 PK IL IN MI OH WI 12 12 12 12 12 E
 For Slitter Wire UP-B36 (1191619), Package of 5.

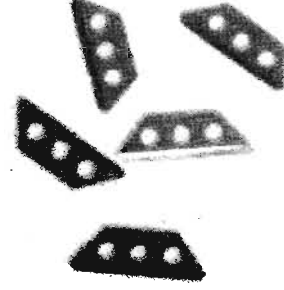

5320861

BLANKET

400011615 BLANKET RUBBER 72IN X 72IN
 1183046 1 EA CA06651. Used by Cable Splicers. E

DISTRIBUTION SERVICES

NETWORK SERVICES

TOOLS

BUILDING JANITORIAL

AUTOMOTIVE

FORMS/OFFICE SUPPLIES

GENERAL

DATA VOICE

PRODUCT IDENTIFIER DESCRIPTION

ITEM NUMBER	ORD. MULT.	SELL UNIT	STD. PKG. STOCK AVAILABILITY / PA	LEAD TIME	MIN. ORD.	A C
-------------	------------	-----------	-----------------------------------	-----------	-----------	-----

400407706 BLANKET RUBBER INSULATED
 1132035 1 EA IL IN MI OH WI 12 12 12 12 12 E
 CA07333X. Blanket Linemans B 36in x 36in. Used as temperature insulating wrapping on poles, BSP 081-710-100.

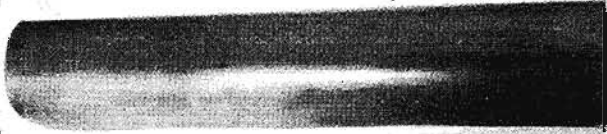

1132035

BLOCK

401005632 BLOCK CABLE D 7268
 N EA 1 2 1 E
 Supports aerial cable to 2 3/4in diameter on suspension strand prior to fashing cable. WT. 3 3/4lbs.

BLOCK SNATCH ROPE

400011961 BLOCK SNATCH ROPE 6FT MANILA
 1112409 1 EA E
 CA06426. Used in conjunction with general pulling and lifting operations, BSP 081-510-203.

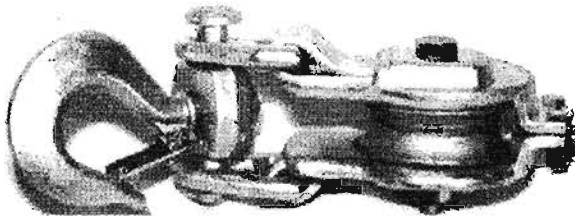

400011961

BLOCK TACKLE

401329453 BLOCK TACKLE 1802 30
 1112466 1 EA E



401329453

PRODUCT IDENTIFIER DESCRIPTION

ITEM NUMBER	ORD. MULT.	SELL UNIT	STD. PKG. STOCK AVAILABILITY / PA	LEAD TIME	MIN. ORD.	A C
-------------	------------	-----------	-----------------------------------	-----------	-----------	-----

400012043 BLOCK TACKLE 3IN DB W/SHACKLE
 4107805 1 EA IL IN MI OH WI 12 12 12 12 E
 CA06552 - A 3in tackle block with a shackle, two sheaves and hooks, maximum load 1000lbs, BSP 081-510-203.

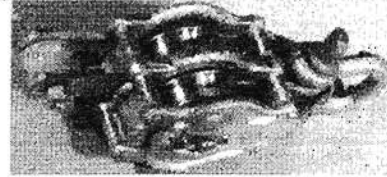

4107805

400012027 BLOCK TACKLE 3IN DOUBLE W/HOOK
 N EA 1 8 7 E
 Tackle block with 2 sheaves and hooks, BSP 081-510-203.

BLOWER

260383047 BLOWER ELECTRIC 2351 12-VOLT DC
 N EA 1 2 1 E

BOARD TEST

400012274 BOARD TEST FIBER B CA07812
 1112763 1 EA E
 Rigid test board 10 3/8in X 2in numbered 1-50 for tagging identified pairs of even count cables, BSP 106-310-100.

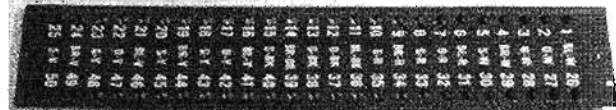

400012274

400012282 BOARD TEST FIBER C CA07812
 1112789 1 EA IL IN MI OH WI 12 12 12 12 E
 Rigid test board 10 3/8in X 2in numbered 51-100 for tagging identified pairs of even count cables, BSP 106-310-100.



1112789

BOND

PRODUCT IDENTIFIER		DESCRIPTION				
ITEM NUMBER	ORD. MULT.	SELL UNIT	STD. PKG. STOCK AVAILABILITY / PA	LEAD TIME	MIN. ORD.	A C

BOND

400014254 BOND TEMPORARY B CA07781

1181891 1 EA E

A 5FT rubber covered cord with battery clips on each end, used to prevent electrical shock from street light fixtures. Used with Bag Storage C (1101014), BSP 620-105-010.



400014254

BOOT

Yellow, 18in high.

300052164 BOOT OVER THE SHOE SIZE 9

1144428 1 PR E

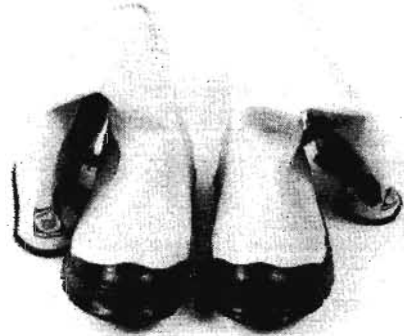

300052164

300052172 BOOT OVER THE SHOE SIZE 10

1161257 1 PR E
IL IN MI OH WI
12 12 12 12 12

300052180 BOOT OVER THE SHOE SIZE 11

1224774 1 PR E
IL IN MI OH WI
12 12 12 12 12

300052198 BOOT OVER THE SHOE SIZE 12

1216812 1 PR E
IL IN MI OH WI
12 12 12 12 12

300052206 BOOT OVER THE SHOE SIZE 13

1153551 1 PR E
IL IN MI OH WI
12 12 12 12 12

300052214 BOOT OVER THE SHOE SIZE 14

1149450 1 PR E
IL IN MI OH WI
12 12 12 12 12

300052222 BOOT OVER THE SHOE SIZE 15

1980979 1 PR E
IL IN MI OH WI
12 12 12 12 12

PRODUCT IDENTIFIER		DESCRIPTION				
ITEM NUMBER	ORD. MULT.	SELL UNIT	STD. PKG. STOCK AVAILABILITY / PA	LEAD TIME	MIN. ORD.	A C

300052230 BOOT OVER THE SHOE SIZE 16

1136937 1 PR E
IL IN MI OH WI
12 12 12 12 12

BOOT HOOK

402888499 BOOT HOOK LIFTING R4940

N EA 1 2 1 E

BOOT RUBBER A1501

Steel toe and shank for safety, construction forces only.

280099169 BOOT RUBBER STEEL TOE SIZE 7

N PR 1 2 1 E

280099177 BOOT RUBBER STEEL TOE SIZE 8

N PR 1 2 1 E

300043544 BOOT RUBBER STEEL TOE SIZE 9

N PR 1 2 1 E

280099185 BOOT RUBBER STEEL TOE SIZE 10

N PR 1 2 1 E

280099193 BOOT RUBBER STEEL TOE SIZE 11

N PR 1 2 1 E

280099201 BOOT RUBBER STEEL TOE SIZE 12

N PR 1 2 1 E

280099219 BOOT RUBBER STEEL TOE SIZE 13

N PR 1 2 1 E

280099227 BOOT RUBBER STEEL TOE SIZE 14

N PR 1 2 1 E

BOOT STORMKING

401332432 BOOT STORMKING A1050 BLACK SIZE 8

N PR 1 1 E



401332432

401332440 BOOT STORMKING A1050 BLACK SIZE 9

N PR 1 4 2 E

DISTRIBUTION SERVICES

NETWORK SERVICES

TOOLS

BUILDING JANITORIAL

AUTOMOTIVE

FORMS/OFFICE SUPPLIES

GENERAL

DATA VOICE

PRODUCT IDENTIFIER		DESCRIPTION				
ITEM NUMBER	ORD. MULT.	SELL UNIT	STD. PKG. STOCK AVAILABILITY / PA	LEAD TIME	MIN. ORD.	A C
401332457		PR	1	4	2	E
BOOT STORMKING A1050 BLACK SIZE 10						
N						
401332465		PR	1	4	2	E
BOOT STORMKING A1050 BLACK SIZE 11						
N						
401332473		PR	1		1	E
BOOT STORMKING A1050 BLACK SIZE 12						
N						

BOX						
280015892		EA	1	2	1	E
BOX ASSEMBLY LG/SM TOOL & HANGER						
N						
			901010.			

BOX PLASTIC M818								
3324764	1	EA	IL	IN	MI	OH	WI	E
			12	12	12	12	12	

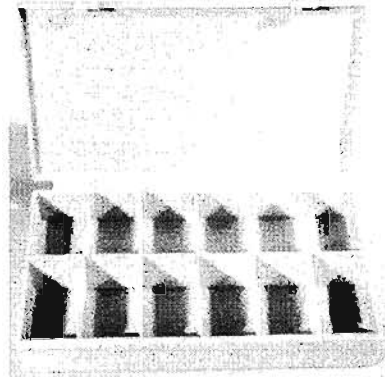

3324764

280020512		EA	1	2	1	E
BOX UTILITY 1083T						
N						
280020520		EA	1	2	1	E
BOX UTILITY 4383T						
N						
280021015		EA	1	2	1	E
BOX UTILITY TII 160						
N						

BRACE RATCHET						
400017059		EA				E
1168955 1						
Used with wood boring bit for boring holes in poles/trees for guying purposes. Use with Wrench Socket Brace Bit 1/4in (1294082) or 5/16in (1294108) for removing lag bolts from poles, BSP 620-310-100.						

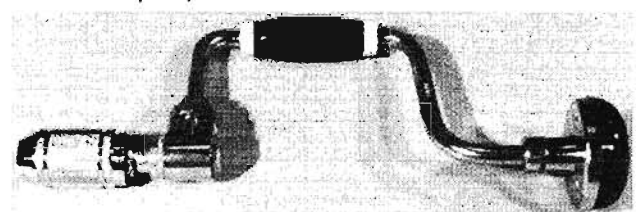

400017059

PRODUCT IDENTIFIER		DESCRIPTION				
ITEM NUMBER	ORD. MULT.	SELL UNIT	STD. PKG. STOCK AVAILABILITY / PA	LEAD TIME	MIN. ORD.	A C
BRACKET						
280056508		EA	1	2	1	E
BRACKET BKT-W HARD HAT HOLDER						
N						
			Wall mount.			

BROOM						
401337886		EA				E
BROOM WAREHOUSE 1C						
1101295	1					
#1299, a regular sweeping broom having a straight wooden handle. For sweeping floors.						



401337886

260300629		EA	1	1	1	E
BROOM WAREHOUSE 32C						
N						

BRUSH						
996606323		EA				E
BRUSH CARDING B CA07262 L1						
1118026	1					
For preparing soldering surface on lead cable sheath. For cleaning files. To scuff plastic sheath. Use with Guard Brush Carding B (1103077), BSP 637-241-200.						

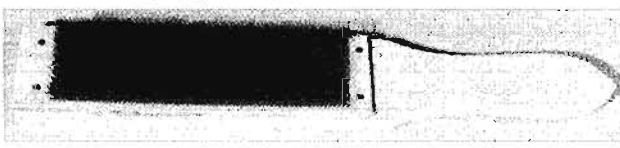

996606323

260447602		EA	12	3	24	E
BRUSH CARDING C C8952						
N						
400021093		EA				E
BRUSH CK14162 17/32 X 1/16IN						
N						

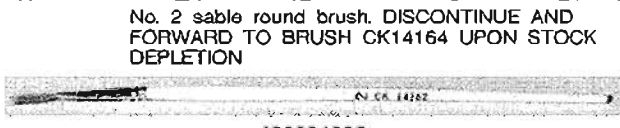

400021093

BRUSH CK14164 3/32 X 11/16IN								
1117945	1	EA	IL	IN	MI	OH	WI	E
			12	12	12	12	12	
A No. 4 sable round brush 3/32in diameter, 11/16in bristles, 6 7/8in overall length, BSP 074-205-138.								



1117945

DISTRIBUTION SERVICES

BRUSH

PRODUCT IDENTIFIER		DESCRIPTION						
ITEM NUMBER	ORD. MULT.	SELL UNIT	STD. PKG. STOCK AVAILABILITY / PA	LEAD TIME			MIN. ORD.	A C

400021119	1	EA	12 12	12 12	12 12	12 12	12 12	E
1117960 BRUSH CK14208 L 1 9/64 X 5/8IN								
Red sable round artists brush, 9/64in diameter, 5/8in bristles, 6 7/8in overall length, BSP 074-205-138.								



1117960

400147229	N	EA	1	3	5	E	CA07346		
400147229 BRUSH HOOK GUARD									

900314071	1	EA	12 12	12 12	12 12	12 12	12 12	E
900314071 BRUSH SASH 08711-025 1IN X 8IN								
DISCONTINUE UPON STOCK DEPLETION								



5136648

900314071	N	EA	1	2	3	CA07272			
900314071 BRUSH SASH 08711-025 345-8 1IN X 8IN									



900314071

400021309	1	EA	12 12	12 12	12 12	12 12	12 12	E
400021309 BRUSH SOAP B								
For applying soap solution used in pressure testing. A rubber stopper over the ferrule, fits the bottom of the wall in the soap bucket, BSP 637-020-100.								



1118281

260304019	N	EA	1	2	1	E	CA07260		
260304019 BRUSH SOLVENT COBRA MS-226									
Attaches to spray nozzle on can for MS-181 to provide efficient metered spray with scrubbing action.									

400021325	1	EA	12 12	12 12	12 12	12 12	12 12	E
400021325 BRUSH TOOL WATER B								
Used with water for cleaning cable terminals. 1in diameter X 2 1/4in length x 7 1/4in overall length.								

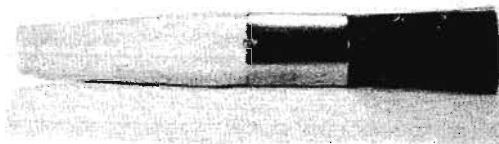

1118307

NETWORK SERVICES

TOOLS

BUILDING JANITORIAL

AUTOMOTIVE

FORMS/OFFICE SUPPLIES

GENERAL

DATA VOICE

PRODUCT IDENTIFIER		DESCRIPTION						
ITEM NUMBER	ORD. MULT.	SELL UNIT	STD. PKG. STOCK AVAILABILITY / PA	LEAD TIME			MIN. ORD.	A C

401005624	1	EA	12 12	12 12	12 12	12 12	12 12	E
401005624 BRUSH WIRE STEEL 36								
For removing old paint, cleaning dirt from iron terminals, etc. 1in wide X 5in long X 10in overall length.								



1333385

BRUSH VARNISH

400407532	1	EA						E
400407532 BRUSH VARNISH FLAT 1IN								
For general painting/varnishing. An inexpensive rubber or bakelike set brush w/metal ferrule w/flat wood handle. May also be used for applying soap solution in pressure testing.								

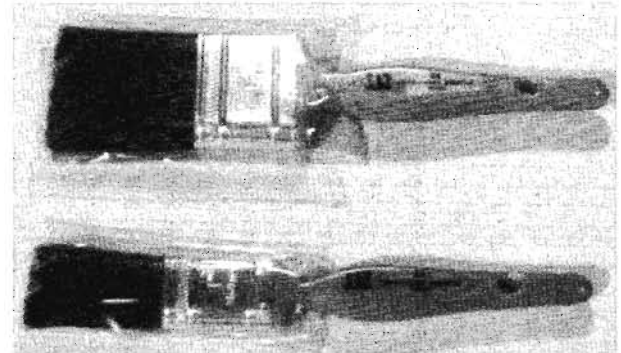

400407532

400484564	1	EA	12 12	12 12	12 12	12 12	12 12	E
400484564 BRUSH VARNISH FLAT 2IN								
Same as 1in Brush.								

PRODUCT IDENTIFIER		DESCRIPTION				
ITEM NUMBER	ORD. MULT.	SELL UNIT	STD. PKG. STOCK AVAILABILITY / PA	LEAD TIME	MIN. ORD.	A C

PRODUCT IDENTIFIER		DESCRIPTION				
ITEM NUMBER	ORD. MULT.	SELL UNIT	STD. PKG. STOCK AVAILABILITY / PA	LEAD TIME	MIN. ORD.	A C

BUCKET CANVAS

BUCKET SOAP

400021358 BUCKET CANVAS 9IN CA06673
 1118422 1 EA E
 Made of hard woven cotton duck with leather bottom, 9in diameter X 12in deep, 3/8in manilla rope bails, and has an outside pocket for small items. Used in raising tools aloft.

400021374 BUCKET SOAP B CA07271
 1118463 1 EA E
 Dispenses soap solution used in pressure testing. Consists of a cylindrical aluminum can with a funnel shaped well to accommodate a brush and is equipped with a bail for hoisting.



400021358

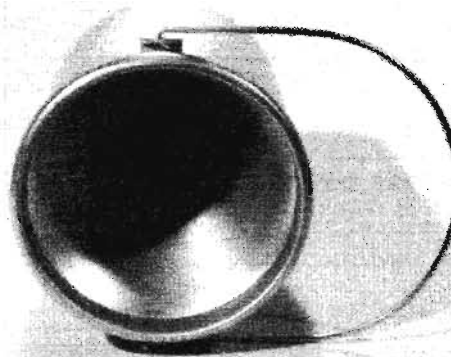

400021374

400021366 BUCKET CANVAS 12IN CA06673
 1158824 1 EA E

IL	IN	MI	OH	WI
12	12	12	12	12

 For handling material and tools when working aloft, BSP 620-310-100.



1158824

280020744 BUCKET CANVAS OVAL W/POCKETS
 N EA 1 2 1 E
 Oval bucket 8in X 14in with 15 pockets inside, Klein 5144S.

BUCKLE

280019563 BUCKLE 1/2IN ABV 4IN WITH 3IN FACE
 N EA 1 2 1 E

BULB ASPIRATOR

400484663 BULB ASPIRATOR 08-16839
 2792002 1 EA E
 For Indicator Gas F.



400484663

BURNISHER

300039450 BURNISHER CONTACT CB5
 1313486 1 EA E
 For cleaning all types of relay contacts in a central office, BSP 074-105-101 & BSP 074-217-110.



300039450

CABLE

260359575 CABLE BRIDGE TEST 9031 6FT
 N EA 1 8 1 E
 Used with 710B.

DISTRIBUTION SERVICES

NETWORK SERVICES

TOOLS

BUILDING JANITORIAL

AUTOMOTIVE

FORMS/OFFICE SUPPLIES

GENERAL

DATA VOICE

CABLE

PRODUCT IDENTIFIER		DESCRIPTION					
ITEM NUMBER	ORD. MULT.	SELL UNIT	STD. PKG. STOCK AVAILABILITY / PA	LEAD TIME	MIN. ORD.	A	C

260436613 CABLE CONNECTORIZED 50FT
1980854 1 EA IL IN MI OH WI

260436621 CABLE CONNECTORIZED 75FT
1980862 1 EA IL IN MI OH WI

260436639 CABLE CONNECTORIZED 100FT
1980870 1 EA IL IN MI OH WI

260436647 CABLE CONNECTORIZED 200FT
1980888 1 EA IL IN MI OH WI

300085230 CABLE COUPLER 9011
N EA 1 6 1 E
A 12ft extension cable for use with any Dynatel probe, coupler, transmitter or receiver.

260359807 CABLE EXTENSION 9032 33FT
N EA 1 9 1 E
Used with 710B.

300080439 CABLE POWER SUB ASSEMBLY-26FT
N EA 1 11 1 E
Model 260500-1.

300080447 CABLE POWER SUB ASSEMBLY-30FT
N EA 1 11 1 E
Model 260500.

260357546 CABLE REC/FRAME 9026
N EA 1 6 1 E

260359856 CABLE TEST 745-01
N EA 1 9 1 E

260357553 CABLE TEST CONNECTOR W/735
N EA 1 6 1 E

260357504 CABLE TEST CONNECTOR 9003 W/710A
N EA 1 6 1 E

260357538 CABLE TEST CONNECTOR 9019
N EA 1 6 1 E
Used with 730.

280010810 CABLE TEST CPN 627-5847-001
N EA 1 2 1 E

260357520 CABLE TRANSMITTER 9012
N EA 1 6 1 E
A 5ft transmitter cable e/w 2 clips used with Dynatel 500 or 573 Cable Locator Set.

CABLE CONNECTOR

260359419 CABLE CONNECTOR 25 PAIR 15FT C9837
N EA 1 6 1 E
2 each male C-J blank.

PRODUCT IDENTIFIER		DESCRIPTION					
ITEM NUMBER	ORD. MULT.	SELL UNIT	STD. PKG. STOCK AVAILABILITY / PA	LEAD TIME	MIN. ORD.	A	C

260359393 CABLE CONNECTOR 50 PAIR 15FT C9835
N EA 1 6 1 E
2 each female C-J blank.

260359534 CABLE CONNECTOR 50 PAIR 15FT C9859
N EA 1 6 1 E
2 each male C-J blank.

CABLE CRIMPING

ADC ORDER ITEM ONLY.

260303185 CABLE CRIMPING 940-1131-4
1944884 1 EA E



260303185

280055609 CABLE CRIMPING 940-1132-6
1930115 1 EA IL IN MI OH WI E

280060526 CABLE CRIMPING 940-1133-8
N EA 1 4 1 E

260324652 CABLE CRIMPING 940-1134-0
N EA 1 2 1 E

260303193 CABLE CRIMPING 940-1978-0
1944223 1 EA IL IN MI OH WI E

CAN SAFETY

401468970 CAN SAFETY 3 GALLON CA08260
N EA 1 2 1 E
10728, 5/8in hose, red.

400300448 CAN SAFETY 2 5 GALLON CA08260
1130179 1 EA IL IN MI OH WI E
12 12 12 12
10821, equipped with flame-arresting screen.
Used for petroleum liquids, red.

PRODUCT IDENTIFIER DESCRIPTION

ITEM NUMBER	ORD. MULT.	SELL UNIT	STD. PKG. STOCK AVAILABILITY / PA	LEAD TIME	MIN. ORD.	A C
-------------	------------	-----------	-----------------------------------	-----------	-----------	-----

400300364 CAN SAFETY C 2 GALLON CA08260
 1123422 1 EA IL IN MI OH WI 12 12 12 12 E
 Equipped with flame-arresting screen. Used for petroleum liquids, red.



1123422

400300380 CAN SAFETY C 5 GALLON CA08260
 N EA 1 2 1 E
 Red.

402233647 CAN SAFETY E 3 GALLON CA08260
 N EA 1 2 1 E
 Red.

CAP

402761530 CAP CONDUCTIVE PROBE 188A
 1443002 1 EA E
 Provides protection from the sharp tip of the Set Test 188A (1163596) and provides a means of attaching the ground cord, BSP 081-705-102.



402761530

CAP BASEBALL ILLINOIS

ILLINOIS BELL LOGO ONLY

260395371 CAP BASEBALL NAVY BLUE CORDUROY - IL
 1974030 1 EA E

260395389 CAP BASEBALL NAVY BLUE VENTILATED - IL
 1974048 1 EA IL IN MI OH WI 12 E

260395397 CAP BASEBALL TAN CORDUROY - IL
 1974014 1 EA IL IN MI OH WI 12 E

260395405 CAP BASEBALL TAN VENTILATED - IL
 1974022 1 EA IL IN MI OH WI 12 E

PRODUCT IDENTIFIER DESCRIPTION

ITEM NUMBER	ORD. MULT.	SELL UNIT	STD. PKG. STOCK AVAILABILITY / PA	LEAD TIME	MIN. ORD.	A C
-------------	------------	-----------	-----------------------------------	-----------	-----------	-----

CAP BASEBALL INDIANA

INDIANA BELL LOGO ONLY

260337910 CAP BASEBALL NAVY BLUE CORDUROY - IN
 1947929 1 EA E

260337936 CAP BASEBALL NAVY BLUE VENTILATED - IN
 1947945 1 EA IL IN MI OH WI 12 E

260337928 CAP BASEBALL TAN CORDUROY - IN
 1947937 1 EA IL IN MI OH WI 12 E

260337902 CAP BASEBALL TAN VENTILATED - IN
 1947911 1 EA IL IN MI OH WI 12 E

CAP BASEBALL MICHIGAN

MICHIGAN BELL LOGO ONLY

260395454 CAP BASEBALL NAVY BLUE CORDUROY - MI
 1981100 1 EA E

260395462 CAP BASEBALL NAVY BLUE VENTILATED - MI
 1981118 EA IL IN MI OH WI 12 E

260395470 CAP BASEBALL TAN CORDUROY - MI
 1981126 1 EA IL IN MI OH WI 12 E

260395488 CAP BASEBALL TAN VENTILATED - MI
 1981134 1 EA IL IN MI OH WI 12 E

CAP BASEBALL OHIO

OHIO BELL LOGO ONLY

260395413 CAP BASEBALL NAVY BLUE CORDUROY - OH
 N EA 24 4 24 E

260395421 CAP BASEBALL NAVY BLUE VENTILATED - OH
 N EA 24 4 24 E

260395439 CAP BASEBALL TAN CORDUROY - OH
 N EA 24 4 24 E

260395447 CAP BASEBALL TAN VENTILATED - OH
 N EA 24 4 24 E

CAP BASEBALL WISCONSIN

WISCONSIN BELL LOGO ONLY

260395330 CAP BASEBALL NAVY BLUE CORDUROY - WI
 N EA 24 4 24 E

260395348 CAP BASEBALL NAVY BLUE VENTILATED - WI
 N EA 24 4 24 E

DISTRIBUTION SERVICES

NETWORK SERVICES

TOOLS

BUILDING JANITORIAL

AUTOMOTIVE

FORMS/OFFICE SUPPLIES

GENERAL

DATA VOICE

CAP BASEBALL WISCONSIN

DISTRIBUTION SERVICES

PRODUCT IDENTIFIER		DESCRIPTION				
ITEM NUMBER	ORD. MULT.	SELL UNIT	STD. PKG. STOCK AVAILABILITY / PA	LEAD TIME	MIN. ORD.	A C
260395355			CAP BASEBALL TAN CORDUROY - WI			
N		EA	24	4	24	E

NETWORK SERVICES

260395363			CAP BASEBALL TAN VENTILATED - WI			
N		EA	24	4	24	E

CARD

840601421			CARD DESIGNATION 840601421			
N		EA	1	4	140	E

CARD TEST

260388988			CARD TEST 71-0288-00			
N		EA	1		1	E
260388996			CARD TEST 71-0289-00			
N		EA	1		1	E
260389002			CARD TEST 72-0281-00 EXT			
N		EA	1		1	E

TOOLS

BUILDING JANITORIAL

260435151			CARD TEST ACCESS 910P001-001			
1980177		EA	IL IN MI OH WI			

CARRIER

400088035			CARRIER HANDLINE B CA07710			
1125781	1	EA				E
Device may be attached to a body belt and used for securing one end of rope while climbing, BSP 081-720-111.						



400088035

400496253			CARRIER HOSE BLOWER B CA08418			
1125807	1	EA	IL IN MI OH WI			E
Used to carry a Hose Blower B (1184028), BSP 649-510-115.						

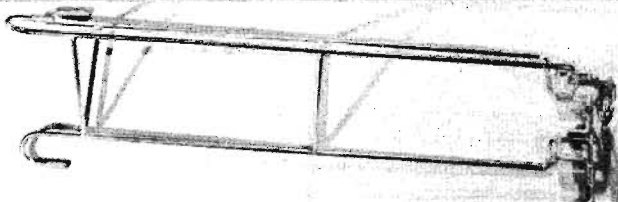

1125807

FORMS/OFFICE SUPPLIES

GENERAL

CASE

260357769			CASE 50 PAIR TEST CORD			
N		EA	1	9	1	E
260357827			CASE 308 TEST CONNECTOR			
N		EA	1	9	1	E
Carrying case for Connector 308 Test.						

DATA VOICE

PRODUCT IDENTIFIER		DESCRIPTION				
ITEM NUMBER	ORD. MULT.	SELL UNIT	STD. PKG. STOCK AVAILABILITY / PA	LEAD TIME	MIN. ORD.	A C

260357785			CASE 310 TEST CONNECTOR			
N		EA	1	9	1	E
Carrying case for Connector 310 Test (PID260357710).						

260357793			CASE 333 TEST CONNECTOR			
N		EA	1	9	1	E
Carrying case for Connector 333 Test (PID260357637).						

260436423			CASE 369T TRIPLET			
N		EA	1	2	1	
Case for 310 Volt Meter.						

400329496			CASE ASSEMBLY CK08740 L91			
N		EA	1	5	2	E

260411657			CASE C-50			
N		EA	1	2	1	E

260411665			CASE C-70			
N		EA	1	2	1	E

300080462			CASE DIGITAL BEEPER J375			
1333468	1	EA	IL IN MI OH WI			E
12 12 12 12						

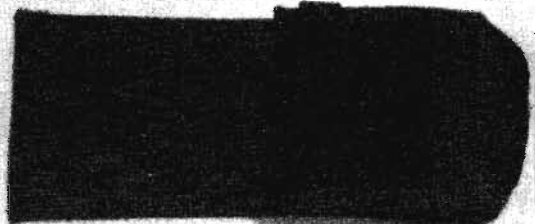

1333468

401352653			CASE GLASS SAFETY REINFORCED 69			
1196691	1	EA	IL IN MI OH WI			E
12 12 12 12						

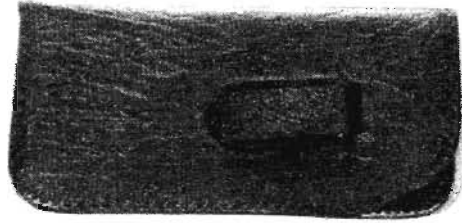

1196691

PRODUCT IDENTIFIER DESCRIPTION

ITEM NUMBER	ORD. MULT.	SELL UNIT	STD. PKG. STOCK AVAILABILITY / PA	LEAD TIME	MIN. ORD.	A C
-------------	------------	-----------	-----------------------------------	-----------	-----------	-----

002087726 CASE GOGGLE VINYL 955
 1446245 1 EA IL IN MI OH WI E
 12 12 12 12 12
 Suitable for containing the monogoggle, panoram or eye saver goggles, BSP 620-155-010.

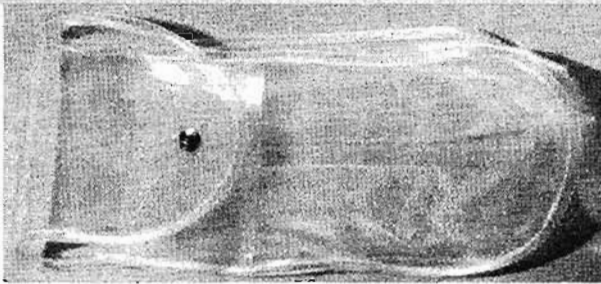

1446245

402896508 CASE INDICATOR GAS D CA08898

ITEM NUMBER	ORD. MULT.	SELL UNIT	STD. PKG. STOCK AVAILABILITY / PA	LEAD TIME	MIN. ORD.	A C
-------------	------------	-----------	-----------------------------------	-----------	-----------	-----

Used to store and transport the Kit Test Gas C (2640861) and associated fittings, BSP 081-700-122.



5316943

402968671 CASE INSTALLER C CA7401

ITEM NUMBER	ORD. MULT.	SELL UNIT	STD. PKG. STOCK AVAILABILITY / PA	LEAD TIME	MIN. ORD.	A C
-------------	------------	-----------	-----------------------------------	-----------	-----------	-----

Used by I&M service technicians to carry tools. Made of high density polyethylene, 21in L X 10in H X 8in W, has a hinged cover and removable tray. The catch is e/w a locking ear.



1447383

260431887 CASE NYLON 8455
 N EA 1 4 1

PRODUCT IDENTIFIER DESCRIPTION

ITEM NUMBER	ORD. MULT.	SELL UNIT	STD. PKG. STOCK AVAILABILITY / PA	LEAD TIME	MIN. ORD.	A C
-------------	------------	-----------	-----------------------------------	-----------	-----------	-----

401058763 CASE POCKET TOOL R4014
 N EA 6 1 6 E

403238272 CASE S5201-1
 N EA 1 9 1 E

402954325 CASE S5201-2
 N EA 1 9 1 E

280016627 CASE SOFT Y382B304
 N EA 1 2 1 E

CASE CARRYING

260336573 CASE CARRYING 30B
 N EA 1 4 1 E

260385190 CASE CARRYING 107/108
 N EA 1 6 1 E

300086600 CASE CARRYING 369T
 N EA 1 3 1 E
 Carrying case for Meter Multi Voltmeter 310 Type 5, (PID300086568).

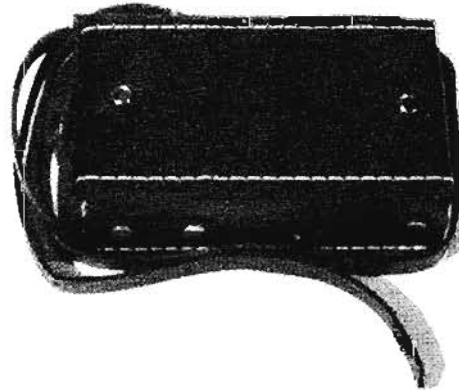

300086600

280017377 CASE CARRYING 425A-CC CANVAS
 N EA 1 2 1 E

280013608 CASE CARRYING 802-1702-0
 N EA 1 2 1 E

280043712 CASE CARRYING 818A E/W STRAP
 N EA 1 17 1 E
 Carrying case for Set Test 818A (PID280043704).

300085313 CASE CARRYING 1018
 N EA 1 2 1 E
 Used for Public Services for service tool box.

260385182 CASE CARRYING 102A SOFT
 N EA 1 6 1 E

280020660 CASE CARRYING 1118 CENTRAL OFFICE
 N EA 1 2 1 E

DISTRIBUTION SERVICES

NETWORK SERVICES

TOOLS

BUILDING JANITORIAL

AUTOMOTIVE

FORMS/OFFICE SUPPLIES

GENERAL

DATA VOICE

DISTRIBUTION SERVICES

CASE CARRYING

PRODUCT IDENTIFIER		DESCRIPTION				
ITEM NUMBER	ORD. MULT.	SELL UNIT	STD. PKG. STOCK AVAILABILITY / PA	LEAD TIME	MIN. ORD.	A C

300085339 CASE CARRYING 1304 KEITHLEY
 N EA 1 2 2 E
 Padded soft vinyl case and stand for handled Keithley 135 DMM and test leads, zips up.

NETWORK SERVICES

280011230 CASE CARRYING 1306
 N EA 1 2 1 E
 A carrying case for the Model 135 Multimeter, Keithly Instruments.

TOOLS

260395041 CASE CARRYING 7706 ZIPPERED
 N EA 1 2 1 E

280019845 CASE CARRYING 921000082 CANVAS
 N EA 1 2 1 E

280025263 CASE CARRYING 921000090 CANVAS
 N EA 1 2 1 E

300085321 CASE CARRYING 921000094
 N EA 1 3 1 E

BUILDING JANITORIAL

401004445 CASE CARRYING BIT 30IN
 N EA 1 4 12 E
 Carrying case for long Drill Bits.

401352703 CASE CARRYING BIT 31IN
 1219998 1 EA IL IN MI OH WI E
 12 12 12 12 12
 DISCONTINUE AND FORWARD TO CASE CARRY BIT 30IN UPON STOCK DEPLETION.

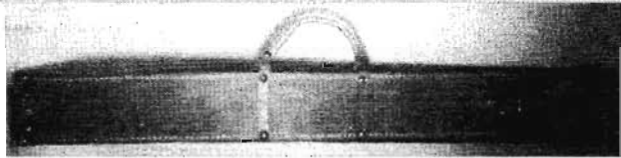

1219998

AUTOMOTIVE

280017856 CASE CARRYING BMW-3
 N EA 1 2 1 E
 Carrying case for SLC-96 plug-in cards.

FORMS/OFFICE SUPPLIES

300064128 CASE CARRYING C 90
 1152678 1 EA IL IN MI OH WI E
 12 12 12 12 12
 For use with Meter Multi-Digital 8021B (1162289).

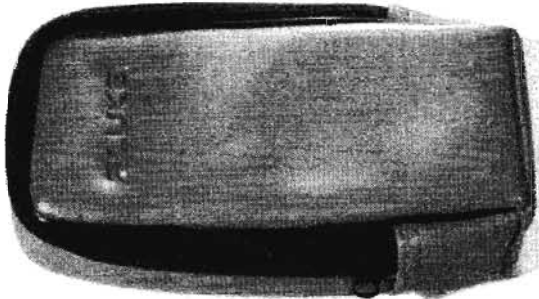

1152678

GENERAL

260423363 CASE CARRYING C250SSP
 N EA 1 2 1

DATA VOICE

PRODUCT IDENTIFIER		DESCRIPTION				
ITEM NUMBER	ORD. MULT.	SELL UNIT	STD. PKG. STOCK AVAILABILITY / PA	LEAD TIME	MIN. ORD.	A C

260438445 CASE CARRYING CALLER ID TEST SET
 N EA 1 3 1

280023540 CASE CARRYING CARD APERTURE
 1921791 1 EA IL IN MI OH WI E
 12 12
 DISCONTINUE UPON STOCK DEPLETION.

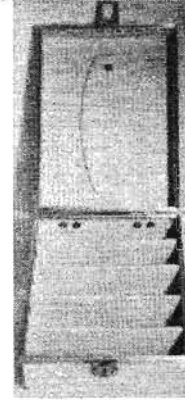

1921791

300085305 CASE CARRYING CC 202A
 N EA 1 5 1 E
 Carrying case for Meter CT 620 (Ainos)

997302583 CASE CARRYING CK07678 L14A
 N EA 1 1 1 E

997714019 CASE CARRYING CK08456 L3
 1165050 1 EA IL IN MI OH WI E
 12 12 12 12 12
 Carrying case with strap for Set Test CK8455 L1 (1199505), BSP 106-020-100.

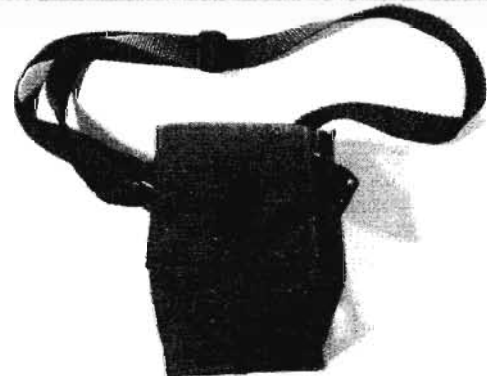

1165050

PRODUCT IDENTIFIER DESCRIPTION

ITEM NUMBER	ORD. MULT.	SELL UNIT	STD. PKG. STOCK AVAILABILITY / PA	LEAD TIME	MIN. ORD.	A C
-------------	------------	-----------	-----------------------------------	-----------	-----------	-----

401507454 CASE CARRYING CK14510 L102
 2608422 1 EA IL IN MI OH WI 12 12 12 12 12 E



2608422

997714308 CASE CARRYING CK15617

ITEM NUMBER	ORD. MULT.	SELL UNIT	STD. PKG. STOCK AVAILABILITY / PA	LEAD TIME	MIN. ORD.	A C
-------------	------------	-----------	-----------------------------------	-----------	-----------	-----

1302323 1 EA IL IN MI OH WI 12 12 E



1302323

402806780 CASE CARRYING CK16979 L9

ITEM NUMBER	ORD. MULT.	SELL UNIT	STD. PKG. STOCK AVAILABILITY / PA	LEAD TIME	MIN. ORD.	A C
-------------	------------	-----------	-----------------------------------	-----------	-----------	-----

5290346 1 EA IL IN MI OH WI 12 12 12 12 12 E
 Carrying case for Meter CK16979 L1 (1105593). Has neck strap for hands free testing with meter, BSP 084-810-101.

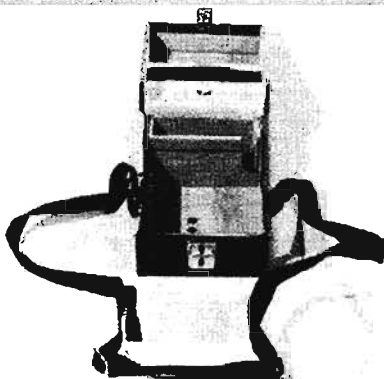

5290346

300067493 CASE CARRYING CTT140

ITEM NUMBER	ORD. MULT.	SELL UNIT	STD. PKG. STOCK AVAILABILITY / PA	LEAD TIME	MIN. ORD.	A C
-------------	------------	-----------	-----------------------------------	-----------	-----------	-----

N EA 1 2 1 E

PRODUCT IDENTIFIER DESCRIPTION

ITEM NUMBER	ORD. MULT.	SELL UNIT	STD. PKG. STOCK AVAILABILITY / PA	LEAD TIME	MIN. ORD.	A C
-------------	------------	-----------	-----------------------------------	-----------	-----------	-----

300087178 CASE CARRYING FOR SET TEST GENERATOR
 1334383 1 EA IL IN MI OH WI 12 12 12 12 12 E
 Carrying case for Set Test Generator (1334375).



1334383

996500690 CASE CARRYING REPLACEMENT FOR MT91A

ITEM NUMBER	ORD. MULT.	SELL UNIT	STD. PKG. STOCK AVAILABILITY / PA	LEAD TIME	MIN. ORD.	A C
-------------	------------	-----------	-----------------------------------	-----------	-----------	-----

2242347 1 EA IL IN MI OH WI 12 12 12 12 12 E
 TEST SET. Carrying case for components of Set Test 91A (1221341), BSP 106-300-100.

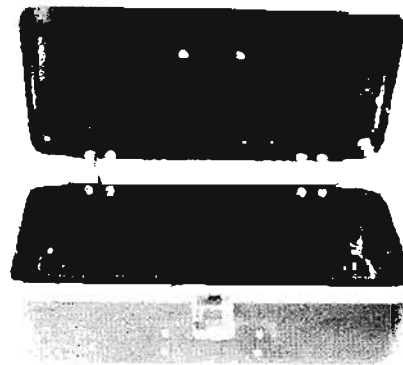

2242347

280020355 CASE CARRYING SOFT

ITEM NUMBER	ORD. MULT.	SELL UNIT	STD. PKG. STOCK AVAILABILITY / PA	LEAD TIME	MIN. ORD.	A C
-------------	------------	-----------	-----------------------------------	-----------	-----------	-----

N EA 1 2 1 E

280018912 CASE CARRYING XE TEST SET

ITEM NUMBER	ORD. MULT.	SELL UNIT	STD. PKG. STOCK AVAILABILITY / PA	LEAD TIME	MIN. ORD.	A C
-------------	------------	-----------	-----------------------------------	-----------	-----------	-----

N EA 1 2 1 E

DISTRIBUTION SERVICES

NETWORK SERVICES

TOOLS

BUILDING JANITORIAL

AUTOMOTIVE

FORMS/OFFICE SUPPLIES

GENERAL

DATA VOICE

DISTRIBUTION SERVICES

CASE TOOL

PRODUCT IDENTIFIER		DESCRIPTION				
ITEM NUMBER	ORD. MULT.	SELL UNIT	STD. PKG. STOCK AVAILABILITY / PA	LEAD TIME	MIN. ORD.	A C

CASE TOOL

996500617 CASE TOOL B CA08190

1127506 1 EA E
 For carrying tools used by Station and PBX Repairman (16in L X 12in W X 6in H). Has fall pocket and hasp.



996500617

402615959 CASE TOOL B MATERIAL CA08965

1185199 1 EA IL IN MI OH WI E
 12 12 12 12 12
 Used for CSMS to hold screws fastners, tool adapters etc. For use in downsized vehicles.

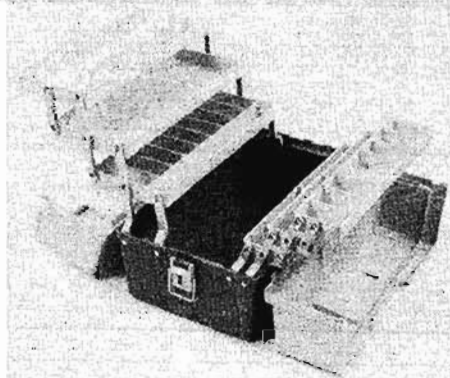

1185199

401285515 CASE TOOL C CA08600

N EA 1 12 1 E
 For field installers and repairman of data and teletype services. Lid and base pallets must be ordered separately.

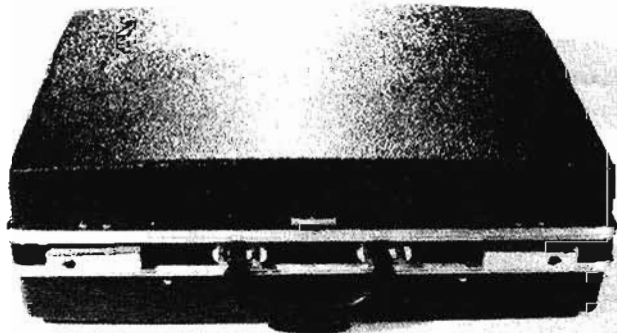

401285515

NETWORK SERVICES

TOOLS

BUILDING JANITORIAL

AUTOMOTIVE

FORMS/OFFICE SUPPLIES

GENERAL

DATA VOICE

PRODUCT IDENTIFIER		DESCRIPTION				
ITEM NUMBER	ORD. MULT.	SELL UNIT	STD. PKG. STOCK AVAILABILITY / PA	LEAD TIME	MIN. ORD.	A C

400119954 CASE TOOL POCKET CA06475

N EA 1 6 8 E
 For carrying pocket tools, BSP 074-570-101.

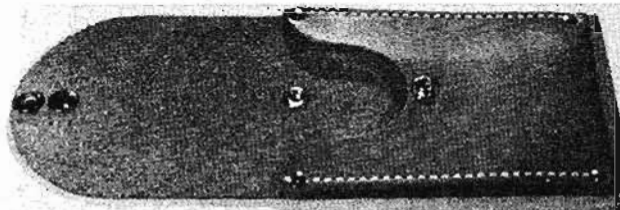

400119954

CASK WATER

400756888 CASK WATER B 2 GALLON CA08524

4449421 1 EA E
 An aluminum insulated storage container for drinking liquids. Has a stainless steel liner and a spigot, BSP 649-040-115.



400756888

401203005 CASK WATER C 2 GALLON CA08524

1148239 1 EA IL IN MI OH WI E
 12 12 12 12 12
 A vinyl plastic insulated storage container for drinking liquids. Has a plastic liner and a spigot, BSP 649-040-115.



1148239

PRODUCT IDENTIFIER		DESCRIPTION				
ITEM NUMBER	ORD. MULT.	SELL UNIT	STD. PKG. STOCK AVAILABILITY / PA	LEAD TIME	MIN. ORD.	A C

CHAIN

400120168 CHAIN CONSTRUCTION 1/2IN X 6FT

1127803 1 EA CA06354. For use in attaching the cable sheave to pull in irons, BSP 081-020-100. E

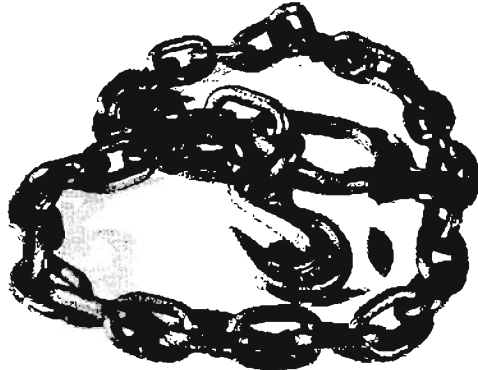

400120168

400120176 CHAIN CONSTRUCTION 1/2IN X 15FT

N EA 1 8 1 E CA06354, BSP 081-020-100.

400120150 CHAIN CONSTRUCTION 5/16IN X 4FT 4IN

1127787 1 EA IL IN MI OH WI E
12 12 12 12 12
CA06354. For general construction work, BSP 081-020-100 & BSP 627-295-300.

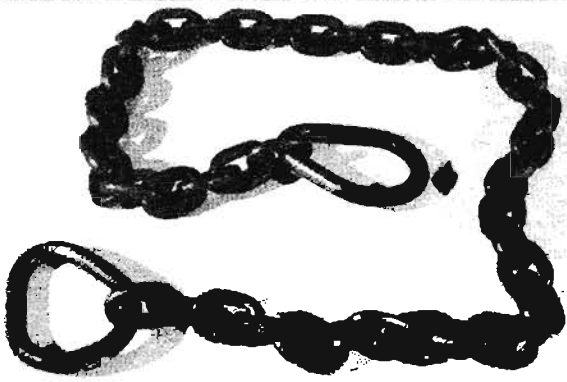

1127787

260383070 CHAIN GALVANIZED 3/16IN 3592T44

N FT 1 1 50 E

PRODUCT IDENTIFIER		DESCRIPTION				
ITEM NUMBER	ORD. MULT.	SELL UNIT	STD. PKG. STOCK AVAILABILITY / PA	LEAD TIME	MIN. ORD.	A C

400120135 CHAIN HANDLINE AERIAL B CA08192

1101352 1 EA IL IN MI OH WI E
12 12 12 12 12
Part of Handline Aerial B (1182642).



1101352

401393764 CHAIN LINK WIRE NIAGARA 6/0

1127829 1 FT IL IN MI OH WI E
12 12 12

CHARGER BATTERY

280021163 CHARGER BATTERY 6D 517140

N EA 1 2 1 E

260329939 CHARGER BATTERY AUTO 7.2 VOLTS DC

1946749 1 EA IL IN MI OH WI E
12 12 12 12 12
A battery charger used with Drill Cordless 3/8in 6073DW and Battery Rechargeable 7.2 Volts DC (1946731), Makita P/N113026-4.



1946749

260377577 CHARGER BATTERY AUTO 9.6 VOLTS DC

1959833 1 EA IL IN MI OH WI E
12 12 12 12 12
A battery charger used with Drill Cordless 3/8in 6093DW (1945723) and Battery Rechargeable Auto 9.6 Volts DC (1959841).

260357744 CHARGER BATTERY DYNATEL

N EA 1 9 1 E

DISTRIBUTION SERVICES

NETWORK SERVICES

TOOLS

BUILDING JANITORIAL

AUTOMOTIVE

FORMS/OFFICE SUPPLIES

GENERAL

DATA VOICE

DISTRIBUTION SERVICES

CHARGER BATTERY

PRODUCT IDENTIFIER		DESCRIPTION						MIN. A
ITEM NUMBER	ORD. MULT.	SELL UNIT	STD. PKG. STOCK AVAILABILITY / PA	LEAD TIME	MI	OH	WI	ORD. C
260303029 CHARGER BATTERY WP90741 L2								
1940023	1	EA	IL IN	12	MI	OH	WI	E
Comcode 404048134 used in conjunction with the AT&T, Craft Access System.								



1940023

NETWORK SERVICES

TOOLS

BUILDING JANITORIAL

AUTOMOTIVE

FORMS/OFFICE SUPPLIES

GENERAL

DATA VOICE

CHISEL

400486593 CHISEL COLD 1/2IN X 6IN								
N	EA	1		3				1 E
For general use in cutting metals.								

400486601 CHISEL COLD 3/4IN X 12IN								
1127985	1	EA	IL IN	12 12	MI	OH	WI	E
For general use in cutting metals.								



1127985

260439856 CHISEL NON-TURN #805								
N	EA	1		2				1
Air impact tool parts.								

900219841 CHISEL WOOD 1 IN								
1126565	1	EA	IL IN	12 12	MI	OH	WI	E



1126565

PRODUCT IDENTIFIER		DESCRIPTION						MIN. A
ITEM NUMBER	ORD. MULT.	SELL UNIT	STD. PKG. STOCK AVAILABILITY / PA	LEAD TIME	MI	OH	WI	ORD. C

CHOCK WHEEL

403107006 CHOCK WHEEL CA09034 W85S-MR								
1455360	1	EA						E
A Molded rubber triangular shaped wheel chock used to assist the vehicle brakes when vehicles are parked on slopes, BSP 649-040-200.								

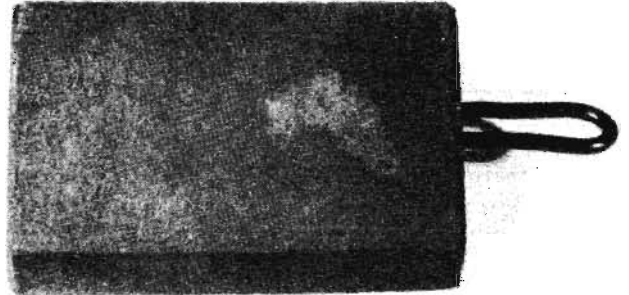

403107006

300085370 CHOCK WHEEL CB-05								
N	EA	1		3				3 E
A light weight heavy duty double grip safety wheel chock. To prevent movement of a truck under certain working conditions.								

400266383 CHOCK WHEEL SHOE CA06409-2								
N	EA	1		12				10 E
Used over the wheel chock for chocking the wheel of trucks when working in ice covered ground, BSP 649-040-200.								

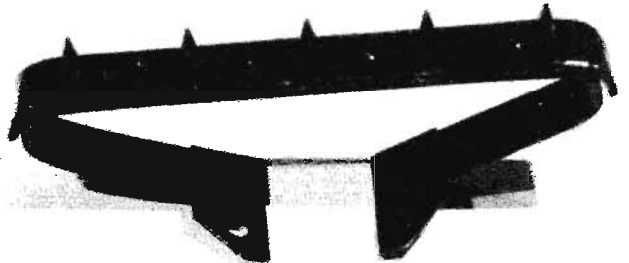

400266383

300071958 CHOCK WHEEL WOODEN CA07280								
N	EA	1		8				2 E
A wooden chock used to block line truck wheels.								

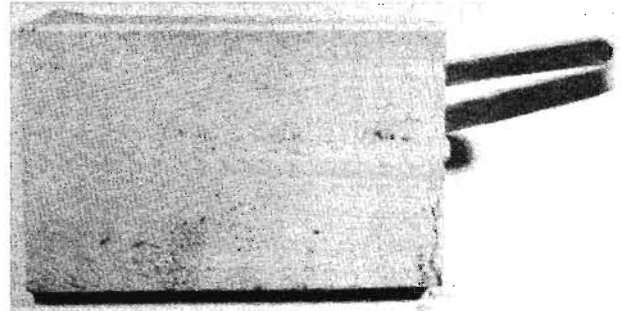

300071958

PRODUCT IDENTIFIER DESCRIPTION

ITEM NUMBER	ORD. MULT.	SELL UNIT	STD. PKG. STOCK AVAILABILITY / PA	LEAD TIME	MIN. ORD.	A C
-------------	------------	-----------	-----------------------------------	-----------	-----------	-----

CHUCK

002078921 CHUCK MAGNETIC HEX MSH 1/4IN
 1166165 1 EA E
 Used to drive hexagon head self-tapping screws with variable speed electric drills. Overall length 1 3/4in.

002078939 CHUCK MAGNETIC HEX MSH 3/8IN
 1195594 1 EA E
 IL IN MI OH WI
 12 12 12 12 12
 Used to drive hexagon head self-tapping screws with variable speed electric drills. Overall length 1 3/4in.



1195594

260432703 CHUCK MAGNETIC HEX MSH 5/16IN
 1979575 1 EA E
 IL IN MI OH WI
 12 12 12 12 12
 Used to drive hexagon head self-tapping screws with variable speed electric drills. Overall length 1 3/4IN.

CLAMP

401192299 CLAMP ASSEMBLY CA08418
 N EA 1 4 18 E

260321575 CLAMP DOUBLE KNOB HEAD AND BAR
 N EA 1 3 1 E
 Spare part for 3M 4046 Crimper 78-8044-9384-5.

260433107 CLAMP POLE SAFETY FC110
 N EA 1 4 1
 Flag clamp only W/nylon strap.

260433115 CLAMP POLE SAFETY FC1110
 N EA 1 4 1
 Flag clamp W/nylon strap and 3 flags.

260433131 CLAMP POLE SAFETY FC1150
 N EA 1 4 1
 Flag clamp W/steel chain and 3 flags.

260433123 CLAMP POLE SAFETY FC150
 N EA 1 4 1
 Flag clamp only W/steel chain and spring-load.

260433156 CLAMP POLE SAFETY LC1210
 N EA 1 4 1
 Light clamp W/2 flags & nylon strap.

280037615 CLAMP POLE SAFETY LC1250
 N EA 1 4 1 E
 Light clamp w/2 flags and steel chain.

260433149 CLAMP POLE SAFETY LC210
 N EA 1 4 1
 Light clamp only with nylon strap.

PRODUCT IDENTIFIER DESCRIPTION

ITEM NUMBER	ORD. MULT.	SELL UNIT	STD. PKG. STOCK AVAILABILITY / PA	LEAD TIME	MIN. ORD.	A C
-------------	------------	-----------	-----------------------------------	-----------	-----------	-----

260433164 CLAMP POLE SAFETY LC250
 N EA 1 4 1
 Light clamp only W/steel chain.

CLIMBER EQUIPMENT

401611520 CLIMBER RG1972AR W/GUARD
 2807149 1 PR E
 For Gaff replacement order Gaffs RG 72 (2788182). For Guard replacement order Guard Gaff 1972G (2658880) or Guard Gaff D (1425686).

401611538 CLIMBER RG1972ARL W/GUARD
 1219543 1 EA E
 IL IN MI OH WI
 12 12 12 12 12
 Adjustable. For Gaff replacement order Gaffs RG 72 (2788182). For Guard replacement order Guard Gaff 1972G (2658880) or Guard Gaff D (1425686).

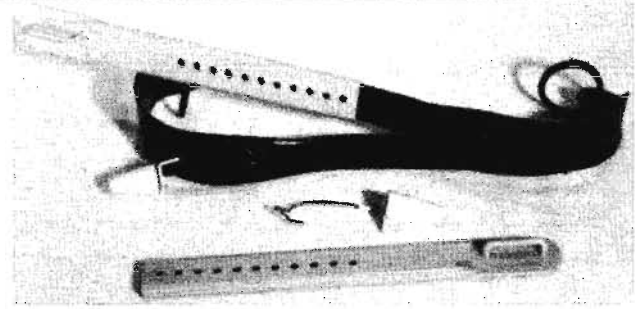

1219543

400519849 FASTENER CLIMBER F CA08530
 7430868 1 SE E
 IL IN MI OH WI
 12
 Set of four.

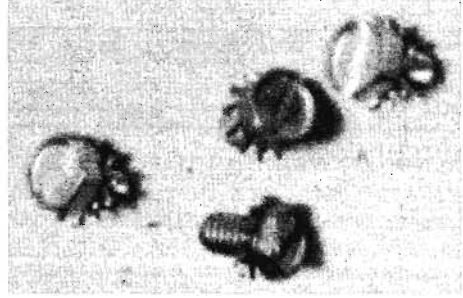

7430868

900377896 GUARD GAFF 1972G
 2658880 1 PR E
 IL IN MI OH WI
 12 12 12 12 12
 Plastic coated, coil spring gaff guard, see Gaffs RG 72 (2788182).

DISTRIBUTION SERVICES

NETWORK SERVICES

TOOLS

BUILDING JANITORIAL

AUTOMOTIVE

FORMS/OFFICE SUPPLIES

GENERAL

DATA VOICE

DISTRIBUTION SERVICES

NETWORK SERVICES

TOOLS

BUILDING JANITORIAL

AUTOMOTIVE

FORMS/OFFICE SUPPLIES

GENERAL

DATA VOICE

CLIMBER EQUIPMENT

PRODUCT IDENTIFIER		DESCRIPTION						MIN. A		
ITEM NUMBER	ORD. MULT.	SELL UNIT	STD. PKG. STOCK AVAILABILITY / PA	LEAD TIME	IL	IN	MI	OH	WI	ORD. C

402616072 GUARD GAFF D CA08918
 1425686 1 PK IL IN MI OH WI E
 12 12 12 12 12
 Package of 20. Used to cover gaff's on Irons Leg Climber F, BSP 081-730-010.



1425686

401152145 IRONS LEG CLIMBER F CA08530
 1102590 1 PR IL IN MI OH WI E
 12 12 12 12 12
 Leg irons only E/W fasteners and gaff guards. Pads (1144303), leg (1266163 & 1169656) and foot (1323584) straps, and sleeves (1100263 & 1102731) must be ordered separately, BSP 081-730-101.

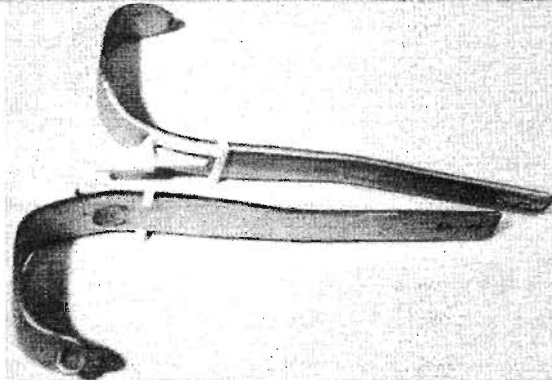

1102590

401286752 IRONS LEG CLIMBER H CA08530
 5364562 1 PR IL IN MI OH WI E
 12 12 12 12 12
 Leg irons only for workers of small stature, BSP 081-730-101.

PRODUCT IDENTIFIER		DESCRIPTION						MIN. A		
ITEM NUMBER	ORD. MULT.	SELL UNIT	STD. PKG. STOCK AVAILABILITY / PA	LEAD TIME	IL	IN	MI	OH	WI	ORD. C

400519864 SLEEVE CLIMBER F 18 1/2IN
 1100263 1 PR IL IN MI OH WI E
 12 12 12 12 12
 CA08530. For Irons Leg Climber F (1102590). New climbers do not include sleeves, BSP 081-730-101.

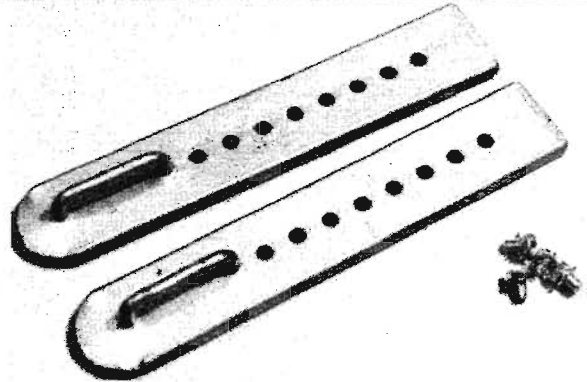

1100263

400519872 SLEEVE CLIMBER F 21 1/2IN
 1102731 1 PR IL IN MI OH WI E
 12 12 12 12 12
 CA08530. For Irons Leg Climber F (1102590). New climbers do not include sleeves, BSP 081-730-101.

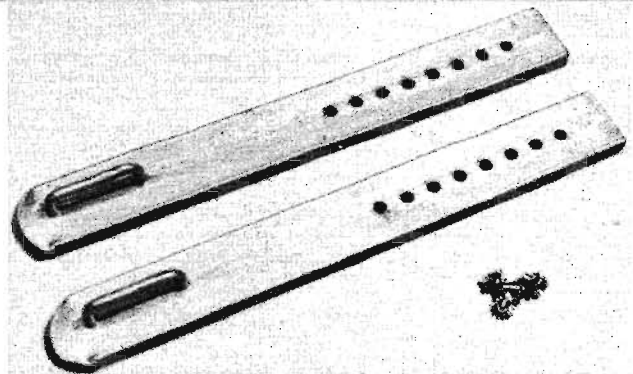

1102731

400272233 STRAP CLIMBER B 22IN CA07490
 1266163 1 EA IL IN MI OH WI E
 12 12 12 12 12
 Leg strap for Irons Leg Climber F (1102590) & H (5364562), BSP 081-730-101.



1266163

400272241 STRAP CLIMBER B 26IN CA07490
 1169656 1 EA IL IN MI OH WI E
 12 12 12 12 12
 Leg strap for Irons Leg Climber F (1102590) & H (5364562), BSP 081-730-100.

DISTRIBUTION SERVICES

NETWORK SERVICES

TOOLS

BUILDING JANITORIAL

AUTOMOTIVE

FORMS/OFFICE SUPPLIES

GENERAL

DATA VOICE

PRODUCT IDENTIFIER		DESCRIPTION					
ITEM NUMBER	ORD. MULT.	SELL UNIT	STD. PKG. STOCK AVAILABILITY / PA	LEAD TIME	MIN. ORD.	A	C

400584710 STRAP CLIMBER E CA08584
 1323584 1 EA IL IN MI OH WI E
 12 12 12 12 12
 Foot strap for Irons Leg Climber F (1102590) & H (5364562), BSP 081-730-101.



1323584

CLIP

102278959 CLIP 6A
 2689067 1 EA E
 Rustproof clip for use with H2B cords and associated 1013A-type hand sets when access to terminals, connecting blocks, and drop wire or bare conductors are required.



102278959

260380217 CLIP 6A P-5000-016
 N PK 1 3 1 E
 Package of 20.

260413570 CLIP AC70
 N EA 1 2 1 E

900182999 CLIP ALLIGATOR MUELLER 60
 1129742 1 EA IL IN MI OH WI E
 12 12 12 12 12
 A small clip 2in long X 1/8in wide with an alligator jaw 9/16in long.



1129742

260301924 CLIP BELT P 3218-214
 1938753 1 EA IL IN MI OH WI E
 12 12 12 12 12



1938753

260380209 CLIP BELT P-5000-010
 1980193 1 PK IL IN MI OH WI E
 12 12 12 12 12

PRODUCT IDENTIFIER		DESCRIPTION					
ITEM NUMBER	ORD. MULT.	SELL UNIT	STD. PKG. STOCK AVAILABILITY / PA	LEAD TIME	MIN. ORD.	A	C

001001627 CLIP BELT TOOL HAND SET
 5138461 1 EA IL IN MI OH WI E
 12 12 12 12 12
 This is a replacement clip for the Set Hand TS-21.



5138461

260385141 CLIP CABLE 317
 N EA 1 6 1 E

997124656 CLIP CK16336 L1
 N EA 1 15 1 E

997126974 CLIP CONNECTING CK06278
 1129882 1 EA IL IN MI OH WI E
 12 12 12 12 12
 For general use on Tool 360A, 360B & 360C, BSP 074-260-113.

996993408 CLIP CONNECTING CK06780
 N EA 1 2 1 E
 Narrow spring clip with terminal for soldering. Use on Tool 360A, 360B or 360C, BSP 074-260-113.



996993408

400122339 CLIP CONTACT B CA06869
 N EA 25 4 25 E



400122339

300085461 CLIP CONTACT NSQ4100L1
 N EA 1 18 E
 Used on test leads of Set Hand 1013B, alligator type clip.

280099292 CLIP CORD TRANSFER B
 1937441 1 EA IL IN MI OH WI E
 12 12 12 12 12

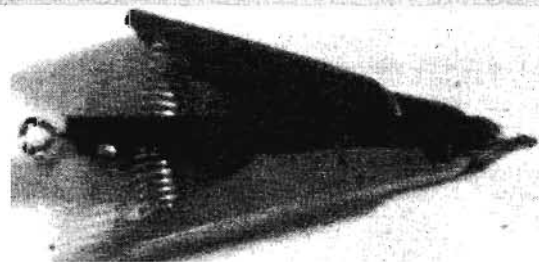

1937441

260443437 CLIP LOGIC 548A
 N EA 1 6 1

CLIP

PRODUCT IDENTIFIER DESCRIPTION

ITEM NUMBER	ORD. MULT.	SELL UNIT	STD. PKG.	LEAD TIME	MIN. ORD.	A C
-------------	------------	-----------	-----------	-----------	-----------	-----

900693334 CLIP TEST 4347

1447722	1	EA	IL	IN	MI	OH	WI	E
			12	12	12	12	12	

Used to access quiet front binding posts.

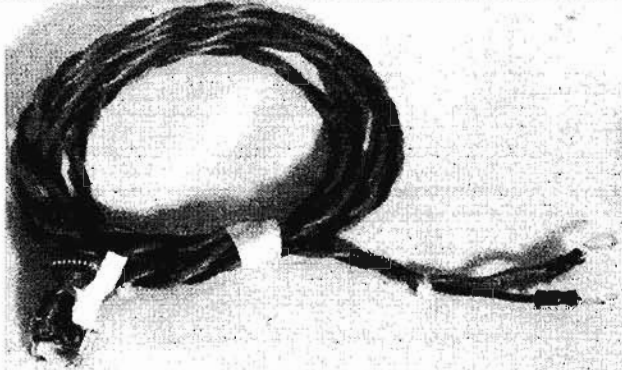

1447722

280062704 CLIP TEST 6P W/BOOTS (RED & BLACK)

1934257	1	BG	IL	IN	MI	OH	WI	E
			12	12	12	12	12	

Includes 2 clips and one red and one black boot. For use with the Set Hand 1013A.



1934257

400122495 CLIP TEST B CA07950

1130104	1	EA	IL	IN	MI	OH	WI	E
			12	12	12	12	12	

Used to connect test clips to cable pairs terminated in a 300 Connector or 121 Protector, BSP 106-315-101.



1130104

400122503 CLIP TRANSFER CABLE B CA06869

1130120	1	EA	IL	IN	MI	OH	WI	E
			12	12	12	12	12	

Used in testing 22 gauge or smaller exchange cables, without removing insulation.



1130120

PRODUCT IDENTIFIER DESCRIPTION

ITEM NUMBER	ORD. MULT.	SELL UNIT	STD. PKG.	LEAD TIME	MIN. ORD.	A C
-------------	------------	-----------	-----------	-----------	-----------	-----

400122511 CLIP TRANSFER CABLE C CA06869

1130146	1	EA	IL	IN	MI	OH	WI	E
			12	12	12	12	12	

Used in testing 19 gauge or heavier exchange cables.

CLOTH ABRASIVE

400122750 CLOTH ABRASIVE 1IN X 9IN 120J

N	PK	1	2	1	E
---	----	---	---	---	---

Aluminum Oxide, package of 100, CA06160.

400122768 CLOTH ABRASIVE 3IN X 5 1/2IN 120J

N	PK	1	2	1	E
---	----	---	---	---	---

CA06160. Package of 100. Medium, Aluminum Oxide.

400454575 CLOTH ABRASIVE 9IN X 11IN

N	SH	50	2	50	E
---	----	----	---	----	---

Medium grit.

001025923 CLOTH ABRASIVE 9IN X 11IN 3/0

N	EA	50	2	50	E
---	----	----	---	----	---

Electrocut, 80J, Aluminum Oxide.

400454559 CLOTH ABRASIVE 9IN X 11IN CROCUS

1130948	1	SH	IL	IN	MI	OH	WI	E
			12	12	12	12	12	

CLOTH EMERY

996582318 CLOTH EMERY 9IN X 11IN COARSE

N	SH	50	2	50	E
---	----	----	---	----	---

996582292 CLOTH EMERY 9IN X 11IN MEDIUM

N	SH	50	2	50	E
---	----	----	---	----	---

02432 3M.

CLOTH WIPING

400122941 CLOTH WIPING FLAT 2 1/2IN CA06245

1130963	1	EA						E
---------	---	----	--	--	--	--	--	---

Cotton, flat wiping cloth used for wiping joints in lead covered cable cables.

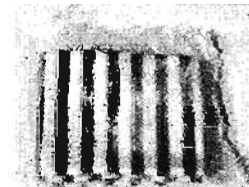

400122941

400122958 CLOTH WIPING FLAT 3 IN CA06245

N	EA	1	6	35	E
---	----	---	---	----	---

Cotton, flat wiping cloth used for wiping joints in lead covered cable sheath.

400122974 CLOTH WIPING FLAT 4 IN CA06245

1139899	1	EA	IL	IN	MI	OH	WI	E
			12	12	12	12	12	

Cotton, flat wiping cloth used for wiping joints in lead covered cable sheath.

DISTRIBUTION SERVICES

NETWORK SERVICES

TOOLS

BUILDING JANITORIAL

AUTOMOTIVE

FORMS/OFFICE SUPPLIES

GENERAL

DATA VOICE

DISTRIBUTION SERVICES

NETWORK SERVICES

TOOLS

BUILDING JANITORIAL

AUTOMOTIVE

FORMS/OFFICE SUPPLIES

GENERAL

DATA VOICE

PRODUCT IDENTIFIER		DESCRIPTION				
ITEM NUMBER	ORD. MULT.	SELL UNIT	STD. PKG. STOCK	LEAD TIME AVAILABILITY / PA	MIN. ORD.	A C

400123006 CLOTH WIPING FLAT 10 IN CA06245
 N EA 1 6 1 E
 Cotton, flat wiping cloth used for wiping joints in lead covered cable sheath.

COATING

280019555 COATING PROTECTIVE LADDER 4621
 N CS 1 3 1 E
 A protective coating for fiberglass ladders. Used to renew the finish and cover any exposed fibers.

CONE

300067691 CONE COLLAR 6IN
 N EA 25 3 25 E
 Highly reflective collar is to be placed on traffic cones when they are used for traffic control.

002044279 CONE SAFETY WARNING DISPOSABLE
 1163220 1 EA IL IN MI OH WI 12 12 12 12 12 E

260364344 CONE TRAFFIC D 28IN WITH 2 COLLARS
 1954479 1 EA IL IN MI OH WI 12 12 12 12 12 E



1954479

CONNECTOR

401004635 CONNECTOR APP TEST TAC 284-1
 1161679 1 EA E
 An adaptor which provides a fast, safe access to any pair of a 66 type connecting block.

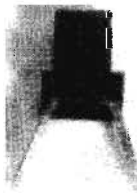

401004635

260359260 CONNECTOR FTS 303/302 W/AMP
 N EA 1 6 1 E

PRODUCT IDENTIFIER		DESCRIPTION				
ITEM NUMBER	ORD. MULT.	SELL UNIT	STD. PKG. STOCK	LEAD TIME AVAILABILITY / PA	MIN. ORD.	A C

402490064 CONNECTOR L PRESSER CA08948
 1223156 1 EA IL IN MI OH WI 12 12 12 12 E
 Used to connect 710 connectors. Used to connect CONECS, WHIS/BSM and male/female connectors, BSP 632-205-220.

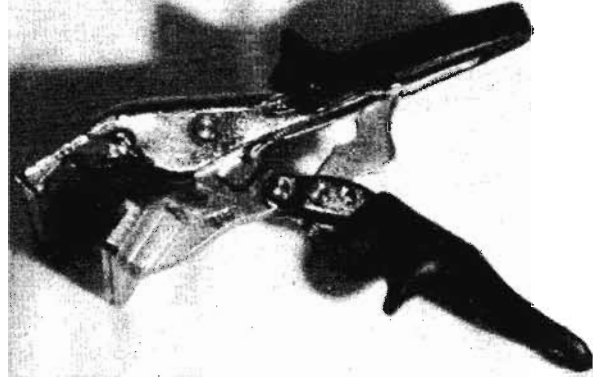

1223156

260359864 CONNECTOR LINED LOOSE
 N EA 1 12 100 E

260442215 CONNECTOR LOOPBACK CALNET 732
 N EA 1 3 1
 REPLACES ED3C793-3- G1.

997116181 CONNECTOR PLUG CK19531 L1
 N EA 1 13 1 E

997118450 CONNECTOR PLUG PIN CK19531 L2
 N EA 1 2 1 E

280079831 CONNECTOR SELF STRIP 25 PAIR
 N EA 1 3 1 E
 Test 4328.

402689020 CONNECTOR TEST S CA08953
 N EA 1 12 1 E

CONTAINER TAG POLE

400130522 CONTAINER TAG POLE CA06407
 1134924 1 EA E
 A metal box with compartments and hinged cover, 7in X 11in X 3in. Designed for carrying tags and numbers used for pole identification.

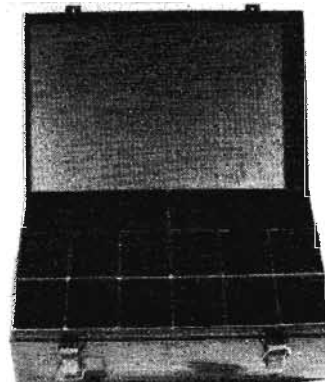

400130522

DISTRIBUTION SERVICES

NETWORK SERVICES

TOOLS

BUILDING JANITORIAL

AUTOMOTIVE

FORMS/OFFICE SUPPLIES

GENERAL

DATA VOICE

CORD

PRODUCT IDENTIFIER		DESCRIPTION				
ITEM NUMBER	ORD. MULT.	SELL UNIT	STD. PKG. STOCK AVAILABILITY / PA	LEAD TIME	MIN. ORD.	A C

CORD

100162734 CORD W1M 3FT 6IN RED

1176198 1 EA
 Individually packaged, intended for use on line finder and rotary line switch units.
 DISCONTINUE, ORDER NON STOCK UPON STOCK DEPLETION

260367735 CORD 0042 310 PLUG

N EA 1 2 1 E

260360045 CORD BUTT-IN B2, C3, L1, L2, L9

N EA 1 4 1 E
 Multi end.

260360052 CORD BUTT-IN B2, C3, L1, L2, LX

N EA 1 4 1 E
 Multi end.

260360060 CORD BUTT-IN B2, C4, L1, L2, L9, LX

N EA 1 4 1 E
 Multi end.

300085552 CORD CMC 6823-03

N EA 1 2 1 E

260361134 CORD CONVERSION NE-P3Q3

N EA 1 4 1 E
 ADC 4-25898-0030.

280026907 CORD EXTENSION 150ft W/REEL & CADDY 12/3

N EA 1 4 1 E
 Heavy duty 12 Gauge 3 conductor yellow cord with four female receptacles mounted on a reel with caddy, SY 14F47.

260395074 CORD EXTENSION 36IN 7563

N EA 1 2 1 E

400131983 CORD EXTENSION C CA07637

1146043	1	EA	IL 12	IN 12	MI 12	OH 12	WI 12	E
---------	---	----	-------	-------	-------	-------	-------	---

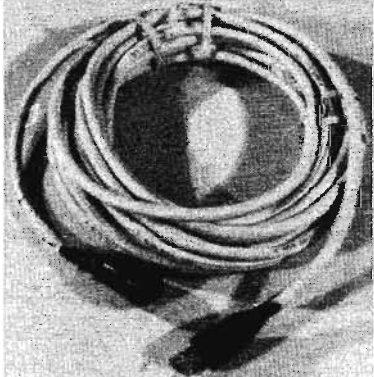

1146043

PRODUCT IDENTIFIER		DESCRIPTION				
ITEM NUMBER	ORD. MULT.	SELL UNIT	STD. PKG. STOCK AVAILABILITY / PA	LEAD TIME	MIN. ORD.	A C

400131991 CORD EXTENSION D CA07637

1101667	1	EA	IL 12	IN 12	MI 12	OH 12	WI 12	E
---------	---	----	-------	-------	-------	-------	-------	---

30ft 14GA 3 conductor cord used to connect portable electric tools to AC outlets, BSP 620-103-010.

280015496 CORD FOR 730 VAULT TEST SET

N		EA	1	2	1	E
---	--	----	---	---	---	---

103936514 CORD H2B 5FT BLACK

1456749	1	EA	IL 12	IN 12	MI 12	OH 12	WI 12	E
---------	---	----	-------	-------	-------	-------	-------	---

Two conductor cord used with Set Test 1013B.

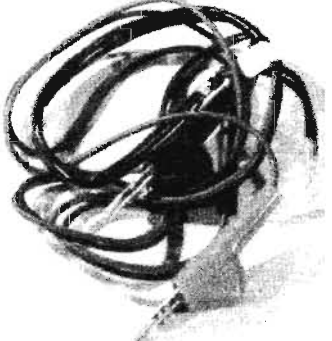

1456749

102458049 CORD H2C 10IN BLACK E/W PLUG 346A

2823989	1	EA	IL 12	IN 12	MI 12	OH 12	WI 12	E
---------	---	----	-------	-------	-------	-------	-------	---

Two conductor cord used with Set Test 1014B.



2823989

260357348 CORD L 3W3A-12W-SL 12 FT SLATE

N		EA	1	4	3	E
---	--	----	---	---	---	---

E/W one 310 plug & KS-6780 Alligator clip, 3 conductor.

260355045 CORD L 6PID- 1W-SL 1 FT SLATE

N		EA	1	5	3	E
---	--	----	---	---	---	---

E/W 425A Plugs, 6 conductor.

103847034 CORD M2FS-87 6FT

N		EA	1	1	1	E
---	--	----	---	---	---	---

280009762 CORD MOD LINE 6200-07W SEE 102479904

N		EA	1	3	1	E
---	--	----	---	---	---	---

This is a 4 conductor 7ft straight cord. Plug ended one end and spade tipped on the other end. Color - silver pearl.

280024654 CORD MODULAR FOR TONE TEST SET

N		EA	1	2	1	E
---	--	----	---	---	---	---

140A/MC.

PRODUCT IDENTIFIER DESCRIPTION						
ITEM NUMBER	ORD. MULT.	SELL UNIT	STD. PKG. STOCK AVAILABILITY / PA	LEAD TIME	MIN. ORD.	A C
280009770 CORD MODULAR LINE 6200-14W						
N		EA	1	3	1	E
This is a 4 conductor 7ft straight cord. Plug ended one end and spade tipped on the other end. Color - silver pearl.						
260436316 CORD MT 10142A						
N		EA	1	2	1	
Used with MT 911 Series Test Sets.						
260436324 CORD MT 10143						
N		EA	1	2	1	
Used with MT 911 Series Test Sets.						
260436332 CORD MT 10145A (310 PLUG)						
N		EA	1	2	1	
Used with MT 911 Series Test Sets.						
260436308 CORD MT 10146A						
N		EA	1	2	1	
Used with MT 911 Series Test Sets.						
260436340 CORD MT 10146A						
N						
Used with MT 911 Series Test Sets.						
260441126 CORD MULTI-END B1, C2, L1, L2						
N		EA	1	4	2	
260441142 CORD MULTI-END B1, C3, L1, L2, L4						
N		EA	1	4	1	
260439401 CORD MULTI-END B1, C3, L1, L2, L5						
N		EA	1	4	1	
260439385 CORD MULTI-END B1, C3, L1, L2, L7						
N		EA	1	4	1	
260439393 CORD MULTI-END B1, C3, L1, L5, L7						
N		EA	1	4	1	
260439419 CORD MULTI-END B1, C4, L1, L2, L5, L7						
N		EA	1	4	1	
260441159 CORD MULTI-END B1, C4, L1, L2, L7						
N		EA	1	4	1	
260441167 CORD MULTI-END B1, C4, L1, L2, L9						
N		EA	1	4	1	
260441175 CORD MULTI-END B2, C2, L1, L2						
N		EA	1	4	1	
260441191 CORD MULTI-END B2, C3, L0, LX						
N		EA	1	4	1	
260439336 CORD MULTI-END B2, C3, L1, L2, L3						
N		EA	1	4	1	
260441183 CORD MULTI-END B2, C3, L1, L2, L4						
N		EA	1	4	1	
260439344 CORD MULTI-END B2, C3, L1, L2, L5						
N		EA	1	4	1	

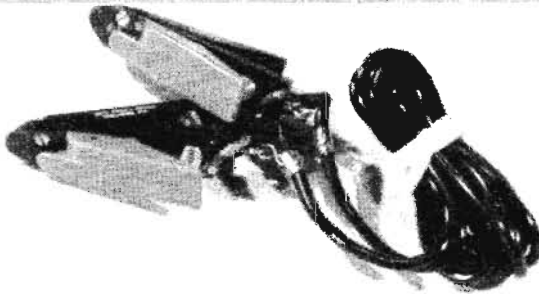
PRODUCT IDENTIFIER DESCRIPTION						
ITEM NUMBER	ORD. MULT.	SELL UNIT	STD. PKG. STOCK AVAILABILITY / PA	LEAD TIME	MIN. ORD.	A C
260439351 CORD MULTI-END B2, C3, L1, L2, L7						
N		EA	1	4	1	
260441134 CORD MULTI-END B2, C3, L1, L5, L7						
N		EA	1	4	1	
260439377 CORD MULTI-END B2, C3, L2, L3						
N		EA	1	4	1	
260439369 CORD MULTI-END B2, C4, L1, L2, L5, L7						
N		EA	1	4	1	
260441209 CORD MULTI-END B2, C4, L1, L2, L7						
N		EA	1	4	1	
260439468 CORD PJ1312 DUAL PATCH 12FT						
N		EA	1	4	3	
260439476 CORD PJ1515 DUAL PATCH 15FT						
N		EA	1	4	2	
260439484 CORD PJ1520 DUAL PATCH 20FT						
N		EA	1	4	2	
280016395 CORD POWER SENSOR 11730B						
N		EA	1	2	1	E
With 009 OPT for 436A Power Meter.						
260357751 CORD P-100A 50 PAIR TEST						
N		EA	1	9	1	E
260357777 CORD P-100B 50 PAIR EXTENSION						
N		EA	1	9	1	E
300085560 CORD P-5000-011 WITH CLIP 6A						
N		PK	1	3	1	E
This is a replacement cord e/w 6A alligator clips, for the Set Hand TS-21.						
260370127 CORD P-5000-012 CLIP W/BED OF NAILS						
N		PK	1	3	1	E
Package of 4.						
400132130 CORD TRANSFER B MODEL 318						
1146241	1	EA	IL IN MI OH WI			E
12 12 12 12 12						
Used for maintaining continuity when cutting slack in or out of cables, BSP 106-300-115.						
						
1146241						
280020413 CORD VENTILATOR FAN SET 4210A4						
N		EA	1	2	1	E

DISTRIBUTION SERVICES

NETWORK SERVICES

TOOLS

BUILDING JANITORIAL

AUTOMOTIVE

FORMS/OFFICE SUPPLIES

GENERAL

DATA VOICE

DISTRIBUTION SERVICES

CORD

PRODUCT IDENTIFIER		DESCRIPTION				
ITEM NUMBER	ORD. MULT.	SELL UNIT	STD. PKG. STOCK AVAILABILITY / PA	LEAD TIME	MIN. ORD.	A C

105583314 CORD W4DG 10FT

N EA 1 4 1

NETWORK SERVICES

CORD CABLE

260338462 CORD CABLE 8IN 023-800058

N EA 1 3 1 E

An 8 conductor modular cable equipped with a modular plug end and an RJ31X receptacle end. Used with the Smart Jack Remote Testing Unit.



260338462

260344502 CORD CABLE 6FT 023-800059

1950295 1 EA IL IN MI OH WI E
12

1950295

260338504 CORD CABLE 7FT 023-800049

N EA 1 4 1 E

An 8 conductor modular cable equipped with plug to plug modular ends. Used with Smart Jack Remote Testing Unit.

260338488 CORD CABLE 7FT 023-800051

1948208 1 EA IL IN MI OH WI E
12 12

An 8 conductor modular cable equipped with a modular plug end and an 8 spade lugs end. Used with the Smart Jack Remote Testing Unit.

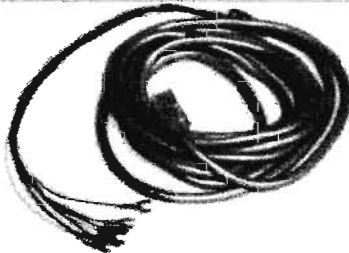

1948208

TOOLS

BUILDING JANITORIAL

AUTOMOTIVE

FORMS/OFFICE SUPPLIES

GENERAL

DATA VOICE

PRODUCT IDENTIFIER		DESCRIPTION				
ITEM NUMBER	ORD. MULT.	SELL UNIT	STD. PKG. STOCK AVAILABILITY / PA	LEAD TIME	MIN. ORD.	A C

260338496 CORD CABLE 14FT 023-800050

N EA 1 4 1 E

An 8 conductor modular cable equipped with plug to plug modular ends used with the Smart Jack Remote Testing Unit.

260338470 CORD CABLE 14FT 023-800052

N EA 1 4 1 E

An 8 conductor modular cable equipped with a modular plug end and an 8 spade lugs end. Used with the Smart Jack Remote Testing Unit.

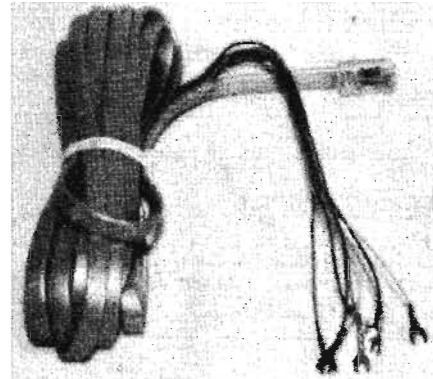

260338470

260338421 CORD CABLE 30FT SPI000-134

N EA 1 3 1 E

An 8 conductor modular cable equipped with a modular plug end and a 15 pin sub-D receptacle. Used with Smart Jack Remote Testing Unit.

CORD SHIELDED

260324363 CORD SHIELDED 8 PIN 5FT

1944702 1 EA E

023-800064. Used with Westell Smart Jack on Hi-Cap Service, DS-I.



260324363

260324371 CORD SHIELDED 8 PIN 10FT

N EA 1 4 1 E

023-800063.

CORD SOLDERING

400004529 CORD SOLDERING CK08740 L56

N EA 1 5 3 E

DISTRIBUTION SERVICES

NETWORK SERVICES

TOOLS

BUILDING JANITORIAL

AUTOMOTIVE

FORMS/OFFICE SUPPLIES

GENERAL

DATA VOICE

PRODUCT IDENTIFIER		DESCRIPTION				
ITEM NUMBER	ORD. MULT.	SELL UNIT	STD. PKG. STOCK AVAILABILITY / PA	LEAD TIME	MIN. ORD.	A C
400004479		EA	1	5	5	E
CORD SOLDERING 2X20 CK08740 L51						
N		EA	1	5	5	E
401244918 CORD SOLDERING 2X20 CK14440 L45						
N		EA	1	5	5	E
400004487 CORD SOLDERING 2X6 CK08740 L52						
N		EA	1	5	6	E
401244934 CORD SOLDERING 3X6 CK14440 L47						
N		EA	1	5	3	E

CORD TEST

100122084		EA	1	3FT RED		E
1135723						
Used for testing central office equipment, BSP 032-311-101.						

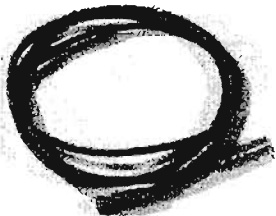

100122084

101428050		EA	1	6FT RED		E
1135749						
Used for testing central office equipment, BSP 032-311-101.						

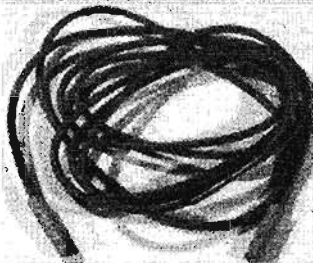

1135749

101428167		EA	1	10	1	E
N						
CORD TEST 2W 6A						

101428290		EA	1	4	4	E
N						
CORD TEST 2W17A 6FT SLATE						
Used to convert D4BU mounting cords for use with Jacks 548, 549 & 550. E/W a Plug 310, BSP 461-630-100.						

100123066		EA	1	1	1	E
N						
CORD TEST 2W17C SLATE						

101428357		EA	1	1	1	E
N						
CORD TEST 2W21A 6FT BROWN						
Consists of 1-Cord W2AB 6ft long equipped with 2-Tool 360A, BSP 032-312-101.						

PRODUCT IDENTIFIER		DESCRIPTION				
ITEM NUMBER	ORD. MULT.	SELL UNIT	STD. PKG. STOCK AVAILABILITY / PA	LEAD TIME	MIN. ORD.	A C
100123231		EA	1	4FT		E
1135889						
Consists of 1-Cord W2DB 4ft, equipped with a Jack 471, BSP 032-312-101.						

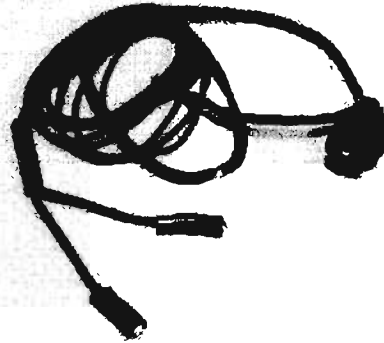

1135889

101428498		EA	1	5FT BLACK		E
1135905						

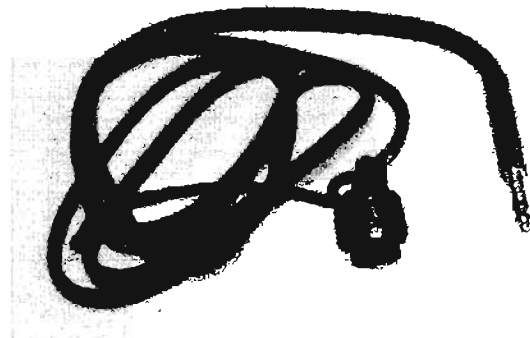

1135905

101428506		EA	1	4FT		E
1202259						
Bulk pack.						

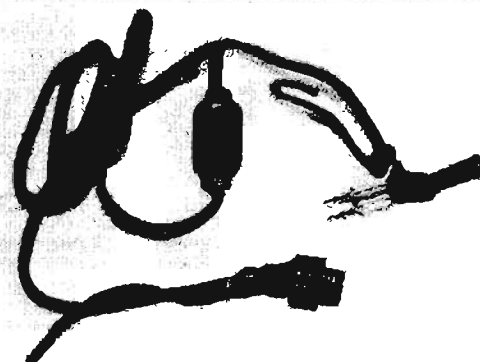

1202259

102247418		EA	1	1	1	E
N						
CORD TEST 2W39B						

DISTRIBUTION SERVICES

NETWORK SERVICES

TOOLS

BUILDING JANITORIAL

AUTOMOTIVE

FORMS/OFFICE SUPPLIES

GENERAL

DATA VOICE

CORD TEST

PRODUCT IDENTIFIER		DESCRIPTION							MIN.	A
ITEM NUMBER	ORD. MULT.	SELL UNIT	STD. PKG. STOCK AVAILABILITY / PA		LEAD TIME			ORD.	C	
101428522		CORD TEST	2W41A	4FT						
5398461	1	EA	IL 12	IN 12	MI 12	OH 12	WI 12		E	
A W2CJ cord 4ft long w/a 471A jack & two 360 type tools, BSP 032-312-122.										

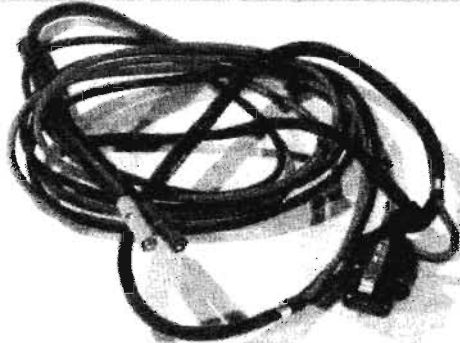

5398461

101428530		CORD TEST	2W42A	5FT 6IN					
N		EA	1		1			1	E

101428555		CORD TEST	2W44A						
N		EA	1		4			1	E

101428639		CORD TEST	2W50A	4FT BLACK					
1166009	1	EA	IL 12	IN 12	MI 12	OH 12	WI 12		E
Cord for a Set Test 91A e/w Plug 310 other end fitted for 723A receiver, BSP 106-300-100.									

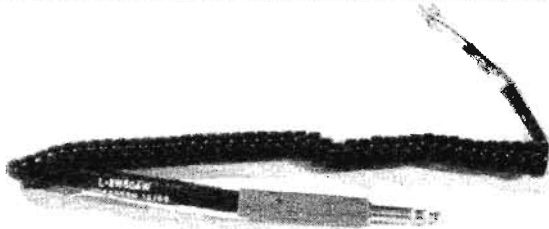

1166009

101428662		CORD TEST	3W 3A	12FT					
N		EA	1		1			1	E

101428670		CORD TEST	3W 4A	6FT SLATE					
5138107	1	EA	IL 12	IN 12	MI 12	OH 12	WI 12		E
A three conductor cord 6ft long consisting of one each: Cord W3M, Plug 310 and Tools 360A, 360B & 360C.									

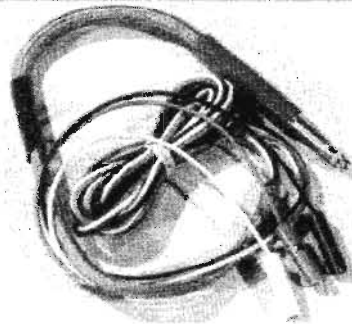

5138107

PRODUCT IDENTIFIER		DESCRIPTION							MIN.	A
ITEM NUMBER	ORD. MULT.	SELL UNIT	STD. PKG. STOCK AVAILABILITY / PA		LEAD TIME			ORD.	C	
100124247		CORD TEST	3W10A	4FT SLATE						
1157750	1	EA	IL 12	IN 12	MI 12	OH 12	WI 12		E	
Individual pack, 3 conductor testing cord e/w 3 clips on one end and a 471A 2 plug receptical on the other with an on/off switch.										

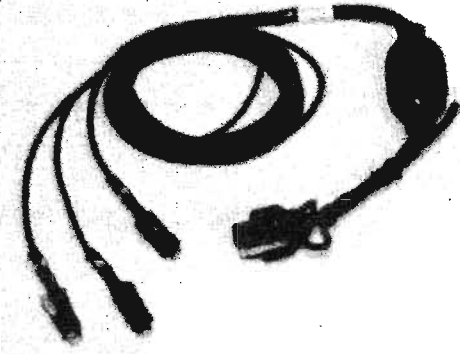

1157750

102274362		CORD TEST	3W10B						
N		EA	1			4		2	E

101428969		CORD TEST	4W 6A						
N		EA	1			1		1	E

101429017		CORD TEST	4W11A						
N		EA	1			10		50	E

260385174		CORD TEST	311						
N		EA	1			6		1	E

260392303		CORD TEST	399-1161						
1965855	1	EA	IL 12	IN 12	MI 12	OH 12	WI 12		E

260385158		CORD TEST	710-305						
N		EA	1			6		1	E

260385166		CORD TEST	710-306						
N		EA	1			6		1	E

260338199		CORD TEST	5026-60						
1948034	1	EA	IL 12	IN 12	MI 12	OH 12	WI 12		E
Two Alligator clips red & black.									

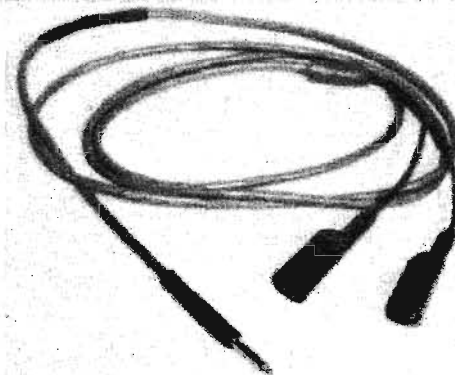

1948034

PRODUCT IDENTIFIER DESCRIPTION

ITEM NUMBER	ORD. MULT.	SELL UNIT	STD. PKG. STOCK AVAILABILITY / PA	LEAD TIME	MIN. ORD.	A C
-------------	------------	-----------	-----------------------------------	-----------	-----------	-----

280018680 CORD TEST 9958-254761
 N EA 1 4 1 E

300073806 CORD TEST ASSEMBLY JP11286
 N EA 1 2 1 E
 An all weather replacement cord for use with the Set Hand 21800089.

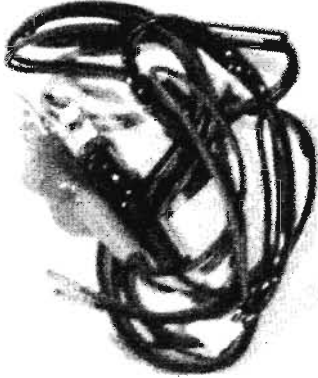

300073806

260438437 CORD TEST CALLER ID TEST SET
 N EA 1 4 1

260402474 CORD TEST CAU 3005
 N EA 1 3 1 E
 Channel Test Jack with 310 jacks.

260402458 CORD TEST CAU 3007
 N EA 1 3 1 E
 Channel Test Jack with dual 310 jacks.

260338678 CORD TEST CC 405755208
 1948604 1 EA IL IN MI OH WI E
 12 12 12 12
 RGT 16L2H 15A

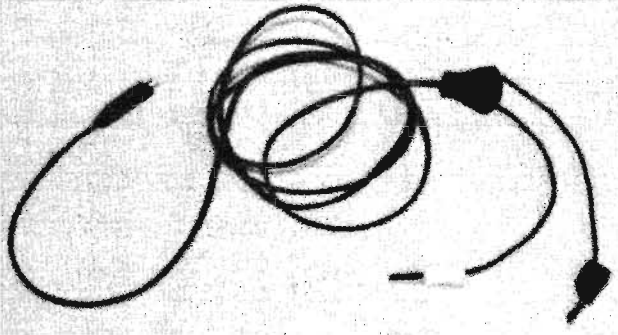

1948604

400931762 CORD TEST CK20908 L2
 N EA 1 8 1 E

402023949 CORD TEST D 4FT CA08662
 N EA 1 2 1

PRODUCT IDENTIFIER DESCRIPTION

ITEM NUMBER	ORD. MULT.	SELL UNIT	STD. PKG. STOCK AVAILABILITY / PA	LEAD TIME	MIN. ORD.	A C
-------------	------------	-----------	-----------------------------------	-----------	-----------	-----

402023956 CORD TEST D 8FT CA08662
 5522649 1 EA IL IN MI OH WI E
 12 12 12 12 12

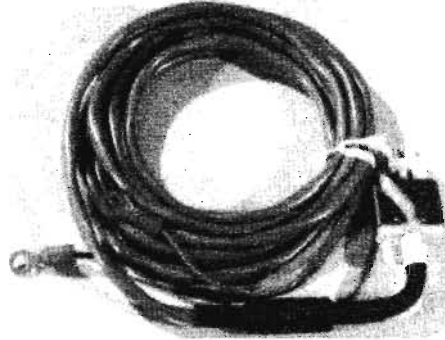

5522649

260441217 CORD TEST D-4 AND SLC-96
 N EA 1 4 2

260402466 CORD TEST D-4 MONITOR 3023
 N EA 1 3 1 E
 With one 471A Jack.

102500402 CORD TEST L-W1P-1BROWN 12 1/2IN
 1145482 1 EA IL IN MI OH WI E
 12 12 12 12 12
 Both ends have a #30 mini-gator clip, BSP 032-311-131.

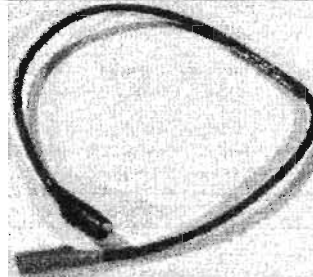

1145482

102540077 CORD TEST P2CY
 N EA 1 12 1 E

101433860 CORD TEST P2DC
 N EA 1 12 1 E

102430733 CORD TEST P2EC 8FT
 N EA 1 1 1 E

102187739 CORD TEST P2EU
 N EA 1 2 1 E

102816170 CORD TEST P6AC 12FT
 N EA 1 1 1 E

102822459 CORD TEST P6AD 6FT
 N EA 1 1 1 E

102822467 CORD TEST P6AD 12FT
 N EA 1 1 1 E

DISTRIBUTION SERVICES

NETWORK SERVICES

TOOLS

BUILDING JANITORIAL

AUTOMOTIVE

FORMS/OFFICE SUPPLIES

GENERAL

DATA VOICE

DISTRIBUTION SERVICES

NETWORK SERVICES

TOOLS

BUILDING JANITORIAL

AUTOMOTIVE

FORMS/OFFICE SUPPLIES

GENERAL

DATA VOICE

CORD TEST

PRODUCT IDENTIFIER		DESCRIPTION						
ITEM NUMBER	ORD. MULT.	SELL UNIT	STD. PKG. STOCK AVAILABILITY / PA	LEAD TIME	MIN. ORD.	A C		
260440847 CORD TEST SERIES TAP-DCCD-024								
N		EA	1	4	9			
400887881 CORD TEST SET ITE 9169B								
N		EA	1	1	1	E		
260402441 CORD TEST T-CARRIER 3006								
N		EA	1	3	1	E		
2 or 4 wire Channel Test Jacks.								
100163021 CORD TEST W1AH 6FT W/BN33674								
1145441	1	EA	IL 12	IN 12	MI 12	OH 12	WI 12	E
Individual pack, conductor is 18 gauge stranded copper wire equipped at the test clip end with bent nose, bed-of-nails, piercing spike.								



1145441

101615185 CORD TEST W1AL 2FT GREEN						
N		EA	1	1	5	E
Intended for busying out subscribers lines on the No.1 - 350A & 355A line finder units.						
101615193 CORD TEST W1AL 3FT 6IN GREEN						
N		EA	1	1	5	E
101615276 CORD TEST W1BB N3-CARRIER						
N		EA	1	2	1	E
101615284 CORD TEST W1BC						
N		EA	1	12	1	E
101952893 CORD TEST W1BF						
N		EA	1	12	1	E
102581857 CORD TEST W1BP 4FT						
N		EA	1	14	1	E

PRODUCT IDENTIFIER		DESCRIPTION						
ITEM NUMBER	ORD. MULT.	SELL UNIT	STD. PKG. STOCK AVAILABILITY / PA	LEAD TIME	MIN. ORD.	A C		
103642286 CORD TEST W1BU 25FT BLACK								
1311233	1	EA	IL 12	IN 12	MI 12	OH 12	WI 12	E
For use as a ground to the conductive end cap when the Set Test 188A is being used aloft or in a basket truck.								



1311233

102490935 CORD TEST W26M 16FT								
N		EA	1	1	1	E		
102279189 CORD TEST W2BJ 6FT BLACK								
1184796	1	EA	IL 12	IN 12	MI 12	OH 12	WI 12	E
Includes a Tool 513A Test Pick and Plug 347D. Used with Set Test 91A for testing cable, BSP 106-300-100.								

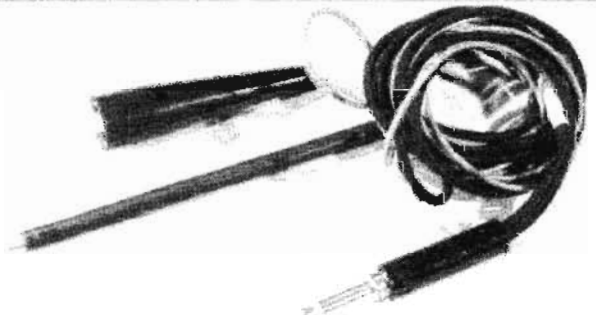

1184796

100164474 CORD TEST W2BT 4FT W/6A CLIP								
1311241	1	EA	IL 12	IN 12	MI 12	OH 12	WI 12	E

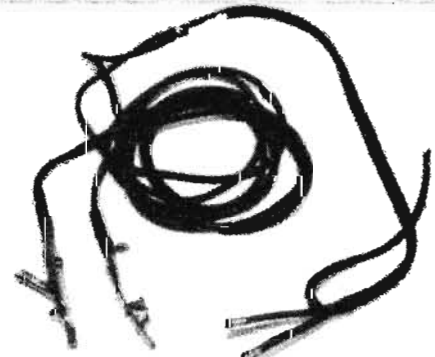

1311241

102185105 CORD TEST W2CJ						
N		EA	1	12	1	E

PRODUCT IDENTIFIER		DESCRIPTION					
ITEM NUMBER	ORD. MULT.	SELL UNIT	STD. STOCK	PKG. AVAILABILITY / PA	LEAD TIME	MIN. ORD.	A C
100164664		CORD TEST W2CK	6FT				
N		EA	1		14	1	E
Part of 2W38A test cord.							
100164706		CORD TEST W2CK	10FT				
N		EA	1		12	1	E
E/W 310.							
102061405		CORD TEST W2DB	4FT BLACK				
1145649	1	EA	IL	IN	MI	OH	WI
			12	12	12	12	12
Individual pack, used with 1011C hand set, part of 2W37A cord.							

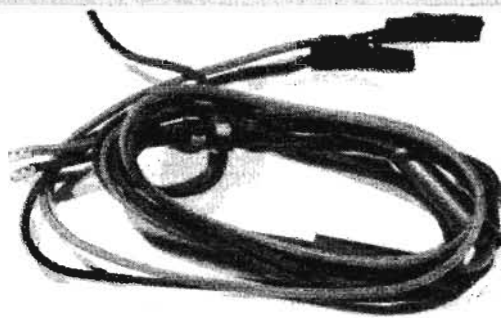

1145649

101616399		CORD TEST W2FH	6IN				
N		EA	1		1	1	E
101616449		CORD TEST W2FM	16FT				
N		EA	1		1	1	E

101858991		CORD TEST W2FT WITH 310 PLUG					
1191353	1	EA	IL	IN	MI	OH	WI
			12	12	12	12	12

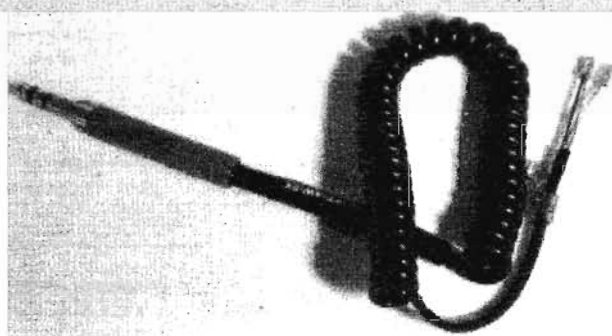

1191353

101817617		CORD TEST W2FW	35FT				
N		EA	1		1	1	E
102459088		CORD TEST W2GC	3FT BLACK				
N		EA	1		4	2	E
101945590		CORD TEST W2GL	3FT SLATE				
N		EA	1		4	2	E
102583531		CORD TEST W2HB	4FT				
N		EA	1		12	1	E
103853248		CORD TEST W2HF87	10FT				
N		EA	1		1	5	E

PRODUCT IDENTIFIER		DESCRIPTION					
ITEM NUMBER	ORD. MULT.	SELL UNIT	STD. STOCK	PKG. AVAILABILITY / PA	LEAD TIME	MIN. ORD.	A C
100163690		CORD TEST W2W					
N		EA	1		12	1	E
E/W 1-310 plug.							
260441894		CORD TEST W463EF	1FT				
N		EA	1		4	2	
102530821		CORD TEST W4BR	16FT BLACK				
1311225	10	EA	IL	IN	MI	OH	WI
			12	12	12	12	12
Used for In & Out Test on 302 type connectors.							



1311225

101898633		CORD TEST W4CJ	16FT SLATE				
2755827	1	EA	IL	IN	MI	OH	WI
			04	04	04	04	04
Bulk pack, four-conductor cord e/w a 464A plug & a 463A plug.							

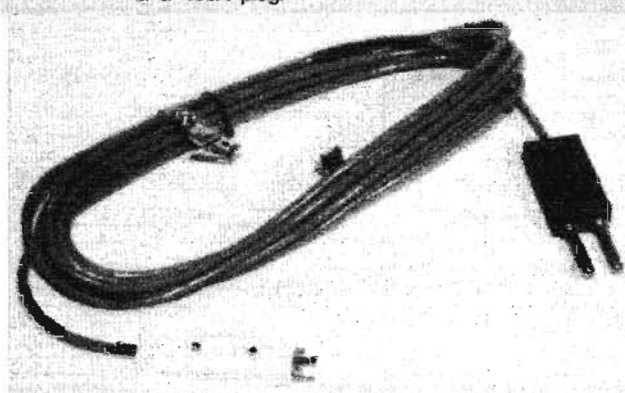

2755827

101981603		CORD TEST W4CM	16FT				
N		EA	1		12	1	E
102564002		CORD TEST W4CP	16FT				
N		EA	1		4	1	E
102653508		CORD TEST W4CT MAIN FRAME					
N		EA	1		1	1	E

DISTRIBUTION SERVICES
 NETWORK SERVICES
 TOOLS
 BUILDING JANITORIAL
 AUTOMOTIVE
 FORMS/OFFICE SUPPLIES
 GENERAL
 DATA VOICE

DISTRIBUTION SERVICES

COUPLER

PRODUCT IDENTIFIER		DESCRIPTION					
ITEM NUMBER	ORD. MULT.	SELL UNIT	STD. PKG. STOCK AVAILABILITY / PA	LEAD TIME	MIN. ORD.	A	C

CORD TIP

SEE TIP CORD.

COUPLER

260357488			COUPLER DYNA 3001 TM 3IN				
N		EA	1	6	1	E	
260357496			COUPLER DYNA 3005 1IN				
N		EA	1	12	1	E	
260439955			COUPLER FEMALE #825				
N		EA	1	2	1		
			Air impact tool parts.				
260439963			COUPLER MALE #826				
N		EA	1	2	1		
			Air impact tool parts.				

COVER

260438684			COVER DUST 49IN RECTIFIER				
N		EA	1	4	1		
260438676			COVER DUST 98IN RECTIFIER				
N		EA	1	4	1		

COVERALL

260447469			COVERALL DISPOSABLE YELLOW	LARGE			
N			Polycoated.				
260447453			COVERALL DISPOSABLE YELLOW	MEDIUM			
N			Polycoated.				
260447477			COVERALL DISPOSABLE YELLOW	XLARGE			
N			Polycoated.				
260448485			COVERALL DISPOSABLE YELLOW	XXLARGE			
N			Polycoated.				
260448493			COVERALL DISPOSABLE YELLOW	XXXLARGE			
N			Polycoated.				

COVERALL DISPOSABLE PANTS

260448527			COVERALL PANTS WHITE	LARGE			
N			Disposable, breathable.				
260448501			COVERALL PANTS WHITE	MEDIUM			
N			Disposable, breathable.				

NETWORK SERVICES

TOOLS

BUILDING JANITORIAL

AUTOMOTIVE

FORMS/OFFICE SUPPLIES

GENERAL

DATA VOICE

PRODUCT IDENTIFIER		DESCRIPTION					
ITEM NUMBER	ORD. MULT.	SELL UNIT	STD. PKG. STOCK AVAILABILITY / PA	LEAD TIME	MIN. ORD.	A	C

260448543 COVERALL PANTS WHITE XLARGE

N Disposable, breathable.

260448568 COVERALL PANTS WHITE XXLARGE

N Disposable, breathable.

260448584 COVERALL PANTS WHITE XXXLARGE

N Disposable, breathable.

COVERALL DISPOSABLE SHIRT

260448535 COVERALL SHIRT WHITE LARGE

N Disposable, breathable.

260448519 COVERALL SHIRT WHITE MEDIUM

N Disposable, breathable.

260448550 COVERALL SHIRT WHITE XLARGE

N Disposable, breathable.

260448576 COVERALL SHIRT WHITE XXLARGE

N Disposable, breathable.

260448592 COVERALL SHIRT WHITE XXXLARGE

N Disposable, breathable.

CRIMPER

280037870 CRIMPER 685B350

N EA 1 2 1 E

300080967 CRIMPER BNC MOD D 69477-1

N EA 1 2 1 E

CUTTER

280037888 CUTTER 3B910

N EA 1 2 1 E
Miniaturized tool used for repair of circuit packs in Central Office.

280037896 CUTTER 3B973

N EA 1 2 1 E
Miniaturized tool used for repair of circuit packs in Central Office.

280037904 CUTTER 3B974

N EA 1 2 1 E
Miniaturized tool used for repair of circuit packs in Central Office.

260436779 CUTTER AIR PIPE & TUBING

N EA 1 3 1
Used to cut CA3131 Air Pipe & Tubing.

PRODUCT IDENTIFIER DESCRIPTION

ITEM NUMBER	ORD. MULT.	SELL UNIT	STD. PKG. STOCK AVAILABILITY / PA	LEAD TIME	MIN. ORD.	A C
-------------	------------	-----------	-----------------------------------	-----------	-----------	-----

300085594 CUTTER CABLE 250 COMM-CUTTER
 N EA 1 2 1 E
 A ratcheting cable cutter manually operated, capacity 2 1/2in single cut or 3 1/2in double cut.

260411335 CUTTER CABLE 63035 16 1/2IN LENGTH
 N EA 1 2 1 E
 For cutting cable up to 1 3/8IN. Not designed for cutting steel or ACSR.

260411327 CUTTER CABLE 63041 25 1/2IN LENGTH
 N EA 2 2 2 E

400135992 CUTTER CABLE AND WIRE CA07263
 1214213 1 EA IL IN MI OH WI E
 12 12 12 12 12
 Used to cut wire and small cables from the ground in plant dismantling operations with the small tree pruner handle, BSP 081-020-102.



1214213

260447461 CUTTER CABLE RATCHETING 75250
 N

900349333 CUTTER CABLE UP B41
 4236661 1 EA IL IN MI OH WI E
 12 12 12 12 12
 For cutting cable up to 2 3/10in in diameter and/or 100 pair cable, 24 gauge in size.

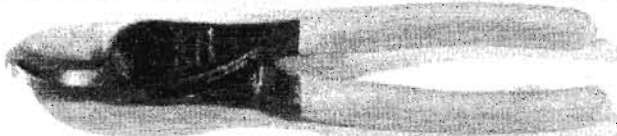

4236661

996765525 CUTTER CABLE W/O GUARD CA06625
 1134452 1 EA IL IN MI OH WI E
 12 12 12 12 12
 For cutting cable up to and including 2 3/10IN in diameter, 37IN in length. Not designed for cutting steel or ACSR.



1134452

300085628 CUTTER GENERAL PURPOSE 24IN #0190MC
 N EA 1 2 1 E
 A 24in cutter for bolts, rods, strand, etc. Cuts soft metal up to 4/16in and hard metals up to 5/16in.

PRODUCT IDENTIFIER DESCRIPTION

ITEM NUMBER	ORD. MULT.	SELL UNIT	STD. PKG. STOCK AVAILABILITY / PA	LEAD TIME	MIN. ORD.	A C
-------------	------------	-----------	-----------------------------------	-----------	-----------	-----

300085610 CUTTER LEAD 948R
 N EA 1 2 1 E
 Peripheral cutter used with Ajax Air Hammer.

300085602 CUTTER LEAD #803
 N EA 1 2 1 E
 Longitudinal cutter used with Ajax Air Hammer.

400291654 CUTTER POST BAND B CA07429
 1147926 1 EA IL IN MI OH WI E
 12 12 12 12



1147926

280045956 CUTTER SEALING WASHER 849A
 N EA 1 13 1 E

300078086 CUTTER STRAND 16M 0390MCX
 1920157 1 EA IL IN MI OH WI E
 12 12 12 12 12
 Used primarily for cutting up to 16,000lb strand or 5/8in bolts at the threaded end.

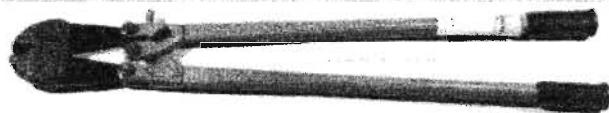

1920157

400135943 CUTTER STRAND B CA08274
 1101709 1 EA IL IN MI OH WI E
 12 12 12 12 12
 190MTQ, 24IN in length, used in cutting the B Strand self-supporting cable, BSP.



1101709

DISTRIBUTION SERVICES

NETWORK SERVICES

TOOLS

BUILDING JANITORIAL

AUTOMOTIVE

FORMS/OFFICE SUPPLIES

GENERAL

DATA VOICE

DISTRIBUTION SERVICES

CYLINDER

PRODUCT IDENTIFIER		DESCRIPTION					MIN.	A	
ITEM NUMBER	ORD. MULT.	SELL UNIT	STD. PKG. STOCK AVAILABILITY / PA	LEAD TIME	MI	OH	WI	ORD.	C

CYLINDER

260323084 CYLINDER LP GAS ALUMINUM 20LB
 1943340 1 EA 4806 E/W Rego 910-3T9F Valve. E



260323084

260323092 CYLINDER LP GAS ALUMINUM 40LB
 1943332 1 EA IL IN MI OH WI E
 12 12 12 12
 4804 E/W Rego 910-3T9F Valve.

400136016 CYLINDER LP GAS B 20LB
 6164467 1 EA IL IN MI OH WI E
 12 12 12 12
 A refillable steel container used for transporting and storing liquified petroleum gas, BSP 081-330-116.

400136024 CYLINDER LP GAS C 40LB
 1227496 1 EA IL IN MI OH WI E
 12 12 12 12
 A 40 lb. propane cylinder.



1227496

NETWORK SERVICES

TOOLS

BUILDING JANITORIAL

AUTOMOTIVE

FORMS/OFFICE SUPPLIES

GENERAL

DATA VOICE

PRODUCT IDENTIFIER		DESCRIPTION					MIN.	A	
ITEM NUMBER	ORD. MULT.	SELL UNIT	STD. PKG. STOCK AVAILABILITY / PA	LEAD TIME	MI	OH	WI	ORD.	C

400918862 CYLINDER REPLACEMENT KIT TEST GAS C

2791582 1 EA IL IN MI OH WI E
 12 12 12 12

Disposable gas cylinder with 2 1/2% natural gas under pressure of 250 PSI indicators. See Kit Test Gas C (2640961), BSP 081-700-122.



2791582

DAMPER

400136040 DAMPER VIBRATION B CA07488
 N PK 20 3 20 E
 Package of 20.

DETECTOR

280071523 DETECTOR COIL LOAD MODEL 88
 1935296 1 EA E
 Used by field forces to determine the presence and number of load coils on active or dead lines. Uses Battery 9.0V GP NEDA 1604 (1101055) or Battery 9.0V Alkaline (1434068).

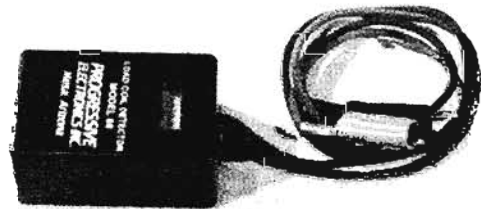

280071523

280052408 DETECTOR FT60 FERRO TRAK
 N EA 1 4 1 E
 For locating manhole covers and Peds when buried by snow or earth. Offers audio and visual indication of target strength.

PRODUCT IDENTIFIER		DESCRIPTION				
ITEM NUMBER	ORD. MULT.	SELL UNIT	STD. PKG. STOCK AVAILABILITY / PA	LEAD TIME	MIN. ORD.	A C

PRODUCT IDENTIFIER		DESCRIPTION				
ITEM NUMBER	ORD. MULT.	SELL UNIT	STD. PKG. STOCK AVAILABILITY / PA	LEAD TIME	MIN. ORD.	A C

DISTRIBUTION SERVICES

NETWORK SERVICES

TOOLS

BUILDING JANITORIAL

AUTOMOTIVE

FORMS/OFFICE SUPPLIES

GENERAL

DATA VOICE

DEVICE

402617401 DEVICE LEVELING CK22473 L1

N EA 1 3 1 E



402617401

DISTANCE MEASURING

SEE EQUIPMENT.

DRESSER CABLE

401190780 DRESSER CABLE WOODEN 46L113

1101717 1 EA E

A wooden tool used to remove irregularities from lead cable sheaths and for beating in the ends of lead sleeves when splicing.



401190780

DRI WICK

401513783 DRI WICK NO 484-6

N CT 1 2 4 E
25 Spools per carton.

DIE

300085644 DIE STEEL LETTERING 6688-L

N EA 1 2 1 E

Used for stamping letters on tools or items made of steel.

DRIFT

260439864 DRIFT KEY #807

N EA 1 2 1

Air impact tool parts.

400136842 DIE STEEL NUMBERING CA06688

1150128 1 EA IL IN MI OH WI E
12 12 12 12 12

Having a rotary head for use in stamping 1/4in numbers on tools or items made of steel.



1150128

DRILL

300085685 DRILL 907032

N EA 1 2 1 E
3/16in X 18in. For use with the Telsta Impact Wrench.

DIGGER

400462966 DIGGER POST HOLE 8FT DG-118

1228569 1 EA E

CA07632. A clamp shell hand operated post hole digger with 8ft handle.

260439971 DRILL AIR 1/2IN #827

N EA 1 2 1

Air impact tool parts.

DIPPER

260447479 DIPPER PARAFIN CA06679

N

401130687 DRILL ARBOR W/PILOT M44K

1173013 1 EA IL IN MI OH WI E
12 12 12 12 12

Arbor for Saw Hole 2 1/4IN (1136721). Unit consists of hex shank and 1/4in high speed drill, fits 1/2in chuck.



1173013

DISPENSER WIRE

300085669 DISPENSER SAFETY GUY WIRE

N EA 1 2 34 E

A wire dispenser designed to provide safe, easy, completely controlled handling and paying out of strand coils up to 500ft in length.

DISTRIBUTION SERVICES

NETWORK SERVICES

TOOLS

BUILDING JANITORIAL

AUTOMOTIVE

FORMS/OFFICE SUPPLIES

GENERAL

DATA VOICE

DRILL

PRODUCT IDENTIFIER		DESCRIPTION						
ITEM NUMBER	ORD. MULT.	SELL UNIT	STD. STOCK	PKG. AVAILABILITY	LEAD TIME / PA	MIN. ORD.	A C	
400137642 DRILL AUTOMATIC B WITH POINTS								
1215491	1	EA	IL 12	IN 12	MI 12	OH 12	WI 12	E
CA07137. A push type automatic drill used to start holes for wood screws and self-tapping screws, BSP 080-115-101.								



1215491

PRODUCT IDENTIFIER		DESCRIPTION						
ITEM NUMBER	ORD. MULT.	SELL UNIT	STD. STOCK	PKG. AVAILABILITY	LEAD TIME / PA	MIN. ORD.	A C	
400137667 DRILL CABLE CA06797								
1165696	1	EA	IL 12	IN 12	MI 12	OH 12	WI 12	E
A cable drill bit used for drilling holes (size: .0221in) in lead cable sheath and/or sleeves, BSP 081-600-100.								

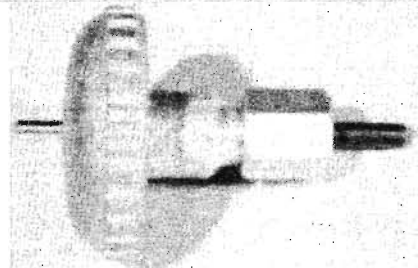

1165696

400291704 DRILL CABLE D CA07533								
N		EA		1		5	3	E

PRODUCT IDENTIFIER		DESCRIPTION						
ITEM NUMBER	ORD. MULT.	SELL UNIT	STD. STOCK	PKG. AVAILABILITY	LEAD TIME / PA	MIN. ORD.	A C	
260329917 DRILL CORDLESS 3/8IN 6093DW								
1946723	1	EA	IL 12	IN 12	MI 12	OH 12	WI 12	E
A cordless drill used with Battery Rechargeable 9.6 Volts DC (1959841) and Charger Battery Auto 9.6 Volts DC (1959833).								



1946723

PRODUCT IDENTIFIER		DESCRIPTION						
ITEM NUMBER	ORD. MULT.	SELL UNIT	STD. STOCK	PKG. AVAILABILITY	LEAD TIME / PA	MIN. ORD.	A C	
401117395 DRILL ELECTRIC D CA08677								
1974055	1	EA	IL 12	IN 12	MI 12	OH 12	WI 12	E
A 3/8in chuck, pistol grip, variable speed, reversible, double insulated, electric drill, used for metal, masonry and wood, BSP 074-211-124.								

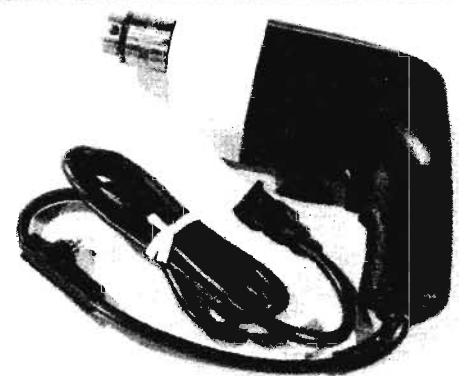

1974055

PRODUCT IDENTIFIER		DESCRIPTION						
ITEM NUMBER	ORD. MULT.	SELL UNIT	STD. STOCK	PKG. AVAILABILITY	LEAD TIME / PA	MIN. ORD.	A C	
900385832 DRILL FOUR POINT 1/2IN X 18IN								
1333583	1	EA	IL 12	IN 12	MI 12	OH 12	WI 12	E
A hand held steel four point star masonry drill.								



1333583

PRODUCT IDENTIFIER		DESCRIPTION						
ITEM NUMBER	ORD. MULT.	SELL UNIT	STD. STOCK	PKG. AVAILABILITY	LEAD TIME / PA	MIN. ORD.	A C	
900385824 DRILL FOUR POINT 3/8IN X 18IN								
1333591	1	EA	IL 12	IN 12	MI 12	OH 12	WI 12	E
A hand held steel four point star masonry drill.								

280095514 DRILL GAS TANAKA TED-262								
N		EA		1		2	1	E

260323209 DRILL HAMMER 1/2IN TM-7S VSR								
N		EA		1		2	1	E

280011321 DRILL HAMMER 3/8IN 5392-1								
N		EA		1		2	1	E
A variable speed electric hammer drill e/w 3/8in geared key type chuck, removable side handle and depth gauge. Modified to disable trigger locking feature, part of Kit Drill Hammer 5397-1 (300086113).								

300085677 DRILL HAMMER 3/8IN 5392-1								
N		EA		1		2	1	E
Modification required.								

260439989 DRILL STAR #806								
N		EA		1		2	1	
Air impact tool parts.								

400138020 DRILL TWIST B30 CA07790								
N		EA		1		3	84	E
A twist steel carbide bit to drill through steel with a portable electric drill. Length: 2 3/4 in. Hole size: 9/64in. See Set Drill Twist B (1242305), BSP 074-600-101.								

PRODUCT IDENTIFIER		DESCRIPTION				
ITEM NUMBER	ORD. MULT.	SELL UNIT	STD. PKG. STOCK AVAILABILITY / PA	LEAD TIME	MIN. ORD.	A C

PRODUCT IDENTIFIER		DESCRIPTION				
ITEM NUMBER	ORD. MULT.	SELL UNIT	STD. PKG. STOCK AVAILABILITY / PA	LEAD TIME	MIN. ORD.	A C

DRILL EXTENSION D & E

SEE BIT EXTENSION D/E

DRILL MASONRY

900207762	N	EA	2	4	16	E	DRILL MASONRY 3/8 X 18 X 5/16
900207770	N	EA	3	4	30	E	DRILL MASONRY 300 1/2 X 6 X 3/8
900207788	N	EA	2	4	14	E	DRILL MASONRY 300 1/2 X 18 X 3/8
900209115	N	EA	6	4	42	E	DRILL MASONRY 300 3/8 X 4 X 1/4
900207754	N	EA	2	4	20	E	DRILL MASONRY 300 3/8 X 12 X 5/16
900207747	N	EA	12	4	48	E	DRILL MASONRY 300 5/16 X 4 X 1/4
900235334	N	EA	1	4	21	E	DRILL MASONRY CRB 5/8 X 6 X 1/2IN

900207697	7416743	1	EA	IL 12	IN 12	MI 12	OH 12	WI 12	E	DRILL MASONRY PERCUS 1/4IN
-----------	---------	---	----	-------	-------	-------	-------	-------	---	----------------------------

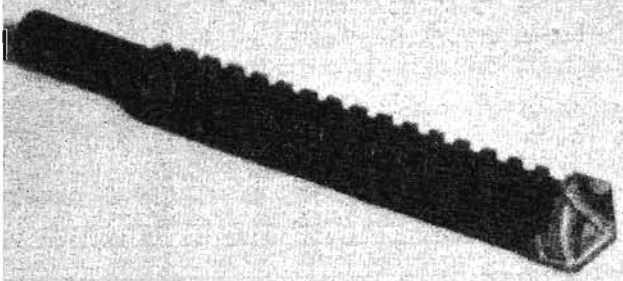

7416743

900207713	7417543	1	EA	IL 12	IN 12	MI 12	OH 12	WI 12	E	DRILL MASONRY PERCUS 3/8IN
-----------	---------	---	----	-------	-------	-------	-------	-------	---	----------------------------

900207689	7416685	1	EA	IL 12	IN 12	MI 12	OH 12	WI 12	E	DRILL MASONRY PERCUS 3/16IN
-----------	---------	---	----	-------	-------	-------	-------	-------	---	-----------------------------

900207705	7416768	1	EA	IL 12	IN 12	MI 12	OH 12	WI 12	E	DRILL MASONRY PERCUS 5/16IN
-----------	---------	---	----	-------	-------	-------	-------	-------	---	-----------------------------

DRILL MASONRY B

CA08191. A carbide tip masonry drill bit for use in a low speed (500-700 RPM) electric drill (not for drilling with a hammer). The numbers after each item are (1) hole size (2) overall length.

400460093	1101733	1	EA							E	DRILL MASONRY B 1/2IN X 6IN
-----------	---------	---	----	--	--	--	--	--	--	---	-----------------------------

400460093

400465670	1102392	1	EA	IL 12	IN 12	MI 12	OH 12	WI 12	E	DRILL MASONRY B 1/2IN X 18IN
-----------	---------	---	----	-------	-------	-------	-------	-------	---	------------------------------

400460101	1102418	1	EA	IL 12	IN 12	MI 12	OH 12	WI 12	E	DRILL MASONRY B 1/4IN X 4IN
-----------	---------	---	----	-------	-------	-------	-------	-------	---	-----------------------------

401133285	1196493	1	EA	IL 12	IN 12	MI 12	OH 12	WI 12	E	DRILL MASONRY B 1/4IN X 18IN
-----------	---------	---	----	-------	-------	-------	-------	-------	---	------------------------------

900207663	6179689	1	EA	IL 12	IN 12	MI 12	OH 12	WI 12	E	DRILL MASONRY B 3/4IN X 6IN
-----------	---------	---	----	-------	-------	-------	-------	-------	---	-----------------------------

900207622	1132019	1	EA	IL 12	IN 12	MI 12	OH 12	WI 12	E	DRILL MASONRY B 3/8IN X 6IN
-----------	---------	---	----	-------	-------	-------	-------	-------	---	-----------------------------

400465704	1102459	1	EA	IL 12	IN 12	MI 12	OH 12	WI 12	E	DRILL MASONRY B 3/8IN X 18IN
-----------	---------	---	----	-------	-------	-------	-------	-------	---	------------------------------

900207648	7178707	1	EA	IL 12	IN 12	MI 12	OH 12	WI 12	E	DRILL MASONRY B 5/8IN X 6IN
-----------	---------	---	----	-------	-------	-------	-------	-------	---	-----------------------------

900207655	1219188	1	EA	IL 12	IN 12	MI 12	OH 12	WI 12	E	DRILL MASONRY B 5/8IN X 18IN
-----------	---------	---	----	-------	-------	-------	-------	-------	---	------------------------------

900207671	N	EA	3				2	9	E	DRILL MASONRY B 7/8IN X 6IN
-----------	---	----	---	--	--	--	---	---	---	-----------------------------

400465688	1102434	1	EA	IL 12	IN 12	MI 12	OH 12	WI 12	E	DRILL MASONRY B 3/16IN X 3IN
-----------	---------	---	----	-------	-------	-------	-------	-------	---	------------------------------

400465712	1102467	1	EA	IL 12	IN 12	MI 12	OH 12	WI 12	E	DRILL MASONRY B 5/16IN X 4IN
-----------	---------	---	----	-------	-------	-------	-------	-------	---	------------------------------

900207630	N	EA	6				2	24	E	DRILL MASONRY B 7/16IN X 6IN
-----------	---	----	---	--	--	--	---	----	---	------------------------------

DISTRIBUTION SERVICES

NETWORK SERVICES

TOOLS

BUILDING JANITORIAL

AUTOMOTIVE

FORMS/OFFICE SUPPLIES

GENERAL

DATA VOICE

DRILL MASONRY L

DISTRIBUTION SERVICES

PRODUCT IDENTIFIER		DESCRIPTION					
ITEM NUMBER	ORD. MULT.	SELL UNIT	STD. PKG.	LEAD TIME	MIN. ORD.	A C	
			STOCK AVAILABILITY / PA				

DRILL MASONRY L

CA06558. A drill bit for drilling holes in masonry walls to secure building attachments with anchoring devices. Designed to fit into L drill holder and electric hammer. BSP 081-745-111.

400137998	1	EA							E
-----------	---	----	--	--	--	--	--	--	---



400137998

400137949	1	EA	IL	IN	MI	OH	WI		E
1185215			12	12	12	12	12		

400137972	1	EA	IL	IN	MI	OH	WI		E
1162065			12	12	12	12	12		

900154840	N	EA	3	3	3				E
-----------	---	----	---	---	---	--	--	--	---

400137931	1	EA	IL	IN	MI	OH	WI		E
1198705			12	12	12	12	12		

400137964	1	EA	IL	IN	MI	OH	WI		E
1171215			12	12	12	12	12		

400137980	N	EA	6	3	6				E
-----------	---	----	---	---	---	--	--	--	---

DRILL SURFACE TREATED

High Speed Drill Bit, jobber length.

900283896	1	EA							E
1152587									

900284019	1	EA	IL	IN	MI	OH	WI		E
1152728			12	12	12	12	12		



1152728

900283961	1	EA	IL	IN	MI	OH	WI		E
1152686			12	12	12	12	12		

NETWORK SERVICES

TOOLS

BUILDING JANITORIAL

AUTOMOTIVE

FORMS/OFFICE SUPPLIES

GENERAL

DATA VOICE

PRODUCT IDENTIFIER		DESCRIPTION					
ITEM NUMBER	ORD. MULT.	SELL UNIT	STD. PKG.	LEAD TIME	MIN. ORD.	A C	
			STOCK AVAILABILITY / PA				

900283938	1	EA	IL	IN	MI	OH	WI		E
2780783			12	12	12	12	12		

900208315	1	EA	IL	IN	MI	OH	WI		E
1188235			12	12	12	12	12		

900283979	1	EA	IL	IN	MI	OH	WI		E
2780825			12	12	12	12	12		

900208497	1	EA	IL	IN	MI	OH	WI		E
1193439			12	12					

DISCONTINUE UPON STOCK DEPLETION.

900208513	N	EA	1	4	60				E
-----------	---	----	---	---	----	--	--	--	---

DISCONTINUE UPON STOCK DEPLETION.

400460622	1	EA	IL	IN	MI	OH	WI		E
5141929			12	12					

DISCONTINUE UPON STOCK DEPLETION.

900208562	1	EA	IL	IN	MI	OH	WI		E
5142042			12	12					

DISCONTINUE UPON STOCK DEPLETION.

900208349	1	EA	IL	IN	MI	OH	WI		E
6188060			12	12					

DISCONTINUE UPON STOCK DEPLETION.

DRIVER HEX SET

300085693	N	EA	1	2	1				E
-----------	---	----	---	---	---	--	--	--	---

Set includes 9 blades from .050 to 3/16in, a 4in extension and plastic handle. Set comes in a see through case.

DRIVER NUT

280019415	1	EA							E
1971291									

Used to drive 1/4in hex head screws.

300048980	1	EA	IL	IN	MI	OH	WI		E
1169417			12	12	12	12	12		

Non-magnetic. Used to drive hexagon head self-tapping screws.

260395181	N	EA	6	2	6				E
-----------	---	----	---	---	---	--	--	--	---

280019431	N	EA	1	2	1				E
No. 11			272SC020.						

PRODUCT IDENTIFIER DESCRIPTION

ITEM NUMBER	ORD. MULT.	SELL UNIT	STD. PKG. STOCK AVAILABILITY / PA	LEAD TIME	MIN. ORD.	A C
-------------	------------	-----------	-----------------------------------	-----------	-----------	-----

280037391 DRIVER NUT FIXED HANDLE DRILL SHAFT
 N EA 6 2 6 E
 1/4in No. 8 272SC144.

002078954 DRIVER NUT ND8
 N EA 6 4 6 E
 1/4in nut driver for hexagon self tapping screws. DISCONTINUE UPON STCK DEPLETION. REPLACED BY DRIVER NUT 1/4IN (1971291).



002078954

260358163 DRIVER NUT SET 7 PIECE STANDARD
 1953133 1 EA IL IN MI OH WI 12 12 12 12 12 E

Used with new hex head screws.

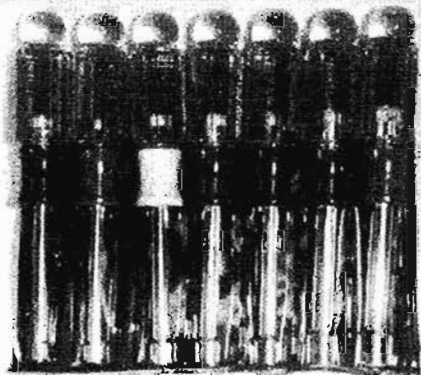

1953133

260371604 DRIVER NUT SET 13 PIECE POWER
 1956227 1 SE IL IN MI OH WI 12 12 12 12 12 E

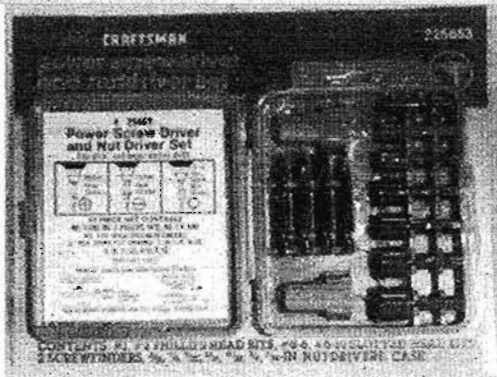

1956227

DRIVER POST

300088648 DRIVER POST D-400
 N EA 1 4 1 E

PRODUCT IDENTIFIER DESCRIPTION

ITEM NUMBER	ORD. MULT.	SELL UNIT	STD. PKG. STOCK AVAILABILITY / PA	LEAD TIME	MIN. ORD.	A C
-------------	------------	-----------	-----------------------------------	-----------	-----------	-----

DRIVER SOCKET

260412218 DRIVER SOCKET FOR KIT WRENCH D
 1979948 1 EA E
 Screwdriver handle with 3/8In socket.

DUSTER

300070034 DUSTER COMPRESSED AIR TX2500
 6512780 1 EA E
 Equipped with Nozzle and Extension.



300070034

ELEMENT

400004719 ELEMENT CK08740 L71
 N EA 1 5 3 E

280016635 ELEMENT E476B170 95W
 N EA 1 2 1 E

260329487 ELEMENT HEATING S-65
 N EA 1 3 1 E

900154931 ELEMENT SOLDER ELECTRIC 9273
 1154765 1 EA IL IN MI OH WI 12 12 E



1154765

DISTRIBUTION SERVICES

NETWORK SERVICES

TOOLS

BUILDING JANITORIAL

AUTOMOTIVE

FORMS/OFFICE SUPPLIES

GENERAL

DATA VOICE

DISTRIBUTION SERVICES

EXPANDER

PRODUCT IDENTIFIER		DESCRIPTION					
ITEM NUMBER	ORD. MULT.	SELL UNIT	STD. STOCK	PKG. AVAILABILITY / PA	LEAD TIME	MIN. ORD.	A C

EMERY CLOTH

SEE CLOTH EMERY.

NETWORK SERVICES

EXPANDER

300060209 EXPANDER 1502 WITH ACCESSORY

1925750	1	EA						E
---------	---	----	--	--	--	--	--	---

Identifies wires, fault locating, and locating the depth and path of buried cables. Replaces Set Test 91A.

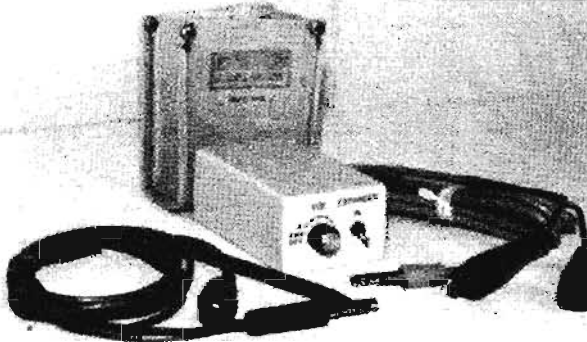

300060209

TOOLS

BUILDING JANITORIAL

280046400 EXPANDER 1503 WITH CORDS

1925768	1	EA	IL	IN	MI	OH	WI	E
			12	12	12	12	12	

A speaker used with Expander 1502.

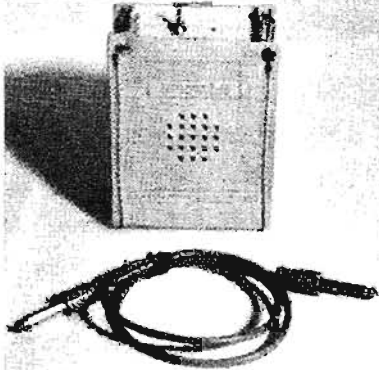

1925768

AUTOMOTIVE

FORMS/OFFICE SUPPLIES

GENERAL

DATA VOICE

PRODUCT IDENTIFIER		DESCRIPTION					
ITEM NUMBER	ORD. MULT.	SELL UNIT	STD. STOCK	PKG. AVAILABILITY / PA	LEAD TIME	MIN. ORD.	A C

300068582 EXPANDER 1504 W/O ACCESSORY

1332320	1	EA	IL	IN	MI	OH	WI	E
			12	12	12	12	12	

For use with the Expander 1502. Identifies wires, fault locating and locating the depth and path of buried cables.

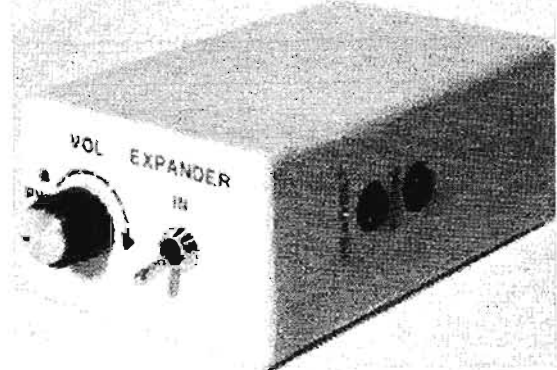

1332320

300068590 EXPANDER 1505 WITH AMPLIFIER

1332312	1	EA	IL	IN	MI	OH	WI	E
			12	12	12			

ACCESSORY KIT



1332312

EXTENDER

300085743 EXTENDER EXT 400

N		EA	1		2		1	E
---	--	----	---	--	---	--	---	---

An accessory for the Toll Wire Wrap 14RF2-27600 AA4.

EXTENSION

300086279 EXTENSION LIGHTER PLUG

N		EA	1		1		1	E
---	--	----	---	--	---	--	---	---

To be used with spot-lites and rotating yellow flasher lights on Company vehicles.

280014234 EXTENSION SOCKET 3IN 814

N		EA	1		2		1	E
---	--	----	---	--	---	--	---	---

Air impact tool parts.

PRODUCT IDENTIFIER DESCRIPTION

ITEM NUMBER	ORD. MULT.	SELL UNIT	STD. PKG. STOCK AVAILABILITY / PA	LEAD TIME	MIN. ORD.	A C
-------------	------------	-----------	-----------------------------------	-----------	-----------	-----

400291100 EXTENSION WRENCH D CA08381
 1155507 1 EA 12 12 12 12 12 E
 For 3/8in drive.



1155507

PRODUCT IDENTIFIER DESCRIPTION

ITEM NUMBER	ORD. MULT.	SELL UNIT	STD. PKG. STOCK AVAILABILITY / PA	LEAD TIME	MIN. ORD.	A C
-------------	------------	-----------	-----------------------------------	-----------	-----------	-----

FILAMENT
400140158 FILAMENT FOR F GAS INDICATOR
 2792127 1 EA P/N40000013, BSP 081-700-106. E



400140158

EXTRACTOR

400139663 EXTRACTOR ANCHOR CA06796
 1102475 1 EA E
 For removing hammer drive anchors from masonry, BSP 627-610-200.



400139663

401808407 EXTRACTOR CK21838 L1
 N EA 1 3 1 E

EYEGGLASS

280016650 EYEGGLASS LOUPES E11B114 8X18
 N EA 1 3 1 E
 Attach to eyeglass temples to reduce eye strain when inspecting and assembling small parts.

300086261 EYEGGLASS LOUPES N11B135 4X7
 N EA 1 2 2 E

FILE

996673596 FILE EQUALING 6 CK02663
 1156042 1 EA E
 Double cut swiss used on round type relays, keys and telegraph relays, BSP 074-217-110.



996673596

401331103 FILE FLAT SMOOTH 6 IN
 N EA 12 2 12 E
 Replaced by File H Smooth Mill (1155960).



401331103

400140182 FILE H COMBINATION CA06779
 1155903 1 EA 12 12 12 12 12 E
 Has double bastard cut on one side and single smooth cut on the other, used on soldering coppers and general file work. 1in x 12 1/4in, BSP 074-217-110.



1155903

400140208 FILE H LEAD CA06779
 1155945 1 EA 12 12 12 12 12 E
 Single float cut file with 4in integral handle and 10in cutting surface. Used for preparing lead sleeves for wiping.



1155945

FILE

DISTRIBUTION SERVICES

PRODUCT IDENTIFIER		DESCRIPTION					
ITEM	ORD.	SELL	STD. PKG.	LEAD TIME		MIN.	A
NUMBER	MULT.	UNIT	STOCK AVAILABILITY / PA		ORD.	C	
400140216 FILE H SMOOTH MILL CA06779							
1155960	1	EA	IL	IN	MI	OH	WI
			12	12	12	12	12
Mill-bastard cut file with 4in integral handle and 8in cutting surface. Used principally for tools and station ground.							



1155960

PRODUCT IDENTIFIER		DESCRIPTION					
ITEM	ORD.	SELL	STD. PKG.	LEAD TIME		MIN.	A
NUMBER	MULT.	UNIT	STOCK AVAILABILITY / PA		ORD.	C	
400144598 FLAG WARNING H 18IN CA08028							
2613604	1	EA	IL	IN	MI	OH	WI
			12	12	12	12	12
A vinyl fluorescent red warning flag e/w handle, BSP 620-135-100 & BSP 620-310-100.							

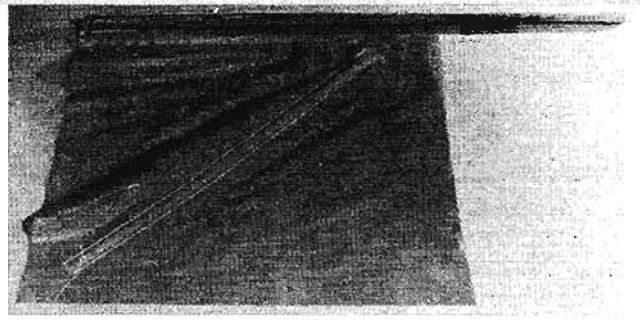

2613604

NETWORK SERVICES

TOOLS

FILTER							
400985826 FILTER COTTON 16499							
1146852	1	PK					E
401716287 FILTER INHIBITOR 0847740							
6318105	1	PK	IL	IN	MI	OH	WI
			12	12	12	12	12
Package of 6. Cotton filter used to prevent moisture and dust from getting into gas detection monitors, manufactured by MSA Co.							

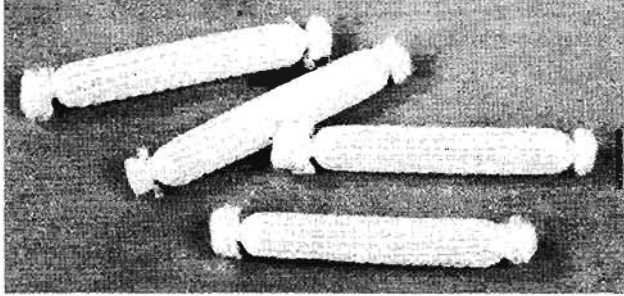

6318105

BUILDING JANITORIAL

AUTOMOTIVE

FORMS/OFFICE SUPPLIES

GENERAL

DATA VOICE

FLARE FUSE							
401400817 FLARE FUSE RED 104 20 MINUTE							
1157222	1	EA					E
Consists of chemical compound in a cardboard tube. Has a spike on bottom to stick in ground. Burning time 15 to 20 min.							



401400817

FLASHLIGHT							
400410700 BULB FLASHLIGHT PR 6 CA07882							
1198481	1	EA					
A flanged-base bulb for flashlights B and C.							
280062654 FLASHLIGHT 2618							
1934331	1	EA	IL	IN	MI	OH	WI
			12	12	12	12	12



1934331

300084951 FLASHLIGHT ADVA-LITE DISPOSABLE 001							
N		EA	1		3		100 E
Disposable flashlight for coin collectors.							

FINDER							
260448253 FINDER PULL C CAO 8485 IS.1							
N							

FLAG WARNING							
401400783 FLAG WARNING 18IN X 18IN NYLON							
N		EA	5		2		25 E
Vinyl coated flourscent red-orange with 36in staff.							

300085818 FLAG WARNING FL213 24IN							
N		EA	1		2		1 E
A 13in X 13in red stiffened flag on a 24in wood staff.							

DISTRIBUTION SERVICES

NETWORK SERVICES

TOOLS

BUILDING JANITORIAL

AUTOMOTIVE

FORMS/OFFICE SUPPLIES

GENERAL

DATA VOICE

PRODUCT IDENTIFIER		DESCRIPTION				
ITEM NUMBER	ORD. MULT.	SELL UNIT	STD. PKG. STOCK AVAILABILITY / PA	LEAD TIME	MIN. ORD.	A C

400144812 FLASHLIGHT C CA07724
 1157263 1 EA IL IN MI OH WI E
 12 12 12 12 12
 A two cell, prefocused, flat lens and a reflector designed to produce a spotlight in a small area, BSP 074-217-121.



1157263

260322151 FLASHLIGHT MICRO-MAX 2
 1942805 1 EA IL IN MI OH WI E
 12 12 12 12 12
 A 5 1/8in X 5/8in two cell, high intensity, adjustable beam flashlight. Uses two AA size Alkaline batteries. DISCONTINUE UPON STOCK DEPLETION

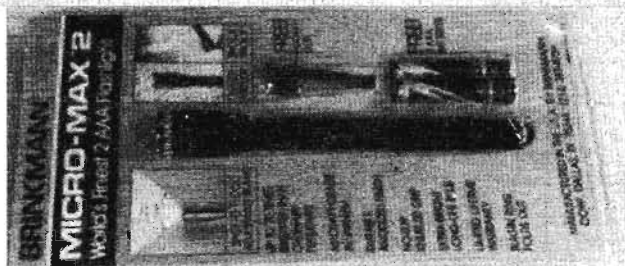

1942805

260318076 FLASHLIGHT MINI MAGLITE 2AA
 N EA 1 2 1 E
 Uses Lamp T1 (260391099) and Holster (260329891) for carrying flashlight.

260414990 FLASHLIGHT MINI MAGLITE 2AA COMBO
 1972596 1 EA IL IN MI OH WI E
 12 12 12 12 12
 Includes flashlight, holster, and lamp.

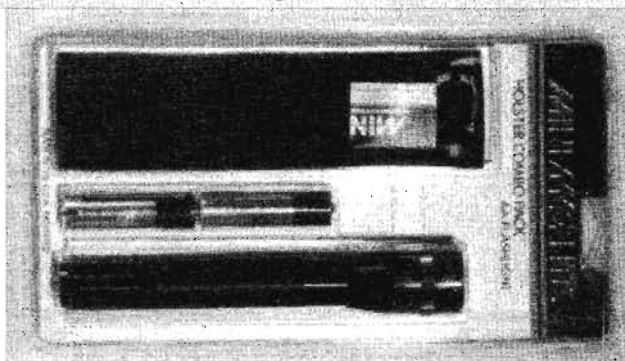

1972596

300085834 FLASHLIGHT R4554
 N EA 1 2 6 E
 Optical magnifier magnalite, for replacement (bulb) use Lamp Magnifier R4554 (401775077).

PRODUCT IDENTIFIER		DESCRIPTION				
ITEM NUMBER	ORD. MULT.	SELL UNIT	STD. PKG. STOCK AVAILABILITY / PA	LEAD TIME	MIN. ORD.	A C

401331459 FLASHLIGHT REPAIRMAN S 2105-4
 1173690 1 EA IL IN MI OH WI E
 12 12 12 12 12

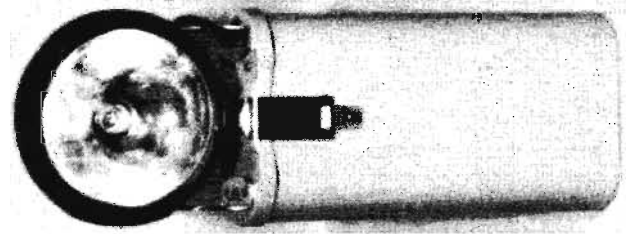

1173690

FLINT
400144838 FLINT LIGHTER RENEWAL
 1175976 1 BX E
 Extra flints for Lighter Friction CA07932 (1434928). For lighting soldering iron, box of 6.



400144838

FLOODLIGHT
400144846 FLOODLIGHT B CA7659
 N EA 5 1 5 E

FOOT STOOL
 SEE STOOL FOOT.

FRAME
280015504 FRAME EARTH CONTACT 3014
 N EA 1 6 1 E
 Field accessory for 3M locators.

DISTRIBUTION SERVICES

NETWORK SERVICES

TOOLS

BUILDING JANITORIAL

AUTOMOTIVE

FORMS/OFFICE SUPPLIES

GENERAL

DATA VOICE

FURNACE

PRODUCT IDENTIFIER		DESCRIPTION				
ITEM NUMBER	ORD. MULT.	SELL UNIT	STD. PKG. STOCK AVAILABILITY / PA	LEAD TIME	MIN. ORD.	A C

FURNACE

280057217 FURNACE MICRO

1931006 1 EA E
Ceramic furnace is powered by 120 Volt AC, 1500 Watt Current.



280057217

400145892 FURNACE PROPANE D CA08299

1151357 1 EA E
IL IN MI OH WI
12 12 12 12 12
Furnace unit includes handle, top body base and control valve, BSP 081-330-115.

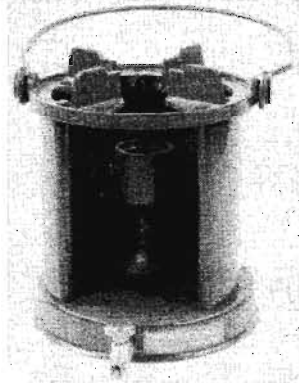

1151357

GAUGE

100204486 GAUGE 70 J
N EA 1 13 1 E
For measuring the tension of a relay spring, BSP 084-103-101.

PRODUCT IDENTIFIER		DESCRIPTION				
ITEM NUMBER	ORD. MULT.	SELL UNIT	STD. PKG. STOCK AVAILABILITY / PA	LEAD TIME	MIN. ORD.	A C

GAUGE PRESSURE

SEE PRESSURIZATION AIR CABLE EQUIPMENT.

GLASSES SAFETY

300077567 GLASSES SAFETY 2001S010 CLEAR

5124073 1 PR E

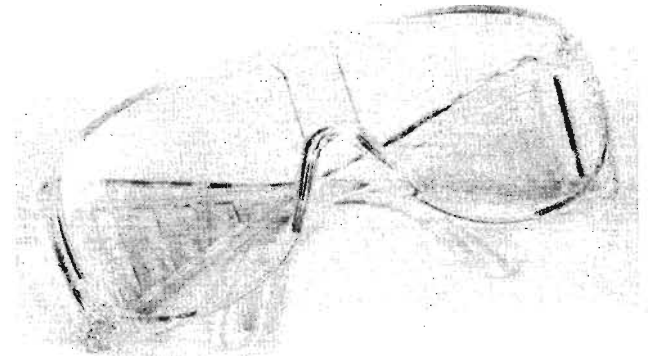

300077567

300077708 GLASSES SAFETY 2001S011 SUN GRAY

5124149 1 PR E

Wraparound Polycarbonate sunglass lens.

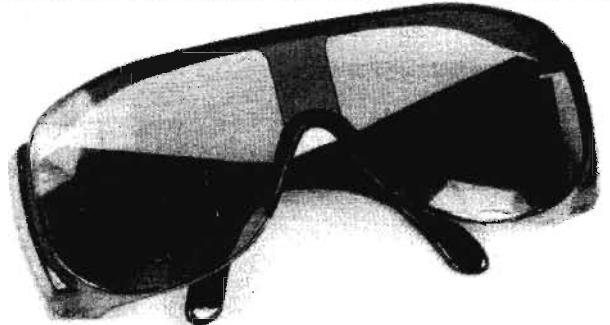

5124149

002043198 GLASSES SAFETY F2048SM20 CLEAR 511A

5258442 1 PR E
IL IN MI OH WI
12 12 12

SM20 poly.

002043206 GLASSES SAFETY F2048SM22 CLEAR 511A

5258467 1 PR E
IL IN MI OH WI
12

002043214 GLASSES SAFETY F2050SM22 CLEAR 511A

5258582 1 PR E
IL IN MI OH WI
12 12

Poly.

002043230 GLASSES SAFETY F2050SM24 CLEAR 511A

5258608 1 PR E
IL IN MI OH WI
12

SM24.

DISTRIBUTION SERVICES

NETWORK SERVICES

TOOLS

BUILDING JANITORIAL

AUTOMOTIVE

FORMS/OFFICE SUPPLIES

GENERAL

DATA VOICE

PRODUCT IDENTIFIER		DESCRIPTION						MIN. A
ITEM NUMBER	ORD. MULT.	SELL UNIT	STD. PKG.		LEAD TIME		ORD. C	
			STOCK AVAILABILITY / PA					
002043248 GLASSES SAFETY F2052SM22 CLEAR 511A								
5258780	1	PR	IL	IN	MI	OH	WI	E
			12					
Poly.								
002043255 GLASSES SAFETY F2052SM24 CLEAR 511A								
1133637	1	PR	IL	IN	MI	OH	WI	E
			12					
SM24 Poly.								

GLOVE

260301023 GLOVE 444 LINED LARGE								
N		DZ	1		1		1	E
Flocked yellow.								
260301031 GLOVE 444 LINED XLARGE								
N		DZ	1		1		1	E
Flocked yellow.								

900572686 GLOVE ACID 36-755 SIZE 11								
1229047	1	PR	IL	IN	MI	OH	WI	E
			12	12	12	12	12	
Used for installation and maintenance of storage batteries and counter EMF cells only, 14in long, .040 guage.								



1229047

300006822 GLOVE COTTON UTILITY								
6500538	1	DZ	IL	IN	MI	OH	WI	E
			12	12	12	12	12	

900212143 GLOVE COTTON WHITE MAGID T83								
N		PR	12		2		12	E

PRODUCT IDENTIFIER		DESCRIPTION						MIN. A
ITEM NUMBER	ORD. MULT.	SELL UNIT	STD. PKG.		LEAD TIME		ORD. C	
			STOCK AVAILABILITY / PA					
402670541 GLOVE DISPOSABLE LARGE EMB125								
1433565	1	BX	IL	IN	MI	OH	WI	E
			12	12	12	12	12	
Package of 100. A disposable plastic glove for use when handling toxic materials, BSP 081-856-101.								



1433565

280029323 GLOVE DISPOSABLE VINYL XLARGE								
N		BX	1		12		1	E
34-100.								

402403570 GLOVE FIRE RESISTANT								
1178087	1	PR	IL	IN	MI	OH	WI	E
			12	12	12	12	12	



1178087

400146627 GLOVE WIPING B SIZE 10 1/2								
1455329	1	PR	IL	IN	MI	OH	WI	E
			12	12	12	12	12	
For use when wiping joints, CA08314.								

GLOVE DRIVER

260386446 GLOVE DRIVER LINED LARGE								
1963728	1	PR						E
A pigskin, cotton lined work glove for general use.								

260386438 GLOVE DRIVER LINED MEDIUM								
1963710	1	PR	IL	IN	MI	OH	WI	E
			12	12	12	12	12	

260386420 GLOVE DRIVER LINED SMALL								
1963702	1	PR	IL	IN	MI	OH	WI	E
			12	12	12	12	12	

260386453 GLOVE DRIVER LINED XLARGE								
1963736	1	PR	IL	IN	MI	OH	WI	E
			12	12	12	12	12	

DISTRIBUTION SERVICES

NETWORK SERVICES

TOOLS

BUILDING JANITORIAL

AUTOMOTIVE

FORMS/OFFICE SUPPLIES

GENERAL

DATA VOICE

GLOVE DRIVER

PRODUCT IDENTIFIER		DESCRIPTION							MIN. A
ITEM NUMBER	ORD. MULT.	SELL UNIT	STD. PKG. STOCK AVAILABILITY / PA	LEAD TIME			OH	WI	ORD. C
260386487 GLOVE DRIVER UNLINED LARGE									
1963769	1	PR	IL 12	IN 12	MI 12	OH 12	WI 12		E
A split cowhide, unlined work glove for general use.									
260386479 GLOVE DRIVER UNLINED MEDIUM									
1963751	1	PR	IL 12	IN 12	MI 12	OH 12	WI 12		E



1963751

260386461 GLOVE DRIVER UNLINED SMALL									
1963744	1	PR	IL 12	IN 12	MI 12	OH 12	WI 12		E
260386495 GLOVE DRIVER UNLINED XLARGE									
1963777	1	PR	IL 12	IN 12	MI 12	OH 12	WI 12		E
260386511 GLOVE DRIVER WINTER LARGE 1011PL									
1963793	1	PR	IL 12	IN 12	MI 12	OH 12	WI 12		E
A fleece rawhide, lined glove for cold weather use.									
260386503 GLOVE DRIVER WINTER MEDIUM 1011PL									
1963785	1	PR	IL 12	IN 12	MI 12	OH 12	WI 12		E
260386529 GLOVE DRIVER WINTER XLARGE 1011PL									
1963801	1	PR	IL 12	IN 12	MI 12	OH 12	WI 12		E

GLOVE FINGERLESS

280056904 GLOVE FINGERLESS 14487-MA LARGE									
N		PR	1			6		1	E
Framemen no padding.									
280056888 GLOVE FINGERLESS 14487-MA SMALL									
N		PR	1			3		1	E
Framemen no padding.									
280056896 GLOVE FINGERLESS 14487-MA MEDIUM									
N		PR	1			6		1	E
Framemen no padding.									

PRODUCT IDENTIFIER		DESCRIPTION							MIN. A
ITEM NUMBER	ORD. MULT.	SELL UNIT	STD. PKG. STOCK AVAILABILITY / PA	LEAD TIME			OH	WI	ORD. C
900212150 GLOVE FINGERLESS SIZE 7									
1333617	1	PR	IL 12	IN 12	MI 12	OH 12	WI 12		E
Leather cape skin.									

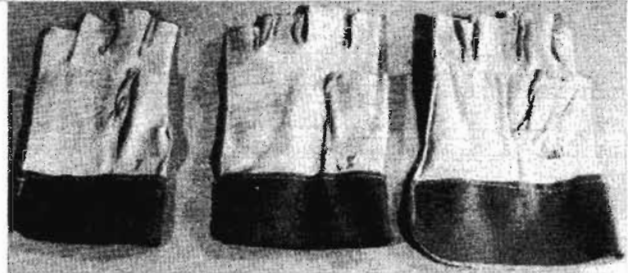

1333617

900212176 GLOVE FINGERLESS SIZE 9									
1166454	1	PR	IL 12	IN 12	MI 12	OH 12	WI 12		E
R4248.									
900212184 GLOVE FINGERLESS SIZE 10									
1159756	1	PR	IL 12	IN 12	MI 12	OH 12	WI 12		E
R4248.									
900212192 GLOVE FINGERLESS SIZE 11									
1189183	1	PR	IL 12	IN 12	MI 12	OH 12	WI 12		E

GLOVE INSULATING

401394309 GLOVE INSULATING E SIZE 8									
N		PR	1			1		1	E
CA08440.									
400329108 GLOVE INSULATING E SIZE 9 1/2									
1149492	1	PR	IL 12	IN 12	MI 12	OH 12	WI 12		E
CA08440. DISCONTINUE AND REPLACED BY GLOVE INS F 9 1/2 UPON STOCK DEPLETION									
400329116 GLOVE INSULATING E SIZE 10									
1135434	1	PR	IL 12	IN 12	MI 12	OH 12	WI 12		E
CA08440. DISCONTINUE AND REPLACED BY GLOVE INS F 10 UPON STOCK DEPLETION									
400329124 GLOVE INSULATING E SIZE 11									
1230078	1	PR	IL 12	IN 12	MI 12	OH 12	WI 12		E
CA08440. DISCONTINUE AND REPLACED BY GLOVE INS F 11 UPON STOCK DEPLETION									
400329132 GLOVE INSULATING E SIZE 12									
1136119	1	PR	IL 12	IN 12	MI 12	OH 12	WI 12		E
CA08440. DISCONTINUE AND REPLACED BY GLOVE INS F 12 UPON STOCK DEPLETION									

PRODUCT IDENTIFIER		DESCRIPTION					A
ITEM NUMBER	ORD. MULT.	SELL UNIT	STD. PKG. STOCK AVAILABILITY / PA	LEAD TIME	MIN. ORD.	WI	C

402156848 GLOVE INSULATING F SIZE 8								
1141390	1	PR	IL 12	IN 12	MI 12	OH 12	WI 12	E
Used for electrical protection, CA08439 - BSP 081-710-200.								

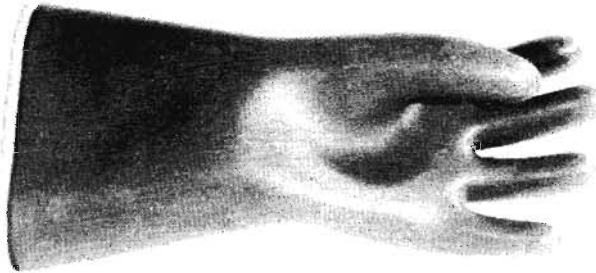

1141390

402156855 GLOVE INSULATING F SIZE 9 1/2								
1162297	1	PR	IL 12	IN 12	MI 12	OH 12	WI 12	E
CA08439.								

402156863 GLOVE INSULATING F SIZE 10								
1221077	1	PR	IL 12	IN 12	MI 12	OH 12	WI 12	E
CA08439.								

402156871 GLOVE INSULATING F SIZE 11								
1192732	1	PR	IL 12	IN 12	MI 12	OH 12	WI 12	E
CA08439.								

402156889 GLOVE INSULATING F SIZE 12								
1169615	1	PR	IL 12	IN 12	MI 12	OH 12	WI 12	E
CA08439.								

GLOVE LATEX

260380043 GLOVE LATEX SIZE 5-7								
1960583	1	BX						E
Multi-purpose.								

260380050 GLOVE LATEX SIZE 7 1/2-9								
1960575	1	BX	IL 12	IN 12	MI 12	OH 12	WI 12	E
Multi-purpose.								

900126707 GLOVE LATEX SIZE 9 26665B								
N		PR	12		3		12	E

260403118 GLOVE LATEX SIZE 10-11								
1969048	1	BX	IL 12	IN 12	MI 12	OH 12	WI 12	E
Multi-purpose.								

260404850 GLOVE LATEX SIZE 10-11 X-LARGE								
N		BX	1		2		1	E
Hand protection.								

PRODUCT IDENTIFIER		DESCRIPTION					A
ITEM NUMBER	ORD. MULT.	SELL UNIT	STD. PKG. STOCK AVAILABILITY / PA	LEAD TIME	MIN. ORD.	WI	C

GLOVE LEATHER

260386404 GLOVE LEATHER 3IN CUFF LARGE								
1963686	1	PR						E
A rawhide palm, cotton backed, unlined glove used by outside plant technicians.								



260386404

260386396 GLOVE LEATHER 3IN CUFF MEDIUM								
1963678	1	PR	IL 12	IN 12	MI 12	OH 12	WI 12	E

260404900 GLOVE LEATHER 3IN CUFF SMALL								
1969303	1	PR	IL 12	IN 12	MI 12	OH 12	WI 12	E

260386412 GLOVE LEATHER 3IN CUFF X-LARGE								
1963694	1	PR	IL 12	IN 12	MI 12	OH 12	WI 12	E

260386370 GLOVE LEATHER 5IN CUFF LARGE								
1963652	1	PR	IL 12	IN 12	MI 12	OH 12	WI 12	E
A rawhide palm, cotton backed, unlined glove used by outside plant technicians.								

260386362 GLOVE LEATHER 5IN CUFF MEDIUM								
1964189	1	PR	IL 12	IN 12	MI 12	OH 12	WI 12	E

260404918 GLOVE LEATHER 5IN CUFF SMALL								
1969311	1	PR	IL 12	IN 12	MI 12	OH 12	WI 12	E

260386388 GLOVE LEATHER 5IN CUFF X-LARGE								
1963660	1	PR	IL 12	IN 12	MI 12	OH 12	WI 12	E

900303744 GLOVE LEATHER LARGE								
N		PR	12		4		12	E
With elastic back, Magid.								

900303728 GLOVE LEATHER MEDIUM								
N		PR	12		4		12	E
With elastic back, Magid.								

900339821 GLOVE LEATHER PS1000 XLRG								
5195867	1	PR	IL 12	IN 12	MI 12	OH 12	WI 12	E
Equipped with elastic back, Magid.								

GLOVE LEATHER

PRODUCT IDENTIFIER		DESCRIPTION				
ITEM NUMBER	ORD. MULT.	SELL UNIT	STD. PKG. STOCK AVAILABILITY / PA	LEAD TIME	MIN. ORD.	A C
900303736			GLOVE LEATHER SMALL			
N		PR	12	4	12	E
With elastic back, Magid.						

PRODUCT IDENTIFIER		DESCRIPTION				
ITEM NUMBER	ORD. MULT.	SELL UNIT	STD. PKG. STOCK AVAILABILITY / PA	LEAD TIME	MIN. ORD.	A C

DISTRIBUTION SERVICES

NETWORK SERVICES

TOOLS

BUILDING JANITORIAL

AUTOMOTIVE

FORMS/OFFICE SUPPLIES

GENERAL

DATA VOICE

GLOVE LINEMAN

300052396			GLOVE LINEMAN WINTER LARGE			
6509398	1	PR				E
300080595			GLOVE LINEMAN WINTER MEDIUM			
6513473	1	PR	IL IN MI OH WI			E
			12 12 12 12 12			
300052404			GLOVE LINEMAN WINTER X-LARGE			
6509406	1	PR	IL IN MI OH WI			E
			12 12 12 12 12			

GLOVE LINER

400146544			GLOVE LINER FABRIC C7 CA07599			
1180349	1	PR				E
For glove sizes 9 1/2 & 10.						

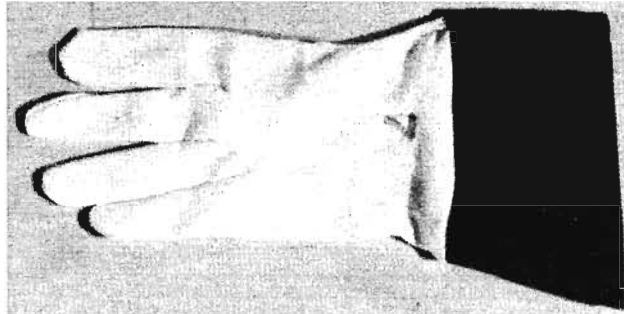

400146544

400146551			GLOVE LINER FABRIC C8 CA07599			
1180489	1	PR	IL IN MI OH WI			E
			12 12 12 12 12			
For glove sizes 11 & 12.						

900212051			GLOVE LINER KNITWRIST 11M			
1105932	1	PR	IL IN MI OH WI			E
			12 12 12 12 12			
Liners may be worn inside all types of insulating gloves for warmth in cold weather and for absorbing perspiration in warm weather.						

GLOVE PROTECTIVE

402087522			GLOVE PROTECT LEATHER D SIZE 8			
1926154	1	PR				E
CA07597.						



402087522

402087530			GLOVE PROTECT LEATHER D SIZE 9 1/2			
1926147	1	PR	IL IN MI OH WI			E
			12 12 12 12 12			

402087548			GLOVE PROTECT LEATHER D SIZE 10			
1166140	1	PR	IL IN MI OH WI			E
			12 12 12 12 12			
CA07597.						

402087555			GLOVE PROTECT LEATHER D SIZE 11			
1165746	1	PR	IL IN MI OH WI			E
			12 12 12 12 12			
CA07597.						

402087563			GLOVE PROTECT LEATHER D SIZE 12			
1102541	1	PR	IL IN MI OH WI			E
			12 12 12 12 12			
CA07597.						

GLOVE RUBBER

280009481			GLOVE RUBBER SIZE 9 1/2			
N		BX	1	2	1	E
Box of 12.						

300067709			GLOVE RUBBER LARGE			
6512111	1	DZ	IL IN MI OH WI			E
			12 12 12 12 12			
To protect hands when using housecleaning chemicals, scrubbing and general cleaning.						



6512111

PRODUCT IDENTIFIER		DESCRIPTION				
ITEM NUMBER	ORD. MULT.	SELL UNIT	STD. PKG. STOCK AVAILABILITY / PA	LEAD TIME	MIN. ORD.	A C

GLOVE WHIZARD

300049541	N	EA	133021	SMALL	1	1	1	E
300044534	N	EA	133023	MEDIUM	1	1	1	E
300044526	N	EA	133025	LARGE	1	1	1	E
300044542	N	EA	133065	WOMEN	1	1	1	E
300044468	N	EA	133068	XLARGE	1	1	1	E

260360532 GLOVE WHIZARD LARGE								
ITEM NUMBER	ORD. MULT.	SELL UNIT	IL	IN	MI	OH	WI	A C
1953711	1	EA	12	12	12	12	12	E

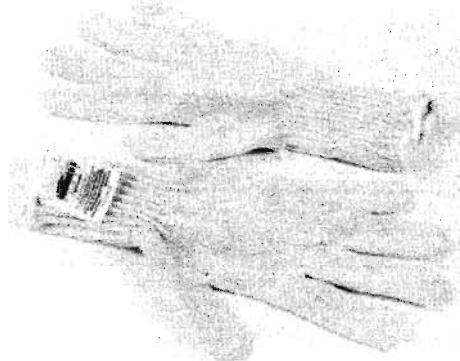

1953711

260360540 GLOVE WHIZARD MEDIUM								
ITEM NUMBER	ORD. MULT.	SELL UNIT	IL	IN	MI	OH	WI	A C
1953703	1	EA	12	12	12	12	12	E

260360557 GLOVE WHIZARD SMALL								
ITEM NUMBER	ORD. MULT.	SELL UNIT	IL	IN	MI	OH	WI	A C
1953695	1	EA	12	12	12	12	12	E

260360565 GLOVE WHIZARD XLARGE								
ITEM NUMBER	ORD. MULT.	SELL UNIT	IL	IN	MI	OH	WI	A C
1953729	1	EA	12	12	12	12	12	E

260360573 GLOVE WHIZARD XSMALL								
ITEM NUMBER	ORD. MULT.	SELL UNIT	IL	IN	MI	OH	WI	A C
1953737	1	EA	12	12	12	12	12	E

PRODUCT IDENTIFIER		DESCRIPTION				
ITEM NUMBER	ORD. MULT.	SELL UNIT	STD. PKG. STOCK AVAILABILITY / PA	LEAD TIME	MIN. ORD.	A C

GLOVE WOLVERINE

REPLACED BY GLOVE LEATHER 3IN CUFF

GOGGLE

300051604	6509117	1	EA	283547E				E
-----------	---------	---	----	---------	--	--	--	---



300051604

GRIP

280062589	N	EA	1613-30	CHICAGO KLEIN	1	5	1	E
-----------	---	----	---------	---------------	---	---	---	---

400720587 GRIP LASHING WIRE D CA08605								
ITEM NUMBER	ORD. MULT.	SELL UNIT	IL	IN	MI	OH	WI	A C
2756445	1	EA	12	12	12	12	12	E

For securing lashing wire temporarily to suspended strand to prevent loosening, BSP 627-330-202.

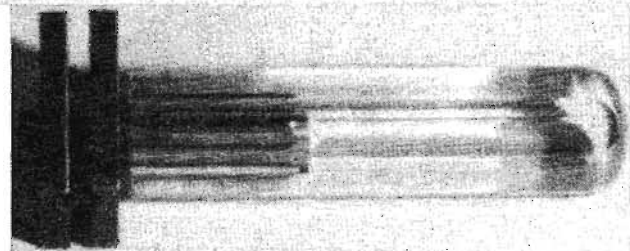

2756445

GRIP CABLE PLACING

Multiple strength pulling grip for use in placing, removing and/or tensioning cable in overhead transmission construction, BSP 081-410-102.

400146734	1180927	1	EA	3/4IN	GRIP CABLE PLACING			E
-----------	---------	---	----	-------	--------------------	--	--	---

CA06674. For cables 3/4in to 1in.

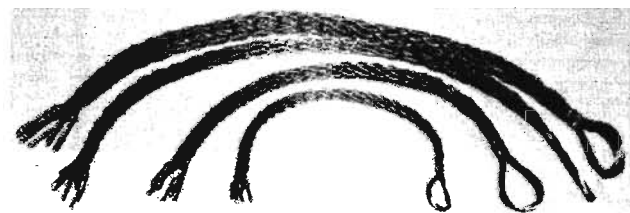

400146734

DISTRIBUTION SERVICES

GRIP CABLE PLACING

PRODUCT IDENTIFIER		DESCRIPTION							
ITEM NUMBER	ORD. MULT.	SELL UNIT	STD. PKG. STOCK AVAILABILITY / PA	LEAD TIME	MIN. ORD.	MI	OH	WI	A
400146742			GRIP CABLE PLACING 1 IN						
1334060	1	EA	IL IN MI OH WI 12 12 12 12 12						E
CA06674. For cables 1in to 1 1/2in.									
400146759			GRIP CABLE PLACING 1 1/2IN						
1180943	1	EA	IL IN MI OH WI 12 12 12 12 12						E
CA06674. For cables 1 1/2in to 2in.									
400146767			GRIP CABLE PLACING 2 IN						
1136176	1	EA	IL IN MI OH WI 12 12 12 12 12						E
CA06674. For cables 2in to 2 1/2in.									
400146775			GRIP CABLE PLACING 2 1/2IN						
1166439	1	EA	IL IN MI OH WI 12 12 12 12 12						E
CA06674. For cables 2 1/2in to 3in.									

NETWORK SERVICES

TOOLS

400146783			GRIP CABLE PLACING 3 IN						
N		EA	1	6	1				E
CA06674. For cables 3in to 3 1/2in.									

GRIP CABLE SPLIT

400146718			GRIP CABLE SPLIT 3 IN						
N		EA	1	6	1				E
CA06674. Kellems 033-13-012.									

BUILDING JANITORIAL

GRIP FLEXIBLE EYE PULLING

A flexible eye pulling grip for placing cables underground.

GROMMETS

840404669			GROMMETS RECEIVER EM1						
N		EA	1	3	1				E
845484427			GROMMETS TRANSMITTER T1						
N		EA	1	13	100				E

AUTOMOTIVE

FORMS/OFFICE SUPPLIES

GUARD

400410650			GUARD AXE CA07345X						
1224303	1	EA							E
Use with Axe 4LB CA07769 (1102079).									

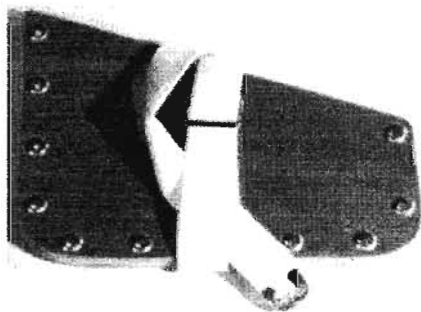

400410650

GENERAL

DATA VOICE

PRODUCT IDENTIFIER		DESCRIPTION							
ITEM NUMBER	ORD. MULT.	SELL UNIT	STD. PKG. STOCK AVAILABILITY / PA	LEAD TIME	MIN. ORD.	MI	OH	WI	A
300085933			GUARD AXE 613 AF FIBER 6 OZ						
N		EA	1	4	1				E
900307745			GUARD AXE CHOPPING F 5509						
N		EA	1	4	12				E
Leather Commercial.									
400147096			GUARD BRUSH CARDING B CA07658						
1103077	1	EA	IL IN MI OH WI 12 12 12 12 12						E
Plastic guard for covering the Brush Carding B (1118028).									



1103077

401334875			GUARD BRUSH WIRE 1663						
N		EA	1	4	24				E
Use with Brush Wire Steel 36 (1333385).									

400147161			GUARD CABLE CUTTER CA07374X						
1103093	1	EA	IL IN MI OH WI 12 12 12 12 12						E
Used as a protection for the cutting edges of a Cutter Cable (1134452). A leather guard with a strap and buckle for fastening to the cable cutter.									

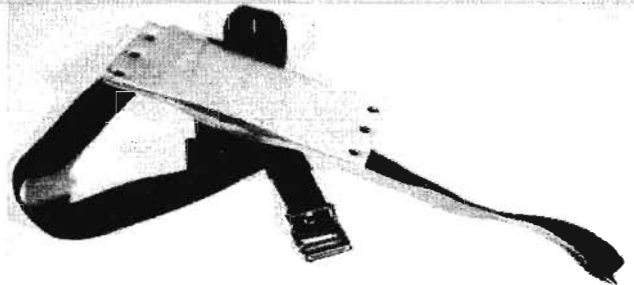

1103093

400147211			GUARD HATCHET 1 1/4 LB CA07377						
N		EA	6	1	6				E

400146932			GUARD HOOK SHAVE B CA07151						
1103119	1	EA	IL IN MI OH WI 12 12 12 12 12						E
To protect the Hook Shave B (1102582), BSP 074-220-135.									

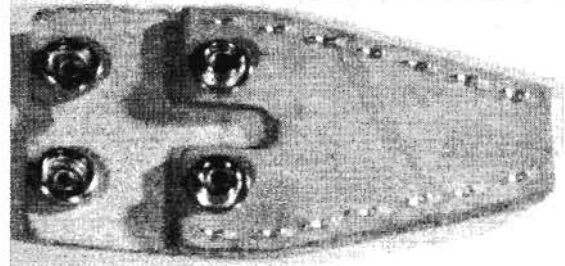

1103119

DISTRIBUTION SERVICES

NETWORK SERVICES

TOOLS

BUILDING JANITORIAL



AUTOMOTIVE

FORMS/OFFICE SUPPLIES

GENERAL

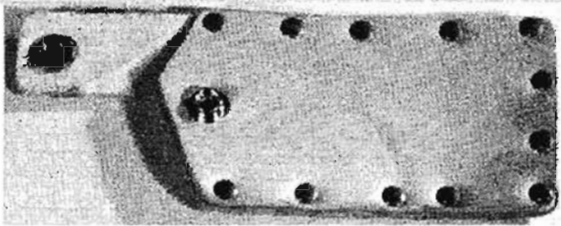
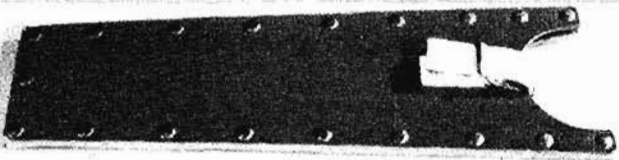
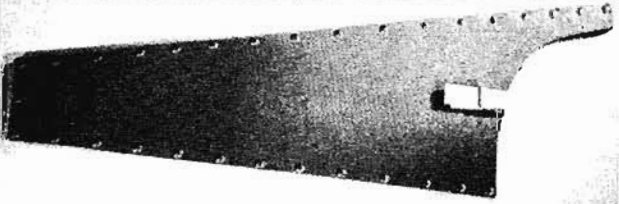
DATA VOICE

PRODUCT IDENTIFIER		DESCRIPTION					MIN. ORD.	A
ITEM NUMBER	ORD. MULT.	SELL UNIT	STD. STOCK	PKG. AVAILABILITY	LEAD TIME / PA	MIN. ORD.	A	
400147245 GUARD KNIFE CHIP LARGE CA07375								
5145300	1	EA	IL 12	IN 12	MI OH WI 12 12		E	
For shielding the cutting edges on Knife Chipping Large (5379123).								
								
5145300								
400147237 GUARD KNIFE CHIP SMALL CA07375								
1181644	1	EA	IL 12	IN 12	MI OH WI 12 12		E	
For shielding the cutting edges on Knife Chipping Small (1227439).								
280054578 GUARD LENS EMERGENCY SU513-S								
N		EA	1	3	1		E	
400147294 GUARD MANHOLE CA06867								
1193631	1	EA	IL 12	IN 12	MI OH WI 12 12		E	
Used around open manholes and small obstructions in streets or side walks as a warning to traffic. Made of 3/4in pipe and is 42in high and 32in square.								
400408068 GUARD SAW CABLE CA07347X								
1103135	1	EA	IL 12	IN 12	MI OH WI 12 12		E	
For protecting teeth of a double edge Saw Cable (1137109).								
								
1103135								
400408076 GUARD SAW DOCKING 30IN CA07347								
N		EA	1	3	3		E	
For protecting the teeth of a 30in docking saw, BSP 620-310-100.								
400408084 GUARD SAW HAND 20IN CA07347X								
N		EA	1	3	4		E	
Use with Saw Hand 20in (5379586).								
400454344 GUARD SAW HAND 26IN CA07347X								
1149781	1	EA	IL 12	IN 12	MI OH WI 12 12		E	
Use with Saw Hand 26in (1193581).								
								
1149781								

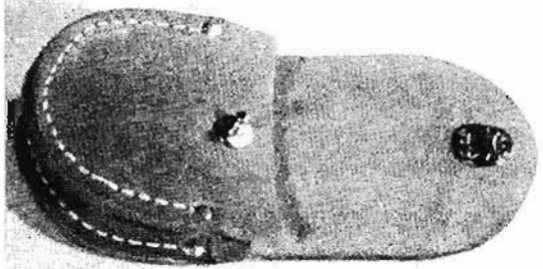
PRODUCT IDENTIFIER		DESCRIPTION					MIN. ORD.	A
ITEM NUMBER	ORD. MULT.	SELL UNIT	STD. STOCK	PKG. AVAILABILITY	LEAD TIME / PA	MIN. ORD.	A	
402408074 GUARD SAW ONE MAN CA07347								
N		EA	1	3	2		E	
A protecting guard for cross-cut saws, consists of a fibre guard conforming to the outline of the saw.								
400408092 GUARD SAW PRUNING 24IN CA07347X								
5145508	1	EA	IL 12	IN 12	MI OH WI 12 12		E	
A guard for protecting the teeth of a 24in pruning saw.								
401716352 GUARD SAW PRUNING 26IN 5522								
1193268	1	EA	IL 12	IN 12	MI OH WI 12 12		E	
For protecting the teeth of a 26in pruning saw.								
								
1193268								
401334891 GUARD SAW PRUNING OP2008								
N		EA	1	4	12		E	
Forward to Guard Saw Pruning 26in 5522 (1193268).								
400408100 GUARD SAW PRUNING POLE								
1102558	1	EA	IL 12	IN 12	MI OH WI 12 12		E	
A guard for protecting blade of a pole pruning saw, CA07347X.								
								
1102558								
402408090 GUARD SAW TWO MAN CA07347								
N		EA	1	3	2		E	
401334933 GUARD TREE PRUNER 1-14IN								
N		EA	1	4	12		E	
								
401334933								
GUN								
260422670 GUN HOT AIR CV5300								
N		EA	1	6	1		E	

DISTRIBUTION SERVICES

GUN INJECTION

PRODUCT IDENTIFIER		DESCRIPTION					
ITEM NUMBER	ORD. MULT.	SELL UNIT	STD. PKG. STOCK AVAILABILITY / PA	LEAD TIME	MIN. ORD.	A C	

GUN INJECTION

300014537 GUN INJECTION 4470

5123430 1 EA

E

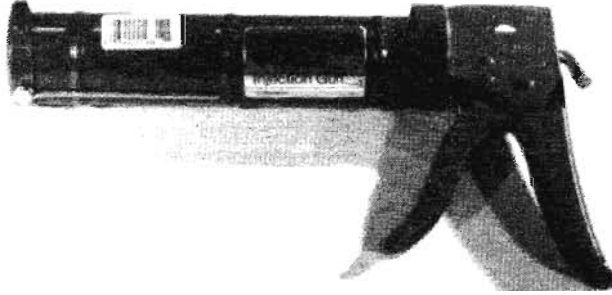

300014537

260344551 GUN INJECTION D CA09019

1950451 10 EA

IL IN MI OH WI
12 12 12 12

E

Used to inject encapsulant into Closure 2200 UG.

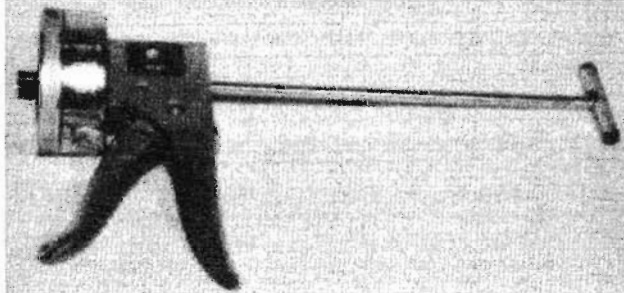

1950451

260328562 GUN INJECTION S99 RATCHET

1952887 1 EA

IL IN MI OH WI
12 12 12

E

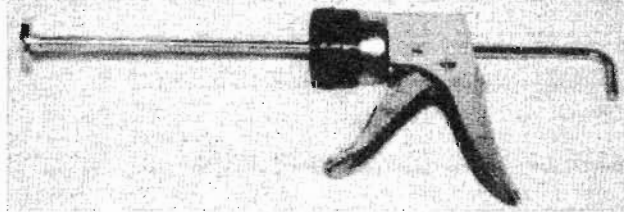

1952887

HAMMER

280014242 HAMMER AIR 5163

N

EA

1

2

1

E

260439823 HAMMER AIR #801

N

EA

1

2

1

Air impact tool.

NETWORK SERVICES

TOOLS

BUILDING JANITORIAL

AUTOMOTIVE

FORMS/OFFICE SUPPLIES

GENERAL

DATA VOICE

PRODUCT IDENTIFIER		DESCRIPTION					
ITEM NUMBER	ORD. MULT.	SELL UNIT	STD. PKG. STOCK AVAILABILITY / PA	LEAD TIME	MIN. ORD.	A C	

300088853 HAMMER CLAW 1LB

1920587 1 EA

IL IN MI OH WI
12 12 12 12

E

One pound hammer for use in driving nails. Head will chip when striking masonry drills or chisels, BSP 081-745-102.

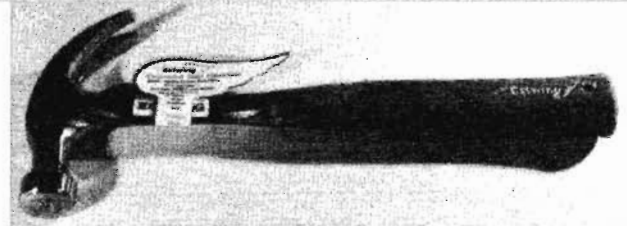

1920587

400147732 HAMMER CLAW 1 1/2LB CA07329

1209932 1 EA

IL IN MI OH WI
12 12 12 12 12

E



1209932

400147740 HAMMER CLAW 2LB CA07329

1103671 1 EA

IL IN MI OH WI
12 12 12 12 12

E

Used for driving and pulling nails, BSP 081-745-102.

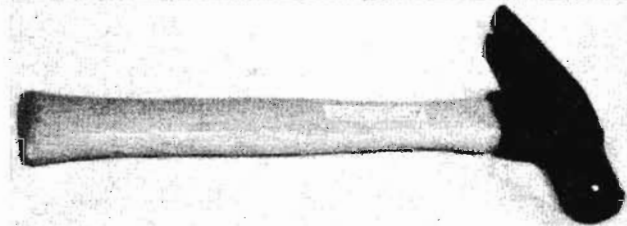

1103671

400147757 HAMMER DRILL 1 1/4LB CA07329

1112359 1 EA

IL IN MI OH WI
12 12 12 12 12

E

Used by construction and installation forces, with masonry drills and drill holders, BSP 081-745-102.

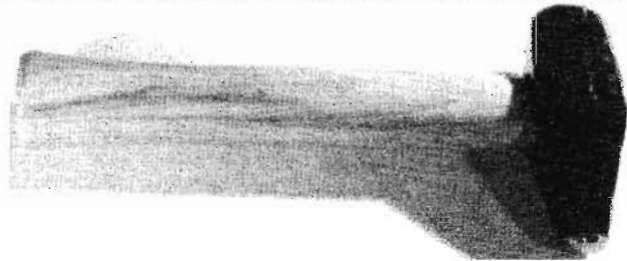

1112359

PRODUCT IDENTIFIER DESCRIPTION

ITEM NUMBER	ORD. MULT.	SELL UNIT	STD. PKG. STOCK AVAILABILITY / PA	LEAD TIME	MIN. ORD.	A C
-------------	------------	-----------	-----------------------------------	-----------	-----------	-----

400147773 HAMMER DRIVING 3LB CA07329
 1158733 1 EA IL IN MI OH WI 12 12 12 12 12 E
 Used by linemen in general construction work, BSP 081-745-102.

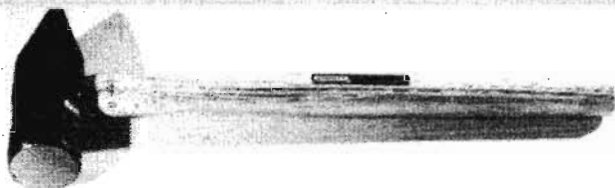

1158733

900215609 HAMMER LINEMAN 2 1/2LB E3 40L
 1155853 1 EA IL IN MI OH WI 12 12 12 12 E

For use by linemen for driving pole steps, drive screws, or heavy pounding. Double faced with shock grip metal handle, BSP 081-745-102.

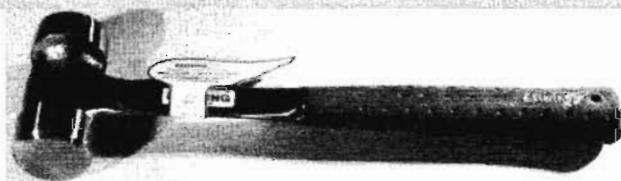

1155853

002037349 HAMMER LINEMAN DOUBLE FACE
 1221556 1 EA IL IN MI OH WI 12 12 12 12 E

36 ounce hammer, 14in overall length. For driving pole steps, etc.

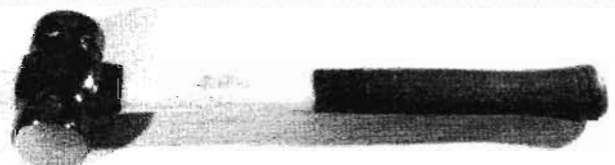

1221556

400147823 HAMMER RIVET 12OZ CA07329
 1141713 1 EA IL IN MI OH WI 12 12 12 12 E

Used by cable splicers with the Knife Chipping Large (5379123). 12 1/2in handle, BSP 081-745-102.



1141713

PRODUCT IDENTIFIER DESCRIPTION

ITEM NUMBER	ORD. MULT.	SELL UNIT	STD. PKG. STOCK AVAILABILITY / PA	LEAD TIME	MIN. ORD.	A C
-------------	------------	-----------	-----------------------------------	-----------	-----------	-----

400147831 HAMMER SLEDGE 10LB CA07329
 1220970 1 EA IL IN MI OH WI 12 12 12 12 12 E
 A double faced sledge hammer, BSP 770-310-100.



1220970

HAND SET

SEE SET HAND.

HANDLE

400147948 HANDLE CA08740 L95
 N EA 1 5 8 E

300052420 HANDLE FIBERGLASS BFG-3
 1127738 1 EA IL IN MI OH WI 12 12 12 12 12 E
 Small 3ft extension section for Pruner Tree B.



1127738

300052438 HANDLE FIBERGLASS BFG-6
 1333666 1 EA IL IN MI OH WI 12 12 12 12 12 E
 A 6ft extension section for Pruner Tree B.

401148176 HANDLE HAMMER DRIVE 3LB CA07329
 1182444 1 EA IL IN MI OH WI 12 12 12 12 E

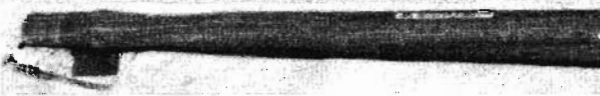

1182444

300084837 HANDLE SHOVEL 48IN CLOSED BACK
 5126532 1 EA IL IN MI OH WI 12 12 12 12 E

300084845 HANDLE SHOVEL 48IN HOLLOW BACK
 1185314 1 EA IL IN MI OH WI 12 12 12 E

401243886 HANDLE SOLDERING CK14440 L50
 N EA 1 5 5 E
 Used with Iron Soldering CK14440

401601844 HANDLE SOLDERING CK14440 L58
 N EA 1 5 9 E
 Used with Iron Soldering CK14440

DISTRIBUTION SERVICES

NETWORK SERVICES

TOOLS

BUILDING JANITORIAL

AUTOMOTIVE

FORMS/OFFICE SUPPLIES

GENERAL

DATA VOICE

DISTRIBUTION SERVICES

NETWORK SERVICES

TOOLS

BUILDING JANITORIAL

AUTOMOTIVE

FORMS/OFFICE SUPPLIES

GENERAL

DATA VOICE

HANDLE

PRODUCT IDENTIFIER		DESCRIPTION							MIN.	A
ITEM NUMBER	ORD. MULT.	SELL UNIT	STD. PKG.	LEAD TIME		STOCK AVAILABILITY / PA		ORD.	C	

402024723 HANDLE TOOL IMPACT D 814

1120600	1	EA	IL	IN	MI	OH	WI		E
			12	12	12	12	12		

A spring activated impact tool for making connections on 66, 88, and 630 type blocks. Blade 8762D must be ordered separately.



1120600

400754495 HANDLE TORCH ACETYLENE G

N		EA	1		3			3	E
---	--	----	---	--	---	--	--	---	---

CA07932. Replacement torch handle for acetylene torch, BSP 081-330-105.

402202428 HANDLE TPW 555-9 WITH 9FT CORD

4280164	1	EA	IL	IN	MI	OH	WI		E
				12					

Part of Kit Solder Iron TPW 2-20 (1186635), BSP 075-190-901. DISCONTINUE UPON STOCK DEPLETION.



4280164

HANDLINE

401338660 HANDLINE AERIAL 3/8IN X 60FT

7371286	1	EA							E
---------	---	----	--	--	--	--	--	--	---

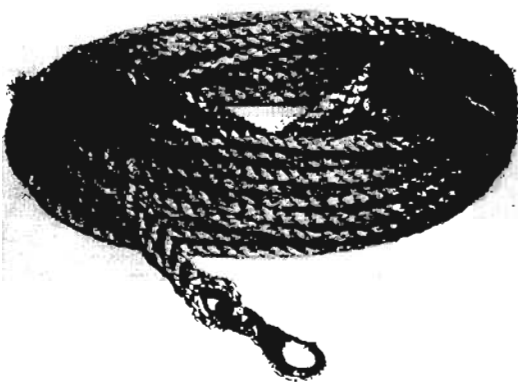

401338660

PRODUCT IDENTIFIER		DESCRIPTION							MIN.	A
ITEM NUMBER	ORD. MULT.	SELL UNIT	STD. PKG.	LEAD TIME		STOCK AVAILABILITY / PA		ORD.	C	

400148201 HANDLINE AERIAL B CA08192

1182642	1	EA	IL	IN	MI	OH	WI		E
			12	12	12	12	12		

Used to handle loads up to 100lb and e/w a locking device which permits a rope clamp to temporarily hold the load at the desired height. Use with Chain Handline Aerial B (1101352), BSP 081-512-100.

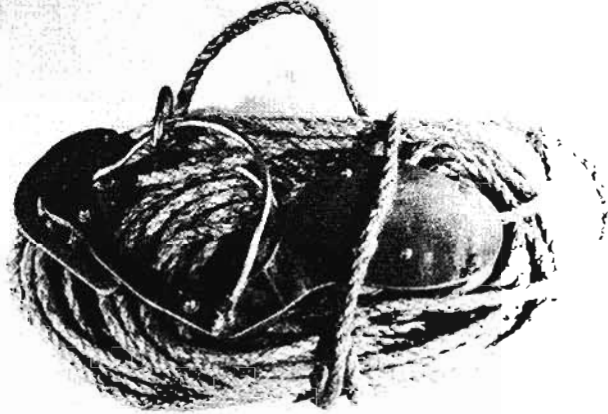

1182642

400148219 HANDLINE UNDERGROUND CA06859

1182709	1	EA	IL	IN	MI	OH	WI		E
			12	12	12	12	12		

Consists of 20 inches of 5/8in manila rope having an eye splice at one end to facilitate setting up cables and a hook at the other end, BSP 081-512-100.



1182709

PRODUCT IDENTIFIER		DESCRIPTION				
ITEM NUMBER	ORD. MULT.	SELL UNIT	STD. PKG. STOCK AVAILABILITY / PA	LEAD TIME	MIN. ORD.	A C

PRODUCT IDENTIFIER		DESCRIPTION				
ITEM NUMBER	ORD. MULT.	SELL UNIT	STD. PKG. STOCK AVAILABILITY / PA	LEAD TIME	MIN. ORD.	A C

DISTRIBUTION SERVICES

NETWORK SERVICES

TOOLS

BUILDING JANITORIAL

AUTOMOTIVE

FORMS/OFFICE SUPPLIES

GENERAL

DATA VOICE

HARDHAT

260345848 CAP SAFETY AMPRD00008 WITH SLOTS
 1951020 1 EA E
 Cap has a rain trough, hard hat.



260345848

260345855 HAT SAFETY AMPRD00008
 1951038 1 EA IL IN MI OH WI E
 12 12 12 12 12
 Hardhat has a full brim.

HEADLAMP

400155198 HEADLAMP 1904-6 CA07698
 2396689 1 EA E

Consists of a light which is mounted on the workman's head by means of a padded swivel bracket, an adjustable strap and a battery case for pocket or belt, BSP 081-340-150.

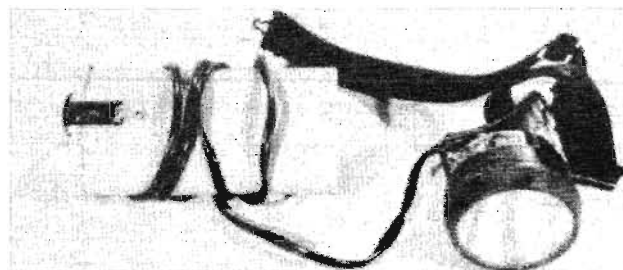

400155198

260421946 HEADLAMP TOPSPOT STR30000
 1975136 1 EA IL IN MI OH WI E
 12 12 12 12 12
 Replaces LIGHT HARDHAT W/VELCRO 664640 (PID260347927)

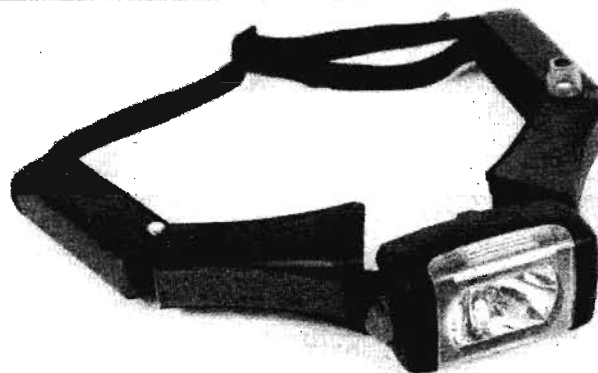

1975136

HARDWARE TENT

SEE TENT HARDWARE

HEADBAND

100208107 HEADBAND 15F
 1153510 1 EA E
 Part of Set Test 91A and Headset 52, BSP 028-360-811.

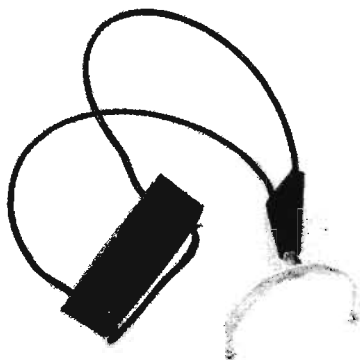

100208107

102115862 HEADBAND 19A50
 1190538 1 EA IL IN MI OH WI E
 12 12 12 12 12
 Forward to PID 100208107 PREV MT.

HEADSET

100672617 HEADSET 52 E
 1160614 1 EA E
 Used for identifying conductors and communicating between splices, BSP 106-020-111.



100672617

DISTRIBUTION SERVICES

NETWORK SERVICES

TOOLS

BUILDING JANITORIAL

AUTOMOTIVE

FORMS/OFFICE SUPPLIES

GENERAL

DATA VOICE

HEADSET

PRODUCT IDENTIFIER DESCRIPTION

ITEM NUMBER	ORD. MULT.	SELL UNIT	STD. PKG. STOCK AVAILABILITY / PA	LEAD TIME	MIN. ORD.	A C
-------------	------------	-----------	-----------------------------------	-----------	-----------	-----

100672666 HEADSET 52 L

1105098	1	EA	IL 04	IN 04	MI 04	OH 04	WI 04	
---------	---	----	-------	-------	-------	-------	-------	--

Head telephone set with transmitter attached to an adjustable arm which is supported at the receiver. Used with switchboards, # 4 order turret, etc, BSP 028-360-811.

100672682 HEADSET 52 N WITH 15FT CORD

1224352	1	EA	IL 04	IN 04	MI 04	OH 04	WI 04	
---------	---	----	-------	-------	-------	-------	-------	--

101234854 HEADSET 52 R

N		EA	1	5	1			
---	--	----	---	---	---	--	--	--

100672690 HEADSET 52 S

N		EA	1	6	2	E		
---	--	----	---	---	---	---	--	--

For technicians use, BSP 028-360-811.

100673003 HEADSET 53 J

N		EA	1	6	1			
---	--	----	---	---	---	--	--	--

280046202 HEADSET AUDIO 1876

1925743	1	EA	IL 12	IN 12	MI 12	OH 12	WI 12	E
---------	---	----	-------	-------	-------	-------	-------	---

Part of/and used with Set Test 91A.

300084712 HEADSET CH0590-1

5126631	1	EA	IL 12	IN 12	MI 12	OH 12	WI 12	E
---------	---	----	-------	-------	-------	-------	-------	---

Provides communication and tone identification.

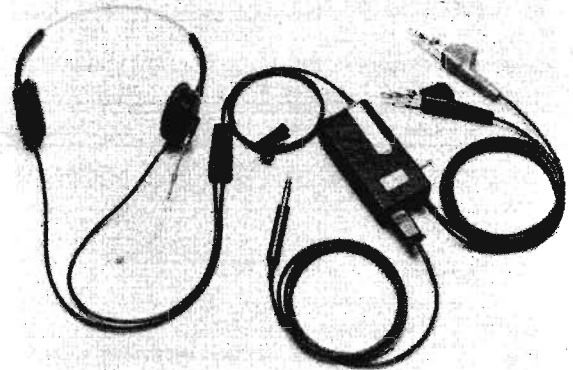

5126631

HEATER

400004701 HEATER ASSEMBLY CK08740 L70

1100933	1	EA						E
---------	---	----	--	--	--	--	--	---

Heating element for Iron Soldering CK08740 (Copper), BSP 075-191-812.



400004701

PRODUCT IDENTIFIER DESCRIPTION

ITEM NUMBER	ORD. MULT.	SELL UNIT	STD. PKG. STOCK AVAILABILITY / PA	LEAD TIME	MIN. ORD.	A C
-------------	------------	-----------	-----------------------------------	-----------	-----------	-----

400004735 HEATER ASSEMBLY CK08740 L74

5146001	1	EA	IL 12	IN 12	MI 12	OH 12	WI 12	E
---------	---	----	-------	-------	-------	-------	-------	---

Heater Assembly with 20ft cord, with par nonpol plug for Soldering Iron, BSP-075-191-812.



5146001

400329488 HEATER ASSEMBLY CK08740 L90 SHELL

1100958	1	EA	IL 12	IN 12	MI 12	OH 12	WI 12	E
---------	---	----	-------	-------	-------	-------	-------	---

Shell for Iron Soldering CK08740, BSP 075-191-812.

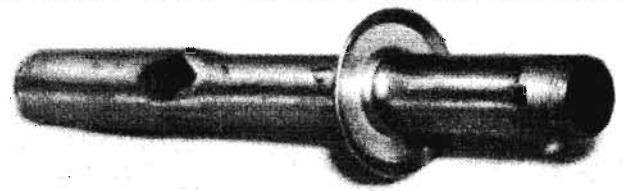

1100958

280016643 HEATER IRON SOLDERING 476B 833

N		EA	1	2	1	E		
---	--	----	---	---	---	---	--	--

Heater for Iron Soldering 476B 833 (300086097).

260374129 HEATER PAD & RELAY 4834-015-00

1956417	1	EA	IL 12	IN 12	MI 12	OH 12	WI 12	E
---------	---	----	-------	-------	-------	-------	-------	---

260388160 HEATER TENT 16000 BTU LP

1964049	1	EA	IL 12	IN 12	MI 12	OH 12	WI 12	E
---------	---	----	-------	-------	-------	-------	-------	---

For heating tents in extreme cold weather.

402202469 HEATER TPW 362 133 LARGE TIP

N		EA	1	2	2	E		
---	--	----	---	---	---	---	--	--

Double insulated thread together Heater, 120V, 45W, w/pre-tinned tip for frame use.



402202469

402202451 HEATER TPW 362 151 SMALL TIP

4280206	1	EA	IL 12	IN 12	MI 12	OH 12	WI 12	E
---------	---	----	-------	-------	-------	-------	-------	---

Double insulated thread Heater and tip for switchroom use, 120V, 45W.



4280206

PRODUCT IDENTIFIER DESCRIPTION

ITEM	ORD.	SELL	STD. PKG.	LEAD TIME	MIN.	A
NUMBER	MULT.	UNIT	STOCK AVAILABILITY / PA		ORD.	C

HEMOSTAT

300085974 HEMOSTAT SS 112B020

N		EA	1	2	4	E
---	--	----	---	---	---	---

A six inch Straight Hemostat used to hold wires for soldering. Act's as a heat shrink and retrieving small parts from hard to reach places.

300085982 HEMOSTAT SS 112B025

N		EA	1	2	4	E
---	--	----	---	---	---	---

A five inch Straight Hemostat used to hold wires for soldering. Act's as a heat shrink and retrieving small parts from hard to reach places.

HOIST CHAIN

400777157 HOIST CHAIN E 1 1/2 TON CA08438

1162107	1	EA				E
---------	---	----	--	--	--	---

A ratchet type hoist intended for use in pulling up guys, tensioning strand and pulling operations, BSP 081-500-105.



400777157

400956157 HOIST CHAIN E 3 TON CA08438

N		EA	1	3	1	E
---	--	----	---	---	---	---

HOLDER

280012840 HOLDER EAR MUFF 119MZ

N		EA	1	2	1	E
---	--	----	---	---	---	---

280012857 HOLDER FIRST AID 119DZ

N		EA	1	2	1	E
---	--	----	---	---	---	---

280012865 HOLDER FLASHLIGHT 124DZ

N		EA	1	2	1	E
---	--	----	---	---	---	---

601086465 HOLDER FUSION SPLICE

1938324	1	EA	IL	IN	MI	OH	WI	E
			12	12	12	12	12	

280012873 HOLDER KEY RING 130AZ

N		EA	1	2	1	E
---	--	----	---	---	---	---

260393087 HOLDER LINEMANS WRENCH

N		EA	1	2	1	E
---	--	----	---	---	---	---

Klein 5134.

PRODUCT IDENTIFIER DESCRIPTION

ITEM	ORD.	SELL	STD. PKG.	LEAD TIME	MIN.	A
NUMBER	MULT.	UNIT	STOCK AVAILABILITY / PA		ORD.	C

300086006 HOLDER RETRO-FIT TPW-1

N		EA	1	2	15	E
---	--	----	---	---	----	---

A small metal holder for a soldering iron and held in place by a P485156 Clip (804851566).

402284772 HOLDER SCRAP WIRE 4988 GRAY

N		EA	1	6	1	E
---	--	----	---	---	---	---

402031272 HOLDER SCRAP WIRE 4988 YELLOW

N		EA	1	6	1	E
---	--	----	---	---	---	---

402378640 HOLDER SET TEST B CA08923

N		EA	1	2	1	E
---	--	----	---	---	---	---

Used to secure Set Test 188A to body belt while climbing poles, BSP 081-705-102.

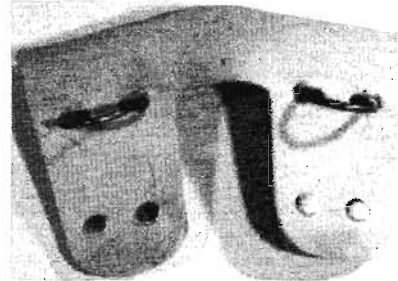

402378640

401338777 HOLDER TAPE 5130

5146183	1	EA	IL	IN	MI	OH	WI	E
			12	12	12	12	12	

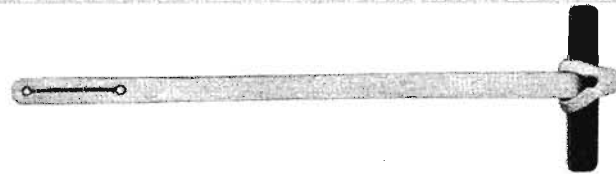

5146183

260412705 HOLDER TOOL E9CH

N		EA	1	2	1	E
---	--	----	---	---	---	---

Completely assembled, 78-8020-7169-2.

300044617 HOLDER TOOL VS3 AMP 229755-1

N		EA	1	2	1	E
---	--	----	---	---	---	---

260328091 HOLDER WIRE GROUP 78-8054-2295-9

N		EA	1	3	1	E
---	--	----	---	---	---	---

For 3M 4046 Crimper.

DISTRIBUTION SERVICES

NETWORK SERVICES

TOOLS

BUILDING JANITORIAL

AUTOMOTIVE

FORMS/OFFICE SUPPLIES

GENERAL

DATA VOICE

DISTRIBUTION SERVICES

HOLSTER

PRODUCT IDENTIFIER		DESCRIPTION				
ITEM NUMBER	ORD. MULT.	SELL UNIT	STD. PKG. STOCK AVAILABILITY / PA	LEAD TIME	MIN. ORD.	A C

NETWORK SERVICES

400149787 HOLSTER CK16921 L1

1183624 1 EA E
 For carrying the Tool Wire Wrap CK1636L3 (1135467) and the Stripper Wire Plier R3088 (1267823), BSP 074-223-128.

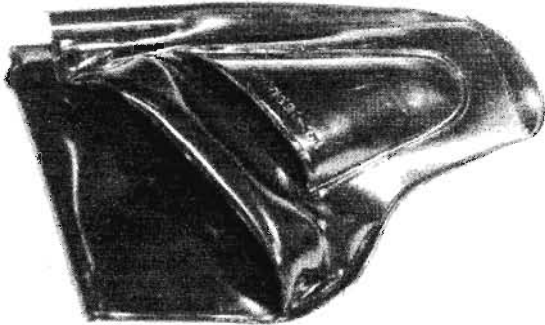

400149787

TOOLS

401145453 HOLSTER D LEFT HAND CA07065

N EA 6 1 6 E

401014667 HOLSTER D RIGHT HAND CA07065

N EA 6 1 6 E

400664876 HOLSTER F LEFT HAND CA07065

N EA 6 2 6 E

BUILDING JANITORIAL

400535829 HOLSTER F RIGHT HAND CA07065

1333625 1 EA E
 IL IN MI OH WI
 12 12 12 12 12

Is attached to body belt and has a pocket for ruler, pliers and scissors, BSP 081-720-111.

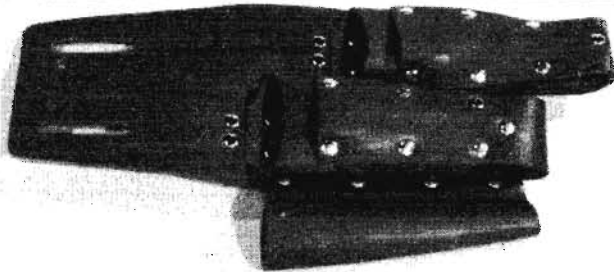

1333625

AUTOMOTIVE

FORMS/OFFICE SUPPLIES

260329891 HOLSTER FOR MINI MAGLITE 2AA

N EA 1 2 1 E
 See Flashlight Mini-Maglite 2AA (260318076).

300080470 HOLSTER STAPLE GUN J360

1333476 1 EA E
 IL IN MI OH WI
 12 12 12

GENERAL

HOOD

280020975 HOOD WINDBAG CABLE DRYER

N EA 1 3 1 E
 W/ADAPTER 7000. Used with heated air method of drying wet splices in cables, BSP 632-800-302.

DATA VOICE

PRODUCT IDENTIFIER		DESCRIPTION				
ITEM NUMBER	ORD. MULT.	SELL UNIT	STD. PKG. STOCK AVAILABILITY / PA	LEAD TIME	MIN. ORD.	A C

HOOK

400149894 HOOK CANT 7 CAO6429

1183764 1 EA E
 Used on medium and larger poles over 7in in diameter, BSP 621-205-202.

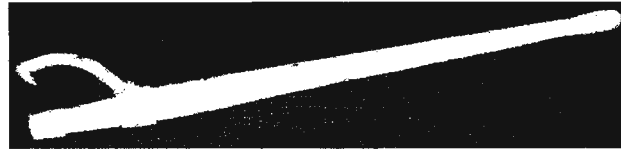

400149894

401338942 HOOK COVER MANHOLE CHICAGO TYPE

1127779 1 EA E
 IL IN MI OH WI
 12

Opigon tool steel fish hook tip with barb at the end.



1127779

400149902 HOOK MANHOLE COVER B CA08172

1183806 1 EA E
 IL IN MI OH WI
 12 12 12 12 12

Consists of a length of octagonal tool steel which is bent to form a handle at one end and an offset at the other. Intended for use on 1in thick manhole cover, BSP 620-150-010.



1183806

400149969 HOOK PLACING B CA08275

1183889 1 EA E
 IL IN MI OH WI
 12 12 12 12 12

Used to temporarily support self-supporting cable during placing and tensioning operations, BSP 627-700-014.



1183889

PRODUCT IDENTIFIER DESCRIPTION

ITEM NUMBER	ORD. MULT.	SELL UNIT	STD. PKG.		LEAD TIME	MIN. ORD.	A C
			STOCK AVAILABILITY / PA				

400149993 HOOK SHAVE B CA07151
 1102582 1 EA 12 12 12 12 12 12 E

For use in cleaning and preparing lead cable sheath and sleeves for soldering and wiping joints, BSP 074-223-132.

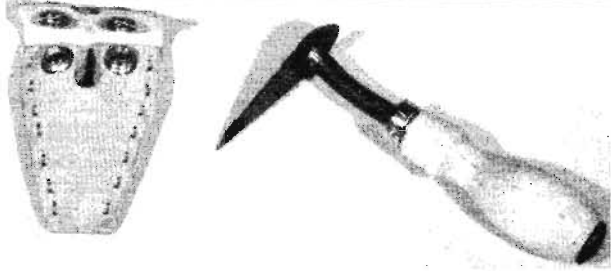

1102582

400150025 HOOK SNAP CA06774
 N EA 1 2 10 E

260339189 HOOK UNILENGTH 2IN
 N EA 1 3 1 E
 4041-280-6103-2688-8.

260339197 HOOK UNILENGTH 4IN
 N EA 1 3 1 E
 4041-480-6103-2689-6.

HOOK E-Z TEST CORDS

280038159 HOOK E-Z 204 6W RED
 N EA 6 3 6 E
 Individual length jumper-mini-hook to mini-hook with square hole tip.

280038167 HOOK E-Z 204 6W2 RED
 N EA 6 3 6 E
 Individual length jumper-mini-hook to mini-hook with rectangular hole tip.

280038092 HOOK E-Z 204 12W RED
 N EA 6 3 6 E
 Individual length jumper-mini-hook to mini-hook with square hole tip.

280038100 HOOK E-Z 204 12W2 BLACK
 N EA 6 3 6 E
 Individual length jumper-mini-hook to mini-hook with rectangular hole tip.

280038118 HOOK E-Z 204 12W2 RED
 N EA 6 3 6 E
 Individual length jumper-mini-hook to mini-hook with rectangular hole tip.

280038282 HOOK E-Z 204 18W2 BLACK
 N EA 6 3 6 E
 Individual length jumper-mini-hook to mini-hook with rectangular hole tip.

280038290 HOOK E-Z 204 18W2 RED
 N EA 6 3 6 E
 Individual length jumper-mini-hook to mini-hook with rectangular hole tip.

PRODUCT IDENTIFIER DESCRIPTION

ITEM NUMBER	ORD. MULT.	SELL UNIT	STD. PKG.		LEAD TIME	MIN. ORD.	A C
			STOCK AVAILABILITY / PA				

280038126 HOOK E-Z 204 24W BLACK
 N EA 6 3 6 E
 Individual length jumper-mini-hook to mini-hook with square hole tip.

280038142 HOOK E-Z 204 24W-S 10/ST
 N SE 6 3 6 E
 Set of jumpers 1 each of 10 colors 24in long. Mini-hook to mini-hook with square hole tip.

280038175 HOOK E-Z 204 60W BLACK
 N EA 6 3 6 E
 Individual length jumper-mini-hook to mini-hook with square hole tip.

280038183 HOOK E-Z 204 60W RED
 N EA 6 3 6 E
 Individual length jumper-mini-hook to mini-hook with square hole tip.

280038308 HOOK E-Z 204 WC
 N EA 6 3 6 E
 A mini-hook to mini-hook jumper 22AWG 26X36 coil cord-square hole tip both ends, 48in long.

280038191 HOOK E-Z 204 XL1-18-S 10/ST
 N SE 6 3 6 E
 Set of jumpers 1 each of 10 colors 18in long. Mini-hook XL to mini-hook XL with square hole tip. (XL Extra long body).

280038209 HOOK E-Z 204 XM-24 RED
 N EA 6 3 6 E
 Set of jumpers micro-hook to micro-hook.

280038217 HOOK E-Z 204 XM-24-S 10/ST
 N SE 6 3 6 E
 Set of jumpers 1 each of 10 colors 24in long. Micro-hook to micro-hook.

280038225 HOOK E-Z 204 XR-12 BLACK
 N EA 6 3 6 E
 Individual length jumper, mini-hook XR to mini-hook XR. (XR Extra thick blade .635mm for added strength and durability). For use on heavy leads or terminals up to .059in.

280038233 HOOK E-Z 204 XR-12 RED
 N EA 6 3 6 E
 Individual length jumper, mini-hook XR to mini-hook XR. (XR Extra thick blade .635mm for added strength and durability). For use on heavy leads or terminals up to .059in.

280038241 HOOK E-Z 204 XR-24 BLUE
 N EA 6 3 6 E
 Individual length jumper, mini-hook XR to mini-hook XR. (XR Extra thick blade .635mm for added strength and durability). For use on heavy leads or terminals up to .059in.

280038258 HOOK E-Z 204 XR-24 YELLOW
 N EA 6 3 6 E
 Individual length jumper, mini-hook XR to mini-hook XR. (XR Extra thick blade .635mm for added strength and durability). For use on heavy leads or terminals up to .059in.

DISTRIBUTION SERVICES

NETWORK SERVICES

TOOLS

BUILDING JANITORIAL

AUTOMOTIVE

FORMS/OFFICE SUPPLIES

GENERAL

DATA VOICE

DISTRIBUTION SERVICES

NETWORK SERVICES

TOOLS

BUILDING JANITORIAL

AUTOMOTIVE

FORMS/OFFICE SUPPLIES

GENERAL

DATA VOICE

HOOK E-Z TEST CORDS

PRODUCT IDENTIFIER		DESCRIPTION				
ITEM NUMBER	ORD. MULT.	SELL UNIT	STD. PKG. STOCK AVAILABILITY / PA	LEAD TIME	MIN. ORD.	A C
280038266 HOOK E-Z 204 XR-24-S 10/ST						
N		SE	6	3	6	E
Set of jumpers 1 each of 10 colors 24in long, mini-hook XR to mini-hook XR. (XR Extra thick blade .635mm for added strength and durability). Foruse on heavy leads or terminals up to .059in.						
280038316 HOOK E-Z 8705 TERMINAL RING						
N		EA	6	3	6	E
A terminal ring to .025in square socket with hang down feature for heavy connectors.						
280038274 HOOK E-Z 8707S ADAPTER 10/ST						
N		SE	6	3	6	E
Test probe for test equipment connection to ESS equipment.						
280038324 HOOK E-Z MINI 204 XL1C BLUE						
N		EA	6	3	6	E
280038332 HOOK E-Z MINI 204 XL1C BROWN						
N		EA	6	3	6	E
280038340 HOOK E-Z MINI 204 XL1C GRAY						
N		EA	6	3	6	E
280038357 HOOK E-Z MINI 204 XL1C GREEN						
N		EA	6	3	6	E
280038365 HOOK E-Z MINI 204 XL1C ORANGE						
N		EA	1	2	1	E
260436480 HOOK E-Z MINI 204 XLIC BLACK						
N		EA	1	2	1	
260436514 HOOK E-Z MINI 204 XR24 BLACK						
N						
260436530 HOOK E-Z MINI 204 XR24 BLUE						
N						
260436548 HOOK E-Z MINI 204 XR24 GREEN						
N						
260436506 HOOK E-Z MINI 204 XR24 RED						
N						
260436522 HOOK E-Z MINI 204 XR24 WHITE						
N						
260436498 HOOK E-Z MINI 204 YLIC RED						
N						
HOSE						
260421193 HOSE 15FT FOR INDICATOR GAS F						
N		EA	1	2	1	E
260438296 HOSE 25FT PROPANE AD1562						
N		EA	1	6	1	

PRODUCT IDENTIFIER		DESCRIPTION				
ITEM NUMBER	ORD. MULT.	SELL UNIT	STD. PKG. STOCK AVAILABILITY / PA	LEAD TIME	MIN. ORD.	A C

280018698 HOSE ASPIRATOR 6IN 40000060						
N		EA	1	4	1	E
Gas Indicator.						
405680893 HOSE ASSEMBLY 678						
N		EA	1	2	1	E
Used with the D5 Standard Type V6 Portable Vacuum Cleaner, Model M-14377-6.						
260413281 HOSE CANVAS MILL 2IN X 25FT						
N		EA	1	2	1	E
260413273 HOSE CANVAS MILL 2IN X 50FT						
N		EA	1	2	1	E
260343009 HOSE HYDRAULIC 1/2						
N		EA	1	2	1	E

400150652 HOSE PRESSURE D 6FT CA07676								
1184101	1	EA	IL	IN	MI	OH	WI	E
			12	12	12	12	12	
Equipped at both ends with a spring guard coupling for connecting the outlet of acetylene pressure regulator to the inlet of the torch proper when using standard acetylene torches. BSP 081-330-105.								

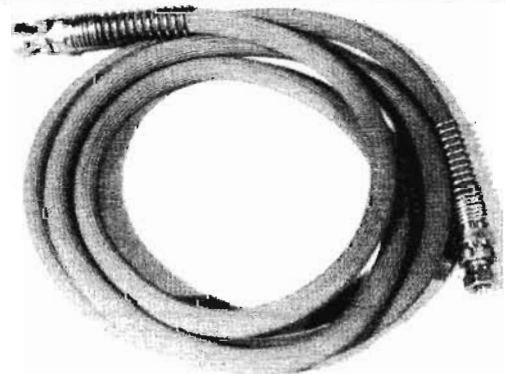

1184101

400150678 HOSE PRESSURE D 25FT CA07676								
1434902	1	EA	IL	IN	MI	OH	WI	E
			12	12	12	12	12	
Equipped at both ends with a spring guard coupling for connecting the outlet of acetylene pressure regulator to the inlet of the torch proper when using standard acetylene torches. BSP 081-330-105.								

400150694 HOSE PRESSURE E 30FT CA07676								
1184127	1	EA	IL	IN	MI	OH	WI	E
			12	12	12	12	12	
Equipped at both ends with a spring guard coupling for connecting the outlet of a propane pressure regulator to the inlet of the several standard propane-powered heaters, ventilators, engines, etc.								

HOSE BLOWER

260383161 HOSE BLOWER 3025B						
N		EA	1	2	1	E

DISTRIBUTION SERVICES

NETWORK SERVICES

TOOLS

BUILDING JANITORIAL

AUTOMOTIVE

FORMS/OFFICE SUPPLIES

GENERAL

DATA VOICE

PRODUCT IDENTIFIER DESCRIPTION

ITEM NUMBER	ORD. MULT.	SELL UNIT	STD. PKG. STOCK AVAILABILITY / PA	LEAD TIME	MIN. ORD.	A C
-------------	------------	-----------	-----------------------------------	-----------	-----------	-----

400738803 HOSE BLOWER B CA08418
 1184028 1 EA IL IN MI OH WI 12 12 12 12 12 E
 8in diameter, 15ft long. Used to heat and ventilate manholes. Yellow vinyl hose spring loaded for easy uncoiling. Use with Carrier Hose Blower B (1125807), BSP 649-510-115.

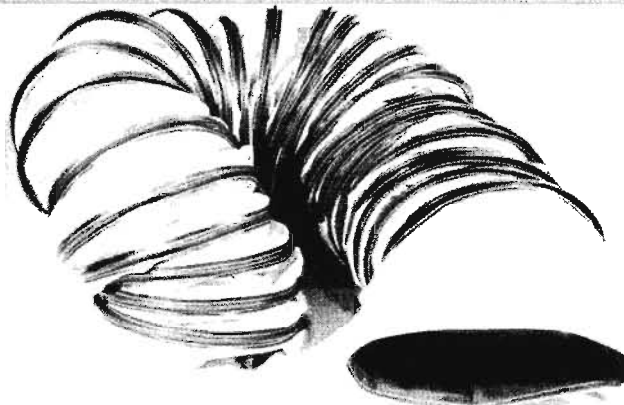

1184028

400472106 HOSE BLOWER B E/W CARRIER
 N EA 1 4 2 E

400955027 HOSE BLOWER C CA08418
 N EA 1 4 4 E

HOSE DISCHARGE

400956025 HOSE DISCHARGE B 2IN X 15FT
 N EA 1 2 2 E
 CA08321. A double jacketed fire hose equipped with a quick-connect coupling on one end only, BSP 649-530-105.

HOSE SUCTION

400997722 HOSE SUCTION C 2IN X 20FT
 1148197 1 EA E
 CA08320. See 15ft Hose above.

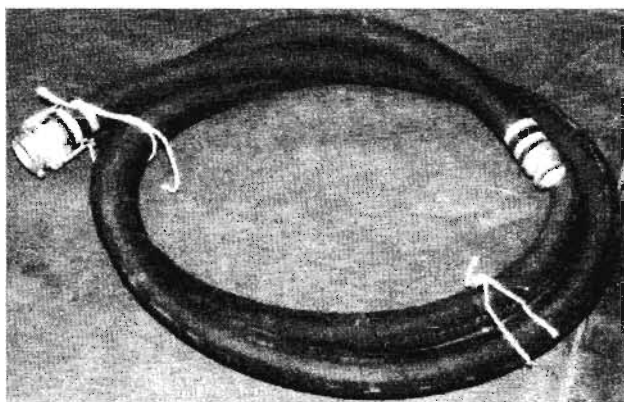

400997722

PRODUCT IDENTIFIER DESCRIPTION

ITEM NUMBER	ORD. MULT.	SELL UNIT	STD. PKG. STOCK AVAILABILITY / PA	LEAD TIME	MIN. ORD.	A C
-------------	------------	-----------	-----------------------------------	-----------	-----------	-----

HYDROMETER

402242697 HYDROMETER CK5499 L1306
 1187260 1 EA E
 For use in testing enclosed lead-acid type batteries, BSP 084-550-101.



402242697

402242705 HYDROMETER CK5499 L1308
 1945931 1 EA IL IN MI OH WI 12 12 12 12 12 E
 Used for high gravity cells.



1945931

IDENTIFIER

260428875 IDENTIFIER HI-CAP 130 T-BUG
 N EA 1 4 1 E
 A non-intrusive, hand held instrument that identifies T1 signal presence without interruption of service. Uses (1) Battery 9.0 Volts GP Neda 1604 (1101055).

260424320 IDENTIFIER HI-CAP D550 SHARK
 N EA 1 4 1 E
 A non-intrusive, hand held instrument that identifies T1 signal presence without interruption of service. Detects all signals or patterns up to 600ft of 22GA cable. Uses (1) Battery 9.0 Volt Alkaline.

INDICATOR

400151155 INDICATOR GAS G CA08226
 N EA 1 7 1 E
 P/N SCO 40002220.

INSERT

260324462 INSERT JAW 78-8026-8166-4
 N EA 1 3 1 E
 Replacement part for Tool Crimping E-9BM (1191478).

INSTRUCTIONS

PRODUCT IDENTIFIER		DESCRIPTION					
ITEM NUMBER	ORD. MULT.	SELL UNIT	STD. PKG. STOCK AVAILABILITY / PA	LEAD TIME	MIN. ORD.	A	C

INSTRUCTIONS

260395058 INSTRUCTIONS FOR SKD 3527							
N		EA	1	2	1	E	
For Protector Ground Tester (260388608)							

INTERFACE

260389028 INTERFACE EXBERT DATA RS232 51487							
N		EA	1		1	E	
260389036 INTERFACE EXBERT DATA V.35 51490							
N		EA	1		1	E	

IRON SOLDERING

300086097 IRON SOLDERING 476B 833							
N		EA	1	2	1	E	
A 95 Watt Soldering Iron, used for frame cross connect soldering.							
400130670 IRON SOLDERING CK08740 L 2							
N		EA	1	5	2	E	
95 Watt - 20 Amp.							
400130746 IRON SOLDERING CK08740 L 9							
N		EA	1	5	2	E	

400130761 IRON SOLDERING CK08740 L11									
1169797	1	EA		IL 12	IN 12	MI 12	OH 12	WI 12	E

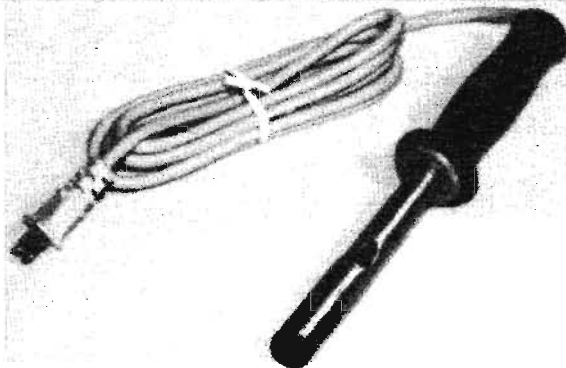

1169797

400130787 IRON SOLDERING CK08740 L13							
N		EA	1	5	2	E	
400130803 IRON SOLDERING CK08740 L22							
N		EA	1	5	2	E	
401244876 IRON SOLDERING CK14440 L13A							
N		EA	1	5	2	E	

PRODUCT IDENTIFIER		DESCRIPTION					
ITEM NUMBER	ORD. MULT.	SELL UNIT	STD. PKG. STOCK AVAILABILITY / PA	LEAD TIME	MIN. ORD.	A	C

401244884 IRON SOLDERING CK14440 L16									
1179770	1	EA		IL 12	IN 12	MI 12	OH 12	WI 12	E



1179770

401244892 IRON SOLDERING CK14440 L17								
N		EA	1		5	3	E	
Equipped with 6in cord.								

401244900 IRON SOLDERING CK14440 L18								
N		EA	1		5	2	E	

400152369 IRON SOLDERING CK16346 L 2								
N		EA	1		4	4	E	

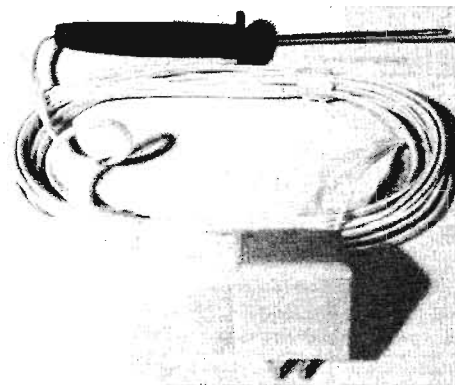

400152369

280016486 IRON SOLDERING CORDLESS 7700								
N		EA	1		2	1	E	

402429591 IRON SOLDERING ELECTRIC CP 2003								
N		EA	1		2	3	E	

300086089 IRON SOLDERING WTCPR								
N		EA	1		2	1	E	
A controlled output soldering station, consists of a TC201 Soldering Iron and a TC202 Power Unit.								

DISTRIBUTION SERVICES

NETWORK SERVICES

TOOLS

BUILDING JANITORIAL

AUTOMOTIVE

FORMS/OFFICE SUPPLIES

GENERAL

DATA VOICE

PRODUCT IDENTIFIER		DESCRIPTION				
ITEM NUMBER	ORD. MULT.	SELL UNIT	STD. PKG. STOCK AVAILABILITY / PA	LEAD TIME	MIN. ORD.	A' C

JACK

400152559 JACK RACK CABLE B CA07286
 5146845 1 EA C
 For bending and racking cables in manholes/vaults. Consists of a 25in curved shoe, a tubular base and a screw & nut for advancing the shoe. Two 15in sections are provided to increase the jack length.

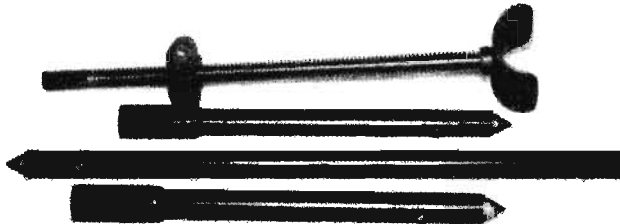

400152559

JAWS

280013970 JAWS REPLACEMENT 1062
 N EA 1 2 1 E
 For Tool Placing 1062-12, -18, -24 Fiber Optic inner duct.

KEY

260425574 KEY CHUCK S10 MAKITA
 N EA 1 3 1 E

840841324 KEY HEX 840841324
 6509430 1 EA IL IN MI OH WI E
 12 12 12 12 12
 Size - 5/16 inch.



6509430

KIT

260439906 KIT BOX #811
 N EA 1 2 1
 Tool box for air impact parts kit.

260440318 KIT COMBO 400 TW2
 N EA 1 2 1
 Air impact tools.

PRODUCT IDENTIFIER		DESCRIPTION				
ITEM NUMBER	ORD. MULT.	SELL UNIT	STD. PKG. STOCK AVAILABILITY / PA	LEAD TIME	MIN. ORD.	A' C

402378236 KIT DRILL DRIVER C CA08900
 1403329 5 EA IL IN MI OH WI E
 12 12 12 12 12



1403329

300086113 KIT DRILL HAMMER 5397-1 MODIFICATION REQ

N EA 1 2 1 E
 Kit includes a speed control drill w/depth gauge, removable side handle, rubber dust shield & one each bit; 3/16in X 3in, 1/4in X 4in, 3/8in X 4in and 1/2in X 6in. Modified to disable trigger locking.

300086121 KIT JET LINE J02-5-1
 N EA 1 2 1 E
 A conduit fishing system, includes 5 lb. Carbon Dioxide cylinder, seal-offs for 1/2in to 1 3/4in fishing foam line carries and a refill adapter.

280016668 KIT JTK-54 D54B554
 N EA 1 2 1 E
 Central Office Telecommunications.

401411871 KIT KENNEDY
 N EA 1 4 1 E
 Metal tool box, 16 per case.

400153144 KIT KEY C CA08032
 1196121 1 KT IL IN MI OH WI E
 12 12 12 12 12
 Consists of a plastic envelope containing nine hexagonal socket keys. .05, 1/16, 3/32, 7/64, 1/8, 9/64, 5/32, 3/16, 5/64.

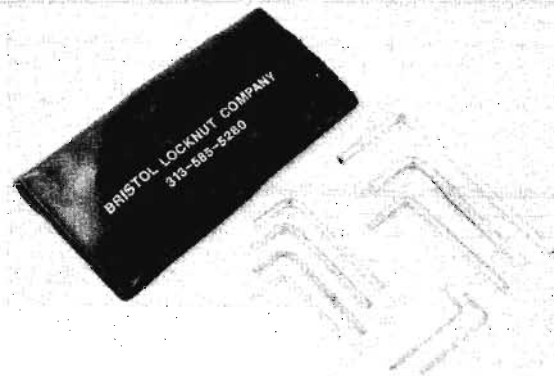

1196121

DISTRIBUTION SERVICES

NETWORK SERVICES

TOOLS

BUILDING JANITORIAL

AUTOMOTIVE

FORMS/OFFICE SUPPLIES

GENERAL

DATA VOICE

KIT

PRODUCT IDENTIFIER		DESCRIPTION				
ITEM NUMBER	ORD. MULT.	SELL UNIT	STD. PKG. STOCK AVAILABILITY / PA	LEAD TIME	MIN. ORD.	A C
260412747 KIT MODULE MAINTENANCE 4026						
N		EA	1	2	1	E
80-6102-8197-6.						
300086147 KIT NUT DRIVER K3B227						
N		EA	1	2	1	E
An eleven piece set consisting of ten hollow shaft nut drivers, sizes 3/16in through 9/16in, in a plastic desk case.						
260436910 KIT PISTOL GRIP COMBO 700A						
N		EA	1	2	1	
Air impact tool parts kit.						
260436928 KIT PISTOL GRIP MASTER 800A.						
N		EA	2	2	2	
Air impact tool parts kit.						
260422662 KIT PROPANE TORCH 132929						
N		EA	1	6	1	E

402202493 KIT SOLDER IRON TPW2-09

ITEM NUMBER	ORD.	SELL	IL	IN	MI	OH	WI	A
1227520	1	EA	12	12	12	12		E

A light weight soldering iron. Consists of TPW-5500 handle w/9ft cord, TPW-1 retro-fit holder, TPW 362-133 tip & heater, TPW-3 metal sponge tray & bracket and TPW sponge replacement.

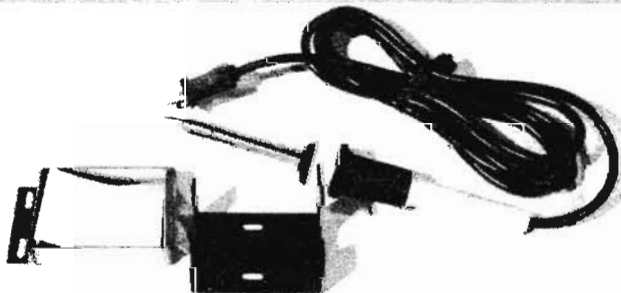

1227520

402202501 KIT SOLDER IRON TPW2-20

ITEM NUMBER	ORD.	SELL	IL	IN	MI	OH	WI	A
1186635	1	EA	12	12	12	12		E

Same as TPW2-09 except this has a 20ft cord.

401405659 KIT STENCIL R2315

N		EA	1	4	1	E
---	--	----	---	---	---	---

PRODUCT IDENTIFIER		DESCRIPTION				
ITEM NUMBER	ORD. MULT.	SELL UNIT	STD. PKG. STOCK AVAILABILITY / PA	LEAD TIME	MIN. ORD.	A C

400753927 KIT TEST GAS C CA08594

2640961	1	EA	IL	IN	MI	OH	WI	E
			12	12	12	12	12	

Used to test hot wire gas indicators. Has 2 disposable pressurized gas cylinders and one dispenser valve. Uses Cylinder Replacement (2791582) & Case Indicator Gas D (5316943), BSP 081-700-122.



2640961

260411749 KIT TEST LEADS Y8134

N		EA	1	2	1	E
---	--	----	---	---	---	---

300086170 KIT TOOL POCKET 99PS-50 U3B607

N		EA	1	2	1	E
---	--	----	---	---	---	---

Includes handle, 7 nut driver blades 3/16in through 3/8in. Two slotted screwdriver blades, two phillip screwdriver blades No's 1 & 2 and one 4in extension in a plastic case.

260344817 KIT TOOL VACUUM

N		EA	1	2	1	E
---	--	----	---	---	---	---

For model AC80704-06.

260436894 KIT UNIVERSAL SPLICING #500

N		EA	1	2	1	
---	--	----	---	---	---	--

Air impact tool parts kit.

260412713 KIT WIRE GUIDE 78-8054-9696-1

N		EA	1	2	1	E
---	--	----	---	---	---	---

Module terminator spare part, 4163.

260412721 KIT WIRE RETAINER 78-8012-9790-0

N		EA	1	2	1	E
---	--	----	---	---	---	---

Module terminator spare part, 4163

260412739 KIT WIRE SEPARATOR 78-8004-0874-8

N		EA	1	2	1	E
---	--	----	---	---	---	---

Module terminator spare part, 4163

PRODUCT IDENTIFIER DESCRIPTION

ITEM NUMBER	ORD. MULT.	SELL UNIT	STD. PKG. STOCK AVAILABILITY / PA	LEAD TIME	MIN. ORD.	A C
-------------	------------	-----------	-----------------------------------	-----------	-----------	-----

400291084 KIT WRENCH D CA08381
 1196402 1 EA IL IN MI OH WI E
 12 12 12 12 12

For splice closures. Consists of reversing-type ratchet 3/8IN drive, 3/8, 7/16, 1/2, 9/16, and 11/16IN sockets, 3 & 5IN extensions, screwdr hex 3/16, wrench comb 9/16, & driver skt-scrdr handle 3/8 Dr.

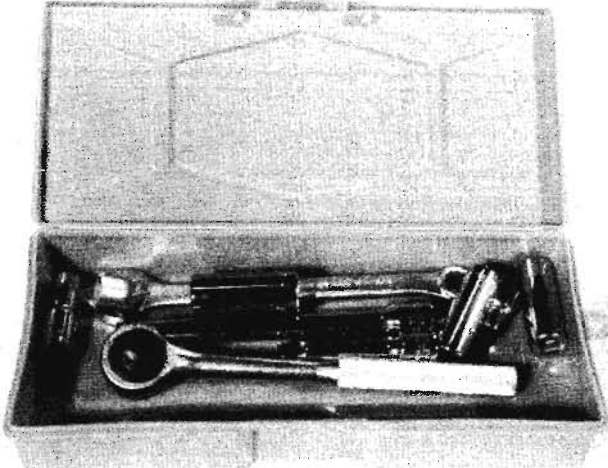

1196402

260436902 KIT WRENCH PISTOL GRIP #600A
 N EA 1 2 1
 Air impact tool parts kit.

PRODUCT IDENTIFIER DESCRIPTION

ITEM NUMBER	ORD. MULT.	SELL UNIT	STD. PKG. STOCK AVAILABILITY / PA	LEAD TIME	MIN. ORD.	A C
-------------	------------	-----------	-----------------------------------	-----------	-----------	-----

401612882 KNIFE SKINNING R2761 W/O SHEATH
 1446047 1 EA IL IN MI OH WI E
 12 12 12 12 12

Tool is similar to a linoleum knife, except it has a blunt tip. Used whenscoring outer sheath of alpeh or poly cables. Use with Pouch Tool E (2798036), BSP 627-700-014.



1446047

LADDER

260347265 LADDER CK5239-03 L2
 N EA 1 4 1 E
 Portable wooden rolling ladder, 6ft 3in high, X 22in wide.

300084381 LADDER COMBINATION 7807 FIBERGLAS
 1217133 1 EA IL IN MI OH WI E
 12 12 12 12 12
 A fiberglass ladder which can be used as a 7ft stepladder or a 11 1/2ft extension ladder.

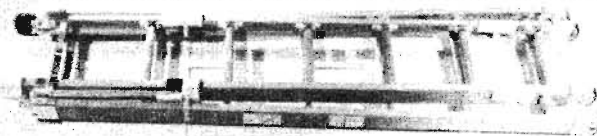

1217133

KNIFE

400153599 KNIFE CHIPPING SMALL CA06312
 1227439 1 EA E
 Blade of knife measures 3in long X 1/8in thick. Use with Guard Knife Chipping Small (1181644).

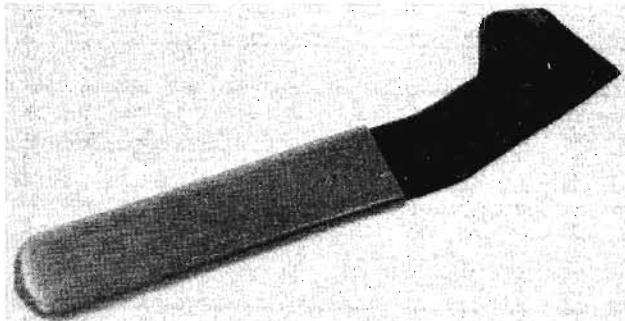

400153599

280017559 KNIFE KLEIN SPORTSMAN 44037
 N EA 1 3 1 E
 Blade locks open, 3-3/8IN.

001238989 KNIFE PUTTY 1 1/4IN ST4701
 5378687 1 EA IL IN MI OH WI E
 12 12 12 12 12
 7 1/2in long, blade 1 1/8in wide X 3 1/2in long, for general use.

LADDER EXTENSION

260441936 LADDER EXTENSION 16FT WITH V RUNG
 N EA 1 5 1

260441951 LADDER EXTENSION 24FT DR WITH HOOKS
 N EA 1 5 1

260441944 LADDER EXTENSION 24FT WITH V RUNG
 N EA 1 5 1

260441977 LADDER EXTENSION 284FT DR WITH HOOKS
 N EA 1 5 1

260441969 LADDER EXTENSION 284FT WITH V RUNG
 N EA 1 5 1

DISTRIBUTION SERVICES

NETWORK SERVICES

TOOLS

BUILDING JANITORIAL

AUTOMOTIVE

FORMS/OFFICE SUPPLIES

GENERAL

DATA VOICE

DISTRIBUTION SERVICES

NETWORK SERVICES

TOOLS

BUILDING JANITORIAL

AUTOMOTIVE

FORMS/OFFICE SUPPLIES

GENERAL

DATA VOICE

LADDER EXTENSION

PRODUCT IDENTIFIER		DESCRIPTION							
ITEM NUMBER	ORD. MULT.	SELL UNIT	STD. PKG. STOCK AVAILABILITY / PA	LEAD TIME	MIN. ORD.	A		C	

400691234 LADDER EXTENSION E 24FT W/HOOKS								
1155994	1	EA	IL IN MI OH WI					E
			12 12 12 12 12					

CA08616. Consists of two interlocking channel side rails of fiberglass, aluminum rungs & plated steel locks, e/w 3/8in rope & pulley to raise & lower top section. Also e/w aluminum hooks and spurs.

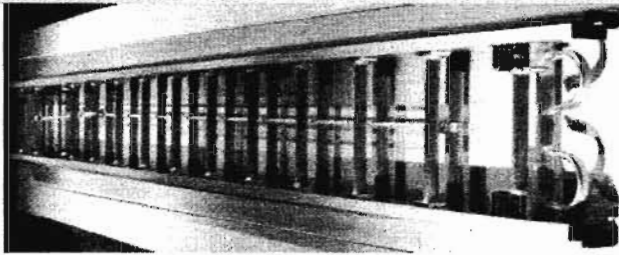

1155994

400691283 LADDER EXTENSION E 28FT W/HOOKS								
1171470	1	EA	IL IN MI OH WI					E
			12 12 12 12 12					

CA08616. Same as Ladder Extension E 24ft W/Hooks.

001220847 LADDER EXTENSION FIBERGLASS 16FT								
4299362	1	EA	IL IN MI OH WI					E
			12 12 12 12					

PE 1005.

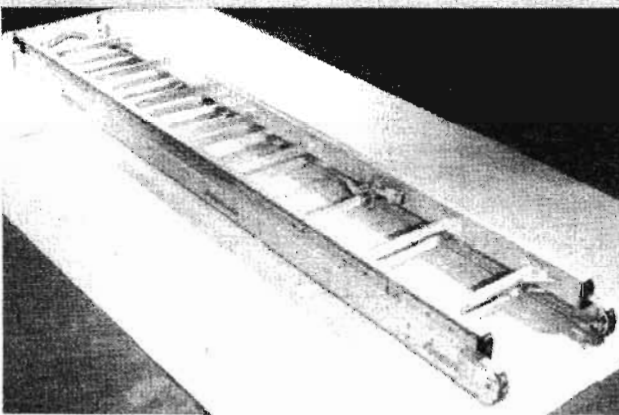

4299362

300088887 LADDER EXTENSION FIBERGLASS 24FT								
1920702	1	EA	IL IN MI OH WI					E
			12 12 12 12 12					

WITH POLE-GRIP, CA08616.

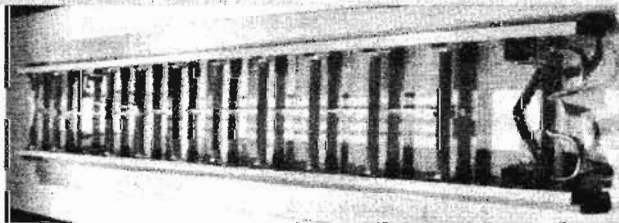

1920702

300088879 LADDER EXTENSION FIBERGLASS 28FT								
1920694	1	EA	IL IN MI OH WI					E
			12 12 12 12 12					

WITH POLE-GRIP, CA08616.

PRODUCT IDENTIFIER		DESCRIPTION							
ITEM NUMBER	ORD. MULT.	SELL UNIT	STD. PKG. STOCK AVAILABILITY / PA	LEAD TIME	MIN. ORD.	A		C	

LADDER STEP

260300256 LADDER STEP 11007 7FT WOODEN								
N		EA	1	2	1			E
Meets or exceeds 1A Industrial classification.								

280099300 LADDER STEP 11014 14FT WOODEN								
N		EA	1	2	1			E
Meets or exceeds 1A Industrial classification.								

400155032 LADDER STEP D 8FT CA07544								
1196964	1	EA	IL IN MI OH WI					E
			12 12 12 12 12					
Intended for indoor use.								

402018386 LADDER STEP E 4FT RUBBER FEET								
3173807	1	EA	IL IN MI OH WI					E
			12 12 12 12 12					
CA07544. For inside use of plant forces.								

400155073 LADDER STEP E 5FT CA07544								
1333641	1	EA	IL IN MI OH WI					E
			12 12 12 12					
For inside use of plant forces.								

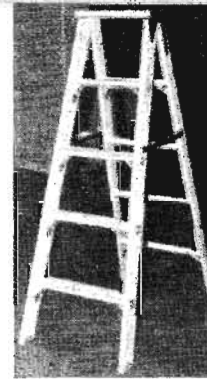

1333641

402018527 LADDER STEP E 6FT RUBBER FEET								
3173823	1	EA	IL IN MI OH WI					E
			12 12 12 12 12					
CA07544. For inside use of plant forces.								

400155107 LADDER STEP E 10FT CA07544								
1230144	1	EA	IL IN MI OH WI					E
			12 12 12 12 12					
For inside use of plant forces.								

400155115 LADDER STEP E 12FT CA07544								
7134627	1	EA	IL IN MI OH WI					E
			12 12 12 12 12					
For inside use of plant forces.								

LADDER STRAIGHT

401343405 LADDER STRAIGHT 10FT PTD/SPURS								
1196980	1	EA						E
A single length ladder for outside forces.								

PRODUCT IDENTIFIER		DESCRIPTION						MIN.	A
ITEM NUMBER	ORD. MULT.	SELL UNIT	STD. PKG. STOCK AVAILABILITY / PA		LEAD TIME		ORD.	C	
401343413 LADDER STRAIGHT 12FT FIBERGLASS									
1187641	1	EA	IL	IN	MI	OH	WI	E	
			12	12	12	12	12		
Combination foot. A single length ladder for outside forces.									

PRODUCT IDENTIFIER		DESCRIPTION						MIN.	A
ITEM NUMBER	ORD. MULT.	SELL UNIT	STD. PKG. STOCK AVAILABILITY / PA		LEAD TIME		ORD.	C	
300073558 LAMP FLASHLIGHT PR 31 K2-2									
1193672	1	EA	IL	IN	MI	OH	WI	E	
			12	12	12	12	12		
A replacement bulb for use in the duracell DFF flashlight only.									

LAMP								
260303771 LAMP 50WATT ARMORIZED X-DUTY 4100								
N		EA	1		1		1	E
260303789 LAMP 75WATT ARMORIZED X-DUTY 369								
N		EA	1		1		1	E
260303797 LAMP 100WATT ARMORIZED X-DUTY 4160								
N		EA	1		1		1	E
260303805 LAMP 150WATT ARMORIZED X-DUTY 4220								
N		EA	1		1		1	E
260303813 LAMP 200WATT ARMORIZED X-DUTY 4510								
N		EA	1		1		1	E
401424650 LAMP BEAM BIG 166								
N		EA	6		2		6	E

280062860 LAMP EMERGENCY 500W 120V 501								
1930719	1	EA	IL	IN	MI	OH	WI	E
			12	12	12	12	12	
Super flood P/N SU 501. Required for emergency lighting.								



1930719

280057373 LAMP EMERGENCY S.U. 510								
1930727	1	EA	IL	IN	MI	OH	WI	E
			12	12	12	12	12	
Replacement bulb for emergency lamp.								

280094103 LAMP FLUORESCENT 30W 25FT CORD								
1937383	1	EA	IL	IN	MI	OH	WI	E
			12	12	12	12	12	
Portable, 30-3025-HD.								

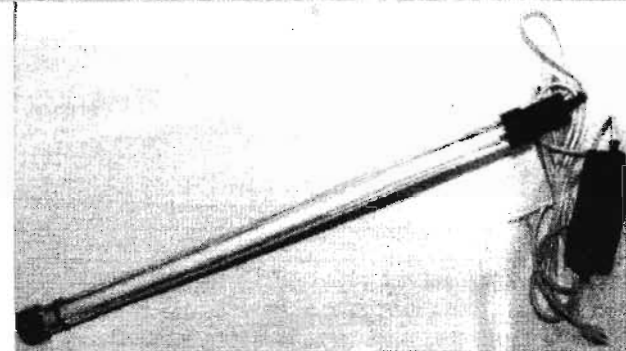

1937383

001186360 LAMP HAND VAPROTEX								
N		EA	1		3		1	E

401343843 LAMP INFRARED 250W 40/S								
5131623	1	EA	IL	IN	MI	OH	WI	E
			12			12		

300086212 LAMP MAGNIFIER CMC 3972-A								
N		EA	1		1		1	E
22 watt, 15 volt only AC fluorescent 3-cord.								

300086220 LAMP MAGNIFIER LC1A								
N		EA	1		1		1	E
Equipped with Magnification Lens and Portable Clamps.								

401775077 LAMP MAGNIFIER R4554								
N		EA	1		4		6	E
Replacement lamp for Flashlight R4554 (300085834).								

DISTRIBUTION SERVICES

NETWORK SERVICES

TOOLS

BUILDING JANITORIAL

AUTOMOTIVE

FORMS/OFFICE SUPPLIES

GENERAL

DATA VOICE

DISTRIBUTION SERVICES

LAMP

PRODUCT IDENTIFIER		DESCRIPTION							MIN. A
ITEM NUMBER	ORD. MULT.	SELL UNIT	STD. PKG. STOCK AVAILABILITY / PA	LEAD TIME		MI	OH	WI	ORD. C
401491063 LAMP MANHOLE 523 110V W/106									
1189332	1	EA	IL 12	IN 12	MI 12	OH 12	WI 12		E

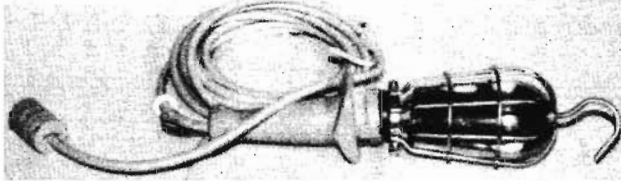

1189332

NETWORK SERVICES

TOOLS

PRODUCT IDENTIFIER		DESCRIPTION							MIN. A
ITEM NUMBER	ORD. MULT.	SELL UNIT	STD. PKG. STOCK AVAILABILITY / PA	LEAD TIME		MI	OH	WI	ORD. C
401943006 LAMP PORTABLE CA07652									
2820340	1	EA	IL 12	IN 12	MI 12	OH 12	WI 12		E
A 25ft three conductor extension cord equipped with 3 wire outlets on the same lamp guard. Used by installation and repair forces.									

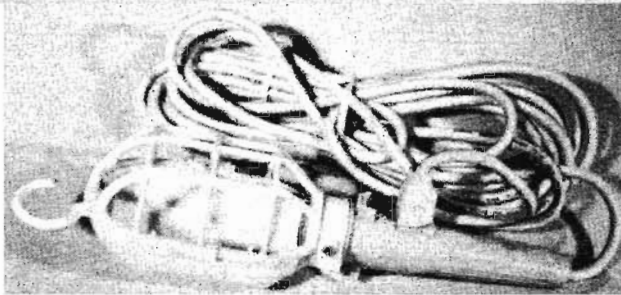

2820340

BUILDING JANITORIAL

AUTOMOTIVE

PRODUCT IDENTIFIER		DESCRIPTION							MIN. A
ITEM NUMBER	ORD. MULT.	SELL UNIT	STD. PKG. STOCK AVAILABILITY / PA	LEAD TIME		MI	OH	WI	ORD. C
280043738 LAMP REPLACEMENT BB2000									
1925123	4	EA	IL 12	IN 12	MI 12	OH 12	WI		E
For hand held spotlight.									

PRODUCT IDENTIFIER		DESCRIPTION							MIN. A
ITEM NUMBER	ORD. MULT.	SELL UNIT	STD. PKG. STOCK AVAILABILITY / PA	LEAD TIME		MI	OH	WI	ORD. C
260322060 LAMP REPLACEMENT UV SL-100 82042									
N		EA	1		3		1		E
A replacement lamp for Light UV SL-100 81013 (PID260322045).									

PRODUCT IDENTIFIER		DESCRIPTION							MIN. A
ITEM NUMBER	ORD. MULT.	SELL UNIT	STD. PKG. STOCK AVAILABILITY / PA	LEAD TIME		MI	OH	WI	ORD. C
300086238 LAMP SPLICERS JP-3475									
N		EA	1		3		2		E
Used to provide lighting for splicing cables. Use replacement Lamp 150 Par FI 120V West (2398867).									

PRODUCT IDENTIFIER		DESCRIPTION							MIN. A
ITEM NUMBER	ORD. MULT.	SELL UNIT	STD. PKG. STOCK AVAILABILITY / PA	LEAD TIME		MI	OH	WI	ORD. C
260391099 LAMP T1									
N		PK	1		2		1		E
For Flashlite Mini-Maglite 2AA (260318076).									

GENERAL

DATA VOICE

PRODUCT IDENTIFIER		DESCRIPTION							MIN. A
ITEM NUMBER	ORD. MULT.	SELL UNIT	STD. PKG. STOCK AVAILABILITY / PA	LEAD TIME		MI	OH	WI	ORD. C

LANTERN

PRODUCT IDENTIFIER		DESCRIPTION							MIN. A
ITEM NUMBER	ORD. MULT.	SELL UNIT	STD. PKG. STOCK AVAILABILITY / PA	LEAD TIME		MI	OH	WI	ORD. C
402764955 LANTERN ELECTRIC B CA09003									
5509109	1	EA							E

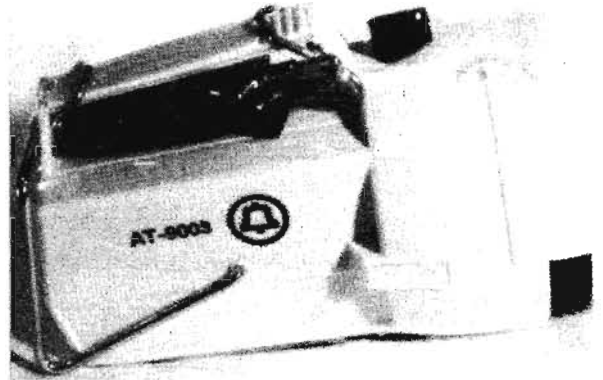

402764955

LEADS

280038514 LEADS SAFETY WRAP PIN .025 FEMALE									
N		EA	1		2		10		E
260320437 LEADS TALK CIRCUIT PL276-2									
N		EA	1		2		1		E
260436431 LEADS TEST 79-153 TRIPLETT									
N		EA	1		2		1		
260436449 LEADS TEST 79-493 TRIPLETT									
N		EA	1		2		1		
260436456 LEADS TEST 79-513 TRIPLETT									
N		EA	1		2		1		
260436472 LEADS TEST 79-537 TRIPLETT									
N		EA	1		2		1		
260436464 LEADS TEST 79-548 TRIPLETT									
N		EA	1		2		1		

PRODUCT IDENTIFIER DESCRIPTION

ITEM NUMBER	ORD. MULT.	SELL UNIT	STD. PKG. STOCK AVAILABILITY / PA	LEAD TIME	MIN. ORD.	A C
-------------	------------	-----------	-----------------------------------	-----------	-----------	-----

402138077 LEADS TEST CK14510 L12
 1403402 1 EA IL IN MI OH WI E
 12 12 12 12 12
 Used with Meter CK14510 L11 (2608448), BSP 084-810-101 & BSP 100-520-101.



1403402

260411731 LEADS TEST SET Y8132						
N		EA	1	2	1	E
260411798 LEADS TEST TL20						
N		EA	1	2	1	E
260411806 LEADS TEST TL22						
N		EA	1	2	1	E
260411780 LEADS TEST TL24						
N		EA	1	2	1	E
260411756 LEADS TEST TL26						
N		EA	1	2	1	E
260411764 LEADS TEST TL28						
N		EA	1	2	1	E
260411772 LEADS TEST TL70						
N		EA	1	2	1	E

LEG IRONS

SEE IRONS LEG.

LEVEL

300023041 LEVEL SPIRIT STANLEY 9IN
 5104737 1 EA STANLEY 42-264. E

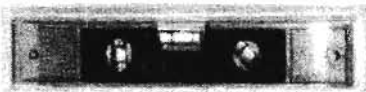

300023041

300023058 LEVEL SPIRIT STANLEY 18IN
 N EA 1 2 1 E
 STANLEY 42-180.

300023066 LEVEL SPIRIT STANLEY 24IN
 N EA 1 2 1 E
 STANLEY 42-241.

PRODUCT IDENTIFIER DESCRIPTION

ITEM NUMBER	ORD. MULT.	SELL UNIT	STD. PKG. STOCK AVAILABILITY / PA	LEAD TIME	MIN. ORD.	A C
-------------	------------	-----------	-----------------------------------	-----------	-----------	-----

LIFTER

300086253 LIFTER CABLE BLOCK C 7163
 N EA 1 8 2 E
 Used with handle sections for placing Block Cable D on suspension strand.

260405857 LIFTER MANHOLE COVER G1368
 N EA 1 5 1 E

LIGHT

400500617 LIGHT PORTABLE HMR-41075-2000
 1144337 1 EA E
 Used as a flood or spot lite. Uses Battery 7.5V CK15939 (Item 1101097) and Bulb P/N 98039-0010 PID 260444955 (Item 1983775).

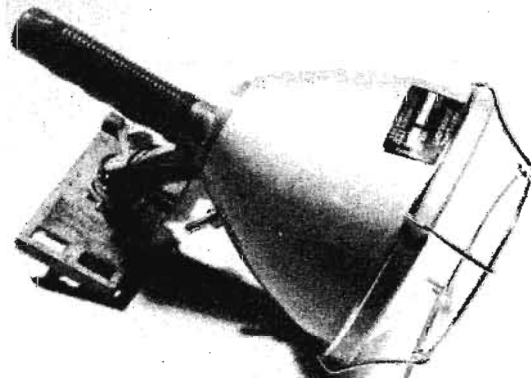

400500617

260444955 LIGHT REPLACEMENT BULB P/N 98039-0010
 1983775 EA IL IN MI OH WI
 Graybar. For: Portable Light HMR 41075-2000, PID 400500617 (Item 1144337).

002055457 LIGHT SPOT FLOOD
 1135475 1 EA IL IN MI OH WI E
 12 12 12 12 12
 With 12ft coil cord.

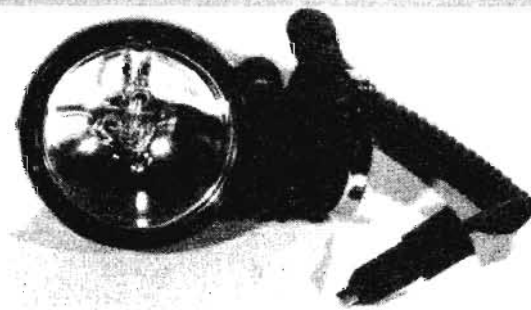

1135475

280071176 LIGHT SPOT SUPER 800-1500-0
 N EA 1 3 1 E
 With magnetic base.

DISTRIBUTION SERVICES

NETWORK SERVICES

TOOLS

BUILDING JANITORIAL

AUTOMOTIVE

FORMS/OFFICE SUPPLIES

GENERAL

DATA VOICE

DISTRIBUTION SERVICES

LIGHT

PRODUCT IDENTIFIER		DESCRIPTION				
ITEM NUMBER	ORD. MULT.	SELL UNIT	STD. PKG. STOCK AVAILABILITY / PA	LEAD TIME	MIN. ORD.	A C

260322045 LIGHT UV SL-100 81013
 N EA 1 3 3 E
 An Ultra-violet light used to cure adhesive in a fiber optic mechanical connector. Order: Lamp Replacement UV SL-100 82042 (PID260322060) & Adapter AC Light UV SL-100 82049 (PID260322052).

LIGHT HARDHAT

SEE HEADLAMP/HEADLIGHT

NETWORK SERVICES

LIGHTER

401937453 LIGHTER FRICTION CA07932
 1434928 1 EA E
 A lighter used instead of matches and associated with an acetylene torch used in replacing sheath defect in aerial cables only. Use Flint Lighter Renewal (1175976) for extra flints, BSP 081-330-105.



401937453

TOOLS

BUILDING JANITORIAL

LINE

401345772 LINE JET PACKAGE 1/2/3/4IN
 6213785 1 RO E

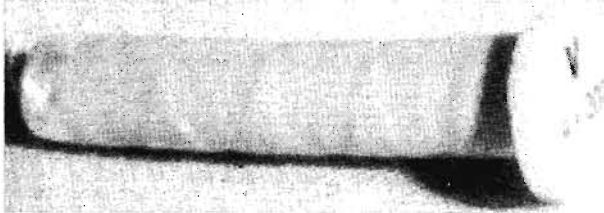

401345772

AUTOMOTIVE

FORMS/OFFICE SUPPLIES

LINER CAP SAFETY

280003526 LINER HARDHAT CAPE STYLE LARGE
 1942821 1 EA E
 EL29 long neck. Intended to be used with Cap Safety (1951020).

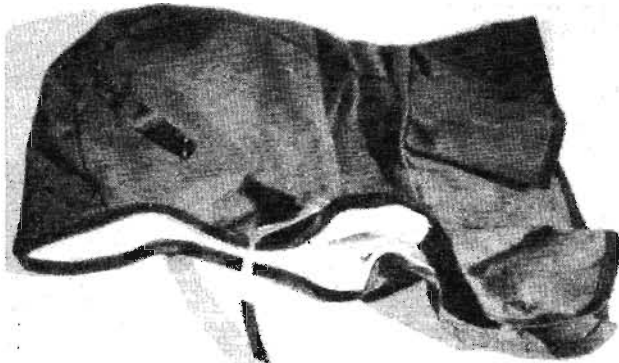

280003526

GENERAL

DATA VOICE

PRODUCT IDENTIFIER		DESCRIPTION				
ITEM NUMBER	ORD. MULT.	SELL UNIT	STD. PKG. STOCK AVAILABILITY / PA	LEAD TIME	MIN. ORD.	A C

280003534 LINER HARDHAT CAPE STYLE MEDIUM
 1942813 1 EA IL IN MI OH WI E
 12 12 12 12 12
 EL29 long neck. Intended to be used with Cap Safety (1951020).

900261900 LINER WINTER 30 FVB LARGE
 1314120 1 EA IL IN MI OH WI E
 12 12 12 12 12
 Size 7 3/8 to 7 7/8. Intended for use with Cap Safety (1951020), BSP 081-020-010.

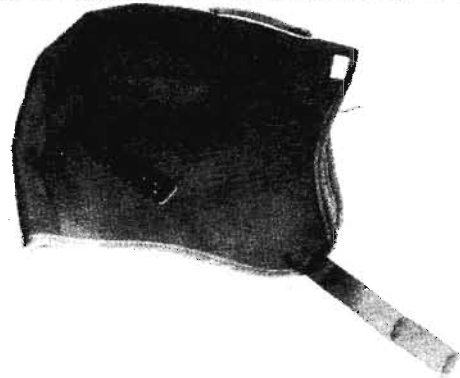

1314120

401345830 LINER WINTER 70EL52 LRG
 1179754 1 EA IL IN MI OH WI E
 12 12
 DISCONTINUED - REPLACED BY LINER WINTER 30.FVB LARGE.

900261918 LINER WINTER MEDIUM 30 FVBM
 1314112 1 EA IL IN MI OH WI E
 12 12 12 12 12
 Intended for use with Cap Safety (1951020), BSP 081-020-010.

LINK CONNECTOR

400491726 LINK CONNECTOR B 1/2IN
 1200147 1 EA E
 Safe load 3,000lb.



400491726

400491734 LINK CONNECTOR B 1/4IN CA08077
 N EA 5 4 5 E

400491700 LINK CONNECTOR B 3/4IN
 1306159 1 EA IL IN MI OH WI E
 12 12 12 12 12
 Safe load 6,000lb.

PRODUCT IDENTIFIER		DESCRIPTION							MIN.	A
ITEM NUMBER	ORD. MULT.	SELL UNIT	STD. PKG. STOCK AVAILABILITY / PA		LEAD TIME			ORD.	C	
400491718 LINK CONNECTOR B 3/8IN										
1188185	1	EA	IL 12	IN 12	MI 12	OH 12	WI 12		E	

400155743 LINK CONNECTOR B 1IN									
N		EA	5		4			5	E

LOCATOR CABLE

260323423 LOCATOR CABLE									
N		EA	1		2			1	E

280015512 LOCATOR CABLE 500A									
N		EA	1		9			1	E

260357470 LOCATOR CABLE 730 FAULT/OPEN									
N		EA	1		6			1	E
Including 9019.									

260357728 LOCATOR CABLE 9043 GROUND EXTENSION									
N		EA	1		9			1	E

300097672 LOCATOR CABLE MINI-TRACER 508									
1920900	1	EA	IL 12	IN 12	MI 12	OH 12	WI 12		E
Used to locate a cable path and open faults in buried service drop wire.									

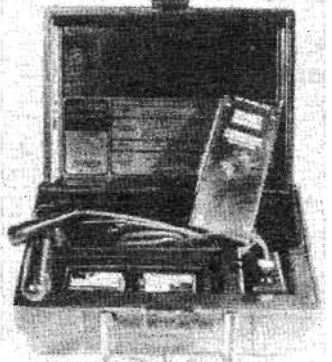

1920900

LP GAS
SEE CYLINDER.

LUBRICANT

403549512 LUBRICANT PENETRANT PR3 4516									
1131565	1	EA							E

PRODUCT IDENTIFIER		DESCRIPTION							MIN.	A
ITEM NUMBER	ORD. MULT.	SELL UNIT	STD. PKG. STOCK AVAILABILITY / PA		LEAD TIME			ORD.	C	
900509217 LUBRICANT SILICONE 200 2OZ BOTTLE										
1145078	1	BT	IL 12	IN 12	MI 12	OH 12	WI 12		E	

General purpose silicone used to lubricate air pressure tools. Squeeze bottle.



1145078

METER

260321633 METER 25DMM									
N		EA	1		2			1	E

260411715 METER 27DMM									
N		EA	1		2			1	E

260411681 METER 77DMM									
N		EA	1		2			1	E

260411673 METER 83DMM									
1975631	1	EA	IL 12	IN 12	MI 12	OH 12	WI 12		E

260411699 METER 87DMM									
N		EA	1		2			1	E

260436399 METER 310 TRIPLET									
N		EA	1		2			1	E

260436381 METER 510 BIDDLE									
N		EA	1		3			1	E

260411707 METER 8024B									
N		EA	1		2			1	E

DISTRIBUTION SERVICES

NETWORK SERVICES

TOOLS

BUILDING JANITORIAL

AUTOMOTIVE

FORMS/OFFICE SUPPLIES

GENERAL

DATA VOICE

DISTRIBUTION SERVICES

NETWORK SERVICES

TOOLS

BUILDING JANITORIAL

AUTOMOTIVE

FORMS/OFFICE SUPPLIES

GENERAL

DATA VOICE

METER

PRODUCT IDENTIFIER		DESCRIPTION						
ITEM NUMBER	ORD. MULT.	SELL UNIT	STD. PKG. STOCK AVAILABILITY / PA	LEAD TIME	MIN. ORD.	A	C	

401549431 METER CK14510 L11 WITH CASE

2608448	1	EA	IL 12	IN 12	MI 12	OH 12	WI 12	E
---------	---	----	-------	-------	-------	-------	-------	---

A portable AC/DC VOM for SLC-96 testing purposes, BSP 100-520-101.

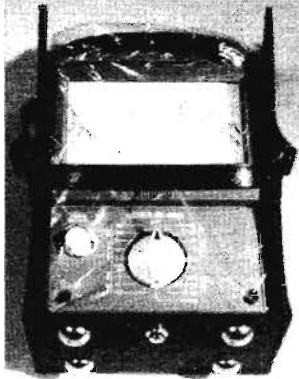

2608448

997331368 METER CK16979 L1 WITH TEST LEADS

1105593	1	EA	IL 12	IN 12	MI 12	OH 12	WI 12	E
---------	---	----	-------	-------	-------	-------	-------	---

& BATTERY. A portable volt-ohm millimeter having various resistances. Use with Case Carry CK16979 L9 (5290348), BSP 084-810-101 & BSP 570-005-101.

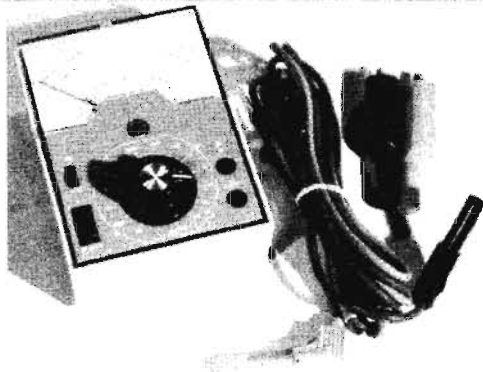

1105593

280025933 METER CURRENT T304

N	EA	1	4	1	E
---	----	---	---	---	---

A current flow meter used to verify cable shield continuity.

280003385 METER DIGITAL 248 MULTI DATA

N	EA	1	1	1	E
---	----	---	---	---	---

Volt-ohm millimeter for general testing.

PRODUCT IDENTIFIER		DESCRIPTION						
ITEM NUMBER	ORD. MULT.	SELL UNIT	STD. PKG. STOCK AVAILABILITY / PA	LEAD TIME	MIN. ORD.	A	C	

300064136 METER DIGITAL 8021B MULTI M/D

1162289	1	EA	IL 12	IN 12	MI 12	OH 12	WI 12	E
---------	---	----	-------	-------	-------	-------	-------	---

Portable digital multimeter, LED readout. To be used for SLC-96, Multiplexer, chattos etc. Used with Case Carry C 90 (1152678). DISCONTINUE UPON STOCK DEPLETION-REPLACED BY METER 83DMM - PID260411673.

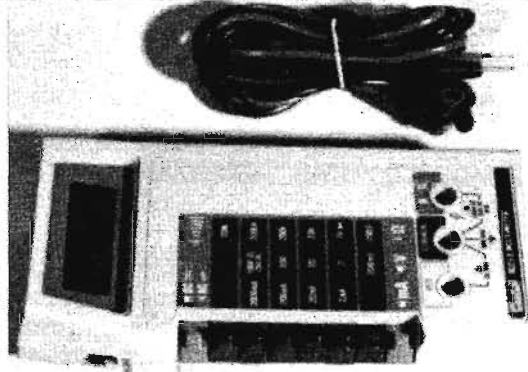

1162289

260389051 METER DIGITAL 8024A MULTI

N	EA	1	1	E
---	----	---	---	---

260389069 METER DIGITAL 8060A MULTI

N	EA	1	1	E
---	----	---	---	---

260436365 METER DIGITAL DM10

N	EA	1	2	1
---	----	---	---	---

260436415 METER DM78 BECKMAN

N	EA	1	2	1
---	----	---	---	---

260436555 METER HD-100 BECKMAN

N

280013731 METER MINITESTER RS232 232MTT

N	EA	1	2	1	E
---	----	---	---	---	---

260436357 METER MODEL #2 TRIPLETT

N	EA	1	2	1
---	----	---	---	---

260436373 METER MODEL #4 TRIPLETT

N	EA	1	2	1
---	----	---	---	---

PRODUCT IDENTIFIER		DESCRIPTION				
ITEM NUMBER	ORD. MULT.	SELL UNIT	STD. PKG. STOCK AVAILABILITY / PA	LEAD TIME	MIN. ORD.	A C

300086568 METER MULTI 310 VOM TYPE 5 TRIPLET
 N EA 1 3 1 E

Voltmeter used in cable maintenance. Case not included, use with Case Carry 369T(300086600 Order Non-Stock).

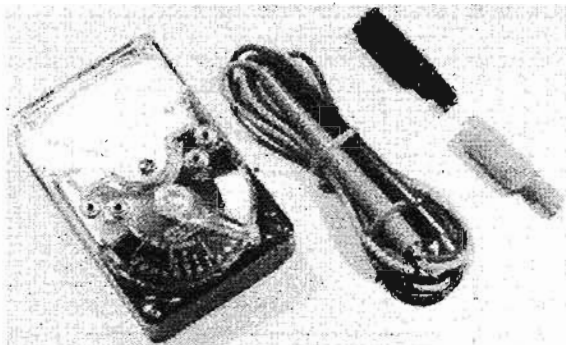

300086568

MIRROR

400161485 MIRROR SPLICER CA07423
 1201707 1 EA E

Used by cable splicers for examining the underside of wiped joints and cable sheath.

MODULE

280037284 MODULE BATTERY C50P
 N EA 1 2 1 E

260389085 MODULE MULTI MODE 850NM TD-260
 N EA 1 1 E

260389077 MODULE MULTI MODE 1300NM TD-273
 N EA 1 1 E

260389010 MODULE PRINTER CONTROL 2760-21
 N EA 1 1 E

260389127 MODULE SINGLE MODE 1300NM TD-263
 N EA 1 1 E

260389093 MODULE SINGLE MODE 1300NM TD-273
 N EA 1 1 E

260389101 MODULE SINGLE MODE 1300NM TD-275
 N EA 1 1 E

260389119 MODULE SINGLE MODE 1550NM TD-274
 N EA 1 1 E

260389135 MODULE SINGLE MODE DUAL 1300/1550NM TD-265.
 N EA 1 1 E

PRODUCT IDENTIFIER		DESCRIPTION				
ITEM NUMBER	ORD. MULT.	SELL UNIT	STD. PKG. STOCK AVAILABILITY / PA	LEAD TIME	MIN. ORD.	A C

NUT DRIVER

SEE DRIVER NUT.

OIL

260439880 OIL 4 OZ #809 (TOOL KIT)
 N EA 1 2 1

Air impact tool parts.

996453148 OIL NEATSFOOT 1 PINT CAN
 1204800 1 CN IL IN MI OH WI E
 12 12 12 12 12

Used as a dressing/preservative for all leather goods, such as safety belts, climber straps and tool bags.



1204800

OILER

400163218 OILER CK14796 L1 6 OUNCE CAN
 1204842 1 EA E

Pump type oil can e/w finger trigger, designed to produce either a minutemeasured quantity or a small steady stream of light oil. For lubrication of teletypewriters, BSP 074-235-140.

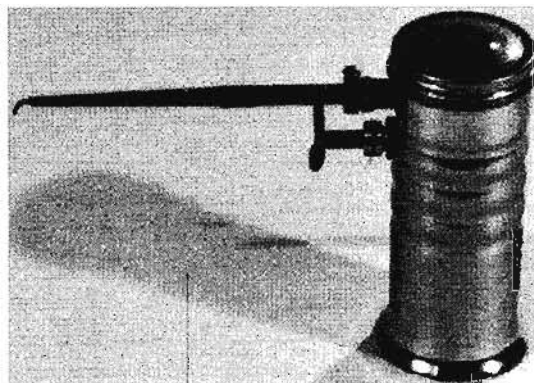

400163218

260439898 OILER #810 (TOOL KIT)
 N EA 1 2 1

Air impact tool parts.

DISTRIBUTION SERVICES

NETWORK SERVICES

TOOLS

BUILDING JANITORIAL

AUTOMOTIVE

FORMS/OFFICE SUPPLIES

GENERAL

DATA VOICE

DISTRIBUTION SERVICES

PACK BATTERY

PRODUCT IDENTIFIER		DESCRIPTION				
ITEM NUMBER	ORD. MULT.	SELL UNIT	STD. PKG. STOCK AVAILABILITY / PA	LEAD TIME	MIN. ORD.	A C

ORANGE STICK

SEE STICK ORANGE.

NETWORK SERVICES

PACK BATTERY

260369020 PACK BATTERY 3.6V/2.2AH

1955567	1	EA				E
---------	---	----	--	--	--	---

Pack consists of three batteries strapped together. For use with Terminal Craft Access 512K (Itron T4000 Teletch Test Set) PID260338041.

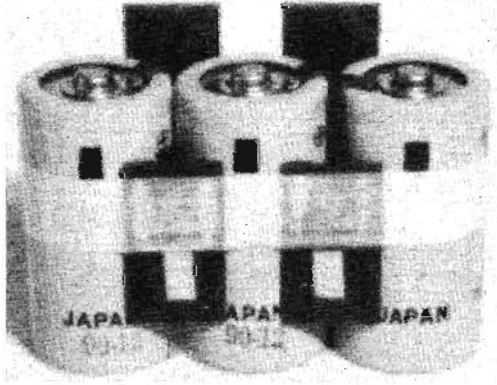

260369020

280019860 PACK BATTERY 91850029

N		PK	1	2	1	E
---	--	----	---	---	---	---

For 143A Test Set.

280017815 PACK BATTERY C48

N		EA	1	2	1	E
---	--	----	---	---	---	---

For Model 245 Digital Meter.

TOOLS

BUILDING JANITORIAL

AUTOMOTIVE

FORMS/OFFICE SUPPLIES

GENERAL

DATA VOICE

PAD

400163390 PAD CLIMBER B CA08149

1144303	1	PR				E
---------	---	----	--	--	--	---

Cushioned pads protect both the calf and shin. Used with Irons Leg Climber F & H (1102590 & 5364562), BSP 081-720-300.

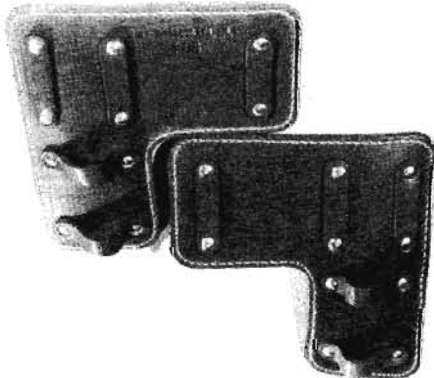

400163390

PRODUCT IDENTIFIER		DESCRIPTION				
ITEM NUMBER	ORD. MULT.	SELL UNIT	STD. PKG. STOCK AVAILABILITY / PA	LEAD TIME	MIN. ORD.	A C

401780937 PAD LADDER B CA08804

5396242	1	PR	IL IN MI OH WI			E
			12 12 12 12 12			

An extension ladder pad intended to prevent damage to buildings having fragile siding, BSP 460-300-108.

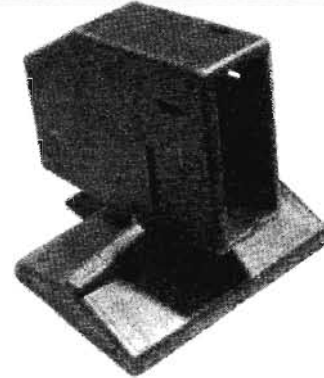

5396242

401351176 PAD LEATHER DWB-B2881 F2

N		EA	1	4	48	E
---	--	----	---	---	----	---

Commercial.

002015535 PAD SHIELD HEAT AD1460

1161737	1	EA	IL IN MI OH WI			E
			12 12 12 12 12			

Fiberglass heat shield pad. It is used with the XAGA kit in repairing cable sheath openings. It reflects heat and protects the cable from damage during repair.

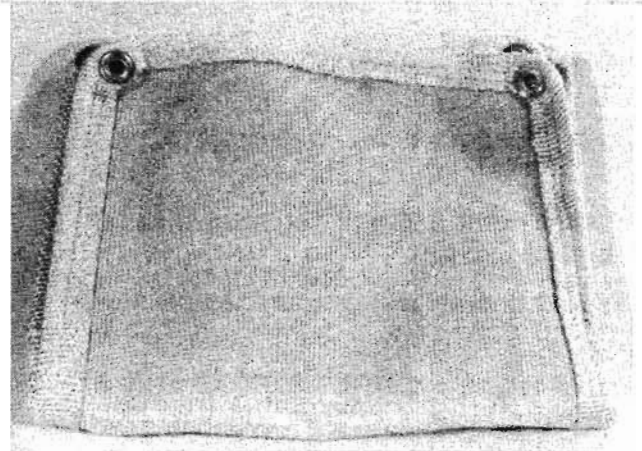

1161737

PADLOCK

401351275 PADLOCK 620A KEYED ALIKE

1163626	1	EA				E
---------	---	----	--	--	--	---

A cast bronze padlock with steel hardened bronze shackle and is stronger than the sterling rotary shackle lock.



401351275

PRODUCT IDENTIFIER DESCRIPTION

ITEM NUMBER	ORD. MULT.	SELL UNIT	STD. PKG. STOCK AVAILABILITY / PA	LEAD TIME	MIN. ORD.	A C
-------------	------------	-----------	-----------------------------------	-----------	-----------	-----

400483673		PADLOCK	620A	KEYED DIFFERENT				
1146233	1	EA	IL 12	IN 12	MI 12	OH 12	WI 12	E
WITH 2 KEYS. Brass shackle.								

401351291		PADLOCK	621	WITH 2 KEYS				
5148585	1	EA	IL 12	IN 12	MI 12	OH 12	WI 12	E
Steel shackle.								

401351317		PADLOCK	622	WITH 2 KEYS				
1205765	1	EA	IL 12	IN 12	MI 12	OH 12	WI 12	E
Steel shackle.								

403030901		PADLOCK	622A	CB KA BELL				
1159657	1	EA	IL 12	IN 12	MI 12	OH 12	WI 12	E
Keyed Alike. IBT brass shackle, bronze chain.								

401351325		PADLOCK	659A	WITH 2 KEYS				
2680645	1	EA	IL 12	IN 12	MI 12	OH 12	WI 12	E
Brass Shackle.								

260396619		PADLOCK MASTER	10	RANDOM KEYED		
N		EA	12	2	72	E

300052487		PADLOCK MASTER	175	KEYLESS				
1229302	1	EA	IL 12	IN 12	MI 12	OH 12	WI 12	E

300052495		PADLOCK MASTER	175LH	KEYLESS LONG				
6509497	1	EA	IL 12	IN 12	MI 12	OH 12	WI 12	E

PADLOCK KEY

001133065		KEY	622A	CB KA				
1214478	1	EA	Keys only for Padlock 622A CB KA (1159657).					

PAIL

400408480		PAIL	GALVANIZED	14QT				
5148700	1	EA						

PRODUCT IDENTIFIER DESCRIPTION

ITEM NUMBER	ORD. MULT.	SELL UNIT	STD. PKG. STOCK AVAILABILITY / PA	LEAD TIME	MIN. ORD.	A C
-------------	------------	-----------	-----------------------------------	-----------	-----------	-----

PAN DUST

401351390		PAN DUST	HOODED	16IN			
1126763	1	EA	Heavy gauge steel.				E

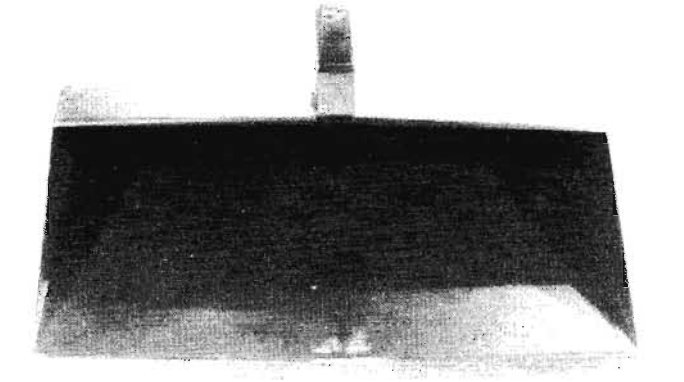

401351390

PAPER ABRASIVE

400443099		PAPER ABRASIVE	4 1/2IN X 11IN	CK13148			
1207365	1	EA	For cleaning surfaces of panel dial system communicators, package of 400, BSP 065-710-100.				E

402940662		PAPER ABRASIVE	9	IN X 10IN	COARSE	
N		SH	50	2	50	E
Flint.						

402940670		PAPER ABRASIVE	9	IN X 10IN	FINE	
N		SH	50	2	50	E
Flint.						

401427117		PAPER ABRASIVE	9	IN X 10IN	MEDIUM	
N		SH	50	2	50	E
Flint.						

402940688		PAPER ABRASIVE	9	IN X 11IN	220A	
N		SH	50	2	50	E
Aluminum oxide.						

PAPER EMERY

401353578		PAPER EMERY	9 X 13 3/4	FINE 2/0		
N		SH	100	2	100	E

PAPER SAND

401426770		PAPER SAND	8/0	GARNET		
N		SH	50	2	50	E

401153978		PAPER SAND	COARSE	9IN X 10IN				
5217885	1	SH	IL 33	IN 33	MI 33	OH 33	WI 33	E

DISTRIBUTION SERVICES

NETWORK SERVICES

TOOLS

BUILDING JANITORIAL

AUTOMOTIVE

FORMS/OFFICE SUPPLIES

GENERAL

DATA VOICE

PENLIGHT

PRODUCT IDENTIFIER		DESCRIPTION					MIN.	A
ITEM NUMBER	ORD. MULT.	SELL UNIT	STD. PKG. STOCK AVAILABILITY / PA	LEAD TIME	MIN.	ORD.	A	
							C	

PRODUCT IDENTIFIER		DESCRIPTION					MIN.	A
ITEM NUMBER	ORD. MULT.	SELL UNIT	STD. PKG. STOCK AVAILABILITY / PA	LEAD TIME	MIN.	ORD.	A	
							C	

DISTRIBUTION SERVICES

NETWORK SERVICES

TOOLS

BUILDING JANITORIAL

AUTOMOTIVE

FORMS/OFFICE SUPPLIES

GENERAL

DATA VOICE

PATCH CORD

SEE CORD PATCH.

PENLIGHT

280016692			AA	221	B100					
N		EA		1		2		6		E

401814066			AA	3022	LARGE					
2649202	1	EA		IL	IN	MI	OH	WI		E
				12	12	12	12	12		



2649202

PIN EXTENSION

400463881				R271	SURE SET					
5142505	1	EA								E



400463881

PLANK

401154414					EXTENDABLE W.E.	4FT				
8382606	1	EA								E

An extendable plank for use with manhole platform supports. Extends to 6 foot, BSP 081-300-100.



401154414

PLATFORM

280038480					PLATFORM STYLE A					
N		EA		1		2		1		E

Roll-A-Reel. Consists of a metal frame with 2 rollers, one of which is adjustable to accommodate various size reels, up to a maximum width of 28 inches.

280038498					PLATFORM STYLE C					
N		PR		1		2		1		E

Roll-A-Reel. Consists of 2 separate roller assemblies in order to accommodate any width reel. Each unit is 9 1/2in. wide X 4in. high X 28in. long.

PLIERS

400408555					PLIERS CK02827					
1129445	1	EA								E

For use in extracting heat coils, BSP 074-247-127.

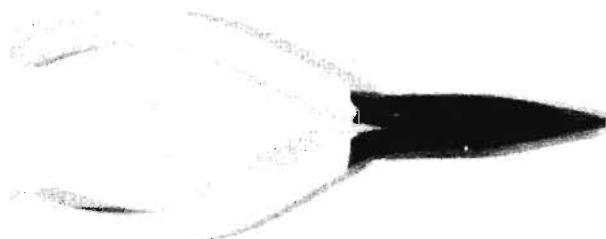

400408555

996706743					PLIERS CK07782					
1226928	1	EA		IL	IN	MI	OH	WI		E
				12	12	12	12	12		

For general use in adjusting key springs, BSP 074-247-127.

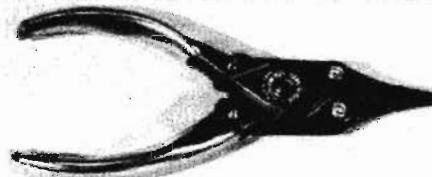

1226928

401229448					PLIERS CK21257 L1 LONG NOSE					
2795666	1	EA		IL	IN	MI	OH	WI		E
				12	12	12	12	12		

Yellow handle, for use in cutting, crushing, and stripping insulation wire, BSP 074-247-128.



2795666

401229455					PLIERS CK21257 L2					
N		EA		6			8		6	E

402048870					PLIERS CK21257 L3					
N		EA		6			8		6	E

400408563					PLIERS COMBINATION B 923-7C					
1102624	1	EA		IL	IN	MI	OH	WI		E
				12	12	12	12	12		

Jaws have both flat serrated & curved gripping surfaces used in replacing parts of friction roll drives, work on drop wire & motor vehicles, CA08420 - BSP 074-247-128.



1102624

PRODUCT IDENTIFIER DESCRIPTION

ITEM	ORD.	SELL	STD. PKG.	LEAD TIME	MIN.	A
NUMBER	MULT.	UNIT	STOCK AVAILABILITY / PA		ORD.	C

400320529 PLIERS CUT SIDE B 8IN CA07859
 N EA 6 4 36 E

400316683 PLIERS CUT SIDE B 9IN CA07859
 2743906 1 EA IL IN MI OH WI E
 12 12 12 12 12

High leverage type for cutting high strength wire, for heavy duty use in construction and maintenance work. Equipped with blue plastic cushion-grip handles, BSP 074-247-128.



2743906

400320412 PLIERS DIAGONAL B 5IN CA07858
 N EA 1 6 21 E

400320446 PLIERS DIAGONAL B 6IN CA07858
 N EA 6 4 48 E

400316659 PLIERS DIAGONAL BV NOTCH CA07858
 2752287 1 EA IL IN MI OH WI E
 12 12 12 12 12

W shaped notches in the jaw for slitting insulation and a V notch for crushing insulation on frame wire. Equipped with red rubber grips, BSP 074-247-129.



2752287

300076825 PLIERS DIAGONAL CUTTER D275-5
 6513200 1 EA IL IN MI OH WI E
 12 12 12 12 12

A five inch lightweight flush cutter. Shears wire up to 14AWG.

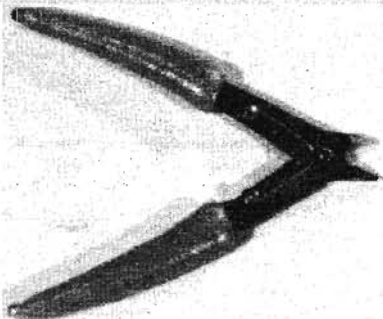

6513200

PRODUCT IDENTIFIER DESCRIPTION

ITEM	ORD.	SELL	STD. PKG.	LEAD TIME	MIN.	A
NUMBER	MULT.	UNIT	STOCK AVAILABILITY / PA		ORD.	C

402175509 PLIERS DIAGONAL D 6IN CA07858
 1179648 1 EA IL IN MI OH WI E
 12 12 12 12 12

Has a skinning hole in the jaws for removing insulation, and W shaped notches in the jaws for slitting insulation, BSP 074-247-128.

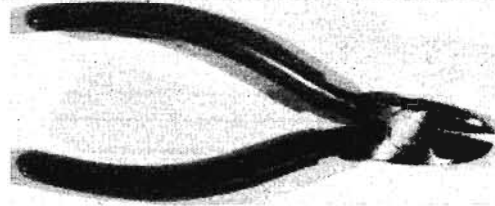

1179648

900144031 PLIERS GAS 10IN DIAMOND K 310
 N EA 6 3 6 E

280002213 PLIERS IV 620
 N EA 1 2 1 E
 Insulated tip pliers used for ESS CC units.

400316667 PLIERS LONG NOSE B CA07860
 1101972 1 EA IL IN MI OH WI E
 12 12 12 12 12

Provided with green plastic cushion-grip handle, for general use, 6 5/8in. long, BSP 074-247-128.

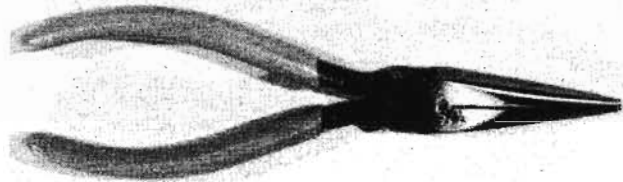

1101972

400290151 PLIERS PRESSING B CA08254
 N EA 6 4 54 E

For installing the B band clip used in splicing and terminating plastic sheathed cables.

400358891 PLIERS PRESSING C CA08517
 2130708 1 EA IL IN MI OH WI E
 12 12 12 12 12

A tool used for pressing 3M company UG connectors, BSP 081-852-125.

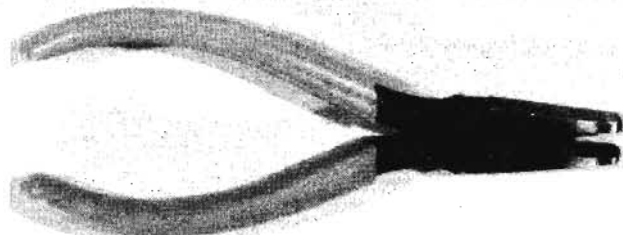

2130708

DISTRIBUTION SERVICES

NETWORK SERVICES

TOOLS

BUILDING JANITORIAL

AUTOMOTIVE

FORMS/OFFICE SUPPLIES

GENERAL

DATA VOICE

DISTRIBUTION SERVICES

PLIERS

PRODUCT IDENTIFIER DESCRIPTION

ITEM NUMBER	ORD. MULT.	SELL UNIT	STD. PKG. STOCK AVAILABILITY / PA	LEAD TIME	MIN. ORD.	A C
-------------	------------	-----------	-----------------------------------	-----------	-----------	-----

900221086 PLIERS PUMP CHANNEL LOCK
 6139600 1 EA IL IN MI OH WI E
 12 12 12 12 12
 Heavy duty, adjusting pliers used by Outside Plant technicians for tightening and loosening equipment.

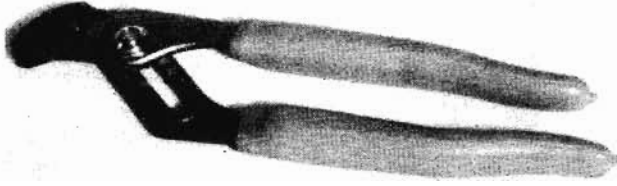

6139600

400358826 PLIERS SHORT NOSE B CA08479
 1316984 1 EA IL IN MI OH WI E
 12 12 12 12 12
 For general use in wiring. A six inch plier with a narrow jaw, BSP 074-247-128.

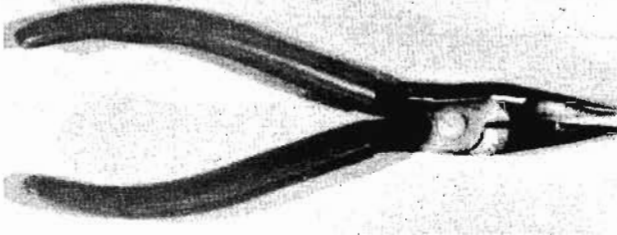

1316984

NETWORK SERVICES

TOOLS

BUILDING JANITORIAL

AUTOMOTIVE

FORMS/OFFICE SUPPLIES

GENERAL

DATA VOICE

PRODUCT IDENTIFIER DESCRIPTION

ITEM NUMBER	ORD. MULT.	SELL UNIT	STD. PKG. STOCK AVAILABILITY / PA	LEAD TIME	MIN. ORD.	A C
-------------	------------	-----------	-----------------------------------	-----------	-----------	-----

402503668 PLUG PJ 4 LOOPING
 1940395 1 EA IL IN MI OH WI E
 12 12 12 12 12
 Standard, 310 size, 3 conductor.

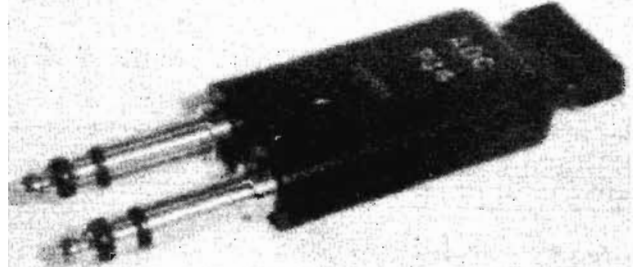

1940395

402258222 PLUG PJ744 TERMINATING
 N EA 1 4 13 E

402495345 PLUG PJ746 LOOPING
 1940411 1 EA IL IN MI OH WI E
 12 12 12 12 12
 Bantam, 3 Conductor.

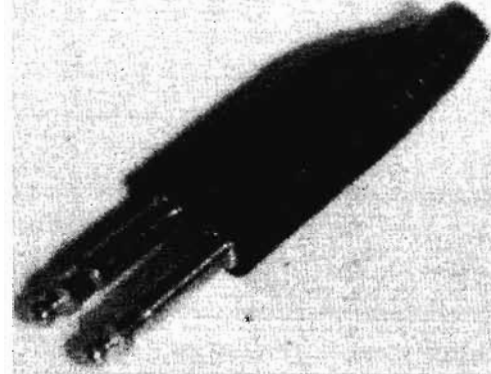

1940411

PLOTTER

260389184 PLOTTER INTERNAL TD-252
 N EA 1 1 E

PLUG

403128861 PLUG 3012 SLOT
 5327007 1 PR E

402156459 PLUG CONVERSION AP051
 1940387 1 EA IL IN MI OH WI E
 12 12 12 12 12
 Plug that converts a Bantam Jack to a 310 Jack.

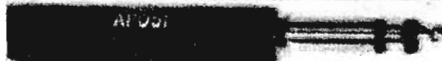

1940387

401766159 PLUG PJ748 DUMMY
 1940429 1 EA IL IN MI OH WI
 12 12 12 12
 DISCONTINUE, ORDER NON STOCK UPON STOCK DEPLETION

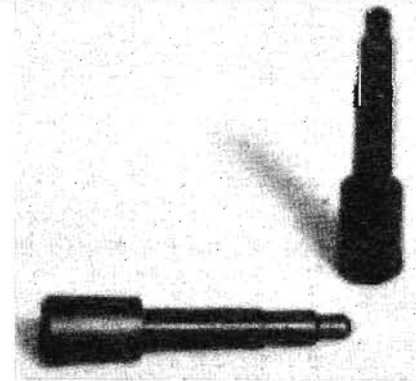

1940429

300062338 PLUG PJ750B DUMMY 3 CONDUCTOR
 N EA 10 4 120 E
 Bantam.

DISTRIBUTION SERVICES

NETWORK SERVICES

TOOLS

BUILDING JANITORIAL

AUTOMOTIVE

FORMS/OFFICE SUPPLIES

GENERAL

DATA VOICE

PRODUCT IDENTIFIER		DESCRIPTION								
ITEM NUMBER	ORD. MULT.	SELL UNIT	STD. PKG. STOCK AVAILABILITY / PA		LEAD TIME		MIN. ORD.	A C		
280323704		PLUG PJ800	TERMINATING 100OHM							
1944025	1	EA	IL	IN	MI	OH	WI	E		
			12	12	12	12	12			



1944025

PRODUCT IDENTIFIER		DESCRIPTION								
ITEM NUMBER	ORD. MULT.	SELL UNIT	STD. PKG. STOCK AVAILABILITY / PA		LEAD TIME		MIN. ORD.	A C		
400465720		POINT DRILL AUTO B	1/16IN							
1228700	1	PK	IL	IN	MI	OH	WI	E		
			12	12	12	12	12			
CAO7137, Package of 2.										
400410775		POINT DRILL AUTO B	3/32IN							
1228726	1	PK	IL	IN	MI	OH	WI	E		
			12	12	12	12	12			
CAO7137, Package of 2.										
400410783		POINT DRILL AUTO B	11/64IN							
1228742	1	PK	IL	IN	MI	OH	WI	E		
			12	12	12	12	12			
CAO7137, Package of 2.										

PRODUCT IDENTIFIER		DESCRIPTION								
400320594		POCKET CANVAS B	CA7196							
1228668	1	EA	For attachment to workman's body belt to facilitate carrying small items, such as clamps, bolts, screws, sleeves, etc.							E



400320594

PRODUCT IDENTIFIER		DESCRIPTION								
400320602		POINT TEST SPLICER B	CA07472							
1228825	1	EA	For identifying cable pairs at main frames or cable terminals, BSP 106-315-102.							E



400320602

PRODUCT IDENTIFIER		DESCRIPTION								
400777207		POINT DRILL 30	CA07137							
1228783	1	PK	Use with Drill Automatic B, BSP 080-115-101.							E
Package of 2.										



400777207

PRODUCT IDENTIFIER		DESCRIPTION								
400328738		POLE PIKE 14FT	CA06756							
1227744	1	EA	Pike poles for use in setting poles or as temporary braces for poles in pole line construction and maintenance, BSP 621-205-202.							E



400328738

PRODUCT IDENTIFIER		DESCRIPTION								
400465761		POINT DRILL 33	CA07137							
1228809	1	PK	IL	IN	MI	OH	WI	E		
			12	12	12	12	12			
Package of 2.										
900150012		POINT DRILL AUTO	5/32IN							
5149344	1	EA	IL	IN	MI	OH	WI	E		
			12	12	12	12	12			
Stanley 04-067. DISCONTINUE UPON STOCK DEPLETION										

PRODUCT IDENTIFIER		DESCRIPTION								
260398870		POLE PROD B	CA07661							
N		EA	1	2	1			E		
4000291829.										

DISTRIBUTION SERVICES

POUCH

PRODUCT IDENTIFIER		DESCRIPTION				
ITEM NUMBER	ORD. MULT.	SELL UNIT	STD. PKG. STOCK AVAILABILITY / PA	LEAD TIME	MIN. ORD.	A C

POUCH

300094703 POUCH 188A TESTER J388

1940262 1 EA

E



300094703

280080359 POUCH 200C LEATHER

1936567	1	EA	IL 12	IN 12	MI 12	OH 12	WI 12	E
---------	---	----	----------	----------	----------	----------	----------	---

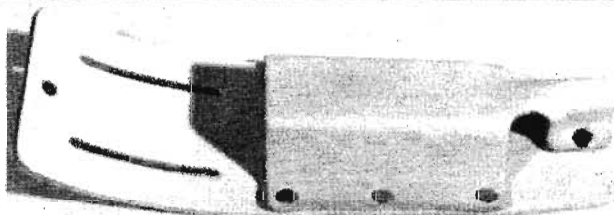

1936567

401689542 POUCH FLASHLIGHT 1443M

1179499	1	EA	IL 12	IN 12	MI 12	OH 12	WI 12	E
---------	---	----	----------	----------	----------	----------	----------	---

For use on tool belts to carry flashlights.

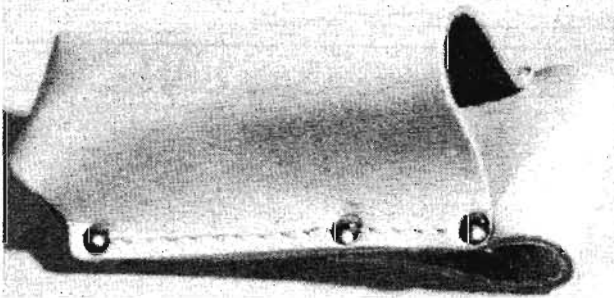

1179499

300080488 POUCH FLASHLIGHT J346

1333443	1	EA	IL 12	IN 12	MI 12	OH 12	WI 12	E
---------	---	----	----------	----------	----------	----------	----------	---

Used to hold flashlight to tool belt.



1333443

NETWORK SERVICES

TOOLS

BUILDING JANITORIAL

AUTOMOTIVE

FORMS/OFFICE SUPPLIES

GENERAL

DATA VOICE

PRODUCT IDENTIFIER		DESCRIPTION				
ITEM NUMBER	ORD. MULT.	SELL UNIT	STD. PKG. STOCK AVAILABILITY / PA	LEAD TIME	MIN. ORD.	A C

401359575 POUCH FLASHLIGHT WM-140

N		EA	1	4	24	E
---	--	----	---	---	----	---

Commercial.

300067907 POUCH GOGGLE 1080

6511915	1	EA	IL 12	IN 12	MI 12	OH 12	WI	E
---------	---	----	----------	----------	----------	----------	----	---

Norton. For safety goggles.

900302894 POUCH GOGGLE W/SNAP 8047

N		EA	1	4	10	E
---	--	----	---	---	----	---

Commercial.

001182385 POUCH LEATHER TOBACCO

5413088	1	EA	IL 12	IN 12	MI 12	OH 12	WI 12	E
---------	---	----	----------	----------	----------	----------	----------	---

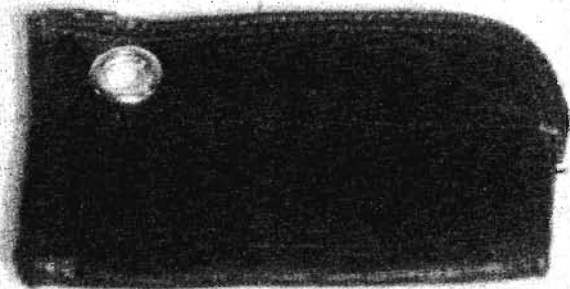

5413088

300080496 POUCH NAIL J359

1333435	1	EA	IL 12	IN	MI 12	OH	WI	E
---------	---	----	----------	----	----------	----	----	---

Used to hold small parts or tools, 4in X 5in X 1in.

280046038 POUCH PAN PPC25X50 EMPTY

N		EA	1	2	1	E
---	--	----	---	---	---	---

NOW AVAILABLE THROUGH TOUCH-TONE ORDER ENTRY.

260338579 POUCH TERMINAL HAND-HELD J-382

N		EA	1	3	1	E
---	--	----	---	---	---	---

401352802 POUCH TOOL 3 POCKET WITH BELT

N		EA	1	4	24	E
---	--	----	---	---	----	---

WM92A with side pocket.

PRODUCT IDENTIFIER DESCRIPTION

ITEM NUMBER	ORD. MULT.	SELL UNIT	STD. PKG. STOCK AVAILABILITY / PA	LEAD TIME	MIN. ORD.	A C
-------------	------------	-----------	-----------------------------------	-----------	-----------	-----

400496535 POUCH TOOL 5145 WITH BELT
 5130427 1 EA IL IN MI OH WI E
 12 12 12 12
 Tool pouch with belt 6in high X 4in wide X 1in deep with 3 pockets. Used to carry hand tools.

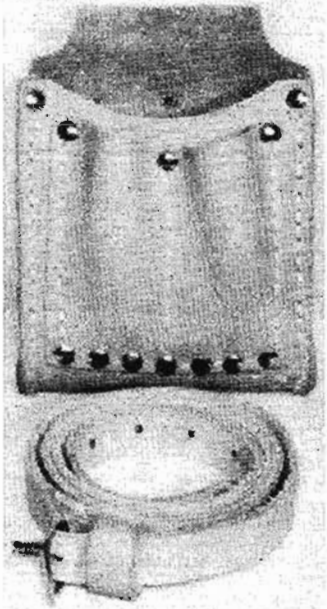

5130427

400738795 POUCH TOOL 5145 WITHOUT BELT
 N EA 1 4 12 E
 Tool pouch 6in high X 4in wide X 1in deep with 3 pockets. Used to carry hand tools.

401736020 POUCH TOOL D CA08475

ITEM NUMBER	ORD. MULT.	SELL UNIT	STD. PKG. STOCK AVAILABILITY / PA	LEAD TIME	MIN. ORD.	A C
-------------	------------	-----------	-----------------------------------	-----------	-----------	-----

2668640 1 EA IL IN MI OH WI E
 12 12 12 12
 A riveted leather pouch for use by repairman, installers, and PBX switchboard men, with four small pockets and one large pocket for carrying tools.

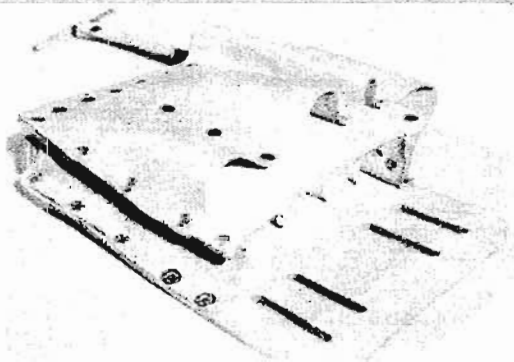

2668640

PRODUCT IDENTIFIER DESCRIPTION

ITEM NUMBER	ORD. MULT.	SELL UNIT	STD. PKG. STOCK AVAILABILITY / PA	LEAD TIME	MIN. ORD.	A C
-------------	------------	-----------	-----------------------------------	-----------	-----------	-----

400358909 POUCH TOOL E CA08513
 2798306 1 EA IL IN MI OH WI E
 12 12 12 12 12
 Combination tool pouch for carrying Knife Skinning R2761 (1446047) and the Scissors C (1184630).



2798306

300080520 POUCH TOOL J-340

ITEM NUMBER	ORD. MULT.	SELL UNIT	STD. PKG. STOCK AVAILABILITY / PA	LEAD TIME	MIN. ORD.	A C
-------------	------------	-----------	-----------------------------------	-----------	-----------	-----



1922260

280017567 POUCH TOOL KLEIN 42241
 N EA 1 2 1 E

300064169 POUCH TOOL S 4866A

ITEM NUMBER	ORD. MULT.	SELL UNIT	STD. PKG. STOCK AVAILABILITY / PA	LEAD TIME	MIN. ORD.	A C
-------------	------------	-----------	-----------------------------------	-----------	-----------	-----

8410852 1 EA IL IN MI OH WI E
 12 12 12 12 12
 Designed pouch for outside craft, flashlight holder, snap pocket for Set Test 139, small tool front pockets, screwdriver slots, slide loops, tape chain.

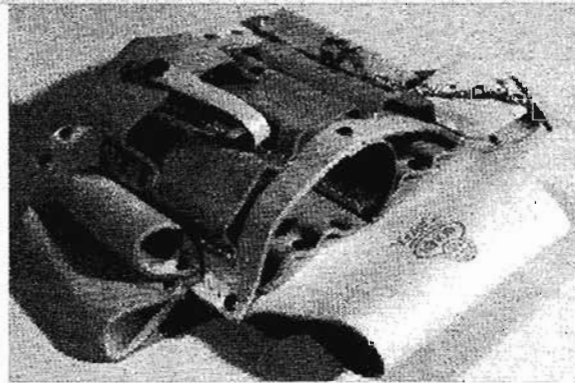

8410852

DISTRIBUTION SERVICES

NETWORK SERVICES

TOOLS

BUILDING JANITORIAL

AUTOMOTIVE

FORMS/OFFICE SUPPLIES

GENERAL

DATA VOICE

DISTRIBUTION SERVICES

NETWORK SERVICES

TOOLS

BUILDING JANITORIAL

AUTOMOTIVE

FORMS/OFFICE SUPPLIES

GENERAL

DATA VOICE

PRESSER

PRODUCT IDENTIFIER		DESCRIPTION				
ITEM NUMBER	ORD. MULT.	SELL UNIT	STD. PKG. STOCK AVAILABILITY / PA	LEAD TIME	MIN. ORD.	A C

PRODUCT IDENTIFIER		DESCRIPTION				
ITEM NUMBER	ORD. MULT.	SELL UNIT	STD. PKG. STOCK AVAILABILITY / PA	LEAD TIME	MIN. ORD.	A C

PRESSER

PROBE

400348181 PRESSER CONNECTOR D
1192237 1 EA E

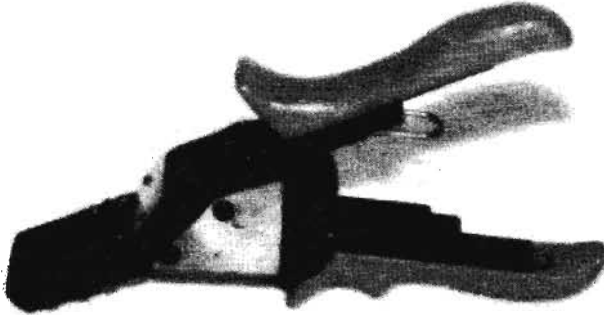

400348181

300097102 PRESSER HAND 4270
1922245 1 EA E
IL IN MI OH WI
12 12 12 12 12
Used for plugging preterminated and spliced module combinations together.

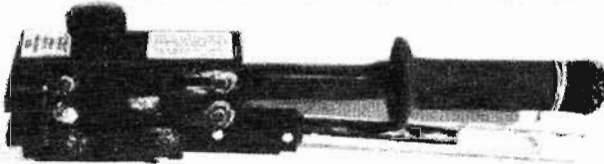

1922245

401403951 PRESSER SLEEVE G CA08737
1110460 1 EA E
IL IN MI OH WI
12 12 12 12 12
For pressing single-tube brass sleeves in splicing drop and block wire, BSP 081-750-106.



1110460

401403969 PRESSER SLEEVE H CA08737
1195677 1 EA E
IL IN MI OH WI
12 12 12 12 12
For pressing F & G sleeves when splicing D rural or C urban wire, BSP 624-220-200.

280079153 PROBE 4327 SELF STRIP
1940684 1 EA E
Single pair.

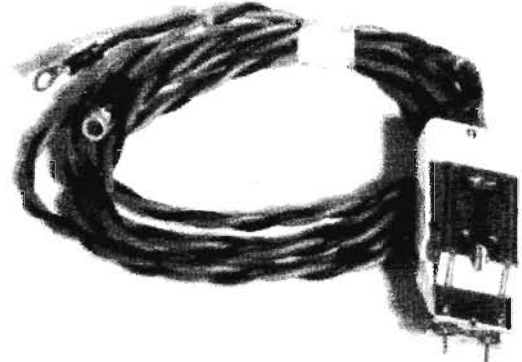

280079153

280056987 PROBE 4327A WITH DISH
N EA 1 3 1 E
Self strip single pair.

260395033 PROBE 7570 REMOTE ADAPTER 3/2
N EA 1 2 1 E

280025206 PROBE 10041A
N EA 1 2 1 E
A HP divider probe used with oscilloscopes for testing ESS equipment, 6 1/2in long.

280020868 PROBE DIGITAL LOGIC PRB-1
N EA 1 2 1 E
Shows high, low, bad level or open circuit logic and pulses.

280046046 PROBE DIGITAL LOGIC PRB-1
N EA 1 2 1 E
Shows high, low, bad level or open circuit logic and pulses.

260359740 PROBE DIRECT 3/8IN 3013
N EA 1 6 1 E

260359559 PROBE INDUCTIVE 3/8IN 3011
N EA 1 6 1 E

280025917 PROBE P6053A
N EA 1 2 1 E

280002338 PROBE P6056 010-6056-03
N EA 1 3 1 E
A standard accessory to the 485 Oscilloscope.

280011800 PROBE P6065 010-6065-02
N EA 1 3 1 E
A standard accessory to the 465 Oscilloscope.

300068954 PROBE SPUDGER PD 642-WCC
N EA 1 3 1 E

PRODUCT IDENTIFIER DESCRIPTION

ITEM	ORD.	SELL	STD. PKG.	LEAD TIME	MIN.	A
NUMBER	MULT.	UNIT	STOCK AVAILABILITY / PA	ORD.	ORD.	C

401154992 PROBE SPUDGER PP 640-W

1333633	1	EA	IL IN MI OH WI 12 12 12 12 12			E
---------	---	----	----------------------------------	--	--	---

A tool used in ESS offices and PBX to clean terminal punchings prior to making wiring changes.

1333633

401335781 PROBE SPUDGER PP 640-WY

N		EA	1	3	1	E
---	--	----	---	---	---	---

260323563 PROBE SUPER MATE 4048-DPM/CJ

N		EA	1	3	1	E
---	--	----	---	---	---	---

260324678 PROBE SUPER MINI 4048S 25-PAIR

N		EA	1	3	1	E
---	--	----	---	---	---	---

300097052 PROBE SUPER MINI TEST 4048SA-1

N		KT	1	3	1	E
---	--	----	---	---	---	---

400751483 PROBE TEST CA08629 L1

1127472	1	EA	IL IN MI OH WI 12 12 12 12 12			E
---------	---	----	----------------------------------	--	--	---

Used with a tone supply to pick an individual wire out of a group of wires, with out breaking the insulation. Equipped with a conical tip, BSP 105-241-100.

1127472

260323217 PROBE TEST QTBI17A

N		EA	1	2	1	E
---	--	----	---	---	---	---

280020546 PROBE VOLTAGE:10X 2M

N		EA	1	2	1	E
---	--	----	---	---	---	---

W/Accessories 010-6106-13.

280020538 PROBE VOLTAGE:10X 3M

N		EA	1	2	1	E
---	--	----	---	---	---	---

W/Accessories 010-6106-13.

PROTECTION EAR

300051018 PROTECTION EAR PLUG 28-11-20

5115782	1	EA				E
---------	---	----	--	--	--	---

Silent Partner without cord. DISCONTINUE AND FORWARD AS-1 W/O CORD UPON STOCK DEPLETION

300050556 PROTECTION EAR PLUG 28-11-26

5115774	1	EA	IL IN MI OH WI 12 12			E
---------	---	----	-------------------------	--	--	---

Silent Partner with cord. DISCONTINUE AND FORWARD TO PROTECTION EAR PLUG W/CORD UPON STOCK DEPLETION

300050481 PROTECTION EAR PLUG AS 1 W/O CORD

5115790	1	PR	IL IN MI OH WI 12 12 12 12 12			E
---------	---	----	----------------------------------	--	--	---

PRODUCT IDENTIFIER DESCRIPTION

ITEM	ORD.	SELL	STD. PKG.	LEAD TIME	MIN.	A
NUMBER	MULT.	UNIT	STOCK AVAILABILITY / PA	ORD.	ORD.	C

280056482 PROTECTION EAR PLUG AS130R

N		PR	1	3	1	E
---	--	----	---	---	---	---

Airsoft.

300071479 PROTECTION EAR PLUG CABOFLEX

5122853	1	EA	IL IN MI OH WI 12 12			E
---------	---	----	-------------------------	--	--	---

300050564 PROTECTION EAR PLUG DP-AS-1

1161836	1	BX	IL IN MI OH WI 12 12			E
---------	---	----	-------------------------	--	--	---

DISCONTINUE AND FORWARD TO AS-1 W/O CORD UPON STOCK DEPLETION

300040177 PROTECTION EAR PLUG W/CORD

5111468	1	BX	IL IN MI OH WI 12 12 12 12 12			E
---------	---	----	----------------------------------	--	--	---

300040185 PROTECTION EAR PLUG W/O CORD

5111476	1	BX	IL IN MI OH WI 12 12 12 12 12			E
---------	---	----	----------------------------------	--	--	---

900210972 SHIELD EAR 841000

1142455	1	EA	IL IN MI OH WI 12 12 12 12 12			E
---------	---	----	----------------------------------	--	--	---

A cup type shield to protect the wearer from damaging noise to the ear yet admits normal conversation, BSP 010-110-900.



1142455

PROTECTOR

260395066 PROTECTOR GROUND TESTER D7106

N		EA	1	2	1	E
---	--	----	---	---	---	---

DISTRIBUTION SERVICES

NETWORK SERVICES

TOOLS

BUILDING JANITORIAL

AUTOMOTIVE

FORMS/OFFICE SUPPLIES

GENERAL

DATA VOICE

DISTRIBUTION SERVICES

NETWORK SERVICES

TOOLS

BUILDING JANITORIAL

AUTOMOTIVE

FORMS/OFFICE SUPPLIES

GENERAL

DATA VOICE

PROTECTOR

PRODUCT IDENTIFIER		DESCRIPTION						
ITEM NUMBER	ORD. MULT.	SELL UNIT	STD. PKG.	LEAD TIME			MIN. ORD.	A
			STOCK AVAILABILITY / PA					C
260388608 PROTECTOR GROUND TESTER SK-D								
1964296	1	EA	IL 12	IN 12	MI	OH	WI 12	E



1964296

PRUNER

PRODUCT IDENTIFIER		DESCRIPTION						
ITEM NUMBER	ORD. MULT.	SELL UNIT	STD. PKG.	LEAD TIME			MIN. ORD.	A
			STOCK AVAILABILITY / PA					C
400408605 PRUNER TREE B CA07545								
4194548	1	EA						E
For clipping branches up to 1in. in diameter. Use with Handle Fiberglass BFG3 or BFG6, BSP 620-310-100.								

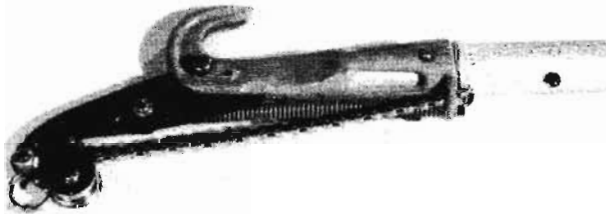

400408605

PULLER

PRODUCT IDENTIFIER		DESCRIPTION						
ITEM NUMBER	ORD. MULT.	SELL UNIT	STD. PKG.	LEAD TIME			MIN. ORD.	A
			STOCK AVAILABILITY / PA					C
260361423 PULLER FUSE MIDGET 34-001								
N		EA	1		2		1	E
260361431 PULLER FUSE POCKET 34-002								
N		EA	1		2		1	E
280021973 PULLER FUSE POCKET 34-003 IDEAL								
N		EA	1		2		1	E
For removing cartridge type fuses.								

PRODUCT IDENTIFIER		DESCRIPTION						
ITEM NUMBER	ORD. MULT.	SELL UNIT	STD. PKG.	LEAD TIME			MIN. ORD.	A
			STOCK AVAILABILITY / PA					C
400289351 PULLER SLACK F CA08245								
1187708	1	EA	IL 12	IN 12	MI 12	OH 12	WI 12	E

Used by construction to pull up messenger stack, BSP 081-020-115.



1187708

PRODUCT IDENTIFIER		DESCRIPTION						
ITEM NUMBER	ORD. MULT.	SELL UNIT	STD. PKG.	LEAD TIME			MIN. ORD.	A
			STOCK AVAILABILITY / PA					C
300013877 PULLER STRAND 1684-5 CA06849								
1147751	1	EA	IL 12	IN 12	MI 12	OH 12	WI 12	E
Designed for tensioning all standard size of strand, not to exceed 5000lbs, BSP 081-500-111.								



1147751

PRODUCT IDENTIFIER		DESCRIPTION						
ITEM NUMBER	ORD. MULT.	SELL UNIT	STD. PKG.	LEAD TIME			MIN. ORD.	A
			STOCK AVAILABILITY / PA					C
260447487 PULLER STRAND L CAO 8533								
N								
400320768 PULLER WIRE DROP CA7357X								
N		EA	1		4		1	E
Used to tension drop wire and self supporting video, BSP 462-405-205.								

PRODUCT IDENTIFIER		DESCRIPTION						
ITEM NUMBER	ORD. MULT.	SELL UNIT	STD. PKG.	LEAD TIME			MIN. ORD.	A
			STOCK AVAILABILITY / PA					C
400636924 PULLER WIRE LOOP R2257								
1218818	1	EA	IL 12	IN 12	MI 12	OH 12	WI 12	E
Wire loop puller for use in sewing cable or pulling wire thru terminal block fanning strips, BSP 074-247-137.								



1218818

PRODUCT IDENTIFIER DESCRIPTION

ITEM NUMBER	ORD. MULT.	SELL UNIT	STD. PKG. STOCK AVAILABILITY / PA	LEAD TIME	MIN. ORD.	A C
-------------	------------	-----------	-----------------------------------	-----------	-----------	-----

PUNCH

401429162			PUNCH CENTER 264B - 26413			
N		EA	1	2	1	E
L.S. Starrett.						

P-NUMBERED PARTS

802203661			P220366 MIRROR DENTAL			
1222265	1	EA				E
A magnifying mirror with insulated metal parts, BSP 074-238-125. P220366.						



802203661

802403519			P240351 CONTACT BURNISHER ASSEMBLY			
1222323	1	EA	IL IN MI OH WI			E
12 12 12 12						

RAINWEAR

002041028			JACKET RAIN LARGE 9040J			
1164699	1	EA				E
For use in inclement weather by outside technicians.						

002041002			JACKET RAIN MEDIUM 9040J			
1130393	1	EA	IL IN MI OH WI			E
12 12 12 12 12						

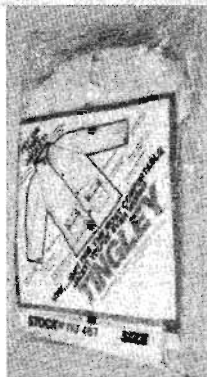

1130393

002041010			JACKET RAIN SMALL 9040J			
1192534	1	EA	IL IN MI OH WI			E
12 12 12 12 12						

002041036			JACKET RAIN XLARGE 9040J			
1149278	1	EA	IL IN MI OH WI			E
12 12 12 12 12						

260339049			JACKET RAIN XXLARGE 9040J			
1970046	1	EA	IL IN MI OH WI			E
12 12 12 12 12						

260339064			JACKET RAIN XXLARGE TALL			
1977819	1	EA	IL IN MI OH WI			E
12 12 12 12 12						

PRODUCT IDENTIFIER DESCRIPTION

ITEM NUMBER	ORD. MULT.	SELL UNIT	STD. PKG. STOCK AVAILABILITY / PA	LEAD TIME	MIN. ORD.	A C
-------------	------------	-----------	-----------------------------------	-----------	-----------	-----

260446307			JACKET RAIN XXXLARGE TALL			
N		EA	1	5	1	

260446315			JACKET RAIN XXXXLARGE TALL			
N		EA	1	5	1	

002040962			PANTS RAIN LARGE 9040P			
1164269	1	EA	IL IN MI OH WI			E
12 12 12 12 12						
For use in inclement weather by outside technicians.						

002040970			PANTS RAIN MEDIUM 9040P			
1189100	1	EA	IL IN MI OH WI			E
12 12 12 12 12						

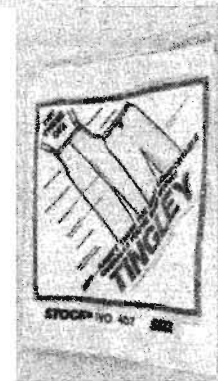

1189100

002040988			PANTS RAIN SMALL 9040P			
1171710	1	EA	IL IN MI OH WI			E
12 12 12 12 12						

002040954			PANTS RAIN XLARGE 9040P			
1176255	1	EA	IL IN MI OH WI			E
12 12 12 12 12						

260339056			PANTS RAIN XXLARGE 9040P			
1970038	1	EA	IL IN MI OH WI			E
12 12 12 12 12						

260339072			PANTS RAIN XXLARGE TALL			
1977827	1	EA	IL IN MI OH WI			E
12 12 12 12 12						

260446323			PANTS RAIN XXXLARGE TALL			
N		EA	1	5	1	

260446331			PANTS RAIN XXXXLARGE TALL			
N		EA	1	5	1	

300071404			RAINSUIT 3-PIECE VINYL YELLOW XXXLG			
6512996	1	BX	IL IN MI OH WI			E
12 12 12 12 12						
TO BE DISCONTINUED UPON DEPLETION OF STOCK.						

DISTRIBUTION SERVICES

NETWORK SERVICES

TOOLS

BUILDING JANITORIAL

AUTOMOTIVE

FORMS/OFFICE SUPPLIES

GENERAL

DATA VOICE

DISTRIBUTION SERVICES

RAKE

PRODUCT IDENTIFIER		DESCRIPTION				
ITEM NUMBER	ORD. MULT.	SELL UNIT	STD. PKG. STOCK AVAILABILITY / PA	LEAD TIME	MIN. ORD.	A C

RAKE

900355397 RAKE CONSTRUCTION 14IN 18 817

1200311	1	EA				E
---------	---	----	--	--	--	---

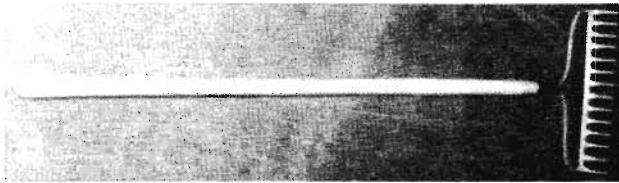

900355397

RATCHET

280011677 RATCHET CHAPMAN MIDGET CM-13

N		EA	1	2	12	E
---	--	----	---	---	----	---

Used by coin collectors to enter housings when collecting.

260439922 RATCHET HAND 3/8IN #813

N		EA	1	2	1	
---	--	----	---	---	---	--

400291092 RATCHET REVERSE D 3/8IN CA08381

1230128	1	EA		IL	IN	MI	OH	WI	E
				12	12	12	12	12	

Replacement 3/8in drive reversing ratchet for Kit Wrench D (1196402).



1230128

RECEIVER

100400761 RECEIVER MT723A

1161539	1	EA							
---------	---	----	--	--	--	--	--	--	--

AUDIOSEARS 2325 receiver, consists of a #12A receiver holder and a HC3 receiver unit. Will accommodate cords with #130 cord tips. Used with #15 headband. BSP 501-220-100

REEL

401667811 REEL FISH TAPE PULLER 31-007

N		EA	1	2	10	E
---	--	----	---	---	----	---

Replaced by Wire Fish B 1/8in.

260321815 REEL PAYOUT STAND

N		EA	1	4	1	E
---	--	----	---	---	---	---

NETWORK SERVICES

TOOLS

BUILDING JANITORIAL

AUTOMOTIVE

FORMS/OFFICE SUPPLIES

GENERAL

DATA VOICE

PRODUCT IDENTIFIER		DESCRIPTION				
ITEM NUMBER	ORD. MULT.	SELL UNIT	STD. PKG. STOCK AVAILABILITY / PA	LEAD TIME	MIN. ORD.	A C

400218160 REEL WIRE CK08047 L2

8216606	1	EA		IL	IN	MI	OH	WI	E
				12	12	12	12	12	

Used in central offices for holding and dispensing frame wire, BSP 074-253-114.

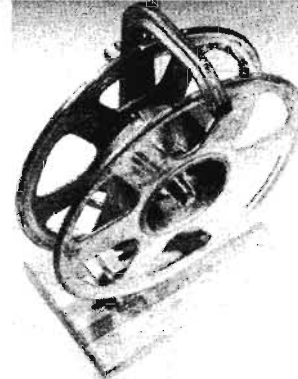

8216606

401977335 REEL WIRE CK21955 L1

1129502	1	RL		IL	IN	MI	OH	WI	E
				12	12	12	12	12	

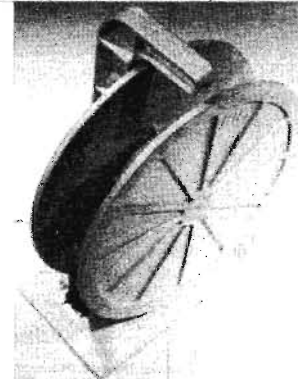

1129502

400218186 REEL WIRE DROP C CA07598

1162735	1	EA		IL	IN	MI	OH	WI	E
				12	12	12	12	12	

Reel to hold drop wire while placing e/w handle and stand, BSP 625-400-205, BSP 462-030-100.

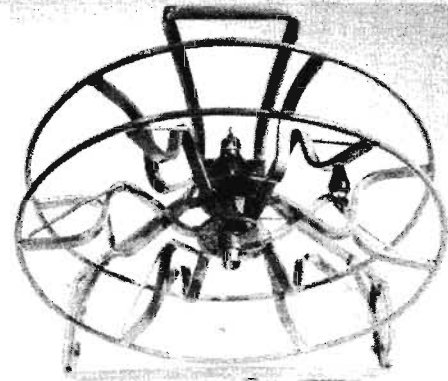

1162735

DISTRIBUTION SERVICES

NETWORK SERVICES

TOOLS

BUILDING JANITORIAL

AUTOMOTIVE

FORMS/OFFICE SUPPLIES

GENERAL

DATA VOICE

PRODUCT IDENTIFIER		DESCRIPTION				
ITEM NUMBER	ORD. MULT.	SELL UNIT	STD. PKG. STOCK AVAILABILITY / PA	LEAD TIME	MIN. ORD.	A C

REFLECTOR

400218277 REFLECTOR LAMP HEAT CA07541

1161141 1 EA E
Used to provide heat and illumination in cable splicing operation during cold weather, BSP 081-340-112.

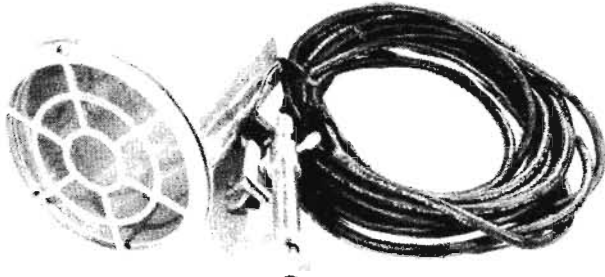

400218277

REGULATOR

400218376 REGULATOR C GAS CA07553 0-180 PSI

1153114 1 EA E
For control of compressed gas in the operation of pneumatic tools. E/w high and low pressure gauges cylinder connection hose connection outlet, pressure limiting device, and adjustment screw.

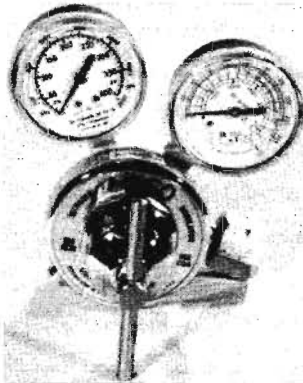

400218376

400218350 REGULATOR FURNACE PROPANE D

1130237 1 EA E
IL IN MI OH WI
12 12 12 12 12
Used to regulate gas to propane heater, CA06299 - BSP 081-330-115.

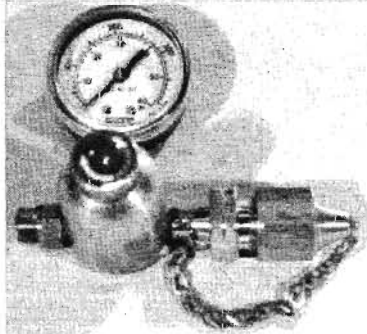

1130237

PRODUCT IDENTIFIER		DESCRIPTION				
ITEM NUMBER	ORD. MULT.	SELL UNIT	STD. PKG. STOCK AVAILABILITY / PA	LEAD TIME	MIN. ORD.	A C

400218301 REGULATOR HEATER PROPANE B

1231720 1 EA E
IL IN MI OH WI
12 12 12 12 12
CA07874.

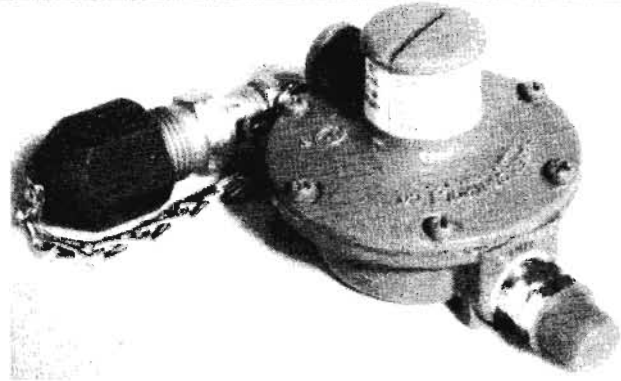

1231720

260438288 REGULATOR PROPANE AD1561

N EA 1 6 1

401360961 REGULATOR R MC CA07932

1186627 1 EA E
IL IN MI OH WI
12 12 12 12 12
A small acetylene regulator for an MC type gas tank, BSP 081-330-105.



1186627

RELEASER

401403977 RELEASER CK21107 L1

N EA 1 3 1 E
A combination tool e/w 3 bits. Used for removing number-card covers, dial finger wheels and trimline cord plugs, BSP 074-253-118, BSP 075-192-301.



401403977

REPELLANT

260421862 REPELLANT DOG SHIELD SPRAY

N EA 1 4 1 E
North NRT 1138-85.

DISTRIBUTION SERVICES

REPELLANT

PRODUCT IDENTIFIER		DESCRIPTION					
ITEM NUMBER	ORD. MULT.	SELL UNIT	STD. PKG. STOCK AVAILABILITY / PA	LEAD TIME	MIN. ORD.	A C	
300049707		REPELLANT INSECT LIQUID 2OZ BOTTLE					
N		CS	1	1	1	E	
12 bottles per case.							

NETWORK SERVICES

PRODUCT IDENTIFIER		DESCRIPTION						
ITEM NUMBER	ORD. MULT.	SELL UNIT	STD. PKG. STOCK AVAILABILITY / PA	LEAD TIME	MIN. ORD.	A C		
260329313		REPELLANT INSECT TECDEET 2A						
1946129	1	EA	IL 12	IN 12	MI 12	OH 12	WI 12	E
2oz bottle for spraying of Insects.								
260347737		REPELLANT TICK PERMANONE						
1951103	1	EA	IL 12	IN 12	MI 12	OH 12	WI 12	E

TOOLS

RESPIRATOR						
401135447		RESPIRATOR 8710				
1221754	1	BX				E
Box of 20. A disposable mask for use as protection against fibrosis producing dust.						

BUILDING JANITORIAL

RETAINER						
280099045		RETAINER CHISEL 2053				
N		EA	6	2	6	E
260439831		RETAINER #802				
N		EA	1	2	1	E
Air impact tool parts.						

AUTOMOTIVE

RIG SPLICING COMPONENTS						
260321534		ASSEMBLY 78-8006-2467-4				
N		EA	1	3	1	E
Support Tube Extension for Rig Splicing 4020M/4021M/4022M, 3M Universal.						

FORMS/OFFICE SUPPLIES

280060328		ASSEMBLY 78-8011-2559-8				
N		EA	1	3	1	E
Wire Retainer for Splicing 22-26 Guage wire.						
280060302		ASSEMBLY 78-8020-7777-2				
N		EA	1	3	1	E
Pad Sub 4045.						

GENERAL

280060344		ASSEMBLY 78-8020-7958-8				
N		EA	1	3	1	E
Vise Handle & Pad for Rig Splicing 4045K Universal.						

280060310		ASSEMBLY CLAMP 78-8004-0836-7				
N		EA	1	3	1	E
Traverse.						

280060294		ASSEMBLY CLAMP 78-8004-0837-5				
N		EA	1	3	1	E
Hand knob.						

DATA VOICE

260321542		ASSEMBLY CLAMP 78-8004-0844-1				
N		EA	1	3	1	E
Spare part for 3M 4020M/4021M/4022M rigs.						

PRODUCT IDENTIFIER		DESCRIPTION					
ITEM NUMBER	ORD. MULT.	SELL UNIT	STD. PKG. STOCK AVAILABILITY / PA	LEAD TIME	MIN. ORD.	A C	

280060286		ASSEMBLY CLAMP 78-8044-9584-0				
N		EA	1	3	1	E
Adjustable traverse clamp.						

300097045		ASSEMBLY HEAD SPLICING 4045				
N		EA	1	2	1	E
3M Universal.						

300071685		ASSEMBLY HEAD SUPPORT 4025				
N		EA	1	2	1	E

300097037		ASSEMBLY SUPPORT TUBE 4042				
N		EA	1	2	1	E

260318100		ASSEMBLY UNIVERSAL HEAD CLAMP 4045				
N		EA	1	3	1	E
78-8006-2482-3.						

260318118		ASSEMBLY VISE FINAL 4045				
N		EA	1	3	1	E
78-8006-2472-4. NOW AVAILABLE THROUGH TOUCH-TONE ORDER ENTRY.						

280060336		BAR LONG TRAVERSE 78-8004-0841-7				
N		EA	1	3	1	E

260321005		BRACE VARIABLE TRAVERSE				
N		EA	1	3	1	E
Spare part for Rig Splicing 4045-K Universal (PID300071768), 3M P/N78-8011-2041-7.						

300071727		CLAMP STRAND 4035A				
N		EA	1	2	1	E
Used to hold Head Splicing 4041P in aerial splicing applications.						

300071735		HEAD SPLICING 4041				
N		EA	1	2	1	E

300071750		HEAD SPLICING 4041P W/T BAR				
N		EA	1	2	1	E

260339171		HOLDER REAR SPRING				
N		EA	1	3	1	E
For 3M modular splice conversions on 4041, 78-8061-8795-7.						

280060377		KIT WIRE GUIDE 78-8054-9695-3				
N		EA	1	3	1	E
For splicing rigs.						

280060385		KIT WIRE SEPARATOR 78-8011-2560-6				
N		EA	1	2	1	E
For splicing rigs.						

260320338		PEDESTAL 78-8011-2047-4 BALL				
N		EA	1	3	1	E
Spare part for 4025/4025K Rig.						

260339213		PEDESTAL 78-8011-2557-2				
N		EA	1	3	1	E
Spare part for 3M 4020M, 4021M and 4022M Rigs.						

DISTRIBUTION SERVICES

NETWORK SERVICES

TOOLS

BUILDING JANITORIAL

AUTOMOTIVE

FORMS/OFFICE SUPPLIES

GENERAL

DATA VOICE

PRODUCT IDENTIFIER		DESCRIPTION				
ITEM NUMBER	ORD. MULT.	SELL UNIT	STD. PKG. STOCK AVAILABILITY / PA	LEAD TIME	MIN. ORD.	A C
260321559 PLATE HEAD TAPE 78-8011-2558-0						
N		EA	1	3	1	E
Spare part for 3M 4020M, 4021M, and 4022M Rigs.						
280060393 RETAINER WIRE SPRING SPLICING						
N		EA	1	3	1	E
20-24, 26-28 Gauge for splicing Rigs 78-8011-2508-5.						
280060401 SCREW ASSORTED 78-8012-9498-0						
N		BG	1	3	1	E
Bag of screws for splicing rigs.						
280060427 TUBE UNIVERSAL SUPPORT 4045						
N		EA	1	3	1	E
78-8006-2485-6.						
260323613 VISE SUPPORT 78-8011-2043-3						
N		EA	1	3	1	E
Spare part for 3M 4025 and 4025K rig.						

RING

300094679 RING 1013 J-363						
1922161	1	EA				E



300094679

RING KEY

300080504 RING KEY J361 1IN						
N		EA	1	3	1	E
009910944 RING KEY W/BELT HOOK ASSEMBLY						
N		EA	1	3	1	E

ROBO TOOLS

280014226 ROBOCHARGE 4220						
N		EA	1	1	1	E
Used to charge Robodrill battery pack.						
280024662 ROBOCORD 9001 25FT						
N		EA	1	1	1	E
Extension cord used with Robodrill.						
280002353 ROBODRILL 1001						
N		EA	1	1	1	E
Used for drilling operations when a commercial electrical source isn't available.						
280002361 ROBOPAK 3200						
N		EA	1	1	1	E
A 24 volt rechargeable battery pack, for Robodrill.						

PRODUCT IDENTIFIER		DESCRIPTION				
ITEM NUMBER	ORD. MULT.	SELL UNIT	STD. PKG. STOCK AVAILABILITY / PA	LEAD TIME	MIN. ORD.	A C
ROD						
260357595 ROD GROUND 8006						
N		EA	1	9	1	E
All locations.						
ROLLPIN						
997073739 ROLLPIN SPRING 51-012-062-0312						
N		EA	1	13	1	E
ROPE						
400320966 ROPE PLATFORM AERIAL GUY D-E						
1238105	1	EA				E
Rope used to guy aerial platform, E/W snap, BSP 081-300-011.						

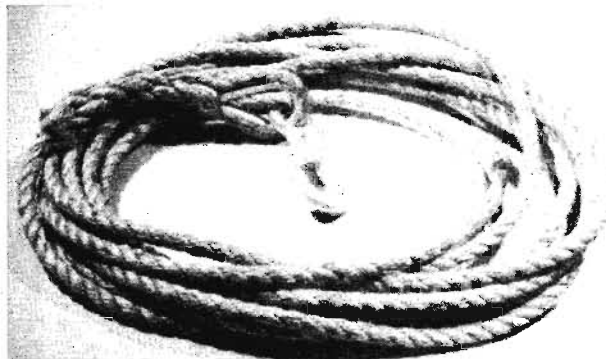

400320966

400261301 ROPE PLATFORM AERIAL SUPPORT								
1161356	1	EA	IL	JN	MI	OH	WI	E
6 1/2ft, CA07955.								

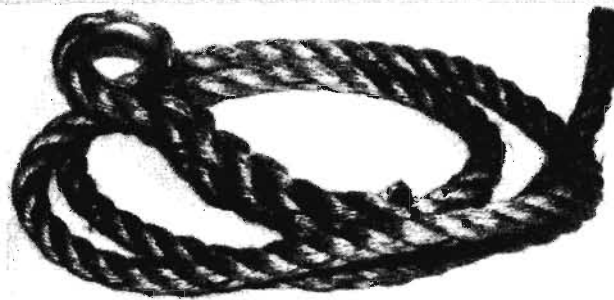

1161356

DISTRIBUTION SERVICES

NETWORK SERVICES

TOOLS

BUILDING JANITORIAL

AUTOMOTIVE

FORMS/OFFICE SUPPLIES

GENERAL

DATA VOICE

ROPE

PRODUCT IDENTIFIER		DESCRIPTION					
ITEM NUMBER	ORD. MULT.	SELL UNIT	STD. PKG.	LEAD TIME	MIN. ORD.	A	C

401432331 ROPE POLY 3/8IN FOR 28FT LADDER
 1220285 1 EA IL IN MI OH WI E
 12 12 12 12 12

A complete rope replacement for the 28ft extension ladder, BSP 081-740-105.

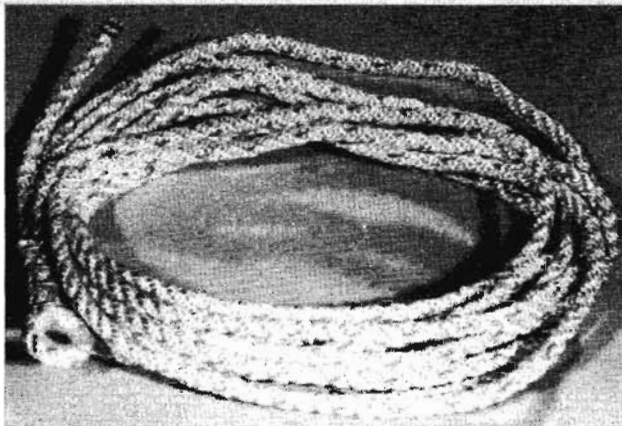

1220285

280038506 ROPE WIRE TELE-ROPAC 7/16 X 1500FT
 N SL 1 2 1 E
 Pulling line E/W 1 Factory Flemish Eye on inside of wooden reel.

ROPE MANILA

400261236 ROPE MANILA 1/2IN CA06582
 1238162 25 FT E
 A 3 strand manila rope for general use. Standard length 1200ft, BSP 081-510-011.

400261210 ROPE MANILA 1/4IN CA06582
 1238121 25 FT IL IN MI OH WI E
 12 12 12 12 12
 Standard length 1200ft.

400261251 ROPE MANILA 3/4IN CA06582
 1238204 25 FT IL IN MI OH WI E
 12 12 12 12 12
 Standard length 600ft.

400261228 ROPE MANILA 3/8IN CA06582
 1238147 50 FT IL IN MI OH WI E
 12 12 12 12 12
 Standard length 1200ft.

400261244 ROPE MANILA 5/8IN CA06582
 1238188 25 FT IL IN MI OH WI E
 12 12 12 12 12
 Standard length 600ft.

PRODUCT IDENTIFIER		DESCRIPTION					
ITEM NUMBER	ORD. MULT.	SELL UNIT	STD. PKG.	LEAD TIME	MIN. ORD.	A	C

ROPE PLASTIC

401077680 ROPE PLASTIC B 1/2IN CA08316
 1100172 1 FT E
 Standard length 1200ft. This plastic rope performs satisfactorily for handlines, aerial pulling lines, blocks and slings and for rodding underground ducts. Safe working load 1200lbs, BSP 081-511-101.

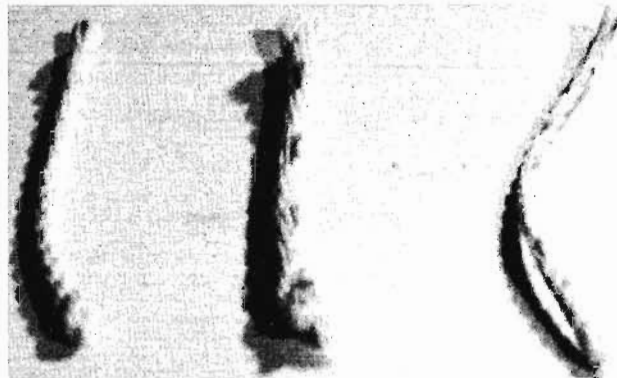

401077680

401077656 ROPE PLASTIC B 1/4IN CA08316
 2741942 50 FT IL IN MI OH WI E
 12 12 12 12 12
 Standard length 2400ft. Safe working load 350lbs.

280080565 ROPE PLASTIC B 1/4IN X 5000FT
 N FT 5000 2 5000 E
 CA08316. Safe working load 350lbs. NOW AVAILABLE THROUGH TOUCH-TONE ORDER ENTRY.

400497517 ROPE PLASTIC B 3/8IN CA08316
 2295667 1 FT IL IN MI OH WI E
 12 12 12 12 12
 Standard length 1200ft. Safe working load 750 lbs.

401077698 ROPE PLASTIC B 5/8IN X 600FT
 N FT 600 2 600 E
 CA08316.

ROTOR

400289203 ROTOR CK16062 L2
 1238246 1 PK E
 Package of 20. A rotary tool made of nylon pile fabric discs used with a handle CK16298 to clean SxS banks, BSP 074-223-108.



400289203

DISTRIBUTION SERVICES

NETWORK SERVICES

TOOLS

BUILDING JANITORIAL

AUTOMOTIVE

FORMS/OFFICE SUPPLIES

GENERAL

DATA VOICE

PRODUCT IDENTIFIER		DESCRIPTION				
ITEM NUMBER	ORD. MULT.	SELL UNIT	STD. PKG. STOCK AVAILABILITY / PA	LEAD TIME	MIN. ORD.	A C

RULE

400321006 RULE CLEARANCE B CA08394
 7445460 1 EA E
 For measuring above ground clearances. Consists of telescoping fiberglass tubing, graduated in feet and inches, extends to 25 feet.

400321006

996714127 RULE WOOD FOLDING 6FT CA06911
 1238261 1 EA E
 IL IN MI OH WI
 12 12 12 12 12
 Has brass plated steel joints, finished in yellow. Used for making miscellaneous measurements.



1238261

SAW

400261665 SAW CABLE CA07363
 1137109 1 EA E
 For cutting cable and lead sleeving. Blade is 12in long X 2in high and has teeth on top and bottom. Use with Guard Saw Cable CA07347X (1103135).



400261665

400555686 SAW HACK B CA08551
 2763326 1 EA E
 IL IN MI OH WI
 12 12 12 12 12
 Adjustable saw which takes 8in, 10in or 12in blades. Good for cutting wood and other hard materials.



2763326

400261699 SAW HACK KEYHOLE 32T CA07276
 1181511 1 EA E
 IL IN MI OH WI
 12 12 12 12 12
 Primarily for the use of installers and repairmen, 10in long.

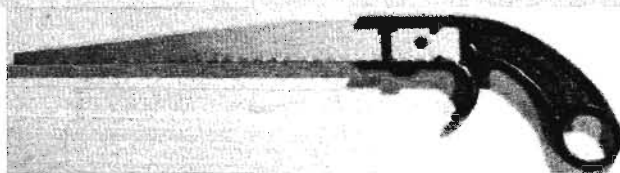

1181511

PRODUCT IDENTIFIER		DESCRIPTION				
ITEM NUMBER	ORD. MULT.	SELL UNIT	STD. PKG. STOCK AVAILABILITY / PA	LEAD TIME	MIN. ORD.	A C

400261707 SAW HAND 20IN CA07363
 5379586 1 EA E
 IL IN MI OH WI
 12 12 12 12
 Use with Guard Saw Hand 20in. (400408084).



5379586

400261715 SAW HAND 26IN CA07363
 1193581 1 EA E
 IL IN MI OH WI
 12 12 12 12 12
 Use with Guard Saw Hand 26in. (1149781).

900457789 SAW HOLE 2 1/4IN A36
 1136721 1 EA E
 IL IN MI OH WI
 12 12 12 12 12

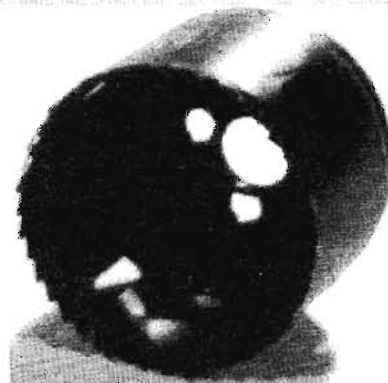

1136721

280027749 SAW PRUNING ADAPTER W/GUARD
 1922419 1 EA E
 IL IN MI OH WI
 12 12 12 12 12
 Leather scabbard PS-2F.



1922419

900222282 SAW PRUNING TR3 14 26IN
 4224626 1 EA E
 IL IN MI OH WI
 12 12 12 12 12
 Nickleson 80299.



4224626

DISTRIBUTION SERVICES

SCABBARD

PRODUCT IDENTIFIER		DESCRIPTION					
ITEM NUMBER	ORD. MULT.	SELL UNIT	STD. PKG. STOCK AVAILABILITY / PA	LEAD TIME	MIN. ORD.	A C	

SCABBARD

400751533 SCABBARD CA08629 L4

2768366 1 EA E
A leather sheath for carrying Probe Test CA08629 L1 (1127472), BSP 105-241-100.

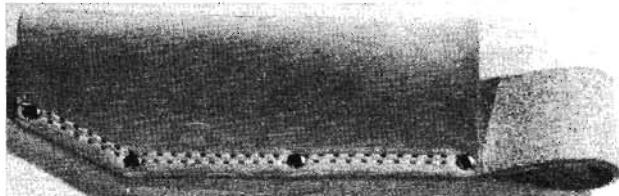

400751533

NETWORK SERVICES

TOOLS

SCISSORS

280029349 SCISSORS SPLICERS

1922799 1 EA E
For cutting cable conductor and stripping insulation, cutting edge 2 1/8in long, 5in total length, BSP 074-256-110.

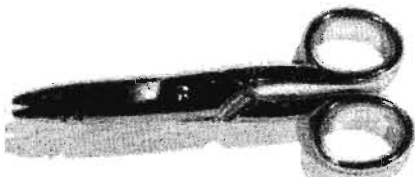

280029349

401730791 SCISSORS SPLICERS C 5IN CA07987

1184630 1 EA E
IL IN MI OH WI
12 12 12 12 12

SCRAPER GLASS

001034503 SCRAPER GLASS CRB-2

N EA 12 2 24 E

SCREWDRIVER

401166392 SCREWDRIVER 64-842

1100206 1 EA E
A dual light handle screwdriver. 3 1/8in long, with 1/16in X 1/4in tip, BSP 074-760-101.



401166392

280002494 SCREWDRIVER 68-402

N EA 1 1 1 E

280013103 SCREWDRIVER 602-3 AC 008606

N EA 6 2 6 E

DATA VOICE

PRODUCT IDENTIFIER		DESCRIPTION					
ITEM NUMBER	ORD. MULT.	SELL UNIT	STD. PKG. STOCK AVAILABILITY / PA	LEAD TIME	MIN. ORD.	A C	

996724621 SCREWDRIVER 6854

1240424 1 EA E
IL IN MI OH WI
12 12 12 12 12
Cabinet type with 3 1/2in blade, BSP 074-760-101, BSP 074-256-117.



1240424

400264677 SCREWDRIVER B SIZE 1 CA07739

1240226 1 EA E
IL IN MI OH WI
12 12 12 12 12
For philips head screws No. 4 and smaller, BSP 074-256-117, BSP 074-760-101, BSP 075-145-301.



1240226

400264685 SCREWDRIVER B SIZE 2 CA07739

1240267 1 EA E
IL IN MI OH WI
12 12 12 12 12
For philips head screws No. 5-9, BSP 074-256-117.

400264693 SCREWDRIVER B SIZE 3 CA07739

1240242 1 EA E
IL IN MI OH WI
12 12 12 12 12
For philips head screws No. 10-16.

996728481 SCREWDRIVER C3 3IN CA07825

1240127 1 EA E
IL IN MI OH WI
12 12 12 12 12
For screws No. 4-6, BSP 074-760-101, BSP 075-145-301.

400264719 SCREWDRIVER C6 6IN CA07825

1240143 1 EA E
IL IN MI OH WI
12 12 12 12 12
For screws No. 5-8, BSP 074-256-117.

400264727 SCREWDRIVER D 3IN CA07825

1240200 1 EA E
IL IN MI OH WI
12 12 12 12 12
For screws No. 5-10, BSP 075-160-301, BSP 074-256-117.

996728473 SCREWDRIVER E4 4IN CA07825

1240168 1 EA E
IL IN MI OH WI
12 12 12 12 12
For screws No. 5-12.



1240168

DISTRIBUTION SERVICES

NETWORK SERVICES

TOOLS

BUILDING JANITORIAL

AUTOMOTIVE

FORMS/OFFICE SUPPLIES

GENERAL

DATA VOICE

PRODUCT IDENTIFIER DESCRIPTION

ITEM NUMBER	ORD. MULT.	SELL UNIT	STD. PKG. STOCK AVAILABILITY / PA	LEAD TIME	MIN. ORD.	A C
-------------	------------	-----------	-----------------------------------	-----------	-----------	-----

400264743 SCREWDRIVER E5 5IN CA07825
 1240184 1 EA IL IN MI OH WI 12 12 12 12 12 E
 For screws No. 14-18, BSP 074-256-117.

400291142 SCREWDRIVER HEX 3/16IN CA08381
 N EA 1 2 1 E

400494720 SCREWDRIVER JEWELER 7/8 555D
 1328880 1 EA IL IN MI OH WI 12 12 12 12 12 E
 Blade is .080in wide X 3/4in long, has an overall length of 3 3/4in and is for general use, BSP 074-256-117.

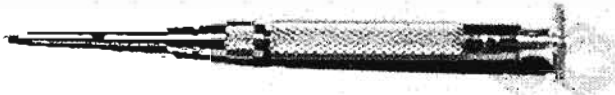

1328880

280021064 SCREWDRIVER OPTICAL US SAFE
 N EA 1 2 1 E
 Slot 2 1930.

280027376 SCREWDRIVER QUICK WEDGE 1734
 N EA 10 2 10 E
 A small 4in. blade screwdriver with capabilities to hold, start, drive and set a screw and/or for removing U-type relay mounting screws. BSP 074-256-120.



280027376

996726162 SCREWDRIVER QUICK WEDGE 1736
 1240440 1 EA IL IN MI OH WI 12 12 12 12 12 E
 A medium 6in. blade screwdriver with capabilities to hold, start, drive and set a screw and/or for removing U-type relay mounting screws. BSP 074-256-120.

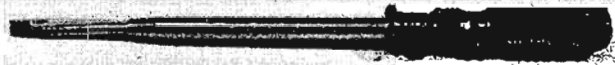

1240440

280027384 SCREWDRIVER QUICK WEDGE 1834
 N EA 10 2 10 E
 A medium 4in. blade screwdriver with capabilities to hold, start, drive and set a screw and/or for removing U-type relay mounting screws. BSP 074-256-120.



280027384

996726006 SCREWDRIVER QUICK WEDGE 2356
 N EA 10 2 10 E
 A heavy-duty 6in. blade screwdriver with capabilities to hold, start, drive and set a screw and/or for removing U-type relay mounting screws. BSP 074-256-120.



996726006

PRODUCT IDENTIFIER DESCRIPTION

ITEM NUMBER	ORD. MULT.	SELL UNIT	STD. PKG. STOCK AVAILABILITY / PA	LEAD TIME	MIN. ORD.	A C
-------------	------------	-----------	-----------------------------------	-----------	-----------	-----

280011685 SCREWDRIVER R3322
 N EA 1 2 20 E

990716531 SCREWDRIVER S3812
 1216416 1 EA IL IN MI OH WI 12 12 12 12 12 E
 3/8in X 12in.

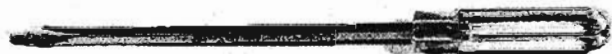

1216416

SEAT LADDER

400291753 SEAT LADDER B CA08002
 1193177 1 EA E
 Hooks to extension ladder white working on aerial cable.

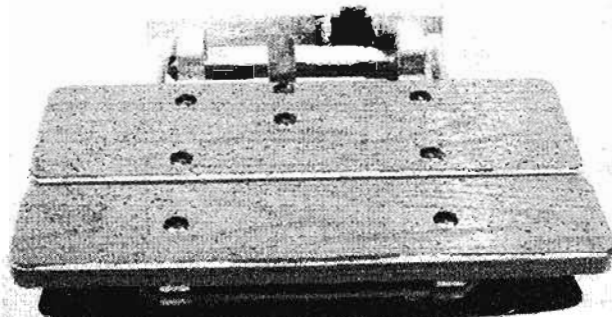

400291753

400264966 SEAT SPLICER B CA07186
 1162024 1 EA IL IN MI OH WI 12 12 12 12 12 E
 12IN X 15IN X 18IN. A green painted box for use by splicers as a combination seat and tool box while working on cables.

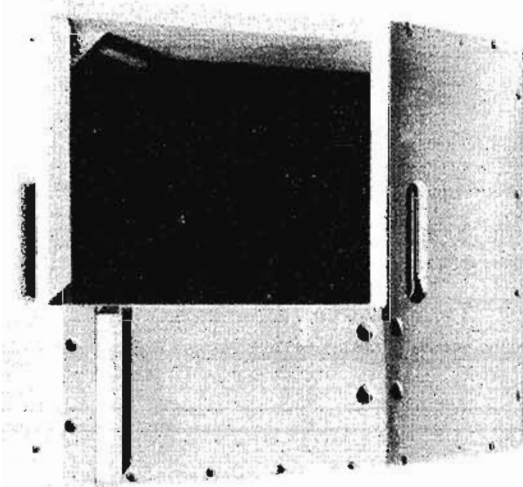

1162024

DISTRIBUTION SERVICES

SET

PRODUCT IDENTIFIER		DESCRIPTION					
ITEM NUMBER	ORD. MULT.	SELL UNIT	STD. PKG. STOCK AVAILABILITY / PA	LEAD TIME	MIN. ORD.	A	C

SET

280027939 SET ANGLE IRON 4058

N		SE	1	3	1	E	
---	--	----	---	---	---	---	--

400265310 SET DRILL TWIST B CA07790

1242305	1	EA	IL 12	IN 12	MI 12	OH 12	WI 12	E
---------	---	----	-------	-------	-------	-------	-------	---

Consists of a canvas roll, 8 1/2in X 9in having twelve pockets and two each high speed drill bits sizes 36, 30, 25, 16, 7 and H for general use in drilling through metal.

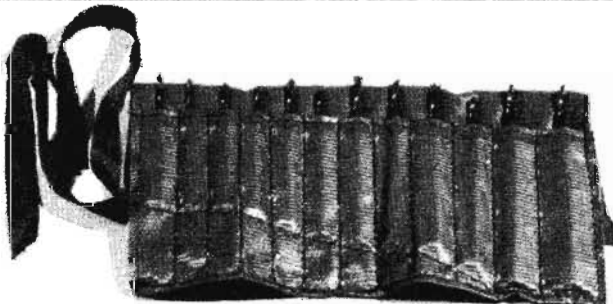

1242305

280002486 SET RATCHET CHAPMAN AL90B331

N		EA	1	2	1	E	
---	--	----	---	---	---	---	--

This is a 27 piece Standard/Metric socket & ratchet set.

280038548 SET TAP AND DIE 146B180

N		EA	1	2	1	E	
---	--	----	---	---	---	---	--

260421854 SET WRENCH ALLEN - 9 PC FOLDING

N		EA	1	2	1	E	
---	--	----	---	---	---	---	--

Set includes 1/16IN, 1/8IN, 3/16IN, 3/32IN, 5/32IN, 5/64IN & Hex Key 050 Allen wrenches.

280011719 SET WRENCH HEX KEY 91S

N		EA	1	2	1	E	
---	--	----	---	---	---	---	--

Set of 9 hex keys .050 - 3/16in, for use in Central Office maintenance.

SET HAND

102539418 SET HAND 1014B

N		EA	1	2	1	E	
---	--	----	---	---	---	---	--

002029379 SET HAND MT 1011

N		EA	1	4	1	E	
---	--	----	---	---	---	---	--

260436407 SET HAND MT 911

N							
---	--	--	--	--	--	--	--

TOOLS

BUILDING JANITORIAL

AUTOMOTIVE

FORMS/OFFICE SUPPLIES

GENERAL

DATA VOICE

PRODUCT IDENTIFIER DESCRIPTION

ITEM NUMBER	ORD. MULT.	SELL UNIT	STD. PKG. STOCK AVAILABILITY / PA	LEAD TIME	MIN. ORD.	A	C
-------------	------------	-----------	-----------------------------------	-----------	-----------	---	---

280071754 SET HAND TEST QSE5E-51

N		EA	1	3	1	E	
---	--	----	---	---	---	---	--

Rotary dial test set used by Outside Plant forces.

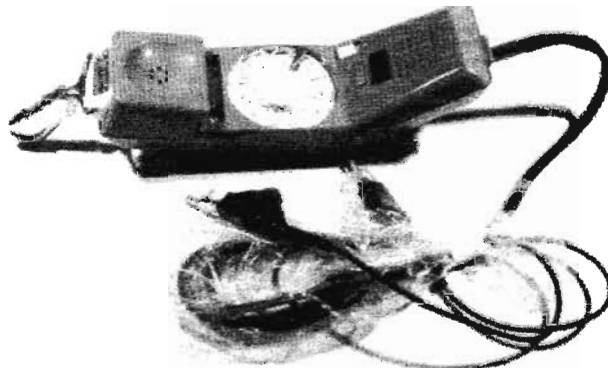

280071754

SET TEST

300087160 SET GENERATOR TEST 140MC/B

1334375	1	EA				E	
---------	---	----	--	--	--	---	--

For variable tone continuity testing, e/w modular jack test lead and two alligator clip leads. Used with Case Carry for Generator Test Set (1334383).

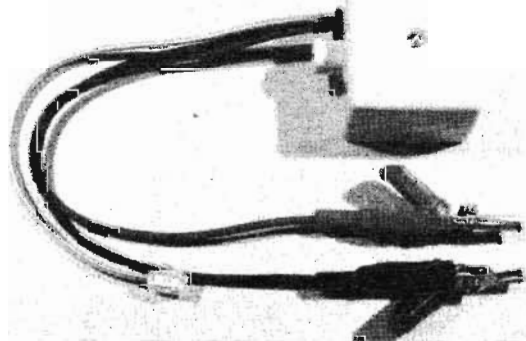

300087160

103082699 SET TEST 188A

1163956	1	EA	IL 12	IN 12	MI 12	OH 12	WI 12	E
---------	---	----	-------	-------	-------	-------	-------	---

A voltage probe used to detect voltages from 50 to 10,000 volts on metal or damp wood surfaces. Used with Cap Conductor Probe 188A (1443002) and Bag Storage C (1101014), BSP 081-705-102.



1163956

PRODUCT IDENTIFIER		DESCRIPTION					
ITEM	ORD.	SELL	STD. PKG.	LEAD TIME		MIN.	A
NUMBER	MULT.	UNIT	STOCK AVAILABILITY / PA		ORD.	C	

103551719 SET TEST 193A
 5290486 1 EA IL IN MI OH WI E
 12 12 12 12 12
 Used to test the threshold voltage of the 188A test set, BSP 081-705-104.



5290486

100718980 SET TEST MT91A
 1221341 1 EA IL IN MI OH WI C
 13 13 13 13
 Consists of 147B amplifier, 732A receiver, 513A tool, cords & plugs. To identify wire in toll & exchange cables w/o making metal contact with wire. Use Case Carry CK14132L2 (2243347), BSP 106-300-100.



1221341

260406962 SET TEST 122 FIBERFONE
 N EA 1 6 1
 Complete with 1 FC//SC and 1 FC/ST jumper.

260406970 SET TEST 125 FIBERFONE KIT COMPLETE
 N EA 1 6 1
 With 1 FC/SC and 1 FC/ST jumper.

260336565 SET TEST A90-000030B
 N EA 1 4 1 E

280094426 SET TEST BREAKDOWN 14103 L5B
 N EA 1 2 1

260436290 SET TEST BREAKDOWN CK14103 L5A
 N EA 1 2 1

260420294 SET TEST CALLER ID DISPLAY UNIT
 N EA 1 3 1
 SL30-17.

280038555 SET TEST CIRCUIT MOD T-136BSBZW
 N EA 1 4 1 E
 Portable, compact combination level and noise measuring set. Used by installers and repairmen to measure loop current, circuit loss, circuit noise, and power influence (noise to ground).

PRODUCT IDENTIFIER		DESCRIPTION					
ITEM	ORD.	SELL	STD. PKG.	LEAD TIME		MIN.	A
NUMBER	MULT.	UNIT	STOCK AVAILABILITY / PA		ORD.	C	

997742069 SET TEST CK08455 L1
 1199505 1 EA IL IN MI OH WI E
 12 12 12 12 12
 Consists of volt-ohm meter and test cords w/o battery. To detect & locate faults in the distribution plant. Use with Case Carry CK08456 L3 (1165050) AND Battery 45.0 KS14369 (1108183) BSP 106-020-100.



1199505

997861091 SET TEST CK08455 L2
 3247049 1 EA IL IN MI OH WI E
 12 12 12 12 12
 Used in detecting high resistance faults in the distribution plant and for making insulation resistance measurements and testing in community dial offices, BSP 106-020-100.



3247049

402632590 SET TEST CK20100 L5
 N EA 1 6 1 E

260389283 SET TEST DROP AND INSERT 124
 N EA 1 2 1 E

280043720 SET TEST LEAD 818A
 N EA 1 17 1 E

DISTRIBUTION SERVICES
 NETWORK SERVICES
 TOOLS
 BUILDING JANITORIAL
 AUTOMOTIVE
 FORMS/OFFICE SUPPLIES
 GENERAL
 DATA VOICE

DISTRIBUTION SERVICES

SET TEST

PRODUCT IDENTIFIER DESCRIPTION

ITEM NUMBER	ORD. MULT.	SELL UNIT	STD. PKG. STOCK AVAILABILITY / PA	LEAD TIME	MIN. ORD.	A C
-------------	------------	-----------	-----------------------------------	-----------	-----------	-----

300043239 SET TEST MT 101B

1333328	1	EA	IL 12	IN 12	MI 12	OH 12	WI 12	E
---------	---	----	-------	-------	-------	-------	-------	---

Used in locating low-resistance faults in non-loaded cable and is used with the 147A amplifier, BSP 106-340-115.

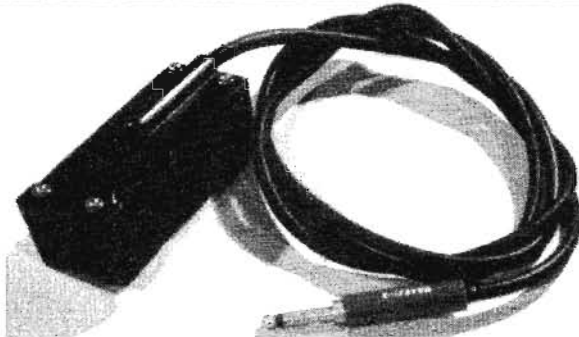

1333328

NETWORK SERVICES

TOOLS

000260133 SET TEST MT 105D

1333534	1	EA	IL 12	IN 12	MI 12	OH 12	WI 12	E
---------	---	----	-------	-------	-------	-------	-------	---

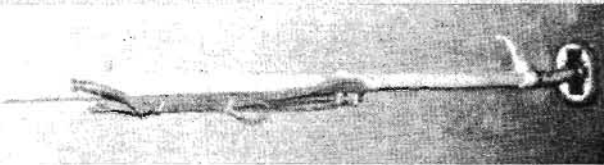

1333534

BUILDING JANITORIAL

AUTOMOTIVE

260320429 SET TEST PL 276

N	EA	1			2			1	E
---	----	---	--	--	---	--	--	---	---

280071184 SET TEST PL 300

N	EA	1			2			1	E
---	----	---	--	--	---	--	--	---	---

260369145 SET TEST PULSE/TONE HAND HELD CO BUTT

1955773	1	EA	IL 12	IN 12	MI 12	OH 12	WI 12	E
---------	---	----	-------	-------	-------	-------	-------	---

7900TB Butt-In II. Utilized by technicians to isolate trouble and make calls into Test & Control Units. Ameritech Logo w/346A plug.



1955773

FORMS/OFFICE SUPPLIES

GENERAL

DATA VOICE

PRODUCT IDENTIFIER DESCRIPTION

ITEM NUMBER	ORD. MULT.	SELL UNIT	STD. PKG. STOCK AVAILABILITY / PA	LEAD TIME	MIN. ORD.	A C
-------------	------------	-----------	-----------------------------------	-----------	-----------	-----

260370093 SET TEST PULSE/TONE HAND HELD CO BUTT W/

1959726	1	EA	IL 12	IN 12	MI 12	OH 12	WI 12	E
---------	---	----	-------	-------	-------	-------	-------	---

SPEAKER - TS22 Test Set with 346A plug, speaker, 9 number auto dialer and internal ringer. Used by a technician to isolate trouble and make calls into Test & Control Units. Ameritech Logo.

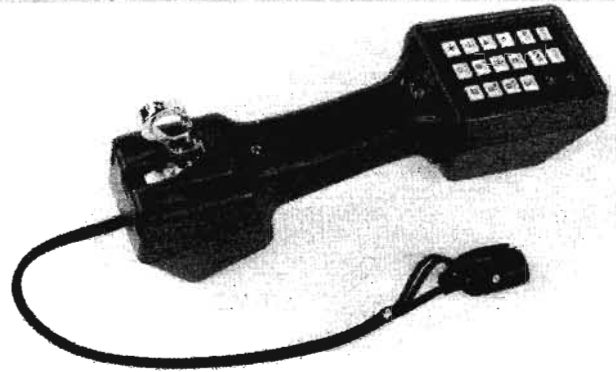

1959726

260370085 SET TEST PULSE/TONE HAND HELD OSP

1959718	1	EA	IL 12	IN 12	MI 12	OH 12	WI 12	E
---------	---	----	-------	-------	-------	-------	-------	---

BUTT W/SPEAKER - TS22 Test Set with 6A clip, speaker, 9 number auto dialer and internal ringer. Utilized by technicians to isolate trouble and make calls into Test & Control Units. Ameritech Logo.



1959718

PRODUCT IDENTIFIER DESCRIPTION

ITEM NUMBER	ORD. MULT.	SELL UNIT	STD. PKG. STOCK AVAILABILITY / PA	LEAD TIME	MIN. ORD.	A C
-------------	------------	-----------	-----------------------------------	-----------	-----------	-----

260369137 SET TEST PULSE/TONE HAND HELD OSP
 1955765 1 EA IL IN MI OH WI E
 12 12 12 12 12
 BUTT - 7900TA Butt-In II. Utilized by technicians to isolate trouble and make calls into Test & Control Units. Replaces Set Test TS21 21800-X89. Ameritech Logo w/6A clip.



1955765

- 260389358 SET TEST REFERENCE LEVEL T105B**
N EA 1 1 E
- 280022377 SET TEST T 279K CIRCUIT TERM**
N EA 1 4 1 E
Must specify mount, SIDE or TOP HINGE, ETC..
- 260389366 SET TEST T 3DS3 TRANSMISSION 275B**
N EA 1 1 E
- 260368683 SET TEST TBR 7900**
N EA 1 2 1 E
Ameritech Logo w/346A PLUG.
- 260370101 SET TEST TS21800-601**
N EA 1 3 1
- 260370119 SET TEST TS21800-684**
N EA 1 3 1
- 260412085 SET TEST UPGRADE RTS C9925A TO C9925B**
N EA 1 6 1 C
- 260389382 SET TEST WIDEBAND ANALOG TRANS AM5XT**
N
E/W Battery charger (24-0017), case (87-0070), cords (2 each of 48-0047, 48-0048, 48-0062).

SHANK

- 260395298 SHANK ADAPTER 907046**
N EA 1 2 1 E
- 280025875 SHANK POWER HEX A 3011A**
N EA 1 1 1 E
Used with Wrench Impact C and Socket Deep Double Square.
- 900208869 SHANK ROUND 510R 5/8X6**
N EA 6 3 18 E

PRODUCT IDENTIFIER DESCRIPTION

ITEM NUMBER	ORD. MULT.	SELL UNIT	STD. PKG. STOCK AVAILABILITY / PA	LEAD TIME	MIN. ORD.	A C
-------------	------------	-----------	-----------------------------------	-----------	-----------	-----

SHARPENER

260438320 SHARPENER KNIFE AND SCISSORS
N

SHEARS

400265831 SHEARS PRUNING B
1177659 1 EA E
Has 2in cutting capacity for small tree branches and underbrush, BSP 620-310-100.

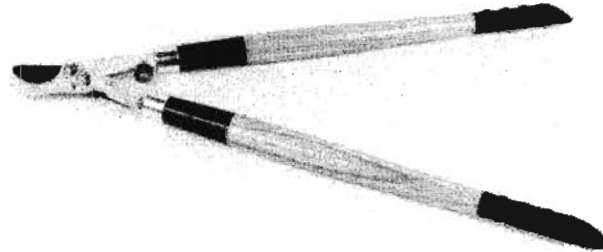

400265831

400265849 SHEARS TABBING B CA08184
1259481 1 EA IL IN MI OH WI E
12 12 12 12 12
Used for cutting tabs in the ends of polyethylene cable sheath to permit placement of the inner sheath clamps of large mechanical splice cases, BSP 633-400-200.

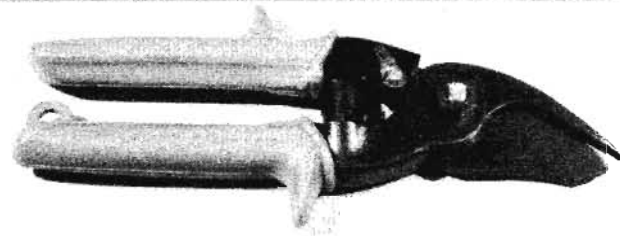

1259481

280011867 SHEARS W/SHEATH 2173
N EA 1 3 1 E
For clean cutting of groups of wire or trimming soft metals such as copper, lead or mild steel. Spring loaded to open automatically w/mechanical stop. Vinyl coated handles-serrated cutting edge.

DISTRIBUTION SERVICES

NETWORK SERVICES

TOOLS

BUILDING JANITORIAL

AUTOMOTIVE

FORMS/OFFICE SUPPLIES

GENERAL

DATA VOICE

DISTRIBUTION SERVICES

SHOE BENDING

PRODUCT IDENTIFIER		DESCRIPTION				
ITEM NUMBER	ORD. MULT.	SELL UNIT	STD. PKG. STOCK AVAILABILITY / PA	LEAD TIME	MIN. ORD.	A C

SHELTER AERIAL

SEE TENT.

NETWORK SERVICES

SHOE BENDING

400897393 SHOE BENDING CABLE B CA08657

2643106 1 EA E
Used to provide a smooth curved support at duct entrances in manholes when setting up cables. See Strap Cable Bender (1102848), BSP 632-305-015, BSP 081-410-150.



400897393

TOOLS

SHOE TEST

280029976 SHOE TEST TERMAX

1922922 1 EA E

BUILDING JANITORIAL

SHOVEL

300084787 SHOVEL ROUND POINT-D HANDLE 27IN

5126557 1 EA E
To remove earth from manholes & trenches and for pole inspection work, 69-227 RP14D.



300084787

AUTOMOTIVE

FORMS/OFFICE SUPPLIES

300084795 SHOVEL ROUND POINT-STRAIGHT HANDLE 48IN

1223867 1 EA E
IL IN MI OH WI
12 12 12 12 12

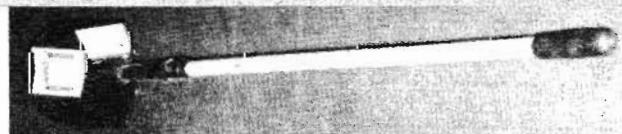

1223867

GENERAL

300084852 SHOVEL SPADE DRAIN-HANDLE 27IN

5126599 1 EA E
IL IN MI OH WI
12 12 12 12 12
Blade 16in.



5126599

DATA VOICE

PRODUCT IDENTIFIER		DESCRIPTION				
ITEM NUMBER	ORD. MULT.	SELL UNIT	STD. PKG. STOCK AVAILABILITY / PA	LEAD TIME	MIN. ORD.	A C

300086402 SHOVEL SPADE DRAIN-HANDLE 48IN

5126672 1 EA E
IL IN MI OH WI
12 12 12 12 12
Blade 16in. Straight handle, 69-277 SS16L.

400266474 SHOVEL SQUARE POINT-D HANDLE 36IN

1138636 1 EA E
IL IN MI OH WI
12 12 12 12 12
CA07330. For mixing and shoveling concrete.



1138636

300084803 SHOVEL SQUARE POINT-STRAIGHT HANDLE

5126573 1 EA E
IL IN MI OH WI
12 12 12 12 12
48IN.



5126573

400266490 SHOVEL STRAIGHT 8FT CA07330

1143776 1 EA E
IL IN MI OH WI
12 12 12 12 12
Used for digging pole and anchor holes.



1143776

400269684 SPOON DIGGING WEST 8FT CA07332

1264606 1 EA E
IL IN MI OH WI
12 12 12 12 12
For removing earth from anchor and pole holes.

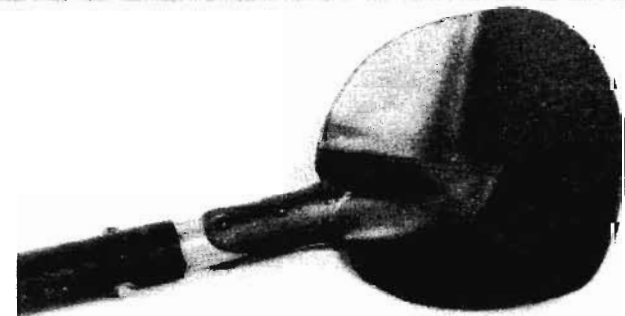

1264606

PRODUCT IDENTIFIER DESCRIPTION

ITEM NUMBER	ORD. MULT.	SELL UNIT	STD. PKG. STOCK AVAILABILITY / PA	LEAD TIME	MIN. ORD.	A C
-------------	------------	-----------	-----------------------------------	-----------	-----------	-----

SIGNS & ACCESSORIES - FLEX MAST

Used to protect employees, property and the general public. Accessories to accommodate all traffic patterns and road conditions.

280017039 BAG STORAGE MS19

1921734	1	EA				
DISCONTINUE, ORDER NON STOCK UPON STOCK DEPLETION						

260303169 FLAG FOR FLEX MAST SIGNS

N		EA	1	1	1	E
---	--	----	---	---	---	---

280017096 SIGN REFLECTIVE 36IN

1921742	1	EA	IL 12	IN 12	MI 12	OH 12	WI 12	E
A roll-up sign, ROAD WORK AHEAD, for use with Stand Mini W/Spring & Flag Yoke MS-1000.								

260303128 SIGN REFLECTIVE 36IN

N		EA	1	1	1	E
UTILITY WORK AHEAD.						

260303144 SIGN REFLECTIVE 36IN

N		EA	1	2	1	E
RIGHT LANE CLOSED AHEAD/left lane overlay.						

260303110 SIGN REFLECTIVE 48IN

N		EA	1	3	1	E
UTILITY WORK AHEAD.						

260303136 SIGN REFLECTIVE 48IN

N		EA	1	1	1	E
Right Lane Closed Ahead w/Left Lane Overlay.						

401684808 SIGN STAND H360

N		EA	1	4	1	E
A portable folding stand designed to display the 36in x 36in, MEN WORKING panels, at work locations and to provide a storage place for the panels when not in use.						

280017013 STAND MINI MS1000

1921726	1	EA	IL 12	IN 12	MI 12	OH 12	WI 12	E
For fabric word sign.								

260303151 STAND MINI W/SPRING & FLAG YOKE

N		EA	1	1	1	E
Sign Stand Mini MS-1000 - Signup.						

SIGNS & ACCESSORIES - WINDMASTER

Used to protect employees, property and the general public. Accessories to accommodate all traffic patterns and road conditions.

300097326 ADAPTER FLASHER P-2062

N		EA	1	2	1	E
---	--	----	---	---	---	---

300097334 ADAPTER FLASHER SA-02611

N		EA	1	2	1	E
---	--	----	---	---	---	---

300097318 BRACKET RIDGED SIGN SA-01729

N		EA	1	2	1	E
---	--	----	---	---	---	---

PRODUCT IDENTIFIER DESCRIPTION

ITEM NUMBER	ORD. MULT.	SELL UNIT	STD. PKG. STOCK AVAILABILITY / PA	LEAD TIME	MIN. ORD.	A C
-------------	------------	-----------	-----------------------------------	-----------	-----------	-----

300097359 CROSSBRACE CONVENTIONAL SIGN 36IN

N		EA	1	2	1	E
SA-0363D.						

300097367 CROSSBRACE CONVENTIONAL SIGN 48IN

N		EA	1	2	1	E
SA-03631.						

260430921 CROSSBRACE FOR 36IN SIGN DURALATCH

N		EA	1	4	1	E
2 flags, DLX03626.						

260430939 CROSSBRACE FOR 36IN SIGN VELCRO

N		EA	1	4	1	E
2 flags, SA03626.						

260430947 CROSSBRACE FOR 48IN SIGN DURALATCH

N		EA	1	4	1	E
2 flags, DLX03628.						

260430905 CROSSBRACE FOR 48IN SIGN VELCRO

N		EA	1	4	1	E
2 flags, SA03628.						

300097300 OVERLAY-LEFT/CENTER LANE P-03930

N		EA	1	2	1	E
---	--	----	---	---	---	---

280011743 SIGN HOLDER WINDMASTER 4812

N		EA	1	2	1	E
For roll-up sign use.						

300097375 SIGN - FLAGGER AHEAD 36IN

N		EA	1	2	1	E
SA-04094.						

300097391 SIGN - FLAGGER SYMBOL 36IN

N		EA	1	2	1	E
SA-03642.						

300097284 SIGN - RIGHT LANE CLOSED 36IN

N		EA	1	2	1	E
Roll-up SA-03657.						

300097292 SIGN - RIGHT LANE CLOSED 48IN

N		EA	1	2	1	E
Roll-up SA-03658.						

300097268 SIGN - WORKERS AHEAD 36IN

N		EA	1	2	1	E
Roll-up, Reflective, Velcro sign face only, SA-03989.						

300097276 SIGN - WORKERS AHEAD 48IN

N		EA	1	2	1	E
Reflective, SA-04091.						

260329339 STAND FOR WINDMASTER SIGN 4814

N		EA	1	4	1	E
For 36in or 48in roll-up signs.						

260430913 STAND FOR WINDMASTER SIGN 4818

N		EA	1	4	1	E
For 36in or 48in aluminum, plastic or plywood signs.						

DISTRIBUTION SERVICES

NETWORK SERVICES

TOOLS

BUILDING JANITORIAL

AUTOMOTIVE

FORMS/OFFICE SUPPLIES

GENERAL

DATA VOICE

DISTRIBUTION SERVICES

SIMILATOR

PRODUCT IDENTIFIER		DESCRIPTION					
ITEM NUMBER	ORD. MULT.	SELL UNIT	STD. PKG. STOCK AVAILABILITY / PA	LEAD TIME	MIN. ORD.	A C	

PRODUCT IDENTIFIER		DESCRIPTION					
ITEM NUMBER	ORD. MULT.	SELL UNIT	STD. PKG. STOCK AVAILABILITY / PA	LEAD TIME	MIN. ORD.	A C	

NETWORK SERVICES

SIMILATOR						
260357579						
N		EA	1	6	1	E
260357561 SIMULATOR RESISTANCE FAULT 1015						
N		EA	1	6	1	E
For 710 A/B.						

SLING						
400321451						
7157784	1	EA				E
Same as Sling Fabric C 6FT.						

TOOLS

SLEEVE IRON SOLDERING						
280016742						
N		EA	1	2	2	E

SLING						
400321451						
400321477						
1213652	1	EA				E
Slings are used primarily in attaching chain hoists or blocks to poles, especially joint use poles, BSP 081-500-125.						

BUILDING JANITORIAL

SLEEVE WIREWRAP						
400897781						
2786285	1	EA				E
Use with Bit Wirewrap 22-24 Gauge CK16734 L1 (1110429) and Tool Wirewrap CK16363 L3 (1135467).						

SLING						
400269338						
1180398	1	EA				E
Slings are used primarily in attaching chain hoists or blocks to poles, especially joint use poles, BSP 081-500-125.						

AUTOMOTIVE

SLEEVE WIREWRAP						
280020884						
N		EA	1	2	1	E
Use with Bit Wirewrap 30 Gauge 501381 (PID # 280020702).						
400897799						
2796649	1	EA				E
Use with Tool Wire Wrap CK16363 L3 (1135467).						

SLITTER						
260439849						
N		EA	1	2	1	E
Air impact tool parts.						
400269411						
1262261	1	EA				E
Consists of a small steel channel, two short lengths of chain, two swivel snaps and a slitting wire (1293423), BSP 081-780-105.						

FORMS/OFFICE SUPPLIES

SLEEVE WIREWRAP						
280020892						
N		EA	1	2	1	E
Use with Bit Wirewrap 30 Gauge 507063 (PID # 280020710).						
280020900						
N		EA	1	2	1	E
An accessory used with Tool Wire Wrap 27600 AD8 (1951087).						

SLITTER						
260439849						
N		EA	1	2	1	E
Air impact tool parts.						
400269411						
1262261	1	EA				E
Consists of a small steel channel, two short lengths of chain, two swivel snaps and a slitting wire (1293423), BSP 081-780-105.						

GENERAL

260446943						
N						
260446950						
N						

260439849						
N		EA	1	2	1	E
Air impact tool parts.						
400269411						
1262261	1	EA				E
Consists of a small steel channel, two short lengths of chain, two swivel snaps and a slitting wire (1293423), BSP 081-780-105.						

DATA VOICE

260446943						
N						
260446950						
N						

260439849						
N		EA	1	2	1	E
Air impact tool parts.						
400269411						
1262261	1	EA				E
Consists of a small steel channel, two short lengths of chain, two swivel snaps and a slitting wire (1293423), BSP 081-780-105.						

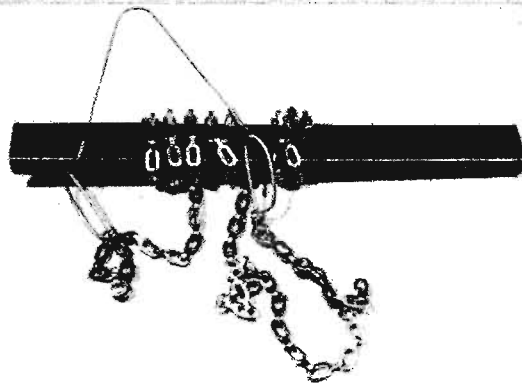
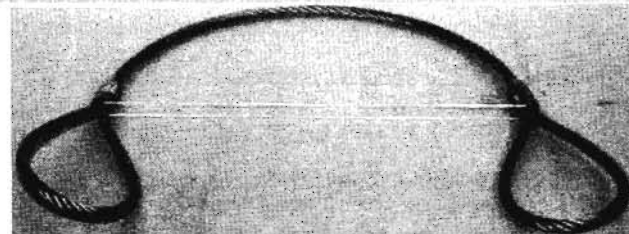
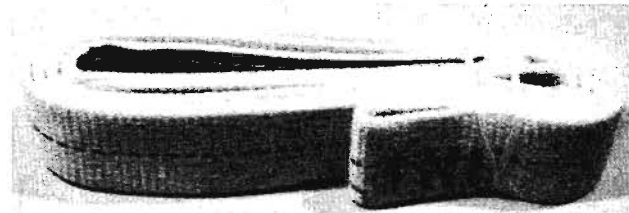

DISTRIBUTION SERVICES
 NETWORK SERVICES
 TOOLS
 BUILDING JANITORIAL
 AUTOMOTIVE
 FORMS/OFFICE SUPPLIES
 GENERAL
 DATA VOICE

PRODUCT IDENTIFIER		DESCRIPTION						A
ITEM NUMBER	ORD. MULT.	SELL UNIT	STD. PKG. STOCK AVAILABILITY / PA	LEAD TIME			MIN. ORD.	C
400269429 SLITTER WEB B CA08273								
1262287	1	EA	IL 12	IN 12	MI 12	OH 12	WI 12	E
For slitting the web between the strand and the cable core. Use with Blade Slitter Web B (1403220), BSP 627-700-014.								

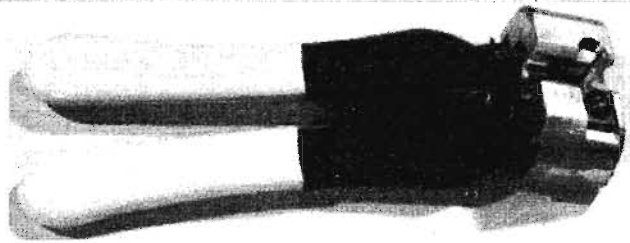

1262287

PRODUCT IDENTIFIER		DESCRIPTION						A
ITEM NUMBER	ORD. MULT.	SELL UNIT	STD. PKG. STOCK AVAILABILITY / PA	LEAD TIME			MIN. ORD.	C
401798558 SLITTER WIRE 205 CA07705								
1164145	1	EA	IL 12	IN 12	MI 12	OH 12	WI 12	E
Used for making longitudinal cuts in the insulation of parallel types of wire such as C rural.								

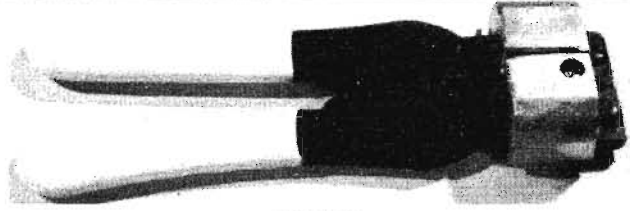

1164145

PRODUCT IDENTIFIER		DESCRIPTION						A
ITEM NUMBER	ORD. MULT.	SELL UNIT	STD. PKG. STOCK AVAILABILITY / PA	LEAD TIME			MIN. ORD.	C
400288023 SLITTER WIRE B FOR LEAD SLEEVES								
1293423	1	EA	IL 12	IN 12	MI 12	OH 12	WI 12	E
Replacement slitting wire for Slitter Sleeve Lead B (1262261), CA07449 - BSP 081-780-105.								

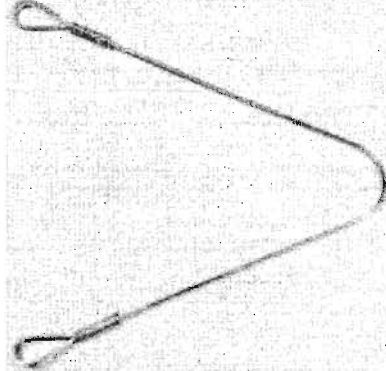

1293423

PRODUCT IDENTIFIER		DESCRIPTION						A
ITEM NUMBER	ORD. MULT.	SELL UNIT	STD. PKG. STOCK AVAILABILITY / PA	LEAD TIME			MIN. ORD.	C
402991889 SLITTER WIRE UP-B36								
1191619	1	EA	IL 12	IN 12	MI 12	OH 12	WI 12	E
Used to slit drop wire insulation. Use with Blade UP-5047 (5320861).								

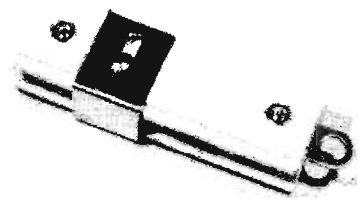

1191619

SNAP

PRODUCT IDENTIFIER		DESCRIPTION						A
ITEM NUMBER	ORD. MULT.	SELL UNIT	STD. PKG. STOCK AVAILABILITY / PA	LEAD TIME			MIN. ORD.	C
400488441 SNAP HOOK 2012								
1262345	1	EA						E



400488441

SNIP

PRODUCT IDENTIFIER		DESCRIPTION						A
ITEM NUMBER	ORD. MULT.	SELL UNIT	STD. PKG. STOCK AVAILABILITY / PA	LEAD TIME			MIN. ORD.	C
900211418 SNIP METAL MASTER M1 WISS								
6146522	1	EA						E

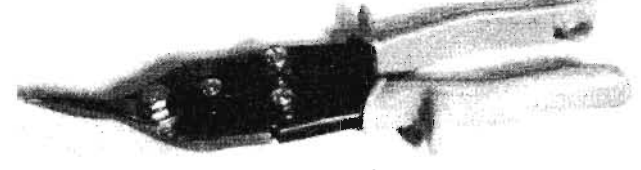

900211418

SOAP BUCKET

SEE BUCKET SOAP.

SOCKET

PRODUCT IDENTIFIER		DESCRIPTION						A
ITEM NUMBER	ORD. MULT.	SELL UNIT	STD. PKG. STOCK AVAILABILITY / PA	LEAD TIME			MIN. ORD.	C
402377212 SOCKET 3/16IN								
N		EA	1		3		10	E
Replacement for C Drill Driver Kit.								

SOCKET 1/2IN DRIVE

PRODUCT IDENTIFIER		DESCRIPTION						A
ITEM NUMBER	ORD. MULT.	SELL UNIT	STD. PKG. STOCK AVAILABILITY / PA	LEAD TIME			MIN. ORD.	C
280003500 SOCKET 1/2IN DRIVE DDS 1/2IN								
N		EA	1		1		1	E
Deep Double Square, SPR432.								

SOCKET 1/2IN DRIVE

DISTRIBUTION SERVICES

PRODUCT IDENTIFIER		DESCRIPTION				
ITEM NUMBER	ORD. MULT.	SELL UNIT	STD. PKG. STOCK AVAILABILITY / PA	LEAD TIME	MIN. ORD.	A C
280003682		SOCKET 1/2IN DRIVE	DDS	3/4IN		
N		EA	1	2	1	E
Deep Double Square, SPR436.						
280003690		SOCKET 1/2IN DRIVE	DDS	3/8IN		
N		EA	1	2	1	E
Deep Double Square, SPR426.						
280003674		SOCKET 1/2IN DRIVE	DDS	5/8IN		
N		EA	1	2	1	E
Deep Double Square, SPR434.						

NETWORK SERVICES

TOOLS

BUILDING JANITORIAL

AUTOMOTIVE

FORMS/OFFICE SUPPLIES

GENERAL

DATA VOICE

SOCKET 3/8IN DRIVE

280014267		SOCKET 1/2IN #818				
N		EA	1	2	5	E
Air impact tool parts.						

400291126		SOCKET 3/8IN DRIVE		1/2IN		
1262568	1	EA	IL IN MI OH WI	12 12 12 12 12		E
Replacement for Kit Wrench D.						



1262568

400900023		SOCKET 3/8IN DRIVE		3/8IN		
1262543	1	EA	IL IN MI OH WI	12 12 12 12 12		E
Replacement for Kit Wrench D.						

400291118		SOCKET 3/8IN DRIVE		7/16IN		
1262584	1	EA	IL IN MI OH WI	12 12 12 12 12		E
Replacement for Kit Wrench D, 6 point deep.						

400291134		SOCKET 3/8IN DRIVE		9/16IN		
1262600	1	EA	IL IN MI OH WI	12 12 12 12 12		E
Replacement for Kit Wrench D.						

260412200		SOCKET 3/8IN DRIVE		11/16IN		
1979930	1	EA	IL IN MI OH WI	12 12		E
Replacement for Kit Wrench D.						

300060142		SOCKET 3/8IN DRIVE IMPACT		1/2IN		
N		EA	1	2	1	E
SIMF 160.						

PRODUCT IDENTIFIER		DESCRIPTION				
ITEM NUMBER	ORD. MULT.	SELL UNIT	STD. PKG. STOCK AVAILABILITY / PA	LEAD TIME	MIN. ORD.	A C
280014275		SOCKET 3/8IN #816				
N		EA	1	2	5	E
Air impact tool parts.						
280014283		SOCKET 7/16IN #817				
N		EA	1	2	5	E
Air impact tool parts.						
280014291		SOCKET 9/16IN #819				
N		EA	1	2	4	E
Air impact tool parts.						
260440011		SOCKET 11/16IN #821				
N		EA	1	2	1	
Air impact tool parts.						
260440029		SOCKET 3/4IN #822				
N		EA	1	2	1	
Air impact tool parts.						
260439997		SOCKET 5/16IN #815				
N		EA	1	2	1	
Air impact tool parts.						
260440003		SOCKET 5/8IN #820				
N		EA	1	2	1	
Air impact tool parts.						

SOCKET 5/8IN DRIVE

280015967		SOCKET 5/8IN DRIVE DEEP		11/16IN		
N		EA	1	2	1	E
907042.						

280015959		SOCKET 5/8IN DRIVE DEEP		13/16IN		
N		EA	1	2	1	E
907041.						

280015900		SOCKET 5/8IN DRIVE DEEP		1 1/8IN		
N		EA	1	2	1	E
907004.						

260395272		SOCKET 5/8IN DRIVE DEEP		1 1/16IN		
N		EA	1	2	1	E
907002.						

280015942		SOCKET 5/8IN DRIVE STD		1IN		
N		EA	1	2	1	E
907012.						

280015926		SOCKET 5/8IN DRIVE STD		3/4IN		
N		EA	1	2	1	E
907008.						

280015918		SOCKET 5/8IN DRIVE STD		5/8IN		
N		EA	1	2	1	E
907006.						

280015983		SOCKET 5/8IN DRIVE STD		7/8IN		
N		EA	1	2	1	E
907010.						

PRODUCT IDENTIFIER		DESCRIPTION				
ITEM NUMBER	ORD. MULT.	SELL UNIT	STD. PKG. STOCK AVAILABILITY / PA	LEAD TIME	MIN. ORD.	A C
260395280		SOCKET 5/8IN DRIVE STD	3/16IN			
N		EA	1	2	1	E
		907009.				
280015975		SOCKET 5/8IN DRIVE STD	9/16IN			
N		EA	1	2	1	E
		907005.				
280015934		SOCKET 5/8IN DRIVE STD	15/16IN			
N		EA	1	2	1	E
		907011.				
260395249		SOCKET 5/8IN DRIVE STD	1 1/8IN			
N		EA	1	2	1	E
		907014.				
260395256		SOCKET 5/8IN DRIVE STD	1 1/16IN			
N		EA	1	2	1	E
		907013.				

SOLDER

900211434		SOLDER KR 5 40/60 1LB SPOOL				
6256586	1	SL				E

400303699		SOLDER SEALING C 1/4LB STICK				
1263467	1	EA	IL IN MI OH WI			E
			12 12 12 12 12			
		Used to seal porosities in wiping joints. BSP 633-020-011.				

280016494		SOLDER WICK 4				
N		EA	1	2	1	E
		Braid to remove solder, 3/32in. x 5ft.				

280016502		SOLDER WICK 8				
N		EA	1	2	1	E
		Braid to remove solder, 1/4in. x 2 1/2ft.				

280038597		SOLDER WICK 40-2-5				
N		EA	1	2	1	E

280019910		SOLDER WICK 40-5-5				
N		EA	1	3	1	E
		Copper braid, .130in. wide. Used to remove solder from solder connections and terminals. 5ft. spool. 25 spools per box.				

280019902		SOLDER WICK 40-6-2 1/2				
N		EA	1	3	1	E
		Copper braid, .190in. wide. Used to remove solder from large lug and wire connections, 2 1/2ft spool. 25 spools per box.				

280019936		SOLDER WICK 40-6-250				
N		RL	1	3	1	E
		Copper braid, .190in. wide. Used to remove solder from large lug and wire connections, 250 ft. roll.				

PRODUCT IDENTIFIER		DESCRIPTION				
ITEM NUMBER	ORD. MULT.	SELL UNIT	STD. PKG. STOCK AVAILABILITY / PA	LEAD TIME	MIN. ORD.	A C
260329958		SOLDER WICK 50 6 5FT				
1946871	1	RO	IL IN MI OH WI			E
			12 12 12 12 12			



1946871

280019928		SOLDER WICK 50-6-5				
N		EA	25	3	25	E

SOLDERING IRON

SEE IRON SOLDERING.

SPLITTER

280003542		SPLITTER CABLE 953				
N		EA	1	1	2	E

280003427		SPLITTER S3DGH 3-WAY AC-048676				
N		EA	1	2	1	E

SPRAY WASP

280039389		SPRAY WASP				
1924092	1	CS				E
		An aerosol spray used to control bees and wasps while working in outside plant. DISCONTINUED - USE SPRAY WASP & ANT (1978866).				

260429964		SPRAY WASP & ANT TELCO & POWER				
1978866	1	CN	IL IN MI OH WI			E
			12 12 12 12 12			
		An aerosol spray used to control ants, bees and wasps while working in outside plant. Case of 12. MSDS.				

DISTRIBUTION SERVICES

NETWORK SERVICES

TOOLS

BUILDING JANITORIAL

AUTOMOTIVE

FORMS/OFFICE SUPPLIES

GENERAL

DATA VOICE

DISTRIBUTION SERVICES

SPRAYER

PRODUCT IDENTIFIER		DESCRIPTION				
ITEM NUMBER	ORD. MULT.	SELL UNIT	STD. PKG. STOCK AVAILABILITY / PA	LEAD TIME	MIN. ORD.	A C

PRODUCT IDENTIFIER		DESCRIPTION				
ITEM NUMBER	ORD. MULT.	SELL UNIT	STD. PKG. STOCK AVAILABILITY / PA	LEAD TIME	MIN. ORD.	A C

NETWORK SERVICES

400269718 SPRAYER 5910 W/ADAPTER
 3319343 1 EA E
 Sprayer for pressure testing of cable, use with Solution Test Pressure E (1310441).



400269718

400451977 STAPLER T-18
 1265041 1 EA E
 Used with Staple T-18 (3/8in 1265009 or 7/16in 1952523) to fasten D or H station wire or small gauge ground wire, BSP 080-110-105.

400452041 STAPLER T-25
 1178335 1 EA E
 IL IN MI OH WI
 12 12 12 12 12
 Used to fasten four pair cable, #6 insulated ground wire or wire of equivalent size, uses Staple T-25 (3/8in 1265140 or 7/16in 1314294) BSP 080-110-101.

TOOLS

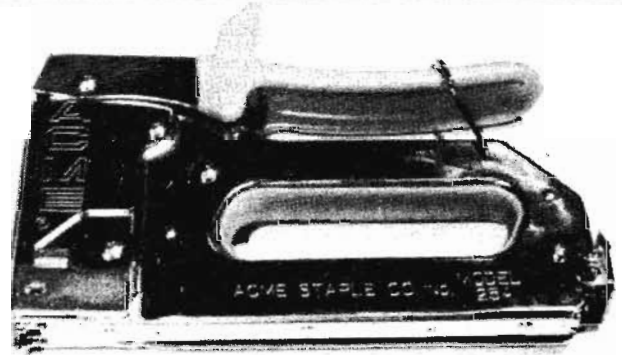

1178335

BUILDING JANITORIAL

400269742 SPREADER SLEEVE LEAD CA06748
 1264648 1 EA E
 Used to open small split lead sleeves, by cable splicing or maintenance forces.

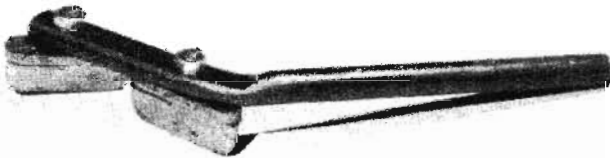

400269742

280017542 STAPLER T-37 GUN
 N EA 1 2 1 E

401114582 STAPLER T-75
 1265066 1 EA E
 IL IN MI OH WI
 12 12 12 12 12
 Intended to be used for fastening 25 pair D inside wiring cable to wood surfaces and uses Staples T-75 (5/8in 1265082 or 7/8in 1265108), BSP 461-200-210, BSP 080-110-101.

AUTOMOTIVE

401245501 SPRING SOLDERING CK14440 L60
 N EA 1 5 19 E

FORMS/OFFICE SUPPLIES

400270245 STAPLE B 1 1/4IN CA07307
 2771188 1 PK E
 1LB Package.

280017575 STAPLE FOR STAPLER T37 GUN
 N BX 1 2 1 E

GENERAL

401336243 STAPLE MOULD POLE 4IN
 5257949 1 EA E
 IL IN MI OH WI
 12 12 12 12 12
 Box of 50. Metal staple for holding wooden molding on telephone poles. 4in X 1 3/4in X 1/4in.

DATA VOICE

STATIC CONTROL PRODUCTS

280043332 BAG ANTISTATIC 5 IN X 10IN 4MIL
 1925073 1 EA E

280093527 BAG ANTISTATIC 8 1/2IN X 12IN
 1937110 1 EA E
 IL IN MI OH WI
 32 32 32 32 32

280043340 BAG ANTISTATIC 10 IN X 15IN 4MIL
 1925065 1000 EA E
 IL IN MI OH WI
 32 32 32 32 32
 Poly.

280019530 BAG ANTISTATIC 10 IN X 16IN PINK
 N EA 1 2 1 E
 POLY. Used to protect static sensitive circuit packs during shipping and handling.

280043357 BAG ANTISTATIC 18 IN X 20IN 4MIL
 1925057 1 EA E
 IL IN MI OH WI
 32 32 32 32 32
 Poly.

PRODUCT IDENTIFIER		DESCRIPTION						
ITEM NUMBER	ORD. MULT.	SELL UNIT	STD. PKG. STOCK AVAILABILITY / PA	LEAD TIME	MIN. ORD.	A	C	
260347471 BAG STATIC SHIELDING 2100								
1951400	1	PK	IL IN MI OH WI 12 12			E		
11IN X 15IN. Package of 100.								
260347455 BAG STATIC SHIELDING 2100								
1951392	1	PK	IL IN MI OH WI 12			E		
8IN X 10IN. Package of 100.								
260347463 BAG STATIC SHIELDING 2100								
1951384	1	PK	IL IN MI OH WI 09			E		
7IN X 15IN. Package of 100.								
260378336 BAG STATIC SHIELDING 2100E								
1960419	1	PK	IL IN MI OH WI 12 12 12			E		
11IN X 15IN RECLOSEABLE. Package of 100.								
260378344 BAG STATIC SHIELDING 2100E								
1960427	1	PK	IL IN MI OH WI 12 12			E		
8IN X 10IN RECLOSEABLE. Package of 100.								
260378351 BAG STATIC SHIELDING 2110E								
1960435	1	PK	IL IN MI OH WI 12 12			E		
10IN X 12IN RECLOSEABLE. Package of 100.								
260347489 BAND WRIST ANTISTATIC 2204								
1951145	1	EA	IL IN MI OH WI 12 12 12 12			E		
Adjustable replacement wrist bands for Strap Wrist 2214, 2224, 2234 and 2244.								
260347497 BOX TOTE ANTISTATIC 4432A								
1951418	1	EA	IL IN MI OH WI 12 12 12			E		
15IN X 20.25IN X 12IN. Use with Divider Antistatic 4333A (1951434) & Cover Tote Box Antistatic 4254A (1951426).								
260353784 CARRIER ANTISTATIC CARD 8520								
N		EA	1	3	10	E		
10IN X 8IN X 1.25IN.								
260353792 CARRIER ANTISTATIC CARD 8521								
N		EA	1	3	10	E		
12IN X 9IN X 1.25IN.								
260353800 CARRIER ANTISTATIC CARD 8522								
N		EA	5	3	5	E		
18IN X 17IN X 2IN.								
260353818 CARRIER ANTISTATIC CARD 8523								
N		EA	6	3	6	E		
10IN X 8IN X 2IN.								
300031325 CONTAINER ANTISTATIC SHIELD 4428								
5107292	1	EA	IL IN MI OH WI 12			E		
280093626 CORD ANTISTATIC 5FT 2210								
1937169	1	EA	IL IN MI OH WI 09 09			E		
Replacement grounding cord for wrist band.								

PRODUCT IDENTIFIER		DESCRIPTION						
ITEM NUMBER	ORD. MULT.	SELL UNIT	STD. PKG. STOCK AVAILABILITY / PA	LEAD TIME	MIN. ORD.	A	C	
280347554 CORD ANTISTATIC 5FT 2240								
1951178	1	EA	IL IN MI OH WI 09			E		
Replacement grounding cord for a wrist band, Five foot, light weight-heavy duty, coiled cord.								
280093634 CORD ANTISTATIC 10FT 2220								
1937151	1	EA	IL IN MI OH WI 09 09 09 09 09			E		
Replacement grounding cord for wrist band.								
280347521 CORD GROUND ANTISTATIC 3040								
1951301	1	EA	IL IN MI OH WI 12 12			E		
A 15 foot ground cord used with a floor mat.								
280347539 CORD GROUND ANTISTATIC 3048								
1951293	1	EA	IL IN MI OH WI 12 12			E		
Common point ground cord, used with Mat Table.								
280347513 CORD GROUND ANTISTATIC 3051								
1951376	1	EA	IL IN MI OH WI 09			E		
Common point cord with ground snap in middle.								
260347570 COVER TOTE BOX ANTISTATIC 4254A								
1951426	1	EA	IL IN MI OH WI 03 03 03			E		
Used with Box Tote Antistatic 4432A (1951418).								
260347588 DIVIDER WIDTH ANTISTATIC 4333A								
1951434	1	EA	IL IN MI OH WI 09 09			E		
For use with Box Tote Antistatic 4432A (1951418).								
260328000 KIT ANTISTATIC FIELD SERVICE 8502								
1951269	1	EA	IL IN MI OH WI 03 03 03 03			E		
8 3/4in x 24in, includes two 5ft ground cords, one wrist band, one static warning sign, and one instruction sign.								
280378138 KIT ANTISTATIC FIELD SERVICE 8515								
1960401	1	EA	IL IN MI OH WI 12 12			E		
Portable.								
260347638 KIT ANTISTATIC GROUND 3054								
1951244	1	EA	IL IN MI OH WI 03 03 03			E		
Used with Runner Antistatic Adhesive Brown-8100 Series.								
300031333 KIT ANTISTATIC PROTECTIVE CUSTOM								
5107250	1	EA	IL IN MI OH WI 12			E		
FIELD SERVICE KIT #3								
260347861 KIT ANTISTATIC WORKSTATION 8021								
1951327	1	EA	IL IN MI OH WI 03 03 03 03			E		
Includes (1)-Mat Table 8211, (1)-Mat Floor 8201, (1)-Cord Ground 3040, (1)-Cord Ground 3048 and (1)-Band Wrist 2200 Series.								

DISTRIBUTION SERVICES
 NETWORK SERVICES
 TOOLS
 BUILDING JANITORIAL
 AUTOMOTIVE
 FORMS/OFFICE SUPPLIES
 GENERAL
 DATA VOICE

STATIC CONTROL PRODUCTS

DISTRIBUTION SERVICES

PRODUCT IDENTIFIER		DESCRIPTION						MIN. A
ITEM NUMBER	ORD. MULT.	SELL UNIT	STD. PKG. STOCK AVAILABILITY / PA	LEAD TIME	MI	OH	WI	ORD. C
260323530 KIT ANTISTATIC WORKSTATION 8501								
1951251	1	EA	IL 03 IN 03 MI 03 OH 03 WI					E
Portable Workstation Kit includes Cord Ground 3051 and Band Wrist 2204 and 2ft x 2ft.								

NETWORK SERVICES

260347679 LABEL ANTISTATIC WARNING 7101								
1951277	1	RO	IL 12 IN MI OH WI	12				E
Roll of 250 Labels.								

TOOLS

260347687 MAT FLOOR ANTISTATIC BLACK 9474								
1951343	1	EA	IL 03 IN 03 MI 03 OH 03 WI					E
4FT X 8FT. Rigid, with 1/8in cleats to anchor into carpeting. Includes snap fastener and ground cord. Use only over carpet.								

260347703 MAT FLOOR ANTISTATIC BROWN 8201								
1951459	1	EA	IL 03 IN 03 MI 03 OH WI					E
4FT X 6FT.								

BUILDING JANITORIAL

260347695 MAT FLOOR ANTISTATIC CLEAR 9461								
1951335	1	EA	IL 03 IN 03 MI 03 OH 03 WI					E
45IN X 53IN. Rigid with lip to extend under desk and 1/8in cleats to anchor into carpeting. Includes snap fastener and ground cord, use only over carpet.								

260368147 MAT SPECIAL ANTISTATIC GRAY 8213								
1962571	1	EA	IL 09 IN MI OH WI					E
24IN X 21IN Non-standard.								

AUTOMOTIVE

260353776 MAT TABLE ANTISTATIC 1872								
N		EA	1	3	10			E
VELOSTAT.								

260353768 MAT TABLE ANTISTATIC BLACK 8214								
N		EA	1	3	1			E
2FT X 4FT.								

FORMS/OFFICE SUPPLIES

260347711 MAT TABLE ANTISTATIC BROWN 8211								
1951442	1	EA	IL 12 IN 12 MI 12 OH 12 WI					E
2FT X 4FT.								

309038460 MAT TABLE ANTISTATIC GRAY 2' x 4FT								
5109959	1	EA	IL 12 IN MI OH WI	12				E
Model 8213, 3M.								

GENERAL

260347760 RUNNER ANTISTATIC BROWN 8121								
1951228	1	EA	IL 09 IN MI OH WI	09				E
ADHESIVE-BACKED 4FT X 36FT. Runner is .2in thick, includes (2) Kit Ground Antistatic 3054.								

260347778 RUNNER ANTISTATIC BROWN 8131								
N		EA	1	3	1			E
ADHESIVE-BACKED 4FT X 100FT. Runner is .2in thick, includes (2) Kit Ground Antistatic 3054.								

DATA VOICE

PRODUCT IDENTIFIER		DESCRIPTION						MIN. A
ITEM NUMBER	ORD. MULT.	SELL UNIT	STD. PKG. STOCK AVAILABILITY / PA	LEAD TIME	MI	OH	WI	ORD. C

260347745 RUNNER ANTISTATIC BROWN 8141								
N		EA	1	3	1			E
ADHESIVE-BACKED 2FT X 31FT. Runner is .2in thick, includes (2) Kit Ground Antistatic 3054.								

260347752 RUNNER ANTISTATIC BROWN 8151								
1951210	1	EA	IL 09 IN MI OH WI					E
ADHESIVE-BACKED 2FT X 100FT. Runner is .2in thick, includes (2) Kit Ground Antistatic 3054.								

260347794 RUNNER ANTISTATIC BROWN 8221								
1951350	1	EA	IL 09 IN MI OH WI					E
ADHESIVE-BACKED 4FT X 40FT. Runner is .2in thick, includes (2) Kit Ground Antistatic 3054.								

260386305 RUNNER FLOOR ANTISTATIC 8251								
N		EA	1	2	1			E
4FT X 24FT Brown.								

260386313 RUNNER FLOOR ANTISTATIC 8261								
N		EA	1	2	1			E
2FT X 24FT Brown.								

260405287 SLEEVE ANTISTATIC BLACK D5								
1969485		EA	IL 32 IN MI OH WI					E

260347810 SNAP GROUND ANTISTATIC 3050								
1951319	1	PK	IL 12 IN 12 MI OH WI					E
Female snap used with the 8200 Series Mats, Package of 10.								

280014952 SPRING ANTISTATIC 93353400								
N		EA	1	2	1			E

260347836 STRAP SHOE ANTISTATIC 2045								
1951285	1	BX	IL 12 IN 12 MI 12 OH 12 WI					E
A shoe strap with ground, Box of 100.								

260347877 STRAP WRIST ANTISTATIC 2209								
1951194	1	EA	IL 09 IN MI OH WI					E
Disposable, Box of 250.								

002077246 STRAP WRIST ANTISTATIC 2211								
1163550	1	EA	IL 12 IN 12 MI 12 OH 12 WI					E
SMALL Wrist Strap equipped with a 5 foot cord.								

002077253 STRAP WRIST ANTISTATIC 2213								
1170142	1	EA	IL 12 IN 12 MI 12 OH 12 WI					E
LARGE Wrist Strap equipped with a 5 foot cord.								

260347844 STRAP WRIST ANTISTATIC 2214								
1951111	1	EA	IL 12 IN 12 MI 12 OH 12 WI					E
With a coiled 5ft ground cord and an adjustable band.								

PRODUCT IDENTIFIER		DESCRIPTION						
ITEM NUMBER	ORD. MULT.	SELL UNIT	STD. PKG. STOCK AVAILABILITY / PA	LEAD TIME	MIN. ORD.	A	C	
260328018 STRAP WRIST ANTISTATIC 2221								
1955732	1	EA	IL 12 IN 12 MI 12 OH 12 WI 12			E		
SMALL Wrist Strap equipped with a 10ft cord.								
300088614 STRAP WRIST ANTISTATIC 2222								
1920736	1	EA	IL 12 IN 12 MI 12 OH 12 WI 12			E		
MEDIUM Wrist Strap equipped with a 10 foot coil type cord, for discharging body static.								
300088622 STRAP WRIST ANTISTATIC 2223								
1920744	1	EA	IL 12 IN 12 MI 12 OH 12 WI 12			E		
LARGE Wrist Strap equipped with a 10 foot coil type cord, for discharging body static.								
260347869 STRAP WRIST ANTISTATIC 2224								
1951129	1	EA	IL 12 IN 12 MI 12 OH 12 WI 12			E		
With a coiled 10ft ground cord and an adjustable band.								
260347851 STRAP WRIST ANTISTATIC 2244								
1951137	1	EA	IL 09 IN 09 MI 09 OH 09 WI 09			E		
With a coiled 5ft light weight, heavy duty, ground cord and an adjustable band.								
260304209 STRAP WRIST ANTISTATIC CP408/C10								
1940692	1	EA	IL 12 IN MI OH WI			E		
Equipped with a coiled 10ft ground cord.								
260347893 TESTER ANTISTATIC WRIST BAND 716								
1951186	1	EA	IL 03 IN 03 MI 03 OH 03 WI 03			E		

STEM TORCH

401936513 STEM TORCH S23 F & G CA07932							
6148320	1	EA				E	
Used with Torch Acetylene G (1278309) when splicing and maintaining cable.							

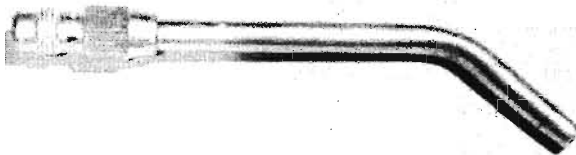

401936513

STICK

996780946 STICK ORANGE CK06320 L1							
1265603	1	EA				E	
This stick, tapered at both ends, is used to penetrate cable core to facilitate filling with resin, BSP 074-257-117, BSP 074-775-101.							



996780946

PRODUCT IDENTIFIER DESCRIPTION

ITEM NUMBER	ORD. MULT.	SELL UNIT	STD. PKG. STOCK AVAILABILITY / PA	LEAD TIME	MIN. ORD.	A	C
-------------	------------	-----------	-----------------------------------	-----------	-----------	---	---

STONE HONING

400409355 STONE HONING							
1265645	1	EA				E	
For general sharpening, BSP 081-730-100.							



400409355

STOOL FOOT

400620464 STOOL FOOT CK5174							
1265660	1	EA				E	
A 381, 803 stool is 13 1/2in high, 12in square on top. For use at main distributing frames in central offices, etc.							

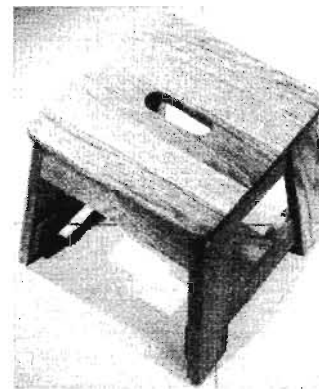

400620464

STRAIGHTENER PIN

280014978 STRAIGHTENER PIN 87369400							
N		EA	1	2	1	E	

STRAP

280060419 STRAP CABLE 24 1 5/16IN DIAMETER							
N		EA	1	3	1	E	
78-8004-0855-7. For attaching cables and pipes to poles or other supporting surfaces. BSP 627-610-200.							

DISTRIBUTION SERVICES

NETWORK SERVICES

TOOLS

BUILDING JANITORIAL

AUTOMOTIVE

FORMS/OFFICE SUPPLIES

GENERAL

DATA VOICE

DISTRIBUTION SERVICES

NETWORK SERVICES

TOOLS

BUILDING JANITORIAL

AUTOMOTIVE

FORMS/OFFICE SUPPLIES

GENERAL

DATA VOICE

STRAP

PRODUCT IDENTIFIER

DESCRIPTION

ITEM NUMBER	ORD. MULT.	SELL UNIT	STD. PKG. STOCK AVAILABILITY / PA	LEAD TIME	MIN. ORD.	A C
-------------	------------	-----------	-----------------------------------	-----------	-----------	-----

400010351 STRAP CABLE BENDER CA06290

1102848	1	EA	IL IN MI OH WI 12 12 12 12 12		E
---------	---	----	----------------------------------	--	---

For bending cables in manholes or on poles. Hard woven cotton webbing 60in X 2in e/w buckle.

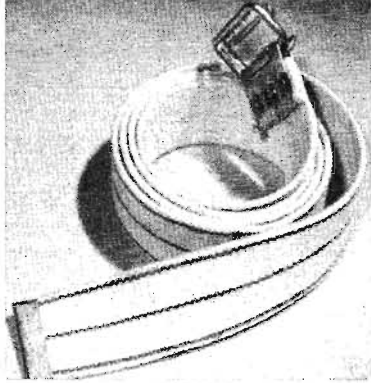

1102848

401170675 STRAP CHIN E342

N		EA	1	3	1	E
---	--	----	---	---	---	---

Universal. For use with a esterene cap, BSP 081-020-101.

260357512 STRAP CONDUCTOR 9006

N		EA	1	6	1	E
---	--	----	---	---	---	---

Package of 10. A jumper for shortening cable pairs at out end beyond the fault e/w 3 clips for various hook-ups.

280003310 STRAP INTERCEPT DX CMC-1041

N		EA	1	4	1	E
---	--	----	---	---	---	---

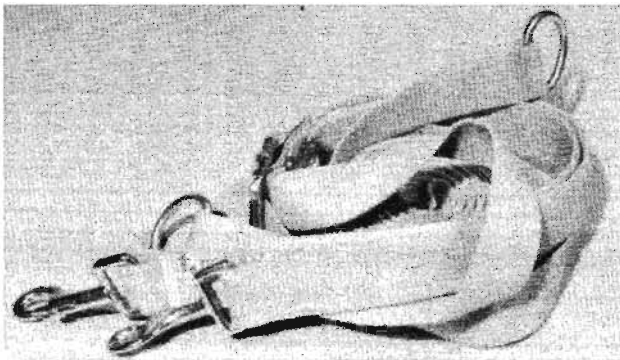

280003310

280029422 STRAP LADDER MATE BOTTOM LM100

1922864	1	EA	IL IN MI OH WI 12 12 12 12 12		E
---------	---	----	----------------------------------	--	---

Used to secure a ladder to a pole at the base before ascending.

PRODUCT IDENTIFIER

DESCRIPTION

ITEM NUMBER	ORD. MULT.	SELL UNIT	STD. PKG. STOCK AVAILABILITY / PA	LEAD TIME	MIN. ORD.	A C
-------------	------------	-----------	-----------------------------------	-----------	-----------	-----

280029430 STRAP LADDER MATE TOP LM200

1923037	1	EA	IL IN MI OH WI 12 12 12		E
---------	---	----	----------------------------	--	---

Used to secure the top of a ladder to a pole.

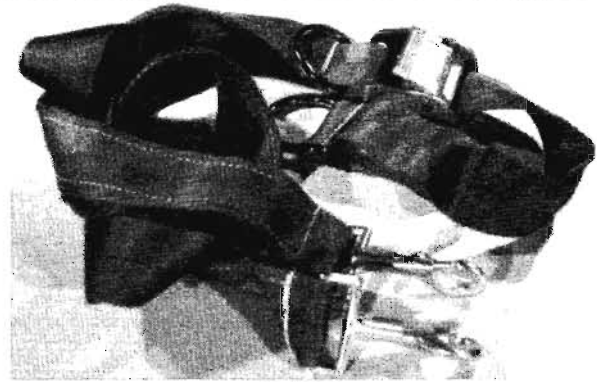

1923037

260323159 STRAP LADDER SAFE TIE

1943258	1	EA	IL IN MI OH WI 12 12		E
---------	---	----	-------------------------	--	---

Safe tie used to secure extension ladder to pole.

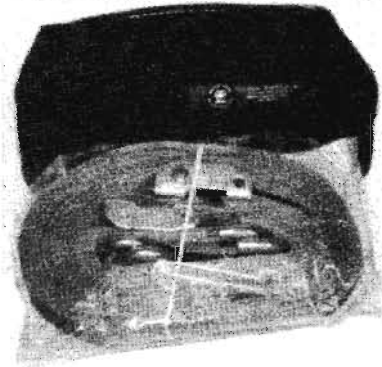

1943258

280014788 STRAP PLASTIC 85194-00

N		EA	1	2	1	E
---	--	----	---	---	---	---

400302378 STRAP SAFETY D CA07810

1187864	1	EA	IL IN MI OH WI 12 12 12 12 12		E
---------	---	----	----------------------------------	--	---

Nylon strap. Adjusts from 36in to 61 1/2in. Used by workmen in conjunction with body belt, BSP 081-720-101, BSP 081-721-200.

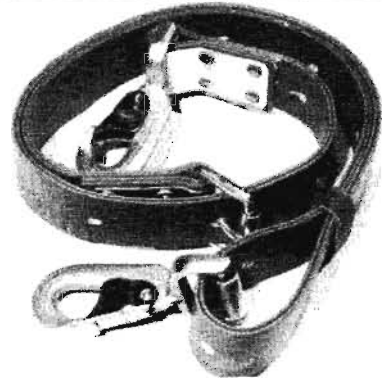

1187864

DISTRIBUTION SERVICES

NETWORK SERVICES

TOOLS

BUILDING JANITORIAL

AUTOMOTIVE

FORMS/OFFICE SUPPLIES

GENERAL

DATA VOICE

PRODUCT IDENTIFIER		DESCRIPTION				
ITEM NUMBER	ORD. MULT.	SELL UNIT	STD. PKG. STOCK AVAILABILITY / PA	LEAD TIME	MIN. ORD.	A C
900196841			STRAP SUPPORT 5208			
N		EA	8	3	8	E

PRODUCT IDENTIFIER		DESCRIPTION				
ITEM NUMBER	ORD. MULT.	SELL UNIT	STD. PKG. STOCK AVAILABILITY / PA	LEAD TIME	MIN. ORD.	A C
401051925			STRIPPER WIRE PLIER R3088			
1267823	1	EA	IL IN MI OH WI			E
			12 12 12 12 12			

A plier type wire stripper. Will strip various gauges of wire.

STRIPPER

300078094			STRIPPER CABLE TCS2			
4211862	1	EA				E
			Designed to remove sheath from 25 pair plenum cable.			

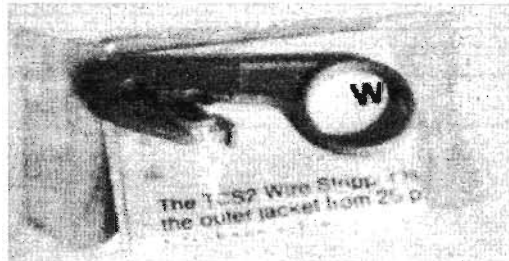

300078094

400890547			STRIPPER CK20620 L5			
N		EA	1	2	4	E
			A wire stripper with 2 slots for 22 & 24 gauge wire and e/w cut off. BSP 074-257-136.			

280003013			STRIPPER COAXIAL 033657			
N		EA	1	3	1	E
			Used to strip shielding and insulation from coax cable during the installation of data terminals. Anixter P/N14TL-PA1204.			

260392147			STRIPPER FIBER OPTIC OCS-100			
N		EA	1	4	1	E
			Uses Blade Replacement Stripper Fiber Optic (PID260392162).			

260392154			STRIPPER FIBER OPTIC OCS-200			
N		EA	1	4	1	E
			Uses Blade Replacement Stripper Fiber Optic (PID260392162).			

280024829			STRIPPER JACKET JST 500 AC 008136			
N		EA	1	3	1	E

105053334			STRIPPER T-WIRE RED HANDLE			
N		EA	1	2	1	E
			Allows you to strip up to 3.0 millimeters in diameter.			

105053300			STRIPPER T-WIRE YELLOW HANDLE			
N		EA	1	2	1	E
			Allows you to strip up to 2.4 millimeters in diameter.			

280013210			STRIPPER UT-5900 AC 021406			
N		EA	1	3	1	E

280013202			STRIPPER UT-6000 AC 022050			
N		EA	1	3	1	E

996780607			STRIPPER WIRE CK16902L1			
N		EA	1	2	1	E

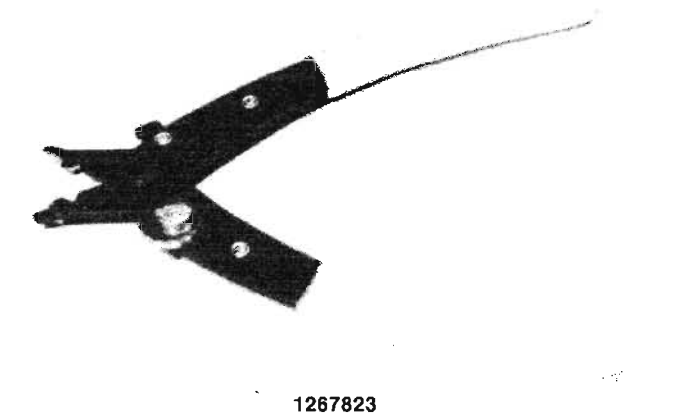

1267823

280020918			STRIPPER WIRE ST-100-30			
N		EA	1	2	1	E
			For 30 gauge wire, adjustable shiner length from 7/8in to 1 1/8in, single blade.			

300078110			STRIPPER WIRE TCS1			
4211870	1	EA	IL IN MI OH WI			E
			12 12 12 12 12			

Designed to remove sheath from 4, 6 or 8 pair plenum wire.

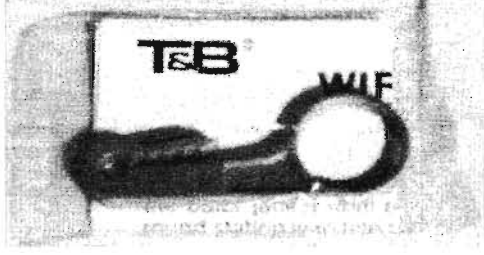

4211870

SUMP MANHOLE

280003021			SUMP MANHOLE 125			
N		EA	1	1	1	E
			A plastic dish with removable cover. Placed in floor of manhole for sump pump, cover attached with 1/8in winch line. 15in in diameter X 4 1/4in high.			

SUPPLY POWER

280026352			SUPPLY POWER EPS 110 AUTOWRAP			
N		EA	1	6	1	E

SUPPORT

400823761			SUPPORT LADDER 'D' BAR ASSEMBLY			
N		EA	1	4	1	E
			CA08634.			

DISTRIBUTION SERVICES

SUPPORT

PRODUCT IDENTIFIER		DESCRIPTION				
ITEM NUMBER	ORD. MULT.	SELL UNIT	STD. PKG. STOCK AVAILABILITY / PA	LEAD TIME	MIN. ORD.	A C
400818639			SUPPORT LADDER 'D' CLAMP ASSEMBLY			
N		EA	1	4	1	E
CA08634.						

NETWORK SERVICES

400823803			SUPPORT LADDER 'D' SPLICE CA08634					
N		EA	1	4	1	E		
400823811			SUPPORT LADDER 'E' CA08635					
1164210	1	EA	IL	IN	MI	OH	WI	E
			12	12	12	12	12	

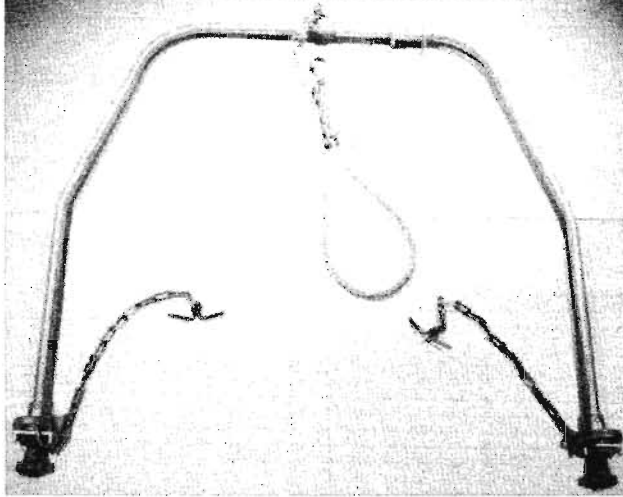

1164210

TOOLS

BUILDING JANITORIAL

400841375			SUPPORT PLATFORM MANHOLE 'D' CA08633					
2774505	1	EA	IL	IN	MI	OH	WI	E
			12	12	12	12	12	
Intended as a temporary support for planks to form a platform for workmen in manholes, BSP 081-300-100.								



2774505

AUTOMOTIVE

FORMS/OFFICE SUPPLIES

280056995			SUPPORT SPLICE HEAD 4244			
N		EA	1	3	1	E

SUSPENDERS

900315110			SUSPENDERS 6258 ADJUSTABLE			
N		EA	1	4	8	E
Used with Belt Body E.						

SUSPENSION

260359765			SUSPENSION ESRT-SL			
1953430	1	EA				E

GENERAL

DATA VOICE

PRODUCT IDENTIFIER		DESCRIPTION				
ITEM NUMBER	ORD. MULT.	SELL UNIT	STD. PKG. STOCK AVAILABILITY / PA	LEAD TIME	MIN. ORD.	A C

SWEATBAND

900111188			SWEATBAND 109C			
5359547	1	EA				E
A sponge rubber brow pad with an adjustable elastic headband for preventing perspiration from dripping onto safety glasses.						



900111188

SWITCH

280027152			SWITCH PRESSURE 4430A10			
N		EA	1	1	2	E

SWIVEL

400274122			SWIVEL B CA07205			
1123232	1	EA				E
Used between pulling eye of cable grip and pulling line when placing underground cable, BSP 628-200-208.						

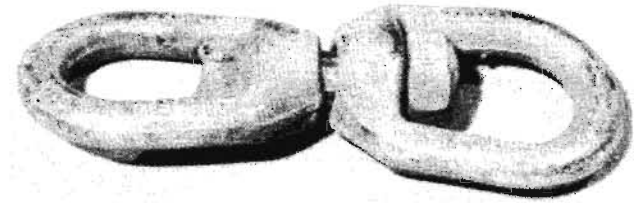

400274122

280011768			SWIVEL HD-1			
N		EA	1	4	1	E
Used for pulling interduct.						

PRODUCT IDENTIFIER		DESCRIPTION				
ITEM NUMBER	ORD. MULT.	SELL UNIT	STD. PKG. STOCK AVAILABILITY / PA	LEAD TIME	MIN. ORD.	A C

PRODUCT IDENTIFIER		DESCRIPTION				
ITEM NUMBER	ORD. MULT.	SELL UNIT	STD. PKG. STOCK AVAILABILITY / PA	LEAD TIME	MIN. ORD.	A C

DISTRIBUTION SERVICES

NETWORK SERVICES

TOOLS

BUILDING JANITORIAL

AUTOMOTIVE

FORMS/OFFICE SUPPLIES

GENERAL

DATA VOICE

TAPE MEASURE

400467353 TAPE MEASURE FIBERGLASS 100FT
 1421586 1 EA E
 CA07338. Used for measuring and is furnished in leather or plastic covered metal cases with folding reel handles. BSP 081-220-100.



400467353

401349758 TAPE MEASURE FIBERGLASS 200FT
 1215954 1 EA E
 IL IN MI OH WI
 12 12 12 12 12
 CA07338. Used for measuring and is furnished in leather or plastic covered metal cases with folding reel handles. BSP 081-220-100.

TARPAULIN

400321923 TARPAULIN B 4FT X 6FT CA07809
 1271189 1 EA E
 Used as protection for incomplete work, as temporary shelter for workmen and plant equipment and as protection for property, e/w grommets. BSP 081-020-112.

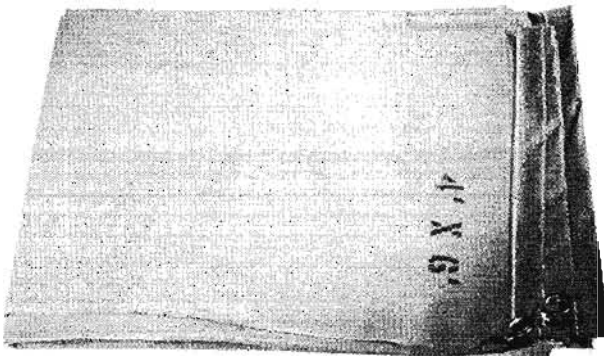

400321923

400279022 TARPAULIN B 8FT X 8FT CA07809
 N EA 1 4 1 E

400279030 TARPAULIN B 12FT X 15FT
 1271221 1 EA E
 IL IN MI OH WI
 12 12 12 12 12

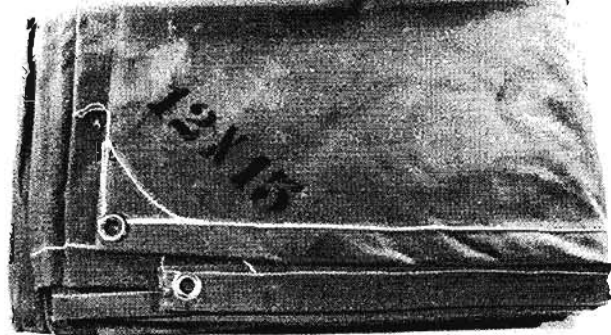

1271221

400321931 TARPAULIN D 4FT X 6FT CA08354
 N EA 1 8 1 E

400321949 TARPAULIN D 8FT X 8FT CA08354
 3331082 1 EA E
 IL IN MI OH WI
 12 12 12 12 12
 DISCONTINUE ORDER NON STOCK UPON STOCK DEPLETION

400321956 TARPAULIN D 10FT X 12FT CA08354
 N EA 1 8 1 E

996223897 TARPAULIN PORTABLE CK15648 L3
 1271247 1 EA E
 IL IN MI OH WI
 12 12 12 12 12
 A 6ft X 12ft, electronically sealed, vinyl coated tarpaulin with 1/2in eyelets along edges. Used as protection for equipment and apparatus.

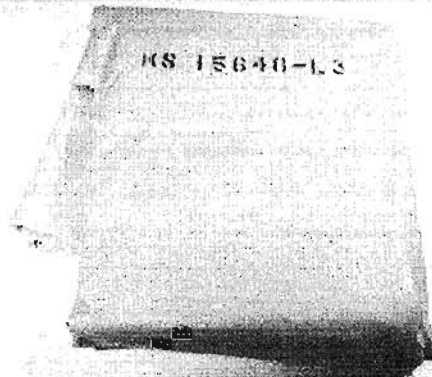

1271247

DISTRIBUTION SERVICES

NETWORK SERVICES

TOOLS

BUILDING JANITORIAL

AUTOMOTIVE

FORMS/OFFICE SUPPLIES

GENERAL

DATA VOICE

TENT

PRODUCT IDENTIFIER		DESCRIPTION				
ITEM NUMBER	ORD. MULT.	SELL UNIT	STD. PKG. STOCK AVAILABILITY / PA	LEAD TIME	MIN. ORD.	A C

TENT

400279154 TENT AERIAL H COMPLETE CA08231

1272583 1 EA E
 A lightweight folding tent designed for installation and removal by one man. Complete tent weights 30lbs, BSP 081-310-121.

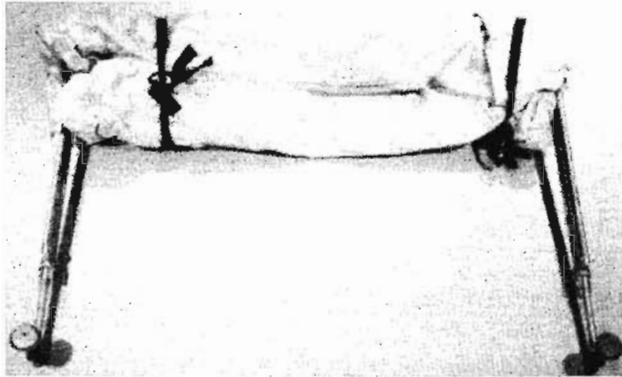

400279154

400134516 TENT AERIAL H COVER CA08231

1147587 1 EA E
 IL IN MI OH WI
 12 12 12 12 12
 Replacement part for tent aerial H. 47 1/2in depth x 52in width x 8ft 8in high, BSP 081-310-101.



1147587

400266193 TENT AERIAL SHELTER 38Y3920

2295683 1 EA E
 IL IN MI OH WI
 12 12 12 12 12
 Ladder tent for cable repair with carrying case.

400006128 TENT BAG B CA08040

N EA 1 4 1 E
 NOW AVAILABLE THROUGH TOUCH-TONE ORDER ENTRY.

260364674 TENT GROUND 6FT X 6FT X 6.5FT W/CASE

1966226 1 EA E
 IL IN MI OH WI
 12 12 12 12 12
 6506B, expandable.

PRODUCT IDENTIFIER		DESCRIPTION				
ITEM NUMBER	ORD. MULT.	SELL UNIT	STD. PKG. STOCK AVAILABILITY / PA	LEAD TIME	MIN. ORD.	A C

400279170 TENT GROUND COVER CA06282

1329342 1 EA E
 IL IN MI OH WI
 12 12 12 12 12



1329342

280093907 TENT GROUND PELSUE 8FT X 8FT X 6.5FT

1966218 1 EA E
 IL IN MI OH WI
 12 12 12 12 12
 6508B, expandable, with case.

260385042 TENT HARDWARE BUCKET 63360 PELSUE

1966143 1 EA E
 IL IN MI OH WI
 12 12 12 12 12
 Use with multi tent 6334A.

260385075 TENT HARDWARE MANHOLE 63390 PELSUE

1966127 1 EA E
 IL IN MI OH WI
 12 12 12 12 12
 Use with multi tent 6334A.

260383229 TENT HARDWARE POLE 63380 PELSUE

1966135 1 EA E
 IL IN MI OH WI
 12 12 12 12 12
 Use with multi tent 6334A.

260385067 TENT HARDWARE STRAND 63350 PELSUE

1966150 1 EA E
 IL IN MI OH WI
 12 12 12 12 12
 Use with multi tent 6334A.

401490313 TENT LADDER C CA07604

1272245 1 EA E
 IL IN MI OH WI
 12 12 12 12 12
 A one man tent designed for a cable splicer working from a ladder.

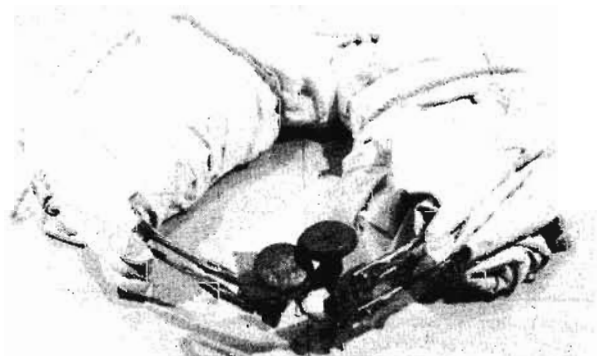

1272245

PRODUCT IDENTIFIER DESCRIPTION

ITEM NUMBER	ORD. MULT.	SELL UNIT	STD. PKG. STOCK AVAILABILITY / PA	LEAD TIME	MIN. ORD.	A C
-------------	------------	-----------	-----------------------------------	-----------	-----------	-----

400279188 TENT MANHOLE COVER CA06881
 5154641 1 EA IL IN MI OH WI 12 12 12 12 E
 A compact square covering for the square type manhole guard, has two pipe members attached to the front corners, BSP 081-310-103.

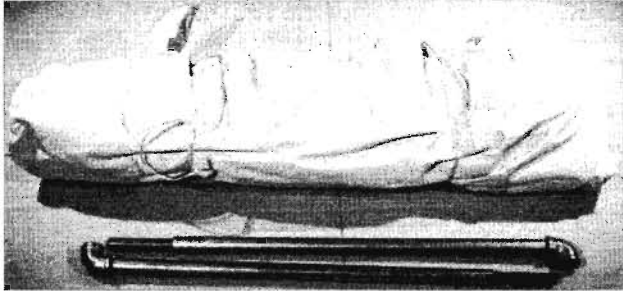

5154641

260390554 TENT MULTI 6334A BUCKET PELSUE
 1966184 1 EA IL IN MI OH WI 12 12 12 12 E
 With case and bucket hardware 63360.

260385034 TENT MULTI 6334A MANHOLE PELSUE
 1966168 1 EA IL IN MI OH WI 12 12 12 12 E
 With case and manhole hardware 63390.

260390562 TENT MULTI 6334A POLE PELSUE
 1966176 1 EA IL IN MI OH WI 12 12 12 12 E
 With case and pole hardware 63380.

260383252 TENT MULTI 6334A STRAND PELSUE
 1966192 1 EA IL IN MI OH WI 12 12 12 12 E
 With case and strand hardware 63350.

TERMINATION

401496567 TERMINATION CMC 7637-900
 1184440 1 EA E

401539895 TERMINATION CMC 7638-600 ORANGE
 4210153 1 EA IL IN MI OH WI 12 12 E

TEST PROBE

SEE PROBE.

TEST SET

SEE SET TEST.

TESTER

260427679 TESTER BATTERY 45 VOLT
 N EA 1 3 1 E
 Provides the Outside Plant Technician with a quick means of detecting faulty 45 volt batteries in test sets not equipped to do so.

PRODUCT IDENTIFIER DESCRIPTION

ITEM NUMBER	ORD. MULT.	SELL UNIT	STD. PKG. STOCK AVAILABILITY / PA	LEAD TIME	MIN. ORD.	A C
-------------	------------	-----------	-----------------------------------	-----------	-----------	-----

260442165 TESTER BIT ERROR RATE (BERTS)
 N EA 1 17 1
 381-821-00.

280003047 TESTER CIRCUIT GFI 521B101
 N EA 1 2 2 E
 Used to test any three-wire 115V single phase polarized wall receptacle. Will indicate safe, reversed polarity and faulty ground circuits.

401352158 TESTER IDEAL 61-040
 5154666 1 EA IL IN MI OH WI 12 12 12 12 E
 For testing electrical power receptacles from 80 to 600 volts AC or DC.

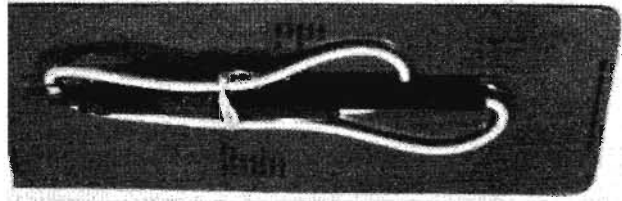

5154666

260359781 TESTER INTERFACE EIA232 100H
 1953497 1 EA IL IN MI OH WI 12 12 12 12 E

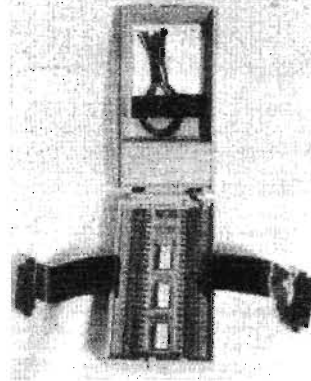

1953497

104305875 TESTER LINE 953B
 1934281 1 EA IL IN MI OH WI 12 E



1934281

DISTRIBUTION SERVICES

NETWORK SERVICES

TOOLS

BUILDING JANITORIAL

AUTOMOTIVE

FORMS/OFFICE SUPPLIES

GENERAL

DATA VOICE

DISTRIBUTION SERVICES

NETWORK SERVICES

TOOLS

BUILDING JANITORIAL

AUTOMOTIVE

FORMS/OFFICE SUPPLIES

GENERAL

DATA VOICE

TESTER

PRODUCT IDENTIFIER		DESCRIPTION					
ITEM NUMBER	ORD. MULT.	SELL UNIT	STD. PKG. STOCK AVAILABILITY / PA	LEAD TIME	MIN. ORD.	A	C

280003054			TESTER MODULAR JACK 114-4				
N		EA	1	2	4	E	
For testing proper and reverse polarity, opens, shorts and A/C lamp voltage. Either red/green or yellow/black pairs can be selected for testing. E/W a receptacle to accept modular plug 115-8.							

260338785			TESTER ONE PAIR CQF P33392				
N		EA	1	4	1	E	
NOW AVAILABLE THROUGH TOUCH-TONE ORDER ENTRY.							

001207190			TESTER POCKET SPERRY SP140				
1168757	1	EA	IL IN MI OH WI			E	
Multiple volt-ohm meter 3 1/2in X 3/4in X 1 13/16in, ohms 4K-OK, carrying case included.							

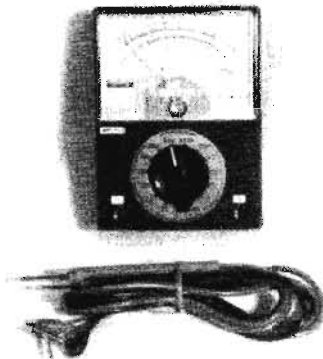

1168757

280003062			TESTER TRANSISTOR 138B100				
N		EA	1	2	1	E	
In circuit-out circuit used to test transistors, e/w battery and cables.							

THERMOMETER

997317763			THERMOMETER CK5499 L1352				
1273987	1	EA				E	
For use in testing cells 100 ampere-hours or less, 6 5/8in long, BSP 084-750-101.							



997317763

997992615			THERMOMETER CK5499 L1353				
1100610	1	EA	IL IN MI OH WI			E	
For use in testing cells over 100 ampere-hours, 10 1/2in long, BSP 084-750-101.							

400409397			THERMOMETER T-40 206WEC				
N		EA	1	3	1	E	

TIE TWIST

280047861			TIE TWIST 20/5 3IN				
1926691	1000	EA				E	
DISCONTINUE, ORDER NON STOCK UPON STOCK DEPLETION							

PRODUCT IDENTIFIER		DESCRIPTION					
ITEM NUMBER	ORD. MULT.	SELL UNIT	STD. PKG. STOCK AVAILABILITY / PA	LEAD TIME	MIN. ORD.	A	C

400729422			TIP CK14440 L35				
7324905	1	EA				E	
1/8in threaded, chisel, iron plated, BSP 074-257-105.							



400729422

400729448			TIP CK14440 L37				
2757807	1	EA	IL IN MI OH WI			E	
3/16in threaded, chisel, iron plated.							



2757807

400751541			TIP CONICAL CA8629 L2				
N		EA	1	2	1	E	



400751541

400321980			TIP COPPER CK 8740 L34				
1100636	1	EA	IL IN MI OH WI			E	
Chrome and iron plated colorized copper tip, 2 3/8in. overall length. BSP 069-140-811, BSP 074-590-101 and BSP 075-191-812 - Tips - KS8740.							

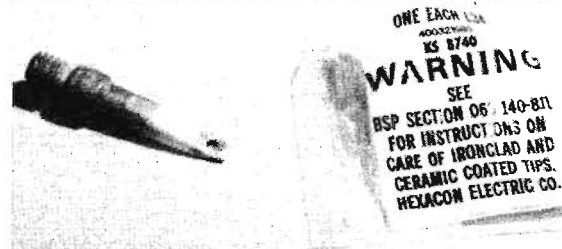

1100636

400729414			TIP COPPER CK14440 L25				
2755843	1	EA	IL IN MI OH WI			E	
Heater and tip assembly used with Iron Soldering CK14440, BSP 074-157-105.							



2755843

PRODUCT IDENTIFIER		DESCRIPTION					MIN.	A
ITEM NUMBER	ORD. MULT.	SELL UNIT	STD. STOCK	PKG. AVAILABILITY / PA	LEAD TIME	ORD.	C	

400751558 TIP DUCKBILL CA8629 L3
 2768424 1 EA IL IN MI OH WI E
 12 12 12 12 12
 Use where Tip Conical (2768408) isn't adequate.
 To be used with Probe Test CA08629 L1
 (1127472), BSP 105-241-100.

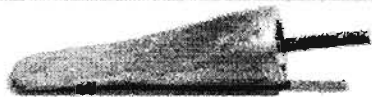

2768424

280016718 TIP NARROW E476B134 95W
 N EA 1 2 6 E

280002916 TIP PRE-TINNED TPW 133
 N EA 1 1 11 E
 Pre-tinned soldering tip for Handle TPW 555
 (4280164), part of Kit Solder Iron TPW 2-20
 (1186635), for frame use.

280002924 TIP PRE-TINNED TPW 151
 N EA 1 1 1 E
 A replacement tip for Handle TPW 555
 (4280164), part of Kit Solder Iron TPW 2-20
 (1186635), for switchroom use. Tip is 1/8In
 wide and longer than the TPW 132.

280016734 TIP SOLDER 476B833
 N EA 1 2 1 E

280002932 TIP SOLDER 7545
 N EA 1 2 1 E
 For ISO-TIP cordless soldering iron.

900217811 TIP SOLDER 823 PARAGON
 1274886 1 EA IL IN MI OH WI E
 12 12 12 12 12



1274886

280013939 TIP SPARE 6804
 N EA 1 2 1 E

280013160 TIP ST07M
 N EA 1 2 1 E

300052651 TIP TORCH BA-2
 6509653 1 EA IL IN MI OH WI E
 12 12 12 12 12
 Mapp gas torch tip used for heat shrink
 application.



6509653

PRODUCT IDENTIFIER		DESCRIPTION					MIN.	A
ITEM NUMBER	ORD. MULT.	SELL UNIT	STD. STOCK	PKG. AVAILABILITY / PA	LEAD TIME	ORD.	C	

001029495 TIP TORCH PRESTOLITE AD1455
 8179200 1 EA IL IN MI OH WI E
 12 12 12 12 12
 Acetylene torch tip.

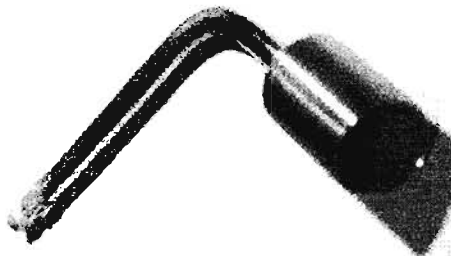

8179200

280016726 TIP WIDE E476B133 95W
 N EA 1 2 1 E

TISSUE

300040219 TISSUE MAGIC 850R
 5111492 1 CT
 Package of 400.

TOOL

280026378 TOOL ABRADING AD 7520
 N EA 1 6 10 E

996813390 TOOL ADJUSTER CK19355 L3
 N EA 1 3 1 E

260386255 TOOL ALIGNMENT AT10K
 N KT 1 6 1 E

280022591 TOOL CABLE TIE G52B
 N EA 1 4 1 E
 Hand operated, ties all miniature, intermediate
 and standard cable ties, clamps and markers.

996758058 TOOL CK02348
 1278002 1 EA IL IN MI OH WI E
 12 12 12 12 12
 Screwdriver for placing shell and binding screws
 on switchboard plugs.BSP 074-800-101 and BSP
 074-208-135.



1278002

300097060 TOOL CUT CLOSED 4050
 N EA 1 2 1 E

DISTRIBUTION SERVICES

NETWORK SERVICES

TOOLS

BUILDING JANITORIAL

AUTOMOTIVE

FORMS/OFFICE SUPPLIES

GENERAL

DATA VOICE

TOOL

PRODUCT IDENTIFIER		DESCRIPTION						
ITEM NUMBER	ORD. MULT.	SELL UNIT	STD. PKG. STOCK AVAILABILITY / PA	LEAD TIME	MIN. ORD.	A	C	

300040318 TOOL CUTTER REMOVAL 10923
 N EA 1 3 1 E
 A sheath removal tool adaptable for most types of cable sheath and inner duct configurations.

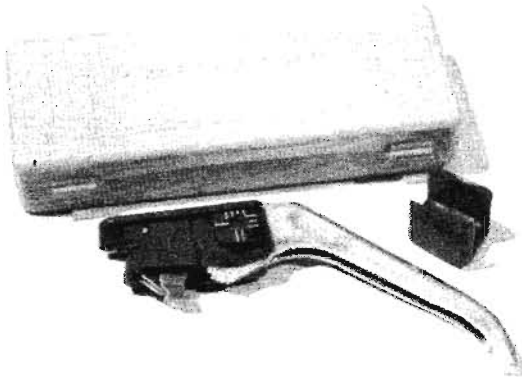

300040318

300077195 TOOL CUTTER WASHER WCT-11K
 5124024 1 EA IL IN MI OH WI E
 12 12 12 12 12
 For cutting universal washers packaged with the 2-type closure system. Use with Blade Replacement Kit WCB-11K (5124016).



5124024

280007030 TOOL EXTRACTOR 91079-1
 N EA 1 2 1 E

280002957 TOOL EXTRACTOR HT1807
 N EA 1 2 3 E
 A tool required for the installation of the AT&T 4540 Teletype. Moler P/N11-02-0001.

280002981 TOOL EXTRACTOR HT2285
 N EA 1 2 3 E
 Used to extract pins in teletype equipment. Waldons P/N11-03-0002.

900350893 TOOL EXTRACTOR T114-1
 N EA 1 2 1 E

300045663 TOOL HAND VS-3 AMP 244271-1
 N EA 1 2 1 E

260348412 TOOL HAND VS-3 WITH HOLDER
 N EA 1 2 1 E
 AMP 244271-5.

PRODUCT IDENTIFIER		DESCRIPTION						
ITEM NUMBER	ORD. MULT.	SELL UNIT	STD. PKG. STOCK AVAILABILITY / PA	LEAD TIME	MIN. ORD.	A	C	

280002965 TOOL IMPACT INSERTION Q915
 N EA 1 3 1 E
 Terminates wires on Telco systems T-1 DSX hardwired cross connect panel from ADC.

280011776 TOOL INSERTION ATA 1033
 N EA 1 2 1 E
 Used in Central Office Maintenance for the removal of file disks on 1A ESS machines.

402383343 TOOL INSERTION D CA08764
 N EA 1 8 2 E
 T-8764.

260357330 TOOL INSERTION T-HANDLE SINGLE WIRE
 1952671 1 EA IL IN MI OH WI E
 12

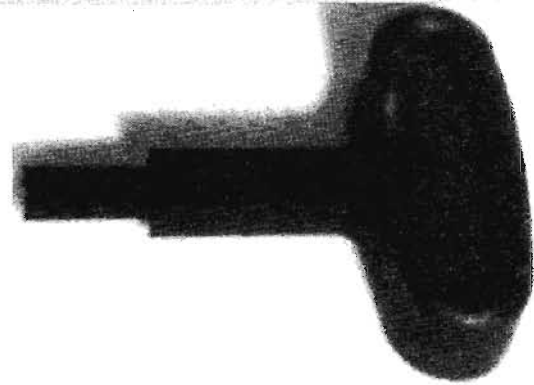

1952671

280037557 TOOL LARGE HAND CLEANING 311SH
 N EA 1 2 5 E

280038639 TOOL LEAD SLEEVE CLOSING I-J-19
 N EA 1 6 1 E
 Used to close sleeve in cable splicing, furnished with ratchet handle. P/N86250116.

280002973 TOOL LEAD SLEEVE G 1026
 N EA 1 3 1 E
 Used to open and close lead sleeves. Retains a tight seam for soldering.

280011891 TOOL PLACING 1062-12
 N EA 1 2 1 E
 Pulling eye and grip for placing fiber optic inner duct. Available in three lengths 12in, 18in & 24in, for staggering.

280011917 TOOL PLACING 1062-18
 N EA 1 2 1 E
 Pulling eye and grip for placing fiber optic inner duct. Available in three lengths 12in, 18in & 24in, for staggering.

280011909 TOOL PLACING 1062-24
 N EA 1 2 1 E
 Pulling eye and grip for placing fiber optic inner duct. Available in three lengths 12in, 18in & 24in, for staggering.

900265653 TOOL PUNCH BD CLP SP578
 N EA 1 2 1 E
 Sheath punch made of steel and powder steel.

DISTRIBUTION SERVICES

NETWORK SERVICES

TOOLS

BUILDING JANITORIAL

AUTOMOTIVE

FORMS/OFFICE SUPPLIES

GENERAL

DATA VOICE

PRODUCT IDENTIFIER DESCRIPTION

ITEM NUMBER	ORD. MULT.	SELL UNIT	STD. PKG. STOCK AVAILABILITY / PA	LEAD TIME	MIN. ORD.	A C
-------------	------------	-----------	-----------------------------------	-----------	-----------	-----

280022682 TOOL PUNCH QTH38B
 N EA 1 4 1 E
 For terminating and removing cross-connect wires on Northern Telecom NE 66QC type connecting blocks.

280024613 TOOL PUNCHING 604610-1
 N EA 1 6 1 E
 An accessory to be used with the amp Universal closure.

900197179 TOOL R 260 SHURE SET
 1328922 1 EA IL IN MI OH WI 12 12 12 12 12 E
 Used to drive Sure Set Fasteners into concrete and masonry. E/W chuck and dowel pin for conversion to a masonry drill, BSP 061-745-113.

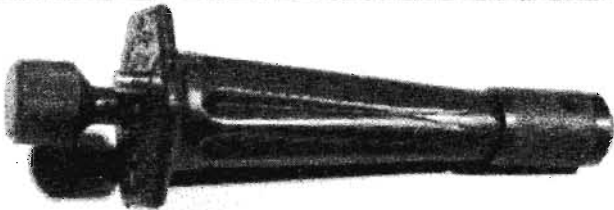

1328922

400494696 TOOL R1005 SCREWDRIVER JEWELERS
 N EA 1 3 1 E
 L.S.Starr ETT 555C.

900214131 TOOL R3907 CUT SKINNING
 1277988 1 EA IL IN MI OH WI 12 12 12 12 12 E

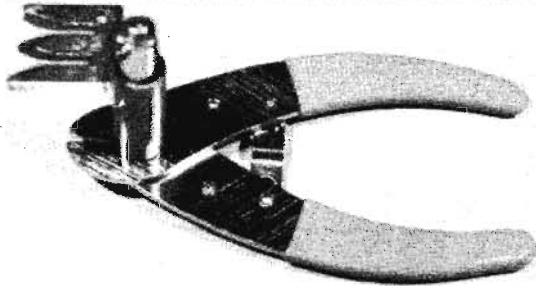

1277988

400280202 TOOL RAISING WIRE CA06355
 1168997 1 EA IL IN MI OH WI 12 12 12 12 12 E
 Tool used for placing line or drop wire on cross arms or other supports and is attached to a tree-pruner handle, BSP 623-210-200.



1168997

PRODUCT IDENTIFIER DESCRIPTION

ITEM NUMBER	ORD. MULT.	SELL UNIT	STD. PKG. STOCK AVAILABILITY / PA	LEAD TIME	MIN. ORD.	A C
-------------	------------	-----------	-----------------------------------	-----------	-----------	-----

400280210 TOOL REPAIR VALVE CA07471
 1278226 1 EA IL IN MI OH WI 12 12 12 12 12 E
 Used to remove or replace a valve from a valve stem in a cable pressure system, BSP 081-600-011.

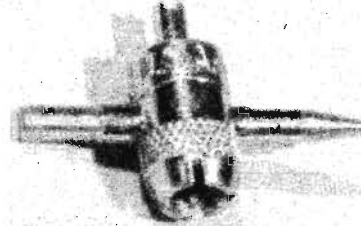

1278226

280025313 TOOL STRIP FIBER OPTIC SINGLE MODE
 N EA 1 2 1 E
 FO102-103S.

260412002 TOOL STRIPPING 3CS5859GN
 N EA 1 3 1 E

300097078 TOOL SUPER MINI MODULE 4051
 N EA 1 2 1 E
 Wire insert and cutoff.

300080975 TOOL TY-RAP INSTALLATION WT-3D
 1215061 1 EA IL IN MI OH WI 12 12 12 12 12 E
 Used to tighten & trim cable ties used for the securing of the Kold-N-Klose repair sleeves.

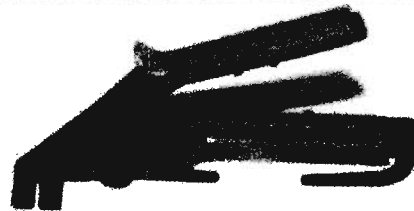

1215061

TOOL CASE

SEE CASE TOOL

TOOL CORING

280024795 TOOL CORING 1/2 IN CCT 3500
 N EA 1 3 1 E

280024803 TOOL CORING 3/4 IN CCT 3750
 N EA 1 3 1 E

280013194 TOOL CORING CCT-3100AC 040983
 N EA 1 3 1 E

280013186 TOOL CORING DCT-500 AC 037040
 N EA 1 2 1 E

280013178 TOOL CORING DCT-750 AC 037041
 N EA 1 2 1 E

DISTRIBUTION SERVICES

NETWORK SERVICES

TOOLS

BUILDING JANITORIAL

AUTOMOTIVE

FORMS/OFFICE SUPPLIES

GENERAL

DATA VOICE

DISTRIBUTION SERVICES

TOOL CRIMPING

PRODUCT IDENTIFIER		DESCRIPTION					
ITEM NUMBER	ORD. MULT.	SELL UNIT	STD. PKG. STOCK AVAILABILITY / PA	LEAD TIME	MIN. ORD.	A	C

TOOL CRIMPING

260388822 TOOL CRIMPING 292-32024
 1966762 1 EA E
 To crimp T & B C taps 54720, 54725TP and 2 hole lug 54205TP.

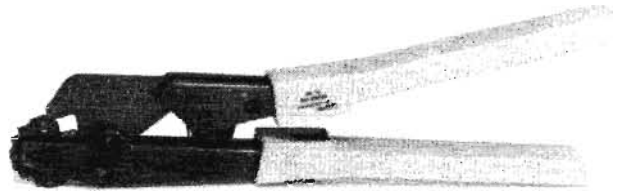

260388822

260381173 TOOL CRIMPING CK22214 L 1
 N EA 1 4 1 E

900407321 TOOL CRIMPING E9BM
 1191478 1 EA IL IN MI OH WI E
 12 12 12 12
 For use with all Scotchlock Brand Copnnectors, parallel closing action, with adjustable jaws.

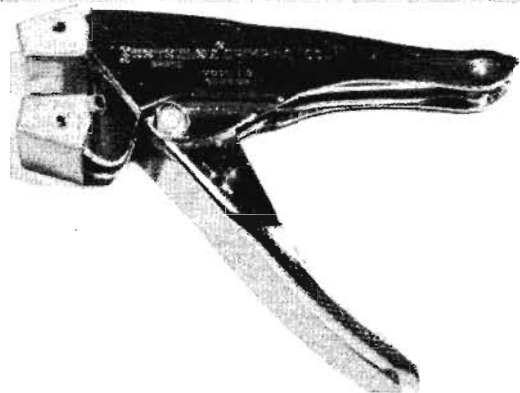

1191478

900218207 TOOL CRIMPING E9C
 1172478 1 EA IL IN MI OH WI E
 12 12 12 12
 A crimping tool which crimps and automatically feeds UR or UY scotchlock connectors which are packaged in cartridges.

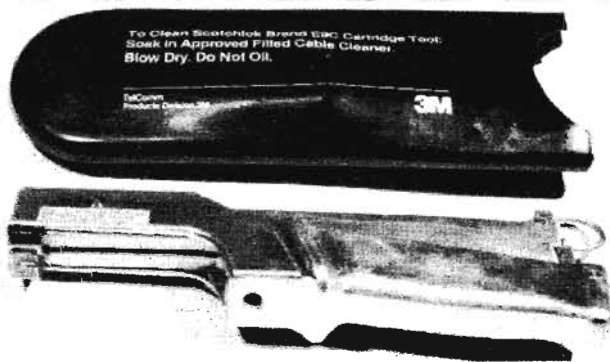

1172478

NETWORK SERVICES

TOOLS

BUILDING JANITORIAL

AUTOMOTIVE

FORMS/OFFICE SUPPLIES

GENERAL

DATA VOICE

PRODUCT IDENTIFIER		DESCRIPTION					
ITEM NUMBER	ORD. MULT.	SELL UNIT	STD. PKG. STOCK AVAILABILITY / PA	LEAD TIME	MIN. ORD.	A	C

900218215 TOOL CRIMPING E9E SCOTCHLOCK
 1229286 1 EA IL IN MI OH WI E
 12 12 12 12 12

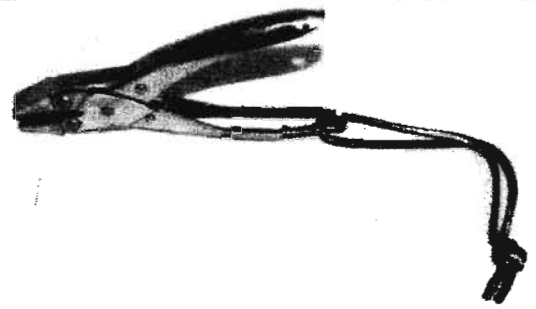

1229286

280013152 TOOL CRIMPING HCT611 AC 084468
 N EA 1 2 1 E

280013145 TOOL CRIMPING HCT659 AC 036525 HEX
 N EA 1 2 1 E
 Hughes.

280017666 TOOL CRIMPING HT-1921 WALDOM
 N EA 1 2 2 E

260357322 TOOL CRIMPING MODULAR RJ PLUGS
 1952705 1 EA IL IN MI OH WI E
 12 12 12 12
 PA1550.

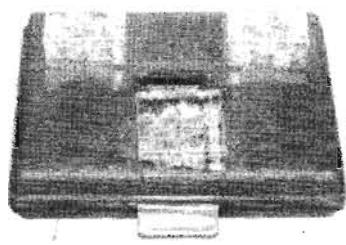

1952705

260353826 TOOL CRIMPING MODULAR RJ PLUGS
 1952184 1 EA IL IN MI OH WI E
 12 12 12

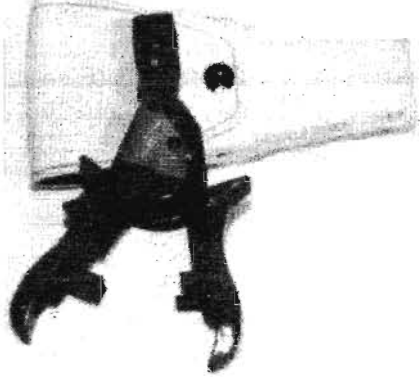

1952184

DISTRIBUTION SERVICES

NETWORK SERVICES

TOOLS

BUILDING JANITORIAL

AUTOMOTIVE

FORMS/OFFICE SUPPLIES

GENERAL

DATA VOICE

PRODUCT IDENTIFIER		DESCRIPTION				
ITEM NUMBER	ORD. MULT.	SELL UNIT	STD. PKG. STOCK AVAILABILITY / PA	LEAD TIME	MIN. ORD.	A C
260440961		TOOL	CRIMPING WT201A			
N		EA	1	3	25	

TOOL NUMBERED

280037565		TOOL	8 67F5795			
N		EA	1	1	22	E
Small insulated screwdriver used for adjusting potentiometers on various radio, C.O. & carrier equipment.						

100750397		TOOL	45B WRENCH SOCKET			
1155978	1	EA	IL IN MI OH WI			E
5/16IN. DISCONTINUE AND REPLACED BY NUTDRIVER SET 7PC STD UPON STOCK DEPLETION						



1155978

100750421		TOOL	48 WRENCH SOCKET			
N		EA	1	3	1	E
Combination 7/32in and 1/4in hex double-end socket wrench and screwdriver for general use, BSP 074-269-128.						

100750462		TOOL	63 WRENCH TRIPLE			
N		EA	1	1	1	E
Used for removing shells #25, 69, 72, & 100 type relays.						

100750587		TOOL	102 WRENCH SOCKET 3/8IN			
1164772	1	EA	IL IN MI OH WI			E
12 12 12 12 12						



1164772

100750678		TOOL	129B WRENCH			
1182907	1	EA	IL IN MI OH WI			E
DISCONTINUE UPON STOCK DEPLETION						



1182907

100750744		TOOL	139B LEVELER COIN			
2755348	1	EA	IL IN MI OH WI			E
12 12 12 12 12						

To determine the level of coins in pay station coin receptacles.



2755348

PRODUCT IDENTIFIER		DESCRIPTION				
ITEM NUMBER	ORD. MULT.	SELL UNIT	STD. PKG. STOCK AVAILABILITY / PA	LEAD TIME	MIN. ORD.	A C
100750850		TOOL	206 SCREWDRIVER OFFSET			
1275222	1	EA	IL IN MI OH WI			E
12 12 12 12 12						
30 degree offset screwdriver for use on flat type relays, BSP 074-256-115, BSP 074-103-101.						



1275222

100750868		TOOL	207 SCREWDRIVER OFFSET			
1275248	1	EA	IL IN MI OH WI			E
12 12 12 12 12						
90 degree offset screwdriver, BSP 074-256-115.						



1275248

102450574		TOOL	216C CAN WRENCH			
2602904	1	EA	IL IN MI OH WI			E
12 12 12 12 12						
A 3/8in and 7/16in Hex double-end socket wrench. Use for connecting wires to binding posts and protectors, BSP 074-269-129.						



2602904

100751098		TOOL	245 WRENCH 3/8INX7/16IN			
1275404	1	EA	IL IN MI OH WI			E
12 12 12 12 12						



1275404

997991575		TOOL	319B CK06305			
1275727	1	EA	IL IN MI OH WI			E
12 12 12 12 12						
Lamp cap and number plate extractor, 5in X 2 1/8in, BSP 074-214-139.						

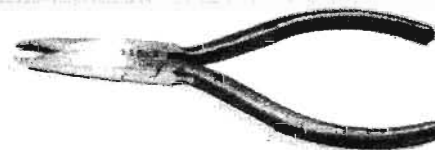

1275727

100751775		TOOL	344 OFFSET SCREWDRIVER			
N		EA	1	1	1	E
For general use, BSP 074-256-115.						



100751775

DISTRIBUTION SERVICES

NETWORK SERVICES

TOOLS

BUILDING JANITORIAL

AUTOMOTIVE

FORMS/OFFICE SUPPLIES

GENERAL

DATA VOICE

TOOL NUMBERED

PRODUCT IDENTIFIER		DESCRIPTION						
ITEM NUMBER	ORD. MULT.	SELL UNIT	STD. PKG. STOCK AVAILABILITY / PA	LEAD TIME	MIN. ORD.	WI	A	

100751940 TOOL 360A CORD TIP RED
 1275925 1 EA IL IN MI OH WI E
 12 12 12 12 12
 Socket type cord tip with red shell, for testing tools with pin terminals. Used in step by step offices, BSP 074-260-112.



1275925

100751957 TOOL 360B CORD TIP BLACK
 1275941 1 EA IL IN MI OH WI E
 12 12 12 12 12
 Spring adjuster used in step by step offices. BSP 074-260-112.

100751965 TOOL 360C CHUCK SPRING WHITE
 N EA 1 3 1 E
 Used for test purposes in connection with tools provided with pin terminals. BSP 074-260-112.

100752005 TOOL 365 CLIP TEST EQUIPMENT
 N EA 1 3 1 E

100752096 TOOL 373D BURNISHER HANDLE
 1276048 1 EA IL IN MI OH WI E
 12 12 12 12 12
 Holder for contact burnishers. Provides space for storing Tool 374 A, B or C and a wide-core bristle brush, BSP 074-217-110.

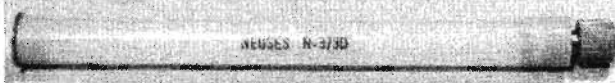

1276048

100752104 TOOL 374A BURNISHER BLADE
 1276063 1 EA IL IN MI OH WI E
 12 12 12 12 12
 Contact burnisher blade for Tool 373D (1276048), 5in x 15/64in, BSP 074-113-101.



1276063

100752112 TOOL 374B BURNISHER BLADE
 N EA 1 3 1 E
 Contact burnisher blade for Tool 373D (1276048), 5in x 15/64in.

100752120 TOOL 374C BLADE CLEANING
 N EA 1 3 1 E
 For burnishing key and jack contacts, BSP 074-217-110. DISCONTINUE UPON STOCK DEPLETION



100752120

PRODUCT IDENTIFIER		DESCRIPTION						
ITEM NUMBER	ORD. MULT.	SELL UNIT	STD. PKG. STOCK AVAILABILITY / PA	LEAD TIME	MIN. ORD.	WI	A	

100752146 TOOL 376A MIRROR A143133
 1276162 1 EA IL IN MI OH WI E
 12 12 12 12 12
 A dental mirror for 200, 206 selectors and 197, 18 switches. 6 3/4in long, BSP 074-238-125.



1276162

100752260 TOOL 388A WRENCH
 1276220 1 EA IL IN MI OH WI E
 12 12 12 12 12
 DISCONTINUE UPON STOCK DEPLETION



1276220

101204485 TOOL 411C TEST PROBE
 N EA 1 3 1 E
 Test pick for testing oscillator circuits, BSP 074-260-112. DISCONTINUE UPON STOCK DEPLETION



101204485

100752526 TOOL 415B ADJUSTER
 1276329 1 EA IL IN MI OH WI E
 12 12 12 12 12
 Spring adjuster for use on 197, 198 switches and SxS relays, BSP 074-202-119, BSP 074-117-101. DISCONTINUE UPON STOCK DEPLETION

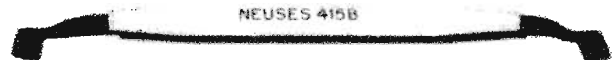

NEUSES 415B

1276329

100752534 TOOL 416B ADJUSTER
 1276345 1 EA IL IN MI OH WI E
 12 12 12 12 12
 Spring adjuster for 197, 198, 211 and 212 line and out trunk switches, BSP 074-202-119. DISCONTINUE UPON STOCK DEPLETION

100752542 TOOL 417A WRENCH
 1276386 1 EA IL IN MI OH WI E
 12 12 12 12 12
 3/4in and 3/8in Hex open double-end flat wrench, BSP 074-117-101, BSP 074-269-123.



1276386

100752559 TOOL 418A WRENCH
 1276402 1 EA IL IN MI OH WI E
 12 12 12 12 12
 5/16in and 7/32in open double-end flat wrench, BSP 074-269-123, BSP 074-117-101.

DISTRIBUTION SERVICES
 NETWORK SERVICES
TOOLS
 BUILDING JANITORIAL
 AUTOMOTIVE
 FORMS/OFFICE SUPPLIES
 GENERAL
 DATA VOICE

PRODUCT IDENTIFIER DESCRIPTION

ITEM NUMBER	ORD. MULT.	SEL. UNIT	STD. PKG. STOCK AVAILABILITY / PA	LEAD TIME	MIN. ORD.	A C
-------------	------------	-----------	-----------------------------------	-----------	-----------	-----

100752567 TOOL 419A TEST CONNECTOR
 1276428 1 EA IL IN MI OH WI E
 12 12 12 12 12
 Used for A and B type sequence switches, 157 interrupters and relays, BSP 074-118-101, BSP 074-208-131.

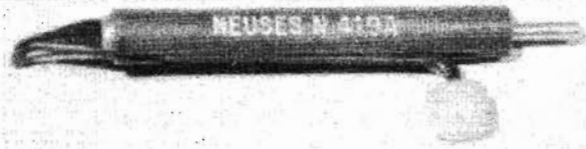

1276428

100752575 TOOL 422A SCREWDRIVER OFFSET
 N EA 1 5 1 E
 Used to maintain #111, 122, & 125 relays.

100752583 TOOL 423A SCREWDRIVER OFFSET
 N EA 1 1 1 E
 Used to maintain #111, 122, & 125 relays.

100752781 TOOL 448A POLE FRAME
 1164616 1 EA IL IN MI OH WI E
 12 12 12 12 12



1164616

100753045 TOOL 474A WRENCH OFFSET
 N EA 1 3 1 E
 3/16in x 1/4in double-end offset wrench for use on 50A drives, 218 and flat type relays, BSP 074-269-118.



100753045

100753060 TOOL 476A WRENCH SOCKET HEX
 1276683 1 EA IL IN MI OH WI E
 12 12 12 12 12
 3/16in hex offset for 197 and 198 switches, BSP 074-269-130.

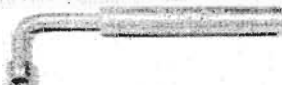

1276683

996705653 TOOL 485A PLIERS CK07665
 1276725 1 EA IL IN MI OH WI E
 12 12 12 12 12
 A smooth jaw long nose pliers, BSP 074-247-127.

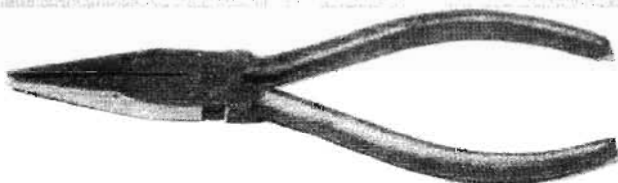

1276725

PRODUCT IDENTIFIER DESCRIPTION

ITEM NUMBER	ORD. MULT.	SEL. UNIT	STD. PKG. STOCK AVAILABILITY / PA	LEAD TIME	MIN. ORD.	A C
-------------	------------	-----------	-----------------------------------	-----------	-----------	-----

997991526 TOOL 486A OIL CAN CK7666
 2678342 1 EA IL IN MI OH WI E
 12 12 12 12 12
 DISCONTINUE UPON STOCK DEPLETION



2678342

100753466 TOOL 513A FIBER TUBE
 N EA 1 3 1
 Consists of a fiber tube with metal point. Use with a W2BJ cord and 47B plug.

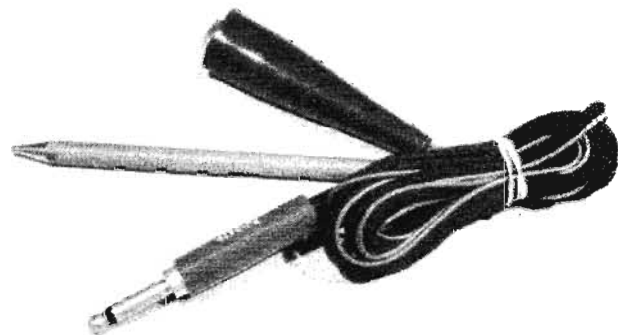

100753466

100753474 TOOL 514C WRENCH STRAP
 N EA 1 27 1 E

100753623 TOOL 528A PICK SLOT CLEANER
 1215053 1 EA IL IN MI OH WI E
 12 12 12 12 12
 For removing foreign material from locks associated with coin telephone, BSP 506-100-103.

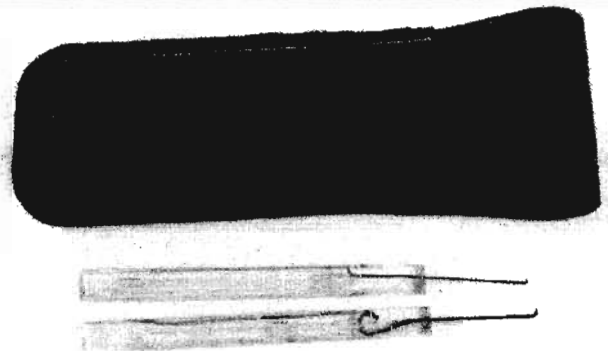

1215053

DISTRIBUTION SERVICES

NETWORK SERVICES

TOOLS

BUILDING JANITORIAL

AUTOMOTIVE

FORMS/OFFICE SUPPLIES

GENERAL

DATA VOICE

TOOL NUMBERED

PRODUCT IDENTIFIER		DESCRIPTION					
ITEM NUMBER	ORD. MULT.	SELL UNIT	STD. PKG. STOCK AVAILABILITY / PA	LEAD TIME	MIN. ORD.	A	C
100753698		TOOL	534D	ADJUSTER SPRING			
N		EA	1	12	1	E	
Used on switches and relays.							
100753714		TOOL	534F	ADJUSTER SPRING			
N		EA	1	12	1	E	
Used on switches and relays.							
100753714							
100753805		TOOL	541A	WRENCH			
N		EA	1	3	1	E	
1/4in double-end box wrench, BSP 074-269-118, BSP 074-128-101.							
100753813		TOOL	544A	WRENCH			
N		EA	1	1	1	E	
100753904		TOOL	553A	EXTRACTOR LAMP			
1277228	1	EA		IL IN MI OH WI			E
				12 12 12 12 12			
Lamp extractor for removing switchboard lamps, BSP 074-214-139.							
1277228							
100754027		TOOL	583A	SCREWDRIVER OFFSET			
1277301	1	EA		IL IN MI OH WI			E
				12 12 12 12 12			
Ninety degree, for use on No. 6 screws, BSP 074-235-109.							
1277301							
100754035		TOOL	564A	SCREWDRIVER OFFSET			
N		EA	1	1	1	E	
Forty-five degree offset, use on No. 6 screws.							
100754035							
100754563		TOOL	610B	SCREWDRIVER			
N		EA	1	1	1	E	
100754688		TOOL	624A				
1277483	1	EA		IL IN MI OH WI			E
				12 12 12 12 12			
For connecting AF, AG and AJ terminal relay windings. BSP 074-208-131.							

PRODUCT IDENTIFIER		DESCRIPTION					
ITEM NUMBER	ORD. MULT.	SELL UNIT	STD. PKG. STOCK AVAILABILITY / PA	LEAD TIME	MIN. ORD.	A	C

100754696		TOOL	624B				
1277509	1	EA		IL IN MI OH WI			E
				12 12 12 12 12			
1277509							
100755040		TOOL	655B	BURNISHER			
N		EA	1	1	1	E	
100755123		TOOL	662A	ADJUSTER RELAY			
N		EA	1	1	1	E	
For adjusting lugs of wire spring multi-contact relays.							
100755123							
102974805		TOOL	710A	MOUNTING COMPLETE			
N		EA	1	3	1	E	
102974805							
103059077		TOOL	710A1	MOUNTING BASE			
N		EA	1	3	1	E	
103059085		TOOL	710A2	MOUNTING CLAMP			
N		EA	1	3	1	E	
103059093		TOOL	710A3	MOUNTING SWIVEL BAR			
N		EA	1	3	1	E	
103239893		TOOL	710A4				
N		EA	1	3	1	E	
103059127		TOOL	710A6	MOUNTING SWIVEL BAR & KNOB			
N		EA	1	3	1	E	
103239901		TOOL	710A7A	MOUNTING TUBE/TOOL CLAMP			
N		EA	1	3	1	E	
100755511		TOOL	714B				
N		EA	1	3	1	E	
Used to terminate conductors on 66A1 connecting blocks. For additional blades See: P46L211 Blade. BSP 074-226-119.							
101285344		TOOL	714E2				
N		EA	1	2	1	E	

PRODUCT IDENTIFIER DESCRIPTION

ITEM	ORD.	SELL	STD. PKG.	LEAD TIME	MIN.	A
NUMBER	MULT.	UNIT	STOCK AVAILABILITY / PA	ORD.	C	

100755594 TOOL 719A KEY
 1277863 1 EA IL IN MI OH WI E
 12 12 12 12 12
 For releasing the housing and door locking mechanisms of single slot coin telephone sets after first opening the locks with keys, BSP 506-101-201, BSP 506-100-103.

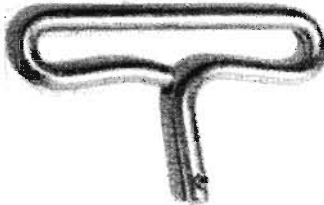

1277863

101218352 TOOL 723B
 N EA 1 3 1 E

100755636 TOOL 724A WIRE REMOVER
 1824326 1 EA IL IN MI OH WI E
 12 12 12 12 12
 To remove wire out of quick connect clip type terminals in No. 66 or 72 type connecting blocks, BSP 074-151-101, BSP 074-253-124.



1824326

100755768 TOOL 737A PROBE TEST
 N EA 1 1 1 E

104012018 TOOL 756C5 WIRE INSERTION
 8412197 1 EA IL IN MI OH WI E
 12 12 12 12 12



8412197

105611545 TOOL 756C5-1
 N EA 1 3 1 E

101541258 TOOL 768A BLOCKING TOOL
 2781922 1 EA IL IN MI OH WI E
 12 12 12 12 12

Plastic, wedge-type blocking tool, BSP 074-205-121. DISCONTINUE UPON STOCK DEPLETION

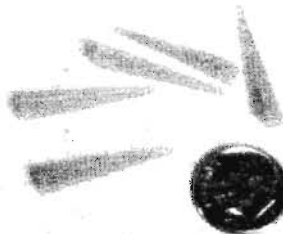

2781922

PRODUCT IDENTIFIER DESCRIPTION

ITEM	ORD.	SELL	STD. PKG.	LEAD TIME	MIN.	A
NUMBER	MULT.	UNIT	STOCK AVAILABILITY / PA	ORD.	C	

102333671 TOOL 787A DIME CLEAR-OUT
 2136622 1 EA IL IN MI OH WI E
 12 12 12 12 12
 Used to free wedged coins in lower half of single slot coin phone chutes, BSP 506-100-103.



2136622

102167467 TOOL 788A1
 N EA 1 2 1 E
 Handle for Tool 797A (PID102344066).



102167467

102648839 TOOL 788J1 IMPACT
 N EA 1 3 1 E

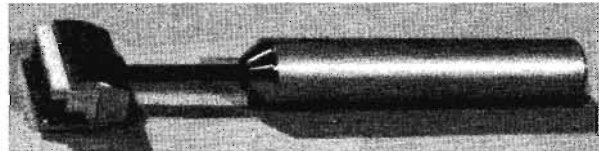

102648839

102655495 TOOL 788K1 HOLDER CONDUCTOR
 5522581 1 EA IL IN MI OH WI E
 12 12 12 12 12

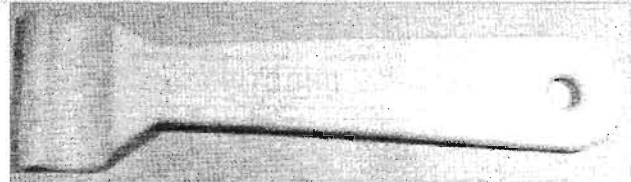

5522581

103765665 TOOL 809B EXTRACTING
 N EA 1 3 1 E

260386669 TOOL 814A SKEW ALIGNMENT
 N EA 1 2 1 E

102950003 TOOL 829A
 N EA 1 3 1 E

103176400 TOOL 840A REMOVER
 1920165 1 EA IL IN MI OH WI E
 12 12 12

Tool designed to remove half taps from 710 modules.



1920165

DISTRIBUTION SERVICES

NETWORK SERVICES

TOOLS

BUILDING JANITORIAL

AUTOMOTIVE

FORMS/OFFICE SUPPLIES

GENERAL

DATA VOICE

DISTRIBUTION SERVICES

TOOL NUMBERED

PRODUCT IDENTIFIER DESCRIPTION

ITEM NUMBER	ORD. MULT.	SELL UNIT	STD. PKG. STOCK AVAILABILITY / PA	LEAD TIME	MIN. ORD.	A C
-------------	------------	-----------	-----------------------------------	-----------	-----------	-----

103289765 TOOL 945A
 1956326 1 EA IL IN MI OH WI 12 12 12 12 12 E

NETWORK SERVICES

103551511 TOOL 945A1
 N EA 1 3 1 E

103551529 TOOL 945A2
 N EA 1 14 1 E

103551537 TOOL 945A3
 N EA 1 3 1 E

TOOLS

260353446 TOOL 950C
 1951889 1 EA IL IN MI OH WI 12 12 12 12 12 E

Consists mainly of a handle, wire cutters, a wire insertion blade and a wire remover, for cutting distribution frame wires. For head replacement use Bit Replacement 950C (1951897).



1951889

BUILDING JANITORIAL

104030523 TOOL 994A
 N EA 1 2 1 E

AUTOMOTIVE

280022765 TOOL 4053PM REMOVAL

ITEM NUMBER	ORD. MULT.	SELL UNIT	STD. PKG. STOCK AVAILABILITY / PA	LEAD TIME	MIN. ORD.	A C
-------------	------------	-----------	-----------------------------------	-----------	-----------	-----

Used to remove 4005 DPM Modules from any other module.

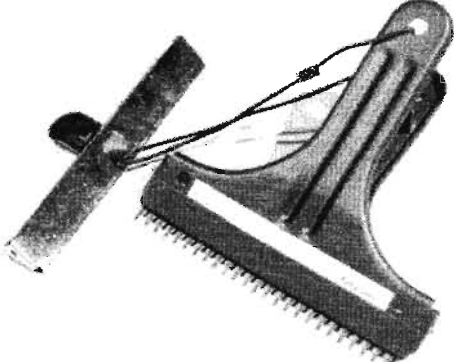

1922237

GENERAL

900198052 TOOL 4055 HAND IMPACT INSERTION

ITEM NUMBER	ORD. MULT.	SELL UNIT	STD. PKG. STOCK AVAILABILITY / PA	LEAD TIME	MIN. ORD.	A C
-------------	------------	-----------	-----------------------------------	-----------	-----------	-----

Used to terminate jumper wires on 3M modules in 3M cross connect cabinets.

DATA VOICE

PRODUCT IDENTIFIER DESCRIPTION

ITEM NUMBER	ORD. MULT.	SELL UNIT	STD. PKG. STOCK AVAILABILITY / PA	LEAD TIME	MIN. ORD.	A C
-------------	------------	-----------	-----------------------------------	-----------	-----------	-----

300052677 TOOL 4055HT ORANGE
 1191759 1 EA IL IN MI OH WI 12 12 12 12 12 E

Designed for use in rework applications where distribution counts are half-tapped to provide continuous service while counts are being changed.

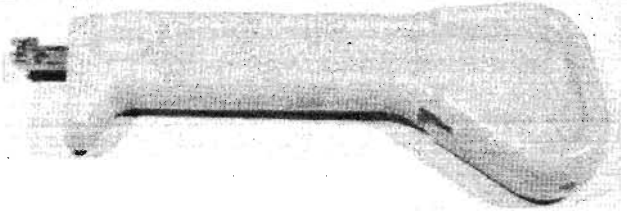

1191759

TOOL POUCH

SEE POUCH.

TOOL WIRE UNWRAP

900375312 TOOL WIRE UNWRAP 509436

ITEM NUMBER	ORD. MULT.	SELL UNIT	STD. PKG. STOCK AVAILABILITY / PA	LEAD TIME	MIN. ORD.	A C
-------------	------------	-----------	-----------------------------------	-----------	-----------	-----

Hand held left hand unwrapping tool used on 26 thru 32 gauge wire.



900375312

280020926 TOOL WIRE UNWRAP 515666

ITEM NUMBER	ORD. MULT.	SELL UNIT	STD. PKG. STOCK AVAILABILITY / PA	LEAD TIME	MIN. ORD.	A C
-------------	------------	-----------	-----------------------------------	-----------	-----------	-----

A manual unwrapping tool 30AWG includes Bit 511465. Term hole diameter .040 depth 1in.

400284527 TOOL WIRE UNWRAP CK16450 L1

ITEM NUMBER	ORD. MULT.	SELL UNIT	STD. PKG. STOCK AVAILABILITY / PA	LEAD TIME	MIN. ORD.	A C
-------------	------------	-----------	-----------------------------------	-----------	-----------	-----

400722179 TOOL WIRE UNWRAP CK20551 L2

ITEM NUMBER	ORD. MULT.	SELL UNIT	STD. PKG. STOCK AVAILABILITY / PA	LEAD TIME	MIN. ORD.	A C
-------------	------------	-----------	-----------------------------------	-----------	-----------	-----

Used to unwrap solderless wrapped connections in congested wiring areas, BSP 074-263-130, BSP 074-850-101.



2762526

400751376 TOOL WIRE UNWRAP CK20827 L1

ITEM NUMBER	ORD. MULT.	SELL UNIT	STD. PKG. STOCK AVAILABILITY / PA	LEAD TIME	MIN. ORD.	A C
-------------	------------	-----------	-----------------------------------	-----------	-----------	-----

Used to remove solderless wrapped connections of 22, 24 and 26 gauge wire, BSP 074-263-130.



2757443

PRODUCT IDENTIFIER		DESCRIPTION				
ITEM NUMBER	ORD. MULT.	SELL UNIT	STD. PKG. STOCK AVAILABILITY / PA	LEAD TIME	MIN. ORD.	A C

TOOL WIRE WRAP

260347901 TOOL WIRE WRAP 27600 AD8

1951087 1 EA E
 This is a battery powered wire wrapping tool with rechargeable battery for 22-30AWG. Used for faster wire wrapping capability on large projects. See Bit Wirewrap 30 Gauge SB30MSH-B.

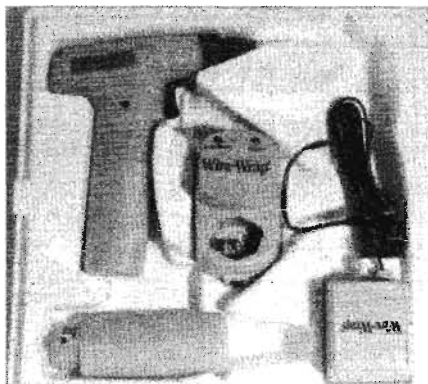

260347901

280025479 TOOL WIRE WRAP BW520

N EA 1 2 1 E

402168090 TOOL WIRE WRAP CK16363 L3

1135467 1 EA E
 IL IN MI OH WI
 12 12 12 12 12
 A hand tool for making solderless wrapped connections to 22-26GA wire. Use with Bit Wirewrap 22-24 Gauge CK16734 L1 (1110429) & Sleeve Wirewrap 22-24 Gauge CK20963 L2 (2786285), BSP 074-269-113.



1135467

402982458 TOOL WIRE WRAP CK22681 L1

1203877 1 EA E
 IL IN MI OH WI
 12 12 12 12 12
 Wire wrapping tool for 22 and 24 gauge wire when only a few connections are made, BSP 074-136-101.



1203877

280011784 TOOL WIRE WRAP HW-30

N EA 1 2 1 E
 Used to wrap wire around grids.

PRODUCT IDENTIFIER		DESCRIPTION				
ITEM NUMBER	ORD. MULT.	SELL UNIT	STD. PKG. STOCK AVAILABILITY / PA	LEAD TIME	MIN. ORD.	A C

280017922 TOOL WIRE WRAP-UNWRAP WSU-30

N EA 1 2 1 E
 A tool used for wrapping and unwrapping wires around grids.

TORCH

400280319 TORCH ACETYLENE G CA07932

1278309 1 EA E
 Torch used with associated equipment, when splicing and maintaining cable, e/w MC Regulator, used with Stem Torch S23 (6148320), BSP 081-330-105.

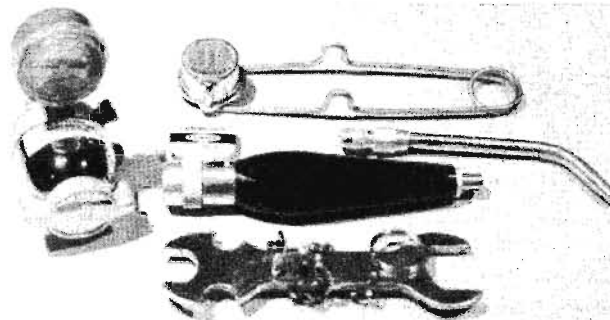

400280319

280024787 TORCH ASSEMBLY UNIWELD KCA 110

N EA 1 3 1 E

401172242 TORCH PROPANE FH2605

N EA 1 6 5 E

TP NUMBERED PARTS

520757659 TP 75765 HOOK

3731646 1 EA E
 DISCONTINUE, ORDER NON STOCK UPON STOCK DEPLETION

521137562 TP113756 MAINTENANCE KIT

6142240 1 EA E
 IL IN MI OH WI
 12 12
 DISCONTINUE, ORDER NON STOCK UPON STOCK DEPLETION

TRACKER

280019456 TRACKER II 501

N EA 1 2 1 E

DISTRIBUTION SERVICES

NETWORK SERVICES

TOOLS

BUILDING JANITORIAL

AUTOMOTIVE

FORMS/OFFICE SUPPLIES

GENERAL

DATA VOICE

DISTRIBUTION SERVICES

TRAY

PRODUCT IDENTIFIER		DESCRIPTION					
ITEM NUMBER	ORD. MULT.	SELL UNIT	STD. PKG. STOCK AVAILABILITY / PA	LEAD TIME	MIN. ORD.	A	C

TRAY

400280772 TRAY CANVAS B CA7755

1279323 1 EA E
A canvas tray 18in L x 12in W x 6in D, for use in carrying tools and material, e/w ropes and snaps to fasten on messenger when working on an aerial platform, BSP 081-020-130.

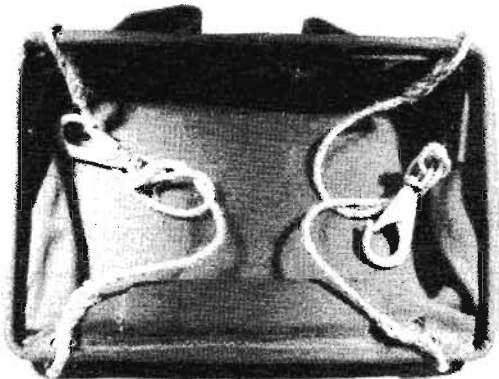

400280772

280037623 TRAY SOLDERING TPW 3

N EA 1 2 6 E

NETWORK SERVICES

TOOLS

BUILDING JANITORIAL

AUTOMOTIVE

FORMS/OFFICE SUPPLIES

GENERAL

DATA VOICE

TUBE

401160676 TUBE FOR SHIELD MANHOLE D

1141911 1 EA E
A thornproof inflatable rubber tube for Shield Manhole D (6146787), 26in x 1 1/4in to 1 3/8in, BSP 081-215-100.

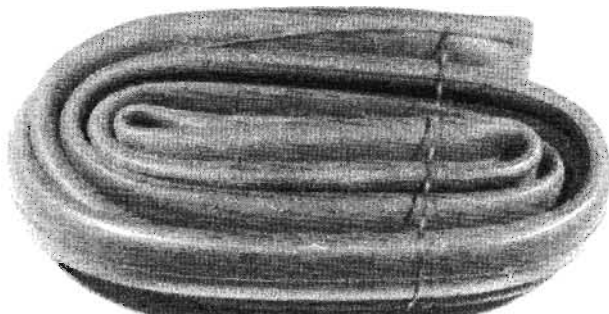

401160676

400280830 TUBE INSERT CK14440 L67

N EA 1 5 19 E

TURBOTORCH

280013137 TURBOTORCH STK-9 AC 052424

N EA 1 2 1 E

PRODUCT IDENTIFIER		DESCRIPTION					
ITEM NUMBER	ORD. MULT.	SELL UNIT	STD. PKG. STOCK AVAILABILITY / PA	LEAD TIME	MIN. ORD.	A	C

TWEEZER

996751640 TWEEZER CK08511

1278028 1 EA E
For use by PBX and teletype installers, repairmen, and central office force, BSP 074-260-145.



996751640

UMBRELLA

400282554 UMBRELLA D CA08092

1118273 1 EA E
For use in inclement weather by outside plant forces.

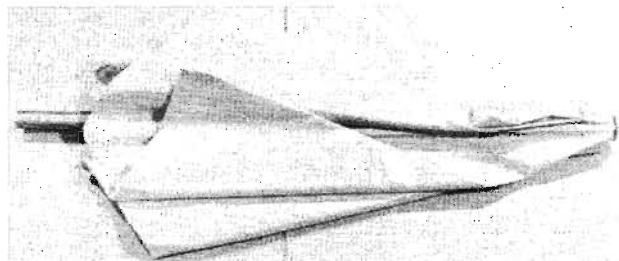

400282554

UNIT

104028758 UNIT FAN 2A

N EA 1 4 1 E

260366265 UNIT ISDN TEST INTERFACE TPI 1946A

1955088 1 EA IL IN MI OH WI E
12

VEST

002047785 VEST SAFETY W/YELLOW STRIPE

5266726 1 EA E

PRODUCT IDENTIFIER		DESCRIPTION				
ITEM NUMBER	ORD. MULT.	SELL UNIT	STD. PKG. STOCK AVAILABILITY / PA	LEAD TIME	MIN. ORD.	A C

WARMER

260341334 WARMER PROPANE BOTTLE

1949677 1 EA E



260341334

WEDGE

402028088 WEDGE LEVELING LADDER B

N EA 1 4 1 E

CA08889. A wedge shaped hardwood block used to provide level footing for extension ladders on uneven ground, BSP 460-300-108.

WEIGHT

401358437 WEIGHT THROW E/W 1IN LOOP

1332916 1 EA E



401358437

WHEEL MEASURING

280002379 WHEEL MEASURING 415

N EA 1 1 1 E

Has a 4ft circumference plated steel disc wheel calibrated to 1/2in. on one side and 1/2 of 1/10ft on the other. Automatically records up to 100,000ft for measuring distance.

PRODUCT IDENTIFIER		DESCRIPTION				
ITEM NUMBER	ORD. MULT.	SELL UNIT	STD. PKG. STOCK AVAILABILITY / PA	LEAD TIME	MIN. ORD.	A C

280002478 WHEEL MEASURING 623

N EA 1 1 1 E

Designed for heavy duty, long distance measuring up to 100,000ft. All steel construction, 6ft circumference wheel, built-in stand. Weight 7 1/2lbs.

WIRE FISH

400287488 WIRE FISH 1/4IN X 1/16IN X 100FT

N EA 1 2 10 E

CA06508.

400287496 WIRE FISH 1/4IN X 1/16IN X 200FT

N EA 1 2 10 E

CA06508.

401169529 WIRE FISH 1/8IN X 1/10IN X 150FT

N EA 1 2 10 E

CA06508.

401352398 WIRE FISH 1/8IN X 1/16IN X 50FT

N EA 1 4 10 E

With ball.

400287462 WIRE FISH 1/8IN X 1/16IN X 100FT

N EA 1 2 10 E

CA06508.

001016534 WIRE FISH 1/8IN X 1/16IN X 100FT

N EA 1 4 6 E

With ball.

001016542 WIRE FISH 1/8IN X 1/16IN X 200FT

N EA 1 2 10 E

With ball.

400287470 WIRE FISH 1/8IN X 1/16IN X 200FT

N EA 1 2 10 E

CA06508. Used by Instalation, Building and Construction Department forcesfor running wires thru conduit and hollow spaces.

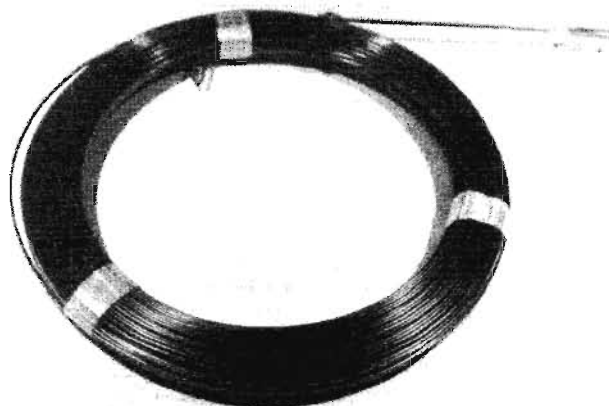

400287470

401352414 WIRE FISH 30 INCH

N EA 1 3 1 E

DISTRIBUTION SERVICES
 NETWORK SERVICES
 TOOLS
 BUILDING JANITORIAL
 AUTOMOTIVE
 FORMS/OFFICE SUPPLIES
 GENERAL
 DATA VOICE

DISTRIBUTION SERVICES

WIRE FISH

PRODUCT IDENTIFIER		DESCRIPTION							
ITEM NUMBER	ORD. MULT.	SELL UNIT	STD. PKG. STOCK AVAILABILITY / PA	LEAD TIME			MIN. ORD.	A C	
401168174 WIRE FISH B 1/4IN CA08489									
6173781	1	EA	IL 12 IN 12 MI OH WI 12 12					E	



6173781

NETWORK SERVICES

TOOLS

BUILDING JANITORIAL

AUTOMOTIVE

FORMS/OFFICE SUPPLIES

GENERAL

DATA VOICE

400467247 WIRE FISH B 1/8IN REEL CA08489								
1183731	1	EA	IL 12 IN 12 MI OH WI 12 12					E
Unbreakable plastic reel, built-in winder for paying out and rewinding tape, equipped with 100 feet of 1/8in fish tape.								

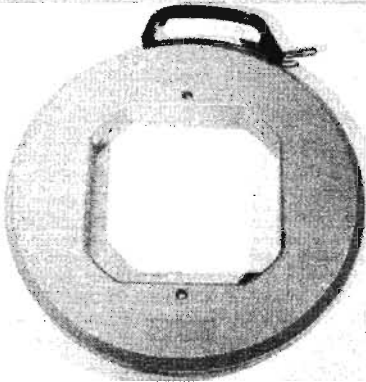

8413252

402942270 WIRE FISH B 1/8IN X .06IN X 200FT								
8413252	1	EA	IL 12 IN 12 MI OH WI 12 12					E
Includes winder. For installation use.								

WIRE FISH LEADER

400155339 WIRE FISH LEADER CA07275									
1199661	1	EA							E
The fish wire ball and leads are for attachment to the end of 1/8in x 1/16in fish wire to facilitate fishing in crowded ducts, around bends, etc.									
									
400155339									

WRENCH

260439914 WRENCH 3/8IN BUTTERFLY AIR IMPACT #812								
N	EA	1	2			1		
Air impact tool parts.								

PRODUCT IDENTIFIER		DESCRIPTION							
ITEM NUMBER	ORD. MULT.	SELL UNIT	STD. PKG. STOCK AVAILABILITY / PA	LEAD TIME			MIN. ORD.	A C	

401041132 WRENCH ADJUSTABLE 6IN R1542								
1416800	1	EA	IL 12 IN 12 MI OH WI 12 12					E
A 6in long wrench with a maximum opening of 15/16in. For general use, BSP 074-269-116.								

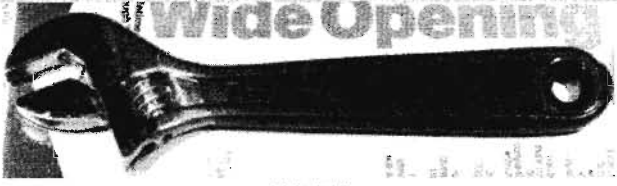

1416800

401050901 WRENCH ADJUSTABLE 10IN R4199								
1416826	1	EA	IL 12 IN 12 MI OH WI 12 12					E
A 10in long wrench with a maximum opening of 15/16in.								



1416826

401041140 WRENCH ADJUSTABLE 12IN R1543								
1293969	1	EA	IL 12 IN 12 MI OH WI 12 12					E
A 12in Monkey Wrench for general use.								

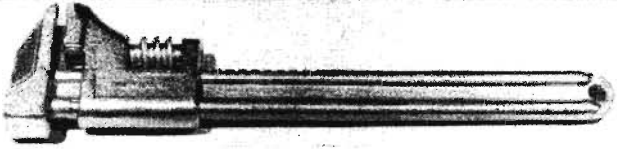

1293969

280013111 WRENCH ADJUSTABLE AC112C								
N	EA	6	2			6		E

280039470 WRENCH AIR IMPACT IR212								
N	EA	1	3			1		E
Used as an alternative to the Ajax 976 when an entire kit is not needed.								



400494431 WRENCH ALLEN 1/8IN								
N	EA	1				1		E
DISCONTINUE AND REPLACED BY WRENCH ALLEN KIT UPON STOCK DEPLETION.								

900240466 WRENCH ALLEN 1/16IN								
1227975	1	EA	IL 12 IN 12 MI OH WI 12 12					E
DISCONTINUE AND REPLACED BY WRENCH ALLEN KIT UPON STOCK DEPLETION.								

900240482 WRENCH ALLEN 3/32IN								
5159145	1	EA	IL 12 IN 12 MI OH WI 12 12					E
DISCONTINUE AND REPLACED BY WRENCH ALLEN KIT UPON STOCK DEPLETION.								

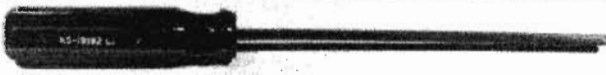
900240474 WRENCH ALLEN 5/64IN								
5159129	1	EA	IL 12 IN 12 MI OH WI 12 12					E
DISCONTINUE AND REPLACED BY WRENCH ALLEN KIT UPON STOCK DEPLETION.								

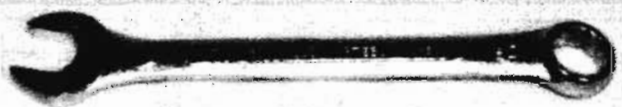
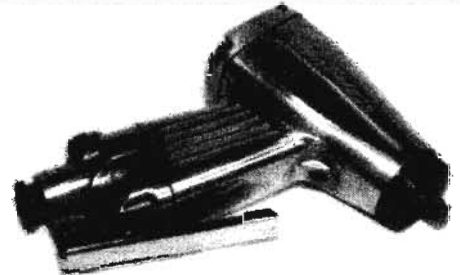
PRODUCT IDENTIFIER		DESCRIPTION						MIN.	A
ITEM NUMBER	ORD. MULT.	SELL UNIT	STD. PKG. STOCK AVAILABILITY / PA	LEAD TIME	MI	OH	WI	ORD.	C
900114836 WRENCH ALLEN HEX KEY 050									
1144295	1	EA	IL 12	IN 12	MI 12	OH 12	WI 12	E	
Blade size 1/16in X 3 3/4in. DISCONTINUE AND REPLACED BY WRENCH ALLEN KITUPON STOCK DEPLETION.									
900302555 WRENCH ALLEN T-HANDLE 1/8IN									
1293860	1	EA	IL 12	IN 12	MI 12	OH 12	WI 12	E	
 <p>1293860</p>									
996759718 WRENCH BOX 7/16IN X 1/2IN 8725									
1293902	1	EA	IL 12	IN 12	MI 12	OH 12	WI 12	E	
 <p>1293902</p>									
400288585 WRENCH CK19192 L1 6IN									
1293845	1	EA	IL 12	IN 12	MI 12	OH 12	WI 12	E	
For removing fasteners in the dome of KS14611 & KS16798 booths. May be used w/ fasteners on KS14125 & KS8164 booth blowers and KS16705 mounting, BSP 503-352-200, BSP 514-231-100.									
 <p>1293845</p>									
260375852 WRENCH CK19195 3 1/2IN									
1957712	6	EA	IL 12	IN 12	MI 12	OH 12	WI 12	E	
 <p>1957712</p>									
900162983 WRENCH COMBINATION 1160									
1294165	1	EA	IL 12	IN 12	MI 12	OH 12	WI 12	E	
Open and box end.									

PRODUCT IDENTIFIER		DESCRIPTION						MIN.	A
ITEM NUMBER	ORD. MULT.	SELL UNIT	STD. PKG. STOCK AVAILABILITY / PA	LEAD TIME	MI	OH	WI	ORD.	C
400957437 WRENCH COMBINATION 9/16IN D KIT									
1293928	1	EA	IL 12	IN 12	MI 12	OH 12	WI 12	E	
CA08381. For Kit Wrench D (1196402).									
 <p>1293928</p>									
300052750 WRENCH IMPACT 3/8IN AT03000									
6509729	1	EA	IL 12	IN 12	MI 12	OH 12	WI 12	E	
 <p>6509729</p>									
260362868 WRENCH IMPACT ELECTRIC IR8062 5/8IN									
N		EA	1		2		1	E	
QUICKCHANGE									
400288650 WRENCH LINEMANS B 13IN CA07389									
1199299	1	EA	IL 12	IN 12	MI 12	OH 12	WI 12	E	
A heat treated alloy steel wrench for use on pole line hardware.									
 <p>1199299</p>									
280003757 WRENCH MANHOLE B 8454									
N		EA	1		5		9	E	
Used in placing and removing the pentagonal head locking bolts for D and H manhole frames and covers, BSP 622-520-100.									
260406954 WRENCH MANHOLE COVER SOCKET G1375									
N		EA	1		4		1	E	
280019761 WRENCH OPEN END 1/2 X 5/16									
N		EA	1		2		1	E	
BSP 610-0996-001.									
280019753 WRENCH OPEN END 1/4 X 5/15									
N		EA	1		2		1	E	
BSP 024-0405-000.									
280019779 WRENCH OPEN END 3/8 X 7/16									
N		EA	1		2		1	E	
See Tool 245 Wrench (PID100751098), BSP 024-0405-000.									

DISTRIBUTION SERVICES
 NETWORK SERVICES
 TOOLS
 BUILDING JANITORIAL
 AUTOMOTIVE
 FORMS/OFFICE SUPPLIES
 GENERAL
 DATA VOICE

WRENCH

PRODUCT IDENTIFIER DESCRIPTION

ITEM NUMBER	ORD. MULT.	SELL UNIT	STD. PKG. STOCK AVAILABILITY / PA	LEAD TIME	MIN. ORD.	A C
-------------	------------	-----------	-----------------------------------	-----------	-----------	-----

996755278 WRENCH PIPE 14IN
 1152512 1 EA IL IN MI OH WI 12 12 12 12 E
 For use on pipes or other rounded surfaces where a gripping hold is required, has a moving head between jaws. For 1/4in to 1 1/2in diameter pipe.

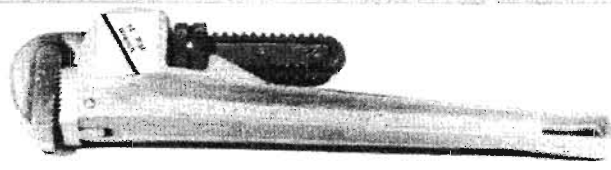

1152512

280014309 WRENCH PISTOL GRIP AIR IMPACT 3/8IN #828
 N EA 1 2 1 E
 Air impact tool parts.

400288718 WRENCH RATCHET B CA07511
 1294025 1 EA IL IN MI OH WI 12 12 12 12 E
 A tool developed to tighten or loosen the bolts used in the installation of the splice cases, T type cable terminals and used on C clamps with 7/16in diameter, BSP 081-330-130.

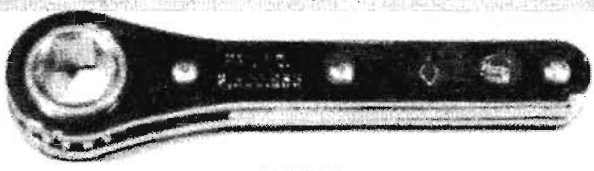

1294025

260387436 WRENCH RATCHET LINEMAN
 1967703 1 EA IL IN MI OH WI 12 12 12 12 E
 PN51901/948005.

400419164 WRENCH REGULATOR C CA07516
 1294041 1 EA IL IN MI OH WI 12 12 12 12 E
 Used on 1 3/16in, 11/16in and 1/8in openings on cylinder and hose connection nuts of pressure testing regulators, BSP 081-600-103.



1294041

280016700 WRENCH SET OPEN END 14 PIECE
 N EA 1 2 1 E
 Electronic 332B490.

900220278 WRENCH SOCKET 9/16IN X 2 5/16IN
 4416461 1 EA IL IN MI OH WI 12 12 12 12 E
 Snap-On Brand.

PRODUCT IDENTIFIER DESCRIPTION

ITEM NUMBER	ORD. MULT.	SELL UNIT	STD. PKG. STOCK AVAILABILITY / PA	LEAD TIME	MIN. ORD.	A C
-------------	------------	-----------	-----------------------------------	-----------	-----------	-----

400288759 WRENCH SOCKET BRACE BIT 1/4IN
 1294082 1 EA IL IN MI OH WI 12 12 12 12 E
 A solid shaft bit to fit in a Brace Ratchet (1168955) with a socket at one end, for removal of lag bolts from wood poles.



1294082

280013947 WRENCH SOCKET BRACE BIT 3/8IN
 N EA 1 2 1 E
 Deep socket, 400-288-783.

280003740 WRENCH SOCKET BRACE BIT 3/8IN
 N EA 1 2 1 E
 Normal, 400-288-775.

400288767 WRENCH SOCKET BRACE BIT 5/16IN
 1294108 1 EA IL IN MI OH WI 12 12 12 12 E
 A solid shaft bit to fit in a Brace Ratchet (1168955) with a socket at one end, for removal of lag bolts from wood poles.



1294108

280014960 WRENCH TORQUE 1/4IN 12263205
 N EA 1 4 1 E

260388137 WRENCH TORQUE 3/8IN DRIVE
 1964130 1 EA IL IN MI OH WI 12 12 12 12 E
 For tightening to the proper torque, bolts on splice closures & apparatus cases. Used with Kit Wrench D (1196402), BSP 081-420-103.
 REPLACEMENT FOR WRENCH TORQUE B.



1964130

300045721 WRENCH TORQUE 3/8IN #829
 N EA 1 2 1

DISTRIBUTION SERVICES

NETWORK SERVICES

TOOLS

BUILDING JANITORIAL

AUTOMOTIVE

FORMS/OFFICE SUPPLIES

GENERAL

DATA VOICE

NOTES

NOTES

SECTION 4 - BUILDING/JANITORIAL **MATERIAL INCLUDED**

- ☐ GENERAL BUILDING and JANITORIAL

We are concerned and value your ideas. Please contact the Ameritech Bell Group Catalog Department direct on (708) 248-8313 with questions, corrections and ideas.

Catalog Format

PRODUCT IDENTIFIER		DESCRIPTION				
ITEM	ORD.	SELL	STD. PKG.	LEAD TIME	MIN.	A
NUMBER	MULT.	UNIT	STOCK AVAILABILITY / PA	ORD.	C	

Stock Material

Product Identifier (PID)	Description	Shaded Area Highlights Stock Material				
260388194	HEADSET OPERATOR HSB343-9					
Item Number — 1964072	1 EA	IL	IN	MI	OH	WI
Std. Operating Environment or (GF) Grandfathered SOE — GF		04	04	04	04	04
Order Multiple		Plantronics Starset in-the-ear headset, quick disconnect, 2 prong connector, 10ft cord, black in color. Equivalent to H31-P10C. REPLACES HS0343-9 PID # 260324801.				
Sell Unit						
Long Description						
		Pattern Account (Under State) Designates Stock Availability				

Non-Stock Material

Product Identifier (PID)	Description	Lead Time	Minimum Order	Account Code
280027921	ASSEMBLY TEST PAIR PLUG	2	1	E
Non-Stock Material — N	EA			"E" = Expense Tool
Grandfathered SOE or (SOE) Std. Operating Environment — GF	1			
Sell Unit		Assembly includes bolts, talk block plug and pie plate, mounts in 3M cabinet. Plug e/w cord extends terminated cable pair on 3M module to talk block for testing purposes.		
Standard Package				
Long Description				

DISTRIBUTION SERVICES

NETWORK SERVICES

TOOLS

BUILDING JANITORIAL

AUTOMOTIVE

FORMS/OFFICE SUPPLIES

GENERAL

DATA VOICE

PRODUCT IDENTIFIER DESCRIPTION

ITEM	ORD.	SELL	STD. PKG.	LEAD TIME	MIN.	A
NUMBER	MULT.	UNIT	STOCK AVAILABILITY / PA	ORD.	ORD.	C

ADAPTER

996813440 ADAPTER SINGLE P&S 1919
7237040 1 EA

ALCOHOL

260411640 ALCOHOL ISOPROPYL 917 PT8500-0559
N BT 1 1 1
Hewlett Packard.

BAG

996295564 BAG CANVAS CLOTH CK5048
1934299 1 BX
Box of 30. Flame retardent bag with 20oz mineral wool used for insulation, stuffing holes and for fire-wall insulation, 12in x 12in x 1 1/2in.

900208000 BAG PAPER 580 16IN X 12IN X 35IN
7161265 50 EA IL IN MI OH WI
31 31 31 31
2 ply, 50 bags per case.

260448311 BAG POLY #100P
N
For sanitary napkin disposal receptacle.

260448378 BAG VACUUM CLEANER #3088147001
N
For Royal vacuum cleaner.

BAG POLY

900208810 BAG POLY 4IN X 3IN X 12IN BANDED
1194431 1 CS
1.0mil, package 100. DISCONTINUE, ORDER NON STOCK UPON STOCK DEPLETION

900208109 BAG POLY 7IN X 14IN 1.5MIL
N CS 1 4 50
Clear, red stripe.

900355041 BAG POLY 7IN X 14IN GREEN STRIPE
N CS 1 6 50
Clear, 1.5mil.

900272808 BAG POLY 9IN X 18IN 4.0ML BANDED
4103663 1 EA IL IN MI OH WI
08
Plain poly bag made with plastic rim and perforations in the body of the bag.

280046939 BAG POLY 10IN X 46IN 6.0MIL
1925909 1 CS IL IN MI OH WI
31 31
DISCONTINUE, ORDER NON STOCK UPON STOCK DEPLETION

PRODUCT IDENTIFIER DESCRIPTION

ITEM	ORD.	SELL	STD. PKG.	LEAD TIME	MIN.	A
NUMBER	MULT.	UNIT	STOCK AVAILABILITY / PA	ORD.	ORD.	C

900291212 BAG POLY 10IN X 4IN X 18IN VENTED
1145623 1 EA IL IN MI OH WI
31 31
Used to protect telephone sets.

260381116 BAG POLY 15IN X 9IN X 23IN
1961011 1 CS IL IN MI OH WI
31 31 31 31 31
250 per case.

300013828 BAG POLY 15IN X 9IN X 23IN .6MIL
N CS 1 4 50
1000 per case.

400416285 BAG POLY 15IN X 9IN X 23IN 1.2MIL
N CS 1 2 50

900208125 BAG POLY 15IN X 17IN 1.2MIL
7370643 1 CS IL IN MI OH WI
31 31
Clear, 500 per case.

300038726 BAG POLY 16IN X 14IN X 3IN .9MIL
N CS 1 1 1
Trash can liner, 250 per case.

300013604 BAG POLY 16IN X 16IN X 48IN .9MIL
N CS 1 2 100
250 per case.

280046343 BAG POLY 16IN X 16IN X 48IN 2.0MIL
1925701 1 CS IL IN MI OH WI
31 31 31 31 31

900208133 BAG POLY 16IN X 18IN 2.4MIL
4103929 1 CS IL IN MI OH WI
31 31 31
Used to store telephone sets and equipment for field turnaround.

300041316 BAG POLY 18IN X 12IN X 45IN 1.4MIL
N CS 1 2 50
200 per case.

900207952 BAG POLY 18IN X 18IN X 40IN 1.8MIL
2793182 1 CS IL IN MI OH WI
31 31 31 31 31
50 per case.

300038734 BAG POLY 20IN X 13IN X 39IN .9MIL
N CS 1 2 50
250 per case.

300038742 BAG POLY 22IN X 14IN X 58IN 1.2MIL
N CS 1 2 50
100 per case.

900208602 BAG POLY 22IN X 18IN X 60IN 1.2MIL
2793208 1 CS IL IN MI OH WI
31 31 31 31 31
Plastic bag used to line trash containers, 50 per case.

300038759 BAG POLY 22.5 X 20IN X 48IN 1.2MIL
5110058 1 CS IL IN MI OH WI
31 31 31 31 31
100 per case.

DISTRIBUTION SERVICES

NETWORK SERVICES

TOOLS

BUILDING JANITORIAL

AUTOMOTIVE

FORMS/OFFICE SUPPLIES

GENERAL

DATA VOICE

BAG POLY

PRODUCT IDENTIFIER DESCRIPTION

ITEM NUMBER	ORD. MULT.	SELL UNIT	STD. PKG. STOCK AVAILABILITY / PA	LEAD TIME	MIN. ORD.	A C
-------------	------------	-----------	-----------------------------------	-----------	-----------	-----

900207978 BAG POLY 23 X 10 X 48 BUFF
 7425900 1 EA IL IN MI OH WI
 31 31 31 31 31
 Case of 300. A .002 mil buff plastic bag used by House Service as an insert in towel baskets.

300013752 BAG POLY 23IN X 17IN X 46IN 1.2MIL
 N CS 1 2 50
 250 per case.

300055654 BAG POLY 24IN X 22IN X 50IN 1.2MIL
 6510180 1 CS IL IN MI OH WI
 31 31 31 31 31
 100 per case.

997196084 BAG POLY 32IN X 30IN X 70IN 2.0MIL
 5148064 1 CS IL IN MI OH WI
 31 31 31 31 31
 CLEAR. Case of 50.

300038783 BAG POLY 88IN X 47IN 1.8MIL
 1183368 1 CS IL IN MI OH WI
 31 31 31 31 31
 50 per case.

260448352 BAG POLY #2317603 23 X 17 X 60 X .003
 N
 Clear. 125/case.

260448360 BAG POLY #P4020 23 X 10 X 39 HEAVY BUFF
 N
 33 GAL, 250/Ccase.

BALLAST

260404710 BALLAST 120V
 1970061 1 EA

260404728 BALLAST 277V
 1970053 1 EA IL IN MI OH WI
 31

280018284 BALLAST LAMP 1-22 & 1-32W
 N EA 1 2 1
 Circline rapid w/sockets RS-22-32 12V 60HZ.

280018292 BALLAST LAMP 1-40W 430MA RS
 N EA 1 2 1
 OR 1-F40-4FT 34W/35W RS 460 MA MAX.

280018268 BALLAST LAMP 480X-LH-TC-P
 N EA 1 2 1
 High output 120V 60 Hertz.

280018276 BALLAST LAMP F40T12RS SINGLE TUBE
 N EA 1 2 1

300086196 BALLAST LAMP FLUORESCENT
 N EA 1 2 1

280017195 BALLAST LAMP RM1 40 TP
 N EA 1 2 1

PRODUCT IDENTIFIER DESCRIPTION

ITEM NUMBER	ORD. MULT.	SELL UNIT	STD. PKG. STOCK AVAILABILITY / PA	LEAD TIME	MIN. ORD.	A C
-------------	------------	-----------	-----------------------------------	-----------	-----------	-----

BASKET

400756565 BASKET PAPER WASTE METAL ROUND GRAY
 1107789 1 EA
 14in high x 12in diameter, 23.5qt capacity.

400470654 BASKET WASTEPAPER RECTANGULAR SAND
 1144998 1 EA IL IN MI OH WI
 31 31 31 31 31
 13in high x 15in x 9in top diameter, 20.7qt capacity.

BATTERY

401825344 BATTERY 4.5 VOLTS CK06568 L2
 N EA 24 9 48
 A 4 1/2 volt dry battery e/w wire terminals. For use at repeater stations.

997300843 BATTERY 7.5 VOLTS CK13493
 N EA 6 9 48

400327839 BATTERY 7.5 VOLTS CK15939
 1101097 1 EA IL IN MI OH WI
 31 31 31 31 31
 Used for emergency and portable lights.

996444501 BATTERY 7.5 VOLTS CK15998
 N EA 5 9 60

995042181 BATTERY 22.5 VOLTS CK06572
 N EA 6 9 48

997904800 BATTERY 22.5 VOLTS CK06573
 1107961 1 EA IL IN MI OH WI
 31 31 31 31 31
 Test battery, tapped from 16 1/2volts to 22 1/2volts equipped with spring clip (Fahnestock) terminals, BSP 157-421-101.

997801477 BATTERY 22.5 VOLTS CK08128
 1108084 1 EA IL IN MI OH WI
 31 31 31 31 31
 Used mainly for superimposed ringing service. Equipped with spring clip terminals, BSP 157-421-101.

997884218 BATTERY 22.5 VOLTS GP CK07105
 1108027 1 EA IL IN MI OH WI
 31 31 31 31 31
 Fahnestock terminals, spring clip, for use in plate or grid battery service, package of 40, BSP 157-421-101.

995042223 BATTERY 30.0 VOLTS GP CK15937
 1108308 1 EA IL IN MI OH WI
 31 31 31 31 31
 For use in the CK14510 L1 meter, BSP 157-421-101.

997566591 BATTERY 45.0 VOLTS CK06948
 1108001 1 EA IL IN MI OH WI
 31 31 31 31 31
 Equipped with eight fahnestock terminals, spring clip, for plate and test battery service, package of 4, BSP 157-421-101.

DISTRIBUTION SERVICES

NETWORK SERVICES

TOOLS

BUILDING JANITORIAL

AUTOMOTIVE

FORMS/OFFICE SUPPLIES

GENERAL

DATA VOICE

PRODUCT IDENTIFIER		DESCRIPTION					
ITEM NUMBER	ORD. MULT.	SELL UNIT	STD. PKG. STOCK AVAILABILITY / PA	LEAD TIME	MIN. ORD.	A C	

401825351 BATTERY 93.0 VOLTS CK07890 L2
 2671024 1 EA IL IN MI OH WI
 31 31 31 31 31
 Used for regulated tube rectifiers. E/W wire terminals for 46 1/2 volt and 90 volt taps, BSP 157-421-101.

000247916 BATTERY AML II SUB MODULE
 1183178 1 EA IL IN MI OH WI
 31 31 31 31
 Required to power the AML-II Sub Module P/N 77-136-00 W6, BSP 363-400-900.

000247916 BATTERY AMLII SUB MODULE
 1183178 EA IL IN MI OH WI
 31 31 31 31

842197337 BATTERY HOLDOWN
 N EA 1 9 1

280003369 BATTERY MODULE C-48
 N EA 1 3 1

BLEACH

280010547 BLEACH CLEANSER 21OZ
 N CS 1 1 1
 Case of 30.

260300579 BLEACH HEAVY DUTY 2290
 N GL 1 1 1

280010554 BLEACH HEAVY DUTY LIQUID
 N GL 1 1 1

280099029 BLEACH QUART
 N CS 1 1 1
 Case of 18.

260300587 BLEACH SWB SO WHITE
 N GL 1 1 1
 6 gallon bottles per case.

BOTTLE

260416706 BOTTLE MOISTENER SQUEEZE LARGE B-94
 N EA 1 1 1
 NOW AVAILABLE THROUGH TOUCH TONE ORDER ENTRY.

300038791 BOTTLE PLASTIC SPRAY 22OZ W/TRIGGER
 1218719 1 EA IL IN MI OH WI
 31 31 31 31 31
 Comes assembled, graduated bottle, adjustable trigger sprayer.

260301528 BOTTLE SPRAYER 922
 N EA 1 1 1

PRODUCT IDENTIFIER		DESCRIPTION					
ITEM NUMBER	ORD. MULT.	SELL UNIT	STD. PKG. STOCK AVAILABILITY / PA	LEAD TIME	MIN. ORD.	A C	

BOWL CLEANER
 SEE CLEANER.

BRACE
260300603 BRACE GUARDIAN FOR BROOM HANDLES
 N EA 1 1 1
 No tools required.

BROMICIDE
260327861 BROMICIDE T
 1945527 1 PL

BROOM

260300611 BROOM 1123 70Y
 N EA 1 1 1

401337910 BROOM BASE B-80 14IN W/HDL 125
 N EA 6 2 6

260300637 BROOM PUSH COARSE 70-18
 N EA 1 1 1
 Palmyra Fibre 18.

260300645 BROOM PUSH COARSE P52-18
 N EA 1 1 1
 Prolene Plastic 18.

260300652 BROOM PUSH COARSE P52-24
 N EA 1 1 1
 Prolene Plastic 24.

401337894 BROOM STREET PUSH 14IN LESS HANDLE
 1117465 1 EA IL IN MI OH WI
 31 31 31 31 31
 Stiff bristle push broom 14in wide, 6 1/4in from top of wooden block to floor end.



1117465

DISTRIBUTION SERVICES

NETWORK SERVICES

TOOLS

BUILDING JANITORIAL

AUTOMOTIVE

FORMS/OFFICE SUPPLIES

GENERAL

DATA VOICE

BROOM

PRODUCT IDENTIFIER		DESCRIPTION					
ITEM NUMBER	ORD. MULT.	SELL UNIT	STD. PKG. STOCK AVAILABILITY / PA	LEAD TIME	MIN. ORD.	A	C

400415261 BROOM WHISK CORN 1

1117481 1 EA IL IN MI OH WI
31 31 31 31 31
1181, ball and ring type 8IN corn broom,
11IN long. Package of 12.



1117481

260447909 BROOM W/METAL HANDLE #6118 52IN MED
N Upright.

BRUSH

260300678 BRUSH BLACK TAMPLENE 258

N EA 1 1 1
Plastic.

400559209 BRUSH BOWL TOILET

1117986 1 EA IL IN MI OH WI
31 31 31 31 31
Rayon head with plastic handle.

400484341 BRUSH COUNTER DUSTER 13IN

1118042 1 EA IL IN MI OH WI
31 31 31 31 31
CB10114.

260300660 BRUSH COUNTER HORSEHAIR 250

N EA 1 1 1
Plastic mix.

400021226 BRUSH FLOOR 201821 16IN W/HANDLE

N EA 1 2 1
Horsehair brush for smooth sweeping, 60in
wood & steel handle.

PRODUCT IDENTIFIER		DESCRIPTION					
ITEM NUMBER	ORD. MULT.	SELL UNIT	STD. PKG. STOCK AVAILABILITY / PA	LEAD TIME	MIN. ORD.	A	C

400021234 BRUSH FLOOR HAIR 16IN LESS HANDLE

1118083 1 EA IL IN MI OH WI
31 31 31 31 31
For sweeping polished parquet, linoleum and tile
floors.

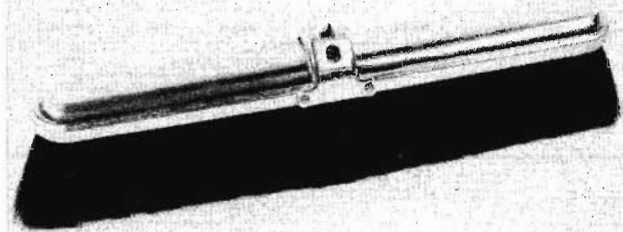

1118083

400021242 BRUSH FLOOR HAIR 201871 30IN W/HANDLE

1194076 1 EA IL IN MI OH WI
31 31 31 31 31
Horsehair brush for smooth sweeping, 60in
wood & steel handle.

400021259 BRUSH FLOOR HAIR 30IN LESS HANDLE

1118109 1 EA IL IN MI OH WI
31 31 31 31 31
Horsehair brush for smooth sweeping.

400559118 BRUSH FLOOR PALMYRA 18IN W/HANDLE

N EA 1 2 1
For average to rough sweeping, 60in wood &
steel handle.

260359971 BRUSH FLOOR PALMYRA 24IN L/HANDLE

1953588 1 EA IL IN MI OH WI
31 31 31 31 31

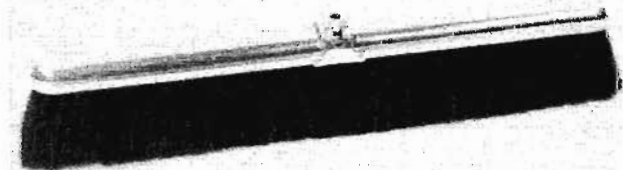

1953588

400559134 BRUSH FLOOR PALMYRA 24IN W/HANDLE

1170753 1 EA IL IN MI OH WI
31 31 31 31 31
For average to rough sweeping, 60in wood &
steel handle.

280025354 BRUSH INSULATED 8 1/2IN

N EA 1 1

260300686 BRUSH MILKING MACHINE 551N

N EA 1 1 1

280037433 BRUSH P52 24IN PLASTIC PROLENE/MOP

N EA 1 2 1

996601316 BRUSH RADIATOR

1118208 1 EA IL IN MI OH WI
31 31 31 31 31
Brush for cleaning in small areas, black
horsehair & synthetic fiber blend, 9in brush face,
2 1/2in trim, Zimco #02-R.

DISTRIBUTION SERVICES

NETWORK SERVICES

TOOLS

BUILDING JANITORIAL

AUTOMOTIVE

FORMS/OFFICE SUPPLIES

GENERAL

DATA VOICE

PRODUCT IDENTIFIER DESCRIPTION

ITEM NUMBER	ORD. MULT.	SELL UNIT	STD. PKG. STOCK AVAILABILITY / PA	LEAD TIME	MIN. ORD.	A C
-------------	------------	-----------	-----------------------------------	-----------	-----------	-----

260447826 BRUSH WIRE #1541 TEMPERED STEEL 12/CASE

N

BUCKET

260301288 BUCKET 8110R 10QT W/POURING SPOUT

N EA 1 1 1

280010620 BUCKET CYR206-2 MOP STRUCTOLEN

N EA 1 3 1

With 2In castors, yellow.

260448402 BUCKET #2614RD 14 QUART ROUND RED

N

260448386 BUCKET #6130YL W/WRINGER FOR WET MOP

N

BULB

SEE LAMP.

CALCIUM CHLORIDE

SEE CHLORIDE CALCIUM.

CALCIUM CHLORIDE

SEE ICE REMOVAL

CAN WASTE

SEE WASTEBASKET.

CAPACITOR

280018136 CAPACITOR 23 84536G01

N EA 1 2 1

280025677 CAPACITOR 25 MFD 660 VOLTS AC

N EA 1 2 1

0214266125.

280025040 CAPACITOR C RAW

N EA 1 2 1

CASE

280025065 CASE NETWORK LATTICE L730 RAW

N EA 1 2 1

BOLN.

CEMENT

900626128 CEMENT EPOXY METAL SET A4

1127746 1 SE

One case equal 4 cartons, one carton equal 12 units.

PRODUCT IDENTIFIER DESCRIPTION

ITEM NUMBER	ORD. MULT.	SELL UNIT	STD. PKG. STOCK AVAILABILITY / PA	LEAD TIME	MIN. ORD.	A C
-------------	------------	-----------	-----------------------------------	-----------	-----------	-----

400485827 CEMENT HOUSEHOLD DUPONT

1127621 1 TU IL IN MI OH WI
31 31 31 31 31

1 3/4oz General purpose adhesive. Can be used for cementing dustproof strips on sander cabinet doors.

260409511 CEMENT RUBBER K-19

N EA 1 1 1
NOW AVAILABLE THROUGH TOUCH-TONE ORDER ENTRY.

CHAMOIS

401768064 CHAMOIS SKINS 200

N DZ 1 3 2
Case of 12.

CHARGER BATTERY

260442231 CHARGER BATTERY 9.6 VOLT

N EA 1 3 1

CHEESE CLOTH

SEE CLOTH.

CHEMICAL WATER TREATMENT

280379607 CHEMICAL WATER TREATMENT 2350

1960443 1 DR
Liquid corrosion inhibitor used in cooling towers.

260361563 CHEMICAL WATER TREATMENT C452

1954206 1 DR IL IN MI OH WI
31

CLEANER

260300710 CLEANER 504-GA HD ALL PURPOSE

N GL 1 1 1
Green Pine.

280009341 CLEANER 4209-GA AJAX PINE FOREST

N GL 1 3 1
Liquid.

300052271 CLEANER ALL PURPOSE 880

6509208 1 CS IL IN MI OH WI
31 31

Ammoniated, high foam, 12 per case.

001079532 CLEANER ALL PURPOSE HEAVY DUTY

N CS 1 1 1
Versatile, powerful, non-phosphate cleaner, removes soil, oil, grease, wax, gum, dye, ink, carpet stains, and polish build-up 311 snap, 1 gallon per container.

260302534 CLEANER ALL PURPOSE MR JINX

N CS 1 2 1
Aerosol, 20oz can, 12 per case.

DISTRIBUTION SERVICES

NETWORK SERVICES

TOOLS

BUILDING JANITORIAL

AUTOMOTIVE

FORMS/OFFICE SUPPLIES

GENERAL

DATA VOICE

CLEANER

PRODUCT IDENTIFIER		DESCRIPTION					
ITEM NUMBER	ORD. MULT.	SELL UNIT	STD. PKG. STOCK AVAILABILITY / PA	LEAD TIME	MIN. ORD.	A	C

300067634 CLEANER ALL PURPOSE ZEP SPIRIT

1168617	1	CS	IL IN MI OH WI	31 31 31 31 31
---------	---	----	----------------	----------------

Premixed, germicidal cleaner used deodorant, 32oz bottles with hand sprayers, 20qts per case.



1168617

900220492 CLEANER ANTI FOG 3.5OZ BOTTLE

1145169	1	EA	IL IN MI OH WI	33 33 33 33 33
---------	---	----	----------------	----------------

Cleaner to be used on safety glass lenses, cleans polishes and protects plastic and glass, 50 bottles per case.

260319231 CLEANER BATHROOM NABC SPARTAN

N		CS	1	2	1
---	--	----	---	---	---

300098753 CLEANER BATHROOM STAY WARSAW

N		QT	1	1	1
---	--	----	---	---	---

900422593 CLEANER BOL-TABS

1328781	1	CS	IL IN MI OH WI	31 31 31 31 31
---------	---	----	----------------	----------------

Individually wrapped, 1000/case.

300038809 CLEANER BOWL LIQUID 8-10% ACID

5110130	1	CS	IL IN MI OH WI	31 31 31 31 31
---------	---	----	----------------	----------------

12qts per case.

300038817 CLEANER BOWL LIQUID 18-23% ACID

N		CS	1	3	25
---	--	----	---	---	----

280009390 CLEANER BOWL NA100 QUART

N		QT	1	3	1
---	--	----	---	---	---

Bowl Cleaner & Disinfectant, 12 quarts per case.

900154626 CLEANER BOWL SANIFLUSH 20OZ CAN

1158642	1	CS	IL IN MI OH WI	31 31 31 31 31
---------	---	----	----------------	----------------

Granular, cleans, disinfects, deodorizes, 12 cans per case.

280003591 CLEANER BOWL STAIN-X NA500

N		QT	1	1	1
---	--	----	---	---	---

12 quarts per case.

260300728 CLEANER C031 CHEX ALL PURPOSE

N		EA	1	1	1
---	--	----	---	---	---

12 per case, 19oz.

PRODUCT IDENTIFIER		DESCRIPTION					
ITEM NUMBER	ORD. MULT.	SELL UNIT	STD. PKG. STOCK AVAILABILITY / PA	LEAD TIME	MIN. ORD.	A	C

400121646 CLEANER CK14356 L1 PINT CAN

N		CN	12	2	12
---	--	----	----	---	----

400647848 CLEANER CK20406 L1 12OZ CAN

1297382	1	CN	IL IN MI OH WI	31 31 31 31 31
---------	---	----	----------------	----------------

A spray cleaner for cleaning relay and similar contacts.

260357975 CLEANER CONCENTRATE 1 GALLON

1953018	1	GL	IL IN MI OH WI	31 31 31 31 31
---------	---	----	----------------	----------------

Simply Green, non-toxic, non-abrasive, biodegradable.

260321070 CLEANER CRT SCREEN TX129

N		CS	1	3	1
---	--	----	---	---	---

Non-aerosol pump spray removes dust and oils from crt, polygraph, readout & display screens, 4oz bottle, 6 per box.

260321013 CLEANER CRT TERMINAL TX101

N		CS	1	3	1
---	--	----	---	---	---

Aerosol spray removes oil and dust etc., from crt, polygraph, readout & display screens, 15oz cans, 12 cans per box.

260344288 CLEANER CYNAMIC 307 5 GALLON

1950204	1	CO	IL IN MI OH WI	31 31 31 31 31
---------	---	----	----------------	----------------

Polish Mate.

900635095 CLEANER DUST A GO GO 9

N		BX	1	6	1
---	--	----	---	---	---

300029568 CLEANER DUST A GO GO 11

N		BX	1	6	1
---	--	----	---	---	---

300029576 CLEANER DUST A GO GO 15

N		BX	1	6	1
---	--	----	---	---	---

280039421 CLEANER DUZ-ALL N215-GA

N		GL	1	2	1
---	--	----	---	---	---

300093127 CLEANER ENVY JOHNSON

N		CS	1	1	1
---	--	----	---	---	---

400559365 CLEANER FLOOR LIQUID 1 GALLON

1129304	1	CS	IL IN MI OH WI	31 31 31 31 31
---------	---	----	----------------	----------------

Liquid cleaner for removing resin and wax in the reconditioning cleaning of all resilient floor coverings, BSP 770-150-304.

280045154 CLEANER FLOOR LIQUID C4 1 GALLON

N		CS	1		1
---	--	----	---	--	---

300067824 CLEANER GERMICIDAL HEAVY DUTY

N		CS	1	2	1
---	--	----	---	---	---

Acid cleaner used to remove rust, scum and stains from urinals and toilet bowls without harm to metal drain lines, 12qts per case.

300038833 CLEANER GERMICIDAL TAMSDQ06

5110171	1	CS	IL IN MI OH WI	31 31 31 31 31
---------	---	----	----------------	----------------

4 one gallon jugs per case.

PRODUCT IDENTIFIER		DESCRIPTION					
ITEM NUMBER	ORD. MULT.	SELL UNIT	STD. PKG. STOCK AVAILABILITY / PA	LEAD TIME	MIN. ORD.	A C	
300038841		CLEANER MULTIPURPOSE GALLON CAN					
N		CS	1	4	15		
		ISP 1013, 4 gallons per case.					
900233594		CLEANER POLISH MAG-AL-3					
N		CN	12	2	12		
		For long lasting protection of aluminum and other metal surfaces and the retention of its original luster.					
001025071		CLEANER SIMPLE GREEN PREMIXED					
N		GL	6	2	6		
300093184		CLEANER STAINLESS STEEL BTCHRS					
N		EA	1	1	1		

PRODUCT IDENTIFIER		DESCRIPTION					
ITEM NUMBER	ORD. MULT.	SELL UNIT	STD. PKG. STOCK AVAILABILITY / PA	LEAD TIME	MIN. ORD.	A C	
400772695		CLEANER SURFACE HARD C39 5LB BOX					
1101451	1	CS	IL IN MI OH WI 31 31 31 31				
		Powdered, non-abrasive, non-phosphate compound. A Blend of biodegradable detergent, sodium carbonate, surfact.					



1101451

280011255		CLEANER TAPE HEAD 10-620					
N		CN	1	3	1		
260447560		CLEANER #C841 NASSCO STAINLESS STEEL 18OZ					
N							
260447552		CLEANER #CITRA440 CITRA-CLEAN WHC W/GRIT					
N							
		4 X 1 GA.					
260448006		CLEANER #P222 TOILET BOWL BLUE					
N							
		12/BOX.					

CLEANER GLASS

260300702		CLEANER GLASS 103K PM WINDOW					
N		CS	1	1	1		
		32oz bottle.					
300093168		CLEANER GLASS AEROSOL WINDEX					
N		CS	1	1	1		

PRODUCT IDENTIFIER		DESCRIPTION					
ITEM NUMBER	ORD. MULT.	SELL UNIT	STD. PKG. STOCK AVAILABILITY / PA	LEAD TIME	MIN. ORD.	A C	
001121433		CLEANER GLASS ANTISTATIC					
N		CS	1	2	3		
		FORWARD TO CLEANER GLASS					
280009408		CLEANER GLASS C050 CHEX					
N		EA	1	3	1		
		12 per case, 19oz.					
260300736		CLEANER GLASS NA01 CONCENTRATE					
N		GL	1	1	1		
300024908		CLEANER GLASS PLATEN 16OZ CAN					
N		CS	1	2	1		
		Streak-free glass cleaner, can be used on chrome and/or stainless steel, 12 cans per case.					

PRODUCT IDENTIFIER		DESCRIPTION					
ITEM NUMBER	ORD. MULT.	SELL UNIT	STD. PKG. STOCK AVAILABILITY / PA	LEAD TIME	MIN. ORD.	A C	
300038999		CLEANER GLASS PREMIXED GALLON					
1165795	1	CS	IL IN MI OH WI 31 31 31 31 31				
		Premixed antistatic glass and plastic cleaner in gallon jugs for general cleaning, film and ammonia free, 4 gallons per case.					

PRODUCT IDENTIFIER		DESCRIPTION					
ITEM NUMBER	ORD. MULT.	SELL UNIT	STD. PKG. STOCK AVAILABILITY / PA	LEAD TIME	MIN. ORD.	A C	
900154659		CLEANER GLASS TELEPHONE BOOTH					
1404145	1	CN	IL IN MI OH WI 31 31 31 31 31				
		Streak proof, lint free, dust proof, 12 - 15oz aerosol cans.					

PRODUCT IDENTIFIER		DESCRIPTION					
ITEM NUMBER	ORD. MULT.	SELL UNIT	STD. PKG. STOCK AVAILABILITY / PA	LEAD TIME	MIN. ORD.	A C	
300083185		CLEANER GLASS WINDOW W/SPRAYER					
6513937	1	CS	IL IN MI OH WI 31 31 31 31 31				
		Windex, with Ammonia-D, 32oz bottles, 12 per case.					

CLEANER HAND

260300744		CLEANER HAND 388 GRITTY GIANT/PUMICE					
N		GL	1	1	1		
		Liquid waterless 12oz can.					
002083004		CLEANER HAND 6-7005					
8158568	1	EA	IL IN MI OH WI 12		12	E	

260409917		CLEANER HAND DERMA-KWIK A-40					
N		EA	1	1	1		
		50 pads per pack. NOW AVAILABLE THROUGH TOUCH-TONE ORDER ENTRY.					

280009416		CLEANER HAND LURON BORAXO					
N		CS	1	1	1		
		10 liters per case.					

280008863		CLEANER HAND POWDER					
N		CS	1	2	1		

900417163		CLEANER HAND REN C-3016					
N		EA	36	4	36	E	
		Hand cleaner used to remove pressurization compounds, contains lanolin.					

300077641		CLEANER HAND VK200 INK REMOVE					
N		EA	1	1	1		

DISTRIBUTION SERVICES

NETWORK SERVICES

TOOLS

BUILDING JANITORIAL

AUTOMOTIVE

FORMS/OFFICE SUPPLIES

GENERAL

DATA VOICE

CLEANER HAND

DISTRIBUTION SERVICES

PRODUCT IDENTIFIER		DESCRIPTION							MIN. A
ITEM NUMBER	ORD. MULT.	SELL UNIT	STD. PKG. STOCK AVAILABILITY / PA	LEAD TIME			ORD.	C	
000246728 CLEANER HAND WATERLESS 12OZ									
1101436	1	CS	IL 12 IN 12 MI 12 OH 12 WI 12					E	

NETWORK SERVICES

000246736 CLEANER HAND WATERLESS 64OZ W/DISP								
N		CS	1	2			1	
8 gallon jugs, 8 per case.								
400522959 CLEANER HAND WATERLESS PINT								
N		CN	1	4			240	E
A paste cleaner for use by field forces in locations where washing facilities are not available, package of 24.								

TOOLS

900608209 CLEANER HAND WATERLESS PR875								
N		CS	1	3			1	
12oz, case of 12.								

280062357 CLEANER HAND ZEP CINCH								
1934158	1	CS	IL 12 IN 12 MI 12 OH 12 WI 12					E
12 cans per case, 105 ounces per can.								

280062365 CLEANER HAND ZEP O CREAM								
1934141	1	CS	IL 12 IN 12 MI 12 OH 12 WI 12					E
12 cans per case, 105 ounces per can.								

BUILDING JANITORIAL

CLEANER MS

300059532 CLEANER MS 180 FREON TF 16OZ CAN								
N		EA	1	1			1	

260301767 CLEANER MS 185								
N		CN	1	2			1	
12 per case.								

900422981 CLEANER MS 185 FREON 16OZ CAN								
N		EA	1	1			1	

300059557 CLEANER MS 200 16OZ CAN								
N		EA	1	1			1	

300059599 CLEANER MS 220 16OZ CAN								
N		EA	1	1			1	

300083771 CLEANER MS 226 COBRA								
N		EA	1	1			1	

300059565 CLEANER MS 230 16OZ CAN								
N		CN	1	1			1	

AUTOMOTIVE

260301783 CLEANER MS 230/C02								
N		CS	1	2			1	
12 per case.								

FORMS/OFFICE SUPPLIES

300059573 CLEANER MS 238 SOLVENT 16OZ CAN								
N		EA	1	1			1	

GENERAL

260301791 CLEANER MS 260								
N		CS	1	2			1	
Glass. 12 per case.								

DATA VOICE

PRODUCT IDENTIFIER		DESCRIPTION							MIN. A
ITEM NUMBER	ORD. MULT.	SELL UNIT	STD. PKG. STOCK AVAILABILITY / PA	LEAD TIME			ORD.	C	
300059581 CLEANER MS 260 16OZ CAN									
N		EA	1	1			1		

CLEANING FLUID
SEE FLUID CLEANING.

CLEANSER

260300751 CLEANSER 2801 LURON LOTION								
N		BT	1	1			1	
10 bottles per case.								

280009200 CLEANSER AJAX INSTNL CREME								
N		BX	1	2			1	
Scouring 26oz 9 per box.								

280052424 CLEANSER AJAX PROFESSIONAL								
N		EA	1	1			1	
Double bleach 4283.								

260447578 CLEANSER AJAX #4941 SCOUR CREME 24.5 OZ								
N								
9/Case.								

300098712 CLEANSER BOWL GERMICIDAL								
N		CS	1	1			1	

300093259 CLEANSER COMET								
N		CS	1	1			1	

260300769 CLEANSER DUTCH W/CHLORIDE P782098								
N		EA	1	1			1	
Case of 30.								

402139596 CLEANSER KITCHEN W/CHLORINE BLEACH								
1125609	1	CS	IL 31 IN 31 MI 31 OH 31 WI 31					
21oz containers, 24 containers per case.								

260448014 CLEANSER LIQUIKLENZ LIQUID CREAM 32 OZ								
N								

300083193 CLEANSER LOTION 33.8 FLUID OZ								
6513945	1	CS	IL 31 IN 31 MI 31 OH 31 WI 31					
Body and hand luron, 1 liter bottles, 10 bottles per case.								

CLIP

400152005 CLIP C TERMINAL INSULATOR								
N		PK	1	3			300	

CLOTH

260300777 CLOTH 414 STRETCH & DUST TREATED								
N		PK	1	1			1	

PRODUCT IDENTIFIER DESCRIPTION

ITEM	ORD.	SELL	STD. PKG.	LEAD TIME	MIN.	A
NUMBER	MULT.	UNIT	STOCK AVAILABILITY / PA		ORD.	C

401352901 CLOTH CHEESE CURTAIN 20
 N YD 1 2 100
 100% cotton, sparkling white, bleached, textured to be soft, highly absorbent, lint free. 36in, folds in half to 18in, 100yds per roll, 4 1/2lbs per roll.

400122784 CLOTH CLEANING CK14666 L 1

ITEM	ORD.	SELL	STD. PKG.	LEAD TIME	MIN.	A
NUMBER	MULT.	UNIT	STOCK AVAILABILITY / PA		ORD.	C
1130864	1	PK	IL IN MI OH WI			E
			31 31 31 31 31			

Ivory colored cotton twill cloth for general cleaning, 18in x 18in, package of 25, 8 packages per box, BSP 065-370-101.

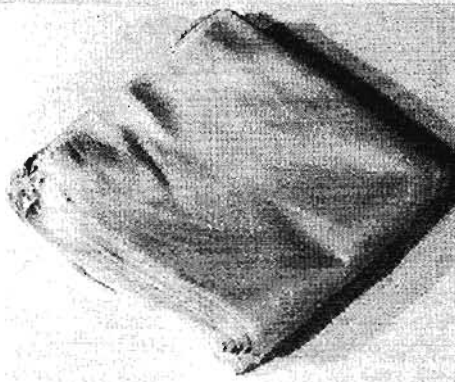

1130864

900221508 CLOTH DROP 9FT X 12FT FIREPROOF
 N EA 1 4 1

455004838 CLOTH DROP 9FT X 12FT PLASTIC
 3129106 1 EA IL IN MI OH WI
 31 31 31 31 31
 Used to cover furniture and other items when painting or performing other work operations requiring protection.

300060498 CLOTH DUST MASSLINN 24IN X 16IN
 N CS 1 1 5
 NO.213 Chicopee.

280030941 CLOTH LINT FREE
 N BX 1 2 5
 Box of 600.

PRODUCT IDENTIFIER DESCRIPTION

ITEM	ORD.	SELL	STD. PKG.	LEAD TIME	MIN.	A
NUMBER	MULT.	UNIT	STOCK AVAILABILITY / PA		ORD.	C

996289096 CLOTH POLISHING CK14668
 1131086 1 PK IL IN MI OH WI
 31 31 31 31 31
 impregnated twilled jean cloth, 18in x 18in. A black tracer woven into edge distinguishes it from unimpregnated. Used for dry or slightly damp dusting and polishing of C.O. equip. Package of 25.



1131086

900314949 CLOTH SCRUB 16IN X 26IN VARIOUS COLORS
 6152561 1 EA IL IN MI OH WI
 31 31 31 31 31
 Hand towel, 100 towels per case, 35lbs.

900221573 CLOTH SCRUB/WP WHITE 5LB BAG
 2127944 1 LB IL IN MI OH WI
 31 31 31 31 31
 Various colors, absorbent, prewashed, sterilized, knitted texture on one side, turkish effect on other side, cut to wiper size (360 sq in), 20 bags per 100lb bale.

300059649 CLOTH SPUN WOVEN
 1330480 300 BG IL IN MI OH WI
 31 31 31 31 31
 A synthetic fabric intended primarily for use in the cleaning, polishing and oiling of central office apparatus, C1-99, 9in x 9in, 300 sheets per bag.

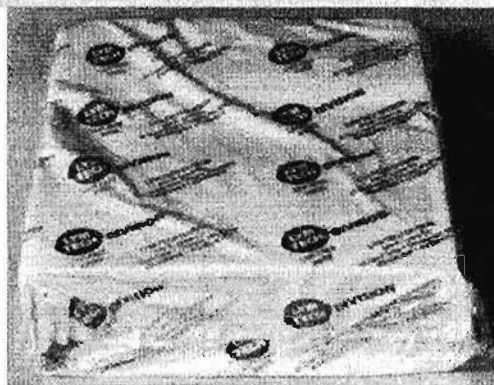

1330480

400407334 CLOTH TREATED DISPOSABLE
 1131144 1 PK IL IN MI OH WI
 31 31 31 31 31
 A non-woven cotton and rayon fabric treated with chemical dust absorbent, BSP 770-130-303. Package of 50.

DISTRIBUTION SERVICES

NETWORK SERVICES

TOOLS

BUILDING JANITORIAL

AUTOMOTIVE

FORMS/OFFICE SUPPLIES

GENERAL

DATA VOICE

CLOTH CLEANING

DISTRIBUTION SERVICES

PRODUCT IDENTIFIER		DESCRIPTION				
ITEM NUMBER	ORD. MULT.	SELL UNIT	STD. PKG. STOCK AVAILABILITY / PA	LEAD TIME	MIN. ORD.	A C

CLOTH CLEANING

300060472 CLOTH CLEANING 24IN X 24IN						
6510974	1	CS				
Used for general dusting, desks, bookcase, file cabinets. Yellow treated 910 Chicopee.						
300060480 CLOTH CLEANING 24IN X 40IN						
N		CS	1	1	5	
Yellow treated, 214 Chicopee.						
280030933 CLOTH CLEANING ANTI-GLARE SCREEN						
N		EA	1	2	1	
280009283 CLOTH CLEANING PRETREATED						
N		CS	1	2	1	
Disposable 24in x 24in.						
280002627 CLOTH CLEANING SHURWIPE 292-10						
N		CS	1	1	1	
50 per package, 16 packages per case.						
280002635 CLOTH CLEANING SHURWIPE 294-06						
N		CS	1	1	1	
40 per package, 6 packages per case.						
280019274 CLOTH CLEANING SHURWIPE 294-17						
N		CS	1	2	1	
13in X 17in.						
280019282 CLOTH CLEANING SHURWIPE 299-20						
N		CS	1	2	1	
3 ply heavy.						

COMPOUND SWEEPING

900113432 COMPOUND SWEEPING 25LB CAN						
5210260	1	BG				
Acts as an absorbent of grease, oily and common spills, 25lb container.						
280009424 COMPOUND SWEEPING 1NOGRTT-50						
N		BX	1	3	1	
50lb box.						
300029584 COMPOUND SWEEPING DUST A GO GO						
N		BX	1	6	1	

CONNECTOR

300062551 CONNECTOR 430B12W HUBBELL						
N		EA	1	1	1	
997484142 CONNECTOR 5261 HUBBELL WIRE						
N		EA	10	1	10	
400494159 CONNECTOR 5269C HUBBELL						
N		EA	10	1	10	
401330840 CONNECTOR 7565C HUBBELL BODY						
N		EA	10	2	10	

NETWORK SERVICES

TOOLS

BUILDING JANITORIAL

AUTOMOTIVE

FORMS/OFFICE SUPPLIES

GENERAL

DATA VOICE

PRODUCT IDENTIFIER		DESCRIPTION				
ITEM NUMBER	ORD. MULT.	SELL UNIT	STD. PKG. STOCK AVAILABILITY / PA	LEAD TIME	MIN. ORD.	A C

280017526 CONNECTOR F56324G						
N		EA	1	2	1	
280017534 CONNECTOR GF625CH						
N		EA	1	2	1	
996795449 CONNECTOR SHIELD CK15711 L4						
N		EA	1	1	1	

CONTAINER

300085529 CONTAINER 469 PREVAL BOTTLE						
N		CS	1	2	4	
280009218 CONTAINER 3524 BIG WHEEL						
N		EA	1	2	1	
280009325 CONTAINER BASE 23GAL BEIGE						
N		EA	1	2	1	
Woodgrain 3569-86.						
260300793 CONTAINER F8 FOAM 8OZ						
N		CS	1	1	1	
Case of 500.						

CORD

280016387 CORD 8120-2220 LINE YELLOW						
N		EA	1	2	1	
401957592 CORD CK16935 L32 72IN EXTENSION						
1106179	1	EA	1L	IN	MI	OH
			31	31	31	31
A 3 conductor, 6ft extension cord, rated at 10 amps. Plug has 2 parallel blades and round ground prong. Compatible with 110 volt grounded AC outlet. Used in conjunction with Panel Power 1A1 (1178616).						

401957600 CORD CK16935 L33 12FT						
1114926	1	EA	1L	IN	MI	OH
			31	31	31	31
A 3 conductor, 12ft extension cord, 10 amps. Plug has 2 parallel blades and round ground prong. Compatible with 110 volt grounded AC outlet. Used in conjunction with Panel Power 1A1 (1178616).						

CORDAGE

996333951 CORDAGE CK15141 14/3						
1146282	1	CT				
14 guage, 3 conductor.						
997829015 CORDAGE CK15143 16/3 SJO						
1146423	1	FT	1L	IN	MI	OH
			31	31	31	31

PRODUCT IDENTIFIER DESCRIPTION

ITEM NUMBER	ORD. MULT.	SELL UNIT	STD. PKG. STOCK AVAILABILITY / PA	LEAD TIME	MIN. ORD.	A C
-------------	------------	-----------	-----------------------------------	-----------	-----------	-----

COTTON SWAB

SEE SWAB.

COVER TOILET SEAT

401984869 COVER TOILET SEAT 1/4 FOLD

3139162 1 CS
Dispenser box, 5000 per case.

280008905 COVER TOILET SEAT 3350

N CS 1 1 N 1
5000 per case.

260321294 COVER TOILET SEAT SCOTT 7410

1942193 1 CS IL IN MI OH WI
31 31 31
Disposable personal seat covers, 18in x 15in,
125 sheets per package, 24 packages per case.

401984844 COVER TOILET SEAT SLIPTEX

N CS 1 2 1
Crown Zellerbach #048, 5000 per case.

CREAM HAND

997200761 CREAM HAND KERODEX 51 4OZ

1147785 1 TU
For protection against poisonous vegetation,
creosote, and synthetic resins, such as C plug
resin and activator, for dry or oily work.

400462453 CREAM HAND KERODEX 71 4OZ

1147801 1 TU IL IN MI OH WI
33 33 33 33 33
A water repellent protective hand cream
available in 4oz tubes for use with keradex 55.

900578394 CREAM HAND PRO TEK 6OZ/TU

N CS 1 2 5

260447800 CREAM HAND #2821 LUROSOOTHE LOTION 12 OZ

N

CUP DRINKING

400464319 CUP DRINKING 42RSS001

1428805 1 CS
Cone shaped, Solo #42-R, 4 1/2oz, 50 sleeves
of 100 per case.

280008921 CUP DRINKING 148 ML P5A 5OZ

N CS 1 2 1

260301775 CUP DRINKING PAPER COLD 5OZ

N CS 1 2 1
Waxed for cold only, 2500 per case.

280009432 CUP DRINKING SOLO PLASTIC COATED

N CS 1 1 1
6oz 1000 per case.

PRODUCT IDENTIFIER DESCRIPTION

ITEM NUMBER	ORD. MULT.	SELL UNIT	STD. PKG. STOCK AVAILABILITY / PA	LEAD TIME	MIN. ORD.	A C
-------------	------------	-----------	-----------------------------------	-----------	-----------	-----

400410569 CUP DRINKING WEDGE WAX PAPER

1147868 1 CS IL IN MI OH WI
33 33 33 33 33
Plain white, 4oz, 250 per tube, 20 tubes per
case. CUP FOR DISPENSER 414 - SEE PID
400507885

260448022 CUP #100HL 10 OZ HOT/COLD 2500/CASE

N

260448030 CUP #376HL 6 OZ HOT/COLD

N 1000/Case.

DEGREASER

280009382 DEGREASER 359 NON-BUTYL.

N GL 1 3 1

300093192 DEGREASER 600 J-SHOP

N PL 1 1 1

260300835 DEGREASER N215GA DUZALL CONCENTRATE

N GL 1 1 1
Cleaner 6 gallon per case.

DEODORANT

280010612 DEODORANT 12-1 PINE DISC

N PK 1 2 1

260300876 DEODORANT 7609 ODOR END

N CN 1 1 1
Carpet/room 12 per case.

280052465 DEODORANT BLOCK 6-24 PINE

N PK 1 3 1
6 per pack.

260447057 DEODORANT DISC TOILET ORDER END D30

N 12 Discs/Case.

260300850 DEODORANT DISK 12-4 CHERRY

N BX 1 1 1
Urinal, 12 per box.

260447891 DEODORANT DISK URINAL 12-4 4 OZ PINE

N

280052457 DEODORANT WALL 6-24 CHERRY

N BX 1 3 1
Blocks 24oz 6 per box.

280009275 DEODORANT WALL 6-24 FLORAL

N BX 1 3 1
Blocks 24oz 6 per box.

260448121 DEODORANT #90-7100 WINTER SCENT

N

DISTRIBUTION SERVICES

NETWORK SERVICES

TOOLS

BUILDING JANITORIAL

AUTOMOTIVE

FORMS/OFFICE SUPPLIES

GENERAL

DATA VOICE

DEODORANT

PRODUCT IDENTIFIER		DESCRIPTION				
ITEM NUMBER	ORD. MULT.	SELL UNIT	STD. PKG. STOCK AVAILABILITY / PA	LEAD TIME	MIN. ORD.	A C
260448220	N		DEODORANT #A04454 AIR FRESHENER GEL			
Fresh Floral, 24/box. Plastic tub of gel fits Georgia Pacific Cormatic dispenser #A2.						
260448204	N		DEODORANT #A0450 AIR FRESHENER GEL			
Winter Mint, 24/box. Plastic tub of gel fits Georgia Pacific Cormatic dispenser #A2.						
260448212	N		DEODORANT #A0453 AIR FRESHENER GEL			
Orange Spice, 24/box. Plastic tub of gel fits Georgia Pacific Cormatic dispenser #A2.						
260448238	N		DEODORANT #A0455 AIR FRESHENER GEL			
Powder Fresh, 24/box. Plastic tub of gel fits Georgia Pacific Cormatic Dispenser #A2.						
280008962	N	CN	DEODORANT CARPET FRESHEN-UP	1	2	1

DISINFECTANT SPRAY

260448287	N		DISINFECTANT AERESOL LYSOL 12 OZ 12/CASE			
260301510	N	EA	DISINFECTANT SPRAY C011 CHEX	1	1	1
12 per case.						

DISPENSER

400507885	N	EA	DISPENSER 414 CUP	1	2	1
DISPENSER FOR CUP DRINKING WEDGE WAX PAPER (1147868) - SEE PID 400410569.						
260300892	N	EA	DISPENSER 562-01 NON-PERF ROLL	1	1	1
White enamel.						
280022625	N	EA	DISPENSER 630C TOWEL SINGLEFOLD	1	2	1
260300900	N	EA	DISPENSER 630C TOWEL SINGLEFOLD	1	1	1
Chrome.						
260300918	N	EA	DISPENSER 876C TOILET TISSUE	1	1	1
2-roll CVR chrome.						
260300884	N	EA	DISPENSER 1200 DISP 1GA BEIGE	1	1	1
Crank type, lotion.						
260447032	N		DISPENSER 876C TOILET PAPER			
2-Roll covered, chrome.						

PRODUCT IDENTIFIER		DESCRIPTION				
ITEM NUMBER	ORD. MULT.	SELL UNIT	STD. PKG. STOCK AVAILABILITY / PA	LEAD TIME	MIN. ORD.	A C

260300926	N	EA	DISPENSER CM115 CONTROL/MIST	1	1	1
Auto aerosol.						
260300934	N	EA	DISPENSER FH33 TOILET SEAT COVER	1	1	1
White.						
280016809	N	EA	DISPENSER FORT HOWARD CAB565-50	1	2	1
Clever lever.						
260300959	N	EA	DISPENSER RT22 1 ROLL TOILET TISSUE	1	1	1
Chrome.						
280021932	N	EA	DISPENSER SOAP POWDER MARK VIII	1	2	1
Sanitary equipment supply.						
260300942	N	EA	DISPENSER SOAP POWDER MARK VIII	1	1	1
65 cubic inch chrome industrial.						

300039054 DISPENSER SOAP SANI FRESH

1156992	1	CS	IL IN MI OH WI			
			31 31 31			
E/W cartridge of liquid soap, 12 per case.						

280008913	N	EA	DISPENSER TOILET TISSUE DUAL COVER	1	2	1
578-53.						
280039439	N	EA	DISPENSER TOWEL U704	1	1	1
260448147	N		DISPENSER #1345 CUP			
Plastic, for #42R cup, 4.5 OZ unprinted cone cup.						
260448154	N		DISPENSER #1357 CUP			
Metal, for 405HL cup. Beige or gray.						
260448162	N		DISPENSER #1389 CUP			
Plastic, for 405HL cup. Beige or gray.						
260447792	N		DISPENSER #21 SOAP LURON			
260448261	N		DISPENSER #A-2 AIR FRESHENER GEL			
Georgia Pacific Cormatic dispenser holds plastic tub gel deodorant.						

DOLLY

260447958	N		DOLLY #2640 UNIVERSAL FOR BRUTE CANS			
-----------	---	--	--------------------------------------	--	--	--

DISTRIBUTION SERVICES

NETWORK SERVICES

TOOLS

BUILDING JANITORIAL

AUTOMOTIVE

FORMS/OFFICE SUPPLIES

GENERAL

DATA VOICE

DISTRIBUTION SERVICES

NETWORK SERVICES

TOOLS

BUILDING JANITORIAL

AUTOMOTIVE

FORMS/OFFICE SUPPLIES

GENERAL

DATA VOICE

PRODUCT IDENTIFIER							DESCRIPTION						
ITEM NUMBER	ORD. MULT.	SELL UNIT	STD. PKG. STOCK AVAILABILITY / PA	LEAD TIME	MIN. ORD.	A C							

PRODUCT IDENTIFIER							DESCRIPTION						
ITEM NUMBER	ORD. MULT.	SELL UNIT	STD. PKG. STOCK AVAILABILITY / PA	LEAD TIME	MIN. ORD.	A C							

DOOR EASE STICK						
SEE LUBRICANT.						

ENAMEL						
SEE PAINT						

DRAIN OPENER											
280052432 DRAIN OPENER NA700											
N		QT	1	2	1						
280003260 DRAIN OPENER NA800 QUART											
N		QT	1	1	1		Case of 12.				
260448196 DRAIN OPENER #535 ENZYME DRAIN CLEANER											
N							Liquid 32 OZ, 12/case.				

EXTENSION CORD						
SEE CORD EXTENSION.						

EXTINGUISHER FIRE											
400139606 EXTINGUISHER FIRE E 6											
1155523	1	EA					A 10lb CO2 extinguisher used where fires involve flammable liquids and petroleum products including gasoline, oil, solvents and grease, BSP 010-105-001.				

DRESSING											
260447875 DRESSING #C875 DUST MOP 14 OZ 12/CASE											
N											

EXTINGUISHER FIRE E15 HALON														
5249144	1	EA					IL	IN	MI	OH	WI			
							31	31	31	31	31			
Rated for use in fighting small fires in telephone equipment and other areas requiring a cleaning agent, rated 10 BC, BSP 770-330-100.														

DROP CLOTH						
SEE CLOTH.						

DUST MOP FRAME						
SEE FRAME DUST MOP						

DUST PAN						
SEE PAN DUST.						

DUSTER											
260321278 DUSTER COMPRESSED AIR TX2504											
N		BX	1	1	1		7.5OZ Can. Extended wand, trigger valve, 4 cans per box.				



5249144

EXTINGUISHER FIRE E16 9LB														
5122838	1	EA					IL	IN	MI	OH	WI			
							31	31	31	31	31			
A general purpose Halon extinguisher.														

DUSTER REFILL 12OZ TX2503														
6512772	1	CS					IL	IN	MI	OH	WI			
							31	31	31	31	31			
Compressed Gas canister for use w/Microduster Valve Assy M6019-1, non-toxic.														

FILTER											
300098241 FILTER 24IN X 24IN X 2IN											
N		EA	12		1	12					

300098589 FILTER AAF 24X24X2IN AMA 300 MARK 80											
N		CT	1		2	1	Carton of 10.				

ELBOW											
900451626 ELBOW 217 INTERNAL											
N		EA	1	2	1						

300098258 FILTER AIR 12IN X 24IN X 2IN											
N		EA	12		1	12					

401252754 FILTER AIR 16IN X 20IN X 1IN											
N		EA	12		1	12	30% EFF, used to filter air in heating and air conditioning systems, 12 per case.				

FILTER AIR 16IN X 25IN X 1IN														
5297861	1	EA					IL	IN	MI	OH	WI			
							31	31	31	31	31			

DISTRIBUTION SERVICES

NETWORK SERVICES

TOOLS

BUILDING JANITORIAL

AUTOMOTIVE

FORMS/OFFICE SUPPLIES

GENERAL

DATA VOICE

FILTER

PRODUCT IDENTIFIER		DESCRIPTION						
ITEM NUMBER	ORD. MULT.	SELL UNIT	STD. PKG. STOCK AVAILABILITY / PA	LEAD TIME	MIN. ORD.	A	C	
401331160 FILTER AIR 20IN X 25IN X 1IN								
N		EA	12	1	12			
Used to filter air in heating and air conditioning systems, 12 per case.								
260438072 FILTER AIR NTI A0351171								
N		EA	50	3	100			
260438098 FILTER AIR NTI A0351172								
N		EA	80	3	160			
260438080 FILTER AIR NTI A0351173								
N		EA	35	3	105			
400143640 FILTER CK07406 L2 16X20X2								
N		EA	12	2	12			
400143657 FILTER CK07406 L2 16X25X2								
1199596	1	EA	IL IN MI OH WI 31 31 31 31					
Air filter.								
400143665 FILTER CK07406 L2 20X20X2								
1156224	1	EA	IL IN MI OH WI 31 31 31 31 31					
Air filter.								
400143673 FILTER CK07406 L2 20X25X2								
5298026	1	EA	IL IN MI OH WI 31 31 31 31					
Air filter.								
280071374 FILTER MEDIA PAD 20IN X 20IN X 1IN								
N		CT	1	2	1			
Fiber glass.								
280071531 FILTER MEDIA PAD 24IN X 24IN X 2IN								
N		CT	1	2	1			
Fiber glass.								
260321161 FILTER SWINNEX ASSM TX601 SCRIN								
N		EA	1	1	1			
Filter disc & Washer, filters compressed air to 1.2 microns.								
300098647 FILTER TYPE II DP 12 X 20 X 8IN								
N		CT	1	2	1			
Cartons of 10 & 20.								
300098688 FILTER TYPE II DP 12 X 24 X 12IN								
N		CT	1	2	1			
Cartons of 20.								
300098654 FILTER TYPE II DP 16 X 20 X 8IN								
N		CT	1	2	1			
Cartons of 10.								
300098662 FILTER TYPE II DP 20 X 25 X 8IN								
N		CT	1	2	1			
Cartons of 10.								
300098670 FILTER TYPE II DP 24 X 24 X 8IN								
N		CT	1	2	1			
Cartons of 10.								

PRODUCT IDENTIFIER		DESCRIPTION						
ITEM NUMBER	ORD. MULT.	SELL UNIT	STD. PKG. STOCK AVAILABILITY / PA	LEAD TIME	MIN. ORD.	A	C	
300098696 FILTER TYPE II DP 24 X 24 X 12IN								
N		CT	1	2	1			
Cartons of 10.								
300098456 FILTER TYPE II PLEATED 8 X 48 X 1IN								
N		CT	1	2	1			
Cartons of 6 & 12.								
300098464 FILTER TYPE II PLEATED 9 X 28 X 1IN								
N		CT	1	2	1			
Cartons of 6 & 12.								
300098472 FILTER TYPE II PLEATED 12 X 20 X 1IN								
N		CT	1	2	1			
Cartons of 6 & 20.								
300098530 FILTER TYPE II PLEATED 12X24X2IN MARK 80								
N		CT	1	2	1			
Cartons of 12 & 20.								
300098480 FILTER TYPE II PLEATED 15 X 20 X 1IN								
N		CT	1	2	1			
Cartons of 10 & 12.								
300098498 FILTER TYPE II PLEATED 16 X 20 X 1IN								
N		CT	1	2	1			
Cartons of 10 & 12.								
300098548 FILTER TYPE II PLEATED 16 X 20 X 2IN								
N		CT	1	2	1			
Cartons of 10 & 12.								
300098506 FILTER TYPE II PLEATED 16 X 25 X 1IN								
N		CT	1	2	1			
Cartons of 10 & 12.								
300098555 FILTER TYPE II PLEATED 16 X 25 X 2IN								
N		CT	1	2	1			
Cartons of 10 & 12.								
300098597 FILTER TYPE II PLEATED 16 X 25 X 4IN								
N		CT	1	2	1			
Cartons of 5 & 6.								
300098605 FILTER TYPE II PLEATED 18 X 24 X 4IN								
N		CT	1	2	1			
Cartons of 5.								
300098613 FILTER TYPE II PLEATED 20 X 16 X 4IN								
N		CT	1	2	1			
Cartons of 5 & 6.								
300098514 FILTER TYPE II PLEATED 20 X 20 X 1IN								
N		CT	1	2	1			
Cartons of 10 & 12.								
300098563 FILTER TYPE II PLEATED 20 X 20 X 2IN								
N		CT	1	2	1			
Cartons of 10 & 12.								
300098522 FILTER TYPE II PLEATED 20 X 25 X 1IN								
N		CT	1	2	1			
Cartons of 10 & 12.								

PRODUCT IDENTIFIER		DESCRIPTION				
ITEM NUMBER	ORD. MULT.	SELL UNIT	STD. PKG. STOCK AVAILABILITY / PA	LEAD TIME	MIN. ORD.	A C
300098571		FILTER TYPE II PLEATED 20 X 25 X 2IN				
N		CT	1	2	1	
Cartons of 10.						
300098621		FILTER TYPE II PLEATED 20 X 25 X 4IN				
N		CT	1	2	1	
Carton of 5.						
300098639		FILTER TYPE II PLEATED 24 X 24 X 4IN				
N		CT	1	2	1	
Carton of 5.						
280027327		FILTER WATER CARTRIDGE G78B3				
N		EA	100	1	100	
CUNO 5 micron.						

FINISH FLOOR

401331285		FINISH FLOOR 207 CYNAMIC				
7369488	1	CO				
Polish, zinc crosslinked formulation for all hard floors except unsealed wood, 5 gallon container.						
401331277		FINISH FLOOR 224 MAINTAINER				
N		CO	1	1	1	
Regloss is formulated to repair wear marks and raise the gloss level, 5 gallon container.						
300067642		FINISH FLOOR BUCKEYE CASTLEGUARD				
N		PL	1	2	1	

400560538		FINISH FLOOR F7 1 GALLON JUG				
2101188	1	CS	IL 31	IN 31	MI 31	OH 31
WI 31						

400560546		FINISH FLOOR F7 5 GALLON CAN				
3365205	1	CN	IL	IN	MI	OH
WI 31 31						

300093119		FINISH FLOOR JOHNSONS COMPLETE				
N		CN	1	1	1	

300067741		FINISH FLOOR JOHNSONS COMPLETE				
6512079	1	PL	IL 31	IN 31	MI 31	OH 31
WI 31						
Non-buffable floor finish. Resists dirt penetration, black heel marks, scuffing and detergent scrubbing, 5 gallon container.						

300067758		FINISH FLOOR JOHNSONS FORTIFY				
N		PL	1	2	1	
Sealer, adheres to alkaline or acid hardened surfaces, eliminates concrete dustings, 5 gallon pail.						

FIRE EXTINGUISHER

SEE EXTINGUISHER FIRE.

FLAG

260300165		FLAG U.S. NYLON 5FT X 8FT				
N		EA	1	2	1	

PRODUCT IDENTIFIER		DESCRIPTION				
ITEM NUMBER	ORD. MULT.	SELL UNIT	STD. PKG. STOCK AVAILABILITY / PA	LEAD TIME	MIN. ORD.	A C
260300173		FLAG U.S. NYLON 6FT X 10FT				
N		EA	1	2	1	

FLUID CLEANING

996486304		FLUID CLEANING B 1 PINT CA08236				
1157388	1	CN				
1,1,1 Trichlorethylene for cleaning purposes, BSP 081-500-111.						

FLUID WASHING

400144978		FLUID WASHING CK16436 L1				
1157446	1	CT				
1 gallon used in cleaning and treating banks, commutators and wipers of 197 and 198 switches in step-by-step offices and PBX's, BSP 069-501-801. DISCONTINUE UPON STOCK DEPLETION						

401347182		FLUID WASHING CK16436 L2				
4431387	1	CS	IL 31	IN 31	MI 31	OH 31
WI 31						
A non-abrasive washing fluid used for cleaning of banks, commutator contracts and wipers. Contains 15% oil and can be used when cleaning does not respond to the L1 fluid.						

FRAME DUST MOP

260301007		FRAME DUST MOP SN530F0 5IN X 30IN				
N		EA	1	1	1	
260448089		FRAME DUST MOP #CZ36FO 36IN CLIP-ON				
N						
260447917		FRAME #29536 5 X 36IN DUST MOP				
N						

FRESHENER AIR

260301015		FRESHENER AIR 0851 CHERRY ALMOND				
N		EA	1	1	1	
12 per box.						
260301205		FRESHENER AIR D30 MOUNDS ODOR END				
N		EA	1	1	1	
280009465		FRESHENER AIR SPRAY 15OZ				
N		CS	1	2	1	
Specify lemon, mint, or belair, case of 12.						
260301502		FRESHENER AIR SPRAY C131 CHEX				
N		EA	1	1	1	
Glycol, mint.						
260301494		FRESHENER AIR SPRAY C136 CHEX				
N		EA	1	1	1	
Glycol, lemon.						

DISTRIBUTION SERVICES

NETWORK SERVICES

TOOLS

BUILDING JANITORIAL

AUTOMOTIVE

FORMS/OFFICE SUPPLIES

GENERAL

DATA VOICE

FUNNEL

DISTRIBUTION SERVICES

PRODUCT IDENTIFIER		DESCRIPTION				
ITEM NUMBER	ORD. MULT.	SELL UNIT	STD. PKG. STOCK AVAILABILITY / PA	LEAD TIME	MIN. ORD.	A C

PRODUCT IDENTIFIER		DESCRIPTION				
ITEM NUMBER	ORD. MULT.	SELL UNIT	STD. PKG. STOCK AVAILABILITY / PA	LEAD TIME	MIN. ORD.	A C

FUNNEL

401334255						
N		EA	1	2	15	
401334271 FUNNEL TIN 4IN W/STRAINER						
N		EA	1		1	

260448113						
N						
260447883 HANDLE BROOM #2004-6 6FT METAL TIP						
N						
Threaded.						

NETWORK SERVICES

GLASS CLEANER

SEE CLEANER GLASS.						
260447990						
N						
260447990 GLOVE LATEX #6024 LINED BLUE MEDIUM						
N						

400148052 HANDLE BRUSH FLOOR HAIR 60IN						
1182386	1	EA	IL 31	IN 31	MI 31	OH 31
Replacement 60in wood & steel handle for the hair floor brush. Has a hanger bolt at one end for attaching to brush. DISCONTINUE UPON STOCK DEPLETION						

TOOLS

GLOVE HOUSEHOLD

260447982						
N						
260447982 GLOVE LATEX #6023 LINED BLUE SMALL						
N						

260301064						
N		EA	1	1	1	
260301064 HANDLE MOP 4110 STANDARD 54IN						

BUILDING JANITORIAL

GLUE

260409263						
N		BT	1	1	1	
White. NOW AVAILABLE THROUGH TOUCH-TONE ORDER ENTRY.						
260409461						
N		EA	1	1	1	
NOW AVAILABLE THROUGH TOUCH-TONE ORDER ENTRY.						

400148102 HANDLE MOP CA06625						
1182469	1	DZ	IL 31	IN 31	MI 31	OH 31
60in wooden handle water mop, rust resistant plating, large wing nut clamp for holding mops to avoid marring furniture and woodwork.						

AUTOMOTIVE

GREASE

400146676						
1180844	1	CN				
Used with CK7461 grease gun for bearings of motors in teletypewriter service and 200 type selectors. Case of 24 cans. BSP 159-440-801.						

260448071						
N						
260448071 HANDLE MOP DUST #COH 60IN X 30IN CLIP-ON						

FORMS/OFFICE SUPPLIES

400146668						
1180828	1	TU	IL 31	IN 31	MI 31	OH 31
400146668 GREASE CK7471 4OZ TUBE						

4001338629 HANDLE PUSHBROOM STRAIGHT 60IN						
1182600	1	EA	IL 31	IN 31	MI 31	OH 31
Wooden handle tapered on one end to fit socket in head of straight pushbroom, 14in. DISCONTINUE AND FORWARD TO HANDLE STRAIGHT 60IN W/TAPERED END UPON STOCK DEPLETION						

GENERAL

HAND CLEANER

SEE CLEANER HAND.						
-------------------	--	--	--	--	--	--

260301056						
N		EA	1	1	1	
260301056 HANDLE SNH 15/16						

HAND CREAM

SEE CREAM HAND.						
-----------------	--	--	--	--	--	--

260302963 HANDLE STRAIGHT 60IN W/TAPERED END						
1939744	1	EA	IL 31	IN 31	MI 31	OH 31
Use with Broom Straight Push 14in (1117465).						

DATA VOICE

HANDLE

260301049						
N		EA	1	1	1	
260301049 HANDLE 7081 HARDWOOD 5FT						
Threaded metal tip.						

260301072 HANGER 515 MOP AND BROOM 7/8IN						
N		EA	1	1	1	
1 1/4in handle.						

HANGER

DISTRIBUTION SERVICES

NETWORK SERVICES

TOOLS

BUILDING JANITORIAL

AUTOMOTIVE

FORMS/OFFICE SUPPLIES

GENERAL

DATA VOICE

PRODUCT IDENTIFIER		DESCRIPTION					
ITEM NUMBER	ORD. MULT.	SELL UNIT	STD. PKG. STOCK AVAILABILITY / PA	LEAD TIME	MIN. ORD.	A C	
HOLDER							
260410469 HOLDER ID CARD 4009 K-09							
N		EA	1	1	1		
3-5/8 X 2-1/2IN. Wisconsin. NOW AVAILABLE THROUGH TOUCH-TONE ORDER ENTRY.							
260410568 HOLDER ID CARD 9705 K-10							
N		EA	1	1	1		
3-5/8 X 2-1/2IN. Wisconsin. NOW AVAILABLE THROUGH TOUCH-TONE ORDER ENTRY.							
280021452 HOLDER TISSUE RT22 12/CT							
N		CT	1	2	1		
ICE REMOVAL							
260300827 DE-ICE 160LB DRUM							
N		DR	1	1	1		
300078045 ICE FIGHTER PLUS MELTER 100LB DRUM							
1162685	1	DR	IL IN MI OH WI 31 31 31 31 31				
Winter ice melter pellets in plastic lined, metal top & bottom drum.							
INHIBITOR							
280048042 INHIBITOR CORROSION LCS20							
1927137	1	DR					
290lb drum. Used to maintain ph level in low make-up boilers.							
INSECTICIDE							
300044633 INSECT CONTROL GRANULAR 4485							
N		CS	1	1	1		
260301080 INSECTICIDE C003 CHEX FOGGING							
N		EA	1	1	1		
12 per case.							
260301098 INSECTICIDE C301 ROACH & ANT							
N		EA	1	1	1		
Residual killer.							

PRODUCT IDENTIFIER		DESCRIPTION					
ITEM NUMBER	ORD. MULT.	SELL UNIT	STD. PKG. STOCK AVAILABILITY / PA	LEAD TIME	MIN. ORD.	A C	
405078114 INSECTICIDE CONTROLLED RELEASE							
1930784	1	CS	IL IN MI OH WI 31 31 31 31 31				
An insecticide product contained in a 4 ounce plastic canister. To be used in pedestal type closures and cabinets infested by ants, wasps, cockroaches, etc. Case of 24.							
							
1930784							
280022559 INSECTICIDE STRIP							
N		DZ	1	2	1		
260301544 INSECTICIDE STRIP STARBAR							
N		EA	1	1	1		
KIT							
260320361 KIT CLEANING TX204 TAPE TRANSPORT							
N		EA	1	3	1		
Includes aerosol cleaner, swabs, wipes and case.							
260321096 KIT CLEANING TX211 CRT TERM							
N		EA	1	3	1		
Use for cleaning & static control of terminal screens, housings, and surrounding work area.							
LACQUER							
401494067 LACQUER VINYL PRESSURIZED BLACK							
5250589	1	EA					
12 3/4oz can.							
401494075 LACQUER VINYL PRESSURIZED GREEN							
5248286	1	EA	IL IN MI OH WI 31 31 31 31 31				
12 3/4oz can.							
LAMP							
100316637 LAMP 2Y							
1197186	1	EA					
Carbon filament lamps used with 12, 30, 34 or similar type lamp sockets, 48V.							
401343652 LAMP 15A15 120 VOLTS GE							
5298349	2	EA	IL IN MI OH WI 31 31 31 31 31				

DISTRIBUTION SERVICES

LAMP

PRODUCT IDENTIFIER		DESCRIPTION					
ITEM NUMBER	ORD. MULT.	SELL UNIT	STD. PKG. STOCK AVAILABILITY / PA	LEAD TIME	MIN. ORD.	A C	

280011628 LAMP 20T 6 1/2 CF SYL
N EA 1 2 1

260423447 LAMP 24E
N EA 1 1 1

NETWORK SERVICES

401343678 LAMP 25A 125-130 VOLTS
6252148 1 EA IL IN MI OH WI
31 31 31 31 31

280011636 LAMP 25T 6 1/2 CF SYL
N EA 1 2 1

280018540 LAMP 35A2
N EA 1 2 1

TOOLS

450005517 LAMP 40A 120 VOLTS WEST
N EA 120 2 120
40 watt, 19/8 inches in diameter x 4 1/4 inches long, medium base, inside frosted, package of 120.

996257408 LAMP 50A21-3 RH 47V
N EA 1 1 1

BUILDING JANITORIAL

997677869 LAMP 50W 47V A21 IF LIGHTING
5298364 1 EA IL IN MI OH WI
31 31 31 31 31
Left hand thread used for emergency lighting.

280011644 LAMP 60 MB GE
N EA 1 2 1
Indicator - bulb T-2 amps .05 M5CD - .73 - Pilot.

280018557 LAMP 60 WATT INCANDESCENT
N EA 1 2 1

AUTOMOTIVE

450004841 LAMP 60A 120 VOLTS WEST
2398784 1 EA IL IN MI OH WI
31 31 31 31 31
60 watt, 19/8 inches in diameter X 47/16 inches long, med. base, inside frosted, package of 120.

FORMS/OFFICE SUPPLIES

280025396 LAMP 65-84047E01
N EA 1 2 10

280011651 LAMP 75 PAR FL SYL
N EA 1 2 1

280018565 LAMP 75 WATT
N EA 1 2 1

GENERAL

450005996 LAMP 75A 120 VOLTS WEST
2398800 1 EA IL IN MI OH WI
31 31 31 31 31
A 75 Watt 19/8in in diameter, 4 7/16in long, incandescent, medium base, inside frosted. For use with portable lamp and other rough service applications.

DATA VOICE

280018573 LAMP 75A FROSTED
N EA 1 2 1

PRODUCT IDENTIFIER		DESCRIPTION					
ITEM NUMBER	ORD. MULT.	SELL UNIT	STD. PKG. STOCK AVAILABILITY / PA	LEAD TIME	MIN. ORD.	A C	

403489974 LAMP 75A RST
1160291 1 EA IL IN MI OH WI
31 31 31 31 31
For rough service.

280013012 LAMP 93 12 VOLTS GE
N EA 1 2 3

450005830 LAMP 100A 120 VOLTS WEST
N EA 120 4 120

401343736 LAMP 100A 130 VOLTS 99 EX-LIFE
N EA 120 2 120

401343744 LAMP 100A GE
N EA 1

401360508 LAMP 100A RS 120 VOLTS WEST
N EA 1
100 watt, 120 volt, rough service lamp. Intended for use in circumstances that would cause premature failure of a standard lamp.

401347216 LAMP 100A21/RS 120 VOLTS GE
7218743 1 EA IL IN MI OH WI
31 31 31 31 31
Rough service lamp.

400998290 LAMP 100A/90WM
1214619 1 EA IL IN MI OH WI
31 31 31 31 31

280018524 LAMP 120 PSB GE
N EA 1 2 1

280046004 LAMP 130V 18117 60 PER CASE
N EA 1 2 1
Frosted appliance scale illuminator.

450006135 LAMP 150 PAR FL 120V WEST
2398867 1 EA IL IN MI OH WI
31 31 31 31 31
A 150 watt flood light, heat resistant glass bulb, medium skirted base. Indoor or outdoor. Replacement for Lamp Splicers JP-3475 (300086238).

280018532 LAMP 150 WATT
N EA 1 2 1

450005939 LAMP 150A 120 VOLTS WEST
2398842 1 EA IL IN MI OH WI
31 31 31 31 31
150 Watt, 23/8in in diameter, 6 5/16in long, medium base, inside frosted.

400998332 LAMP 150A 125 VOLTS CHAMPION
N EA 60 2 60

401343769 LAMP 150A 135WM 130 VOLTS
6299065 1 EA IL IN MI OH WI
31 31 31 31 31

260338231 LAMP 150W RS 120 VOLTS 19616
N EA 1 3 1

PRODUCT IDENTIFIER		DESCRIPTION					
ITEM NUMBER	ORD. MULT.	SELL UNIT	STD. PKG. STOCK AVAILABILITY / PA	LEAD TIME	MIN. ORD.	A C	
401343827 LAMP 200 IF GE							
N		EA	60	2	60		
Inside frosted incandescent light bulb.							
400860615 LAMP 382 GE							
N		EA	10	1	10		
280024704 LAMP 6490							
N		EA	1	2	1		
401122619 LAMP 7387 GE							
5415422	1	EA	IL IN MI OH WI 31 31 31 31 31				
Miniature indicator lamp. DISCONTINUE AND FORWARD TO LENS INDICATOR 1D UPON STOCK DEPLETION							
280018300 LAMP 67406 CLEAR LU 100/MED							
N		EA	1	2	1		
100316686 LAMP A1 24 VOLTS .045 AMPS							
1223172	1	EA	IL IN MI OH WI 31 31 31 31 31				
Used with 12, 30, 34 or similar type lamp sockets. BSP 032-501-901.							
100316702 LAMP A3 24 VOLTS .033 AMPS							
1149419	1	EA	IL IN MI OH WI 31 31 31 31 31				
Used with 12, 30, 34 or similar type lamp sockets. BSP 032-501-901.							
100316736 LAMP B2 18 VOLTS .048 AMPS							
1225979	1	EA	IL IN MI OH WI 31 31 31 31 31				
Used with 12, 30, 34 or similar type lamp sockets. BSP 032-501-901.							
400471991 LAMP CK16197 L2							
1299081	1	EA	IL IN MI OH WI 31 31 31 31 31				
Package of 10. For use in CK14762 portable lamps where they are to be used on 48 volts, BSP 074-235-109.							
300024627 LAMP DDS							
N		EA	10	1	10		
280010513 LAMP DISPLAY BLACK BUSY							
N		EA	1	2	1		
GB11720-13-50-10.							
100316769 LAMP E1 6 VOLTS .045 AMPS							
1168625	1	EA	IL IN MI OH WI 31 31 31 31 31				
300024593 LAMP ELH							
N		EA	10	1	10		
300031606 LAMP ENH							
N		EA	1	2	1		
280018318 LAMP EXIT BAYONET 20T 6 1/2							
N		EA DC/CF.	1	2	1		

PRODUCT IDENTIFIER		DESCRIPTION					
ITEM NUMBER	ORD. MULT.	SELL UNIT	STD. PKG. STOCK AVAILABILITY / PA	LEAD TIME	MIN. ORD.	A C	
401257837 LAMP F 6T 5 D GE							
8193722	1	EA	IL IN MI OH WI 31 31 31 31				
401344023 LAMP F 8T 5 GE							
6244822	1	EA	IL IN MI OH WI 31 31 31 31				
401617600 LAMP F13T 8 CW GE							
5288043	1	EA	IL IN MI OH WI 31 31 31 31				
450004023 LAMP F15T 8 CW WEST							
2398966	1	EA	IL IN MI OH WI 31 31 31 31				
280018326 LAMP F15T12 CW							
N		EA	1	2	1		
280018359 LAMP F15T12 CW SYL 21532							
N		EA	1	2	1		
450004296 LAMP F20T12 CW GE							
6352021	1	EA	IL IN MI OH WI 31 31 31 31				
Light, fluorescent, 2ft, cool white.							
300041290 LAMP F30T12 CW/RS/WM							
6508309	1	EA	IL IN MI OH WI 31 31 31 31				
Fluorescent light tube, used in ceiling and desk lamp fixture.							
300070364 LAMP F30T12 WW/RS							
6512665	1	EA	IL IN MI OH WI 31 31				
400492583 LAMP F40 CW							
1199232	30	EA	IL IN MI OH WI 31 31 31 31				
280051087 LAMP F40 CW RS SS							
N		EA	1	3	1		
280018367 LAMP F40 CW RS U6							
N		CS	12	4	12		
Case of 12.							
280018383 LAMP F40 CW U3							
N		EA	12	4	12		
300041282 LAMP F40 CW/RS/WM							
N		EA	1		1		
300068103 LAMP F40 CW/SS							
5120675	1	EA	IL IN MI OH WI 31 31 31 31				
300041266 LAMP F40 LW/SS							
6508333	30	EA	IL IN MI OH WI 31 31 31 31				
280018375 LAMP F40 WW/RS/SS							
N		CS	1	2	1		
Case of 30.							

DISTRIBUTION SERVICES

NETWORK SERVICES

TOOLS

BUILDING JANITORIAL

AUTOMOTIVE

FORMS/OFFICE SUPPLIES

GENERAL

DATA VOICE

DISTRIBUTION SERVICES

LAMP

PRODUCT IDENTIFIER		DESCRIPTION				
ITEM NUMBER	ORD. MULT.	SELL UNIT	STD. PKG. STOCK AVAILABILITY / PA	LEAD TIME	MIN. ORD.	A C

401344080 LAMP F48 PG17C GE
N EA 12 2 12

280018342 LAMP F48T12 CW HO
N EA 30 4 30
21146.

280018391 LAMP F96T12 CW/HO/SS COOL WHITE
N EA 15 4 15
21010.

280018409 LAMP F96T12 WW/HO W/END CLIP
N EA 1 2 1

280011594 LAMP FB40 CW/6 SYL
N EA 12 3 12

280025446 LAMP FC 8T9 CW RS
N EA 1 2 1

400469979 LAMP FC 8T9 CW WEST
7278721 1 EA IL IN MI OH WI
31 31 31 31 31
Circular fluorescent lamp for telephone booth illumination.

450005202 LAMP FC12T9 CW 125 VOLTS
2399063 1 EA IL IN MI OH WI
31 31 31 31 31
32 watt, 1 1/4 inches in diameter, 12 inches circline fluorescent lamp, cool white.

450005244 LAMP FC16T9 CW RS
1198242 1 EA IL IN MI OH WI
31 31 31 31 31
40 watt, 1 1/4 inches in diameter, 16 inches circline fluorescent lamp. Package of 12.

401344130 LAMP FLOOD 400G 120 VOLTS
1198044 1 EA IL IN MI OH WI
31 31 31

280018334 LAMP FLUORESCENT TUBE 4IN 24594
N CS 1 2 1

100316827 LAMP G2
N EA 1 1 1
Used with 12, 30, 34 or similar type lamp sockets. BSP 032-501-901.

280018433 LAMP HR 100DX38
N EA 1 2 1

100316876 LAMP K2 30VOLTS .032 TO .044 AMPS
1169052 1 EA IL IN MI OH WI
31 31 31 31 31
A portion of this bulb on front of the lamp has a white lacquer coating.

280011602 LAMP LU 150/55 SYL
N EA 1 2 1

280011610 LAMP LU 250/S SYL
N EA 1 2 1

NETWORK SERVICES

TOOLS

BUILDING JANITORIAL

AUTOMOTIVE

FORMS/OFFICE SUPPLIES

GENERAL

DATA VOICE

PRODUCT IDENTIFIER		DESCRIPTION				
ITEM NUMBER	ORD. MULT.	SELL UNIT	STD. PKG. STOCK AVAILABILITY / PA	LEAD TIME	MIN. ORD.	A C

280018458 LAMP LUMALUX 35W-B17 67400 LU 35
N CS 1 2 1
Medium, Sylvania, 12 per case.

100845577 LAMP M1 48 VOLTS
1302042 1 EA IL IN MI OH WI
31 31 31 31 31
Used with 12, 30, 34 or similar type lamp sockets. BSP 032-501-901.

280018490 LAMP METAL ARC MOGUL BASE SYL
N EA 1 2 1
M400 C U 64492.

280018474 LAMP REFLECTOR ELLYSORDIAL
N EA 1 2 1
120ER40, 120 Watts 120 Volts.

280018482 LAMP REFLECTOR FLOOD 75 WATT
N EA 1 2 1

280055674 LAMP SCHADOW 72193
N EA 1

280015595 LAMP T2 120 PSB 120V SYLVANIA
N EA 120 2 30

002052710 LAMP TS3614 110 VOLT AC
N EA 1 4 1

LAMP BALLAST

SEE BALLAST.

LAMP MINIATURE

400998019 LAMP MINIATURE 27
1198283 1 EA

260325030 LAMP MINIATURE 44
N EA 10 1 10

280018599 LAMP MINIATURE 55
N EA 1 2 1
To be used in an indicator light in the AC Distribution Panel.

400998407 LAMP MINIATURE 222
1198325 1 EA IL IN MI OH WI
31 31 31 31 31

400517819 LAMP MINIATURE 327 GE M/D
1198408 1 EA IL IN MI OH WI
31 31 31 31 31
REPLACED BY 996607354.

997305222 LAMP MINIATURE 387 GE
1197848 1 EA IL IN MI OH WI
31 31 31 31 31
28 Volts, .04 Amps, for use in LMX2 equipment.

260325048 LAMP MINIATURE 1813
N EA 10 1 10

PRODUCT IDENTIFIER DESCRIPTION

ITEM	ORD.	SELL	STD. PKG.	LEAD TIME	MIN.	A
NUMBER	MULT.	UNIT	STOCK AVAILABILITY / PA		ORD.	C

LAMPFIELD

280009887 LAMPFIELD BEIGE GB11720-50-10
N EA 1 2 1

LID

260447065 LID FOR RECEPTACLE T1600BG SWINGER BEIGE
N

260448436 LID SWING #3624BR FOR 23 GAL WASTEBASKET
N #3569BR. BROWN.

280009358 LID T1600BG BEIGE SWINGER
N EA 1 3 1
B32 or B25.

260301106 LID T1700BG BEIGE TIP-TOP
N EA 1 1 1
B32 or B25.

260448428 LID #2662BR TOP FOR 23 GAL BROWN WASTE
N BASKET #3569BR. Brown.

LIGHT

260319264 LIGHT EMERGENCY 2V604
N EA 1 2 1

LINER

260301114 LINER 101W BROWN WAXED
N CS 1 1 1
Case of 500.

280009515 LINER 159232 15IN X 9IN X 23IN
N CS 1 1 1
.002 clear.

280009531 LINER 159322 15IN X 32IN
N CS 1 1 1
.002 clear.

280009572 LINER 2317483 23IN X 17IN X 48IN
N CS 1 3 1
3 mil.

260377270 LINER ANTI-STATIC 15IN X 9IN X 23IN
N CS 1 2 1
Poly, pink, 3 mil, case 250.

260377288 LINER ANTI-STATIC 15IN X 9IN X 33IN
N CS 1 2 1
Poly, pink, 3 mil, case 250.

PRODUCT IDENTIFIER DESCRIPTION

ITEM	ORD.	SELL	STD. PKG.	LEAD TIME	MIN.	A
NUMBER	MULT.	UNIT	STOCK AVAILABILITY / PA		ORD.	C

260377262 LINER ANTI-STATIC 23IN X 17IN X 46IN
N CS 1 2 1
Poly, pink, 3 mil, case 100.

280009507 LINER CAN TRASH 15IN X 9IN X 23IN
N BX 1 1 1
Low.

280009523 LINER CAN TRASH 15IN X 9IN X 23IN
N BX 1 1 1
1 mil.

280009556 LINER CAN TRASH 15IN X 9IN X 32IN
N BX 1 1 1
1 mil.

280009549 LINER CAN TRASH 15IN X 9IN X 32IN
N BX 1 1 1
2 mil.

280009564 LINER CAN TRASH 23IN X 17IN X 46IN
N BX 1 1 1
Low.

280009499 LINER CAN TRASH 23IN X 17IN X 46IN
N BX 1 1 1
2 mil.

260301122 LINER P2410 15IN X 9IN X 24IN
N CS 1 1 1
.001 buff.

260301130 LINER P4820 23IN X 17IN X 48IN .002
N CS 1 1 1
Buff, 125 per case.

260301148 LINER P4820 23IN X 17IN X 48IN .002
N CS 1 1 1
Buff, 125 per case.

300098845 LINER PG2-2210 12IN X 8IN X 22IN
N CS 1 1 1

300098860 LINER PG2-2410 15IN X 9IN X 24IN
N CS 1 1 1

300098837 LINER PG2-4020 20IN X 13IN X 40IN
N CS 1 1 1

300098852 LINER PG2-6130 22IN X 14IN X 60IN
N CS 1 1 1

300093093 LINER PH8-3340 20IN X 13IN X 40IN
N CS 1 1 1
Tuftote.

300093176 LINER PH8-3860 22IN X 16IN X 58IN
N CS 1 1 1
Tuftote.

300098779 LINER RM 5007
N CS 1 1 1

DISTRIBUTION SERVICES

NETWORK SERVICES

TOOLS

BUILDING JANITORIAL

AUTOMOTIVE

FORMS/OFFICE SUPPLIES

GENERAL

DATA VOICE

DISTRIBUTION SERVICES	LINER							PRODUCT IDENTIFIER DESCRIPTION						
	ITEM	ORD.	SELL	STD. PKG.	LEAD TIME	MIN.	A	ITEM	ORD.	SELL	STD. PKG.	LEAD TIME	MIN.	A
	NUMBER	MULT.	UNIT	STOCK AVAILABILITY / PA		ORD.	C	NUMBER	MULT.	UNIT	STOCK AVAILABILITY / PA		ORD.	C
DISTRIBUTION SERVICES	300098787							300038890						
	N		CS	1	1	1		5110254	1	CS	IL IN MI OH WI			
NETWORK SERVICES	300098761							Open twist cotton/rayon blend yarn, handle and frame not included.						
	N		CS	1	1	1		300038908						
TOOLS	LINK LEAD							5110270	1	CS	IL IN MI OH WI			
	900132523							Open twist cotton/rayon blend yarn, handle and frame not included.						
BUILDING JANITORIAL	LINK LEAD FUSIBLE 165 DEGREES							260301163						
	N		BX	1	6	1		N		EA	1	1	1	
AUTOMOTIVE	LOTION HAND							16 ply, 16oz, regular.						
	SEE CLEANER HAND.							260301171						
FORMS/OFFICE SUPPLIES	LUBRICANT							260301189						
	401203963							N		EA	1	1	1	
GENERAL	1200501	1	EA	Pencil type lubricant for door guide of telephone booths and operator chairs.				260301197						
	MASK							260301155						
DATA VOICE	260448345							N		EA	1	1	1	
	MAT							260448055						
	280055831							N		EA	1	1	1	
	1930586	25	CS	A disposable paper drop cloth used when cleaning Flexgel Cables.				260448063						
	MESSAGE WAITING							300098811						
	MITTS							280021593						
	280021627							N		CT	1	2	1	
	N		DZ	1	2	1		Carton of 12.						
	MOP							280021635						
	300038874							N		CT	1	2	1	
	5110239	1	CS	Open twist cotton/rayon blend yarn, handle and frame not included.				280021676						
	300038882							N		EA	1	2	1	
	1178756	1	CS	IL IN MI OH WI				280021668						
	Open twist cotton/rayon blend yarn, handle and frame not included.							400161642						
	MOP DISPOSABLE TREATED 5IN X 24IN							1201764	1	DZ	IL IN MI OH WI			
	Open twist cotton/rayon blend yarn, handle and frame not included.							400161659						
	MOP DISPOSABLE TREATED 5IN X 30IN							1201780	1	DZ	IL IN MI OH WI			
	Open twist cotton/rayon blend yarn, handle and frame not included.							31 31 31 31 31						
	MOP DISPOSABLE TREATED 5IN X 36IN							31 31 31 31 31						
	Open twist cotton/rayon blend yarn, handle and frame not included.													

PRODUCT IDENTIFIER DESCRIPTION

ITEM NUMBER	ORD. MULT.	SELL UNIT	STD. PKG. STOCK AVAILABILITY / PA	LEAD TIME	MIN. ORD.	A C
-------------	------------	-----------	-----------------------------------	-----------	-----------	-----

300067808 MOP WEBFOOT 16OZ NARROW BAND
 6512012 1 DZ IL IN MI OH WI
 31 31 31 31
 Seco, cotton, wet mop, looped end construction tail band holds yarn in spread pattern.

300067816 MOP WEBFOOT 24OZ NARROW BAND
 6512004 1 DZ IL IN MI OH WI
 31 31 31 31
 Use with handle, double seamed, for cleaning all general floor areas.

260448394 MOP #150128NAS 20 OZ COTTON WET MOP
 N
 12/CASE.

260447925 MOP #21312S SMALL EXTENDER GREEN WET MOP
 N

260447933 MOP #21412S SMALL EXTENDER BLUE WET MOP
 N

260447941 MOP #21512S SMALL EXTENDER WHITE WET MOP
 N

MOTOR ELECTRIC

260318084 MOTOR ELECTRIC 1/4HP 1725 RPM
 N EA 1 2 1
 120 volt single phase, frame size K 48 enclosed type ODP.

NAPKIN

260406723 NAPKIN LUNCHEON SIZE 350-90
 N CS 1 1 1
 1 ply, 1/4 fold, 13in x 13in, 375 per package, 16 packages per case, 6000 per case.

260301213 NAPKIN LUNCHEON SIZE 377-06 1PLY
 N CS 1 1 1
 375 per package, 6000 per case.

280021874 NAPKIN TIDYNAP 392-01
 N CS 1 2 1
 3 1/2in x 5in, 8000 per case.

300093200 NAPKIN TIDYNAP FH392-01
 N CS 1 1 1

260301221 NAPKIN WHITE 392-01 1PLY
 N CS 1 1 1
 250 per package, 8000 per case.

NAPKIN PAPER

280003245 NAPKIN PAPER
 N CS 1 1 1
 13in x 13in, 6000 per case.

PRODUCT IDENTIFIER DESCRIPTION

ITEM NUMBER	ORD. MULT.	SELL UNIT	STD. PKG. STOCK AVAILABILITY / PA	LEAD TIME	MIN. ORD.	A C
-------------	------------	-----------	-----------------------------------	-----------	-----------	-----

260407853 NAPKIN PAPER 351-90 DINNER SIZE
 N CS 1 2 1
 White, 1 ply, 15in x 17in, 125 per package, 40 packages per case.

260407861 NAPKIN PAPER 352-90 DINNER SIZE
 N CS 1 2 1
 White, 1 ply, 17in x 17in, 500 per package, 8 packages per case.

260407879 NAPKIN PAPER 353-90 DINNER SIZE
 N CS 1 2 1
 White, 2 ply, 15in x 17in, 250 per package, 12 packages per case.

260407887 NAPKIN PAPER 354-90 BEVERAGE SIZE
 N CS 1 2 1
 White, 1/4 fold, 10in x 10in, 1000 per box, 4 boxes per case.

260407895 NAPKIN PAPER 380-90 DISPENSER SIZE
 N CS 1 2 1
 White, tallfold, 7 1/4in x 13 1/2in, 250 per package, 40 packages per case.

260406780 NAPKIN PAPER 381-90 DISPENSER SIZE
 N CS 1 2 1
 White, 9in x 13in, 250 per package, 32 packages per case.

260407903 NAPKIN PAPER 382-90 DISPENSER SIZE
 N CS 1 2 1
 White, lapsize, 13in x 17in, 500 per package, 10 packages per case.

260407911 NAPKIN PAPER 383-90 LARGE DISPENSER SIZE
 N CS 1 2 1
 White, lapsize, 13in x 13in, 500 per package, 12 packages per case.

401349329 NAPKIN PAPER 392-01 COMPACT SIZE
 N CS 12 2 12
 10in x 12in, JR250, Fort Howard.

400559977 NAPKIN PAPER 392-01 SHEET FOLD
 N CS 12 1 12
 White, 1 ply, 9in x 13in, 250 per package, 32 packages per case. REPLACED BY PID 260406780

NAPKIN SANITARY

260301247 NAPKIN SANITARY 8B02 4X2.25X9 PRT
 N CS 1 1 1
 1000 per case.

280026006 NAPKIN SANITARY FEMININE 147
 N CS 1 2 1
 Super maxi pad, Kotex/Modess style, 3in x 1in x 4 1/4in.

DISTRIBUTION SERVICES

NETWORK SERVICES

TOOLS

BUILDING JANITORIAL

AUTOMOTIVE

FORMS/OFFICE SUPPLIES

GENERAL

DATA VOICE

DISTRIBUTION SERVICES

NAPKIN SANITARY

PRODUCT IDENTIFIER		DESCRIPTION						
ITEM NUMBER	ORD. MULT.	SELL UNIT	STD. PKG. STOCK AVAILABILITY / PA	LEAD TIME	MIN. ORD.	A	C	

403040595 NAPKIN SANITARY GUARD 111
 1148353 1 CS IL IN MI OH WI
 31 31 31 31 31
 Maxi pads, 2 3/4in x 3/4in x 9 1/2in, 250 per shipping carton, weight of 10lbs.

403039910 NAPKIN SANITARY GUARD 147
 1203166 1 CS IL IN MI OH WI
 31 31 31 31 31
 Beltless maxi pad, packaged individually, 3in x 1in x 4 1/4in boxes, 250 per shipping carton, weight of 15lbs.

280021890 NAPKIN SANITARY HYNAP 332
 N CS 1 2 1
 3 1/2in x 6 3/4in.

280022476 NAPKIN SANITARY SANIBAG 8B02
 N CS 1 3 1

300098803 NAPKIN SANITARY STAYFREE MAXI 776-4
 N CS 1 1 1

400489423 NAPKIN SANITARY TAMPAX TAMPONS
 1176214 1 CS IL IN MI OH WI
 31 31 31 31 31
 100% cotton, 5 1/8in x 11/16in, 500 per shipping carton, weight of 8lbs.

300093218 NAPKIN SANITARY TAMPONS
 N CS 1 1 1

260301577 NAPKIN SANITARY TAMPONS TAMPAX V05
 N CS 1 1 1

260448295 NAPKIN/TAMPON #1PN DUAL
 N

NIPPLE PREWIRE

NOZZLE

400162681 NOZZLE CREVISE CK14377 L13
 N EA 1 13 1

OIL DRY

300038916 OIL DRY 50LB BAG
 1222927 1 BG
 For use in garages to absorb oil spills.

OIL HOUSEHOLD

900158999 OIL HOUSEHOLD 3 IN 1 3OZ CAN
 1204644 1 CS
 General purpose light lubricating oil.

NETWORK SERVICES

TOOLS

BUILDING JANITORIAL

AUTOMOTIVE

FORMS/OFFICE SUPPLIES

GENERAL

DATA VOICE

PRODUCT IDENTIFIER		DESCRIPTION						
ITEM NUMBER	ORD. MULT.	SELL UNIT	STD. PKG. STOCK AVAILABILITY / PA	LEAD TIME	MIN. ORD.	A	C	

OIL ZORB

260301254 OIL ZORB 50LB BAG STANDARD
 N BG 1 1 1

ORGANIZER POWER

280037409 ORGANIZER POWER LONG MA494B009
 N EA 1 2 1

OUTLET

400866851 OUTLET 5252 HUBBELL DUPLEX
 5288985 1 EA

995084407 OUTLET 5262 HUBBEL
 N EA 10 1 10

PAD

260300157 PAD BRILLO HOTEL SIZE 343W240000
 N BX 1 2 1
 4in x 4in large steel wool soap pads, 10 per box, 12 boxes per case.

401351150 PAD SCOTT BRITE 7448 7IN X 4IN
 1170100 1 CS IL IN MI OH WI
 31 31 31 31 31
 Ultra fine hand pad for light cleaning, finishing or deburring requirements, 6in x 9in, 20 pads per box, 3 boxes per case.

280021916 PAD SCOUR NYLON
 N CT 1 2 1

260321153 PAD WIPING ANTISTATIC SOLUTION
 N PK 1 1 1
 Texstat 100, controls static on workstations, wtrboats, and synthetic surfaces in cleanrooms TX826 68 pads per box.

PAD CLEANING

260321229 PAD CLEANING CONTACT GOLD-WIPES
 N PK 1 1 1
 TX809, 80 Pads per box, clean, lubricate, protect contacts.

260321252 PAD CLEANING CRT SCREEN 1 STEP
 N BX 1 1 1
 Antistatic, ultra thin, 80 pads per package.

260321237 PAD CLEANING CRT SCREEN WET/DRY
 N PK 1 1 1
 Twin packs, 1 wet & 1 dry, cleans, dries, controls static TX812, 40 twin packs per box.

PRODUCT IDENTIFIER		DESCRIPTION				
ITEM	ORD.	SELL	STD. PKG.	LEAD TIME	MIN.	A
NUMBER	MULT.	UNIT	STOCK AVAILABILITY / PA		ORD.	C
260321203 PAD CLEANING HAND TOWELETTE						
N		PK	1	3	1	
Pre-moistened, with an ink removing formulation containing lanolin, 72 pads per box.						
001187301 PAD CLEANING TX 801 MAGTPHD						
N		BX	1	1	1	
Used to clean tape heads, tape transport components, magnetic disc surfaces, 3in x 4in applicator. Box of 80.						
260321211 PAD CLEANING TX 806						
N		PK	1	1	1	
Isopropyl alcohol and deionized water used for component cleaning. Box of 80.						
260320346 PAD CLEANING TX 808 PHONE-WIPES						
N		PK	1	1	1	
Presaturated pads used on telephones, headsets, communication equipment to sanitize, 72 pads per box.						

PAD FLOOR

260301270 PAD FLOOR BUFFING 13IN RED 70130						
N		EA	1	2	1	
Thick, nylon.						
300038924 PAD FLOOR BUFFING 15						
5110312	1	CS	IL	IN	MI	OH
			31	31	31	31
Pad used with buffer for polishing floors, red, 5 per case.						
300093143 PAD FLOOR BUFFING 17IN RED 51						
N		CS	1	1	1	
401351127 PAD FLOOR BUFFING 17IN RED 51						
1329029	1	CS	IL	IN	MI	OH
			31	31	31	31
5 per box.						
401351135 PAD FLOOR BUFFING 17IN WHITE 51						
1329086	1	EA	IL	IN	MI	OH
			31	31	31	31
Super polish.						
300038932 PAD FLOOR BUFFING 19						
5110338	1	CS	IL	IN	MI	OH
			31	31	31	31
Specially designed for spray cleaning, cleans when damp, buffs when dry, tan, 5 per case.						
300038940 PAD FLOOR BUFFING 20						
1178939	1	CS	IL	IN	MI	OH
			31	31	31	31
Designed for spray cleaning, cleans when damp, buffs when dry, tan, 5 per case.						
260301262 PAD FLOOR BUFFING 20IN TAN 30200						
N		EA	1	1	1	
Thick, nylon.						
280021908 PAD FLOOR BUFFING 20IN TAN NYLON						
N		EA	1	2	1	

PRODUCT IDENTIFIER		DESCRIPTION				
ITEM	ORD.	SELL	STD. PKG.	LEAD TIME	MIN.	A
NUMBER	MULT.	UNIT	STOCK AVAILABILITY / PA		ORD.	C
300038957 PAD FLOOR STRIPPING 15						
5110353	1	CS	IL	IN	MI	OH
			31	31	31	31
Pad for buffer for stripping old wax.						
401351119 PAD FLOOR STRIPPING 17						
1328963	1	EA	IL	IN	MI	OH
			31	31	31	31
Blue, 5 per case.						
300067857 PAD FLOOR STRIPPING 17IN BLACK						
N		CS	1	2	1	
5 per case.						
300067873 PAD FLOOR STRIPPING 17IN BROWN						
1221473	1	CS	IL	IN	MI	OH
			31	31	31	31
5 per case.						
300038965 PAD FLOOR STRIPPING 19						
1209973	1	CS	IL	IN	MI	OH
			31	31	31	31
Black, 5 per case.						
300038973 PAD FLOOR STRIPPING 20IN BLACK						
5110379	1	CS	IL	IN	MI	OH
			31	31	31	31
For wet stripping to completely remove old wax and finish.						
260448329 PAD FLOOR #10150 15IN BLACK NYLON STRIP						
N						

PAIL

SEE BUCKET.

PAINT

900219650 PAINT ALUMINUM OUTSIDE QUART						
N		QT	1		1	
400139325 PAINT ENAMEL SPRAY ALUMINUM 9OZ CAN						
1154880	1	CN	IL	IN	MI	OH
			31	31	31	31
Touch-up paint for building operations.						
400139333 PAINT ENAMEL SPRAY BLACK 9OZ CAN						
1154906	1	CN	IL	IN	MI	OH
			31	31	31	31
400139358 PAINT ENAMEL SPRAY GREEN 9OZ CAN						
1154922	1	CN	IL	IN	MI	OH
			31	31	31	31

DISTRIBUTION SERVICES

NETWORK SERVICES

TOOLS

BUILDING JANITORIAL

AUTOMOTIVE

FORMS/OFFICE SUPPLIES

GENERAL

DATA VOICE

DISTRIBUTION SERVICES

PAINT

PRODUCT IDENTIFIER		DESCRIPTION				
ITEM NUMBER	ORD. MULT.	SELL UNIT	STD. PKG. STOCK AVAILABILITY / PA	LEAD TIME	MIN. ORD.	A C
400789541 PAINT ENAMEL SPRAY GREY/GREEN 9OZ CAN						
2792648	1	CN	IL 31 IN 31 MI 31 OH 31 WI 31			



2792648

400789533 PAINT ENAMEL SPRAY WHITE 9OZ CAN						
2792622	1	CN	IL 31 IN 31 MI 31 OH 31 WI 31			

400139374 PAINT ENAMEL SPRAY YELLOW 9OZ CAN						
1154948	1	CN	IL 31 IN 31 MI 31 OH 31 WI 31			

900209198 PAINT ENAMEL WHITE GLOSS 17 QUART 54-352						
N		EA	6	1	6	

PAN DUST

401351432 PAN DUST 602 B BLACK						
5129981	1	EA	Package of 10.			

260300975 PAN DUST 715HD METAL BLACK ENAMEL 12IN						
N		EA	1	1	1	

400565230 PAN DUST LOBBY USE						
1180059	1	EA	IL 31 IN 31 MI 31 OH 31 WI 31	Bronze, 5 3/4in x 12in x 36 5/8in, complete with handle.		

PAPER TOILET

260407929 PAPER TOILET 100-00 SOFT BEIGE						
N		CS	1	2	1	
Made of 100% PCW, 4 1/2in x 4 1/2in, 500 sheets per roll, 96 rolls per case.						

300098704 PAPER TOILET 120						
N		CS	1	1	1	

260407937 PAPER TOILET 130-90 WHITE						
1972232	1	CS	IL 31 IN 31 MI 31 OH 31 WI 31	Giant roll, 1 ply, 4in x 4000ft, 6 rolls per case.		

PRODUCT IDENTIFIER		DESCRIPTION				
ITEM NUMBER	ORD. MULT.	SELL UNIT	STD. PKG. STOCK AVAILABILITY / PA	LEAD TIME	MIN. ORD.	A C

280022666 PAPER TOILET 143 1 PLY ROLL						
N		CS	1	2	1	
Bosstex.						

402904635 PAPER TOILET 144 1 PLY ROLL						
N		CS	8	1	8	
4 1/2in x 4 1/2in sheets, 1500 sheets per roll, 60 rolls per case. REPLACED BY PID 260406814						

260407945 PAPER TOILET 150-00 SOFT BEIGE						
N		CS	1	2	1	
Made of 100% PCW, 1 ply, 4 1/2in x 4 1/2in, 1000 sheets per roll, 96 rolls per case.						

260407952 PAPER TOILET 151-90 WHITE						
1972224	1	CS	IL 31 IN 31 MI 31 OH 31 WI 31	Jumbo roll, 1 ply, 4in x 2100ft, 12 rolls per case.		

260407960 PAPER TOILET 152-90 WHITE						
N		CS	1	2	1	
Jumbo roll, 2 ply, 4in x 1075ft, 12 rolls per case.						

260407978 PAPER TOILET 153-90 WHITE						
N		CS	1	2	1	
1 ply, 4 1/2in x 4 1/2in, 1000 sheets per roll, 96 rolls per case.						

260406814 PAPER TOILET 154-90 WHITE						
1970749	1	CS	IL 31 IN 31 MI 31 OH 31 WI 31	1 ply, 4 1/2in x 4 1/2in, 1500 sheets per roll, 60 rolls per case.		

260406731 PAPER TOILET 155-90 WHITE						
N		CS	1	1	1	
1 ply, 4 1/2in x 4 1/2in, 1000 sheets per roll, 96 rolls per case.						

260407986 PAPER TOILET 159-00 WHITE						
N		CS	1	2	1	
2 ply, 4 1/2in x 4 1/2in, 500 sheets per roll, 96 rolls per case.						

300038981 PAPER TOILET 171 WHITE INTERFOLDED						
N		CS	20	1	20	
Singlefold, 4in x 5in sheets, 1000 sheets per package, 60 packages per case. REPLACED BY PID 260406749						

300097698 PAPER TOILET 720						
1937227	1	CS	IL 31 IN 31 MI 31 OH 31 WI 31			

401556485 PAPER TOILET 5016						
2602862	1	RL	IL 31 IN 31 MI 31 OH 31 WI 31	150 sheets per roll, 48 rolls per case.		

260321476 PAPER TOILET 7250 WHITE						
1942201	1	CS	IL 31 IN 31 MI 31 OH 31 WI 31	Jumbo roll, 1 ply, 2250ft x 4in, 12 rolls per case.		

NETWORK SERVICES

TOOLS

BUILDING JANITORIAL

AUTOMOTIVE

FORMS/OFFICE SUPPLIES

GENERAL

DATA VOICE

PRODUCT IDENTIFIER							DESCRIPTION						
ITEM	ORD.	SELL	STD. PKG.	LEAD TIME	MIN.	A	ITEM	ORD.	SELL	STD. PKG.	LEAD TIME	MIN.	A
NUMBER	MULT.	UNIT	STOCK AVAILABILITY / PA		ORD.	C	NUMBER	MULT.	UNIT	STOCK AVAILABILITY / PA		ORD.	C
PAPER TOWEL													
SEE TOWEL PAPER.													
PETROLEUM SPIRITS													
SEE SPIRITS PETROLEUM.													
PLATE													
997728530 PLATE FLUSH HUBBEL 91091													
N		EA	100		1	100							
401357462 PLATE FLUSH HUBBEL 91101													
5219105	1	EA	IL	IN	MI	OH	WI						
			31	31	31	31	31						
PLUG													
402201248 PLUG 5280C HUBBEL													
1121541	1	EA											
401999487 PLUG 5965 NYLON YELLOW													
1112102	1	EA	IL	IN	MI	OH	WI						
			31	31	31	31	31						
A three wire power plug with parallel prongs.													
260359757 PLUG 5969VY NYLON HUBBELL													
1953554	1	EA	IL	IN	MI	OH	WI						
			31	31	31	31	31						
400936779 PLUG CONDUIT ROUND 4IN CA06190													
N		EA	1		3	15							
300062544 PLUG CP3034 CLOSURE HUBBELL													
N		EA	1		1	1							
PLUNGER													
260301320 PLUNGER TOIL-A-FLEX													
N		EA	1		1	1							
POLISH													
400560702 POLISH AUTO LIQUID P70 PINT CAN													
N		CS	1										
260301338 POLISH BLUE SATIN STAINLESS STEEL													
N		EA	1		1	1							
12 per case.													
260301346 POLISH FURNITURE C811 CHEX													
N		EA	1		1	1							
Spray & Shine lemon 12 per case.													

PRODUCT IDENTIFIER							DESCRIPTION						
ITEM	ORD.	SELL	STD. PKG.	LEAD TIME	MIN.	A	ITEM	ORD.	SELL	STD. PKG.	LEAD TIME	MIN.	A
NUMBER	MULT.	UNIT	STOCK AVAILABILITY / PA		ORD.	C	NUMBER	MULT.	UNIT	STOCK AVAILABILITY / PA		ORD.	C
400356341 POLISH FURNITURE LIQUID QUART CAN													
5299305	1	CS	IL	IN	MI	OH	WI						
			31	31	31	31	31						
A wax-silicon polish suitable for all furniture polishing purposes, lemon scent, 12 quarts per case.													
280026279 POLISH FURNITURE PLEDGE ORIGINAL													
N		CS	1		1	1							
900302886 POLISH METAL 100Z CAN													
5299321	1	CS	IL	IN	MI	OH	WI						
			31	31	31	31	31						
Paste, not intended for painted surfaces.													
280047432 POLISH METAL LIQUID 7 1/2OZ													
N		CS	1		7	9							
Polish used to shine chrome, metal, stainless steel and other metals with a bright finish.													
300093135 POLISH SHINE-UP LEMON JOHNSON													
N		CS	1		1	1							
POWER UNIT													
SEE UNIT POWER.													
PUMICE													
280021999 PUMICE 3361 WASH WELL GREY													
N		CS	1		2	1							
PUMP													
300060449 PUMP FOR ANTI-FOG LENS CLEANER													
N		EA	1										
PUTTY WOOD													
900205808 PUTTY WOOD NATURAL 4OZ CAN													
1150946	1	EA											
For filling holes, cracks, etc. in wood. Putty like compound that resembles wood when dry.													
RAGS													
280022302 RAGS													
N		BD	1		2	1							
300098746 RAGS NEW KNIT SOFT WHITE 25LB													
N		BX	1		1	1							
RECEPTACLE													
260301353 RECEPTACLE 100 SANITARY NAPKIN													
N		EA	1		1	1							
Floor style.													

DISTRIBUTION SERVICES
 NETWORK SERVICES
 TOOLS
 BUILDING JANITORIAL
 AUTOMOTIVE
 FORMS/OFFICE SUPPLIES
 GENERAL
 DATA VOICE

RECEPTACLE

DISTRIBUTION SERVICES

PRODUCT IDENTIFIER		DESCRIPTION				
ITEM NUMBER	ORD. MULT.	SELL UNIT	STD. PKG. STOCK AVAILABILITY / PA	LEAD TIME	MIN. ORD.	A C
280022294		RECEPTACLE	SANITARY	6140		
N		EA	1	2	1	
Napkin 12 1/2 X 5 1/4 X 10 3/4.						

PRODUCT IDENTIFIER		DESCRIPTION				
ITEM NUMBER	ORD. MULT.	SELL UNIT	STD. PKG. STOCK AVAILABILITY / PA	LEAD TIME	MIN. ORD.	A C
SCOURING POWDER						
SEE CLEANSER						

NETWORK SERVICES

RECEPTACLE HUBBELL						
280022237		RECEPTACLE	HUBBELL	2713		
N		EA	1	2	1	
280022245		RECEPTACLE	HUBBELL	5207		
N		EA	1	2	1	
280022229		RECEPTACLE	HUBBELL	5965VY		
N		EA	1	2	1	

SCREEN						
280022500		SCREEN URINAL	160A	100% VINYL		
N		EA	1	3	1	
With removing tool.						
280022492		SCREEN URINAL	164	SWEET PEA		
N		EA	1	3	1	
With 20 day deodorant.						
260448337		SCREEN URINAL	BLOCK	#1000A	12/BOX	
N						

TOOLS

REDUCER						
997784749		REDUCER	FUSE BUSS	213		
N		EA	1	2	1	

SEAL						
900594342		SEAL	DOOR	POLY-LOK	RED	
N		EA	1	2	1	
280026261		SEAL	JOHNSONS	OVER AND UNDER		
N		CN	1	1	1	

BUILDING JANITORIAL

REMOVER SPOT & STAIN						
260301486		REMOVER	SPOT	C830	GONE	
N		EA	1	1	1	
Case of 12.						
260447594		REMOVER	#SR100	STAIN ELIMINATOR	16 OZ	
N					12/Case.	

SHELF BATTERY						
841765647		SHELF BATTERY	841765647			
N		EA	1	15	1	
841765720		SHELF BATTERY	841765720			
N		EA	1	1	1	

AUTOMOTIVE

SALT						
260448048		SALT	ROCK	#ROCKSALT	80#	
N						

SHURWIPE						
SEE CLOTH CLEANING.						

FORMS/OFFICE SUPPLIES

280071366		SALT	SOFTENER	PELLETS		
N		BG	1	1	20	
SAND						
280002460		SAND	SILICA	530	100LB BAG	
N		BG	1	3	1	

SIGN						
260447966		SIGN	#6109	'WET FLOOR'	YELLOW	
N						
260447974		SIGN	#6109-78	'RESTROOM CLOSED'	YELLOW	
N					Floor sign.	

GENERAL

SCOOP						
260448303		SCOOP	#SCOOP	3	QUART PLASTIC	
N						

SILICONE SPRAY						
403549488		SILICONE	SPRAY	3416		
1138057		1	EA			
280003583		SILICONE	SPRAY	CO77		
N		EA	1	1	1	
Case of 12.						

DATA VOICE

PRODUCT IDENTIFIER							DESCRIPTION						
ITEM NUMBER	ORD. MULT.	SELL UNIT	STD. PKG. STOCK AVAILABILITY / PA	LEAD TIME	MIN. ORD.	A C							
SOAP													
260301387 SOAP 1164N9 CALGON LOTION													
N		GL	1	1	1		6 gallons per case.						
260301395 SOAP 2902 AQUA 12/800 ML/CS													
N		BX	1	1	1								
260301411 SOAP 4159 DISHWASHING MACHINE POWDER													
N		DR	1	1	1		50 pounds.						
260318092 SOAP DISHWASHING LIQUID DAWN													
N		CS	1	2	1		Liquid 22oz each, 20 per case.						
260301361 SOAP HAND 2203 BORAXO POWDERED													
N		PK	1	1	1		10 five pound packages per case.						
260301379 SOAP HAND 2403 LURON PINK POWDERED													
N		PK	1	1	1		10 packages per case.						
280022518 SOAP HAND BAR 1190 WHITE GARDENIA													
N		CS	1	2	1		144, #275.						
280022526 SOAP HAND BAR 1191													
N		EA	1	2	1		Pink Apple Blossom.						
260301403 SOAP HAND BAR 3321 EASY TASK													
N		EA	1	1	1		White pumice.						
260300181 SOAP HAND BAR 4 1/2OZ PALMOLIVE GOLD													
N		CS	1	2	1		48 bars per case.						
260301429 SOAP HAND BAR GARDEN BOUQUET 3OZ													
N		EA	1	1	1		P864000.						
280022534 SOAP HAND BAR LAVA													
N		EA	1	2	1		Case of 48.						
300098894 SOAP HAND BAR LAVA													
N		CS	1	1	1								
260301437 SOAP HAND BAR LAVA GREEN PUMICE													
N		EA	1	3	1		Case of 48.						
280026238 SOAP HAND HYPOR LOTION													
N		CS	1	1	1								
400409207 SOAP HAND IVORY 3 OZ BAR													
1262469	1	EA	IL IN MI OH WI 31 31 31 31 31				For general purpose use, individually wrapped bars, 200 per case.						

PRODUCT IDENTIFIER							DESCRIPTION						
ITEM NUMBER	ORD. MULT.	SELL UNIT	STD. PKG. STOCK AVAILABILITY / PA	LEAD TIME	MIN. ORD.	A C							
300093226 SOAP HAND IVORY 3 OZ BAR													
N		CS	1	1	1								
300039039 SOAP HAND LIQUID 357 WEIGHT 9													
5110478	1	CS	IL IN MI OH WI 31 31 31 31				1 gallon.						
300093234 SOAP HAND LIQUID GREEN 912RTU05													
N		GL	1	1	1								
300040334 SOAP HAND LIQUID LOTION 115 ISP													
5111591	1	CS	IL IN MI OH WI 31 31 31 31				Kutel #550, pearlescent pink, 6 one gallon jugs per case.						
280003518 SOAP HAND LIQUID LOTION BORAXO													
N		GL	1	1	1								
280022542 SOAP HAND LURON W/LANOLIN													
N		CS	1	2	1		Powder pink.						
300039047 SOAP HAND SANI FRESH													
5110494	1	CS	IL IN MI OH WI 31 31 31 31				800 milligrams per cartridge, 12 cartridges per case.						
400410817 SOAP HAND SCOURING 4OZ CAKE													
1100305	1	CS	IL IN MI OH WI 31 31 31 31 31				144 per case.						
400614780 SOAP HAND SCOURING POWDER 5LB													
1168070	1	CS	IL IN MI OH WI 31 31 31 31 31				Used to remove oil, grease and soil from hands without harming skin. Phosphate-free granular powder.						
260447818 SOAP HAND #340C1015 LIQUID COCO CASTILE													
N							4 X 1 GA.						
300041258 SOAP LIQUID CARTRIDGE 800MI													
6508358	1	CS	IL IN MI OH WI 31 31 31 31				Go-Jo Perma Pro #9102, 12 800ml cartridges per case.						
400305645 SOAP LIQUID CONCENTRATE													
N		EA	6	2	60		Pure soap readily soluble in water for general use, one gallon can.						
400454625 SOAP SADDLE SHOE SHINE 1LB CAN													
N		EA	12	4	24								
260448279 SOAP #8601 LIQUID HAND FROSTI LEMON A.P.													
N							10/Case. For use in Cormatic Dispenser #L1.						

DISTRIBUTION SERVICES

NETWORK SERVICES

TOOLS

BUILDING JANITORIAL

AUTOMOTIVE

FORMS/OFFICE SUPPLIES

GENERAL

DATA VOICE

SODA BICARB

DISTRIBUTION SERVICES

PRODUCT IDENTIFIER		DESCRIPTION				
ITEM NUMBER	ORD. MULT.	SELL UNIT	STD. PKG. STOCK AVAILABILITY / PA	LEAD TIME	MIN. ORD.	A C
SODA BICARB						

NETWORK SERVICES

900211426 SODA BICARB 5LB PACKAGE						
5256503	1	EA				
Acid neutralizing agent required to be on hand at all Lead acid type battery installations.						
SOLUTION						

TOOLS

260321021 SOLUTION ANTISTATIC TX105A						
N		BX	2	3	2	
14oz cans, 6 cans per box. Used to control static electricity on walls, floors, furniture, all non-conductive synthetic surfaces.						
SOLVENT						

BUILDING JANITORIAL

401548292 SOLVENT CK21446 L1 1 GALLON						
2602623	1	CN				
Intended for the warm solvent immersion (140 degrees Farenheit maximum) removal of waterproof cable filling (petrolatum) compound from cable core.						
401548300 SOLVENT CK21446 L1 5 GALLON						
N		PL	4	2	4	
280017971 SOLVENT FREON TF MS180						
N		EA	1	2	1	

AUTOMOTIVE

260321062 SOLVENT GOLDMIST TX123 16OZ CAN						
N		CS	1	1	1	
6 cans per box. A blend of Freon TF & Polyphenyl Ether. It cleans & lubricates computer interfaces, male & female electrical connectors.						

FORMS/OFFICE SUPPLIES

SPIRITS PETROLEUM						
400409249 SPIRITS PETROLEUM CK07860 GALLON						
1264481	1	CN				
Intended for use as a paint thinner, as a dry cleaning liquid, and for cleaning grease and oil from finished or unfinished metal surfaces.						
400409256 SPIRITS PETROLEUM CK07860 PINT						
1102814	1	CN	IL IN MI OH WI			
31 31 31 31 31						

GENERAL

400409264 SPIRITS PETROLEUM CK07860 QUART						
1264465	1	CN	IL IN MI OH WI			
31 31 31 31 31						

DATA VOICE

SPONGE						
260410923 SPONGE 3IN C-69						
N		EA	1	1	1	
NOW AVAILABLE THROUGH TOUCH-TONE ORDER ENTRY.						

PRODUCT IDENTIFIER		DESCRIPTION				
ITEM NUMBER	ORD. MULT.	SELL UNIT	STD. PKG. STOCK AVAILABILITY / PA	LEAD TIME	MIN. ORD.	A C
260301452 SPONGE CELLULOSE 7546M2 MEDIUM						
N		EA	1	1	1	
48 per case.						

400565602 SPONGE CELLULOSE ART LARGE						
5129924	1	EA	IL IN MI OH WI			
31 31 31 31 31						
4 1/8in x 6 1/4in x 5/8in.						

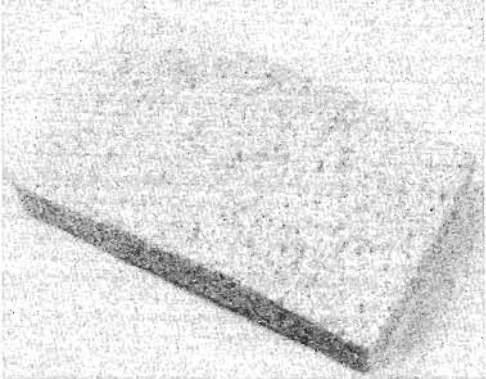

401335906 SPONGE POLY S18A 6 X 4 X 3 1/2IN						
N		EA	1			
DISCONTINUED - REPLACED BY SPONGE CELLULOSE ART LARGE						

401335880 SPONGE SCOT-BRITE SCRUB 74						
6153320	1	CS	IL IN MI OH WI			
31 31 31 31 31						
Medium duty cleaning pad/sponge, abrasive pad on one side, cellulose sponge on one other, 3 1/2in x 6 1/4in.						



401667860 SPONGE SHEEPSWOOL 7 1/2IN X 8IN						
1199513	1	EA	IL IN MI OH WI			
31 31 31						
DISCONTINUE UPON STOCK DEPLETION						

SPOON						
260447081 SPOON CSN43050 HEAVY DUTY PLASTIC 100/BX						
N						

PRODUCT IDENTIFIER		DESCRIPTION					
ITEM NUMBER	ORD. MULT.	SELL UNIT	STD. PKG. STOCK AVAILABILITY / PA	LEAD TIME	MIN. ORD.	A	C
SPRAY							
402071419	1	CN					
1196592 1 CN 402071419 SPRAY CHALK 217 ORANGE 17OZ CAN							
400445532 SPRAY PLASTIC PERMO SEAL 10OZ							
3253427	1	CS	IL IN MI OH WI 31 31 31 31 31				
Plastic seal in spray can.							
SQUEEGEE							
260301536							
260301536 SQUEEGEE 12 COMPLETE ETTORE							
N		EA	1	1			1
260448105 SQUEEGEE 12IN CHANNEL & RUBBER							
N							
260448097 SQUEEGEE 12IN COMPLETE WINDOW							
N							
260316708 SQUEEGEE FLOOR 30IN							
1149211	1	EA	IL IN MI OH WI 31 31 31 31 31				
401336003 SQUEEGEE FLOOR 30IN ALUMINUM							
1940981	1	EA	IL IN MI OH WI 31 31 31 31 31				
Straight frame without handle.							
STARTER							
997763388	1	EA					
1265280 1 EA 997763388 STARTER FLUORESCENT FS 2							
401336409 STARTER FLUORESCENT FS 5 GE							
6244806	1	EA	IL IN MI OH WI 31 31 31 31				
401336425 STARTER FLUORESCENT FS20 GE15/20							
6327221	1	EA	IL IN MI OH WI 31 31 31 31				
401336474 STARTER FLUORESCENT FS40 GE 400							
6327205	1	EA	IL IN MI OH WI 31 31 31 31 31				
STRAP							
900409939							
900409939 STRAP 205 1 HOLE							
N		BX	1	2			1
STRIPPER							
300093101							
300093101 STRIPPER FLOOR WAX STEP-OFF							
N		CN	1	1			1
Johnson.							

PRODUCT IDENTIFIER		DESCRIPTION					
ITEM NUMBER	ORD. MULT.	SELL UNIT	STD. PKG. STOCK AVAILABILITY / PA	LEAD TIME	MIN. ORD.	A	C
300067931 STRIPPER FLOOR ZEP TIME SAVER							
1144907	1	CS	IL IN MI OH WI 31 31				
A powerful, fast acting liquid designed to remove most floor finishes without brushing or other agitation, 8 one gallon jugs per case.							
SWAB							
280301569							
280301569 SWAB 207 DURALON TOILET BOWL							
N		EA	1	1			1
300070588 SWAB COTTON TIPS LINT FREE TX705							
N		PK	1	1			1
Box of 1000 custom swabs for application of solvents and cleaning solutions, small size.							
260321179 SWAB TX700							
N		PK	1	1			1
Foam bonded on cotton bud 6in wood handle. 50 pieces per bag.							
260321187 SWAB TX706							
N		PK	10	3			10
Foam head on 3IN elongated flexible handle, adhesively bonded. 50 piece per bag.							
260321138 SWAB TX710							
N		PK	1	1			1
Mini foam head 4in nylon handle used for accessing deep recessed areas. 50 pieces per bag.							
280021007 SWAB TX813							
N		PK	1	1			1
Premoist w/ alcohol, full-size head on 5in handle, rectangular, thermally-bonded, sealed in foil used for cleaning tape heads. 25 pieces per box.							
SWEEPING COMPOUND							
SEE COMPOUND SWEEPING.							
TAMPONS							
SEE NAPKIN SANITARY.							
TILE							
260300405							
260300405 TILE CEILING 2FT X 4FT X 5/8IN							
N		CT	1	4			1
Armstrong Cortega 823 lay-in ceiling.							
TISSUE							
401346697							
401346697 TISSUE CLEANER SIGHT SAVERS 65							
N		CT	1	3			1
260407994 TISSUE FACIAL 490-90 WHITE							
N		CS	1	2			1
2 ply, 8.33in x 8.0in sheets, 100 sheets per box, 30 boxes per case.							

DISTRIBUTION SERVICES
 NETWORK SERVICES
 TOOLS
 BUILDING JANITORIAL
 AUTOMOTIVE
 FORMS/OFFICE SUPPLIES
 GENERAL
 DATA VOICE

TISSUE

DISTRIBUTION SERVICES

PRODUCT IDENTIFIER		DESCRIPTION				
ITEM NUMBER	ORD. MULT.	SELL UNIT	STD. PKG. STOCK AVAILABILITY / PA	LEAD TIME	MIN. ORD.	A C
280002908 TISSUE FOLDED 171 1M SHEETS						
N		CS	1	1	1	
60 packages per case.						

NETWORK SERVICES

PRODUCT IDENTIFIER		DESCRIPTION				
ITEM NUMBER	ORD. MULT.	SELL UNIT	STD. PKG. STOCK AVAILABILITY / PA	LEAD TIME	MIN. ORD.	A C
260406749 TISSUE INTERFOLDED 157-90 WHITE						
1971556	1	CS	IL 31	IN 31	MI 31	OH WI 31 31
1 ply, 4in x 5in, 1000 sheets per package, 60 packages per case, 60,000 sheets per case.						

TOOLS

TOILET PAPER						
SEE PAPER TOILET.						

TOILET SEAT COVER						
SEE COVER TOILET SEAT.						

TOWEL PAPER						
--------------------	--	--	--	--	--	--

BUILDING JANITORIAL

260321484 TOWEL PAPER 108 ROLL						
1942185	1	CS	White, 8in width, 7.9in diameter, 425ft roll, 12 rolls per case.			

PRODUCT IDENTIFIER		DESCRIPTION				
ITEM NUMBER	ORD. MULT.	SELL UNIT	STD. PKG. STOCK AVAILABILITY / PA	LEAD TIME	MIN. ORD.	A C
300039062 TOWEL PAPER 115-04 ROLL						
5110510	1	CS	IL 31	IN 31	MI OH WI 31 31	
Natural, perf-embossed, 350ft roll, 16 rolls per case, 37lb case.						

AUTOMOTIVE

300093085 TOWEL PAPER 170 HAND						
N		CS	1	1	1	
Scott.						

280022617 TOWEL PAPER 211-04 SINGLEFOLD						
N		CS	1	1	1	
Bleached.						

FORMS/OFFICE SUPPLIES

PRODUCT IDENTIFIER		DESCRIPTION				
ITEM NUMBER	ORD. MULT.	SELL UNIT	STD. PKG. STOCK AVAILABILITY / PA	LEAD TIME	MIN. ORD.	A C
300041241 TOWEL PAPER 227 SINGLEFOLD						
6508374	1	CS	IL 31	IN 31	MI OH WI 31 31	
Natural white, 9 1/2in x 10 3/4in, washroom hand towel, 275 towels per package, 16 packages per case. DISCONTINUE UPON STOCK DEPLETION						

300041233 TOWEL PAPER 229 INTERFOLDED						
N		CS	12	1	12	
Natural white, 9 1/4in x 9 1/2in, multifold hand towel that opens to full size when dispensed, 1 ply, 275 towels per package, 16 packages per case. REPLACED BY PID 260406822						

GENERAL

260301643 TOWEL PAPER 229-04 MULTIFOLD						
N		CS	1	1	1	
Natural white, 9 1/4in x 9 1/2in, 250 towels per package, 16 packages per case.						

280052440 TOWEL PAPER 235-04 SINGLEFOLD						
N		CS	1	1	1	
Case of 400.						

DATA VOICE

PRODUCT IDENTIFIER		DESCRIPTION				
ITEM NUMBER	ORD. MULT.	SELL UNIT	STD. PKG. STOCK AVAILABILITY / PA	LEAD TIME	MIN. ORD.	A C

260406715 TOWEL PAPER 240-90 SINGLEFOLD						
N		CS	1	1	1	
Natural, 9 1/2in x 10 5/8in, 250 towels per package, 16 packages per case, 4000 towels per case.						

260411004 TOWEL PAPER 241-90 SINGLEFOLD						
N		CS	1	2	1	
Natural, JR, 8in x 10in, 250 towels per package, 16 packages per case, 4000 towels per case.						

260411012 TOWEL PAPER 242-90 SINGLEFOLD						
N		CS	1	1	1	
Natural, 9 1/2in x 10 5/8in, 250 towels per package, 16 packages per case, 4000 towels per case.						

280022609 TOWEL PAPER 244C FOLD						
N		CS	1	1	1	
Bleached, 2400 per case.						

260411020 TOWEL PAPER 245-90 MULTIFOLD						
N		CS	1	2	1	
Bleached, 9 1/4in x 9 1/2in, 250 towels per package, 16 packages per case, 4000 towels per case.						

PRODUCT IDENTIFIER		DESCRIPTION				
ITEM NUMBER	ORD. MULT.	SELL UNIT	STD. PKG. STOCK AVAILABILITY / PA	LEAD TIME	MIN. ORD.	A C
260406822 TOWEL PAPER 246-90 MULTIFOLD						
1970756	1	CS	IL 31	IN 31	MI OH WI 31 31	
Natural white, 9 1/4in x 9 1/2in, 250 towels per package, 16 packages per case, 4000 towels per case.						

260411038 TOWEL PAPER 247-90 MULTIFOLD						
N		CS	1	2	1	
Natural, 9 1/4in x 9 1/2in, 250 towels per package, 16 packages per case, 4000 towels per case.						

260411046 TOWEL PAPER 249-90 MULTIFOLD						
N		CS	1	2	1	
Natural, 9 1/4in x 9 1/2in, 250 towels per package, 16 packages per case, 4000 towels per case.						

260411053 TOWEL PAPER 251-90 CFOLD						
N		CS	1	2	1	
Bleached, 10 1/4in x 13 1/4in, 200 towels per package, 12 packages per case, 2400 towels per case.						

PRODUCT IDENTIFIER		DESCRIPTION				
ITEM NUMBER	ORD. MULT.	SELL UNIT	STD. PKG. STOCK AVAILABILITY / PA	LEAD TIME	MIN. ORD.	A C
260406798 TOWEL PAPER 252-90 CFOLD						
1970723	1	CS	IL 31	IN 31	MI OH WI 31 31	
Natural, 10 1/4in x 13 1/4in, 200 towels per package, 12 packages per case, 2400 towels per case.						

260411061 TOWEL PAPER 259-90 NARROWFOLD						
N		CS	1	2	1	
Natural, 9 1/2in x 9 1/2in, 286 towels per package, 14 packages per case, 4004 towels per case.						

PRODUCT IDENTIFIER		DESCRIPTION				
ITEM NUMBER	ORD. MULT.	SELL UNIT	STD. PKG. STOCK AVAILABILITY / PA	LEAD TIME	MIN. ORD.	A C
260411079 TOWEL PAPER 275-90 ROLL						
1971721	1	CS	IL 31	IN 31	MI OH WI 31 31	
Natural, non-perforated, 7 7/8in, 850ft per roll, 6 rolls per case.						

PRODUCT IDENTIFIER		DESCRIPTION					
ITEM NUMBER	ORD. MULT.	SELL UNIT	STD. PKG. STOCK AVAILABILITY / PA	LEAD TIME		MIN. ORD.	A C
260406806 TOWEL PAPER 276-90 ROLL							
1970731	1	CS	IL IN MI OH WI 31 31 31 31 31				
Natural, non-perforated, 7 1/8in, 400ft per roll, 12 rolls per case.							
260411087 TOWEL PAPER 277-90 ROLL							
N		CS	1	2	1		
Natural, non-perforated, 7 7/8in, 400ft per roll, 12 rolls per case.							
260411095 TOWEL PAPER 278-90 ROLL							
1972240	1	CS	IL IN MI OH WI 31 31 31 31 31				
Bleached white, non-perforated, 7 7/8in, 400ft per roll, 12 rolls per case.							
260411103 TOWEL PAPER 279-90 ROLL							
N		CS	1	2	1		
White, 2 ply, perforated, 11in x 9in, 100 sheets per roll, 30 rolls per case.							
280002817 TOWEL PAPER 286-32							
N		CS	1	3	1		
Natural, non-perforated.							
300098795 TOWEL PAPER 555 GEORGIA PACIFIC							
N		CS	1	1	1		
300080983 TOWEL PAPER 579 WIPERS							
5125427	1	CS	IL IN MI OH WI 31 31 31 31 31				
White, 9.8in x 16.4in, 9 dispensers per box, 100 wipers per box.							
260319280 TOWEL PAPER 836XX DIXIE MARATHON							
N		CS	1	2	1		
Folded paper hand towel.							
260301650 TOWEL PAPER A1227 TURKISH							
N		LB	1	1	1		
TREATMENT WATER							
SEE CHEMICAL WATER TREATMENT.							
UNISTRUT							
280014804 UNISTRUT P300 10FT W/ASSM HARDWARE							
N		EA	1	2	1		
Hot dip galvanized.							
UNIT POWER							
280011792 UNIT POWER PREVAL 468							
N		DZ	1	1	1		
Spray attachment w/cap. Used with container bottle #469. Case of 12.							
VINEGAR							
300093242 VINEGAR 06300							
N		GL	1	1	1		

PRODUCT IDENTIFIER		DESCRIPTION					
ITEM NUMBER	ORD. MULT.	SELL UNIT	STD. PKG. STOCK AVAILABILITY / PA	LEAD TIME		MIN. ORD.	A C
WASTEBASKET							
300085271 WASTEBASKET CAN 46-232D							
N		EA	1	2	1		
260448170 WASTEBASKET #2956BG MEDIUM RECTANGULAR							
N				Beige.			
260448188 WASTEBASKET #2957BG LARGE RECTANGULAR							
N				Beige.			
260448410 WASTEBASKET #3569BR 23 GAL BROWN							
N							
WATER DISTILLED							
280019506 WATER DISTILLED							
N		CS	1	1	4		
6 per case, 4 case minimum.							
WIPER							
002073971 WIPER 290-90 SHUR							
1448167	1	CS					
White, 4 ply, 9 3/4in x 12 3/4in, 125 per dispenser box, 15 boxes per case.							
260301668 WIPER 292-10 ALL PURPOSE WHITE							
N		CS	1	1	1		
800 per case.							
260301676 WIPER 292-31 ALL PURPOSE WHITE							
N		CS	1	1	1		
12in x 15in, 800 per case.							
260301692 WIPER 294-06 FOOD SERVICE							
N		CS	1	1	1		
Standard duty, 240 per case.							
260301684 WIPER 294-06 FOOD SERVICE							
N		CS	1	1	1		
Standard duty, 240 per case.							
401356407 WIPER 298-15 INDUSTRIAL							
1291822	1	CS	IL IN MI OH WI 31 31 31 31 31				
White, 2 ply, 9 3/4in x 12 3/4in, 125 per dispenser box, 15 boxes per case.							
260301700 WIPER 299-20 HEAVY DUTY 3PLY							
N		CS	1	1	1		
Natural, 600 per case, 50 per box.							
260302542 WIPER DISPOSABLE KLEENUP II							
N		CS	1	2	1		
Reusable, 14in x 18in, 50 per box, 6 boxes per case.							

DISTRIBUTION SERVICES
NETWORK SERVICES
TOOLS
BUILDING JANITORIAL
AUTOMOTIVE
FORMS/OFFICE SUPPLIES
GENERAL
DATA VOICE

DISTRIBUTION SERVICES

WIPER

PRODUCT IDENTIFIER		DESCRIPTION						
ITEM NUMBER	ORD. MULT.	SELL UNIT	STD. PKG. STOCK	PAV	LEAD TIME	MIN. ORD.	A C	

400454138 WIPER NON-WOVEN 17IN X 18IN

2626705	1	PK	IL	IN	MI	OH	WI
			31	31	31	31	31

100 per package, 12 packages per carton.

NETWORK SERVICES

260321104 WIPER TX304 CLOTH 4IN

N		PK	1		1		1
---	--	----	---	--	---	--	---

Texwipe 100% cotton, used to remove acids & etchants, clean equipment of high temperature and clean & polish metallic & non-metallic magnetic media.

260321112 WIPER TX309 CLOTH 9IN X 9IN

N		PK	1		1		1
---	--	----	---	--	---	--	---

Texwipe 100% cotton, used to remove acids & etchants, clean equipment of high temperature and clean & polish metallic & non-metallic magnetic media, 300 per package.

TOOLS

260321120 WIPER TX350A CLOTH 7IN X 11IN

N		PK	1		1		1
---	--	----	---	--	---	--	---

Reusable, chemically-treated antistatic wiper, package of 25.

BUILDING JANITORIAL

300070596 WIPER TX404 ABSORBOND LINT FREE

N		PK	1		1		1
---	--	----	---	--	---	--	---

4in x 4in, 1200 per box, spun laced poly fabric, no additives.

260321146 WIPER TX508 BLUEWIPES 8IN X 8IN

N		PK	1		1		1
---	--	----	---	--	---	--	---

Non-woven absorbent, multi purpose, 100 pieces per bag, 10 bags per case.

AUTOMOTIVE

260321260 WIPER TX904 NYLON STATIC FREE

N		PK	1		1		1
---	--	----	---	--	---	--	---

Cleans magnetic tape head & electric components, abrasive surfaces, lint free, 4in x 4in, 1200 per package.

260447586 WIPER #90415 13X15IN DURAWEVE 900/CASE

N

FORMS/OFFICE SUPPLIES

WRINGER

280022328 WRINGER 6122 YELLOW 16-24OZ CAPACTY

N		EA	1		2		1
---	--	----	---	--	---	--	---

280022336 WRINGER SW1 SQUEEZE TYPE

N		EA	1		1		1
---	--	----	---	--	---	--	---

Structolene.

280022310 WRINGER SW3 PRESS DOWN

N		EA	1		1		1
---	--	----	---	--	---	--	---

Structolene.

GENERAL

DATA VOICE

PRODUCT IDENTIFIER		DESCRIPTION						
ITEM NUMBER	ORD. MULT.	SELL UNIT	STD. PKG. STOCK	PAV	LEAD TIME	MIN. ORD.	A C	

NOTES

NOTES

SECTION 5 - AUTOMOTIVE MATERIALS INCLUDED

- ❑ MISCELLANEOUS AUTO PARTS

We are concerned and value your ideas. Please contact the Ameritech Bell Group Catalog Department direct on (708) 248-8313 with questions, corrections and ideas.

Catalog Format

PRODUCT IDENTIFIER		DESCRIPTION						
ITEM NUMBER	ORD. MULT.	SELL UNIT	STD. PKG.	LEAD TIME	MIN. ORD.	A	C	

Stock Material

Product Identifier (PID)	Description	Shaded Area Highlights Stock Material				
260388194	HEADSET OPERATOR HSB343-9					
Item Number 1964072	1 EA	IL	IN	MI	OH	WI
Std. Operating Environment or (GF) Grandfathered SOE GF		04	04	04	04	04
Order Multiple		Plantronics Starsset in-the-ear headset, quick disconnect, 2 prong connector, 10ft cord, black in color. Equivalent to H31-P10C. REPLACES HS0343-9 PID # 260324801.				
Sell Unit						
Long Description						
		Pattern Account (Under State) Designates Stock Availability				

Non-Stock Material

Product Identifier (PID)	Description	Lead Time	Minimum Order	Account Code
280027921	ASSEMBLY TEST PAIR PLUG	2	1	E = Expense Tool
Non-Stock Material N	1 EA			
Grandfathered SOE or (SOE) Std. Operating Environment GF				
Sell Unit				
Standard Package				
Long Description				
				Assembly includes bolts, talk block plug and pie plate, mounts in 3M cabinet. Plug e/w cord extends terminated cable pair on 3M module to talk block for testing purposes.

PRODUCT IDENTIFIER DESCRIPTION

ITEM NUMBER	ORD. MULT.	SELL UNIT	STD. PKG. STOCK AVAILABILITY / PA	LEAD TIME	MIN. ORD.	A C
-------------	------------	-----------	-----------------------------------	-----------	-----------	-----

ADDITIVE

260392345 ADDITIVE DIFFERENTIAL 1052358
 1965905 1 EA
 Additive for limited slip rear ends, all years.

ADDITIVE DIESEL

403549496 ADDITIVE DIESEL CONDITIONER 3512
 5518761 1 EA

300000478 ADDITIVE DIESEL FLOW 3716
 1199331 1 EA IL IN MI OH WI
 73 73 73 73
 Case of 24.

ALTERNATOR

300034451 ALTERNATOR 321- 38
 6503334 1 EA

402959142 ALTERNATOR 321- 39
 1151233 1 EA IL IN MI OH WI
 73 73 73 73

402959183 ALTERNATOR 321- 41
 1225714 1 EA IL IN MI OH WI
 73 73 73 73

300034485 ALTERNATOR 321-142
 N EA 1 4 1

402959175 ALTERNATOR 321-147
 1208975 1 EA IL IN MI OH WI
 73 73 73 73

403229123 ALTERNATOR 321-149
 1202952 1 EA IL IN MI OH WI
 73 73 73 73

300035011 ALTERNATOR 321-154
 N EA 1 1 1

300069812 ALTERNATOR 321-243
 N EA 1 2 1

300069838 ALTERNATOR 321-249
 N EA 1 1 1

260339635 ALTERNATOR 321-332
 1949214 1 EA IL IN MI OH WI
 73 73 73 73

260425475 ALTERNATOR 321-438
 1977041 1 EA IL IN MI OH WI
 73 73 73 73
 For 1985-89 Ford Astros.

260425483 ALTERNATOR 321-445
 1977058 1 EA IL IN MI OH WI
 73 73 73 73
 For 1986-90 Chevy Cavaliers.

PRODUCT IDENTIFIER DESCRIPTION

ITEM NUMBER	ORD. MULT.	SELL UNIT	STD. PKG. STOCK AVAILABILITY / PA	LEAD TIME	MIN. ORD.	A C
-------------	------------	-----------	-----------------------------------	-----------	-----------	-----

260422530 ALTERNATOR 321-659 100 AMP
 1975680 1 EA IL IN MI OH WI
 73 73 73 73

403368152 ALTERNATOR 321-661
 1152991 1 EA IL IN MI OH WI
 73 73 73 73

260421920 ALTERNATOR 5233472
 1975110 EA IL IN MI OH WI
 73 73 73 73

ANTIFREEZE

403549546 ANTIFREEZE GAS-LINE 5112
 1211631 1 EA

300060761 ANTIFREEZE SHELL 55 GALLONS
 6511139 1 DR IL IN MI OH WI
 73 73 73 73

ARM IDLER

403234008 ARM IDLER K6096
 5507780 1 EA

ARM PITMAN

403234115 ARM PITMAN K6143
 N EA 4 4 4

BALL JOINT

SEE JOINT BALL

BATTERY

300006145 BATTERY 1150
 5101410 1 EA

280022112 BATTERY 2005
 N EA 1 3 1

300069887 BATTERY 50 MONTH 58-50
 1153817 1 EA IL IN MI OH WI
 73 73 73 73

300035029 BATTERY 50 MONTH 62-50
 6502948 1 EA IL IN MI OH WI
 73 73 73 73

402959340 BATTERY 60 MONTH 22F-60
 1107052 1 EA IL IN MI OH WI
 73 73 73 73

402959332 BATTERY 60 MONTH 24F-60
 1115576 1 EA IL IN MI OH WI
 73 73 73 73

DISTRIBUTION SERVICES

NETWORK SERVICES

TOOLS

BUILDING JANITORIAL

AUTOMOTIVE

FORMS/OFFICE SUPPLIES

GENERAL

DATA VOICE

DISTRIBUTION SERVICES

BATTERY

PRODUCT IDENTIFIER		DESCRIPTION						
ITEM NUMBER	ORD. MULT.	SELL UNIT	STD. PKG. STOCK AVAILABILITY / PA	LEAD TIME	MIN. ORD.	A	C	

402959357 BATTERY 60 MONTH 24-60
1148072 1 EA IL IN MI OH WI
73 73 73 73

403229107 BATTERY 60 MONTH 26-60S
1145052 1 EA IL IN MI OH WI
73 73 73 73

402959399 BATTERY 60 MONTH 27F-60
1925859 1 EA IL IN MI OH WI
73 73 73 73

402959407 BATTERY 60 MONTH 7060-60
N EA 1 4 1

402959423 BATTERY 60 MONTH 74A-60
1141879 1 EA IL IN MI OH WI
73 73 73 73

300035045 BATTERY 60 MONTH 75-60
6503219 1 EA IL IN MI OH WI
73 73 73 73

300034527 BATTERY 60 MONTH 78-60
6503367 1 EA IL IN MI OH WI
73 73 73 73

300006202 BATTERY 60-MONTH 70-60
1170191 1 EA IL IN MI OH WI
73 73 73 73

260386610 BATTERY 70 DT72
1963892 1 EA IL IN MI OH WI
73 73 73 73
Delco.

402959415 BATTERY 72 MONTH 75A-72
N EA 1 4 1

260386602 BATTERY 78 DT72
1963884 1 EA IL IN MI OH WI
73 73 73 73

BEAM SEALED

402959449 BEAM SEALED 4651
6122200 1 EA

402959456 BEAM SEALED 4652
6122226 1 EA IL IN MI OH WI
73 73 73 73

402959472 BEAM SEALED 6014
1195255 1 EA IL IN MI OH WI
73 73 73 73

402959480 BEAM SEALED 6016
1137653 1 EA IL IN MI OH WI
73 73 73 73

300038320 BEAM SEALED 6052
6507327 1 EA IL IN MI OH WI
73 73 73 73

PRODUCT IDENTIFIER		DESCRIPTION						
ITEM NUMBER	ORD. MULT.	SELL UNIT	STD. PKG. STOCK AVAILABILITY / PA	LEAD TIME	MIN. ORD.	A	C	

300052040 BEAM SEALED H6054
6509174 1 EA IL IN MI OH WI
73 73 73 73

260382544 BEAM SEALED MOPAR 43188166
1961565 1 EA IL IN MI OH WI
73 73 73 73
Sylvania 2 & 1, Dodge headlamp for '88, '89, '90 vehicles.

BEARING WHEEL

403206527 BEARING WHEEL S 377
5509661 1 EA

BELT

260377668 BELT 7240
1960104 1 EA
For '84-87 Dodge Caravan/Ram MiniVan 4-135 2.2L - A/P.

260421532 BELT 7260
1974865 1 EA IL IN MI OH WI
73 73 73 73
For '85 Ford Tempo 2.3L - Alternator / '86-'91 Alternator & Power Steering.

260421680 BELT 7340
1975003 1 EA IL IN MI OH WI
73 73 73 73
For '84-'87 Chevy V8-350 5.7L C&G 10,20,30 / '86 G10,20,30 V-6 262 4.3L - A/P.

403213648 BELT 7375
5506105 1 EA IL IN MI OH WI
73 73 73 73
For '85-'86 Chevy-GMC Astro/Safari V6-262 4.3L - P/S / '85 Chevy G10-30 Van V8-305 5.0L - A/P (W/HD Cooling & SGL A/P).

260421540 BELT 7390
1974873 1 EA IL IN MI OH WI
73 73 73 73
For '90 Dodge D, W, & B100-350 V-6-239 3.9L - Fan & Idler.

260421748 BELT 7400
1975060 1 EA IL IN MI OH WI
73 73 73 73
For '87 Dodge D150 6-225 Power Steering.

260421755 BELT 7425
1975078 1 EA IL IN MI OH WI
73 73 73 73
For '87 Dodge Caravan/SE 4-156 2.6L - Power Steering.

403358450 BELT 7430
1176511 1 EA IL IN MI OH WI
73 73 73 73
For 87-89 Plymouth Reliant 4-135 2.2L-P/S/85 Astro/Safari V6-262 4.3L-Alt/85 Chevy G10-30 Van V8-305 5.0L-A/P&P/S (with dual A/P)/85-'86 Ford E100-350 Van 6-300 4.9L-Alt/84 GMC C300 V8-350 5.7L-Fan&HP

TOOLS

BUILDING JANITORIAL

AUTOMOTIVE

FORMS/OFFICE SUPPLIES

GENERAL

DATA VOICE

PRODUCT IDENTIFIER		DESCRIPTION					
ITEM NUMBER	ORD. MULT.	SELL UNIT	STD. PKG. STOCK AVAILABILITY / PA	LEAD TIME	MIN. ORD.	A	C
260377676 BELT 7435							
1960146	1	EA	IL IN MI OH WI 73 73 73				
For '83-'84 Chevy/GMC C2500 Pickup V8-350 5.7L - Alt & P/S / '87 Chevy R20 V6-262 4.3L - P/S / '87 Chevy Suburban V8-350 5.7L - P/S (W/O A/C) / '86 Dodge Ram Van 4-135 2.2L - P/S (W/O A/C).							
403213531 BELT 7440							
1228114	1	EA	IL IN MI OH WI 73 73 73				
For '85 Chevy G10-30 5.0 & 5.7L - Alt.							
260421763 BELT 7450							
1975086	1	EA	IL IN MI OH WI 73 73 73				
For '85 Chevy G10 V8-350 5.0L & C30 V8-350 5.7L - P/S (W/O HD Cool, W/SGL A/P) '85-'91 Dodge B100-350 V8-360 5.9L & V6-239 3.9L - P/S.							
260421649 BELT 7475							
1974964	1	EA	IL IN MI OH WI 73 73 73				
For '90-'91 Plymouth Sundance / '88 Dodge Aries / '88 Dodge Omni 2.2l - A/C Compressor.							
260421706 BELT 7480							
1975029	1	EA	IL IN MI OH WI 73 73 73				
For '88 Dodge B350/D350 5.9L V8-360 - A/P (W/SGL A/P) / '85-'86 Dodge B350 5.9L - Alt (W/O 100,117 Amp) / '84 chev G30 V8-350 - A/P & Alt / '83 GMC C200 5.7L - A/P & Alt (W/ HD Cool).							
260421656 BELT 7483							
N		EA		1	2	1	
For '89 Dodge Aries 2.2L - A/C Compressor.							
260377692 BELT 7485							
1960120	1	EA	IL IN MI OH WI 73 73 73				
For '86-'87/'89-'91 Dodge B350 Van V8-360 5.9L - A/P (W/SGL A/P, '87 under 8500 GVW) / '87-'91 Ford E150-250 Van 6-300 4.9L - Serpentine.							
260421664 BELT 7490							
1974980	1	EA	IL IN MI OH WI 73 73 73				
For '85 Chevy S10 V6-173 2.8L - Alt / '86 Ford Ranger V6-177 2.9L - Alt / '89 Plymouth Reliant 4-135 2.2L - A/C Compressor.							
260421714 BELT 7500							
1975037	1	EA	IL IN MI OH WI 73 73 73				
For '87 Dodge D150 6-225 Air Pump.							
260377684 BELT 7575							
1960096	1	EA	IL IN MI OH WI 73 73 73				
For '85-'87 Dodge D150 Pickup 6-225 3.7L - Alt (W/O 100 Amp).							

PRODUCT IDENTIFIER		DESCRIPTION					
ITEM NUMBER	ORD. MULT.	SELL UNIT	STD. PKG. STOCK AVAILABILITY / PA	LEAD TIME	MIN. ORD.	A	C
260390406 BELT 7603							
1964452	1	EA	IL IN MI OH WI 73 73 73				
For '88-'91 Dodge B100-350 Van V6-239 3.9L & V8-360 5.9L - Alt (Matched Set).							
260421557 BELT 7612							
1974881	1	EA	IL IN MI OH WI 73 73 73				
For '88-'91 Dodge V6-239 & V8-360 Alternator. (Matched Set).							
260390422 BELT 8485							
1964478	1	EA	IL IN MI OH WI 73 73 73				
For '89 Dodge Aries K 2.2L / '85-'87 Caravan 2.2L - A/C Compressor							
260390430 BELT 8555							
1964486	1	EA	IL IN MI OH WI 73 73 73				
For '85 Chevy Astro Van 4.3L / '86 Chevy - GMC V8-5.0L - Fan, A/C & P/S.							
260421771 BELT 9525							
1975094	1	EA	IL IN MI OH WI 73 73 73				
For '86 Ford F350 351-V8 / '88-'91 Ford Ranger 2.9L.							
260421599 BELT 9580							
1974915	1	EA	IL IN MI OH WI 73 73 73				
For '89-'91 Ford F350 V8-446 7.3L Diesel (including Super Duty) - Alt.							
260421789 BELT 9600							
1975102	1	EA	IL IN MI OH WI 73 73 73				
For '89-'91 Ford F350 V8-446 7.3L Diesel (including Super Duty) - P/S.							
260390455 BELT 7395							
N							
260390448 BELT 7445							
N							
260421391 BELT KO40384							
1974725	1	EA	IL IN MI OH WI 73 73 73				
For '90 Dodge Dynasty 4-153 2.5L / '89 Plymouth Reliant & Dodge Aries 4-135 2.2L / '89 Dodge Caravan 4-153 2.5L / '91 Dodge Spirit 4-153 2.5L - Alt.							
260421409 BELT KO40410							
1974733	1	EA	IL IN MI OH WI 73 73 73				
For '87 Plymouth Reliant & Dodge Aries 4-135 2.2L - Alt.							
260377650 BELT KO40413							
1960112	1	EA	IL IN MI OH WI 73 73 73				
For '84-'87 Dodge Caravan/Ram MiniVan 4-135 2.2L - Alt.							

DISTRIBUTION SERVICES
 NETWORK SERVICES
 TOOLS
 BUILDING JANITORIAL
 AUTOMOTIVE
 FORMS/OFFICE SUPPLIES
 GENERAL
 DATA VOICE

BELT

PRODUCT IDENTIFIER DESCRIPTION

ITEM NUMBER	ORD. MULT.	SELL UNIT	STD. PKG. STOCK AVAILABILITY / PA	LEAD TIME	MIN. ORD.	A C
-------------	------------	-----------	-----------------------------------	-----------	-----------	-----

260421417 BELT KO40882
 1974741 1 EA IL IN MI OH WI
 73 73 73
 For '87-'89 GMC Astro/Safari V6-262 4.3L / '88-'89 Chevy C & K 1500-3500 Pickup - Serpentine (W/O A/P).

260421607 BELT KO40940
 1974923 1 EA IL IN MI OH WI
 73 73 73
 For '87-'89 GMC Astro/Safari V6-262 4.3L / '88-'89 Chevy C&K 1500-3500 Pickup - Serpentine (W/A/P).

260421425 BELT KO50435
 1974758 1 EA IL IN MI OH WI
 73 73 73
 For '88 Chevy Blazer V8-350 5.7L / '86 Astro/Safari V6-262 4.3L - Alt.

260421433 BELT KO50720
 1974766 1 EA IL IN MI OH WI
 73 73 73
 For '87-'90 Plymouth Voyager/Dodge Caravan V6-3.0L - Serpentine.

260390364 BELT KO50825
 1964411 1 EA IL IN MI OH WI
 73 73 73
 For '87-'89 Chevy Cavalier 2.0L / '90 Cavalier 2.2L - Serpentine.

260421615 BELT KO60435
 1974931 1 EA IL IN MI OH WI
 73 73 73
 For '88 Ford Tempo 4-140 2.3L - A/C & P/S.

260421623 BELT KO60480
 1974949 1 EA IL IN MI OH WI
 73 73 73
 For '85-'87 Ford Tempo 4-140 2.3L - A/C & P/S (W/Fact. Air).

260421441 BELT KO60500
 1974774 1 EA IL IN MI OH WI
 73 73 73
 For '88-'91 Mercury Grand Marquis V8-302 5.0L - Alt, Fan & P/S (W/O 100 Amp).

260421458 BELT KO60598
 1974782 1 EA IL IN MI OH WI
 73 73 73
 For '89-91 Mercury Grand Marquis V8-302 A/C & A/P.

260390380 BELT KO60685
 1964437 1 EA IL IN MI OH WI
 73 73 73
 For '88-'91 Ford F150-350 7.5L V8 Fan, A/C & P/S (Including Super Duty).

260421466 BELT KO60705
 1974790 1 EA IL IN MI OH WI
 73 73 73
 For '89-'91 Ford Taurus V6-182 3.0L - A/C, W/P, & P/S / '90-'91 Chevy Lumina V6-181 3.1L - Serpentine.

PRODUCT IDENTIFIER DESCRIPTION

ITEM NUMBER	ORD. MULT.	SELL UNIT	STD. PKG. STOCK AVAILABILITY / PA	LEAD TIME	MIN. ORD.	A C
-------------	------------	-----------	-----------------------------------	-----------	-----------	-----

260421474 BELT KO60755
 1974808 1 EA IL IN MI OH WI
 73 73 73
 For '88-'89 GMC S & T15, Sonoma, Jimmy 4-151 2.5L - Serpentine.

260421482 BELT KO60770
 1974816 1 EA IL IN MI OH WI
 73 73 73
 For '87-'90 Chevy Celebrity 4-151 2.5L / '90-'91 Lumina 4-151 2.5L - Serpentine.

260421490 BELT KO60905
 1974824 1 EA IL IN MI OH WI
 73 73 73
 For '90-'91 Astro/Safari V6-262 4.3L - Serpentine.

260421508 BELT KO60938
 1974832 1 EA IL IN MI OH WI
 73 73 73
 For '89 Ford E100-350 V8-351 5.8L - Serpentine (over 8500 GVW) / '90-'91 Chevy - GMC c-1500-3500 Pickup V8-350 5.7L - Serpentine (W/O A/P).

260390331 BELT KO60945
 1964387 1 EA IL IN MI OH WI
 73 73 73
 For '87-'89 Astro Van V6-262 4.3L / '89 Ford E100-350 V8-351 5.8L (under 8500 GVW) - Serpentine.

260390414 BELT KO60960
 1964460 1 EA IL IN MI OH WI
 73 73 73
 For '87-'89 Ford Taurus 4-153 2.5L - Serpentine.

260440912 BELT KO60966
 N EA 1 2 1
 For '87-91 Ford F350 Pickup 6-300 4.9L, Serpentine.

260421631 BELT KO60990
 1974956 1 EA IL IN MI OH WI
 73 73 73
 For '90-'91 Chevy Astro V6-262 4.3L (W/A/C) / '90-'91 Dodge Caravan V6-201 3.3L (W/A/C) / '87-'91 Ford E150-250 Van 6-300 4.9L - Serpentine.

260421516 BELT KO61010
 1974840 1 EA IL IN MI OH WI
 73 73 73
 For '89-'91 Ford Taurus V6-232 3.8L / Lincoln V6-232 3.8L - Serpentine.

260390349 BELT KO61080
 1964395 1 EA IL IN MI OH WI
 73 73 73
 For '89 Buick Century 3.3L - Serpentine.

260421524 BELT KO61105
 1974857 1 EA IL IN MI OH WI
 73 73 73
 For '88 Ford Taurus V6-232 3.8L / Lincoln V6-232 3.8L - Serpentine.

DISTRIBUTION SERVICES
 NETWORK SERVICES
 TOOLS
 BUILDING JANITORIAL
 AUTOMOTIVE
 FORMS/OFFICE SUPPLIES
 GENERAL
 DATA VOICE

PRODUCT IDENTIFIER		DESCRIPTION				
ITEM NUMBER	ORD. MULT.	SELL UNIT	STD. PKG. STOCK AVAILABILITY / PA	LEAD TIME	MIN. ORD.	A C

PRODUCT IDENTIFIER		DESCRIPTION				
ITEM NUMBER	ORD. MULT.	SELL UNIT	STD. PKG. STOCK AVAILABILITY / PA	LEAD TIME	MIN. ORD.	A C

BLADE WIPER

BRAKE FLUID

001015981 BLADE WIPER 11-15 ANCO
1109256 1 PR

SEE FLUID BRAKE

001015999 BLADE WIPER 11-16 ANCO
1136614 1 PR IL IN MI OH WI
73 73 73 73

BRAKE PAD

SEE PAD BRAKE

001016112 BLADE WIPER 11-18 ANCO
1162073 1 PR IL IN MI OH WI
73 73 73 73

BRAKE SHOE

SEE SHOE BRAKE

260377700 BLADE WIPER 13-18
1960138 1 PR IL IN MI OH WI
73 73 73 73

BULB

SEE LAMP MINIATURE

403233869 BLADE WIPER 25-15 97899
1168876 1 PK IL IN MI OH WI
73 73 73 73

CALIPER

403213341 CALIPER RWC 5118 RE-MANUFACTURE
1153957 1 EA

403233877 BLADE WIPER 25-16 97900
1215939 1 PK IL IN MI OH WI
73 73 73 73

403213390 CALIPER RWC 5119 RE-MANUFACTURE
1225573 1 EA IL IN MI OH WI
73 73 73 73 73

403233885 BLADE WIPER 25-18 97901
1191072 1 PK IL IN MI OH WI
73 73 73 73

300037819 CALIPER RWC 5239 RE-MANUFACTURE
N EA 1 1 1

300083102 BLADE WIPER 29-16 97905
6513796 1 PK IL IN MI OH WI
73 73 73 73

300037827 CALIPER RWC 5240 RE-MANUFACTURE
N EA 1 1 1

300083110 BLADE WIPER 29-18 97906
6513788 1 PK IL IN MI OH WI
73 73 73 73
10/PK

CAP DISTRIBUTOR

300034568 CAP DISTRIBUTOR C 303
6503433 1 EA
For '85-'90 Dodge B350 van & D350 P/U
V8-360 5.9L

280028879 CAP DISTRIBUTOR C 305
1922534 1 EA IL IN MI OH WI
73 73 73 73 73
For '84-'85 Dodge Caravan 4-135 2.2L

402959498 CAP DISTRIBUTOR C 306
1160317 1 EA IL IN MI OH WI
73 73 73 73 73

260390018 CAP DISTRIBUTOR C 311
1964551 1 EA IL IN MI OH WI
73 73 73 73 73
For '88-'89 Plymouth Reliant & Dodge Aries
4-135 2.2L / '90 Plymouth Sundance 4-135
2.2L / '88-'89 Dodge Caravan & Ram van
4-153 2.5L / '86-'88 Dodge Omnl, Caravan, &
Ram van 4-135 2.2L

260417340 CAP DISTRIBUTOR C 314
1971846 1 EA IL IN MI OH WI
73 73 73 73 73

BRACKET

280003799 BRACKET VELVAC SS-1245/704068
1921262 1 EA

DISTRIBUTION SERVICES

NETWORK SERVICES

TOOLS

BUILDING JANITORIAL

AUTOMOTIVE

FORMS/OFFICE SUPPLIES

GENERAL

DATA VOICE

CAP DISTRIBUTOR

DISTRIBUTION SERVICES

PRODUCT IDENTIFIER		DESCRIPTION						
ITEM NUMBER	ORD. MULT.	SELL UNIT	STD. PKG. STOCK AVAILABILITY / PA	LEAD TIME	MIN. ORD.	A	C	

402959571 CAP DISTRIBUTOR D 335
 1134833 1 EA IL IN MI OH WI
 73 73 73 73
 For '85 Chevy Astro & '84-'86 G10 van V6-262 4.3L

402959589 CAP DISTRIBUTOR D 336
 1163733 1 EA IL IN MI OH WI
 73 73 73 73
 For '84-'86 Chevy C2500 P/U, Suburban & G30 van V8-350 5.7L / '85 Chevy G10 van V8-305 5.0L

403547029 CAP DISTRIBUTOR D 339
 1178665 1 EA IL IN MI OH WI
 73 73 73 73
 For '84-'87 Chevy S10 P/U 4-151 2.5L

300006210 CAP DISTRIBUTOR D 341
 1131276 1 EA IL IN MI OH WI
 73 73 73 73
 For '84 Chevy Citation V6-173 2.8L / '85 Chevy S10 V6-173 2.8L

260339676 CAP DISTRIBUTOR D 345
 1949230 1 EA IL IN MI OH WI
 73 73 73 73
 For '86-'90 Chevy Astro V6-262 4.3L / '87-'90 Chevy G10-20 van V6-262 4.3L

260339684 CAP DISTRIBUTOR D 352
 1949248 1 EA IL IN MI OH WI
 73 73 73 73
 For '86 Chevy Cavalier 4-121 2.0L & '85 Citation 4-151 2.5L

260377718 CAP DISTRIBUTOR D 354
 1959874 1 EA IL IN MI OH WI
 73 73 73 73
 For '88-'89 Chevy C3500 P/U V8-350 5.7L

402959662 CAP DISTRIBUTOR F 313Z
 1169425 1 EA IL IN MI OH WI
 73 73 73 73
 For '82-'90 Ford F350 P/U & E350 Van V8-351 5.8L

402959670 CAP DISTRIBUTOR F 314Z
 1162511 1 EA IL IN MI OH WI
 73 73 73 73
 For '85 Ford E350 Van 6-300 4.9L w/remote module.

300035060 CAP DISTRIBUTOR F 318
 1198523 1 EA IL IN MI OH WI
 73 73 73 73
 For '84-'85 Ford Escort 1.6L / '86 Ford Ranger & '85-'88 Tempo 4-140 2.3L

260384854 CAP DISTRIBUTOR MOPAR 4289870
 1962654 1 EA IL IN MI OH WI
 73 73 73 73
 For '87 Dodge B250 Van 6-225 3.7L / '88-'90 Dodge B250 Van V6-239 3.9L / '87-'90 Dodge D150 P/U & Dakota V6-239 3.9L

NETWORK SERVICES

TOOLS

BUILDING JANITORIAL

AUTOMOTIVE

FORMS/OFFICE SUPPLIES

GENERAL

DATA VOICE

PRODUCT IDENTIFIER		DESCRIPTION						
ITEM NUMBER	ORD. MULT.	SELL UNIT	STD. PKG. STOCK AVAILABILITY / PA	LEAD TIME	MIN. ORD.	A	C	

CAP GAS

402959779 CAP GAS GT 80
 N EA 1 4 1

402959852 CAP GAS GT 114
 N EA 1 4 1

402959837 CAP GAS GT 150
 N EA 1 4 1

300006236 CAP GAS GT 152
 1196071 1 EA IL IN MI OH WI
 73 73 73 73

402959829 CAP GAS GT 181
 1959882 1 EA IL IN MI OH WI
 73 73 73 73

CAP OIL

402959902 CAP OIL FILLER FC 68
 6112029 1 EA

402959886 CAP OIL FILLER FC 91
 1129429 1 EA IL IN MI OH WI
 73 73 73 73

260377726 CAP OIL FILLER FC 105
 N EA 1 4 1

260377734 CAP OIL FILLER FC 109
 N EA 1 4 1

CAP RADIATOR

402959936 CAP RADIATOR RC 6
 1216432 1 EA

402959951 CAP RADIATOR RC 15
 1174672 1 EA IL IN MI OH WI
 73 73 73 73

402959969 CAP RADIATOR RC 27
 6501890 1 EA IL IN MI OH WI
 73 73 73 73

402959977 CAP RADIATOR RC 32
 1182766 1 EA IL IN MI OH WI
 73 73 73 73

402959985 CAP RADIATOR RC 33
 1200071 1 EA IL IN MI OH WI
 73 73 73 73

402959993 CAP RADIATOR RC 34
 1151332 1 EA IL IN MI OH WI
 73 73 73 73

402960009 CAP RADIATOR RC 36
 1230219 1 EA IL IN MI OH WI
 73 73 73 73

PRODUCT IDENTIFIER		DESCRIPTION						
ITEM NUMBER	ORD. MULT.	SELL UNIT	STD. PKG. STOCK AVAILABILITY / PA	LEAD TIME			MIN. ORD.	A C
260377759 CAP RADIATOR RC 45								
1959932	1	EA	IL IN MI OH WI 73 73 73 73					

PRODUCT IDENTIFIER		DESCRIPTION						
ITEM NUMBER	ORD. MULT.	SELL UNIT	STD. PKG. STOCK AVAILABILITY / PA	LEAD TIME			MIN. ORD.	A C
403549603 CLAMP MUFFLER U178								
5518563	1	EA	IL IN MI OH WI 73 73 73 73					

CLAMP HOSE

260382171 CLAMP HOSE 24								
1961383	1	EA	IL IN MI OH WI 73 73 73 73					
Radiator hose clamp.								

403558778 CLAMP HOSE 613-008-706 SHIELDED								
1153098	1	EA	IL IN MI OH WI 73 73 73 73					

403558786 CLAMP HOSE 613-012-706 SHIELDED								
1138495	1	EA	IL IN MI OH WI 73 73 73 73					

403558794 CLAMP HOSE 613-020-706 SHIELDED								
1225540	1	EA	IL IN MI OH WI 73 73 73 73					

403558802 CLAMP HOSE 613-028-706 SHIELDED								
1181818	1	EA	IL IN MI OH WI 73 73 73 73					

403558810 CLAMP HOSE 613-036-706 SHIELDED								
1190330	1	EA	IL IN MI OH WI 73 73 73 73					

403558828 CLAMP HOSE 613-048-706 SHIELDED								
1223495	1	EA	IL IN MI OH WI 73 73 73 73					

CLAMP MUFFLER

300007184 CLAMP MUFFLER 8596								
1192278	1	EA						

403549611 CLAMP MUFFLER H200								
1228197	1	EA	IL IN MI OH WI 73 73 73 73					

403549629 CLAMP MUFFLER H212								
1155168	1	EA	IL IN MI OH WI 73 73 73 73					

403549637 CLAMP MUFFLER H214								
1147132	1	EA	IL IN MI OH WI 73 73 73 73					

403549645 CLAMP MUFFLER H300								
5518480	1	EA	IL IN MI OH WI 73 73 73 73					

403549587 CLAMP MUFFLER U112								
5518605	1	EA	IL IN MI OH WI 73 73 73 73					

403549595 CLAMP MUFFLER U134								
1120816	1	EA	IL IN MI OH WI 73 73 73 73					

CLEANER

403549520 CLEANER BRAKE								
1138719	1	EA						
Penray.								

260379995 CLEANER CARBON X66P								
1960609	1	CS	IL IN MI OH WI 71 71 71 71					

403549470 CLEANER CARBURETOR 2114								
1227777	1	EA	IL IN MI OH WI 73 73 73 73					
Spray gum solvent.								

403549504 CLEANER ENGINE 4220								
1157537	1	EA	IL IN MI OH WI 73 73 73 73					

260339692 CLEANER FUEL INJECTION								
1949222	1	EA	IL IN MI OH WI 73 73 73 73					
24 per case.								

403549561 CLEANER MOTOR ELECTRIC								
5518662	1	EA	IL IN MI OH WI 73 73 73 73					
Penray.								

260369368 CLEANER VINYL								
1955856	1	CS	IL IN MI OH WI 71 71 71 71					

COIL IGNITION

402960033 COIL IGNITION C 500								
1179408	1	EA						

260418249 COIL IGNITION C 502								
1973123	1	EA	IL IN MI OH WI 73 73 73 73					

402960066 COIL IGNITION D 530								
1165001	1	EA	IL IN MI OH WI 73 73 73 73					

260377999 COIL IGNITION D 535								
1960187	1	EA	IL IN MI OH WI 73 73 73 73					

260390216 COIL IGNITION D 540								
1964767	1	EA	IL IN MI OH WI 73 73 73 73					

260390224 COIL IGNITION D 543								
1964775	1	EA	IL IN MI OH WI 73 73 73 73					

DISTRIBUTION SERVICES

NETWORK SERVICES

TOOLS

BUILDING JANITORIAL

AUTOMOTIVE

FORMS/OFFICE SUPPLIES

GENERAL

DATA VOICE

COIL IGNITION

DISTRIBUTION SERVICES

PRODUCT IDENTIFIER		DESCRIPTION						
ITEM NUMBER	ORD. MULT.	SELL UNIT	STD. PKG. STOCK AVAILABILITY / PA	LEAD TIME	MIN. ORD.	A	C	
280038803 COIL IGNITION F 503								
1960179	1	EA	IL IN MI OH WI 73 73 73					

PRODUCT IDENTIFIER		DESCRIPTION						
ITEM NUMBER	ORD. MULT.	SELL UNIT	STD. PKG. STOCK AVAILABILITY / PA	LEAD TIME	MIN. ORD.	A	C	
260378021 COIL PICK-UP F1930								
1960377	1	EA	IL IN MI OH WI 73 73 73 73					

NETWORK SERVICES

COIL PICK-UP							
260390190 COIL PICK-UP C1911							
1964742	1	EA					
300034576 COIL PICK-UP C1912							
N		EA	1	1	1		

CONDENSOR							
260418256 CONDENSOR D 446							
1973131	1	EA					

TOOLS

260417365 COIL PICK-UP C1919							
1972059	1	EA	IL IN MI OH WI 73 73 73				

CONDITIONER							
260369376 CONDITIONER VINYL							
1955864	1	CS					

BUILDING JANITORIAL

260418223 COIL PICK-UP C1922							
1973107	1	EA	IL IN MI OH WI 73 73 73				

CYLINDER ASSEMBLY

260390182 COIL PICK-UP C1924							
1964734	1	EA	IL IN MI OH WI 73 73 73				

403212962 CYLINDER ASSEMBLY MASTER MC 36306							
1153221	1	EA					

260382569 COIL PICK-UP C1926							
1961599	1	EA	IL IN MI OH WI 73 73 73				
Application on Dodge Dakota 3.9L.							

300038064 CYLINDER ASSEMBLY MASTER MC 39002							
N		EA	1	1	1		

AUTOMOTIVE

402960140 COIL PICK-UP D1907							
6503946	1	EA	IL IN MI OH WI 73 73 73 73				

260378047 CYLINDER ASSEMBLY MASTER MC 39476							
1960302	1	EA	IL IN MI OH WI 73 73 73 73				

402960165 COIL PICK-UP D1911							
1191635	1	EA	IL IN MI OH WI 73 73 73 73				

403213176 CYLINDER ASSEMBLY WHEEL WC 37235							
1218420	1	EA	IL IN MI OH WI 73 73 73 73				

260390208 COIL PICK-UP D1925A							
1964759	1	EA	IL IN MI OH WI 73 73 73				

260378039 CYLINDER ASSEMBLY WHEEL WC 37625							
1960294	1	EA	IL IN MI OH WI 73 73 73 73				

FORMS/OFFICE SUPPLIES

260378005 COIL PICK-UP D1955							
1960203	1	EA	IL IN MI OH WI 73 73 73 73				

DIESEL ADDITIVE

SEE ADDITIVE DIESEL.

260417373 COIL PICK-UP D1965							
1971838	1	EA	IL IN MI OH WI 73 73 73				

DIESEL CONDITIONER

SEE ADDITIVE DIESEL.

GENERAL

280038811 COIL PICK-UP D1971							
N		EA	1	4	1		

DISTRIBUTOR CAP

SEE CAP DISTRIBUTOR.

300070083 COIL PICK-UP D1972							
N		EA	1	1	1		

EXHAUST PIPE

SEE PIPE EXHAUST.

DATA VOICE

260378013 COIL PICK-UP D1987							
1960195	1	EA	IL IN MI OH WI 73 73 73				

FILTER AIR

260418231 COIL PICK-UP F1907Z							
1973115	1	EA	IL IN MI OH WI 73 73 73				

260377767 FILTER AIR A 49C							
1959957	1	EA					

402960314 FILTER AIR A 114C							
1224816	1	EA	IL IN MI OH WI 72 72 72 72				

PRODUCT IDENTIFIER		DESCRIPTION					
ITEM NUMBER	ORD. MULT.	SELL UNIT	STD. PKG. STOCK AVAILABILITY / PA	LEAD TIME	MIN. ORD.	A C	
402960322		FILTER AIR A	117C				
1164913	1	EA	IL IN MI OH WI 72 72 72 72				
402960330		FILTER AIR A	134C				
N		EA	6	1	6		
403359078		FILTER AIR A	142C				
5514620	1	EA	IL IN MI OH WI 71 71 71 71				
402960348		FILTER AIR A	152C				
1159517	1	EA	IL IN MI OH WI 72 72 72 72				
402960363		FILTER AIR A	178CW				
1204354	1	EA	IL IN MI OH WI 72 72 72 72				
260389846		FILTER AIR A	209C				
1964957	1	EA	IL IN MI OH WI 73 73 73 73				
402960371		FILTER AIR A	218C				
N		EA	6	4	6		
402960389		FILTER AIR A	222C				
1184457	1	EA	IL IN MI OH WI 72 72 72 72				
260389838		FILTER AIR A	266C				
1964940	1	EA	IL IN MI OH WI 73 73 73 73				
260339734		FILTER AIR A	328C				
1949321	1	EA	IL IN MI OH WI 71 71 71 71				
402960405		FILTER AIR A	329C				
1163444	1	EA	IL IN MI OH WI 72 72 72 72				
402960413		FILTER AIR A	348C				
1116731	1	EA	IL IN MI OH WI 72 72 72 72				
402960439		FILTER AIR A	355C				
6125203	1	EA	IL IN MI OH WI 72 72 72 72				
402960454		FILTER AIR A	357C				
1188912	1	EA	IL IN MI OH WI 72 72 72 72				
260302682		FILTER AIR A	365C				
1939421	1	EA	IL IN MI OH WI 72 72 72 72				
300034584		FILTER AIR A	391C				
N		EA	6	1	6		
403359086		FILTER AIR A	458C				
5514604	1	EA	IL IN MI OH WI 71 71 71 71				

PRODUCT IDENTIFIER		DESCRIPTION					
ITEM NUMBER	ORD. MULT.	SELL UNIT	STD. PKG. STOCK AVAILABILITY / PA	LEAD TIME	MIN. ORD.	A C	
402960488		FILTER AIR A	467C				
1166413	1	EA	IL IN MI OH WI 72 72 72 72				
402960520		FILTER AIR A	592C				
1161950	1	EA	IL IN MI OH WI 72 72 72 72				
260339742		FILTER AIR A	712C				
1949313	1	EA	IL IN MI OH WI 73 73 73 73				
402960561		FILTER AIR A	735C				
1158139	1	EA	IL IN MI OH WI 72 72 72 72				
402960579		FILTER AIR A	736C				
1226431	1	EA	IL IN MI OH WI 72 72 72 72				
402960587		FILTER AIR A	744C				
1120683	1	EA	IL IN MI OH WI 71 71 71 71				
300034600		FILTER AIR A	753C				
6503136	1	EA	IL IN MI OH WI 72 72 72 72				
402960660		FILTER AIR A	765C				
1227470	1	EA	IL IN MI OH WI 72 72 72 72				
300034626		FILTER AIR A	773C				
6503144	1	EA	IL IN MI OH WI 72 72 72 72				
402960686		FILTER AIR A	780C				
1137513	1	EA	IL IN MI OH WI 72 72 72 72				
403359094		FILTER AIR A	785C				
5514588	1	EA	IL IN MI OH WI 71 71 71 71				
260377775		FILTER AIR A	821C				
1959940	1	EA	IL IN MI OH WI 73 73 73 73				
300006251		FILTER AIR A	826C				
1139295	1	EA	IL IN MI OH WI 71 71 71 71				
300006269		FILTER AIR A	831C				
1220137	1	EA	IL IN MI OH WI 71 71 71 71				
403558836		FILTER AIR A	858C				
5518944	1	EA	IL IN MI OH WI 71 71 71 71				
260345145		FILTER AIR A	863C				
1950980	1	EA	IL IN MI OH WI 71 71 71 71				
260339478		FILTER AIR A	875C				
1949693	1	EA	IL IN MI OH WI 71 71 71 71				

DISTRIBUTION SERVICES

NETWORK SERVICES

TOOLS

BUILDING JANITORIAL

AUTOMOTIVE

FORMS/OFFICE SUPPLIES

GENERAL

DATA VOICE

FILTER AIR

PRODUCT IDENTIFIER		DESCRIPTION						
ITEM NUMBER	ORD. MULT.	SELL UNIT	STD. PKG. STOCK AVAILABILITY / PA	LEAD TIME	MIN. ORD.	A	C	
260389853 FILTER AIR A 886C								
1964965	1	EA	IL IN 73	MI OH WI 73 73				
300070141 FILTER AIR A 929C								
5122051	1	EA	IL IN 71	MI OH WI 71 71				
260418272 FILTER AIR A 931C								
1973222	1	EA	IL IN 73	MI OH WI 73 73				
260389812 FILTER AIR A 974C								
1964924	1	EA	IL IN 73	MI OH WI 73 73				
260418322 FILTER AIR A 978C								
1973206	1	EA	IL IN 73	MI OH WI 73 73				
260361241 FILTER AIR A 1089C								
1954032	1	EA	IL IN 71	MI OH WI 71 71				
260389820 FILTER AIR A 1098C								
1964932	1	EA	IL IN 73	MI OH WI 73 73				
402960306 FILTER AIR A 1103C								
1193557	1	EA	IL IN 72	MI OH WI 72 72				
260361233 FILTER AIR A 1113C								
1954040	1	EA	IL IN 71	MI OH WI 71 71				
260418330 FILTER AIR A 1115C								
1973214	1	EA	IL IN 73	MI OH WI 73 73				
260418348 FILTER AIR A 1129C								
1973230	1	EA	IL IN 73	MI OH WI 73 73				
260417399 FILTER AIR A 1131C								
1972018	1	EA	IL IN 73	MI OH WI 73 73				
260417407 FILTER AIR A 1135C								
1972190	1	EA	IL IN 73	MI OH WI 73 73				
260368113 FILTER AIR A 1141C								
1955468	1	EA	IL IN 72	MI OH WI 72 72				
260417415 FILTER AIR A 1143C								
1972000	1	EA	IL IN 73	MI OH WI 73 73				
260407754 FILTER AIR A 1146C								
1970913	1	EA	IL IN 73	MI OH WI 73 73				

PRODUCT IDENTIFIER		DESCRIPTION						
ITEM NUMBER	ORD. MULT.	SELL UNIT	STD. PKG. STOCK AVAILABILITY / PA	LEAD TIME	MIN. ORD.	A	C	

FILTER BREATHER

402960694 FILTER BREATHER FB 59								
1140269	1	EA						
402960702 FILTER BREATHER FB 60								
1194399	1	EA	IL IN 72	MI OH WI 72 72				
300006285 FILTER BREATHER FB 73								
1116558	1	EA	IL IN 73	MI OH WI 73 73				
260339650 FILTER BREATHER FB 82								
1949255	1	EA	IL IN 73	MI OH WI 73 73				
260417423 FILTER BREATHER FB 94								
1972216	1	EA	IL IN 73	MI OH WI 73 73				
260377783 FILTER BREATHER FB 99								
1959973	1	EA	IL IN 73	MI OH WI 73 73				
260377791 FILTER BREATHER FB 101								
1959965	1	EA	IL IN 73	MI OH WI 73 73				
260417431 FILTER BREATHER FB 106								
1972133	1	EA	IL IN 73	MI OH WI 73 73				

FILTER BYPASS

402960710 FILTER BYPASS C 267								
1184077	1	EA						

FILTER COOLANT

260377817 FILTER COOLANT WF 100								
1959981	1	EA						

FILTER FUEL

260432695 FILTER FUEL 4443454 MOPAR								
N		EA	1	2	24			
For '88-'91 Dodge B100-350 Van, all engines with efi.								
260386594 FILTER FUEL FD 829								
1963876	1	EA	IL IN 72	MI OH WI 72 72				
402960793 FILTER FUEL GF 61								
1177618	1	EA	IL IN 72	MI OH WI 72 72				
402960801 FILTER FUEL GF 157								
1134353	1	EA	IL IN 72	MI OH WI 72 72				

DISTRIBUTION SERVICES

NETWORK SERVICES

TOOLS

BUILDING JANITORIAL

AUTOMOTIVE

FORMS/OFFICE SUPPLIES

GENERAL

DATA VOICE

DISTRIBUTION SERVICES

NETWORK SERVICES

TOOLS

BUILDING JANITORIAL

AUTOMOTIVE

FORMS/OFFICE SUPPLIES

GENERAL

DATA VOICE

PRODUCT IDENTIFIER		DESCRIPTION						
ITEM NUMBER	ORD. MULT.	SELL UNIT	STD. PKG. STOCK AVAILABILITY / PA	LEAD TIME			MIN. ORD.	A C
260435615 FILTER FUEL GF 174								
1980557		EA	IL IN MI OH WI 73 73 73					
Hastings. 1988-90 Dodge/Plymouth 4 cylinder 2.26L.								
402960736 FILTER FUEL GF 434								
N		EA	1		1		1	
402960835 FILTER FUEL GF 434								
1131516	1	EA	IL IN MI OH WI 72 72 72 72					
300034725 FILTER FUEL GF 454								
N		EA	1		1		1	
260418280 FILTER FUEL GF 455								
1973164	1	EA	IL IN MI OH WI 73 73 73					
402960744 FILTER FUEL GF 470								
1141739	1	EA	IL IN MI OH WI 72 72 72 72					
402960751 FILTER FUEL GF 471								
1138792	1	EA	IL IN MI OH WI 72 72 72 72					
300035797 FILTER FUEL GF 473								
N		EA	1		4		1	
300035094 FILTER FUEL GF 479								
N		EA	1		1		1	
403359102 FILTER FUEL GF 480								
1220475	1	EA	IL IN MI OH WI 72 72 72 72					
403547060 FILTER FUEL GF 481								
5518340	1	EA	IL IN MI OH WI 72 72 72 72					
260382163 FILTER FUEL GF 483								
1961375	1	EA	IL IN MI OH WI 72 72 72					
300034741 FILTER FUEL GF 485								
6501593	1	EA	IL IN MI OH WI 72 72 72 72					
260377825 FILTER FUEL GF 486								
1960021	1	EA	IL IN MI OH WI 72 72 72					
300006525 FILTER FUEL GF 487								
1145318	1	EA	IL IN MI OH WI 72 72 72 72					
300070158 FILTER FUEL GF 510								
5122333	1	EA	IL IN MI OH WI 72 72 72 72					
260418298 FILTER FUEL GF 515								
1973172	1	EA	IL IN MI OH WI 73 73 73					

PRODUCT IDENTIFIER		DESCRIPTION						
ITEM NUMBER	ORD. MULT.	SELL UNIT	STD. PKG. STOCK AVAILABILITY / PA	LEAD TIME			MIN. ORD.	A C
260417449 FILTER FUEL GF 529								
1971945	1	EA	IL IN MI OH WI 73 73 73					
260418306 FILTER FUEL GF 530								
1973180	1	EA	IL IN MI OH WI 73 73 73					
260418264 FILTER FUEL GF 558								
1973156	1	EA	IL IN MI OH WI 73 73 73					
260389762 FILTER FUEL GF 562								
1964874	1	EA	IL IN MI OH WI 72 72 72					
260389796 FILTER FUEL GF 574								
1964908	1	EA	IL IN MI OH WI 72 72 72					
260417456 FILTER FUEL GF 580K								
1972182	1	EA	IL IN MI OH WI 73 73 73					
260389788 FILTER FUEL T936								
1964890	1	EA	IL IN MI OH WI 73 73 73					
402960769 FILTER FUEL TP 865								
6124107	1	EA	IL IN MI OH WI 72 72 72 72					
402960777 FILTER FUEL TP 877								
1108571	1	EA	IL IN MI OH WI 72 72 72 72					
260389804 FILTER FUEL TP 928								
1964916	1	EA	IL IN MI OH WI 72 72 72 72					
402960785 FILTER FUEL TP 931								
6124248	1	EA	IL IN MI OH WI 72 72 72 72					
260339775 FILTER FUEL TP 972								
1949297	1	EA	IL IN MI OH WI 73 73 73 73					
260339783 FILTER FUEL TP 994								
1949289	1	EA	IL IN MI OH WI 73 73 73 73					
260339791 FILTER FUEL TP1055								
1949305	1	EA	IL IN MI OH WI 73 73 73 73					
FILTER OIL								
260423348 FILTER OIL 5281090								
1976084	1	EA						
260440896 FILTER OIL FL1A MOTORCRAFT								
N		EA	1		2		1	
'87-90 Ford F100-350 Pickup & E100-350 Van. '83-90 Ford Ranger 4-140 2.3L '86-87 Ford Ranger V6-177 2.9L								

FILTER OIL

DISTRIBUTION SERVICES

NETWORK SERVICES

TOOLS

BUILDING JANITORIAL

AUTOMOTIVE

FORMS/OFFICE SUPPLIES

GENERAL

DATA VOICE

PRODUCT IDENTIFIER		DESCRIPTION					
ITEM NUMBER	ORD. MULT.	SELL UNIT	STD. PKG.	LEAD TIME		MIN. ORD.	A C
			STOCK AVAILABILITY / PA				
260435607 FILTER OIL LF393							
1980565	1	EA	IL 73	IN 73	MI 73	OH 73	WI
Hastings.							
260422522 FILTER OIL MOPAR 4105409							
1975672	1	EA	IL 73	IN 73	MI 73	OH 73	WI
403359110 FILTER OIL PF 2							
1146639	1	EA	IL 72	IN 72	MI 72	OH 72	WI
300035128 FILTER OIL PF 9							
6504282	1	EA	IL 72	IN 72	MI 72	OH 72	WI
260417464 FILTER OIL PF 13							
1971994	1	EA	IL 73	IN 73	MI 73	OH 73	WI
300038361 FILTER OIL PF 16							
6507251	1	EA	IL 72	IN 72	MI 72	OH 72	WI
402960876 FILTER OIL PF 20							
1189647	1	EA	IL 72	IN 72	MI 72	OH 72	WI
402960884 FILTER OIL PF 24							
1186544	1	EA	IL 72	IN 72	MI 72	OH 72	WI
402960892 FILTER OIL PF 25							
1226852	1	EA	IL 72	IN 72	MI 72	OH 72	WI
300006509 FILTER OIL PF 34							
1961581	1	EA	IL 72	IN 72	MI 72	OH 72	WI
Application for small engine and power units.							
402960918 FILTER OIL PF 35							
1190637	1	EA	IL 72	IN 72	MI 72	OH 72	WI
260389747 FILTER OIL PF 40							
1964858	1	EA	IL 72	IN 72	MI 72	OH 72	WI
402960934 FILTER OIL PF 42							
1213595	1	EA	IL 72	IN 72	MI 72	OH 72	WI
300035144 FILTER OIL PF 45							
6504308	1	EA	IL 72	IN 72	MI 72	OH 72	WI
402960926 FILTER OIL PF 47							
1198473	1	EA	IL 72	IN 72	MI 72	OH 72	WI
402960942 FILTER OIL PF 51							
1142653	1	EA	IL 72	IN 72	MI 72	OH 72	WI

PRODUCT IDENTIFIER		DESCRIPTION					
ITEM NUMBER	ORD. MULT.	SELL UNIT	STD. PKG.	LEAD TIME		MIN. ORD.	A C
			STOCK AVAILABILITY / PA				
260331681 FILTER OIL PF 52							
1947432	1	EA	IL 72	IN 72	MI 72	OH 72	WI
402960868 FILTER OIL PF 53							
1192245	1	EA	IL 72	IN 72	MI 72	OH 72	WI
403486004 FILTER OIL PF 56							
1152975	1	EA	IL 72	IN 72	MI 72	OH 72	WI
300034758 FILTER OIL PF 57							
6502898	1	EA	IL 72	IN 72	MI 72	OH 72	WI
260377833 FILTER OIL PF 341							
1960005	1	EA	IL 73	IN 73	MI 73	OH 73	WI
402960975 FILTER OIL PF 856							
6124883	1	EA	IL 72	IN 72	MI 72	OH 72	WI
300064235 FILTER OIL PF 881							
6511535	1	EA	IL 72	IN 72	MI 72	OH 72	WI
403359128 FILTER OIL PF 897							
1135392	1	EA	IL 72	IN 72	MI 72	OH 72	WI
402964217 FILTER OIL PF 898							
1182873	1	EA	IL 72	IN 72	MI 72	OH 72	WI
402964225 FILTER OIL PF 932							
1141754	1	EA	IL 72	IN 72	MI 72	OH 72	WI
260339809 FILTER OIL PF1054							
1949347	1	EA	IL 72	IN 72	MI 72	OH 72	WI
260389754 FILTER OIL PF1072							
1964866	1	EA	IL 72	IN 72	MI 72	OH 72	WI
260440888 FILTER OIL PF54							
N		EA	1		2		1
Hesco 10KW Engine.							
FILTER TRANSMISSION							
402964258 FILTER TRANSMISSION PF 160							
N		EA	1		1		1
402964274 FILTER TRANSMISSION PF 171							
6103242	1	EA	IL 72	IN 72	MI 72	OH 72	WI
403025737 FILTER TRANSMISSION TF 207							
1135533	1	EA	IL 72	IN 72	MI 72	OH 72	WI

PRODUCT IDENTIFIER DESCRIPTION

ITEM	ORD.	SELL	STD. PKG.	LEAD TIME	MIN.	A
NUMBER	MULT.	UNIT	STOCK AVAILABILITY / PA		ORD.	C

260417472 FILTER TRANSMISSION TF 212
 1972026 1 EA IL IN MI OH WI
 73 73 73 73

300006483 FILTER TRANSMISSION TF 217
 1170993 1 EA IL IN MI OH WI
 73 73 73 73 73

260389879 FILTER TRANSMISSION TF 221
 1965004 1 EA IL IN MI OH WI
 72 72 72 72

260377858 FILTER TRANSMISSION TF 230
 1959866 1 EA IL IN MI OH WI
 72 72 72 72

260417480 FILTER TRANSMISSION TF 231
 1971978 1 EA IL IN MI OH WI
 73 73 73 73

260377841 FILTER TRANSMISSION TF 235
 N EA 1 4 1

260377585 FILTER TRANSMISSION TF 235
 1959775 1 EA IL IN MI OH WI
 72 72 72 72

260389861 FILTER TRANSMISSION TF 236
 1964981 1 EA IL IN MI OH WI
 72 72 72 72

402964332 FILTER TRANSMISSION TF 247
 1136630 1 EA IL IN MI OH WI
 72 72 72 72

300035185 FILTER TRANSMISSION TF 910
 1973248 1 EA IL IN MI OH WI
 73 73 73 73

FILTER WATER

300006491 FILTER WATER WF 100
 N EA 1 4 1

FLASHER SIGNAL

402964415 FLASHER SIGNAL SF 552
 1215459 1 EA

402964431 FLASHER SIGNAL SF 853
 1127852 1 EA IL IN MI OH WI
 73 73 73 73

FLUID AUTOMATIC TRANSMISSION

300060779 FLUID AUTOMATIC TRANSMISSION II
 6511113 1 CS
 12 quarts per case.

PRODUCT IDENTIFIER DESCRIPTION

ITEM	ORD.	SELL	STD. PKG.	LEAD TIME	MIN.	A
NUMBER	MULT.	UNIT	STOCK AVAILABILITY / PA		ORD.	C

300064243 FLUID AUTOMATIC TRANSMISSION II
 6511600 1 DR IL IN MI OH WI
 73 73 73 73
 55 gallons.

FLUID BRAKE

402964449 FLUID BRAKE 11G
 6114280 1 EA
 6 gallons per case.

300060787 FLUID BRAKE DOT3 GALLON
 6511121 1 GL IL IN MI OH WI
 73 73 73 73

FLUID POWER STEERING

300083219 FLUID POWER STEERING
 6513804 1 EA

FLUID STARTING

403549553 FLUID STARTING 5315
 5518720 1 EA

FLUID WINDSHIELD WASHER

300059482 FLUID WINDSHIELD WASHER
 6510271 1 CS

400560959 FLUID WINDSHIELD WASHER 55 GALLON
 1953992 1 DR IL IN MI OH WI
 73 73 73 73

FREON

280049644 FREON R 11 100LB CONTAINER
 N EA 1 1 1

300060555 FREON R 11 200LB DISPENSER TANK
 6511030 1 EA IL IN MI OH WI
 71 71 71 71

280049651 FREON R 11 650LB CONTAINER
 N EA 1 1 1

280049669 FREON R 12 30LB DISPENSER TANK
 1939397 1 EA IL IN MI OH WI
 71 71 71 71

300060563 FREON R 12 50LB DISPENSER TANK
 1175554 1 EA IL IN MI OH WI
 71 71 71 71

280049677 FREON R 12 145LB CONTAINER
 N EA 1 1 1

DISTRIBUTION SERVICES

NETWORK SERVICES

TOOLS

BUILDING JANITORIAL

AUTOMOTIVE

FORMS/OFFICE SUPPLIES

GENERAL

DATA VOICE

DISTRIBUTION SERVICES
 NETWORK SERVICES
 TOOLS
 BUILDING JANITORIAL
 AUTOMOTIVE
 FORMS/OFFICE SUPPLIES
 GENERAL
 DATA VOICE

FREON

PRODUCT IDENTIFIER		DESCRIPTION						
ITEM NUMBER	ORD. MULT.	SELL UNIT	STD. PKG. STOCK AVAILABILITY / PA	LEAD TIME	MIN. ORD.	A	C	
300060589 FREON R 22 30LB DISPENSER TANK								
1148338	1	EA	IL IN MI OH WI 71 71 71 71 71					
Used for recharging air conditioning systems.								
300060571 FREON R 22 50LB DISPENSER TANK								
6511014	1	EA	IL IN MI OH WI 71 71 71 71 71					
280049685 FREON R 22 125LB CONTAINER								
N		EA	1	1	1			
280049893 FREON R114 150LB CONTAINER								
N		EA	1	1	1			
300060597 FREON R500 30LB DISPENSER TANK								
N		EA	1	1	1			
280049701 FREON R500 50LB CONTAINER								
N		EA	1	1	1			
280049719 FREON R500 125LB CONTAINER								
N		EA	1	1	1			
900308156 FREON T-P35 MS160 16OZ CAN								
1187906	1	EA	IL IN MI OH WI 71 71 71 71 71					
A blend of Freon TF solvent and Isopropyl Alcohol used to remove corrosion, insect residue, etc., from block face plates and binding posts. Also for cleaning C.O. circuit packs.								
FUEL PUMP								
SEE PUMP FUEL.								
FUSE								
300064250 FUSE AGA 1 AMP								
N		EA	5	2	5			
300064268 FUSE AGA 3 AMP								
N		EA	5	2	5			
300064276 FUSE AGA 5 AMP								
N		EA	5	2	5			
300064284 FUSE AGA 7 1/2 AMP								
1193599	1	EA	IL IN MI OH WI 73 73 73 73 73					
300064292 FUSE AGA 20 AMP								
N		EA	5	2	5			
997894860 FUSE AGC 10 AMP								
1224592	1	EA	IL IN MI OH WI 73 73 73 73 73					
A cartridge fuse 1 1/4in long X 1/4in diameter with glass enclosure.								
997841622 FUSE AGC 15 AMP								
N		EA	5	2	5			

PRODUCT IDENTIFIER		DESCRIPTION						
ITEM NUMBER	ORD. MULT.	SELL UNIT	STD. PKG. STOCK AVAILABILITY / PA	LEAD TIME	MIN. ORD.	A	C	
300064300 FUSE AGC 20 AMP								
6511758	1	EA	IL IN MI OH WI 73 73 73 73 73					
300064318 FUSE AGC 30 AMP								
6511741	1	EA	IL IN MI OH WI 73 73 73 73 73					
300064326 FUSE AGW 5 AMP								
N		EA	5	2	5			
300064334 FUSE AGW 15 AMP								
1204651	1	EA	IL IN MI OH WI 73 73 73 73 73					
300064342 FUSE AGW 20 AMP								
N		EA	5	2	5			
300064359 FUSE ATC 5 AMP								
N		EA	5	2	5			
300064367 FUSE ATC 7 1/2 AMP								
6511691	1	EA	IL IN MI OH WI 73 73 73 73 73					
300064375 FUSE ATC 10 AMP								
6511683	5	EA	IL IN MI OH WI 73 73 73 73 73					
300064383 FUSE ATC 15 AMP								
6511675	5	EA	IL IN MI OH WI 73 73 73 73 73					
300064391 FUSE ATC 20 AMP								
1216275	5	EA	IL IN MI OH WI 73 73 73 73 73					
300064409 FUSE ATC 30 AMP								
6511659	5	EA	IL IN MI OH WI 73 73 73 73 73					
300064425 FUSE SFE 14 AMP								
6511634	1	EA	IL IN MI OH WI 73 73 73 73 73					
300064433 FUSE SFE 20 AMP								
1211615	1	EA	IL IN MI OH WI 73 73 73 73 73					
300064441 FUSE SFE 30 AMP								
6511618	1	EA	IL IN MI OH WI 73 73 73 73 73					
GAS CAP								
SEE CAP GAS.								
GREASE								
996482436 GREASE CK14774 L1 1OZ TUBE								
1139345	1	TU						
BSP 514-120-301.								

PRODUCT IDENTIFIER		DESCRIPTION					
ITEM NUMBER	ORD. MULT.	SELL UNIT	STD. PKG. STOCK AVAILABILITY / PA	LEAD TIME	MIN. ORD.	A C	
403549538 GREASE LITHIUM WHITE 4816							
1173559	1	EA	IL 72 IN 72 MI 72 OH 72 WI 72				
400456489 GREASE LUBRICANT 130AA							
1200527	1	TU	IL 72 IN 72 MI 72 OH 72 WI 72				
1 3/4 ounce tube.							
900604497 GREASE LUBRIPLATE M0-LITH NO. 2							
1187419	1	EA	IL 72 IN 72 MI OH WI 72 72				
900232042 GREASE NON-OXIDE 1LB CAN							
3154120	1	CN	IL 72 IN 72 MI OH WI 72 72				
Used on storage battery connections to prevent corrosion, BSP 167-410-201.							
403562036 GREASE RED 7001							
1129734	1	EA	IL 72 IN 72 MI 72 OH 72 WI 72				
402964456 GREASE SILICONE DIE D1920							
6114223	5	EA	IL 72 IN 72 MI 72 OH 72 WI 72				
300083235 GREASE SUNAPLEX 14OZ TUBE							
6513887	1	CS	IL 72 IN 72 MI OH WI 72 72 72 72				
10 per carton, 6 cartons per case.							
GUARD SPLASH							
300083342 GUARD SPLASH 4322 12IN X 18IN							
6513812	1	PR					
300083359 GUARD SPLASH 4407 7IN X 12IN							
6513820	1	PR	IL 71 IN 71 MI 71 OH 71 WI 71				
HANGER MUFFLER							
403549579 HANGER MUFFLER 8483							
5518464	1	EA					
HORN UNIVERSAL							
260302492 HORN UNIVERSAL D1931							
1939389	1	EA					
HOSE CLAMP							
SEE CLAMP HOSE.							
HOSE HEATER							
403235583 HOSE HEATER 65020 1/2IN X 50FT ROLL							
1225466	1	RO					

PRODUCT IDENTIFIER		DESCRIPTION					
ITEM NUMBER	ORD. MULT.	SELL UNIT	STD. PKG. STOCK AVAILABILITY / PA	LEAD TIME	MIN. ORD.	A C	
403235591 HOSE HEATER 65023 5/8IN X 50FT ROLL							
1118653	1	RO	IL 73 IN 73 MI 73 OH 73 WI 73				
403235609 HOSE HEATER 65026 3/4IN X 50FT ROLL							
1219022	1	RO	IL 73 IN 73 MI 73 OH 73 WI 73				
HOSE RADIATOR							
403213697 HOSE RADIATOR 61315							
1147652	1	EA					
260378062 HOSE RADIATOR BYPASS 20693							
1960278	1	EA	IL 73 IN MI OH WI 73 73 73				
403358518 HOSE RADIATOR BYPASS 63011							
1166892	1	EA	IL 73 IN 73 MI 73 OH 73 WI 73				
260378054 HOSE RADIATOR BYPASS 63020							
1960286	1	EA	IL 73 IN MI OH WI 73 73 73				
300039518 HOSE RADIATOR BYPASS 63836							
N		EA	10	1	10		
260378070 HOSE RADIATOR LOWER 20958							
1960260	1	EA	IL 73 IN MI OH WI 73 73 73				
403358542 HOSE RADIATOR LOWER 60701							
N		EA	10	4	10		
403358559 HOSE RADIATOR LOWER 60902							
1198754	1	EA	IL 73 IN 73 MI 73 OH 73 WI 73				
403358575 HOSE RADIATOR LOWER 60988							
1129361	1	EA	IL 73 IN 73 MI 73 OH 73 WI 73				
300070299 HOSE RADIATOR LOWER 61192							
N		EA	1	1	1		
300070307 HOSE RADIATOR LOWER 61268							
5122457	1	EA	IL 73 IN 73 MI 73 OH 73 WI 73				
260378088 HOSE RADIATOR UPPER 21406							
1960252	1	EA	IL 73 IN MI OH WI 73 73 73				
260378104 HOSE RADIATOR UPPER 21413							
1960237	1	EA	IL 73 IN MI OH WI 73 73 73				
260378096 HOSE RADIATOR UPPER 21620							
1960245	1	EA	IL 73 IN MI OH WI 73 73 73				
260378112 HOSE RADIATOR UPPER 21639							
1960310	1	EA	IL 73 IN MI OH WI 73 73 73				

DISTRIBUTION SERVICES
 NETWORK SERVICES
 TOOLS
 BUILDING JANITORIAL
 AUTOMOTIVE
 FORMS/OFFICE SUPPLIES
 GENERAL
 DATA VOICE

HOSE RADIATOR

PRODUCT IDENTIFIER DESCRIPTION

ITEM NUMBER	ORD. MULT.	SELL UNIT	STD. PKG. STOCK AVAILABILITY / PA	LEAD TIME	MIN. ORD.	A C
-------------	------------	-----------	-----------------------------------	-----------	-----------	-----

403358583 HOSE RADIATOR UPPER 60749
 1212050 1 EA IL IN MI OH WI
 73 73 73 73

403488752 HOSE RADIATOR UPPER 61025
 1129536 1 EA IL IN MI OH WI
 73 73 73 73

403358633 HOSE RADIATOR UPPER 61098
 5514067 1 EA IL IN MI OH WI
 73 73 73 73

300039583 HOSE RADIATOR UPPER 61106
 N EA 1 2 1

300070356 HOSE RADIATOR UPPER 61184
 5122416 1 EA IL IN MI OH WI
 73 73 73 73

ICE SCRAPER
 SEE SCRAPER ICE.

IGNITION COIL
 SEE COIL IGNITION.

IGNITION WIRES
 SEE WIRES IGNITION.

JOINT BALL
403234016 JOINT BALL LOWER K6117
 N EA 1 1 12

JOINT UNIVERSAL
403235617 JOINT UNIVERSAL 28053X
 1226076 1 EA
403235633 JOINT UNIVERSAL 28153X
 N EA 1 1 40

403235674 JOINT UNIVERSAL 283011
 1155754 1 EA IL IN MI OH WI
 73 73 73 73

260404876 JOINT UNIVERSAL 284800
 1977116 1 EA IL IN MI OH WI
 73 73 73 73
 For Ford trucks F150, F250, F350, E150, E350
 1980 thru 1989.

403235690 JOINT UNIVERSAL 284900
 5512145 1 EA IL IN MI OH WI
 73 73 73 73

260391016 JOINT UNIVERSAL 286300
 1965368 1 EA IL IN MI OH WI
 73 73 73 73
 Dodge U-joint that can be greased, replaces
 U-joint 286300G.

PRODUCT IDENTIFIER DESCRIPTION

ITEM NUMBER	ORD. MULT.	SELL UNIT	STD. PKG. STOCK AVAILABILITY / PA	LEAD TIME	MIN. ORD.	A C
-------------	------------	-----------	-----------------------------------	-----------	-----------	-----

403235708 JOINT UNIVERSAL 286300G
 1215814 1 EA IL IN MI OH WI
 73 73 73 73

403236367 JOINT UNIVERSAL 286600
 N EA 1 1 40

KIT CONTROL
403234065 KIT CONTROL ARM UP K6135
 N EA 4 4 4

KIT LUB OIL
280015637 KIT LUB OIL SAMPLING
 N EA 1 2 1

LAMP MINIATURE
260380076 LAMP MINIATURE 2057
 1960617 1 EA

260380084 LAMP MINIATURE 3157
 1960625 1 BX IL IN MI OH WI
 73 73 73 73

260380092 LAMP MINIATURE 3157NA
 1960633 1 BX IL IN MI OH WI
 73 73 73 73

260331871 LAMP MINIATURE 9005
 1947572 1 EA IL IN MI OH WI
 73 73 73 73

260331889 LAMP MINIATURE 9006
 1947580 1 EA IL IN MI OH WI
 73 73 73 73

402960983 LAMP MINIATURE L 53
 1133249 10 EA IL IN MI OH WI
 73 73 73 73

402960991 LAMP MINIATURE L 57
 1216960 10 EA IL IN MI OH WI
 73 73 73 73

402961015 LAMP MINIATURE L 89
 1143677 10 EA IL IN MI OH WI
 73 73 73 73

402961031 LAMP MINIATURE L 97
 N EA 10 1 10

402961049 LAMP MINIATURE L 194
 1149104 10 EA IL IN MI OH WI
 73 73 73 73

402961064 LAMP MINIATURE L 211-2
 1134692 10 EA IL IN MI OH WI
 73 73 73 73

DISTRIBUTION SERVICES

NETWORK SERVICES

TOOLS

BUILDING JANITORIAL

AUTOMOTIVE

FORMS/OFFICE SUPPLIES

GENERAL

DATA VOICE

PRODUCT IDENTIFIER		DESCRIPTION					
ITEM NUMBER	ORD. MULT.	SELL UNIT	STD. PKG. STOCK AVAILABILITY / PA	LEAD TIME	MIN. ORD.	A	C
300083128 LAMP MINIATURE L 906							
6513770	10	EA	IL 73 IN 73 MI 73 OH 73 WI 73				
T5 Wedge lamp.							
402961080 LAMP MINIATURE L 1004							
6122705	10	EA	IL 73 IN 73 MI 73 OH 73 WI 73				
402961106 LAMP MINIATURE L 1073							
1157115	10	EA	IL 73 IN 73 MI 73 OH 73 WI 73				
300064466 LAMP MINIATURE L 1156							
1223677	10	EA	IL 73 IN 73 MI 73 OH 73 WI 73				
Miniature auto type lamp with S-8 bulb. Base pins are approximately at right angles to plane of filament.							
402961122 LAMP MINIATURE L 1157							
1176057	10	EA	IL 73 IN 73 MI 73 OH 73 WI 73				
402961130 LAMP MINIATURE L 1157A							
1133298	10	EA	IL 73 IN 73 MI 73 OH 73 WI 73				
402961163 LAMP MINIATURE L 1895							
N		EA	10	1		10	
260363213 LAMP MINIATURE L 2057NA							
1954313	1	EA	IL 73 IN 73 MI 73 OH 73 WI 73				
Package of 10.							
260377866 LAMP MINIATURE L 3057							
1960088	10	EA	IL 73 IN 73 MI 73 OH 73 WI 73				
260377874 LAMP MINIATURE L 3057NA							
1960070	10	EA	IL 73 IN 73 MI 73 OH 73 WI 73				
LAMP REPLACEMENT							
260417142 LAMP REPLACEMENT 9004							
1972281	1	EA					
Lamp replacement Halogen bulb.							
LITE TRUCK							
300083276 LITE TRUCK 40202 MOD40 RED							
6513853	1	EA					
300083284 LITE TRUCK 40202Y MOD40 YELLOW							
N		EA	5	1		5	
300083292 LITE TRUCK 40204 MOD40 WHITE							
6513861	1	EA	IL 73 IN 73 MI 73 OH 73 WI 73				

PRODUCT IDENTIFIER		DESCRIPTION					
ITEM NUMBER	ORD. MULT.	SELL UNIT	STD. PKG. STOCK AVAILABILITY / PA	LEAD TIME	MIN. ORD.	A	C

LUBRICANT

300000437 LUBRICANT CHAIN 7006 12/CS							
N		CS	1	4		1	
300000445 LUBRICANT DRY FILM 7002 12/CS							
N		CS	1	2		1	
900217654 LUBRICANT FISKE 930AA							
5213728	1	CS	IL 72 IN 72 MI 72 OH 72 WI 72				
300064458 LUBRICANT GEAR REAR END 90 WEIGHT							
1217612	1	PL	IL 72 IN 72 MI 72 OH 72 WI 72				
35 pounds per pail.							

MIRROR

280062829 MIRROR 4 15/16IN X 7 7/8IN 4L							
N		EA	1	5		1	
Left.							
280062845 MIRROR 4 15/16IN X 7 7/8IN 4R							
N		EA	1	5		1	
Right.							
280062811 MIRROR 5 3/4IN X 8 3/4IN 2L							
N		EA	1	5		1	
Left.							
280062803 MIRROR 5 3/4IN X 8 3/4IN 2R							
N		EA	1	5		1	
Right.							
280062795 MIRROR 6 1/4IN X 8 13/16IN 1L							
1934166	1	EA	IL 73 IN 73 MI 73 OH 73 WI 73				
Left.							
280062787 MIRROR 6 1/4IN X 8 13/16IN 1R							
1934539	1	EA	IL 73 IN 73 MI 73 OH 73 WI 73				
Right.							
280062779 MIRROR 6 1/4IN X 8 13/16IN 15R							
1934174	1	EA	IL 73 IN 73 MI 73 OH 73 WI 73				
Right.							
280062761 MIRROR 7 IN X 9 IN 9L							
1934521	1	EA	IL 73 IN 73 MI 73 OH 73 WI 73				
Left.							
280062753 MIRROR 7 IN X 9 IN 10R							
N		EA	1	5		1	
Right.							

DISTRIBUTION SERVICES

NETWORK SERVICES

TOOLS

BUILDING JANITORIAL

AUTOMOTIVE

FORMS/OFFICE SUPPLIES

GENERAL

DATA VOICE

MIRROR ASSEMBLY

PRODUCT IDENTIFIER		DESCRIPTION				
ITEM NUMBER	ORD. MULT.	SELL UNIT	STD. PKG. STOCK AVAILABILITY / PA	LEAD TIME	MIN. ORD.	A C

PRODUCT IDENTIFIER		DESCRIPTION				
ITEM NUMBER	ORD. MULT.	SELL UNIT	STD. PKG. STOCK AVAILABILITY / PA	LEAD TIME	MIN. ORD.	A C

MIRROR ASSEMBLY

280003831 MIRROR ASSEMBLY SS-520/704093
1921254 1 EA
Flat.

280003849 MIRROR ASSEMBLY SS-530/704095
1921270 1 EA
Convex.

IL	IN	MI	OH	WI
73	73	73	73	73

MIRROR GLASS

300013844 MIRROR GLASS G520 FLAT
1172445 1 EA
Velvac 7020519.

300013836 MIRROR GLASS G530 CONVEX
1189639 1 EA
Velvac 7020579.

IL	IN	MI	OH	WI
73	73	73	73	73

MIRROR SPOT

260353677 MIRROR SPOT 723065
1951970 4 EA

MODULE DISTRIBUTOR

SEE POINT MODULE

MOLLY LUBE

300064508 MOLLY LUBE EXTRA RANGE II
6511550 1 DR

MUFFLER

403234578 MUFFLER M 848
5506964 1 EA

403234560 MUFFLER M1049
5506949 1 EA

IL	IN	MI	OH	WI
73		73	73	73

403234644 MUFFLER M1368
1230730 1 EA

IL	IN	MI	OH	WI
73		73	73	73

403234693 MUFFLER M1424
5507202 1 EA

IL	IN	MI	OH	WI
73		73	73	73

403234669 MUFFLER M1493
1172718 1 EA

IL	IN	MI	OH	WI
73		73	73	73

MUFFLER CLAMP

SEE CLAMP MUFFLER.

MUFFLER HANGER

SEE HANGER MUFFLER.

OIL

260361266 OIL 5W30 SC/CC 55 GALLON DRUM
1954057 1 DR

300060829 OIL 10W30 SUNFLT QUART
6511071 1 CS

IL	IN	MI	OH	WI
72	72	72	72	72

12 quarts per case.

300060811 OIL 10W30 ULTRA 55 GALLON DRUM
6511089 1 DR

IL	IN	MI	OH	WI
72		72	72	72

Sunfleet.

300060837 OIL 10W40 SUNFLT 55 GALLON DRUM
N DR 1 4 20

300064474 OIL 15W40 SUNFLT 55 GALLON DRUM
6511576 1 DR

IL	IN	MI	OH	WI
72		72	72	72

280099664 OIL 15W40 SUNFLT QUART
1937755 1 CS

IL	IN	MI	OH	WI
72	72	72	72	72

12 quarts per case.

300064490 OIL 30W NON-DETERGENT QUART
6511584 1 CS

IL	IN	MI	OH	WI
72		72	72	72

12 quarts per case.

280014317 OIL 623B SPECIFY BOTTLE SIZE
N BT 1 1 1
Minimum \$ 20.00.

400826533 OIL CK 6232 4OZ BOTTLE
1204669 1 BT

IL	IN	MI	OH	WI
72	72	72	72	72

900218819 OIL DELVAC 1200
N CS 1 6 19
24 quarts per case.

001041839 OIL DELVAC 1200 MOBIL
1188813 1 CS

IL	IN	MI	OH	WI
72		72	72	72

Lube oil for 16 cylinder Detroit Diesel. Has low ash content, 24 quarts per case.

001041821 OIL DELVAC 1300 SAE 10 DETERGENT
6349464 1 CS

IL	IN	MI	OH	WI
72	72	72	72	72

12 quarts per case.

DISTRIBUTION SERVICES

NETWORK SERVICES

TOOLS

BUILDING JANITORIAL

AUTOMOTIVE

FORMS/OFFICE SUPPLIES

GENERAL

DATA VOICE

PRODUCT IDENTIFIER		DESCRIPTION						
ITEM NUMBER	ORD. MULT.	SELL UNIT	STD. PKG. STOCK AVAILABILITY / PA	LEAD TIME			MIN. ORD.	A C
260361274 OIL DELVAC-1 5W40 55 GALLON DRUM								
1953968	1	DR	IL IN MI OH WI 72 72 72 72					
401076575 OIL EXTRA RANGE 2 CYCLE QUART								
3347203	1	QT	IL IN MI OH WI 72 72 72 72					
Multi purpose.								
300060795 OIL HYDRALIC SUN 2105 5 GALLON								
6511105	1	PL	IL IN MI OH WI 72 72 72 72					
300060803 OIL HYDRALIC SUN 2105 55 GALLON								
6511097	1	DR	IL IN MI OH WI 72 72 72 72					
001041664 OIL LUBE SAE 10 NONDETERGENT								
7286484	1	CS	IL IN MI OH WI 72 72 72 72					
24 quarts per case.								
900218884 OIL LUBE SAE REGULAR 20 QUART								
1136994	1	QT	IL IN MI OH WI 72 72 72 72					
Penzoil.								
260380811 OIL MOBIL DELVAC 1330 GALLON								
1960906	1	CS	IL IN MI OH WI 72 72 72 72					
001041672 OIL REGULAR 30 MOBIL								
7286468	1	QT	IL IN MI OH WI 72 72 72 72					
260380829 OIL SHELL ROTELLA T-30 GALLON								
1960914	1	CS	IL IN MI OH WI 72 72 72 72					
Use with Detroit GM Diesel.								

OIL CAP
SEE CAP OIL.

PAD DISC BRAKE

403212624 PAD DISC BRAKE PG D 52M								
1186197	1	SE						
Set of 4.								
403212673 PAD DISC BRAKE PG D139								
N		SE	1	1	1			
Set of 4.								
260390240 PAD DISC BRAKE PG D215M								
1964791	1	SE	IL IN MI OH WI 73 73 73 73					
260361290 PAD DISC BRAKE PG D221M								
1954008	1	SE	IL IN MI OH WI 73 73 73 73					
Set of 4.								

PRODUCT IDENTIFIER		DESCRIPTION						
ITEM NUMBER	ORD. MULT.	SELL UNIT	STD. PKG. STOCK AVAILABILITY / PA	LEAD TIME			MIN. ORD.	A C
260390273 PAD DISC BRAKE PG D224M								
1964825	1	SE	IL IN MI OH WI 73 73 73 73					
260390299 PAD DISC BRAKE PG D225M								
1964841	1	SE	IL IN MI OH WI 73 73 73 73					
260418405 PAD DISC BRAKE PG D257M FRONT								
1973305	1	SE	IL IN MI OH WI 73 73 73 73					
260377908 PAD DISC BRAKE PG D259M								
1960062	1	SE	IL IN MI OH WI 73 73 73 73					
260361282 PAD DISC BRAKE PG D289M								
1954081	1	SE	IL IN MI OH WI 73 73 73 73					
Set of 4.								
260390257 PAD DISC BRAKE PG D289M								
N		SE	1	4	1			
260417498 PAD DISC BRAKE PG D324M								
1972125	1	SE	IL IN MI OH WI 73 73 73 73					
260417506 PAD DISC BRAKE PG D324M FRONT								
1971770	1	SE	IL IN MI OH WI 73 73 73 73					
260418454 PAD DISC BRAKE PG D337 REAR								
1973354	1	SE	IL IN MI OH WI 73 73 73 73					
260382551 PAD DISC BRAKE PG D344M								
1961573	1	SE	IL IN MI OH WI 73 73 73 73					
Application on Dodge Dakota 3.9L.								
260417514 PAD DISC BRAKE PG D344M FRONT								
1971762	1	SE	IL IN MI OH WI 73 73 73 73					
260417522 PAD DISC BRAKE PG D347R REAR								
1971788	1	SE	IL IN MI OH WI 73 73 73 73					
260418421 PAD DISC BRAKE PG D376M FRONT								
1973321	1	SE	IL IN MI OH WI 73 73 73 73					
260418447 PAD DISC BRAKE PG D385M FRONT								
1973347	1	SE	IL IN MI OH WI 73 73 73 73					
260418439 PAD DISC BRAKE PG D421M FRONT								
1973339	1	SE	IL IN MI OH WI 73 73 73 73					
260440920 PAD DISC BRAKE PGD375M								
N		EA	1	2	1			
'87-91 Ford E100-150 Van, F100-150 Pickup.								

DISTRIBUTION SERVICES
NETWORK SERVICES
TOOLS
BUILDING JANITORIAL
AUTOMOTIVE
FORMS/OFFICE SUPPLIES
GENERAL
DATA VOICE

PAD DISC BRAKE

PRODUCT IDENTIFIER		DESCRIPTION						
ITEM NUMBER	ORD. MULT.	SELL UNIT	STD. PKG.	LEAD TIME		MIN. ORD.	A C	
			STOCK AVAILABILITY / PA					
260390265 PAD DISC BRAKE SS D369								
1964817	1	SE	IL 73	IN	MI	OH 73	WI 73	
260390281 PAD DISC BRAKE SS D370								
1964833	1	SE	IL 73	IN	MI	OH 73	WI 73	
403558851 PAD DISC BRAKE SSD 120								
1194894	1	SE	IL 73	IN	MI	OH 73	WI 73	
Set of 4.								
403212665 PAD DISC BRAKE SSRD 123								
1168096	1	SE	IL 73	IN	MI	OH 73	WI 73	
Set of 4.								
403212681 PAD DISC BRAKE SSRD 142								
1220063	1	SE	IL 73	IN	MI	OH 73	WI 73	
Set of 4.								
403212699 PAD DISC BRAKE SSRD 153								
5504209	1	SE	IL 73	IN	MI	OH 73	WI 73	
Set of 4.								
300070406 PAD DISC BRAKE SSRD 154								
5122556	1	SE	IL 73	IN	MI	OH 73	WI 73	
Set of 4.								
300009669 PAD DISC BRAKE SSRD 170								
1135186	1	EA	IL 73	IN	MI	OH 73	WI 73	
Set of 4.								
403212707 PAD DISC BRAKE SSRD 183								
1171397	1	SE	IL 73	IN	MI	OH 73	WI 73	
Set of 4.								
300070414 PAD DISC BRAKE SSRD 190								
5122531	1	SE	IL 73	IN	MI	OH 73	WI 73	
Set of 4.								
260339247 PAD DISC BRAKE SSRD 269								
1948711	1	SE	IL 73	IN	MI	OH 73	WI 73	
Set of 4.								
260339858 PAD DISC BRAKE SSRD 313								
1949263	1	SE	IL 73	IN	MI	OH 73	WI 73	
Set of 4.								
260417530 PAD DISC BRAKE SSRD 421A								
1971796	1	SE	IL 73	IN	MI	OH 73	WI 73	

PRODUCT IDENTIFIER		DESCRIPTION						
ITEM NUMBER	ORD. MULT.	SELL UNIT	STD. PKG.	LEAD TIME		MIN. ORD.	A C	
			STOCK AVAILABILITY / PA					
PAINT								
300073830 PAINT 7806 FLAT BLACK								
6512517	1	CN						
16oz spray.								
300083318 PAINT 7844 PRIMER NAPA								
6513762	1	CN	IL 71	IN	MI	OH 71	WI 71	
260339866 PAINT 7865 PRIMER LIGHT GREY								
1949198	1	EA	IL 71	IN	MI	OH 71	WI 71	
12 cans per case.								
300073822 PAINT 7867 BRIGHT ALUMINUM								
6512525	1	CN	IL 71	IN	MI	OH 71	WI 71	
16oz spray.								
300073855 PAINT 79-11008 WHITE								
6512541	1	CN	IL 71	IN	MI	OH 71	WI 71	
Touch-up paint for building operations.								
300073848 PAINT 79-11009 GREEN GRAY								
6512533	1	CN	IL 71	IN	MI	OH 71	WI 71	
16oz spray.								
PCV VALVE								
SEE VALVE PCV.								
PICK-UP COIL								
SEE COIL PICK-UP.								
PIN								
280015850 PIN SWIVEL S.S. F254								
N		PK	1			4	1	
Package of 20.								
PIPE EXHAUST								
403234511 PIPE EXHAUST 18004								
5506865	1	EA						
PIPE EXTENSION								
300000452 PIPE EXTENSION 24662								
1134551	1	EA						
PIPE TAIL								
403234792 PIPE TAIL 54650								
5507400	1	EA						

DISTRIBUTION SERVICES

NETWORK SERVICES

TOOLS

BUILDING JANITORIAL

AUTOMOTIVE

FORMS/OFFICE SUPPLIES

GENERAL

DATA VOICE

DISTRIBUTION SERVICES

NETWORK SERVICES

TOOLS

BUILDING JANITORIAL

AUTOMOTIVE

FORMS/OFFICE SUPPLIES

GENERAL

DATA VOICE

PRODUCT IDENTIFIER		DESCRIPTION						
ITEM NUMBER	ORD. MULT.	SELL UNIT	STD. PKG. STOCK AVAILABILITY / PA	LEAD TIME			MIN. ORD.	A C
403234818 PIPE TAIL 64630								
5507442	1	EA	IL IN MI OH WI 73 73 73 73					
403234800 PIPE TAIL 64640								
5507426	1	EA	IL IN MI OH WI 73 73 73 73					
403234834 PIPE TAIL 74439								
5507483	1	EA	IL IN MI OH WI 73 73 73 73					

PLUG GLOW

260396601 PLUG GLOW AC 8G								
1967745	1	EA						
Application on 7.3L Ford diesel.								

PLUG SPARK

260377882 PLUG SPARK 43TS								
N		EA	104		4			104
300037694 PLUG SPARK 45L								
6505933	1	EA	IL IN MI OH WI 73 73 73 73					
260419155 PLUG SPARK ASF42C								
1974063	1	EA	IL IN MI OH WI 73 73 73 73					
260419197 PLUG SPARK BSF42C								
1974105	1	EA	IL IN MI OH WI 73 73 73 73					
260419213 PLUG SPARK BSF44C								
1974121	1	EA	IL IN MI OH WI 73 73 73 73					
403558844 PLUG SPARK C 45L								
5518969	1	EA	IL IN MI OH WI 73 73 73 73					
402961197 PLUG SPARK C 84T								
N		EA	8		1			8
260390125 PLUG SPARK CR 43TS								
1964676	1	EA	IL IN MI OH WI 73 73 73 73					
260419171 PLUG SPARK FR 3LM								
1974089	1	EA	IL IN MI OH WI 73 73 73 73					
260419163 PLUG SPARK J8C								
1974071	1	EA	IL IN MI OH WI 73 73 73 73					
260390166 PLUG SPARK L 43LTSE								
1964692	1	EA	IL IN MI OH WI 73 73 73 73					

PRODUCT IDENTIFIER		DESCRIPTION						
ITEM NUMBER	ORD. MULT.	SELL UNIT	STD. PKG. STOCK AVAILABILITY / PA	LEAD TIME			MIN. ORD.	A C
300034782 PLUG SPARK R 42LTS								
1185132	1	EA	IL IN MI OH WI 73 73 73 73					
402961205 PLUG SPARK R 42TS								
N		EA	104		1			104
403547078 PLUG SPARK R 42TS								
1224261	1	EA	IL IN MI OH WI 73 73 73 73					
300034832 PLUG SPARK R 42XLS								
6501262	1	EA	IL IN MI OH WI 73 73 73 73					
300034840 PLUG SPARK R 43CXLS								
6501288	1	EA	IL IN MI OH WI 73 73 73 73					
402961213 PLUG SPARK R 43LTS								
N		EA	8		4			8
260417605 PLUG SPARK R 43LTSE								
1971929	1	EA	IL IN MI OH WI 73 73 73 73					
300070547 PLUG SPARK R 43NTSE								
5122150	8	EA	IL IN MI OH WI 73 73 73 73					
402961221 PLUG SPARK R 43T								
1222430	1	EA	IL IN MI OH WI 73 73 73 73					
300006475 PLUG SPARK R 43TS								
1211011	1	EA	IL IN MI OH WI 73 73 73 73					
260345194 PLUG SPARK R 43TS6								
1950972	1	EA	IL IN MI OH WI 73 73 73 73					
260417613 PLUG SPARK R 43XLS								
1971879	1	EA	IL IN MI OH WI 73 73 73 73					
300070554 PLUG SPARK R 44LTS								
5122358	1	EA	IL IN MI OH WI 73 73 73 73					
260390158 PLUG SPARK R 44LTS6								
1964700	1	EA	IL IN MI OH WI 73 73 73 73					
260361407 PLUG SPARK R 44LTSM								
1954131	1	EA	IL IN MI OH WI 73 73 73 73					
Eight per set.								
260417621 PLUG SPARK R 44NTSE								
1971903	1	EA	IL IN MI OH WI 73 73 73 73					
402961247 PLUG SPARK R 44T								
1128298	1	EA	IL IN MI OH WI 73 73 73 73					

PLUG SPARK

PRODUCT IDENTIFIER	DESCRIPTION							
	ITEM NUMBER	ORD. MULT.	SELL UNIT	STD. PKG. STOCK AVAILABILITY / PA	LEAD TIME		MIN. ORD.	A C
402961254 PLUG SPARK R 44TS								
1227330	1	EA	IL IN 73 73	MI OH WI 73 73				
260390133 PLUG SPARK R 44TS6								
1964684	1	EA	IL IN 73 73	MI OH WI 73 73				
300034857 PLUG SPARK R 44TS8								
N		EA	8		1		8	
402961262 PLUG SPARK R 44TSX								
1183855	8	EA	IL IN 73 73	MI OH WI 73 73				
402961270 PLUG SPARK R 44TX								
N		EA	104		1		104	
300034790 PLUG SPARK R 44XLS								
N		EA	8		1		8	
402961288 PLUG SPARK R 44XLS								
1205716	1	EA	IL IN 73 73	MI OH WI 73 73				
402961304 PLUG SPARK R 45								
1151530	1	EA	IL IN 73 73	MI OH WI 73 73				
260302690 PLUG SPARK R 45LS								
1939439	1	EA	IL IN 73 73	MI OH WI 73 73	8 plugs per pack.			
402961312 PLUG SPARK R 45TS								
1130872	1	EA	IL IN 73 73	MI OH WI 73 73				
300034873 PLUG SPARK R 45TS8								
N		EA	8		1		8	
402961320 PLUG SPARK R 45XLS								
1138990	1	EA	IL IN 73 73	MI OH WI 73 73				
402961338 PLUG SPARK R 46LTS								
N		EA	8		4		8	
402961353 PLUG SPARK R 46T								
N		EA	104		1		104	
402961361 PLUG SPARK R 46TS								
1138230	1	EA	IL IN 73 73	MI OH WI 73 73				
300034808 PLUG SPARK R 46TSX								
6501437	1	EA	IL IN 73 73	MI OH WI 73 73				
402961379 PLUG SPARK R 46TX								
N		EA	104		4		104	
402961411 PLUG SPARK R 83T								
1196352	1	EA	IL IN 73 73	MI OH WI 73 73				

PRODUCT IDENTIFIER	DESCRIPTION							
	ITEM NUMBER	ORD. MULT.	SELL UNIT	STD. PKG. STOCK AVAILABILITY / PA	LEAD TIME		MIN. ORD.	A C
260390174 PLUG SPARK R 83TS								
1964726	1	EA	IL IN 73 73	MI OH WI 73 73				
402961387 PLUG SPARK R 84TS								
1143529	1	EA	IL IN 73 73	MI OH WI 73 73				
402961395 PLUG SPARK R 85TS								
1174268	1	EA	IL IN 73 73	MI OH WI 73 73				
300034865 PLUG SPARK R43T56								
N		EA	104		4		104	
260419205 PLUG SPARK RS16YC								
1974113	1	EA	IL IN 73 73	MI OH WI 73 73				
POINT IGNITION								
300070398 POINT IGNITION D1961								
N		EA	1		1		1	
POINT MODULE								
402961445 POINT MODULE C 1900Z								
N		EA	1		1		1	
402961452 POINT MODULE C 1908								
1127910	1	EA	IL IN 73 73	MI OH WI 73 73	Distributor.			
402961502 POINT MODULE D 1906								
1193623	1	EA	IL IN 73 73	MI OH WI 73 73	Distributor.			
260389937 POINT MODULE D 1922A								
1965053	1	EA	IL IN 73 73	MI OH WI 73 73				
260389945 POINT MODULE D 1927A								
1965061	1	EA	IL IN 73 73	MI OH WI 73 73				
260418090 POINT MODULE D 1928A								
1972976	1	EA	IL IN 73 73	MI OH WI 73 73				
260389952 POINT MODULE D 1929A								
1965079	1	EA	IL IN 73 73	MI OH WI 73 73				
260389929 POINT MODULE D 1946A								
1965046	1	EA	IL IN 73 73	MI OH WI 73 73				
300070380 POINT MODULE D 1959								
1225557	1	EA	IL IN 73 73	MI OH WI 73 73	Distributor.			

DISTRIBUTION SERVICES

PRODUCT IDENTIFIER		DESCRIPTION						
ITEM NUMBER	ORD. MULT.	SELL UNIT	STD. PKG. STOCK AVAILABILITY / PA	LEAD TIME	MIN. ORD.	A	C	
300035227 POINT MODULE D 1959								
N		EA	1	2	1			
260417548 POINT MODULE D 1967								
1971812	1	EA	IL IN MI OH WI 73 73 73 73					
260389978 POINT MODULE D 1980								
1965103	1	EA	IL IN MI OH WI 73 73 73 73					
260389911 POINT MODULE D 1990								
1965038	1	EA	IL IN MI OH WI 73 73 73 73					
260389960 POINT MODULE D 1992								
1965087	1	EA	IL IN MI OH WI 73 73 73 73					
402961551 POINT MODULE F 1910								
6504340	1	EA	IL IN MI OH WI 73 73 73 73 73					
Distributor.								
260389994 POINT MODULE F 1931								
1965095	1	EA	IL IN MI OH WI 73 73 73 73					

POWER STEERING FLUID
SEE FLUID POWER-STEERING.

PRIMER
260380100 PRIMER EXTEND 79DA-81849
1960641 1 CS

PROTECTOR BATTERY TERMINAL

300083094 PROTECTOR BATTERY TERMINAL 7011							
6513911	1	EA					
Ray.							

PUMP FUEL

300035268 PUMP FUEL 41034							
N		EA	1	4	1		
402961783 PUMP FUEL 41124							
N		EA	1	1	1		
402961817 PUMP FUEL 41169							
1220954	1	EA	IL IN MI OH WI 73 73 73 73				
402961577 PUMP FUEL 41263							
1131201	1	EA	IL IN MI OH WI 73 73 73 73				
280038852 PUMP FUEL 42073							
N		EA	1	4	1		

PRODUCT IDENTIFIER		DESCRIPTION						
ITEM NUMBER	ORD. MULT.	SELL UNIT	STD. PKG. STOCK AVAILABILITY / PA	LEAD TIME	MIN. ORD.	A	C	
280028929 PUMP FUEL 42073								
1922559	1	EA	IL IN MI OH WI 73 73 73 73					
280038860 PUMP FUEL 42186								
N		EA	1	4	1			
260369335 PUMP FUEL AC42186								
1955831	1	EA	IL IN MI OH WI 73 73 73 73					
300076635 PUMP FUEL ELECTRIC 235A								
5123877	1	EA	IL IN MI OH WI 73 73 73 73					
260378146 PUMP FUEL ELECTRIC EP125								
1960385	1	EA	IL IN MI OH WI 72 72 72 72					
280038845 PUMP FUEL EP253								
1960344	1	EA	IL IN MI OH WI 72 72 72 72					

NETWORK SERVICES

TOOLS

PUMP WASHER

403233893 PUMP WASHER 61-05							
N		EA	4	1	4		
403233901 PUMP WASHER 63-01							
1132837	4	EA	IL IN MI OH WI 71 71 71 71				
Anco.							
403233919 PUMP WASHER 65-01							
1226274	4	EA	IL IN MI OH WI 71 71 71 71				

BUILDING JANITORIAL

AUTOMOTIVE

PUMP WATER

402961874 PUMP WATER NEW 251-154							
1143016	1	EA					
402962062 PUMP WATER NEW 251-225							
1224287	1	EA	IL IN MI OH WI 73 73 73 73				
402961866 PUMP WATER NEW 251-304							
1110916	1	EA	IL IN MI OH WI 73 73 73 73				
260377619 PUMP WATER NEW 251-306							
1959791	1	EA	IL IN MI OH WI 73 73 73 73				
300035359 PUMP WATER NEW 251-308							
N		EA	1	4	1		
300070430 PUMP WATER NEW 251-334							
N		EA	1	1	1		
260378161 PUMP WATER NEW 251-376							
1960369	1	EA	IL IN MI OH WI 73 73 73 73				

FORMS/OFFICE SUPPLIES

GENERAL

DATA VOICE

PUMP WATER

DISTRIBUTION SERVICES

PRODUCT IDENTIFIER		DESCRIPTION						
ITEM NUMBER	ORD. MULT.	SELL UNIT	STD. PKG. STOCK AVAILABILITY / PA	LEAD TIME	MIN. ORD.	A	C	
403485956 PUMP WATER NEW 251-394								
1169805	1	EA	IL 73 IN 73 MI 73 OH 73 WI 73					

NETWORK SERVICES

RADIATOR							
402962120 RADIATOR X40 ANTI-RUST							
6114066	1	EA					

402962146 RADIATOR X41 STOP-LEAK							
1143792	1	EA	IL 73 IN 73 MI 73 OH 73 WI 73				

402962138 RADIATOR X42 FAST-FLUSH							
1142323	1	EA	IL 73 IN 73 MI 73 OH 73 WI 73				

TOOLS

RADIATOR CAP							
SEE CAP RADIATOR.							

BUILDING JANITORIAL

REGULATOR							
402962153 REGULATOR C 603Z							
1170258	1	EA					

402962179 REGULATOR D 680							
1139832	1	EA	IL 73 IN 73 MI 73 OH 73 WI 73				

402962187 REGULATOR F 608Z							
1191601	1	EA	IL 73 IN 73 MI 73 OH 73 WI 73				

260339874 REGULATOR F 609							
1949354	1	EA	IL 73 IN 73 MI 73 OH 73 WI 73				

AUTOMOTIVE

RELUCTOR							
-----------------	--	--	--	--	--	--	--

260418900 RELUCTOR C 1903Z							
1972083	1	EA					

402962211 RELUCTOR C 1904Z							
1228585	1	EA	IL 73 IN 73 MI 73 OH 73 WI 73				

402962229 RELUCTOR F 1903Z							
N	EA	1		4			1

260418165 RELUCTOR F 1923							
1973040	1	EA	IL 73 IN 73 MI 73 OH 73 WI 73				

FORMS/OFFICE SUPPLIES

GENERAL

ROD TIE-IN							
-------------------	--	--	--	--	--	--	--

403234255 ROD TIE-IN ES 409L							
N	EA	1		4			4

DATA VOICE

PRODUCT IDENTIFIER		DESCRIPTION						
ITEM NUMBER	ORD. MULT.	SELL UNIT	STD. PKG. STOCK AVAILABILITY / PA	LEAD TIME	MIN. ORD.	A	C	

ROD TIE-OUT							
--------------------	--	--	--	--	--	--	--

403234263 ROD TIE-OUT ES 409R							
5508481	1	EA					

ROTOR							
--------------	--	--	--	--	--	--	--

300034923 ROTOR C 402							
6503458	1	EA					

280028937 ROTOR C 405							
N	EA	1		1			1

300034931 ROTOR C 411							
6503631	1	EA	IL 73 IN 73 MI 73 OH 73 WI 73				

402962278 ROTOR C 411Z							
1109173	1	EA	IL 73 IN 73 MI 73 OH 73 WI 73				

260390034 ROTOR C 414							
1964577		EA	IL 73 IN 73 MI 73 OH 73 WI 73				

260417563 ROTOR C 415							
1971853	1	EA	IL 73 IN 73 MI 73 OH 73 WI 73				

402962302 ROTOR D 432							
1109298	1	EA	IL 73 IN 73 MI 73 OH 73 WI 73				

403547037 ROTOR D 434							
1174052	1	EA	IL 73 IN 73 MI 73 OH 73 WI 73				

403547045 ROTOR D 436							
1105056	1	EA	IL 73 IN 73 MI 73 OH 73 WI 73				

260339882 ROTOR D 446							
1949206	1	EA	IL 73 IN 73 MI 73 OH 73 WI 73				

260390026 ROTOR D 447							
1964569	1	EA	IL 73 IN 73 MI 73 OH 73 WI 73				

402962310 ROTOR D 448							
1157230	1	EA	IL 73 IN 73 MI 73 OH 73 WI 73				

260361308 ROTOR D 450							
1954065	1	EA	IL 73 IN 73 MI 73 OH 73 WI 73				

260421938 ROTOR DISTRIBUTOR E7PZ12200A							
1975128		EA	IL 73 IN 73 MI 73 OH 73 WI 73				

260418124 ROTOR E 460							
1973008	1	EA	IL 73 IN 73 MI 73 OH 73 WI 73				

PRODUCT IDENTIFIER		DESCRIPTION					
ITEM	ORD.	SELL	STD. PKG.	LEAD TIME		MIN.	A
NUMBER	MULT.	UNIT	STOCK AVAILABILITY / PA		ORD.	C	
402962328 ROTOR F 400Z							
N		EA	10		1	10	
402962385 ROTOR F 408Z							
1131433	1	EA	IL	IN	MI	OH	WI
			73		73	73	73
402962393 ROTOR F 409Z							
1229484	1	EA	IL	IN	MI	OH	WI
			73		73	73	73
260418157 ROTOR F 426							
1973032	1	EA	IL	IN	MI	OH	WI
			73			73	73
260417571 ROTOR F 427							
1971895	1	EA	IL	IN	MI	OH	WI
			73			73	73
260390059 ROTOR F 432							
1964593		EA	IL	IN	MI	OH	WI
			73			73	73
260384862 ROTOR MOPAR 4379131							
1962662	1	EA	IL	IN	MI	OH	WI
			73			73	73

RUSTPROOF

300083326 RUSTPROOF 117 PERMATEX								
6513838	1	EA						
			Aerosol can.					

SCRAPER ICE

300083250 SCRAPER ICE TRW659601								
6513879	1	EA						

SEAL

403236474 SEAL 19273							
N		EA	1		1	10	
403236490 SEAL 19500							
N		EA	1		4	10	
403236508 SEAL 19753							
5510941	1	EA	IL	IN	MI	OH	WI
			73	73	73	73	73
403236565 SEAL 20425							
5511063	1	EA	IL	IN	MI	OH	WI
			73	73	73	73	73
403236797 SEAL 24917 CR							
1959783	1	EA	IL	IN	MI	OH	WI
			73			73	73
403236250 SEAL 28425							
1178210	1	EA	IL	IN	MI	OH	WI
			73	73	73	73	73

PRODUCT IDENTIFIER		DESCRIPTION					
ITEM	ORD.	SELL	STD. PKG.	LEAD TIME		MIN.	A
NUMBER	MULT.	UNIT	STOCK AVAILABILITY / PA		ORD.	C	
403236268 SEAL 28720							
5511782	1	EA	IL	IN	MI	OH	WI
			73	73	73	73	73
260417985 SEAL FRONT 15746							
1972869	1	EA	IL	IN	MI	OH	WI
			73			73	73
260390463 SEAL FRONT 18765							
1964528	1	EA	IL	IN	MI	OH	WI
			73			73	73
260390471 SEAL FRONT 21952							
1964536	1	EA	IL	IN	MI	OH	WI
			73			73	73
260417993 SEAL FRONT 24003							
1972877	1	EA	IL	IN	MI	OH	WI
			73			73	73
260418009 SEAL FRONT 24097							
1972885	1	EA	IL	IN	MI	OH	WI
			73			73	73
260418017 SEAL FRONT 27467							
1972893	1	EA	IL	IN	MI	OH	WI
			73			73	73
260418033 SEAL REAR 13990							
1972919	1	EA	IL	IN	MI	OH	WI
			73			73	73
260418041 SEAL REAR 14381							
1972927	1	EA	IL	IN	MI	OH	WI
			73			73	73
260418058 SEAL REAR 16044							
1972935	1	EA	IL	IN	MI	OH	WI
			73			73	73
260418066 SEAL REAR 16599							
1972943	1	EA	IL	IN	MI	OH	WI
			73			73	73
260418082 SEAL REAR 19221							
1972968	1	EA	IL	IN	MI	OH	WI
			73			73	73

SEALED BEAM

SEE BEAM SEALED.

SHOCKS FRONT

300035433 SHOCKS FRONT 500- 44							
N		EA	1		1	1	
280028945 SHOCKS FRONT 506-200							
1922609	1	EA	IL	IN	MI	OH	WI
			73		73	73	73
403367626 SHOCKS FRONT 508- 32							
1135574	1	EA	IL	IN	MI	OH	WI
			73		73	73	73

DISTRIBUTION SERVICES

NETWORK SERVICES

TOOLS

BUILDING JANITORIAL

AUTOMOTIVE

FORMS/OFFICE SUPPLIES

GENERAL

DATA VOICE

SHOCKS FRONT

DISTRIBUTION SERVICES

PRODUCT IDENTIFIER		DESCRIPTION						
ITEM NUMBER	ORD. MULT.	SELL UNIT	STD. PKG. STOCK AVAILABILITY / PA	LEAD TIME			MIN. ORD.	A C

403367675 SHOCKS FRONT 508- 44								
1228205	1	EA	IL IN MI OH WI 73 73 73 73					

NETWORK SERVICES

260344635 SHOCKS FRONT 508- 59								
1950576	1	EA	IL IN MI OH WI 73 73 73 73					

300035409 SHOCKS FRONT 508- 72								
6505222	1	EA	IL IN MI OH WI 73 73 73 73					

402962575 SHOCKS FRONT 550- 66								
6504589	1	EA	IL IN MI OH WI 73 73 73 73					

TOOLS

402962609 SHOCKS FRONT 550- 88								
N		EA	1	1	1			

260436142 SHOCKS FRONT 560-419								
1979823	1	EA	IL IN MI OH WI 73 73 73 73					

260436126 SHOCKS FRONT 560-433								
1979856	1	EA	IL IN MI OH WI 73 73 73 73					

260384839 SHOCKS FRONT MOPAR 4397902								
1962639	1	EA	IL IN MI OH WI 73 73 73 73					

BUILDING JANITORIAL

AUTOMOTIVE

SHOCKS FRONT GAS

260344627 SHOCKS FRONT GAS 550- 25								
1950543	1	EA						

300077344 SHOCKS FRONT GAS 550- 88								
5124461	1	EA	IL IN MI OH WI 73 73 73 73					

SHOCKS REAR

280028960 SHOCKS REAR 506-308								
N		EA	1	1	1			

403367642 SHOCKS REAR 508- 41								
1159178	1	EA	IL IN MI OH WI 73 73 73 73					

403367659 SHOCKS REAR 508- 42								
1168450	1	EA	IL IN MI OH WI 73 73 73 73					

403367725 SHOCKS REAR 508- 69								
1142158	1	EA	IL IN MI OH WI 73 73 73 73					

260379599 SHOCKS REAR 550- 49								
1960450	1	EA	IL IN MI OH WI 73 73 73 73					

300035862 SHOCKS REAR 550- 59								
N		EA	1	1	1			

FORMS/OFFICE SUPPLIES

GENERAL

DATA VOICE

PRODUCT IDENTIFIER		DESCRIPTION						
ITEM NUMBER	ORD. MULT.	SELL UNIT	STD. PKG. STOCK AVAILABILITY / PA	LEAD TIME			MIN. ORD.	A C

260436134 SHOCKS REAR 560-439								
197983	1	EA	IL IN MI OH WI 73 73 73 73					

260436118 SHOCKS REAR 560-441								
1979849	1	EA	IL IN MI OH WI 73 73 73 73					

260384847 SHOCKS REAR MOPAR 4397904								
1962647	1	EA	IL IN MI OH WI 73 73 73 73					

SHOCKS REAR GAS

300077393 SHOCKS REAR GAS 550- 24								
5124370	1	EA						

300077401 SHOCKS REAR GAS 550- 37								
5124313	1	EA	IL IN MI OH WI 73 73 73 73					

300077419 SHOCKS REAR GAS 550- 38								
5124412	1	EA	IL IN MI OH WI 73 73 73 73					

300077336 SHOCKS REAR GAS 550- 58								
N		EA	1	1	1			

300077427 SHOCKS REAR GAS 550- 59								
1166751	1	EA	IL IN MI OH WI 73 73 73 73					

300077435 SHOCKS REAR GAS 550- 82								
1129478	1	EA	IL IN MI OH WI 73 73 73 73					

260344643 SHOCKS REAR GAS 550-109								
1950535	1	EA	IL IN MI OH WI 73 73 73 73					

260344650 SHOCKS REAR GAS 550-150								
1950568	1	EA	IL IN MI OH WI 73 73 73 73					

SHOE BRAKE

300038221 SHOE BRAKE 242 RR								
6506527	1	SE	Set of 4.					

300081387 SHOE BRAKE 314 PG								
5125518	1	SE	IL IN MI OH WI 73 73 73 73					

403212780 SHOE BRAKE 316 PG								
6506618	1	SE	IL IN MI OH WI 73 73 73 73					
Set of 4.								

300081411 SHOE BRAKE 361 PG								
5125542	1	SE	IL IN MI OH WI 73 73 73 73					

PRODUCT IDENTIFIER		DESCRIPTION						
ITEM NUMBER	ORD. MULT.	SELL UNIT	STD. PKG. STOCK AVAILABILITY / PA	LEAD TIME	MIN. ORD.	A	C	
403212830 SHOE BRAKE 445 PG								
1142737	1	SE	IL IN MI OH WI 73 73 73 73					
Set of 4.								
260344668 SHOE BRAKE 446 PG								
1950584	1	SE	IL IN MI OH WI 73 73 73 73					
Set of 4, rear.								
403212848 SHOE BRAKE 447 PG								
N		SE	1	1	1			
Set of 4.								
403212855 SHOE BRAKE 449 PG								
1195933	1	SE	IL IN MI OH WI 73 73 73 73					
Set of 4.								
260302666 SHOE BRAKE 451 PG								
1939405	1	SE	IL IN MI OH WI 73 73 73 73					
Rear.								
300081437 SHOE BRAKE 473 PG								
1226712	1	SE	IL IN MI OH WI 73 73 73 73					
260418462 SHOE BRAKE 481 PG								
1973362	1	SE	IL IN MI OH WI 73 73 73 73					
300070463 SHOE BRAKE 501 RP								
5122572	1	SE	IL IN MI OH WI 73 73 73 73					
Rear.								
403358344 SHOE BRAKE 504 PG								
5514406	1	SE	IL IN MI OH WI 73 73 73 73					
300070471 SHOE BRAKE 514 RR								
5122598	1	SE	IL IN MI OH WI 73 73 73 73					
Rear.								
260417589 SHOE BRAKE 519 PG								
1971754	1	SE	IL IN MI OH WI 73 73 73 73					
260361332 SHOE BRAKE 519 RR PG								
1954024	1	SE	IL IN MI OH WI 73 73 73 73					
260418470 SHOE BRAKE 520 PG								
1973370	1	SE	IL IN MI OH WI 73 73 73 73					
260361324 SHOE BRAKE 538 PG								
1954016	1	SE	IL IN MI OH WI 73 73 73 73					
260390307 SHOE BRAKE 552 PG								
1964353	1	SE	IL IN MI OH WI 73 73 73 73					

PRODUCT IDENTIFIER		DESCRIPTION						
ITEM NUMBER	ORD. MULT.	SELL UNIT	STD. PKG. STOCK AVAILABILITY / PA	LEAD TIME	MIN. ORD.	A	C	
260361316 SHOE BRAKE 553 PG								
1954073	1	SE	IL IN MI OH WI 73 73 73 73					
260390315 SHOE BRAKE 564 PG								
1964361	1	SE	IL IN MI OH WI 73 73 73 73					
260417597 SHOE BRAKE 566 PG								
1971804	1	SE	IL IN MI OH WI 73 73 73 73					
260440904 SHOE BRAKE 582 PG REAR								
N		EA	1	2	1			
'87-91 Ford E100-150 Van, F100-150 Pickup.								
260393970 SHOE BRAKE 583								
1966606	1	SE	IL IN MI OH WI 73 73 73 73					
Application on '87-'90 Ford F350.								
260390323 SHOE BRAKE 593 PG								
1964379	1	SE	IL IN MI OH WI 73 73 73 73					
SOLENOID STARTER								
402962997 SOLENOID STARTER U 939								
6121988	1	EA						
SPARK PLUG								
SEE PLUG SPARK.								
SPOTLIGHT								
300083367 SPOTLIGHT HB2002								
6513960	1	EA						
Replacement bulb BB2000.								
STARTER								
402963136 STARTER 323- 47								
N		EA	1	4	1			
300035540 STARTER 323- 49								
6504639	1	EA	IL IN MI OH WI 73 73 73 73					
402963144 STARTER 323- 55								
1162594	1	EA	IL IN MI OH WI 73 73 73 73					
280028978 STARTER 323-144								
N		EA	1	4	1			
300034949 STARTER 323-213								
6502971	1	EA	IL IN MI OH WI 73 73 73 73					

DISTRIBUTION SERVICES
 NETWORK SERVICES
 TOOLS
 BUILDING JANITORIAL
 AUTOMOTIVE
 FORMS/OFFICE SUPPLIES
 GENERAL
 DATA VOICE

STARTER

DISTRIBUTION SERVICES

PRODUCT IDENTIFIER		DESCRIPTION						
ITEM NUMBER	ORD. MULT.	SELL UNIT	STD. PKG.	LEAD TIME	MIN. ORD.	A		
				STOCK AVAILABILITY / PA			C	
402963003 STARTER 323-215								
1217299	1	EA	IL 73	IN	MI 73	OH 73	WI 73	

NETWORK SERVICES

402963011 STARTER 323-216							
N		EA	1		1		1
402963094 STARTER 323-255							
6107748	1	EA	IL 73	IN	MI 73	OH 73	WI 73

TOOLS

300035623 STARTER 323-274							
N		EA	1		1		1
300070562 STARTER 323-281							
5122275	1	EA	IL 73	IN	MI 73	OH 73	WI 73
260378179 STARTER 323-284							
1960351	1	EA	IL 73	IN	MI 73	OH 73	WI 73

BUILDING JANITORIAL

300035581 STARTER 323-292							
6504696	1	EA	IL 73	IN	MI 73	OH 73	WI 73
300070570 STARTER 323-300							
5122291	1	EA	IL 73	IN	MI 73	OH 73	WI 73

AUTOMOTIVE

300006467 STARTER 323-300							
N		EA	1		1		1
Was 323-66.							
280028986 STARTER 323-323							
N		EA	1		1		1

FORMS/OFFICE SUPPLIES

260384813 STARTER 323-365							
1962613	1	EA	IL 73	IN	MI 73	OH 73	WI 73
260425491 STARTER 323-367							
1977066	1	EA	IL	IN	MI	OH	WI
For 1985-90 Ford Astro & GMC Mini Vans (automatic).							

GENERAL

403485972 STARTER 323-368							
1227462	1	EA	IL 73	IN	MI 73	OH 73	WI 73
260425509 STARTER 323-387							
1977074	1	EA	IL 73	IN	MI 73	OH 73	WI 73
For 1985-90 Ford E350 (automatic).							
260425517 STARTER 323-429							
1977082	1	EA	IL 73	IN	MI 73	OH 73	WI 73
For 1986-90 Chevy Cavaliers.							

DATA VOICE

300035672 STARTER 323-809							
6504852	1	EA	IL 73	IN	MI 73	OH 73	WI 73

PRODUCT IDENTIFIER		DESCRIPTION						
ITEM NUMBER	ORD. MULT.	SELL UNIT	STD. PKG.	LEAD TIME	MIN. ORD.	A		
				STOCK AVAILABILITY / PA			C	

STARTING FLUID

SEE FLUID STARTING.

TAIL PIPE

SEE PIPE TAIL

THERMOSTAT

402963185 THERMOSTAT 131- 2							
1179010	1	EA					
402963193 THERMOSTAT 131- 3							
1138172	1	EA	IL 73	IN	MI 73	OH 73	WI 73
402963201 THERMOSTAT 131- 6							
1151852	1	EA	IL 73	IN	MI 73	OH 73	WI 73
403546997 THERMOSTAT 131-21							
1227793	1	EA	IL 73	IN	MI 73	OH 73	WI 73
403547003 THERMOSTAT 131-23							
N		EA	1		1		1
For 89-90 Dodge truck V8 360 5.9L							
280028994 THERMOSTAT 132-53							
1922625	1	EA	IL 73	IN	MI 73	OH 73	WI 73

TIRE AUTO

260368014 TIRE AUTO LT195/75R15							
1955120	1	EA					
260368048 TIRE AUTO LT215/85R16D RAS							
1955153	1	EA	IL 74	IN	MI 74	OH 74	WI
Uniroyal Tiger Paw load range D.							
260016092 TIRE AUTO LT235/85R16E							
1162701	1	EA	IL 74	IN	MI	OH 74	WI
260368055 TIRE AUTO LT245/75R16E RAS							
1955179	1	EA	IL 74	IN	MI	OH	WI
260368030 TIRE AUTO LT750 X 16D RAS							
1955146	1	EA	IL 74	IN	MI	OH	WI
Tube type.							
260368022 TIRE AUTO P 165/80R13 RAS							
1955138	1	EA	IL 74	IN	MI	OH 74	WI
B.F. Goodrich Silvertown load range B.							
260016076 TIRE AUTO P 175/80R13 RAS							
1162727	1	EA	IL 74	IN	MI	OH 74	WI

PRODUCT IDENTIFIER		DESCRIPTION					
ITEM NUMBER	ORD. MULT.	SELL UNIT	STD. PKG. STOCK AVAILABILITY / PA	LEAD TIME	MIN. ORD.	A C	
260016068 TIRE AUTO P 185/80R13 RAS							
1162768	1	EA	IL IN MI OH WI 74				
260016050 TIRE AUTO P 195/75R14 RAS							
1162800	1	EA	IL IN MI OH WI 74				
260368063 TIRE AUTO P 205/75R14 RAS							
1955211	1	EA	IL IN MI OH WI 74				B.F. Goodrich Silvertown load range C.
260386636 TIRE AUTO P 205/75R15 RAS							
1963918	1	EA	IL IN MI OH WI 74				357-614.
260016035 TIRE AUTO P 215/75R15 RAS							
1162883	1	EA	IL IN MI OH WI 74				
260368071 TIRE AUTO P 215/75R15 RAS							
1955229	1	EA	IL IN MI OH WI 74				Uniroyal tiger Paw load range D.
260368089 TIRE AUTO P 225/75R15 RAS							
1955237	1	EA	IL IN MI OH WI 74				
260368006 TIRE AUTO P 235/75R15							
1955112	1	EA	IL IN MI OH WI 74				
260016118 TUBE AUTO TIRE LT7.50X16D							
N							
TRANSMISSION FLUID							
SEE FLUID AUTO-TRANSMISSION.							
TUBE TIRE							
260367990 TUBE TIRE 750 X R16LT							
1955104	1	EA					
UNIVERSAL JOINT							
SEE JOINT UNIVERSAL.							
VALVE PCV							
402963391 VALVE PCV CV 761C							
1175448	1	EA					
402963441 VALVE PCV CV 774C							
1134197	1	EA	IL IN MI OH WI 73				
402963458 VALVE PCV CV 781C							
1139410	1	EA	IL IN MI OH WI 73				

PRODUCT IDENTIFIER		DESCRIPTION					
ITEM NUMBER	ORD. MULT.	SELL UNIT	STD. PKG. STOCK AVAILABILITY / PA	LEAD TIME	MIN. ORD.	A C	
402963466 VALVE PCV CV 788C							
1161596	1	EA	IL IN MI OH WI 73				
402963474 VALVE PCV CV 789C							
1187203	1	EA	IL IN MI OH WI 73				
300035706 VALVE PCV CV 794C							
N		EA	10	4			10
402963532 VALVE PCV CV 801C							
1204412	1	EA	IL IN MI OH WI 73				
260377916 VALVE PCV CV 851C							
1960039	1	EA	IL IN MI OH WI 73				
402963557 VALVE PCV CV 854C							
6502120	1	EA	IL IN MI OH WI 73				
403229255 VALVE PCV CV 865C							
1188367	1	EA	IL IN MI OH WI 73				
260418397 VALVE PCV CV 885C							
N		EA	1	4			1
260418389 VALVE PCV CV 886C							
1973289	1	EA	IL IN MI OH WI 73				
260417639 VALVE PCV CV 887C							
N		EA	1	4			1
260389895 VALVE PCV CV 892C							
1965012	1	EA	IL IN MI OH WI 73				
260389903 VALVE PCV CV 895C							
1965020	1	EA	IL IN MI OH WI 73				
260389887 VALVE PCV CV 899C							
1964999	1	EA	IL IN MI OH WI 73				
260341326 VALVE PCV CV 900C							
1949685	1	EA	IL IN MI OH WI 73				
260418371 VALVE PCV CV 905C							
1973271	1	EA	IL IN MI OH WI 73				
260417647 VALVE PCV CV 909C							
1972166	1	EA	IL IN MI OH WI 73				
260417654 VALVE PCV CV 914C							
1972208	1	EA	IL IN MI OH WI 73				

DISTRIBUTION SERVICES
 NETWORK SERVICES
 TOOLS
 BUILDING JANITORIAL
 AUTOMOTIVE
 FORMS/OFFICE SUPPLIES
 GENERAL
 DATA VOICE

VALVE PCV

DISTRIBUTION SERVICES

PRODUCT IDENTIFIER		DESCRIPTION						
ITEM NUMBER	ORD. MULT.	SELL UNIT	STD. PKG. STOCK AVAILABILITY / PA	LEAD TIME	MIN. ORD.	A	C	
260419585 VALVE PCV CV 918C								
1974444	1	EA	IL IN 73	MI OH WI 73 73				

NETWORK SERVICES

PRODUCT IDENTIFIER		DESCRIPTION						
WASHER PUMP								
SEE PUMP WASHER.								
WATER PUMP								
SEE PUMP WATER.								

TOOLS

PRODUCT IDENTIFIER		DESCRIPTION						
WHEEL BEARING								
SEE BEARING WHEEL.								
WIPER BLADE								
SEE BLADE WIPER.								

BUILDING JANITORIAL

PRODUCT IDENTIFIER		DESCRIPTION						
WIRES IGNITION								
300035813 WIRES IGNITION 464B								
6505511	1	SE						

AUTOMOTIVE

PRODUCT IDENTIFIER		DESCRIPTION						
300037736 WIRES IGNITION 506D								
6506253	1	SE	IL IN 73	MI OH WI 73 73 73				

PRODUCT IDENTIFIER		DESCRIPTION						
300040227 WIRES IGNITION 518D								
6505370	1	SE	IL IN 73	MI OH WI 73 73 73				

PRODUCT IDENTIFIER		DESCRIPTION						
260418181 WIRES IGNITION 604X								
1973065	1	SE	IL IN 73	MI OH WI 73 73 73				

PRODUCT IDENTIFIER		DESCRIPTION						
402963680 WIRES IGNITION 606B								
1222331	1	SE	IL IN 73	MI OH WI 73 73 73				

PRODUCT IDENTIFIER		DESCRIPTION						
260419189 WIRES IGNITION 606H								
1974097	1	SE	IL IN 73	MI OH WI 73 73 73				

PRODUCT IDENTIFIER		DESCRIPTION						
300070620 WIRES IGNITION 606R								
5122218	1	SE	IL IN 73	MI OH WI 73 73 73				

PRODUCT IDENTIFIER		DESCRIPTION						
260341243 WIRES IGNITION 606V								
1949339	1	SE	IL IN 73	MI OH WI 73 73 73				

PRODUCT IDENTIFIER		DESCRIPTION						
402963565 WIRES IGNITION 608G								
1172536	1	SE	IL IN 73	MI OH WI 73 73 73				

PRODUCT IDENTIFIER		DESCRIPTION						
300035771 WIRES IGNITION 608H								
N		SE	1	4	1			

DATA VOICE

PRODUCT IDENTIFIER		DESCRIPTION						
260390927 WIRES IGNITION 616G								
1965277	1	SE	IL IN 73	MI OH WI 73 73 73				
'86-'90 Astrovan, 4.3L, 6 cylinder.								

PRODUCT IDENTIFIER		DESCRIPTION						
ITEM NUMBER	ORD. MULT.	SELL UNIT	STD. PKG. STOCK AVAILABILITY / PA	LEAD TIME	MIN. ORD.	A	C	

PRODUCT IDENTIFIER		DESCRIPTION						
260417662 WIRES IGNITION 616T								
1972067	1	SE	IL IN 73	MI OH WI 73 73 73				

PRODUCT IDENTIFIER		DESCRIPTION						
260418215 WIRES IGNITION 616V								
1973099	1	SE	IL IN 73	MI OH WI 73 73 73				

PRODUCT IDENTIFIER		DESCRIPTION						
300035722 WIRES IGNITION 618C								
N		SE	1	1	1			

PRODUCT IDENTIFIER		DESCRIPTION						
300035052 WIRES IGNITION 618H								
N		SE	1	1	1			

PRODUCT IDENTIFIER		DESCRIPTION						
260369350 WIRES IGNITION 618R								
1955849	1	SE	IL IN 73	MI OH WI 73 73 73				

PRODUCT IDENTIFIER		DESCRIPTION						
260377924 WIRES IGNITION 618V								
1960047	1	SE	IL IN 73	MI OH WI 73 73 73				

PRODUCT IDENTIFIER		DESCRIPTION						
260390083 WIRES IGNITION 626B								
1964635	1	SE	IL IN 73	MI OH WI 73 73 73				

PRODUCT IDENTIFIER		DESCRIPTION						
260390075 WIRES IGNITION 626C								
1964627	1	SE	IL IN 73	MI OH WI 73 73 73				

PRODUCT IDENTIFIER		DESCRIPTION						
260390117 WIRES IGNITION 628E								
1964668	1	SE	IL IN 73	MI OH WI 73 73 73				

PRODUCT IDENTIFIER		DESCRIPTION						
300070612 WIRES IGNITION 704C								
5122192	1	SE	IL IN 73	MI OH WI 73 73 73				

PRODUCT IDENTIFIER		DESCRIPTION						
260341342 WIRES IGNITION 704D								
1949701	1	SE	IL IN 73	MI OH WI 73 73 73				

PRODUCT IDENTIFIER		DESCRIPTION						
260418173 WIRES IGNITION 704F								
1973057	1	SE	IL IN 73	MI OH WI 73 73 73				

PRODUCT IDENTIFIER		DESCRIPTION						
260390091 WIRES IGNITION 704H								
1964643	1	SE	IL IN 73	MI OH WI 73 73 73				

PRODUCT IDENTIFIER		DESCRIPTION						
260377643 WIRES IGNITION 704J								
1959767	1	SE	IL IN 73	MI OH WI 73 73 73				

PRODUCT IDENTIFIER		DESCRIPTION						
260361415 WIRES IGNITION 704N								
1954149	1	SE	IL IN 73	MI OH WI 73 73 73				

PRODUCT IDENTIFIER		DESCRIPTION						
260418207 WIRES IGNITION 704Q								
1973081	1	SE	IL IN 73	MI OH WI 73 73 73				

PRODUCT IDENTIFIER		DESCRIPTION						
402963896 WIRES IGNITION 706C								
1147074	1	SE	IL IN 73	MI OH WI 73 73 73				

PRODUCT IDENTIFIER		DESCRIPTION						
ITEM NUMBER	ORD. MULT.	SELL UNIT	STD. PKG. STOCK AVAILABILITY / PA		LEAD TIME		MIN. ORD.	A C
260339239 WIRES IGNITION 706N								
1948703	1	SE	IL 73	IN	MI 73	OH 73	WI 73	
260418199 WIRES IGNITION 708Q								
1973073	1	SE	IL 73	IN	MI	OH 73	WI 73	
260390109 WIRES IGNITION 708R								
1964650	1	SE	IL 73	IN	MI	OH 73	WI 73	
402963920 WIRES IGNITION 708H								
N		SE	1		4			1
260417670 WIRES IGNITION 716B								
1971937	1	SE	IL 73	IN	MI	OH 73	WI 73	
260384821 WIRES IGNITION MOPAR 4439049								
1962621	1	SE	IL 73	IN	MI	OH 73	WI 73	

PRODUCT IDENTIFIER		DESCRIPTION						
ITEM NUMBER	ORD. MULT.	SELL UNIT	STD. PKG. STOCK AVAILABILITY / PA		LEAD TIME		MIN. ORD.	A C

DISTRIBUTION SERVICES
 NETWORK SERVICES
 TOOLS
 BUILDING JANITORIAL
AUTOMOTIVE
 FORMS/OFFICE SUPPLIES
 GENERAL
 DATA VOICE

NOTES

SECTION 6 - FORMS/OFFICE SUPPLIES
MATERIAL INCLUDED

- FORMS
- OFFICE SUPPLIES

We are concerned and value your ideas. Please contact the Ameritech Bell Group Catalog Department direct on (708) 248-8313 with questions, corrections and ideas.

Catalog Format

PRODUCT IDENTIFIER		DESCRIPTION				
ITEM NUMBER	ORD. MULT.	SELL UNIT	STD. PKG.	LEAD TIME	MIN. ORD.	A
260388194	1	EA				
			STOCK AVAILABILITY / PA		ORD.	C

Stock Material

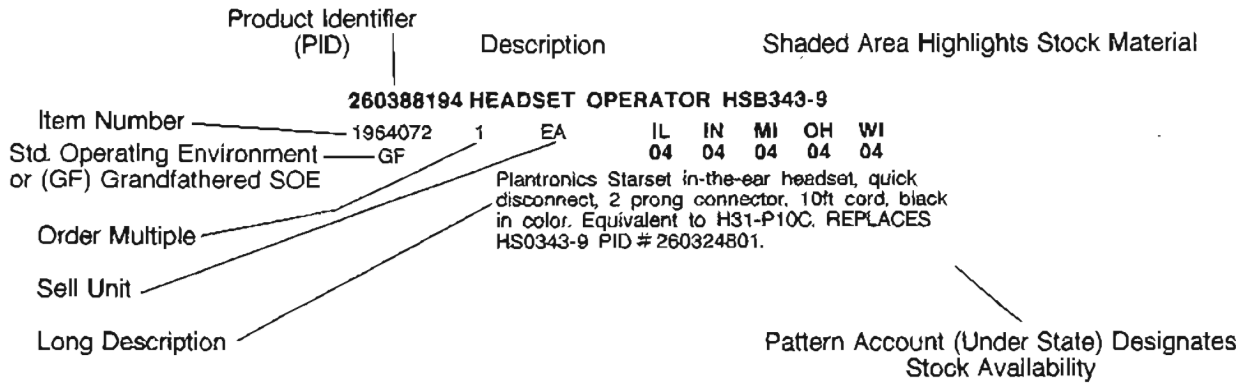

Non-Stock Material

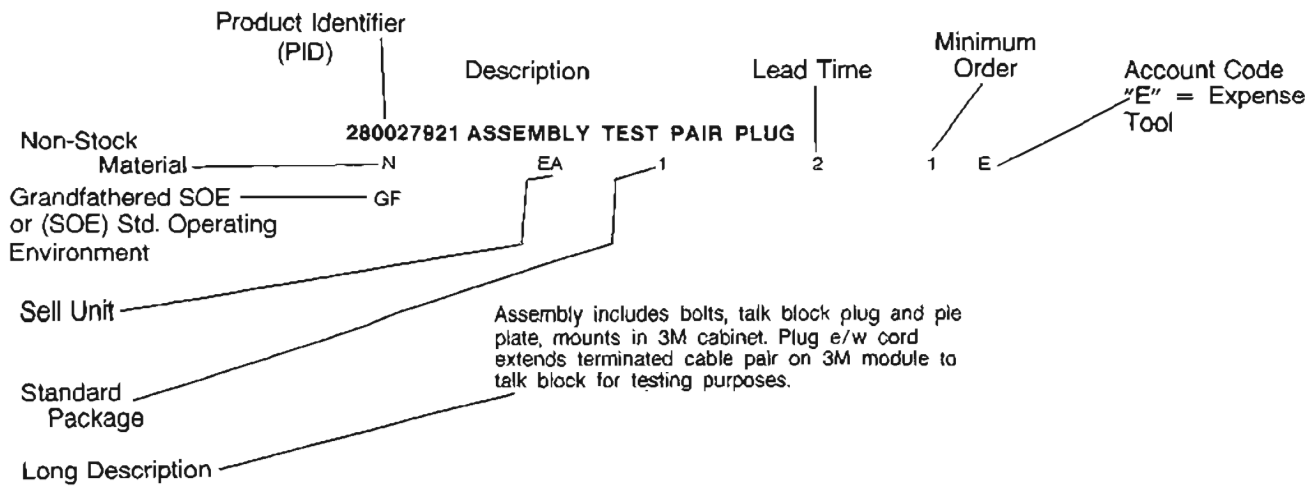

PRODUCT IDENTIFIER DESCRIPTION

ITEM	ORD.	SELL	STD. PKG.	LEAD TIME	MIN.	A
NUMBER	MULT.	UNIT	STOCK AVAILABILITY / PA		ORD.	C

ALL SECTION-6 USERS PLEASE NOTE:

ALL MATERIAL DESCRIPTIONS THAT END WITH AN ALPHABETIZED LETTER FOLLOWED BY A DASH (-) AND TWO NUMBERS (A-01) ARE WISCONSIN ORDER ITEMS ONLY.

ALL SECTION-6 USERS PLEASE NOTE:

ALL MATERIALS THAT HAVE ITEM NUMBERS BEGINING WITH 000 AND/OR ARE WITHOUT A PID OR PATTERN ACCOUNT NUMBER ARE INDIANA ORDER ITEMS ONLY.

BAG

260408802	BAG DATA BATCH 2-1015	A-01
N	EA 1 1 1	
	10 1/2 X 15 5/8IN. NOW AVAILABLE THROUGH TOUCH-TONE ORDER ENTRY.	

300060852	BAG DURA NO 4	
1334169	1 CS	IL IN MI OH WI
		33 33 33 33

300060860	BAG DURA NO 7	
1334151	1 CS	IL IN MI OH WI
		33 33 33 33

260409602	BAG JET PACK 6 12-1/2 X 19IN H-89	
N	EA 1 1 1	

260408901	BAG JET PACK 00 5 X 10IN H-82	
N	EA 1 1 1	

260409008	BAG JET PACK 00 6 X 10IN H-83	
N	EA 1 1 1	
	NOW AVAILABLE THROUGH TOUCH-TONE ORDER ENTRY.	

260409107	BAG JET PACK 1 7-1/4 X 12IN H-84	
N	EA 1 1 1	
	NOW AVAILABLE THROUGH TOUCH-TONE ORDER ENTRY.	

260409206	BAG JET PACK 2 8-1/2 X 12IN H-85	
N	EA 1 1 1	
	NOW AVAILABLE THROUGH TOUCH-TONE ORDER ENTRY.	

260409305	BAG JET PACK 3 8-1/2 X 14IN H-86	
N	EA 1 1 1	

260409404	BAG JET PACK 4 9-1/2 X 14IN H-87	
N	EA 1 1 1	
	NOW AVAILABLE THROUGH TOUCH-TONE ORDER ENTRY.	

260409503	BAG JET PACK 5 10-1/2 X 16IN H-88	
N	EA 1 1 1	
	NOW AVAILABLE THROUGH TOUCH-TONE ORDER ENTRY.	

PRODUCT IDENTIFIER DESCRIPTION

ITEM	ORD.	SELL	STD. PKG.	LEAD TIME	MIN.	A
NUMBER	MULT.	UNIT	STOCK AVAILABILITY / PA		ORD.	C

260409701	BAG JET PACK 7 14-1/2 X 20IN J-47	
N	EA 1 1 1	
	NOW AVAILABLE THROUGH TOUCH-TONE ORDER ENTRY.	

280010539	BAG WAXED C101W SANAP DISPOSAL	
N	CS 1 2 1	

BAG TONER

260382767	BAG TONER 3022E	
N	CT 1 1 1	

260324579	BAG TONER 6020/6022/6030/6130	
N	CT 1 1 1	

260382726	BAG TONER 6110	
N	CT 1 1 1	

260382858	BAG TONER 6113/6213	
N	CT 1 1 1	

260355649	BAG TONER 6242	
N	CT 1 1 1	

260382825	BAG TONER 6260	
N	CT 1 1 1	

260382841	BAG TONER 6272	
N	CT 1 1 1	

260430822	BAG TONER 6550	
N	CT 1 1 1	

BALLPOINT PEN

SEE PEN BALLPOINT.

BAND RUBBER

400544060	BAND RUBBER # 12 1/4LB BOX	
N	BX 1 2 1	
	1-3/4 X 1/16IN.	

280005232	BAND RUBBER # 14 1LB BOX	
0001427	1 BX	IL IN MI OH WI
	NOW AVAILABLE THROUGH TOUCH-TONE ORDER ENTRY.	

280009093	BAND RUBBER # 14 1/4LB BOX	
0001415	1 BX	IL IN MI OH WI
	NOW AVAILABLE THROUGH TOUCH-TONE ORDER ENTRY.	

260409800	BAND RUBBER # 14 1/4LB BOX J-53	
N	BX 1 1 1	
	2 X 1/16IN.	

DISTRIBUTION SERVICES

NETWORK SERVICES

TOOLS

BUILDING JANITORIAL

AUTOMOTIVE

FORMS/OFFICE SUPPLIES

GENERAL

DATA VOICE

BAND RUBBER

PRODUCT IDENTIFIER		DESCRIPTION					
ITEM NUMBER	ORD. MULT.	SELL UNIT	STD. PKG. STOCK AVAILABILITY / PA	LEAD TIME	MIN. ORD.	A C	

280005240 BAND RUBBER # 18 1LB BOX
 0001428 1 BX IL IN MI OH WI
 NOW AVAILABLE THROUGH TOUCH-TONE ORDER ENTRY.

280009101 BAND RUBBER # 18 1/4LB BOX
 0001416 1 BX IL IN MI OH WI
 NOW AVAILABLE THROUGH TOUCH-TONE ORDER ENTRY.

260409909 BAND RUBBER # 18 1/4LB BOX J-54
 N BX 1 1 1
 3 X 1/16IN. NOW AVAILABLE THROUGH TOUCH-TONE ORDER ENTRY.

400544151 BAND RUBBER # 30 1/4LB BOX
 N BX 1 2 40
 2 X 1/8IN.

260410006 BAND RUBBER # 30 1/4LB BOX J-55
 N BX 1 1 1
 2 X 1/8IN.

280005257 BAND RUBBER # 33 1LB BOX
 0001429 1 BX IL IN MI OH WI
 NOW AVAILABLE THROUGH TOUCH-TONE ORDER ENTRY.

280009119 BAND RUBBER # 33 1/4LB BOX
 0001417 1 BX IL IN MI OH WI
 NOW AVAILABLE THROUGH TOUCH-TONE ORDER ENTRY.

260410105 BAND RUBBER # 33 1/4LB BOX J-56
 N BX 1 1 1
 3-1/2 X 1/8IN. NOW AVAILABLE THROUGH TOUCH-TONE ORDER ENTRY.

280005265 BAND RUBBER # 64 1LB BOX
 0001430 1 BX IL IN MI OH WI
 NOW AVAILABLE THROUGH TOUCH-TONE ORDER ENTRY.

400544219 BAND RUBBER # 64 1/4LB BOX
 N BX 1 2 40
 3-1/2 X 1/4IN.

280009127 BAND RUBBER # 64 1/4LB BOX
 0001418 1 BX IL IN MI OH WI
 NOW AVAILABLE THROUGH TOUCH-TONE ORDER ENTRY.

260410204 BAND RUBBER # 64 1/4LB BOX J-57
 N BX 1 1 1
 3-1/2 X 1/4IN.

401328562 BAND RUBBER # 74 1/4LB BOX
 N BX 1 2 1
 3-1/2 X 3/8IN.

PRODUCT IDENTIFIER		DESCRIPTION					
ITEM NUMBER	ORD. MULT.	SELL UNIT	STD. PKG. STOCK AVAILABILITY / PA	LEAD TIME	MIN. ORD.	A C	

280012576 BAND RUBBER #117 1LB BOX
 0001433 1 BX IL IN MI OH WI
 NOW AVAILABLE THROUGH TOUCH-TONE ORDER ENTRY.

BATTERY

280009010 BATTERY 1.5 VOLTS ALKALINE AA
 0001202 1 PK
 Package of 2. NOW AVAILABLE THROUGH TOUCH-TONE ORDER ENTRY.

260334305 BATTERY 1.5 VOLTS ALKALINE D
 0001205 1 PK IL IN MI OH WI
 33
 PACKAGE OF 2. NOW AVAILABLE THROUGH TOUCH-TONE ORDER ENTRY.

280030263 BATTERY 1.5V SILVER OXIDE
 N EA 1 3 1
 357 for watches and calculators.

260419833 BATTERY 9V B-25
 N PK 1 1 1
 NOW AVAILABLE THROUGH TOUCH-TONE ORDER ENTRY.

260419825 BATTERY 9V B-31
 N PK 2 1 1
 NOW AVAILABLE THROUGH TOUCH-TONE ORDER ENTRY.

280004615 BATTERY ALKALINE 9V
 0001204 1 PK IL IN MI OH WI

260419866 BATTERY ALKALINE AA B-15
 N PK 2 1 1
 NOW AVAILABLE THROUGH TOUCH-TONE ORDER ENTRY.

260419858 BATTERY ALKALINE AA B-17
 N PK 1 1 1
 NOW AVAILABLE THROUGH TOUCH-TONE ORDER ENTRY.

260334560 BATTERY ALKALINE AAA
 0001206 1 PK IL IN MI OH WI
 Package of 2. NOW AVAILABLE THROUGH TOUCH-TONE ORDER ENTRY.

260419841 BATTERY ALKALINE AAA B-32
 N PK 2 1 1
 NOW AVAILABLE THROUGH TOUCH-TONE ORDER ENTRY.

280009028 BATTERY ALKALINE C
 0001203 1 PK IL IN MI OH WI
 Package of 2. NOW AVAILABLE THROUGH TOUCH-TONE ORDER ENTRY.

DISTRIBUTION SERVICES

NETWORK SERVICES

TOOLS

BUILDING JANITORIAL

AUTOMOTIVE

FORMS/OFFICE SUPPLIES

GENERAL

DATA VOICE

PRODUCT IDENTIFIER		DESCRIPTION					
ITEM NUMBER	ORD. MULT.	SELL UNIT	STD. PKG. STOCK AVAILABILITY / PA	LEAD TIME	MIN. ORD.	A C	
260419874		BATTERY ALKALINE C B-11					
N		PK	1	1	1		
NOW AVAILABLE THROUGH TOUCH-TONE ORDER ENTRY.							
260419882		BATTERY ALKALINE D B-09					
N		PK	2	1	1		
NOW AVAILABLE THROUGH TOUCH-TONE ORDER ENTRY.							

BINDER

260360342		BINDER 124-6263 ADHESIVE KODAK					
N		CT	2	2	1		
Wisconsin.							
260419684		BINDER 3 RING 1IN CAP BLACK					A-16
N		EA	1	1	1		
NOW AVAILABLE THROUGH TOUCH-TONE ORDER ENTRY.							
260410808		BINDER 3 RING 1IN CAP BLACK					A-20
N		EA	1	1	1		
Vinyl, w/pocket.							
260410709		BINDER 3 RING 1IN CAP BLACK					A-23
N		EA	1	1	1		
NOW AVAILABLE THROUGH TOUCH-TONE ORDER ENTRY.							
260419726		BINDER 3 RING 1IN CAP BLACK					A-23
N		EA	1	1	1		
NOW AVAILABLE THROUGH TOUCH-TONE ORDER ENTRY.							
260419718		BINDER 3 RING 1IN CAP DK GREEN					A-18
N		EA	1	1	1		
260419700		BINDER 3 RING 1IN CAP RED					A-14
N		EA	1	1	1		
NOW AVAILABLE THROUGH TOUCH-TONE ORDER ENTRY.							
260419692		BINDER 3 RING 1IN CAP TANGERINE					A-15
N		EA	1	1	1		
260419676		BINDER 3 RING 1IN CAP YELLOW					A-17
N		EA	1	1	1		
260419767		BINDER 3 RING 1/2IN CAP BLACK					A-10
N		EA	1	1	1		
NOW AVAILABLE THROUGH TOUCH-TONE ORDER ENTRY.							
260419734		BINDER 3 RING 1/2IN CAP DK BLUE					A-13
N		EA	1	1	1		
NOW AVAILABLE THROUGH TOUCH-TONE ORDER ENTRY.							
260419783		BINDER 3 RING 1/2IN CAP DK GREEN					A-08
N		EA	1	1	1		

PRODUCT IDENTIFIER		DESCRIPTION					
ITEM NUMBER	ORD. MULT.	SELL UNIT	STD. PKG. STOCK AVAILABILITY / PA	LEAD TIME	MIN. ORD.	A C	
260419759		BINDER 3 RING 1/2IN CAP RED					A-11
N		EA	1	1	1		
NOW AVAILABLE THROUGH TOUCH-TONE ORDER ENTRY.							
260419742		BINDER 3 RING 1/2IN CAP TANGERINE					A-12
N		EA	1	1	1		
260419775		BINDER 3 RING 1/2IN CAP YELLOW					A-09
N		EA	1	1	1		
260408018		BINDER 3 RING 2IN CAP BLACK					A-22
N		EA	1	1	1		
Vinyl, w/pocket.							
260410402		BINDER 3 RING 3IN CAP BLACK					D-74
N		EA	1	1	1		
NOW AVAILABLE THROUGH TOUCH-TONE ORDER ENTRY.							
260410501		BINDER 3 RING 3IN CAP BLACK					D-75
N		EA	1	1	1		
NOW AVAILABLE THROUGH TOUCH-TONE ORDER ENTRY.							
260410600		BINDER 3 RING 3IN CAP RED					D-76
N		EA	1	1	1		
NOW AVAILABLE THROUGH TOUCH-TONE ORDER ENTRY.							
260419981		BINDER 6 RING 1/2IN CAPACITY					A-24
N		EA	1	1	1		
260338405		BINDER BECKETT 10 X 11 1/2 BLUE					
N		EA	1	1	1		
280004375		BINDER CLEARVIEW 1 IN					
0001110	1	EA	IL IN MI OH WI				
NOW AVAILABLE THROUGH TOUCH-TONE ORDER ENTRY.							
280004383		BINDER CLEARVIEW 1 1/2IN WHITE					
0001109	1	EA	IL IN MI OH WI				
NOW AVAILABLE THROUGH TOUCH-TONE ORDER ENTRY.							
280004391		BINDER CLEARVIEW 2 IN					
0001111	1	EA	IL IN MI OH WI				
NOW AVAILABLE THROUGH TOUCH-TONE ORDER ENTRY.							
260419528		BINDER CLEARVIEW 2 IN WHITE					K-41
N		EA	1	1	1		
Clear-view slant D ring. NOW AVAILABLE THROUGH TOUCH-TONE ORDER ENTRY.							
280004409		BINDER CLEARVIEW 3 IN WHITE					
0001131	1	EA	IL IN MI OH WI				
NOW AVAILABLE THROUGH TOUCH-TONE ORDER ENTRY.							

DISTRIBUTION SERVICES
 NETWORK SERVICES
 TOOLS
 BUILDING JANITORIAL
 AUTOMOTIVE
 FORMS/OFFICE SUPPLIES
 GENERAL
 DATA VOICE

BINDER

DISTRIBUTION SERVICES

PRODUCT IDENTIFIER		DESCRIPTION				
ITEM NUMBER	ORD. MULT.	SELL UNIT	STD. PKG. STOCK AVAILABILITY / PA	LEAD TIME	MIN. ORD.	A C
260419536	N	EA	1	IN WHITE	K-42	
Clear-view slant D ring.						

NETWORK SERVICES

BINDER DATA 8 1/2 X 14 7/8 DARK BLUE						
0001225	1	EA				
260419973	N	EA	1	GRAY	D-64	
BINDER DATA NA-93-599						

TOOLS

260432232	0001133	1	EA	IL IN MI OH WI		
BINDER D-RING 3IN						
NOW AVAILABLE THROUGH TOUCH-TONE ORDER ENTRY.						

260355375	0001930	1	EA	IL IN MI OH WI		
BINDER HANG 11 X 8 1/2 1IN BLACK						

260355128	0001929	1	EA	IL IN MI OH WI		
BINDER HANG 11 X 8 1/2 1IN BLUE						
NOW AVAILABLE THROUGH TOUCH-TONE ORDER ENTRY.						

BUILDING JANITORIAL

260355110	0001931	1	EA	IL IN MI OH WI		
BINDER HANG 11 X 8 1/2 1IN GREEN						
NOW AVAILABLE THROUGH TOUCH-TONE DATA ENTRY.						

260355367	0001932	1	EA	IL IN MI OH WI		
BINDER HANG 11 X 8 1/2 1IN RED						
NOW AVAILABLE THROUGH TOUCH-TONE ENTRY.						

AUTOMOTIVE

280004417	0001112	1	EA	IL IN MI OH WI		
BINDER NOT CLEARVIEW 1 1/2IN BLUE						
NOW AVAILABLE THROUGH TOUCH-TONE ORDER ENTRY.						

FORMS/OFFICE SUPPLIES

260432224	0001132	1	EA	IL IN MI OH WI		
BINDER NOT CLEARVIEW 1 1/2IN WHITE						
NOW AVAILABLE THROUGH TOUCH-TONE ORDER ENTRY.						

280004425	0001113	1	EA	IL IN MI OH WI		
BINDER NOT CLEARVIEW 1IN BLUE						
NOW AVAILABLE THROUGH TOUCH-TONE ORDER ENTRY.						

GENERAL

280004441	0001115	1	EA	IL IN MI OH WI		
BINDER NOT CLEARVIEW 1IN WHITE						
NOW AVAILABLE THROUGH TOUCH-TONE ORDER ENTRY.						

DATA VOICE

280004433	0001114	1	EA	IL IN MI OH WI		
BINDER NOT CLEARVIEW 2 IN BLUE						
NOW AVAILABLE THROUGH TOUCH-TONE ORDER ENTRY.						

PRODUCT IDENTIFIER		DESCRIPTION				
ITEM NUMBER	ORD. MULT.	SELL UNIT	STD. PKG. STOCK AVAILABILITY / PA	LEAD TIME	MIN. ORD.	A C

280004458	0001116	1	EA	IL IN MI OH WI		
BINDER NOT CLEARVIEW 2 IN WHITE						
NOW AVAILABLE THROUGH TOUCH-TONE ORDER ENTRY.						

260408117	N	EA	1		1	1
BINDER POCKET THREE RING A-47						
4 per package, 11 X 8-1/2IN. NOW AVAILABLE THROUGH TOUCH-TONE ORDER ENTRY.						

400010609	5600189	1	EA	IL IN MI OH WI		
BINDER PRACTICE 101						
Black canvas 4 holes.						

260420021	N	EA	1		1	1
BINDER PRSBD LIGHT BLUE D-55						
NOW AVAILABLE THROUGH TOUCH-TONE ORDER ENTRY.						

280004342	0001106	1	EA	IL IN MI OH WI		
BINDER PRSBD 1/2IN DARK BLUE						
NOW AVAILABLE THROUGH TOUCH-TONE ORDER ENTRY.						

280004359	0001107	1	EA	IL IN MI OH WI		
BINDER PRSBD 1/2IN DARK GREEN						
NOW AVAILABLE THROUGH TOUCH-TONE ORDER ENTRY.						

280004334	0001105	1	EA	IL IN MI OH WI		
BINDER PRSBD 1/2IN LIGHT BLUE						
NOW AVAILABLE THROUGH TOUCH-TONE ORDER ENTRY.						

260419940	N	EA	1		1	1
BINDER PRSBD 8 1/2 X 11IN GRAY D-46						
NOW AVAILABLE THROUGH TOUCH TONE ORDER ENTRY.						

260419908	N	EA	1		1	1
BINDER PRSBD 10 5/8 X 11IN GRAY D-52						

260420005	N	EA	1		1	1
BINDER PRSBD 11 X 8 1/2IN GRAY D-61						
NOW AVAILABLE THROUGH TOUCH-TONE ORDER ENTRY.						

260419999	N	EA	1		1	1
BINDER PRSBD 11 X 8 1/2IN GRAY D-63						
NOW AVAILABLE THROUGH TOUCH-TONE ORDER ENTRY.						

260419924	N	EA	1		1	1
BINDER PRSBD 11 3/4 X 8 1/2IN D-49						
LIGHT BLUE. NOW AVAILABLE THROUGH TOUCH-TONE ORDER ENTRY.						

260419932	N	EA	1		1	1
BINDER PRSBD 11 3/4 X 8 1/2IN GRAY D-48						

PRODUCT IDENTIFIER		DESCRIPTION				
ITEM NUMBER	ORD. MULT.	SELL UNIT	STD. PKG. STOCK AVAILABILITY / PA	LEAD TIME	MIN. ORD.	A C
260419916		BINDER PRSBD	12 X 8 1/2IN	D-51		
N		EA	1	1	1	
LIGHT BLUE. NOW AVAILABLE THROUGH TOUCH-TONE ORDER ENTRY.						
260419957		BINDER PRSBD	14 7/8 X 11IN	D-45		
N		EA	1	1	1	
LIGHT BLUE. NOW AVAILABLE THROUGH TOUCH-TONE ORDER ENTRY.						
260419965		BINDER PRSBD	14 7/8 X 11IN	GRAY D-44		
N		EA	1	1	1	
280004292		BINDER PRSBD	11IN	DARK BLUE		
0001101	1	EA	IL IN MI OH WI			
NOW AVAILABLE THROUGH TOUCH TONE ORDER ENTRY.						
280004300		BINDER PRSBD	11IN	EXECUTIVE RED		
0001102	1	EA	IL IN MI OH WI			
NOW AVAILABLE THROUGH TOUCH-TONE ORDER ENTRY.						
280004318		BINDER PRSBD	11IN	LIGHT GREEN		
0001103	1	EA	IL IN MI OH WI			
NOW AVAILABLE THROUGH TOUCH-TONE ORDER ENTRY.						
280004326		BINDER PRSBD	11IN	YELLOW		
0001104	1	EA	IL IN MI OH WI			
NOW AVAILABLE THROUGH TOUCH-TONE ORDER ENTRY.						
260420013		BINDER PRSBD BURST	LIGHT BLUE	D-58		
N		EA	1	1	1	
NOW AVAILABLE THROUGH TOUCH-TONE ORDER ENTRY.						
401706007		BINDER RING D	4182- 4			
8402917	1	EA	IL IN MI OH WI			
			33 33 33 33			
401706106		BINDER RING D	4182-18			
1169755	1	EA	IL IN MI OH WI			
			33 33 33			
260318134		BINDER RING W/POCKET	BLACK 1 IN	CAP		
N		EA	24	2	120	
Clear overlay on front and spine.						
260318142		BINDER RING W/POCKET	BLACK 2 IN	CAP		
1941187	1	EA	IL IN MI OH WI			
			33 33 33 33			
260323837		BINDER RING W/POCKET	BLACK 3 IN	CAP		
1944256	1	EA	IL IN MI OH WI			
			33 33 33			
300027125		BINDER RING W/POCKET	BLUE 1 1/2IN	CAP		
N		EA	1	4	720	
300027109		BINDER RING W/POCKET	BLUE 1 IN	CAP		
8402941	1	EA	IL IN MI OH WI			
			33 33 33 33			

PRODUCT IDENTIFIER		DESCRIPTION				
ITEM NUMBER	ORD. MULT.	SELL UNIT	STD. PKG. STOCK AVAILABILITY / PA	LEAD TIME	MIN. ORD.	A C
300027505		BINDER RING W/POCKET	BLUE 2 IN	CAP		
8402925	1	EA	IL IN MI OH WI			
			33 33 33 33			
402145999		BINDER RING W/POCKET	WHITE 1 IN	CAP		
8402933	1	EA	IL IN MI OH WI			
			33 33 33 33			
402146005		BINDER RING W/POCKET	WHITE 1-1/2IN	CAP		
8402958	1	EA	IL IN MI OH WI			
			33 33 33 33			
402146013		BINDER RING W/POCKET	WHITE 2 IN	CAP		
1225011	1	EA	IL IN MI OH WI			
			33 33 33 33			
260432240		BINDER ROUND RING	1/2IN			
0001135	1	EA	IL IN MI OH WI			
NOW AVAILABLE THROUGH TOUCH-TONE ORDER ENTRY.						
260420039		BINDER SLANT D RING	4IN BLACK	J-31		
N		EA	1	1	1	
260420047		BINDER SLANT D RING	4IN WHITE	J-31		
N		EA	1	1	1	
NOW AVAILABLE THROUGH TOUCH-TONE ORDER ENTRY.						
260420088		BINDER SPRING CLAMP	BLACK A-04			
N		EA	1	1	1	
260420104		BINDER SPRING CLAMP	DARK BLUE A-02			
N		EA	1	1	1	
NOW AVAILABLE THROUGH TOUCH TONE ORDER ENTRY.						
260420096		BINDER SPRING CLAMP	DARK GREEN A-03			
N		EA	1	1	1	
260420070		BINDER SPRING CLAMP	RED A-05			
N		EA	1	1	1	
260420054		BINDER SPRING CLAMP	TANGERINE A-07			
N		EA	1	1	1	
260420062		BINDER SPRING CLAMP	YELLOW A-06			
N		EA	1	1	1	
260432224		BINDER VIEW D-RING	1 1/2IN WHITE			
0001132		EA	IL IN MI OH WI			
NOW AVAILABLE THROUGH TOUCH-TONE ORDER ENTRY.						
260389572		BINDER WORKSHOP	90			
1965137	1	BX	IL IN MI OH WI			
			33 33 33 33			

DISTRIBUTION SERVICES
 NETWORK SERVICES
 TOOLS
 BUILDING JANITORIAL
 AUTOMOTIVE
 FORMS/OFFICE SUPPLIES
 GENERAL
 DATA VOICE

DISTRIBUTION SERVICES
 NETWORK SERVICES
 TOOLS
 BUILDING JANITORIAL
 AUTOMOTIVE
 FORMS/OFFICE SUPPLIES
 GENERAL
 DATA VOICE

BLADE

PRODUCT IDENTIFIER		DESCRIPTION				
ITEM NUMBER	ORD. MULT.	SELL UNIT	STD. PKG. STOCK AVAILABILITY / PA	LEAD TIME	MIN. ORD.	A C

BLADE

260408380		BLADE REPLACEMENT	A-25			
N		PK	1	1	1	

Package of 5. For Lewis safety knife. NOW AVAILABLE THROUGH TOUCH-TONE ORDER ENTRY.

BLOTTER

997502869		BLOTTER DESK	19IN X 24IN			
1112664	1	EA				

BOARD CUTTING

260415682		BOARD CUTTING	15IN SQUARE WOOD	I-93		
N		EA	1	1	1	
260415781		BOARD CUTTING	18IN SQUARE WOOD	I-94		
N		EA	1	1	1	

BOOK

260323753		BOOK	103 PRACTICE SD7400-01	NTI		
1944199	1	EA				

Documentation for 1944165 shelf terminal span J7400AA-1 L1.

260302799		BOOK CABLE MAINTENANCE	ILLINOIS			
1939652	1	EA	IL IN MI OH WI	33		

260302807		BOOK CABLE MAINTENANCE	OHIO			
1939579	1	EA	IL IN MI OH WI	08		

260302815		BOOK CABLE MAINTENANCE	WISCONSIN			
1939694	1	EA	IL IN MI OH WI	33		

260302831		BOOK CABLE PLACING	ILLINOIS			
1939678	1	EA	IL IN MI OH WI	33		

260302849		BOOK CABLE PLACING	OHIO			
1939595	1	EA	IL IN MI OH WI	33		

260302856		BOOK CABLE PLACING	WISCONSIN			
1939710	1	EA	IL IN MI OH WI	33		

260302872		BOOK CABLE SPLICING	ILLINOIS			
1939660	1	EA	IL IN MI OH WI	33		

260302880		BOOK CABLE SPLICING	OHIO			
1939587	1	EA	IL IN MI OH WI	08		

PRODUCT IDENTIFIER		DESCRIPTION				
ITEM NUMBER	ORD. MULT.	SELL UNIT	STD. PKG. STOCK AVAILABILITY / PA	LEAD TIME	MIN. ORD.	A C

260302898		BOOK CABLE SPLICING	WISCONSIN			
1939702	1	EA	IL IN MI OH WI	33		

260302914		BOOK SAFETY TOOLS	GENERAL ILLINOIS			
1939645	1	EA	IL IN MI OH WI	33		

260302922		BOOK SAFETY TOOLS	GENERAL OHIO			
1939561	1	EA	IL IN MI OH WI	08		

260302930		BOOK SAFETY TOOLS	GENERAL WISCONSIN			
1939686	1	EA	IL IN MI OH WI	33		

260408513		BOOK WORD II HERITAGE	J-50			
N		EA	1	1	1	

Hardbound Edition. NOW AVAILABLE THROUGH TOUCH-TONE ORDER ENTRY.

BOOK MEMO

401332275		BOOK MEMO	393 2 3/4IN			
5120287	1	EA				

401319579		BOOK MEMO	6570 SIDE OPEN			
1114009	1	EA	IL IN MI OH WI	33 33 33 33		

Item 6570.

260408216		BOOK MEMO SPIRAL BOUND	A-28			
N		EA	1	1	1	

11 X 8-7/8IN. NOW AVAILABLE THROUGH TOUCH-TONE ORDER ENTRY.

400399937		BOOK MEMO TYPE 1 END OPEN				
1199430	1	EA	IL IN MI OH WI	33 33 33 33		

BOOK STENO

400399911		BOOK STENO 1 NOTE	BSS4210			
N		EA	1	4	6	

400399929		BOOK STENO 2 NOTE				
1139774	1	EA	IL IN MI OH WI	33 33 33		

401332291		BOOK STENO GREGG	2000			
6677146	12	EA	IL IN MI OH WI	33 33 33		

260408414		BOOK STENO GREGG	A-30			
N		EA	1	1	1	

NOW AVAILABLE THROUGH TOUCH-TONE ORDER ENTRY.

260408315		BOOK STENO PITMAN	A-29			
N		EA	1	1	1	

NOW AVAILABLE THROUGH TOUCH-TONE ORDER ENTRY.

PRODUCT IDENTIFIER		DESCRIPTION				
ITEM NUMBER	ORD. MULT.	SELL UNIT	STD. PKG. STOCK AVAILABILITY / PA	LEAD TIME	MIN. ORD.	A C

PRODUCT IDENTIFIER		DESCRIPTION				
ITEM NUMBER	ORD. MULT.	SELL UNIT	STD. PKG. STOCK AVAILABILITY / PA	LEAD TIME	MIN. ORD.	A C

DISTRIBUTION SERVICES
 NETWORK SERVICES
 TOOLS
 BUILDING JANITORIAL
 AUTOMOTIVE
 FORMS/OFFICE SUPPLIES
 GENERAL
 DATA VOICE

BOOKENDS

260408810 BOOKENDS JUMBO BLACK D-81
 N SE 1 1 1
 9IN high X 6 wide x 8-1/2IN deep, 2 per set.
 NOW AVAILABLE THROUGH TOUCH-TONE ORDER ENTRY.

260408919 BOOKENDS JUMBO LT GRAY D-82
 N SE 1 1 1
 9H X 6W X 8 1/2D, 2 per set.

280004961 BOOKENDS METAL GRAY
 0001275 1 SE IL IN MI OH WI
 NOW AVAILABLE THROUGH TOUCH-TONE ORDER ENTRY.

260408711 BOOKENDS SMALL BEIGE D-80
 N SE 1 1 1
 5 1/2in high x 4 3/4in wide x 4 7/8in deep, 2 per set.

260408612 BOOKENDS SMALL BLACK D-78
 N SE 1 1 1
 5 1/2 high X 4-3/4 wide X 4 7/8IN deep, 2 per set. NOW AVAILABLE THROUGH TOUCH-TONE ORDER ENTRY.

BOX

300027448 BOX 8 1/2IN X 7 1/4IN X 3 5/16IN
 8404285 1 EA
 Storage, 1000 IBM Cards, general office use.
 DISCONTINUE UPON STOCK DEPLETION.

300025129 BOX 12 1/2IN X 10IN X 4IN
 N EA 1 3 400
 Packing.

300025111 BOX 12 1/2IN X 10IN X 7IN
 8403170 1 EA IL IN MI OH WI
 33 33 33 33 33
 Packing.

280071721 BOX 15 3/4IN X 7 1/2IN X 1 1/2IN
 1935528 1 EA IL IN MI OH WI
 33 33
 Lid.

280071739 BOX 15 3/4IN X 7 1/2IN X 4 3/4IN
 1935536 1 EA IL IN MI OH WI
 33 33
 Bottom.

401332556 BOX 15 3/4IN X 7 1/2IN X 4 3/4IN
 1198515 1 EA IL IN MI OH WI
 33 33
 Bottom.

BOX STORAGE

300041753 BOX STORAGE 1687- 2
 8408617 1 EA
 15in x 12in x 10in For archive use. Order cover separately. SEE BOX COVER 1687-2A.

300041787 BOX STORAGE 1687- 2A COVER
 8408583 1 EA IL IN MI OH WI
 33 33 33 33 33
 For use with Archive Storage Box 1687-2.

300027158 BOX STORAGE 1687- 3 15 X 12 X 10IN
 8402693 1 EA IL IN MI OH WI
 33 33 33 33 33
 DISCONTINUE UPON STOCK DEPLETION.

300027166 BOX STORAGE 1687- 5 15 X 8 X 4IN
 1145573 1 EA IL IN MI OH WI
 33 33 33 33
 DISCONTINUE UPON STOCK DEPLETION.

300028081 BOX STORAGE 1687- 6
 N EA 1 3 100
 10 3/4in x 8in x 14 1/2in.

300041761 BOX STORAGE 1687- 7 15 X 8 X 5IN
 8408609 1 EA IL IN MI OH WI
 33 33 33 33 33

300041779 BOX STORAGE 1687- 7A COVER
 8408591 1 EA IL IN MI OH WI
 33 33 33 33 33

300027182 BOX STORAGE 1687- 8 15 X 9 X 4IN
 8402735 1 EA IL IN MI OH WI
 33 33 33 33
 DISCONTINUE UPON STOCK DEPLETION.

BRUSH

260409016 BRUSH TYPEWRITER BLACK 6IN K-20
 N EA 1 1 1
 NOW AVAILABLE THROUGH TOUCH-TONE ORDER-ENTRY.

BULB

SEE LAMP.

CALENDAR

260432265 CALENDAR 22IN X 17IN
 0001257 1 EA
 NOW AVAILABLE THROUGH TOUCH-TONE ORDER ENTRY.

401138979 CALENDAR CARD 3MOS/GLANCE
 1167759 1 EA IL IN MI OH WI
 33 33 33 33

CALENDAR

DISTRIBUTION SERVICES

PRODUCT IDENTIFIER		DESCRIPTION				
ITEM NUMBER	ORD. MULT.	SELL UNIT	STD. PKG. STOCK AVAILABILITY / PA	LEAD TIME	MIN. ORD.	A C
260409115		CALENDAR MONTHLY DESK BROWN J-58				
N		EA	1	1	1	
NOW AVAILABLE THROUGH TOUCH-TONE ORDER ENTRY.						

NETWORK SERVICES

260432257		CALENDAR MONTHLY PLANNER 8 1/2 X 11IN				
0001256	1	EA	IL IN MI OH WI			
Wirebound. NOW AVAILABLE THROUGH TOUCH-TONE ORDER ENTRY.						

TOOLS

CARD						
300096732		CARD BUSINESS GENERAL 2				
N		EA	250	2	250	
260417746		CARD TENT-STYLE 9 X 4IN WHITE				
N		EA	1	8	2650	
1/2 inch pinfeed, 2650/CTN.						

BUILDING JANITORIAL

CARD DESIGNATION						
841852205		CARD DESIGNATION 841852205				
N		EA	1	2	1	
600159198		CARD DESIGNATION Y H909 693 G1				
N		EA	1	2	1	
600098586		CARD DESIGNATION Y H909 693 G2				
N		EA	1	2	1	

AUTOMOTIVE

CARD FILE						
260409214		CARD FILE FIBERBOARD 4IN X 6IN H-04				
N		EA	1	1	1	
260409313		CARD FILE FIBERBOARD 5IN X 8IN H-05				
N		EA	1	1	1	
300085289		CARD FILE TELTONE M161-73				
N		EA	1	12	1	

FORMS/OFFICE SUPPLIES

CARD INDEX						
280005877		CARD INDEX PLAIN 3 X 5IN				
0001609	1	PK				
Package of 100. NOW AVAILABLE THROUGH TOUCH-TONE ORDER ENTRY.						
260408976		CARD INDEX PLAIN 3IN X 5IN BLUE H-26				
N		PK	1	1	1	
Package of 100.						
260409172		CARD INDEX PLAIN 3IN X 5IN CANARY H-28				
N		PK	1	1	1	
Package of 100.						

GENERAL

CARD INDEX						
280005893		CARD INDEX RULED 4 X 6IN				
0001611	1	PK	IL IN MI OH WI			
Package of 100. NOW AVAILABLE THROUGH TOUCH-TONE ORDER ENTRY.						
400415162		CARD INDEX RULED 4IN X 6IN WHITE				
N		EA	1			
4208-9, grade 2.						

DATA VOICE

PRODUCT IDENTIFIER		DESCRIPTION				
ITEM NUMBER	ORD. MULT.	SELL UNIT	STD. PKG. STOCK AVAILABILITY / PA	LEAD TIME	MIN. ORD.	A C
260409073		CARD INDEX PLAIN 3IN X 5IN CHERRY H-27				
N		PK	1	1	1	
Package of 100.						
260409271		CARD INDEX PLAIN 3IN X 5IN GREEN H-29				
N		PK	1	1	1	
Package of 100.						
260409370		CARD INDEX PLAIN 3IN X 5IN SALMON H-30				
N		PK	1	1	1	
Package of 100.						
260408679		CARD INDEX PLAIN 3IN X 5IN WHITE H-20				
N		PK	1	1	1	
Package of 100. NOW AVAILABLE THROUGH TOUCH-TONE ORDER ENTRY.						
260408778		CARD INDEX PLAIN 4IN X 6IN WHITE H-21				
N		PK	1	1	1	
Package of 100. NOW AVAILABLE THROUGH TOUCH-TONE ORDER ENTRY.						
260408877		CARD INDEX PLAIN 5IN X 8IN WHITE H-22				
N		PK	1	1	1	
Package of 100. NOW AVAILABLE THROUGH TOUCH-TONE ORDER ENTRY.						
280005885		CARD INDEX RULED 3 X 5IN				
0001610	1	PK	IL IN MI OH WI			
Package of 100. NOW AVAILABLE THROUGH TOUCH-TONE ORDER ENTRY.						
260409776		CARD INDEX RULED 3IN X 5IN BLUE H-41				
N		PK	1	1	1	
Package of 100.						
260409974		CARD INDEX RULED 3IN X 5IN CANARY H-43				
N		PK	1	1	1	
Package of 100.						
260409875		CARD INDEX RULED 3IN X 5IN CHERRY H-42				
N		PK	1	1	1	
Package of 100.						
260410170		CARD INDEX RULED 3IN X 5IN GREEN H-44				
N		PK	1	1	1	
Package of 100.						
260410279		CARD INDEX RULED 3IN X 5IN SALMON H-45				
N		PK	1	1	1	
Package of 100.						
260409479		CARD INDEX RULED 3IN X 5IN WHITE H-23				
N		PK	1	1	1	
Package of 100. NOW AVAILABLE THROUGH TOUCH-TONE ORDER ENTRY.						

CASTER

DISTRIBUTION SERVICES

NETWORK SERVICES

TOOLS

BUILDING JANITORIAL

AUTOMOTIVE

FORMS/OFFICE SUPPLIES

GENERAL

DATA VOICE

PRODUCT IDENTIFIER							DESCRIPTION						
ITEM NUMBER	ORD. MULT.	SELL UNIT	STD. PKG.	LEAD TIME	MIN. ORD.	A C							
							STOCK AVAILABILITY / PA						
260409578 CARD INDEX RULED 4IN X 6IN WHITE H-24													
N		PK	1	1	1		Package of 100. NOW AVAILABLE THROUGH TOUCH TONE ORDER ENTRY.						
280005901 CARD INDEX RULED 5 X 8IN													
0001612	1	PK	IL	IN	MI	OH	WI	33					
Package of 100. NOW AVAILABLE THROUGH TOUCH-TONE ORDER ENTRY.													
400415170 CARD INDEX RULED 5IN X 8IN WHITE													
1125682	1	PK	IL	IN	MI	OH	WI	33 33					
100 per package, 2116.													
260409677 CARD INDEX RULED 5IN X 8IN WHITE H-25													
N		PK	1	1	1		Package of 100. NOW AVAILABLE THROUGH TOUCH-TONE ORDER ENTRY.						
CARD MEMORY													
260338033 CARD MEMORY LABEL ESS-1													
N		EA	1	2	50								
280019969 CARD MEMORY TAGS RC-9 ESS1													
N		EA	50	2	50								
CARD ROLODEX													
260414453 CARD ROLODEX PROTECTORS 2 1/4 X 4IN K-06													
N		EA	1	1	1		For refills, clear.						
260414552 CARD ROLODEX PROTECTORS 3 X 5IN K-07													
N		EA	1	1	1		For refills, clear.						
260414255 CARD ROLODEX REFILL 2 1/4 X 4IN I-63													
N		BX	1	1	1		White, blank, 1000 per box. NOW AVAILABLE THROUGH TOUCH TONE ORDER ENTRY.						
260414354 CARD ROLODEX REFILL 3 X 5IN I-64													
N		BX	1	1	1		White, blank, 1000 per box. NOW AVAILABLE THROUGH TOUCH TONE ORDER ENTRY.						
CARTON													
260360870 CARTON RECORD RETENTION 15IN													
N		EA	1	2	1								
001121391 CARTON RECORD STORAGE													
5664441	1	EA	IL	IN	MI	OH	WI	33 33					
15in X 12in X 10in.													

PRODUCT IDENTIFIER							DESCRIPTION						
ITEM NUMBER	ORD. MULT.	SELL UNIT	STD. PKG.	LEAD TIME	MIN. ORD.	A C							
							STOCK AVAILABILITY / PA						
CASE													
401966791 CASE DOCUMENT C40P													
N		EA	24	2	24								
401983754 CASE TOTE BLUE FLEX VINYL LN-93													
N		EA	12	2	12		15in x 11 1/2in x 2in.						
CASE ATTACHE													
260408109 CASE ATTACHE 3IN BLACK D-91													
N		EA	1	1	1		NOW AVAILABLE THROUGH TOUCH-TONE ORDER ENTRY.						
260408000 CASE ATTACHE 3IN GRAY D-90													
N		EA	1	1	1								
260408307 CASE ATTACHE 5IN BLACK D-93													
N		EA	1	1	1								
260408208 CASE ATTACHE 5IN GRAY D-92													
N		EA	1	1	1								
403111180 CASE ATTACHE TYPE 1A LEATHER C20													
N		EA	1	2	1								
403452337 CASE ATTACHE VINYL C40AV													
N		EA	1	2	1								
403101314 CASE ATTACHE WOMENS LEATHER C20W													
N		EA	1	2	1		Dual attache.						
CASTER													
260318050 CASTER 9009XTS 1/2 X 1 1/2 RP													
N		EA	1	2	1		Load capacity 180lb, atlasite wheel 2in diameter and 13/16in wide, 2 5/8in with threaded stem 1/2in - 13 X 1 1/2in.						
260319223 CASTER 9706G OC BASSICK													
N		SE	1	2	1		Top plate type for wood furniture.						
280099235 CASTER 10696X2													
N		SE	1	2	1		Swivel caster 2 1/2IN diameter soft rubber wheel 7/16IN grip ring stem. Set of 4.						
260300140 CASTER SWIVEL 9696X2													
N		SE	1	2	1		Set of 4 rubber wheels.						

DISTRIBUTION SERVICES
 NETWORK SERVICES
 TOOLS
 BUILDING JANITORIAL
 AUTOMOTIVE
 FORMS/OFFICE SUPPLIES
 GENERAL
 DATA VOICE

CEMENT

PRODUCT IDENTIFIER		DESCRIPTION				
ITEM NUMBER	ORD. MULT.	SELL UNIT	STD. PKG. STOCK AVAILABILITY / PA	LEAD TIME	MIN. ORD.	A C

CEMENT

400485884 CEMENT RUBBER 4 OZ BOTTLE

1101345 1 EA
6 dozen per case.

280009002 CEMENT RUBBER W/BRUSH 4 OZ

0001005 1 EA IL IN MI OH WI

NOW AVAILABLE THROUGH TOUCH-TONE ORDER ENTRY.

CHAIRMAT

280062712 CHAIRMAT CLEATMAT RUBBERMAID

N EA 1 2 1
Single lip with grips RM2360, size 45in X 53in, to be used under chairs on carpet. Lip size 25in X 12in, 23lbs wt, for medium to high pile carpets.

260301809 CHAIRMAT W/CLEATS 2373 48IN X 60IN

N EA 1 2 1
Rubbermaid without edge grip.

CHALK

401352877 CHALK DUSTLESS J4/1400

N BX 1 3 10

401352869 CHALK MARKING BLUE 1 OZ PACKAGE

N EA 1 2 1

260409610 CHALK WHITE A-36

N PK 1 1 1
12 per package.

CLAMP

260409719 CLAMP BULLDOG #3 2 5/8IN W A-37

N EA 1 1 1
NOW AVAILABLE THROUGH TOUCH-TONE ORDER ENTRY.

280030842 CLAMP CHART ORAVISUAL INST

N EA 1 2 1
CHNG S128.

400950184 CLAMP PAPER IDEAL 1

N BX 1 4 12
Box of 12.

280030859 CLAMP SPRING A508

N EA 1 2 1
Wisconsin.

PRODUCT IDENTIFIER		DESCRIPTION				
ITEM NUMBER	ORD. MULT.	SELL UNIT	STD. PKG. STOCK AVAILABILITY / PA	LEAD TIME	MIN. ORD.	A C

CLEANER

280004623 CLEANER DESK TOP

0001301 1 EA
INDIANA ONLY. NOW AVAILABLE THROUGH TOUCH TONE ORDER ENTRY.

260355151 CLEANER FINGER PINKIE

0001946 1 BX IL IN MI OH WI

BOX OF 40. NOW AVAILABLE THROUGH TOUCH-TONE ORDER ENTRY.

260409818 CLEANER FURNITURE A-41

N EA 1 1 1
15OZ Spray can. NOW AVAILABLE THROUGH TOUCH-TONE ORDER ENTRY.

260410014 CLEANER MARKERBOARD B-33

N EA 1 1 1
WE-920-090, plastic bottle, 16oz. NOW AVAILABLE THROUGH TOUCH-TONE ORDER ENTRY.

260357223 CLEANER MARKERBOARD 16OZ

0001945 1 EA IL IN MI OH WI
33

NOW AVAILABLE THROUGH TOUCH TONE ORDER ENTRY.

300024791 CLEANER SCREEN DATA VIEW CLEAR

8402511 1 EA IL IN MI OH WI
33 33 33 33 33

260410113 CLEANER TYPEWRITER 2 OZ A-38

N BT 1 1 1

260410212 CLEANER TYPEWRITER A-39

N EA 1 1 1
Star #1226.

CLIP

280005133 CLIP BINDER 3/8IN

0001404 1 DZ
NOW AVAILABLE THROUGH TOUCH TONE ORDER ENTRY.

280005141 CLIP BINDER 5/8IN

0001405 1 DZ IL IN MI OH WI

NOW AVAILABLE THROUGH TOUCH TONE ORDER ENTRY.

260415831 CLIP FOR MECHANICAL PENCIL 1-35

N EA 1 1 1
NOW AVAILABLE THROUGH TOUCH TONE ORDER ENTRY.

260410311 CLIP IDEAL A-43

N PK 1 1 1
3/4IN wide, 3/8IN capacity. NOW AVAILABLE THROUGH TOUCH-TONE ORDER ENTRY.

DISTRIBUTION SERVICES

NETWORK SERVICES

TOOLS

BUILDING JANITORIAL

AUTOMOTIVE

FORMS/OFFICE SUPPLIES

GENERAL

DATA VOICE

PRODUCT IDENTIFIER DESCRIPTION

ITEM NUMBER	ORD. MULT.	SELL UNIT	STD. PKG. STOCK AVAILABILITY / PA	LEAD TIME	MIN. ORD.	A C
-------------	------------	-----------	-----------------------------------	-----------	-----------	-----

260410410 CLIP IDEAL A-44
 N EA 1 1 1
 2IN wide, 1IN capacity. NOW AVAILABLE THROUGH TOUCH-TONE ORDER ENTRY.

260410519 CLIP IDEAL B-51
 N DZ 1 1 1
 1 1/4IN wide, 5/8IN capacity. NOW AVAILABLE THROUGH TOUCH-TONE ORDER ENTRY.

260410618 CLIP MAGNETIC 1 1/4IN D-95
 N EA 1 1 1
 NOW AVAILABLE THROUGH TOUCH-TONE ORDER ENTRY.

260410717 CLIP MAGNETIC 2 1/2IN D-96
 N EA 1 1 1
 NOW AVAILABLE THROUGH TOUCH-TONE ORDER ENTRY.

280005158 CLIP MAGNETIC STEEL 1-1/4IN
 0001406 1 PK IL IN MI OH WI
 Package of 18. NOW AVAILABLE THROUGH TOUCH TONE ORDER ENTRY.

300000023 CLIP WITH STRAP
 1148833 1 EA IL IN MI OH WI
 33 33

CLIP PAPER

280009051 CLIP PAPER 1 IN
 0001407 1 BX
 NOW AVAILABLE THROUGH TOUCH-TONE ORDER ENTRY.

260410915 CLIP PAPER 1 1/4IN K-18
 N BX 1 1 1
 Box of 100. NOW AVAILABLE THROUGH TOUCH-TONE ORDER ENTRY.

260410816 CLIP PAPER 2 IN A-42
 N BX 1 1 1
 Box of 100. NOW AVAILABLE THROUGH TOUCH-TONE ORDER ENTRY.

280009069 CLIP PAPER 3 IN
 0001408 1 BX IL IN MI OH WI
 NOW AVAILABLE THROUGH TOUCH-TONE ORDER ENTRY.

280009077 CLIP PAPER JUMBO
 0001409 1 BX IL IN MI OH WI
 NOW AVAILABLE THROUGH TOUCH-TONE ORDER ENTRY.

260408026 CLIP PAPER LARGE J-27
 N BX 1 1 1
 1-7/8 x 2-5/8IN. NOW AVAILABLE THROUGH TOUCH-TONE ORDER ENTRY.

PRODUCT IDENTIFIER DESCRIPTION

ITEM NUMBER	ORD. MULT.	SELL UNIT	STD. PKG. STOCK AVAILABILITY / PA	LEAD TIME	MIN. ORD.	A C
-------------	------------	-----------	-----------------------------------	-----------	-----------	-----

260408125 CLIP PAPER MEDIUM J-59
 N BX 1 1 1
 1-5/8 x 1-1/2IN, box of 50. NOW AVAILABLE THROUGH TOUCH-TONE ORDER ENTRY.

260408224 CLIP PAPER REGAL J-60
 N BX 1 1 1
 3/4IN, box of 100.

260408323 CLIP PAPER REGAL J-61
 N BX 1 1 1
 1IN, box of 100.

CLIPBOARD

280004649 CLIPBOARD 9 1/2IN X 12 1/2IN
 0001303 1 EA
 NOW AVAILABLE THROUGH TOUCH TONE ORDER ENTRY.

260408620 CLIPBOARD LETTER SIZE A-73
 N EA 1 1 1
 NOW AVAILABLE THROUGH TOUCH-TONE ORDER ENTRY.

CLIP-IT'S/CUSTOM

260014030 CLIP-IT'S/CUSTOM CALLING-MC
 1155887 1 EA

CLIP-IT'S/INTERCOM

260341409 CLIP-IT'S/INTERCOM - ILL
 1949891 1 EA

260014022 CLIP-IT'S/INTERCOM - MC
 1155861 1 EA IL IN MI OH WI
 65

CLOCK

260355185 CLOCK WALL QUARTZ 12IN BN
 0001967 1 EA
 NOW AVAILABLE THROUGH TOUCH TONE ORDER ENTRY.

DISTRIBUTION SERVICES
 NETWORK SERVICES
 TOOLS
 BUILDING JANITORIAL
 AUTOMOTIVE
 FORMS/OFFICE SUPPLIES
 GENERAL
 DATA VOICE

COVER

PRODUCT IDENTIFIER		DESCRIPTION					
ITEM NUMBER	ORD. MULT.	SELL UNIT	STD. PKG. STOCK AVAILABILITY / PA	LEAD TIME	MIN. ORD.	A C	
COMPUTER PAPER							
SEE PAPER COMPUTER.							
CORRECTION FLUID							
SEE FLUID CORRECTION.							
CORRECTION TAPE							
SEE TAPE CORRECTION.							
COVER							
260419817							
N		EA	1	1	1		
NOW AVAILABLE THROUGH TOUCH-TONE DATA ENTRY.							
260338397							
N		EA	1	1	1		
260419809							
N		EA	1	1	1		
COVER PRESSBOARD							
300024825							
1183392	1	SE					
400544243							
N		PR	1	3	50		
11 1/3in x 9in, for binding sheets 8 3/8in x 10 7/8in, requiring index tab allowance.							
400544250							
N		PR	1	3	50		
401359104							
N		PR	1		1		
With holes.							
401359120							
N		PR	1		1		
11 1/2in x 17 1/4in with holes.							
401359146							
4134684	1	PR	IL IN MI OH WI	33			
11 1/2in X 16 1/2in, with 1in turned in hinge on 11 1/2in side, and two 7/32in round holes.							
COVER REPORT							
260410626							
N		EA	1	1	1		
With grip-strip backbone. NOW AVAILABLE THROUGH TOUCH-TONE DATA ENTRY.							

PRODUCT IDENTIFIER		DESCRIPTION					
ITEM NUMBER	ORD. MULT.	SELL UNIT	STD. PKG. STOCK AVAILABILITY / PA	LEAD TIME	MIN. ORD.	A C	
280004532 COVER REPORT CLEAR							
0001124	1	BX	IL IN MI OH WI				
Box of 50. NOW AVAILABLE THROUGH TOUCH-TONE ORDER ENTRY.							
260410725 COVER REPORT CLEAR A-49							
N		EA	1	1	1		
With grip-strip backbone. NOW AVAILABLE THROUGH TOUCH-TONE ORDER ENTRY.							
280004540 COVER REPORT CLEAR/BROWN							
0001125	1	BX	IL IN MI OH WI				
Box of 25. NOW AVAILABLE THROUGH TOUCH-TONE ORDER ENTRY.							
280004557 COVER REPORT CLEAR/DARK BLUE							
0001126	1	BX	IL IN MI OH WI				
Box of 25. NOW AVAILABLE THROUGH TOUCH-TONE ORDER ENTRY.							
280004516 COVER REPORT PRSBD LT BLU LETTER							
0001122	1	EA	IL IN MI OH WI				
NOW AVAILABLE THROUGH TOUCH-TONE ORDER ENTRY.							
280004508 COVER REPORT PRSBD LT BLUE LEGAL							
0001121	1	EA	IL IN MI OH WI				
NOW AVAILABLE THROUGH TOUCH-TONE ORDER ENTRY.							
280004524 COVER REPORT PRSBD RED LETTER							
0001123	1	EA	IL IN MI OH WI				
NOW AVAILABLE THROUGH TOUCH-TONE ORDER ENTRY.							
280004599 COVER REPORT WINDOW DK BLUE							
0001130	1	BX	IL IN MI OH WI				
Box of 25. NOW AVAILABLE THROUGH TOUCH-TONE ORDER ENTRY.							
COVER TRANSPARENT							
009920059							
1147629	125	EA					
11IN X 14 3/8IN							
400462396							
1140129	125	EA	IL IN MI OH WI	33 33			
8 3/8IN X 10 7/8IN							
COVER TYPEWRITER							
260415880							
N		EA	1	1	1		
For 12in carriage or less.							

PRODUCT IDENTIFIER		DESCRIPTION				
ITEM NUMBER	ORD. MULT.	SELL UNIT	STD. PKG. STOCK AVAILABILITY / PA	LEAD TIME	MIN. ORD.	A C
CUFFETTES						
260409453	N	PR	1	1	1	E-58
CUFFETTES CUFF PROTECTORS .008						
Clear plastic.						
CUP						
260410824	N	EA	1	1	1	A-51
CUP SPONGE ROUND GLASS						
3IN diameter, 1-5/8IN high. Wisconsin Only. NOW AVAILABLE THROUGH TOUCH-TONE ORDER ENTRY.						
DATER						
260355664	N	EA	1	3	1	1 LINE PRINT
DATER SELF INKING						
Triumph 11.						
260355672	N	EA	1	3	1	2 LINE PRINT
DATER SELF INKING						
Triumph 11.						
260408034	N	EA	1	1	1	121 A-52
DATER SELF INKING						
Size 1in.						
260408133	N	EA	1	1	1	121 A-53
DATER SELF INKING						
1-1/2IN x 2IN. NOW AVAILABLE THROUGH TOUCH-TONE ORDER ENTRY.						
DETANGLER						
260441860	N	EA	24	2	24	1500-CLR
DETANGLER HANDSET CORD TWISSTOP						
1500-CLR						
DEVELOPER						
300024833	N	CT	1	2	1	5R111
DEVELOPER						
1 per carton.						
260422969	N	CT	1	2	1	5R161 FOR XEROX 5090
DEVELOPER						
260384524	N	CT	1	2	1	5R178
DEVELOPER						
Xerox 2520.						
260423009	N	CT	2	2	1	1683473
DEVELOPER CYAN						
For Kodak Coloredge Copier.						
260345657	N	EA	1	2	1	LZR1230
DEVELOPER DATA PRODUCTS						

PRODUCT IDENTIFIER		DESCRIPTION				
ITEM NUMBER	ORD. MULT.	SELL UNIT	STD. PKG. STOCK AVAILABILITY / PA	LEAD TIME	MIN. ORD.	A C
260344148	N	CT	1	1	1	IBM 3800 PRINTER
DEVELOPER						
260436803	N	BX	2	2	1	IBM 3835 6190653
DEVELOPER						
260360292	N	CT	2	2	1	K 100-1247
DEVELOPER						
Kodak.						
260360326	N	CT	2	2	1	L 121-4675
DEVELOPER						
Kodak.						
260423017	N	CT	1	2	1	MAGENTA 1799113
DEVELOPER						
For Kodak Coloredge Copier.						
260334503	N	CT	1	2	1	MANNESMAN-TALLY LP40
DEVELOPER						
066K.						
260354501	N	EA	1	3	1	PAGEPRINTER 3812/1348330
DEVELOPER						
260369384	N	BT	1	2	1	SIEMENS 2300 PRINTER
DEVELOPER						
260322557	N	CT	1	1	1	XD-25
DEVELOPER						
280031055	N	CT	1	1	2	XD-36 COPIER
DEVELOPER						
260322581	N	CT	1	2	1	XD-50
DEVELOPER						
260322607	N	CT	1	2	1	XD-75
DEVELOPER						
260411988	N	CT	1	2	1	XD-95
DEVELOPER						
Xerox.						
26C423025	N	CT	2	2	1	YELLOW 1794296
DEVELOPER						
For Kodak Coloredge Copier.						
DIAL SPEED						
401614771	N	EA	100	6	500	DIAL SPEED NUMBER REFERENCE LIST
DIAL SPEED NUMBER REFERENCE LIST						
Pocket size telephone number reference list.						
DICTIONARY						
260408232	N	EA	1	1	1	AMERICAN HERITAGE K-21
DICTIONARY						
College edition, thumb index.						

DISTRIBUTION SERVICES
 NETWORK SERVICES
 TOOLS
 BUILDING JANITORIAL
 AUTOMOTIVE
 FORMS/OFFICE SUPPLIES
 GENERAL
 DATA VOICE

DISTRIBUTION SERVICES

DICTIONARY

PRODUCT IDENTIFIER		DESCRIPTION							
ITEM	ORD.	SELL	STD. PKG.	LEAD TIME	MIN.	A			
NUMBER	MULT.	UNIT	STOCK AVAILABILITY / PA		ORD.	C			
260408331			DICTIONARY AMERICAN HERITAGE K-22						
N		EA	1	1	1				
College edition, paperback. NOW AVAILABLE THROUGH TOUCH-TONE ORDER ENTRY.									

NETWORK SERVICES

403391345			DICTIONARY AMERICAN HERITAGE H15063						
N		EA	1	2	1				
260408430			DICTIONARY THESAURUS ROGET'S J-49						
N		EA	1	1	1				
NOW AVAILABLE THROUGH TOUCH-TONE ORDER ENTRY.									

TOOLS

DISKETTE

280031105			DISKETTE 54238 BASF 5.25IN 2D						
N		BX	1	2	1				
Two Sided, Double Density. Wisconsin.									
280031113			DISKETTE 54244 BASF 5.25IN 2HD						
N		BX	1	2	1				
Two Sided, High Density. Wisconsin.									
260331756			DISKETTE 54249 BASF 3.5IN 2DD						
N		BX	1	2	1				
Two Sided, Double Density. Wisconsin.									
260331749			DISKETTE 54290 BASF 3.5IN 2HD						
N		BX	1	2	1				
Two Sided, High Density. Wisconsin.									

BUILDING JANITORIAL

300036506			DISKETTE 54304 BASF 5.25IN RX50						
8406470	1	BX	IL	IN	MI	OH	WI		
			33	33	33	33	33		

AUTOMOTIVE

260301718			DISKETTE 86026 5.25IN DS/HD						
N		BX	1	1	1				
Two Sided, High Density. Verbatim. Indiana.									

FORMS/OFFICE SUPPLIES

280331764			DISKETTE 3.5IN 2DD SONY						
N		BX	1	2	1				
Two Sided, Double Density. Wisconsin.									

260331772			DISKETTE 3.5IN 2HD SONY						
N		BX	1	2	1				
Two Sided, High Density. Wisconsin.									

260334552			DISKETTE 3.5IN DS/DD 1MG						
0001903	1	BX	IL	IN	MI	OH	WI		
Two Sided, Double Density. Indiana. NOW AVAILABLE THROUGH TOUCH TONE ORDER ENTRY.									

GENERAL

260334545			DISKETTE 3.5IN DS/HD 2MG						
0001904	1	BX	IL	IN	MI	OH	WI		
Two Sided, High Density. Indiana. NOW AVAILABLE THROUGH TOUCH TONE ORDER ENTRY.									

DATA VOICE

300074192			DISKETTE 5.25IN DS/DD 1244002						
4211250	1	BX	IL	IN	MI	OH	WI		
			33	33	33	33	33		
Two Sided, Double Density.									

PRODUCT IDENTIFIER DESCRIPTION

ITEM	ORD.	SELL	STD. PKG.	LEAD TIME	MIN.	A			
NUMBER	MULT.	UNIT	STOCK AVAILABILITY / PA		ORD.	C			
280051525			DISKETTE 5.25IN DS/DD BASF						
1927244	1	BX	IL	IN	MI	OH	WI		
			33	33	33	33	33		
Two Sided, Double Density.									

280051533 DISKETTE 5.25IN DS/QD BASF

1927251	1	BX	IL	IN	MI	OH	WI	
			33	33	33	33	33	
Two Sided, Quad Density.								

300074218 DISKETTE 5.25IN DS/QD ID 0870009

N		BX	10	3	30			
Two Sided, Quad Density.								

260341367 DISKETTE 8IN 1D SOFT SECTOR

N		BX	1	2	1			
One Sided.								

260446869 DISKETTE 3.5 DS/DD WITH AMERITECH LOGO

N	10/Box.							
---	---------	--	--	--	--	--	--	--

260446877 DISKETTE 3.5 DS/HD WITH AMERITECH LOGO

N	10/Box.							
---	---------	--	--	--	--	--	--	--

260446893 DISKETTE 5.25 DS/D WITH AMERITECH LOGO

N

260446851 DISKETTE 5.25 DS/DD WITH AMERITECH LOGO

N	10/Box.							
---	---------	--	--	--	--	--	--	--

260446885 DISKETTE 5.25 DS/HD WITH AMERITECH LOGO

N	10/Box.							
---	---------	--	--	--	--	--	--	--

260446919 DISKETTE 5.25 RX50 FORMAT BOX OF 10

N

260446893 DISKETTE 5.25IN DS/QD W/AMERITECH LOGO

N	10/BOX.							
---	---------	--	--	--	--	--	--	--

260408539 DISKETTE MAILER DE-18-275 B-34

N		EA	1	1	1			
For 5.25IN diskettes. NOW AVAILABLE THROUGH TOUCH-TONE ORDER ENTRY.								

260429485 HOLDER DISKETTE 3.5IN W/LOCK

N		EA	1	2	1			
Holds 50, Fellows A9-90312.								

DISPENSER TAPE

260408638 DISPENSER TAPE C-15 BLACK A-55

N		EA	1	1	1			
NOW AVAILABLE THROUGH TOUCH-TONE ORDER ENTRY.								

280004219 DISPENSER TAPE DESK BLACK

0001006	1	EA	IL	IN	MI	OH	WI	
---------	---	----	----	----	----	----	----	--

NOW AVAILABLE THROUGH TOUCH-TONE ORDER ENTRY.

PRODUCT IDENTIFIER		DESCRIPTION					
ITEM NUMBER	ORD. MULT.	SELL UNIT	STD. PKG. STOCK	LEAD TIME AVAILABILITY	MIN. ORD.	A C	
260408737		DISPENSER TAPE H127 3/4IN A-58					
N		EA	1	1	1		
NOW AVAILABLE THROUGH TOUCH-TONE ORDER ENTRY.							
401144654		DISPENSER TAPE HAND 1/2IN					
1150664	1	EA	IL 33	IN 33	MI 33	OH 33 WI 33	
280004227		DISPENSER TAPE HAND 1/2IN					
0001007	1	EA	IL	IN	MI	OH WI	
NOW AVAILABLE THROUGH TOUCH-TONE ORDER ENTRY.							
280004235		DISPENSER TAPE HAND 3/4IN					
0001008	1	EA	IL	IN	MI	OH WI	
NOW AVAILABLE THROUGH TOUCH-TONE ORDER ENTRY.							
402343354		DISPENSER TAPE SD-999					
5359380	1	EA	IL 33	IN 33	MI 33	OH 33 WI 33	
Shuford mills.							
260415286		DISPENSER TAPE CORE 1IN A-45					
N		EA	1	1	1		
Plastic core only. NOW AVAILABLE THROUGH TOUCH-TONE ORDER ENTRY.							

DOCUMENT

260397344		DOC AAPP ADMINISTRATIVE GUIDE				
1968057	1	EA				
260397252		DOC AAPP BUILDING OPERATION BOOK				
1967968	1	EA	IL 33	IN 33	MI 33	OH 33 WI 33
Key Point Reference Book.						
260397195		DOC AAPP BUILDING OPERATION CARD				
1967901	1	EA	IL 33	IN 33	MI 33	OH 33 WI 33
Annual Safety Card.						
260397138		DOC AAPP BUILDING OPERATION INST				
1967844	1	EA	IL 33	IN 33	MI 33	OH 33 WI 33
Instruction Process Document.						
260397336		DOC AAPP CONFORMANCE REVIEW				
1968040	1	EA	IL 33	IN 33	MI 33	OH 33 WI 33
260397310		DOC AAPP ENVIRONMENTAL INSPECTION				
1968024	1	EA	IL 33	IN 33	MI 33	OH 33 WI 33
260397260		DOC AAPP MATERIAL MANAGEMENT BOOK				
1967976	1	EA	IL 33	IN 33	MI 33	OH 33 WI 33
Key Point Reference Book.						

PRODUCT IDENTIFIER		DESCRIPTION					
ITEM NUMBER	ORD. MULT.	SELL UNIT	STD. PKG. STOCK	LEAD TIME AVAILABILITY	MIN. ORD.	A C	
260397203		DOC AAPP MATERIAL MANAGEMENT CARD					
1967919	1	EA	IL 33	IN 33	MI 33	OH 33 WI 33	
Annual Safety Card.							
260397146		DOC AAPP MATERIAL MANAGEMENT INST					
1967851	1	EA	IL 33	IN 33	MI 33	OH 33 WI 33	
Instruction Process Document.							
260397286		DOC AAPP MOTOR VEHICLE OPERATION BOOK					
1967992	1	EA	IL 33	IN 33	MI 33	OH 33 WI 33	
Key Point Reference Book.							
260397229		DOC AAPP MOTOR VEHICLE OPERATION CARD					
1967935	1	EA	IL 33	IN 33	MI 33	OH 33 WI 33	
Annual Safety Card.							
260397161		DOC AAPP MOTOR VEHICLE OPERATION INST					
1967877	1	EA	IL 33	IN 33	MI 33	OH 33 WI 33	
Instruction Process Document.							
260397294		DOC AAPP NETWORK OPERATION BOOK					
1968008	1	EA	IL 33	IN 33	MI 33	OH 33 WI 33	
Key Point Reference Book.							
260397237		DOC AAPP NETWORK OPERATION CARD					
1967943	1	EA	IL 33	IN 33	MI 33	OH 33 WI 33	
Annual Safety Card.							
260397179		DOC AAPP NETWORK OPERATION INST					
1967885	1	EA	IL 33	IN 33	MI 33	OH 33 WI 33	
Instruction Process Document.							
260397302		DOC AAPP OFFICE SAFETY BOOK					
1968016	1	EA	IL 33	IN 33	MI 33	OH 33 WI 33	
Key Point Reference Book.							
260397245		DOC AAPP OFFICE SAFETY CARD					
1967950	1	EA	IL 33	IN 33	MI 33	OH 33 WI 33	
Annual Safety Card.							
260397187		DOC AAPP OFFICE SAFETY INST					
1967893	1	EA	IL 33	IN 33	MI 33	OH 33 WI 33	
Instruction Process Document.							
260397278		DOC AAPP OUTSIDE SAFETY BOOK					
1967984	1	EA	IL 33	IN 33	MI 33	OH 33 WI 33	
Key Point Reference Book.							
260397211		DOC AAPP OUTSIDE SAFETY CARD					
1967927	1	EA	IL 33	IN 33	MI 33	OH 33 WI 33	
Annual Safety Card.							

DISTRIBUTION SERVICES

NETWORK SERVICES

TOOLS

BUILDING JANITORIAL

AUTOMOTIVE

FORMS/OFFICE SUPPLIES

GENERAL

DATA VOICE

DOCUMENT

DISTRIBUTION SERVICES

PRODUCT IDENTIFIER		DESCRIPTION						
ITEM NUMBER	ORD. MULT.	SELL UNIT	STD. PKG. STOCK AVAILABILITY / PA	LEAD TIME	MIN. ORD.	A	C	
260397153 DOC AAPP OUTSIDE SAFETY INST								
1967869	1	EA	IL IN MI OH WI 33 33 33 33 33					
Instruction Process Document.								

NETWORK SERVICES

260397351 DOC AAPP POCKET HOLDER/SECRETARY							
1968065		EA	IL IN MI OH WI 33 33 33 33 33				
260397328 DOC AAPP PROGRESS REPORT							
1968032	1	EA	IL IN MI OH WI 33 33 33 33 33				

TOOLS

DRUM ASSEMBLY							
260380340 DRUM ASSEMBLY NEG 1964002							
N		EA	1	2	1		

BUILDING JANITORIAL

DRY INK							
SEE INK DRY.							
EASEL PAPER							
SEE PAPER EASEL.							
EMBOSSING TOOL							
SEE TOOL EMBOSSING.							

AUTOMOTIVE

ENVELOPE							
401329776 ENVELOPE 4 1/8 X 9 1/2IN							
4144626	100	EA					
Kraft, Buff, 28LB #10 Envelope, banded by 100's.							

FORMS/OFFICE SUPPLIES

401329784 ENVELOPE 7 1/2 X 10 1/2IN							
4144642	100	EA	IL IN MI OH WI 33 33 33 33				
Kraft, plain, open end, gummed flap.							
401329792 ENVELOPE 9 X 12 IN							
4144667	50	EA	IL IN MI OH WI 33 33 33 33				
Manila, plain, open side, gummed flap, light weight.							

GENERAL

280005851 ENVELOPE CLASP 5 X 7 1/2IN							
0001607	1	BX	IL IN MI OH WI				
Box of 100. NOW AVAILABLE THROUGH TOUCH-TONE ORDER ENTRY.							
280005869 ENVELOPE CLASP 9 X 12 IN							
0001608	1	BX	IL IN MI OH WI				
Box of 100. NOW AVAILABLE THROUGH TOUCH-TONE ORDER ENTRY.							

DATA VOICE

280005844 ENVELOPE CLASP 12 X 15 1/2IN							
0001606	1	BX	IL IN MI OH WI				
Box of 100. NOW AVAILABLE THROUGH TOUCH-TONE ORDER ENTRY.							

PRODUCT IDENTIFIER		DESCRIPTION						
ITEM NUMBER	ORD. MULT.	SELL UNIT	STD. PKG. STOCK AVAILABILITY / PA	LEAD TIME	MIN. ORD.	A	C	

280004763 ENVELOPE CLEAR TOP LOADING							
0001316	1	EA	IL IN MI OH WI				
8 1/2 X 11IN. NOW AVAILABLE THROUGH TOUCH-TONE ORDER ENTRY.							

260408836 ENVELOPE CLEAR VINYL 5 X 8IN B-36							
N		EA	1	1	1		
Thumb cut, AN-1452. NOW AVAILABLE THROUGH TOUCH-TONE ORDER ENTRY.							

401329818 ENVELOPE PACKING 4 1/4 X 5 3/4IN							
4414003	1	EA	IL IN MI OH WI 08				
DISCONTINUE UPON STOCK DEPLETION							

300024775 ENVELOPE PACKING LIST YA066 15BWP							
8402479	1	EA	IL IN MI OH WI 33 33 33 33				

001002740 ENVELOPE PACKING SLIP 4IN X 8IN							
8186288	1	EA	IL IN MI OH WI 33 33 33				

ENVELOPE PACKING SLIP 5 1/2 X 4 1/2IN							
0001987	1	BX					

401329800 ENVELOPE PACKING SLIP CLEAR							
4321265	1	EA	IL IN MI OH WI 32 32 32 32				

300024767 ENVELOPE PLAIN MANILA 15 X 18 1/2IN							
N		EA	1		1		

260408935 ENVELOPE PLAIN WHITE 9 1/2 X 4 1/8 A-59							
N		BX	1	1	1		
500 per box, #10.							

401329917 ENVELOPE TRANSPARENT 7 1/4 X 5 1/4IN							
5603282	125	EA	IL IN MI OH WI 33 33 33 33				
Polyethylene, 008 thumb-cut, open end.							

401141288 ENVELOPE TRANSPARENT 8 3/4 X 11 1/4IN							
1155127	1	EA	IL IN MI OH WI 33 33 33 33				

280005836 ENVELOPE # 6 WHITE							
0001605	1	BX	IL IN MI OH WI				
3 5/8 X 6 1/2IN. Box of 500. NOW AVAILABLE THROUGH TOUCH TONE ORDER ENTRY.							

280005828 ENVELOPE #10 WHITE 4 1/8 X 9 1/2IN							
0001604	1	BX	IL IN MI OH WI				
Box of 500.							

ERASER

400415188 ERASER 1A 6002							
1196535	1	BX					
Eberhard Faber, package of 12.							

PRODUCT IDENTIFIER		DESCRIPTION					
ITEM	ORD.	SELL	STD. PKG.	LEAD TIME		MIN.	A
NUMBER	MULT.	UNIT	STOCK AVAILABILITY / PA		ORD.	C	
400415196 ERASER 1B 211 Artgum							
1155283	1	BX	IL	IN	MI	OH	WI
			33	33			
Package of 12.							
400415204 ERASER 4 112							
1155309	1	BX	IL	IN	MI	OH	WI
			33	33	33		
Eberhard Faber, package of 12.							
401330923 ERASER 1109							
1187591	1	EA	IL	IN	MI	OH	WI
			33	33			
260409032 ERASER ADJUSTABLE PENCIL TYPE F-80							
N		EA	1		1		1
Soft pink pearl.							
260409131 ERASER BLACKBOARD A-61							
N		EA	1		1		1
5IN X 2IN X 1IN. NOW AVAILABLE THROUGH TOUCH-TONE ORDER ENTRY.							
280006073 ERASER CAP PACKAGE OF 12							
0001701	1	PK	IL	IN	MI	OH	WI
NOW AVAILABLE THROUGH TOUCH-TONE ORDER ENTRY.							
260410535 ERASER COMBO MEDIUM FIRM EB-110 F-78							
N		EA	1		1		1
White/soft grey.							
260409230 ERASER DRAFTING MAGIC RUB F-81							
N		EA	1		1		1
NOW AVAILABLE THROUGH TOUCH-TONE ORDER ENTRY.							
280012394 ERASER DRY ERASE							
0001825	1	EA	IL	IN	MI	OH	WI
NOW AVAILABLE THROUGH TOUCH-TONE ORDER ENTRY.							
260409339 ERASER FABER CASTELL 9765-GT3 A-68							
N		EA	1		1		1
NOW AVAILABLE THROUGH TOUCH-TONE ORDER ENTRY.							
260409438 ERASER FANTASTIK 2 A-65							
N		EA	1		1		1
NOW AVAILABLE THROUGH TOUCH-TONE ORDER ENTRY.							
260409636 ERASER FOR BALLPOINT PEN MARKS F-79							
N		EA	1		1		1
NOW AVAILABLE THROUGH TOUCH-TONE ORDER ENTRY.							
260409537 ERASER INK & TYPEWRITER 533T A-63							
N		EA	1		1		1
280031311 ERASER KOH-I-LAR 288N							
N		BX	1		2		1

PRODUCT IDENTIFIER		DESCRIPTION					
ITEM	ORD.	SELL	STD. PKG.	LEAD TIME		MIN.	A
NUMBER	MULT.	UNIT	STOCK AVAILABILITY / PA		ORD.	C	
280031329 ERASER KOH-I-NOOR RAPIDOGRAPH							
N		BX	1		2		1
285 imbibed strip 10 per box.							
260410139 ERASER PDE-1 J-46							
N		EA	1		1		1
5 per tube.							
997583646 ERASER PENCIL 40 2547							
1155408	1	EA	IL	IN	MI	OH	WI
			33	33	33		
260409735 ERASER PENCIL 536T A-64							
N		EA	1		1		1
260409834 ERASER PENCIL CAP RED F-82							
N		EA	1		1		1
NOW AVAILABLE THROUGH TOUCH-TONE ORDER ENTRY.							
260409933 ERASER PENCIL MARKS F-77							
N		EA	1		1		1
Pink pearl, 100.							
260410030 ERASER PENTEL A-66							
N		EA	1		1		1
3 per tube.							
280006107 ERASER PINK PEARL							
0001704	1	DZ	IL	IN	MI	OH	WI
NOW AVAILABLE THROUGH TOUCH-TONE ORDER ENTRY.							
400463774 ERASER PLUG 5							
N		BX	1		3		1
Box of 144.							
260355177 ERASER RETRACTABLE CLIC BLUE							
0001965	1	EA	IL	IN	MI	OH	WI
NOW AVAILABLE THROUGH TOUCH TONE ORDER ENTRY.							
260410238 ERASER RUBY 112 A-62							
N		EA	1		1		1
260410337 ERASER SCRIPTO RED I-40							
N		EA	1		1		1
4 per tube.							
260410436 ERASER SILK 7099B A-67							
N		EA	1		1		1
NOW AVAILABLE THROUGH TOUCH-TONE ORDER ENTRY.							
400463824 ERASER TIP 144							
1155325	1	BX	IL	IN	MI	OH	WI
			33	33	33	33	
Eberhard Faber 1212. Box OF 6.							

DISTRIBUTION SERVICES
 NETWORK SERVICES
 TOOLS
 BUILDING JANITORIAL
 AUTOMOTIVE
 FORMS/OFFICE SUPPLIES
 GENERAL
 DATA VOICE

FASTENER BRASS PAPER

DISTRIBUTION SERVICES

PRODUCT IDENTIFIER		DESCRIPTION				
ITEM NUMBER	ORD. MULT.	SELL UNIT	STD. PKG. STOCK AVAILABILITY / PA	LEAD TIME	MIN. ORD.	A C

PRODUCT IDENTIFIER		DESCRIPTION				
ITEM NUMBER	ORD. MULT.	SELL UNIT	STD. PKG. STOCK AVAILABILITY / PA	LEAD TIME	MIN. ORD.	A C

NETWORK SERVICES

FASTENER BRASS PAPER

260410733 FASTENER ACCO 2 PIECE A-69
 N BX 1 1 1
 NOW AVAILABLE THROUGH TOUCH-TONE ORDER ENTRY.

260410931 FASTENER BRASS PAPER 1/2IN A-71
 N BX 1 1 1
 Box of 100. NOW AVAILABLE THROUGH TOUCH-TONE ORDER ENTRY.

260410832 FASTENER BRASS PAPER 3/8IN A-70
 N BX 1 1 1
 Box of 100.

280005182 FASTENER BRASS PAPER 1 IN
 0001410 1 BX IL IN MI OH WI
 BOX OF 100. NOW AVAILABLE THROUGH TOUCH TONE ORDER ENTRY.

TOOLS

260408042 FASTENER BRASS PAPER 1 1/2IN A-72
 N BX 1 1 1
 Box of 100. NOW AVAILABLE THROUGH TOUCH-TONE ORDER ENTRY.

280005216 FASTENER BRASS PAPER 2 IN
 0001413 1 BX IL IN MI OH WI
 Box of 100. NOW AVAILABLE THROUGH TOUCH-TONE ORDER ENTRY.

BUILDING JANITORIAL

260408141 FASTENER BRASS PAPER 2 IN A-73
 N BX 1 1 1
 Box of 100. NOW AVAILABLE THROUGH TOUCH-TONE ORDER ENTRY.

260364468 FASTENER BRASS PAPER 3 IN
 0001437 1 BX IL IN MI OH WI
 Box of 100. NOW AVAILABLE THROUGH TOUCH-TONE ORDER ENTRY.

AUTOMOTIVE

260408240 FASTENER BRASS PAPER 3 IN K-33
 N BX 1 1 1
 Box of 100.

402309280 FASTENER BRASS PAPER #3
 N EA 1 2 1
 Round head, box of 100.

FORMS/OFFICE SUPPLIES

400464046 FASTENER BRASS PAPER #4
 1155622 1 BX IL IN MI OH WI
 33 33 33 33
 1IN shank, box of 100.

400464061 FASTENER BRASS PAPER #6
 1155648 1 BX IL IN MI OH WI
 33 33 33
 Box of 100.

GENERAL

400524195 FASTENER BRASS PAPER #8
 1155663 1 BX IL IN MI OH WI
 33 33 33 33 33
 Box of 100.

DATA VOICE

FASTENER WASHER

SEE WASHER FASTENER.

FAX PAPER

SEE PAPER FAX.

FILE ADD-A-FILE

260408349 FILE ADD-A-FILE BEIGE E-89
 N EA 1 1 1
 Modular desk filing system.

260408448 FILE ADD-A-FILE BLACK E-90
 N EA 1 1 1
 Modular desk filing system. NOW AVAILABLE THROUGH TOUCH-TONE ORDER ENTRY.

260408745 FILE ADD-A-FILE BLUE E-94
 N EA 1 1 1
 Modular desk filing system.

260408844 FILE ADD-A-FILE CRYSTAL E-95
 N EA 1 1 1
 Modular desk filing system.

260408646 FILE ADD-A-FILE RED E-93
 N EA 1 1 1
 Modular desk filing system.

260408547 FILE ADD-A-FILE SMOKE E-92
 N EA 1 1 1
 Modular desk filing system. NOW AVAILABLE THROUGH TOUCH-TONE ORDER ENTRY.

FILE GUIDE

SEE GUIDE FILE.

FILE MAGNETIC

260355144 FILE MAGNETIC PLASTIC SMOKE
 0001941 1 EA
 NOW AVAILABLE THROUGH TOUCH-TONE ORDER ENTRY.

FILE POCKET

280005539 FILE POCKET EXPANDING LEGAL
 0001524 1 EA
 Cloth reinforced gussets, 3-1/2IN, brown. NOW AVAILABLE THROUGH TOUCH-TONE ORDER ENTRY.

260410741 FILE POCKET EXPANDING LEGAL K-31
 N EA 1 1 1
 3-1/2IN expansion. NOW AVAILABLE THROUGH TOUCH-TONE ORDER ENTRY.

DISTRIBUTION SERVICES

NETWORK SERVICES

TOOLS

BUILDING JANITORIAL

AUTOMOTIVE

FORMS/OFFICE SUPPLIES

GENERAL

DATA VOICE

PRODUCT IDENTIFIER		DESCRIPTION				
ITEM NUMBER	ORD. MULT.	SELL UNIT	STD. PKG. STOCK AVAILABILITY / PA	LEAD TIME	MIN. ORD.	A C
280005547 FILE POCKET EXPANDING LETTER						
0001525	1	EA	IL IN MI OH WI			
Cloth reinforced gussets, 3-1/2IN, brown. NOW AVAILABLE THROUGH TOUCH-TONE ORDER ENTRY.						
280005513 FILE POCKET EXPANDING LETTER						
0001522	1	EA	IL IN MI OH WI			
Cloth reinforced gussets, 1 3/4IN, brown. NOW AVAILABLE THROUGH TOUCH-TONE ORDER ENTRY.						
260410444 FILE POCKET EXPANDING LETTER K-29						
N		EA	1	1	1	
1-3/4IN expansion. NOW AVAILABLE THROUGH TOUCH-TONE ORDER ENTRY.						
260410642 FILE POCKET EXPANDING LETTER K-30						
N		EA	1	1	1	
3-1/2IN expansion. NOW AVAILABLE THROUGH TOUCH-TONE ORDER ENTRY.						
FILE ROTARY						
260414750 FILE ROTARY SWIVEL BASE BEIGE I-49						
N		EA	1	1	1	
For 2 1/4 X 4 IN Rolodex Card.						
260414651 FILE ROTARY SWIVEL BASE BEIGE I-49						
N		EA	1	1	1	
For 2-1/4 X 4IN Rolodex Card. NOW AVAILABLE THROUGH TOUCH TONE ORDER ENTRY.						
FILE WALLET						
260410949 FILE WALLET EXPANDING LEGAL K-28						
N		EA	1	1	1	
9 1/2in x 14 3/4in.						
260410840 FILE WALLET EXPANDING LETTER K-27						
N		EA	1	1	1	
9-1/2 X 11-3/4IN. NOW AVAILABLE THROUGH TOUCH-TONE ORDER ENTRY.						
400547949 FILE WALLET EXPANDING WCA						
N		EA	1	3	100	
9 1/2in x 11 3/4in, correspondence size, 1 3/4in expansion.						
400547956 FILE WALLET EXPANDING WCB						
N		EA	1	2	1	
9 1/2in X 11 3/4in, correspondence size, 1 1/2in expansion.						
400547972 FILE WALLET EXPANDING WLB						
N		EA	1	2	1	
260364476 FILE WALLET EXPANDING - LEGAL						
0001989	1	EA	IL IN MI OH WI			
3-1/2IN expanding with elastic cord. NOW AVAILABLE THROUGH TOUCH TONE ORDER ENTRY.						

PRODUCT IDENTIFIER		DESCRIPTION				
ITEM NUMBER	ORD. MULT.	SELL UNIT	STD. PKG. STOCK AVAILABILITY / PA	LEAD TIME	MIN. ORD.	A C
280005562 FILE WALLET EXPANDING - LEGAL						
0001527	1	EA	IL IN MI OH WI			
2IN expanding, 14-3/4 X 9-1/2IN, cloth tape ties. NOW AVAILABLE THROUGH TOUCH-TONE ORDER ENTRY.						
280005554 FILE WALLET EXPANDING - LETTER						
0001526	1	EA	IL IN MI OH WI			
2IN expanding, 11 3/4 X 9 1/2IN, cloth tape ties. NOW AVAILABLE THROUGH TOUCH TONE ORDER ENTRY.						
260364518 FILE WALLET EXPANDING - LETTER						
0001990	1	EA	IL IN MI OH WI			
3-1/2IN expanding with elastic cord. NOW AVAILABLE THROUGH TOUCH-TONE ORDER ENTRY.						
FILM						
280031428 FILM CORRECTION 4204						
N		EA	1	2	1	
For typewriters.						
260344395 FILM DRAFTING PAPER 8 7/8 X 11IN						
N		SH	1	1	100	
Poly-schematic, transparent.						
280031485 FILM TRANSPARENCY 3R2780						
N		PK	1	2	1	
For copiers.						
FINDER LIST						
260409396 FINDER LIST BEIGE I-08						
N		EA	1	1	1	
5 1/4in x 8 3/8in.						
260409297 FINDER LIST BLACK I-07						
N		EA	1	1	1	
5 1/4in x 8 3/8in.						
260409198 FINDER LIST BROWN I-06						
N		EA	1	1	1	
5 1/4in x 8 3/8in.						
260409495 FINDER LIST REFILL I-09						
N		PD	1	1	1	
5 1/4in x 8 3/8in.						
FINGER RUBBER						
260408356 FINGER RUBBER GRIPEEZ BLUE A-78						
N		EA	1	1	1	
NOW AVAILABLE THROUGH TOUCH-TONE ORDER ENTRY.						

FINGER RUBBER

DISTRIBUTION SERVICES

PRODUCT IDENTIFIER		DESCRIPTION					
ITEM NUMBER	ORD. MULT.	SELL UNIT	STD. PKG. STOCK AVAILABILITY / PA	LEAD TIME	MIN. ORD.	A C	

280004748 FINGER RUBBER LARGE
 0001313 1 DZ IL IN MI OH WI
 NOW AVAILABLE THROUGH TOUCH-TONE ORDER ENTRY.

NETWORK SERVICES

280004730 FINGER RUBBER MEDIUM
 0001312 1 DZ IL IN MI OH WI
 NOW AVAILABLE THROUGH TOUCH-TONE ORDER ENTRY.

TOOLS

402423032 FINGER RUBBER NO 12
 N GR 1 2 1
 Package of 12.

402423057 FINGER RUBBER NO 13
 1274860 1 PK IL IN MI OH WI
 33 33 33
 Package of 12.

BUILDING JANITORIAL

260408455 FINGER RUBBER RED OR AMBER A-79
 N EA 1 1 1
 # 11 small.

260408554 FINGER RUBBER RED OR AMBER A-80
 N EA 1 1 1
 # 11 1/2 medium.

260408653 FINGER RUBBER RED OR AMBER A-81
 N EA 1 1 1
 # 12 large.

AUTOMOTIVE

280004722 FINGER RUBBER SMALL
 0001311 1 DZ IL IN MI OH WI
 NOW AVAILABLE THROUGH TOUCH-TONE ORDER ENTRY.

280004755 FINGER RUBBER X-LARGE
 0001314 1 DZ IL IN MI OH WI
 NOW AVAILABLE THROUGH TOUCH-TONE ORDER ENTRY.

FORMS/OFFICE SUPPLIES

FLUID CORRECTION

260355193 FLUID CORRECTION BLUE
 0001943 1 EA
 NOW AVAILABLE THROUGH TOUCH TONE ORDER ENTRY.

260409826 FLUID CORRECTION BLUE E-43
 N BT 1 1 1
 .6fl oz bottle.

280004789 FLUID CORRECTION CANARY
 0001318 1 EA IL IN MI OH WI
 NOW AVAILABLE THROUGH TOUCH-TONE ORDER ENTRY.

GENERAL

260409628 FLUID CORRECTION CANARY E-41
 N BT 1 1 1
 .6fl oz bottle.

DATA VOICE

PRODUCT IDENTIFIER		DESCRIPTION					
ITEM NUMBER	ORD. MULT.	SELL UNIT	STD. PKG. STOCK AVAILABILITY / PA	LEAD TIME	MIN. ORD.	A C	

280004813 FLUID CORRECTION COPIES
 0001321 1 EA IL IN MI OH WI
 NOW AVAILABLE THROUGH TOUCH-TONE ORDER ENTRY.

260410022 FLUID CORRECTION GOLDENROD E-45
 N BT 1 1 1
 .6fl oz bottle.

260355441 FLUID CORRECTION GREEN
 0001944 1 EA IL IN MI OH WI
 NOW AVAILABLE THROUGH TOUCH-TONE ORDER ENTRY.

260409925 FLUID CORRECTION GREEN E-44
 N BT 1 1 1
 .6fl oz bottle.

260410121 FLUID CORRECTION IVORY E-46
 N BT 1 1 1
 .6fl oz bottle.

260409420 FLUID CORRECTION LEDGER BUFF E-39
 N BT 1 1 1
 .6fl oz bottle.

260355086 FLUID CORRECTION LEDGER GREEN
 0001942 1 EA IL IN MI OH WI
 NOW AVAILABLE THROUGH TOUCH-TONE ORDER ENTRY.

260409529 FLUID CORRECTION LEDGER GREEN E-40
 N BT 1 1 1
 .6fl oz bottle.

260355300 FLUID CORRECTION PEN
 0001940 1 EA IL IN MI OH WI
 NOW AVAILABLE THROUGH TOUCH TONE ORDER ENTRY.

280004821 FLUID CORRECTION PEN & INK
 0001322 1 EA IL IN MI OH WI
 NOW AVAILABLE THROUGH TOUCH-TONE ORDER ENTRY.

260409727 FLUID CORRECTION PINK E-42
 N BT 1 1 1
 .6fl oz bottle.

401611181 FLUID CORRECTION TAPERASER 3189
 4373886 1 EA IL IN MI OH WI
 33
 Non-flammable liquid.

280004797 FLUID CORRECTION THINNER
 0001319 1 EA IL IN MI OH WI
 NOW AVAILABLE THROUGH TOUCH-TONE ORDER ENTRY.

PRODUCT IDENTIFIER DESCRIPTION

ITEM NUMBER	ORD. MULT.	SELL UNIT	STD. PKG. STOCK AVAILABILITY / PA	LEAD TIME	MIN. ORD.	A C
-------------	------------	-----------	-----------------------------------	-----------	-----------	-----

260410220 FLUID CORRECTION THINNER E-47
 N BT 1 1 1
 .6fl oz bottle. NOW AVAILABLE THROUGH TOUCH-TONE ORDER ENTRY.

280004805 FLUID CORRECTION WHITE
 0001320 1 EA IL IN MI OH WI
 NOW AVAILABLE THROUGH TOUCH-TONE ORDER ENTRY.

260410527 FLUID CORRECTION WHITE COPIES J-37
 N BT 1 1 1
 .6fl oz bottle. NOW AVAILABLE THROUGH TOUCH-TONE DATA ENTRY.

260410329 FLUID CORRECTION WHITE MISTAKE OUT A-82
 N BT 1 1 1
 .6fl oz bottle. NOW AVAILABLE THROUGH TOUCH-TONE ORDER ENTRY.

260410428 FLUID CORRECTION WHITE PEN & INK J-36
 N BT 1 1 1
 .6fl oz bottle. NOW AVAILABLE THROUGH TOUCH-TONE ORDER ENTRY.

FOLDER

401203989 FOLDER FORM ORDER SERVICE
 1141077 50 EA
 001127372 FOLDER REPAIRMEN VINYL 7250
 N EA 1 2 1

FOLDER 2 POCKET

260355094 FOLDER 2 POCKET GREEN
 0001934 1 BX
 NOW AVAILABLE THROUGH TOUCH-TONE ORDER ENTRY.

260355342 FOLDER 2 POCKET LETTER BLUE
 0001933 1 BX IL IN MI OH WI
 NOW AVAILABLE THROUGH TOUCH-TONE ORDER ENTRY.

260355359 FOLDER 2 POCKET LETTER ORANGE
 0001935 1 BX IL IN MI OH WI
 NOW AVAILABLE THROUGH TOUCH-TONE ORDER ENTRY.

260364484 FOLDER 2 POCKET LETTER RED
 0001988 1 BX IL IN MI OH WI
 NOW AVAILABLE THROUGH TOUCH-TONE ORDER ENTRY.

260355102 FOLDER 2 POCKET LETTER YELLOW
 0001936 1 BX IL IN MI OH WI
 NOW AVAILABLE THROUGH TOUCH-TONE ORDER ENTRY.

PRODUCT IDENTIFIER DESCRIPTION

ITEM NUMBER	ORD. MULT.	SELL UNIT	STD. PKG. STOCK AVAILABILITY / PA	LEAD TIME	MIN. ORD.	A C
-------------	------------	-----------	-----------------------------------	-----------	-----------	-----

FOLDER FILE

260408752 FOLDER FILE END TAB MANILA A-83
 N BX 1 1 1
 100 per box, 150L.

260432273 FOLDER FILE HANGING LETTER 1/5 CUT
 0001551 1 BX IL IN MI OH WI
 Bright green.

400524757 FOLDER FILE HINGED LEGAL 4445 6
 2745125 1 BX IL IN MI OH WI
 33 33 33 33 33
 14 3/4in X 9 3/8in.

402716484 FOLDER FILE HINGED LETTER 4445 21
 1437129 1 BX IL IN MI OH WI
 33 33 33 33
 Box of 25. Folders complete with labels and label holders.

260409842 FOLDER FILE INDEXED A-Z G-57
 N SE 1 1 1
 25 division. NOW AVAILABLE THROUGH TOUCH-TONE ORDER ENTRY.

260409941 FOLDER FILE INDEXED JAN-DEC G-58
 N SE 1 1 1
 NOW AVAILABLE THROUGH TOUCH-TONE ORDER ENTRY.

260410048 FOLDER FILE INDEXED NUMERIC 1-31 G-59
 N SE 1 1 1
 NOW AVAILABLE THROUGH TOUCH-TONE ORDER ENTRY.

260408950 FOLDER FILE KRAFT A-85
 N BX 1 1 1
 100 per box, 9 1/2in x 1 3/4in.

260408943 FOLDER FILE LETTER 1/3 CUT G-32
 N BX 1 1 1
 100 per box, blue.

260409040 FOLDER FILE LETTER 1/3 CUT G-33
 N BX 1 1 1
 100 per box, green.

260409149 FOLDER FILE LETTER 1/3 CUT G-35
 N BX 1 1 1
 100 per box, gray.

260409248 FOLDER FILE LETTER 1/3 CUT G-36
 N BX 1 1 1
 100 per box, 1/3 cut, lavender.

260409347 FOLDER FILE LETTER 1/3 CUT G-37
 N BX 1 1 1
 100 per box, orange.

260409446 FOLDER FILE LETTER 1/3 CUT G-38
 N BX 1 1 1
 100 per box, pink.

DISTRIBUTION SERVICES

NETWORK SERVICES

TOOLS

BUILDING JANITORIAL

AUTOMOTIVE

FORMS/OFFICE SUPPLIES

GENERAL

DATA VOICE

DISTRIBUTION SERVICES

FOLDER FILE

PRODUCT IDENTIFIER		DESCRIPTION				
ITEM NUMBER	ORD. MULT.	SELL UNIT	STD. PKG. STOCK	LEAD TIME AVAILABILITY / PA	MIN. ORD.	A C

260409545 FOLDER FILE LETTER 1/3 CUT G-39
N BX 1 1 1
100 per box, red.

260409644 FOLDER FILE LETTER 1/3 CUT G-40
N BX 1 1 1
100 per box, white.

260409743 FOLDER FILE LETTER 1/3 CUT G-41
N BX 1 1 1
100 per box, yellow.

280005489 FOLDER FILE LETTER 1/3 CUT 12113
0001519 1 BX IL IN MI OH WI
100 per box, manila. NOW AVAILABLE THROUGH TOUCH-TONE ORDER ENTRY.

280005497 FOLDER FILE LETTER 1/5 CUT 12115
0001520 1 BX IL IN MI OH WI
100 per box, manila. NOW AVAILABLE THROUGH TOUCH-TONE ORDER ENTRY.

NETWORK SERVICES

TOOLS

BUILDING JANITORIAL

AUTOMOTIVE

FORMS/OFFICE SUPPLIES

GENERAL

DATA VOICE

260410147 FOLDER FILE MANILA 1/3 CUT G-28
N BX 1 1 1
2 PLY. 100 per box. NOW AVAILABLE THROUGH TOUCH-TONE ORDER ENTRY.

260410246 FOLDER FILE MANILA 1/5 CUT G-29
N BX 1 1 1
2 PLY. 100 per box. NOW AVAILABLE THROUGH TOUCH-TONE ORDER ENTRY.

260410543 FOLDER FILE PRESSBOARD LEGAL G-51
N BX 1 1 1
Heavy duty, 25 per box, self tab, 1/3 cut, 2in expansion.

260410345 FOLDER FILE PRESSBOARD LETTER G-49
N BX 1 1 1
Heavy duty, 25 per box, self tab, 1/3 cut.

260408851 FOLDER FILE SINGLE TAB MANILA A-84
N BX 1 1 1
Box of 50, 1-3/4 X 9-7/8IN. NOW AVAILABLE THROUGH TOUCH-TONE ORDER ENTRY.

280005406 FOLDER FILE STRAIGHT CUT LETTER 12110
0001511 1 BX IL IN MI OH WI
Box of 100, manila. NOW AVAILABLE THROUGH TOUCH TONE ORDER ENTRY.

401333984 FOLDER FILE VERTICAL 1404A
5604009 10 BX IL IN MI OH WI
33 33
Box of 100.

401333976 FOLDER FILE VERTICAL 302
5603985 1 BX IL IN MI OH WI
33 33
Box of 100.

401333992 FOLDER FILE VERTICAL 5058R
5604025 1 BX IL IN MI OH WI
33 33
Box of 100.

PRODUCT IDENTIFIER		DESCRIPTION				
ITEM NUMBER	ORD. MULT.	SELL UNIT	STD. PKG. STOCK	LEAD TIME AVAILABILITY / PA	MIN. ORD.	A C

400547824 FOLDER FILE VERTICAL KRAFT CHP
1157925 1 BX IL IN MI OH WI
33 33 33 33
Correspondence size.

400547832 FOLDER FILE VERTICAL KRAFT CHX
1157941 1 BX IL IN MI OH WI
33 33 33 33
Correspondence size, expandable.

400547840 FOLDER FILE VERTICAL KRAFT LHP
1101782 1 EA IL IN MI OH WI
33 33 33

FOLDER HANGING

260409552 FOLDER HANGING FILE 1IN LEGAL G-02
N BX 1 1 1
Box bottom, w/o tabs, 25 per box, 1in capacity.

260409057 FOLDER HANGING FILE 1IN LETTER F-97
N BX 1 1 1
Box bottom, w/o tabs, 25 per box, 1in capacity.

260409651 FOLDER HANGING FILE 2IN LEGAL G-03
N BX 1 1 1
Box bottom, w/o tabs, 25 per box, 2IN capacity. NOW AVAILABLE THROUGH TOUCH-TONE ORDER ENTRY.

260409156 FOLDER HANGING FILE 2IN LETTER F-98
N BX 1 1 1
Box bottom, w/o tabs, 25 per box, 2IN capacity. NOW AVAILABLE THROUGH TOUCH-TONE ORDER ENTRY.

260409255 FOLDER HANGING FILE 3IN LETTER F-99
N BX 1 1 1
Box bottom, w/o tabs, 25 per box, 3in capacity.

260409750 FOLDER HANGING FILE 4IN LEGAL G-05
N BX 1 1 1
Box bottom, w/o tabs, 25 per box, 4in capacity.

260409354 FOLDER HANGING FILE 4IN LETTER G-01
N BX 1 1 1
Box bottom, w/o tabs, 25 per box, 4in capacity.

280005356 FOLDER HANGING FILE LEGAL
0001505 1 BX IL IN MI OH WI
1/5 Cut, green. Box of 25. NOW AVAILABLE THROUGH TOUCH-TONE ORDER ENTRY.

260410550 FOLDER HANGING FILE LEGAL 1/5 CUT F-94
N BX 1 1 1
25 per box, red.

260410659 FOLDER HANGING FILE LEGAL 1/5 CUT F-95
N BX 1 1 1
25 per box, blue.

260410758 FOLDER HANGING FILE LEGAL 1/5 CUT F-96
N BX 1 1 1
25 per box, yellow.

PRODUCT IDENTIFIER		DESCRIPTION				
ITEM NUMBER	ORD. MULT.	SELL UNIT	STD. PKG. STOCK AVAILABILITY / PA	LEAD TIME	MIN. ORD.	A C
260409958	N	BX	1	1	1	A-87
FOLDER HANGING FILE LEGAL HF250 25 per box, 1/5 cut. NOW AVAILABLE THROUGH TOUCH-TONE ORDER ENTRY.						
260410154	N	BX	1	1	1	A-89
FOLDER HANGING FILE LEGAL HF250 25 per box, 1/3 cut.						
280005364	0001506	1 BX	IL IN MI OH WI	FOLDER HANGING FILE LETTER 1/5 Cut, green. Box of 25. NOW AVAILABLE THROUGH TOUCH-TONE ORDER ENTRY.		
260355391	0001939	1 BX	IL IN MI OH WI	FOLDER HANGING FILE LETTER 1/5 Cut, yellow. Box of 25. NOW AVAILABLE THROUGH TOUCH-TONE ORDER ENTRY.		
260355383	0001937	1 BX	IL IN MI OH WI	FOLDER HANGING FILE LETTER 1/5 CUT BLUE Box of 25. NOW AVAILABLE THROUGH TOUCH-TONE ORDER ENTRY.		
260410253	N	BX	1	1	1	FOLDER HANGING FILE LETTER 1/5 CUT F-91 Box of 25, RED.
260410352	N	BX	1	1	1	FOLDER HANGING FILE LETTER 1/5 CUT F-92 Box of 25, BLUE.
260410451	N	BX	1	1	1	FOLDER HANGING FILE LETTER 1/5 CUT F-93 Box of 25, YELLOW.
260355136	0001938	1 BX	IL IN MI OH WI	FOLDER HANGING FILE LETTER 1/5 CUT RED Box of 25. NOW AVAILABLE THROUGH TOUCH-TONE ORDER ENTRY.		
260409859	N	BX	1	1	1	FOLDER HANGING FILE LETTER HF150 A-86 Box of 25, 1/5 CUT. NOW AVAILABLE THROUGH TOUCH-TONE ORDER ENTRY.
260410055	N	BX	1	1	1	FOLDER HANGING FILE LETTER HF150 A-88 Box of 25, 1/3 CUT.
FOLDER POCKET PORTFOLIO						
260410857	N	EA	1	1	1	FOLDER POCKET PORTFOLIO BLACK A-90 With double pocket. NOW AVAILABLE THROUGH TOUCH-TONE ORDER ENTRY.
260408661	N	EA	1	1	1	FOLDER POCKET PORTFOLIO DARK BLUE A-98 With double pocket. NOW AVAILABLE THROUGH TOUCH-TONE ORDER ENTRY.

PRODUCT IDENTIFIER		DESCRIPTION				
ITEM NUMBER	ORD. MULT.	SELL UNIT	STD. PKG. STOCK AVAILABILITY / PA	LEAD TIME	MIN. ORD.	A C
260410956	N	EA	1	1	1	FOLDER POCKET PORTFOLIO GRAY A-91 With double pocket.
260408265	N	EA	1	1	1	FOLDER POCKET PORTFOLIO GREEN A-94 With double pocket.
260408562	N	EA	1	1	1	FOLDER POCKET PORTFOLIO LIGHT BLUE A-97 With double pocket. NOW AVAILABLE THROUGH TOUCH-TONE ORDER ENTRY.
260408364	N	EA	1	1	1	FOLDER POCKET PORTFOLIO ORANGE A-95 With double pocket.
260408067	N	EA	1	1	1	FOLDER POCKET PORTFOLIO RED A-92 With double pocket.
260408166	N	EA	1	1	1	FOLDER POCKET PORTFOLIO TAN A-93 With double pocket.
260408463	N	EA	1	1	1	FOLDER POCKET PORTFOLIO WHITE A-96
260408760	N	EA	1	1	1	FOLDER POCKET PORTFOLIO YELLOW A-99 With double pocket.
FOOT-EZE						
260408869	N	EA	1	1	1	FOOT-EZE STEEL GRAY F-87 NOW AVAILABLE THROUGH TOUCH-TONE ORDER ENTRY.
FORM						
260427919	N	SE	3000	2	60000	FORM 9 X 5 2PT 15# J60M23 OH - Teletype Paper, white, 15LB.
0007661	1	EA	FORM 21 J	027KR1	IN - Blue Cross/Blue Shield Medical Claim Form. INDIANA ONLY.	
001067354	5121269	50 SE	32	S20M20	FORM 33 IL IN MI OH WI IL - Request For Tools, 3 ply.	
0005449	25	EA	FORM 35	ISS 10-85	IN - Furniture & Office Equipment Forecast Summary. INDIANA ONLY.	

DISTRIBUTION SERVICES
NETWORK SERVICES
TOOLS
BUILDING JANITORIAL
AUTOMOTIVE
FORMS/OFFICE SUPPLIES
GENERAL
DATA VOICE

FORM

DISTRIBUTION SERVICES

PRODUCT IDENTIFIER		DESCRIPTION				
ITEM NUMBER	ORD. MULT.	SELL UNIT	STD. PKG. STOCK AVAILABILITY / PA	LEAD TIME	MIN. ORD.	A C
FORM		35 J ISS 05-86 414R1				
0007704	1	EA				
IN - Membership Application for Blue Cross/Blue Shield of Indiana. INDIANA ONLY.						

NETWORK SERVICES

260368840 FORM		48 ISS 07-89 S5M20				
1955641	1	EA	IL IN MI OH WI			
33 IL - Illinois Bell Facilities label, 2 1/2 X 3IN round.						
260368832 FORM		48 1 ISS 07-89 S5M20				
1955633	1	EA	IL IN MI OH WI			
33 IL - Illinois Bell Facilities label, 4 1/4 X 3/4IN round.						

TOOLS

260368824 FORM		48 2 ISS 07-89 S3M20				
1955625	1	EA	IL IN MI OH WI			
33 IL - NETPOP - Illinois Bell Facilities label, 4 1/8 X 4 1/2IN, green.						

BUILDING JANITORIAL

260368816 FORM		48 3 ISS 07-89 S3M20				
1955617	1	EA	IL IN MI OH WI			
33 IL - APOP - Illinois Bell Facilities label, 4 1/8 X 4 1/2IN, green.						

260368808 FORM		48 4 ISS 07-89 S6M20				
1955609	1	EA	IL IN MI OH WI			
33 IL - Tag - Illinois Bell Facilities, 2 1/4 X 1/2IN.						

AUTOMOTIVE

260368790 FORM		48 5 ISS 07-89 S5M20				
1955591	1	EA	IL IN MI OH WI			
33 IL - Customer Wire Terminations label, 4 1/4 X 3/4IN round, orange.						

FORMS/OFFICE SUPPLIES

260368782 FORM		48 6 ISS 07-89 S5M20				
1955583	1	EA	IL IN MI OH WI			
33 IL - Network Interface Device label, 2 1/2 X 3IN round, orange.						

260368774 FORM		48 7 ISS 07-89 S15M20				
1955575	15000	EA	IL IN MI OH WI			
33 IL - Network Interface Device label, 3/4 X 4IN, orange.						

GENERAL

280042201 FORM		56 A ISS 07-76 J15C24				
N		SH	10	4	1500	

280044157 FORM		71 ISS 03-90 J5M24				
N		EA	500	6	5000	

260339536 FORM		80 2 ISS 06-88				
1949081	50	PD	IL IN MI OH WI			
33 IN - Personal Injury and Property Damage Report.						

DATA VOICE

300080405 FORM		96 ISS 11-85				
5124974	50	SE	IL IN MI OH WI			
33 IL - Coin Telephone Receptacle/Key/Lock Transmittal.						

PRODUCT IDENTIFIER		DESCRIPTION				
ITEM NUMBER	ORD. MULT.	SELL UNIT	STD. PKG. STOCK AVAILABILITY / PA	LEAD TIME	MIN. ORD.	A C

FORM		001 M ISS 01-92				
0007528	1	EA				
IN - Short Term Prescription Form - Baxter. INDIANA ONLY.						

260445523 FORM		101 ISS 05-92 S1MIL20				
N		EA	500	4	100000	
IL - Final Notice Prior To Disconnection.						

260436092 FORM		101 ISS 09-91 S1MIL20				
1980763	500	SH	IL IN MI OH WI			
33 IL - Final Notice Prior To Disconnection.						

001049394 FORM		109 D A5M21				
1158089	500	EA	IL IN MI OH WI			
33 MI - Envelope - 4th Class Mail, General Use.						

260427828 FORM		110 ISS 09-91 S8M20				
1977728	100	SH	IL IN MI OH WI			
33 IL - 1992 Schedule of Vacations and Other Time Off.						

002048320 FORM		110 B				
5648147	500	SH	IL IN MI OH WI			
33 IL - Record of Vacations and Other Time Off.						

260428644 FORM		111 ISS 09-91 S50M20				
1977884	500	SH	IL IN MI OH WI			
33 IL - Attendance Record (1992 & 1993)						

300069937 FORM		114 2 ISS 11-83 J50M20				
N		SH	12500	8	50000	
IL - Continuous Directory Label, 6 1/2 X 2 5/8IN.						

260361555 FORM		142 ISS 10-89 L10M20				
N		SH	500	2	500	
IL - Daily Work Log.						

260339445 FORM		149 ISS 10-88				
1949057	500	EA	IL IN MI OH WI			
33 IL - Envelope - Duplicate Bill Microfiche, 5 15/16 X 4 3/4IN, 20# white.						

260320312 FORM		151 ISS 01-88 S5M20				
1941971	250	SH	IL IN MI OH WI			
33 IL - Non-Management Appraisal.						

260338298 FORM		154 ISS 09-88				
1948109	500	SH	IL IN MI OH WI			
33 IL - Report of Employee Leaving Service.						

260321781 FORM		156 ISS 01-88				
1942631	1000	SH	IL IN MI OH WI			
33 IL - Summary of Contacts.						

280044165 FORM		161 ISS 02-92 J15C24				
N		EA	25	6	1500	
WI - Envelope - Employment Record.						

PRODUCT IDENTIFIER		DESCRIPTION					
ITEM NUMBER	ORD. MULT.	SELL UNIT	STD. PKG. STOCK AVAILABILITY / PA	LEAD TIME	MIN. ORD.	A	C
001058171		FORM	184				
5606541	500	SH	IL IN MI OH WI	33			
IL - Work Report - Engineering Forces.							
001074871		FORM	199 1A				
5638023	250	SH	IL IN MI OH WI	33			
IL - Employee Worktime Deviations.							
002081842		FORM	200 2 ISS 01-83				
5652388	500	SH	IL IN MI OH WI	33			
IL - Daily Force and Hours Summary.							
001049493		FORM	214				
1158121	100	EA	IL IN MI OH WI	32			
Envelope.							
200005007		FORM	226 1 ISS 05-78 L200M20				
N		EA	500	2	500		
IL - Public Telephone Refund - Coin Telephone Reminder Notice card.							
300090818		FORM	231 ISS 10-80				
1932368	25	SE	IL IN MI OH WI	33			
IN - Postage Requisition.							
260442280		FORM	241 ISS 02-92 L15M20				
N		EA	100	6	100		
IL - Envelope - Priority Mail (Contract Collector).							
300084696		FORM	241 33 ISS 02-86				
5126656	5000	EA	IL IN MI OH WI	33			
IL - Envelope - US Mail, 9 1/2in X 5in, Kraft w/3 inch expansion, 28# brown.							
260446513		FORM	241 55 ISS 03-92 L3M20				
N							
IL - ENVELOPE - U.S. Mail (Contract Collector) 11 X 5IN, 3IN expansion.							
260434725		FORM	248 ISS 08-91 S60M20				
1979963		SH	IL IN MI OH WI	33			
IL - Quality Sample Record.							
260434733		FORM	248-1 ISS 08-91 S15M20				
1979955		SH	IL IN MI OH WI	33			
IL - Quality Sample Record II.							
260434741		FORM	249 ISS 08-91 S50M20				
1979971		SH	IL IN MI OH WI	33			
IL - Quality Summary.							
001172105		FORM	254				
5638882	500	SH	IL IN MI OH WI	33			
IL - Operator Referral Memo.							

PRODUCT IDENTIFIER		DESCRIPTION					
ITEM NUMBER	ORD. MULT.	SELL UNIT	STD. PKG. STOCK AVAILABILITY / PA	LEAD TIME	MIN. ORD.	A	C
300030392		FORM	255 ISS 09-84				
5108019	50	SE	IL IN MI OH WI	33			
IL - Dishonored Check Recharge Memo Transmittal.							
300034105		FORM	267 ISS 09-84				
5108738	500	SH	IL IN MI OH WI	33			
IL - Today's Priorities.							
260443445		FORM	282 ISS 03-92 S25M20				
N		SE	500	8	25000		
IL - Deferred Payment Agreement.							
260347596		FORM	283 ISS 03-89				
1951657	500	SH	IL IN MI OH WI	33			
IL - Special Toll Bill.							
260358528		FORM	283 1				
1953182	500	SH	IL IN MI OH WI	33			
300029055		FORM	284 ISS 09-84				
5105916	500	SE	IL IN MI OH WI	33			
IL - Deposit Advise.							
300009248		FORM	284 1 ISS 01-84 S2M20				
1167858	500	SH	IL IN MI OH WI	33			
IL - Deposit Information - New Customers.							
300009255		FORM	284 2 ISS 01-84 S2M20				
1198390	200	SH	IL IN MI OH WI	33			
IL - Deposit Information - Existing Customers - Residence.							
200005858		FORM	284 6 ISS 10-90 L13M20				
N		SH	2750	2	2750		
IL - Deposit Advice, continuous, roll fashion.							
280042243		FORM	285 ISS 05-79 J10M24				
N		EA	500	4	10000		
280042250		FORM	286 T ISS 06-79 J25M24				
N		SH	500	4	25000		
260338751		FORM	290 ISS 10-88				
1948620	100	EA	IL IN MI OH WI	33			
IL - Deposit envelope, 8 1/2 X 12IN, poly clear.							
260338744		FORM	290 1 ISS 10-88				
1948638	25	EA	IL IN MI OH WI	33			
IL - Deposit envelope, 14 X 22IN, poly clear.							
260402060		FORM	293 ISS 10-90 S35M20				
1968123	1	SH	IL IN MI OH WI	33			
IL - Credit Ticket.							

DISTRIBUTION SERVICES

NETWORK SERVICES

TOOLS

BUILDING JANITORIAL

AUTOMOTIVE

FORMS/OFFICE SUPPLIES

GENERAL

DATA VOICE

FORM

DISTRIBUTION SERVICES

PRODUCT IDENTIFIER		DESCRIPTION					
ITEM NUMBER	ORD. MULT.	SELL UNIT	STD. PKG. STOCK AVAILABILITY / PA	LEAD TIME	MIN. ORD.	A C	

260435029 FORM 294 ISS 11-91 S10M20
 1980003 25 SH IL IN MI OH WI
 33
 IL - Information Credit Ticket.

NETWORK SERVICES

300023124 FORM 309 ISS 05-84 S4M20
 5104794 500 SH IL IN MI OH WI
 33
 IL - Request for Service Review-Voice Data/Facsimile.

260425533 FORM 309 1 ISS 09-91 S4M20
 1977108 25 SE IL IN MI OH WI
 33
 IL - Request for Service-Data.

TOOLS

260425525 FORM 309 3 ISS 09-91 S4M20
 1977090 25 SE IL IN MI OH WI
 33
 IL - Request for Service-Voice/ISDN.

BUILDING JANITORIAL

260438890 FORM 311 1 ISS 01-92 S2M20
 N SE 25 8 2000
 IL - REQUEST FOR AMA TESTS.

300090099 FORM 315 1D ISS 02-92 A27M22
 1932376 500 SH IL IN MI OH WI
 33
 IN - Letterhead - Outstate.

300099942 FORM 318 G
 1932384 50 SH IL IN MI OH WI
 33
 IN - Deny Service Advice.

AUTOMOTIVE

260318241 FORM 321 ISS 12-87
 1941336 1000 SH IL IN MI OH WI
 33
 IL - Coin Trouble Report.

FORMS/OFFICE SUPPLIES

260417167 FORM 333 1 ISS 02-91 S7M20
 1972307 25 SH IL IN MI OH WI
 33
 Record of Customer Service Contract.

280071390 FORM 335 3 ISS 07-87
 1935122 100 SE IL IN MI OH WI
 33
 IL - Order Form For N, T, and F Orders.

300043072 FORM 336 1 ISS 01-85
 5114470 500 SH IL IN MI OH WI
 33
 IL - Change/Record Order.

GENERAL

280071408 FORM 336 3 ISS 07-87
 1935114 100 SE IL IN MI OH WI
 33
 IL - Change/Record Order - Snapout.

280071416 FORM 337 3 ISS 07-87
 1935106 100 SE IL IN MI OH WI
 33
 IL - Disconnect Order.

DATA VOICE

PRODUCT IDENTIFIER		DESCRIPTION					
ITEM NUMBER	ORD. MULT.	SELL UNIT	STD. PKG. STOCK AVAILABILITY / PA	LEAD TIME	MIN. ORD.	A C	

002033835 FORM 348 ISS 10-80 S10M20
 5646745 250 SE IL IN MI OH WI
 33
 IL - Directory Assistance Trouble Memo.

001167501 FORM 357 ISS 01-74 J5M20
 N EA 5000 4 5000
 IL - Overflow label.

200005692 FORM 374 40 J12M21
 N EA 250 6 12000

001049675 FORM 374 4F S80M21
 1158261 250 EA IL IN MI OH WI
 33
 Envelope.

001049683 FORM 374 F A60M21
 1158204 500 EA IL IN MI OH WI
 33
 MI - Envelope - General Use, blank return address, brown Kraft.

280042292 FORM 382 ISS 06-79 J20M24
 N EA 500 4 20000

260324991 FORM 391 ISS 09-88 S40M20
 1945188 50 SE IL IN MI OH WI
 33
 IL - Classification & Approval Form for Supplier Bills & Expense Voucher.

260324983 FORM 391 1 ISS 09-88 S57M8C20
 1945170 950 SE IL IN MI OH WI
 33
 IL - Classification & Approval Form, for Supplier Bills & Expense Vouchers, continuous.

001049709 FORM 411 E
 1158303 100 EA IL IN MI OH WI
 33
 Envelope.

300099959 FORM 414 ISS 01-87
 1932285 25 SH IL IN MI OH WI
 33
 IN - No Access Form.

280042300 FORM 420 ISS 10-88 J15M24
 N EA 25 4 15000

200005379 FORM 429 14B J20M21
 N EA 500 6 20000
 Envelope.

200002533 FORM 429 1H J40M21
 N EA 500 6 40000
 Envelope.

200002293 FORM 429 259 J6M21
 N EA 500 6 6000
 Envelope.

200002541 FORM 429 2H J10M21
 N EA 500 6 10000
 Envelope.

PRODUCT IDENTIFIER		DESCRIPTION						
ITEM NUMBER	ORD. MULT.	SELL UNIT	STD. PKG. STOCK AVAILABILITY / PA	LEAD TIME	MIN. ORD.	A C		
001049824 FORM		429 E	A225M21					
1158345	100	EA	IL IN MI OH WI					
			33					
MI - Envelope - U.S. Mail - General Use.								
260303839 FORM		431 49						
1940486	500	EA	IL IN MI OH WI					
			33					
001049881 FORM		431 D						
1158501	500	EA	IL IN MI OH WI					
			33					
Envelope.								
260422415 FORM		434 ISS 09-91 J6M24						
N		SE	25	4	6000			
WI - Graphics Services Request.								
260422423 FORM		434 B ISS 09-91 J6M24						
N		SE	25	4	6000			
WI - Personalized Company Stationery Printing Request.								
260422431 FORM		434 C ISS 04-91 J15624						
N		SE	25	4	1500			
WI - Company Publications Request for Distribution.								
002031144 FORM		438						
5646406	500	SH	IL IN MI OH WI					
			33					
IL - Home Telephone Service Credit Application.								
001035443 FORM		438 B ISS 05-83 L12M20						
N		SH	500	2	500			
IL - Credit Application - Business.								
280044199 FORM		458 1 ISS 02-92 J5M24						
N		EA	50	6	5000			
WI - Envelope - For Filling Work Orders (Printed).								
300062312 FORM		467 ISS 03-78						
5118216	500	SH	IL IN MI OH WI					
			33					
IL - Record of Bills Forwarded For Payment.								
001214832 FORM		488 4A						
5634949	500	SH	IL IN MI OH WI					
			33					
IL - Choice of Hours.								
001059005 FORM		494						
5609362	500	EA	IL IN MI OH WI					
			33					
IL - Envelope Plain 9 1/4in x 6in Kraft brown 24 #.								
200004455 FORM		494 2 ISS 08-90 J10M20						
N		EA	500	6	10000			
IL - Envelope- Benefit Department HQ 15G, 9 1/4in x 6 1/8IN, Kraft 24 # brown.								
001059047 FORM		502						
6673368	500	EA	IL IN MI OH WI					
			33					
IL - Envelope - Service Order Filing, 5 1/2 X 9 1/2IN, Kraft 20 # brown.								

PRODUCT IDENTIFIER		DESCRIPTION						
ITEM NUMBER	ORD. MULT.	SELL UNIT	STD. PKG. STOCK AVAILABILITY / PA	LEAD TIME	MIN. ORD.	A C		
280045360 FORM		531 ISS 03-86 J50M24						
N		SH	1000	8	50000			
WI - Continuous Letterhead with Logo.								
260338587 FORM		531 2 ISS 10-88 J5M24						
N		EA	1000	6	5000			
WI - Continuous Letterhead - 845 N. 35th Street.								
260439450 FORM		531 3 ISS 01-92 J27C24						
N		SH	2700	8	2700			
WI - Continuous Letterhead - Security.								
260378369 FORM		542 A ISS 12-77 A70M23						
N		SH	2500	2	2500			
OH - Gummed Label 'O.B.T. CO. To'								
280024159 FORM		545 F ISS 01-84						
1932392	25	EA	IL IN MI OH WI					
			33					
IN - Envelope - self-sealing 10 X 13IN Kraft.								
FORM 551 B								
0006075	25	EA						
IN - General Release. INDIANA ONLY.								
300067220 FORM		560 2 ISS 05-85						
1155796	500	EA	IL IN MI OH WI					
			33					
IL - Return Billing Envelope - Bell Payment Center, 5 1/2 X 3 3/4IN, woven, 20# white.								
300090826 FORM		581 2C						
1932434	25	EA	IL IN MI OH WI					
			33					
IN - Gummed Shipping Label - Outstate Division.								
001059252 FORM		584						
5610568	500	EA	IL IN MI OH WI					
			33					
IL - Envelope for Bills Paid By Field Draft or Treasurer's Check, 12 X 9IN Kraft 24 # brown.								
001059260 FORM		588						
7327502	500	EA	IL IN MI OH WI					
			33					
IL - Coin Checklist.								
260419627 FORM		590 ISS 04-91 S4M20						
1974485	25	SE	IL IN MI OH WI					
			33					
Call Identification Screening/Hotel Request.								
280042367 FORM		610 ISS 02-88 J25M24						
N		EA	500	4	5000			
300017886 FORM		610 ISS 05-84 S2M20						
5104654	50	SE	IL IN MI OH WI					
			33					
IL - Transmittal List For Records Forwarded To.								
280024167 FORM		617 B ISS 01-84						
1932442	25	EA	IL IN MI OH WI					
			33					
IN - Envelope - 15 X 10IN Kraft, 240 N. Meridian.								

DISTRIBUTION SERVICES
 NETWORK SERVICES
 TOOLS
 BUILDING JANITORIAL
 AUTOMOTIVE
 FORMS/OFFICE SUPPLIES
 GENERAL
 DATA VOICE

FORM

DISTRIBUTION SERVICES
NETWORK SERVICES
TOOLS
BUILDING JANITORIAL
AUTOMOTIVE
FORMS/OFFICE SUPPLIES
GENERAL
DATA VOICE

PRODUCT IDENTIFIER		DESCRIPTION					
ITEM NUMBER	ORD. MULT.	SELL UNIT	STD. PKG. STOCK AVAILABILITY / PA	LEAD TIME	MIN. ORD.	A C	
280024175 FORM		637 B					
1932418	25	EA	IL IN MI OH WI				
			33				
IL - Envelope - 1- 1/2 X 7IN, Indiana Bell Telephone Company.							
260384391 FORM		643 ISS 05-90 S4M20					
1962456	500	SH	IL IN MI OH WI				
			33				
IL - Customer Service Questionnaire. Has 2 removable label strips, folds to a mailer.							
001050053 FORM		657 H					
1158808	500	EA	IL IN MI OH WI				
			33				
Envelope.							
300018017 FORM		659 27 ISS 06-84 S3M20					
5104646	500	SH	IL IN MI OH WI				
			33				
IL - LABEL - Visitors Temporary Pass, purple, Non HQ.							
200005486 FORM		666 15 ISS 05-88 L66M20					
N		EA	500	2	500		
IL - Final Bills envelope, 8 3/4 X 5 3/4, woven 24 # white.							
280071218 FORM		680 ISS 04-87 J20M24					
N		EA	100	4	20000		
260301817 FORM		681 2 ISS 11-87					
1938704	250	SH	IL IN MI OH WI				
			33				
IL - Dial 1 Plus Equal Access - Customer Confirmation.							
300091543 FORM		681 3 ISS 04-86					
1921106	250	SH	IL IN MI OH WI				
			33				
IL - Request for Account Restriction of Long Distance Company.							
280093345 FORM		681 4 ISS 08-87					
1936856	500	EA	IL IN MI OH WI				
			33				
IL - Dial 1 Plus Access envelope, 9 1/8 X 4 1/4IN, woven, 24 # white.							
260323100 FORM		681 5 ISS 04-87					
1943563	25	SE	IL IN MI OH WI				
			33				
IL - Dial 1 Plus Charges Adjustment Confirmation.							
003006723 FORM		686 ISS 08-89 J56C20					
N		SE	50	8	5600		
IL - Direct Deposit Agreement.							
280093253 FORM		692					
N		EA	500	6	10000		
FORM		694 B					
0003682	1000	EA					
IN - Analyses of Accounts - Year. INDIANA ONLY.							

PRODUCT IDENTIFIER		DESCRIPTION					
ITEM NUMBER	ORD. MULT.	SELL UNIT	STD. PKG. STOCK AVAILABILITY / PA	LEAD TIME	MIN. ORD.	A C	
280327820 FORM		703 1 ISS 05-88 S2M20					
1945493	25	SE	IL IN MI OH WI				
			33				
IL - Memorandum of Agreement, for specific job only.							
001059500 FORM		709 X					
1171900	1000	SE	IL IN MI OH WI				
			33				
IL - Daily Construction Material Report.							
280044215 FORM		720					
N		EA	50	6	25000		
280044223 FORM		721 ISS 02-92 J25M24					
N		EA	25	6	25000		
WI - Kraft Envelope 6 x 9-1/2.							
280044231 FORM		722 ISS 02-92 J10M24					
N		EA	25	6	10000		
WI - Mailing Envelope 3rd Class.							
001032945 FORM		722 SP					
5604785		EA	IL IN MI OH WI				
			33				
IL - Depository envelope in English and Spanish.							
280044249 FORM		723 ISS 02-92 J40M24					
N		EA	50	6	20000		
WI - Large Kraft mailing envelope.							
280044256 FORM		723 2 ISS 02-92 J1M24					
N		EA	500	6	1000		
WI - Envelope with Madison Address.							
280044264 FORM		723 3 ISS 02-92 J1M24					
N		EA	500	6	1000		
WI - Envelope with Eau Claire Address.							
280044272 FORM		724 ISS 02-92 J10M24					
N		EA	25	6	5000		
WI - Large Kraft mailing envelope.							
280042375 FORM		726 1 ISS 04-69 J8.5M24					
N		SH	500	4	10000		
280044280 FORM		731 ISS 02-92 J40M24					
N		EA	500	6	40000		
WI - Envelope - Microfiche.							
001059575 FORM		734 1					
5611525	500	SH	IL IN MI OH WI				
			33				
IL - Customer Loop Transmission Data, 35 KFT Loops.							
001047436 FORM		734 2					
5611566	500	SH	IL IN MI OH WI				
			33				
IL - Customer Loop Transmission Data, 100 KFT Loops.							
260417175 FORM		742 ISS 02-91 S8M20					
1972315	8000	SH	IL IN MI OH WI				
			33				
IL - Application for Upgrade & Transfer - Intra-Company Only.							

PRODUCT IDENTIFIER		DESCRIPTION				
ITEM NUMBER	ORD. MULT.	SELL UNIT	STD. PKG. STOCK AVAILABILITY / PA	LEAD TIME	MIN. ORD.	A C
260303284 FORM 745 ISS 09-87						
1940304	100	SE	IL IN MI OH WI	33		
IL - Time and Material Data Sheet.						
260367875 FORM 745 1 ISS 01-90						
1955435	5000	SH	IL IN MI OH WI	33		
IL - Buried Service Wire Data Sheet.						
001158138 FORM 792 ISS 02-72 J2M20						
N		EA	1000	4	2000	
IL - Important Notice tag.						
280044298 FORM 800 1 ISS 02-92 J30M24						
N		EA	500	6	30000	
280044306 FORM 800 2 ISS 02-92 J30M24						
N		EA	500	6	30000	
WI - Envelope For Directory with Permit.						
260384953 FORM 800 3 ISS 02-92 J20M24						
N		EA	500	6	20000	
WI - ENVELOPE - 7-1/2 X 10-1/2. For API Suspended Area.						
001059765 FORM 820						
5121665	100	EA	IL IN MI OH WI	33		
IL - Test Record - Manhole Atmosphere.						
200004489 FORM 846 1 ISS 10-82 L25M20						
N		EA	500	2	500	
IL - Customer Return Envelope.						
260319199 FORM 858 ISS 01-88						
1941435	500	SH	IL IN MI OH WI	33		
IL - Absence Report Memo.						
280044314 FORM 863 ISS 02-92 J4M5C24						
N		EA	450	6	4500	
WI - Envelope - Public & Semi-Public Coin Comp. Key.						
280042409 FORM 877 1 ISS 04908 J220M24						
N		EA	500	4	220000	
260428347 FORM 877 3 ISS 01-92 J15M20						
N		SH	500	4	15000	
WI - Time Reporting Time.						
260406608 FORM 885 ISS 02-90 S2M22						
1970228	2000	BK	IL IN MI OH WI	33		
IN - Employee Expense Statement.						
001059880 FORM 887 1						
5612747	500	SH	IL IN MI OH WI	33		
IL - Report of Construction Work Completed.						
260388855 FORM 893 ISS 06-90 S5M22						
1964320	2000	SH	IL IN MI OH WI	33		
IN - Memorandum for Voucher.						

PRODUCT IDENTIFIER		DESCRIPTION				
ITEM NUMBER	ORD. MULT.	SELL UNIT	STD. PKG. STOCK AVAILABILITY / PA	LEAD TIME	MIN. ORD.	A C
FORM 893 2 ISS 06-90						
0003685	200	EA				
IN - Voucher Certificate. INDIANA ONLY.						
FORM 917 ISS 12-83						
0007013	100	EA				
IN - Company Shipping Tag. INDIANA ONLY.						
300070273 FORM 925 ISS 03-90 L15M2C20						
N		SE	950	2	950	
IL - Final Accounts Scheduled for Write-off or Referral.						
280042417 FORM 936 1 ISS 04-82 J65M24						
N		EA	50	4	35000	
260367693 FORM 950 ISS 04-90 L2M20						
N		EA	25	2	25	
200005015 FORM 978 1 ISS 11-84 L25M20						
N		SH	500	2	500	
IL - Advice of Non-negotiable Check.						
200005569 FORM 986 32 J50M21						
N		EA	500	6	50000	
200005775 FORM 986 33 J5M21						
N		EA	250	6	5000	
200005783 FORM 986 34 J5M21						
N		EA	250	6	5000	
200005791 FORM 986 35 J5M21						
N		EA	250	6	5000	
200005809 FORM 986 36 J5M21						
N		EA	250	6	5000	
FORM 998 ISS 07-80						
0006679	25	EA				
IN - Operator Services Office Work Log. INDIANA ONLY.						
FORM 999 3 ISS 04-92						
0006850	100	EA				
IN - Special Weekly Time Report. INDIANA ONLY.						
260449459 FORM 1001 ISS 05-92 S5M20						
N						
ASI - Ameritech Small Business System - Tracking & Fulfillment Form.						
300090859 FORM 1006						
1932293	50	SH	IL IN MI OH WI	33		
IN - Commencement Notice.						
300090867 FORM 1007						
1932301	50	SH	IL IN MI OH WI	33		
IN - Completion Notice.						

DISTRIBUTION SERVICES

NETWORK SERVICES

TOOLS

BUILDING JANITORIAL

AUTOMOTIVE

FORMS/OFFICE SUPPLIES

GENERAL

DATA VOICE

FORM

PRODUCT IDENTIFIER DESCRIPTION

ITEM NUMBER	ORD. MULT.	SELL UNIT	STD. PKG. STOCK AVAILABILITY / PA	LEAD TIME	MIN. ORD.	A C
-------------	------------	-----------	-----------------------------------	-----------	-----------	-----

300032075 FORM 1007 ISS 08-84
 1196873 100 EA IL IN MI OH WI
 33
 IL - Trunk Order Log, Non-Supervising Office.

300032083 FORM 1007 1 ISS 08-84
 5107698 100 EA IL IN MI OH WI
 33
 IL - Trunk Order Log, Supervising Office.

280044322 FORM 1009 J20M24
 N EA 500 6 20000
 WI - Envelope 3 5/8 x 6 1/2in, 500 per box, Milwaukee return address.

280044330 FORM 1009 1 ISS 02-92 J5M24
 N EA 500 6 5000
 WI - Envelope - Small white, black logo.

FORM 1010 ISS 03-77
 0006681 25 EA
 IN - Coin Telephone Cash Compartment Key Tracer. INDIANA ONLY.

401567144 FORM 1012 ISS 02-92 J100M24
 N EA 500 6 100000
 WI - Envelope - White, 4-1/8 X 9-1/2IN.

280044348 FORM 1012 1 ISS 02-92 J25M24
 N EA 50 6 25000
 WI - Envelope - blank return address, logo only.

260379920 FORM 1012 28 ISS 02-92 J15M24
 N EA 500 6 15000
 WI - Envelope - 17950 W. Corporate Drive - 3rd Floor.

280044371 FORM 1012 5 ISS 02-92 J5M24
 N EA 500 6 5000
 WI - Envelope - 804 North Milwaukee Street.

260441456 FORM 1012-29 ISS 02-92 J30M24
 N EA 500 6 30000
 WI - Window Envelope with 17950 Corporate Avenue Address.

FORM 1020 ISS 06-77
 0003695 1 EA
 IN - Envelope Coin Telephone Lock. INDIANA ONLY.

002068674 FORM 1021 ISS 05-82 S3M20
 5650101 500 SH IL IN MI OH WI
 33
 IL - Furniture and Office Equipment Request.

280042433 FORM 1021 A ISS 07-88 J15M24
 N EA 100 4 15000

280044405 FORM 1033 1 ISS 06-90 J100M24
 N EA 500 6 100000

280044413 FORM 1033 2 ISS 01-91 J40M24
 N EA 500 6 40000

DISTRIBUTION SERVICES

NETWORK SERVICES

TOOLS

BUILDING JANITORIAL

AUTOMOTIVE

FORMS/OFFICE SUPPLIES

GENERAL

DATA VOICE

PRODUCT IDENTIFIER DESCRIPTION

ITEM NUMBER	ORD. MULT.	SELL UNIT	STD. PKG. STOCK AVAILABILITY / PA	LEAD TIME	MIN. ORD.	A C
-------------	------------	-----------	-----------------------------------	-----------	-----------	-----

FORM 1034 1,2,3,4,5,6 ISS 02-89
 0006783 1 SE
 IN - Inventory of Account 1220.11. INDIANA ONLY.

260348156 FORM 1034 2 ISS 01-91 J20M24
 N EA 500 6 20000

001060268 FORM 1043 ISS J1M20
 N EA 25 3 1000
 IL - Hinge Tabs - Red.

001060250 FORM 1043 WO-47
 6633701 50 EA IL IN MI OH WI
 33
 IL - Hinge tabs, white.

280042441 FORM 1047 ISS 11-90 L7CM24
 N EA 500 4 700000

280042458 FORM 1047 1 ISS 11-90 J105M24
 N EA 500 4 1050000
 WI - Contact Memorandum - Service Representative.

280042466 FORM 1047 2 ISS 12-84 J7M24
 N SH 500 4 7000

280042474 FORM 1047 3 ISS 05-92 J30M24
 N EA 500 4 30000
 WI - Contact Memorandum - Service Representative.

280051574 FORM 1047 6 ISS 05-86 J300M24
 N EA 500 4 300000

280060716 FORM 1047 7 ISS 05-92 J90M24
 N EA 500 4 90000
 WI - Contact Memorandum - Universal.

200005999 FORM 1047 10 ISS 05-92 J25M24
 N EA 500 4 25000
 WI - Contact Memorandum - Remote Call Forwarding - Toll.

200006005 FORM 1047 11 ISS 05-92 J25M24
 N EA 500 4 25000
 WI - Contact Memorandum - Remote Call Forwarding - Local.

200006013 FORM 1047 12 ISS 05-92 J20M24
 N SH 500 4 20000
 WI - Contact Memorandum - Disconnect Radio Service Representative

200006021 FORM 1047 13 ISS 05-92 J20M24
 N SH 500 4 20000
 WI - Contact Memorandum - Radio Broadcast Lines - Service Representative.

280042508 FORM 1050 ISS 06-74 J20M24
 N SH 500 4 20000

280042516 FORM 1051 ISS 06-74 J25M24
 N SH 500 4 25000

PRODUCT IDENTIFIER							DESCRIPTION						
ITEM NUMBER	ORD. MULT.	SELL UNIT	STD. PKG. STOCK AVAILABILITY / PA	LEAD TIME	MIN. ORD.	A C							
260376371		FORM	1060 2D	J20M21									
N		SE	2000	8	20000		MI - Statement of Public Telephone Commission Drafts Issued.						
001060284		FORM	1063										
5664268	500	SH	IL IN MI OH WI	33			IL - Request for Line Identification, Trapping/Tracing.						
260376959		FORM	1075	ISS 02-90	J1.1M24								
N		EA	30	4	1100								
300099967		FORM	1096	ISS 07-83									
1932319	50	SH	IL IN MI OH WI	33			IN - Construction Force Work Report.						
260357389		FORM	1102	ISS 09-89									
1952812	50	SE	IL IN MI OH WI	33	33		IL - Request for Special Payment/Award Treatment - Cash, Class III.						
0007019	1	EA	FORM 1108 4E	ISS 01-84			IN - Miscellaneous Bill. INDIANA ONLY.						
0003330	1	EA	FORM 1108 4E2	ISS 7-87			IN - Miscellaneous Bill. INDIANA ONLY.						
280061227		FORM	1108 7A	ISS 01-84	S3M22								
1932061	1000	SE	IL IN MI OH WI	33			IN - Miscellaneous Bill.						
260363932		FORM	1110	ISS 10-89	S35M20								
1954354	500	SH	IL IN MI OH WI	33			IL - Directory Assistance Memo.						
300090883		FORM	1120	ISS 10-78									
1932327	50	SH	IL IN MI OH WI	33			IN - Refunds.						
300099975		FORM	1121 C										
1932335	100	SH	IL IN MI OH WI	33			IN - Columnar Ruled Sheet - 14 Columns.						
0006397	25	SH	FORM 1123	ISS 12-80			IN - Statement. INDIANA ONLY.						
260439633		FORM	1127	ISS 07-89	J1CM20								
N		EA	2000	8	100000		IL - Tab Card - Toll & Assistance Billing Ticket (Font).						
200005445		FORM	1128	ISS 04-89	J10M20								
N		EA	2000	6	10000								

PRODUCT IDENTIFIER							DESCRIPTION						
ITEM NUMBER	ORD. MULT.	SELL UNIT	STD. PKG. STOCK AVAILABILITY / PA	LEAD TIME	MIN. ORD.	A C							
260388863		FORM	1131	ISS 06-90	S2M22								
1964338	50	SE	IL IN MI OH WI	33			IN - Request for Cash Advance.						
300090891		FORM	1131	ISS 10-78									
N		SE	50	4	2000		Request For Cash Advance.						
0003125	1	EA	FORM 1136 A				IN - General Ledger for the Year. INDIANA ONLY.						
003007085		FORM	1138	ISS 05-91	J15M20								
N		SH	500	4	15000		IL - CNA* Error Memo.						
260323357		FORM	1143	ISS 04-88									
1943746	25	SH	IL IN MI OH WI	33			IN - Uncollectible Voucher.						
300090917		FORM	1144 B										
1932723	100	SH	IL IN MI OH WI	33			IN - Columnar Ruled Sheet.						
260433172		FORM	1150	ISS 08-91	S1M22								
1979864	50	SE	IL IN MI OH WI	33			IN - Account Inquiry.						
280044421		FORM	1155 E	ISS 06-83	L176M24								
N		EA	500	2	176000		WI - Envelope - Disbursements.						
0003764	100	EA	FORM 1157 C1	ISS 06-91			IN - Request for Directories. INDIANA ONLY.						
0007031	25	SH	FORM 1157 C6	ISS 10-80			IN - Request for Indianapolis & Indianapolis Metro Directory. INDIANA ONLY.						
260412358		FORM	1165	ISS 03-91	J6M24								
N		SE	100	4	6000		Request for Local Call Detail.						
0003126	200	EA	FORM 1186	ISS 06-83			IN - Bill of Sale Accounting Report. INDIANA ONLY.						
001074335		FORM	1187										
5642348	500	SH	IL IN MI OH WI	33			IL - DAS/C Non-Published Log.						
260412341		FORM	1189	ISS 02-91	J3SM24								
N		SH	500	4	35000		Mini Adjustment Form - Wisconsin						

DISTRIBUTION SERVICES
 NETWORK SERVICES
 TOOLS
 BUILDING JANITORIAL
 AUTOMOTIVE
 FORMS/OFFICE SUPPLIES
 GENERAL
 DATA VOICE

FORM

PRODUCT IDENTIFIER		DESCRIPTION					
ITEM NUMBER	ORD. MULT.	SELL UNIT	STD. PKG. STOCK AVAILABILITY / PA	LEAD TIME	MIN. ORD.	A C	
260420146 FORM		1189	ISS 04-91 S3M20				
1974535	3000	SH	IL IN MI OH WI				
			33				
IL - Auth # for Time & Matl/Unit Cost Work With Contractors Under General Agreement.							
300070695 FORM		1205 12	ISS 5-84				
N		SH	5000	2	5000		
IL - Blank Bill Form, 1 Up (Memo Payment).							
200005734 FORM		1205-13	ISS 02-88 L9CM20				
N		SH	5000	2	5000		
260369442 FORM		1206	ISS 02-90				
1955906	500	SH	IL IN MI OH WI				
			33				
IL - Memo to DPO or RPC, canary.							
260390547 FORM		1206 1	ISS 05-90 L20M20				
N		SH	500	2	500		
IL - Memo to DPO.							
300070703 FORM		1213/1213 1	ISS 09-84 20				
N		SH	6000	2	6000		
IL - Referral Notice/Return Referral Stub.							
260368899 FORM		1214	ISS 01-90 S8M20				
1955690	100	SH	IL IN MI OH WI				
			33				
IL - Return Referral Stub.							
260431671 FORM		1217	ISS 09-91 J15M24				
N		SH	100	4	15000		
WI - Nondeniable Notice - RCC.							
260431689 FORM		1217 1	ISS J3M24				
N		SH	100	4	3000		
WI - Nondeniable Notice - BCC.							
260431697 FORM		1217 2	ISS 09-91 J3M24				
N		SH	100	4	3000		
WI - Nondeniable Notice - DS							
260443536 FORM		1219	ISS 03-92 J16C24				
N		BK	100	4	1600		
WI - Driver's Daily Log.							
300090701 FORM		1220	ISS 06-81				
1932749	25	SH	IL IN MI OH WI				
			33				
IN - Returning Incorrect Check to Customer.							
260357165 FORM		1222 1	ISS 05-89				
1952606	20	BK	IL IN MI OH WI				
			33				
IL - Book - Advance Payment - Deposit.							
260392469 FORM		1222 4	ISS 12-84 S50M20				
1966010	25	EA	IL IN MI OH WI				
			33				
IL - Envelope - Customer Receipt (1222-1).							
200005759 FORM		1222 5	ISS 02-88 L20M20				
N		SH	5000	2	5000		
IL - Advance Payment - Deposit (Customers Receipt).							

PRODUCT IDENTIFIER		DESCRIPTION					
ITEM NUMBER	ORD. MULT.	SELL UNIT	STD. PKG. STOCK AVAILABILITY / PA	LEAD TIME	MIN. ORD.	A C	
200006609 FORM		1222 6	ISS 04-88 L40M20				
N		SH	5000	2	5000		
IL - Card - Advance Payment - Deposit.							
280099359 FORM		1226	ISS 07-87				
1937664	10	SH	IL IN MI OH WI				
			33				
IN - Application For Leave of Absence.							
280046319 FORM		1236	ISS 03-92 J30M24				
N		EA	25	6	30000		
WI - Envelope Intra-company Mail, 9-1/2 X 12-1/2IN Company Private.							
280040791 FORM		1244	ISS 01-90 J55M24				
N		SE	100	6	55000		
WI - Classification Attachment.							
280045394 FORM		1244 1, 2315-1, 1-9024					
N		SE	850	6	30000		
WI - Classification Attachment.							
280045386 FORM		1244 2	ISS 07-84 J6M24				
N		SE	1500	6	6000		
WI - Classification Attachment.							
260435557 FORM		1245	ISS 09-91 J5C24				
N		SH	100	4	500		
WI - Time Extension for Payment to Prevent Disconnection of Service.							
260435565 FORM		1245A	ISS 09-91 J5C24				
N		SH	100	4	500		
WI - Permanent Disconnect Notice.							
260438270 FORM		1250	ISS 01-92 J50M6C24				
N		SH	2200	8	50600		
WI - Moore Check Form.							
FORM 1252 E							
0003129	1000	EA					
IN - Authorization of Benefits. INDIANA ONLY.							
001060813 FORM		1257					
5664003	500	EA	IL IN MI OH WI				
			33				
IL - Expense Record Envelope.							
200004547 FORM		1263	ISS 07-78 J3M20				
N		EA	500	6	3000		
IL - Envelope - Paycheck Remail.							
001060821 FORM		1264	ISS 09-77 S36M20				
6673061	500	EA	IL IN MI OH WI				
			33				
IL - Envelope - U.S. Mail, white.							
300099991 FORM		1279 C					
1932772	25	SH	IL IN MI OH WI				
			33				
IN - List of Collections.							
260395306 FORM		1280 QJ-3	J50M21				
N		SE	1250	8	50000		
MI - Custom Teletype.							

DISTRIBUTION SERVICES

NETWORK SERVICES

TOOLS

BUILDING JANITORIAL

AUTOMOTIVE

FORMS/OFFICE SUPPLIES

GENERAL

DATA VOICE

PRODUCT IDENTIFIER		DESCRIPTION				
ITEM NUMBER	ORD. MULT.	SELL UNIT	STD. PKG. STOCK	LEAD TIME AVAILABILITY / PA	MIN. ORD.	A C
260407838	FORM	1291	ISS 01-91	S3M20		
1971028	3000	EA	IL IN MI OH WI	33		
IL - Notification of Mailing Address for Paychecks.						
001060862	FORM	1293				
5666388	500	EA	IL IN MI OH WI	33		
IL - CYR Trouble Record.						
002008597	FORM	1295	5			
5643825	50	SE	IL IN MI OH WI	33		
IL - Purchase Order.						
300081742	FORM	1295	A ISS 11-85			
5125815	50	SE	IL IN MI OH WI	33		
IL - Purchase Order, General Trade Telecommunications Equipment.						
001060896	FORM	1305	ISS 07-81	S30M20		
N		EA	50	6	5000	
260330451	FORM	1305	ISS 07-88			
1946905	500	EA	IL IN MI OH WI	33		
IL - Tag - Like for Like.						
280099367	FORM	1307	ISS 08-87	S20M20		
1937573	500	EA	IL IN MI OH WI	33		
IL - Special Service Order Check Sheet (Pouch).						
001060953	FORM	1330				
5667345	50	SH	IL IN MI OH WI	33		
IL - Work Order - One Section.						
001060979	FORM	1331	2			
5667360	50	SH	IL IN MI OH WI	33		
IL - Work Order - two section.						
001061019	FORM	1332	2			
5667444	50	SH	IL IN MI OH WI	33		
IL - Work Order - two section.						
300029360	FORM	1333	ISS 05-83	S2M20		
5106450	500	SH	IL IN MI OH WI	33		
IL - Joint Work Agreement 8 1/2 X 11IN.						
300029378	FORM	1333	1 ISS 05-83	S2M20		
5106476	500	SH	IL IN MI OH WI	33		
IL - Joint Work Agreement 17 X 11IN.						
280047960	FORM	1334	ISS 12-86	S30M20		
1926733	500	SH	IL IN MI OH WI	33		
IL - Temporary Receipt For Advance Payment/Deposits.						

PRODUCT IDENTIFIER		DESCRIPTION				
ITEM NUMBER	ORD. MULT.	SELL UNIT	STD. PKG. STOCK	LEAD TIME AVAILABILITY / PA	MIN. ORD.	A C
001047828	FORM	1337	1			
5600163	50	SH	IL IN MI OH WI	33		
IL - Work Order 13 X 17IN Reduces to 8 1/2 X 11IN.						
001047836	FORM	1337	3			
5600288	50	SH	IL IN MI OH WI	33		
IL - Work Order 26 X 17IN.						
001047844	FORM	1337	5			
5600346	50	SH	IL IN MI OH WI	33		
IL - Work Order 26 X 17IN.						
280061003	FORM	1338	ISS 07-84	S2M22		
1932780	25	SE	IL IN MI OH WI	33		
IN - Transfer Report.						
001061092	FORM	1339	S25M20			
5667147	500	EA	IL IN MI OH WI	33		
IL - Envelope W/Logo. No address window, white wove 9-1/2 X 4-1/8IN.						
	FORM	1345	10D			
0003135	50	EA	IN - Commercial mailing envelope - Evansville. INDIANA ONLY.			
260446158	FORM	1347	ISS 04-92	S3M20		
N		SH	500	1	3000	
IL - Engineering Authorized Change.						
001159466	FORM	1350	1 ISS 10-65	J5C20		
N		SH	50	4	500	
Plant Location Record-Exchange Cable.						
001159474	FORM	1350	2 ISS 10-65	J5C20		
N		SH	50	4	500	
Plant Location Record-UG Cable.						
001159482	FORM	1350	3 ISS 01-70	J5C20		
N		SH	50	4	500	
Plant Location Record-Conduit.						
001159490	FORM	1350	4 ISS 10-65	J5C20		
N		SH	50	4	500	
Plant Location Record-PLR-1.						
001159508	FORM	1350	6 ISS 10-65	J25020		
N		SH	50	4	250	
Plant Location Record-Sheath (State).						
001061167	FORM	1351				
5667162	500	SH	IL IN MI OH WI	33		
Work Assignment.						
	FORM	1353	10D			
0003132	500	EA	IN - Envelope - Evansville 6 1/2In x 3 5/8in white. INDIANA ONLY.			

DISTRIBUTION SERVICES
 NETWORK SERVICES
 TOOLS
 BUILDING JANITORIAL
 AUTOMOTIVE
 FORMS/OFFICE SUPPLIES
 GENERAL
 DATA VOICE

FORM

DISTRIBUTION SERVICES

PRODUCT IDENTIFIER		DESCRIPTION				
ITEM NUMBER	ORD. MULT.	SELL UNIT	STD. PKG. STOCK AVAILABILITY / PA	LEAD TIME	MIN. ORD.	A C
FORM 1353 14D ISS08-87						
0003134	500	EA				
IN - Envelope - Kokomo 6 1/2in x 3 5/8in white. INDIANA ONLY.						

NETWORK SERVICES

PRODUCT IDENTIFIER		DESCRIPTION				
ITEM NUMBER	ORD. MULT.	SELL UNIT	STD. PKG. STOCK AVAILABILITY / PA	LEAD TIME	MIN. ORD.	A C
280024191 FORM 1353 1C ISS 05-84						
1932798	500	EA	IL IN MI OH WI	33		
IN - Envelope - Indianapolis - 240 - 6 1/2 X 3 5/8IN, white.						
FORM 1353 20D						
0003136	500	EA				
IN - Envelope Muncie 6 1/2IN X 3 5/8IN white. INDIANA ONLY.						

TOOLS

PRODUCT IDENTIFIER		DESCRIPTION				
ITEM NUMBER	ORD. MULT.	SELL UNIT	STD. PKG. STOCK AVAILABILITY / PA	LEAD TIME	MIN. ORD.	A C
FORM 1353 21B						
0003137	500	EA				
IN - Envelope New Albany 6-1/2IN X 3-5/8IN white. INDIANA ONLY.						
FORM 1353 25C						
0003139	500	EA				
IN - Envelope South Bend 6-1/2IN X 3-5/8IN white. INDIANA ONLY.						

BUILDING JANITORIAL

PRODUCT IDENTIFIER		DESCRIPTION				
ITEM NUMBER	ORD. MULT.	SELL UNIT	STD. PKG. STOCK AVAILABILITY / PA	LEAD TIME	MIN. ORD.	A C
280024209 FORM 1353 2B ISS 06-84						
1932806	500	EA	IL IN MI OH WI	33		
IN - Outstate envelope, 6 1/2 X 3 5/8IN, 500 per box.						
280024217 FORM 1353 43 ISS 05-84						
1932814	500	EA	IL IN MI OH WI	33		
IN - Envelope - Indianapolis 220, 6 1/2 X 3 5/8IN, white.						

AUTOMOTIVE

PRODUCT IDENTIFIER		DESCRIPTION				
ITEM NUMBER	ORD. MULT.	SELL UNIT	STD. PKG. STOCK AVAILABILITY / PA	LEAD TIME	MIN. ORD.	A C
FORM 1354 10 ISS 08-88						
0003146	500	EA				
IN - Envelope Kokomo 9-1/2IN X 4-1/8IN white. INDIANA ONLY.						
FORM 1354 10 ISS 08-88						
0003144	500	EA				
IN - Envelope Evansville commercial mailing. INDIANA ONLY.						

FORMS/OFFICE SUPPLIES

PRODUCT IDENTIFIER		DESCRIPTION				
ITEM NUMBER	ORD. MULT.	SELL UNIT	STD. PKG. STOCK AVAILABILITY / PA	LEAD TIME	MIN. ORD.	A C
280024225 FORM 1354 1E ISS 01-84						
1932830		EA	IL IN MI OH WI	33		
FORM 1354 20E						
0003147	500	EA				
IN - Envelope Muncie 9-1/2IN X 4-1/8IN white. INDIANA ONLY.						
FORM 1354 21B						
0003148	500	EA				
IN - Envelope New Albany 9-1/2IN X 4-1/8IN white. INDIANA ONLY.						

GENERAL

PRODUCT IDENTIFIER		DESCRIPTION				
ITEM NUMBER	ORD. MULT.	SELL UNIT	STD. PKG. STOCK AVAILABILITY / PA	LEAD TIME	MIN. ORD.	A C
280024241 FORM 1354 25C ISS01-84						
1932848	500	EA	IL IN MI OH WI	33		
IN - Envelope - South Bend.						

DATA VOICE

PRODUCT IDENTIFIER		DESCRIPTION				
ITEM NUMBER	ORD. MULT.	SELL UNIT	STD. PKG. STOCK AVAILABILITY / PA	LEAD TIME	MIN. ORD.	A C
280024233 FORM 1354 2B ISS 01-84						
1932822	500	EA	IL IN MI OH WI	33		
IN - Envelope - Outstate. 9 1/2 X 4 1/8IN, white.						
FORM 1354 36B						
0003151	500	EA				
IN - Envelope Indianapolis South 9-1/2IN X 4-1/8IN white. INDIANA ONLY.						
FORM 1354 40B ISS10-80						
0003152	500	EA				
IN - Envelope Mishawaka 9-1/2IN X 4-1/8IN white. INDIANA ONLY.						
280024258 FORM 1354 43 ISS 01-84						
1932855	500	EA	IL IN MI OH WI	33 33		
IN - Envelope - Indianapolis. 9 1/2 X 4 1/8IN, white.						
FORM 1354 45 ISS 01-88						
0003154	500	EA				
IN - Envelope Hammond 9-1/2IN X 4-1/8IN white, 7220 Kennedy. INDIANA ONLY.						
300100005 FORM 1358 A						
1932863	100	SH	IL IN MI OH WI	33		
IN - Columnar Ruled Sheet - 7 columns.						
001035146 FORM 1372						
1159889	50	EA	IL IN MI OH WI	33		
Envelope.						
300070877 FORM 1375 ISS 10-90 L5M6C20						
N		SH	800	2	800	
IL - Service Order Number Labels.						
300035995 FORM 1396 ISS 09-84						
5109124	500	SH	IL IN MI OH WI	33		
Follow Up Trouble Report Employee Caused.						
001035153 FORM 1397 1L J12M21						
N		SE	100	8	12000	
MI - Transfer Report.						
280079468 FORM 1400 5 ISS 09-87						
1936096	1800	SH	IL IN MI OH WI	33		
IL - Universal Service Order - (Pre-Completion File Copy for Input Work).						
300070935 FORM 1400 7 ISS 10-85 S353M20						
5127233	1500	SE	IL IN MI OH WI	33		
IL - Universal Service Order - Special Service Order.						
300070943 FORM 1400 8 ISS 03-82 12MM2C20						
5127258	2800	SH	IL IN MI OH WI	33		
IL - Universal Service Order (Network Services FRA-MNS Post Completion).						

PRODUCT IDENTIFIER		DESCRIPTION					
ITEM NUMBER	ORD. MULT.	SELL UNIT	STD. PKG. STOCK AVAILABILITY / PA	LEAD TIME		MIN. ORD.	A C
300071016 FORM 1400 19 ISS 03-81 20							
5127332	2800	SH	IL IN MI OH WI 33				
IL - Universal Service Order (Installation BISCOM/DACS POST COMPLETION).							
300070901 FORM 1400 2A ISS 12-82 S165M20							
5127175	1500	SE	IL IN MI OH WI 33				
IL - Universal Service Order (ESS Conversion).							
300071065 FORM 1400 50B ISS 01-80 S150M20							
1169318	2200	SH	IL IN MI OH WI 33				
IL - Universal Service Order, Special Service Bureau.							
260314711 FORM 1400 70 ISS 12-87 S55M20							
1940890	1000	SE	IL IN MI OH WI 33				
IL - Monitor - Universal Service Order.							
001061514 FORM 1406							
5616706	500	SH	IL IN MI OH WI 33				
Notice of Non-Negotiable Check.							
300090727 FORM 1410 A ISS 03-85							
1932871	100	SH	IL IN MI OH WI 33				
IN - Request for Pole Facilities.							
FORM 1410 GH ISS 11-77							
0003157	1000	EA					
IN - Request for Pole Facilities Joint Construction. INDIANA ONLY.							
300090735 FORM 1411 ISS 08-85							
1932889	50	SH	IL IN MI OH WI 33				
IN - Request For CATV Facility Rearrangement.							
001061530 FORM 1414							
6370767	1000	SH	IL IN MI OH WI 33				
Label, HCK designation strip, sheet 15.							
001061548 FORM 1416							
6381343	500	SH	IL IN MI OH WI 33				
IL - Service Order Memo.							
300071438 FORM 1420 1							
N							
001061597 FORM 1422 3 ISS 01-83							
6642660	500	SH	IL IN MI OH WI 33				
3 Payment Receipt.							
280047986 FORM 1422 4 ISS 08-80 S20							
1926873	5400	SH	IL IN MI OH WI 33				
IL - Mechanized Customer Payment Receipt, Teller.							

PRODUCT IDENTIFIER		DESCRIPTION					
ITEM NUMBER	ORD. MULT.	SELL UNIT	STD. PKG. STOCK AVAILABILITY / PA	LEAD TIME		MIN. ORD.	A C
002089175 FORM 1422 10 ISS 01-83							
5655928	1000	SH	IL IN MI OH WI 33				
Memo Payment Page.							
002089183 FORM 1422 11 ISS 01-83 S150M20							
5655944	100	SE	IL IN MI OH WI 33				
IL - Memo Payment Page, Receipt Attached.							
200002665 FORM 1422 N J6M21							
N		EA	500	6	6000		
Envelope.							
001021369 FORM 1445 ISS 12-71 S2M20							
6604926	500	SH	IL IN MI OH WI 33				
IL - Bi-Weekly Time Record.							
280042532 FORM 1445 A ISS 11-79 J3M24							
N		SH	500	4	3000		
001050954 FORM 1451 A							
1159962	100	EA	IL IN MI OH WI 33				
Envelope.							
260339544 FORM 14521AM ISS 11-88 S20							
1949099	100	EA	IL IN MI OH WI 33				
IL - Envelope - Material Ticket.							
001061670 FORM 1458 ISS 01-74 S5M20							
6610428	500	SH	IL IN MI OH WI 33				
IL - Request For Service Order.							
300071644 FORM 1460 ISS 07-85 L130M20							
N		SH	3000	2	3000		
IL - Letter-head, Accounts Collection Center.							
300076569 FORM 1460 1 ISS 09-85 J12M20							
N		SH	3000	8	12000		
IL - Letter-head, Miscellaneous Billing.							
200005361 FORM 1460 2 ISS 06-88 L1CM20							
N		EA	500	2	500		
IL - Envelope - US Mail - 9 1/2 x 4 1/8 White.							
260449442 FORM 1463 ISS 05-92 S100M20							
N							
WI - Stationary - Company Logo, no address. 8-1/2 X 11IN.							
260384920 FORM 1463 2 ISS 06-90 S30M20							
1962738	5000	EA	IL IN MI OH WI 33				
IL - Envelope - Company Signature with no address, 7 1/2in x 3 7/8in.							
280024266 FORM 1487 1B ISS 06-84							
1932897	500	EA	IL IN MI OH WI 33				
IN - Envelope - Indianapolis 240. 12 1/2 X 9 1/2IN Kraft.							

DISTRIBUTION SERVICES

NETWORK SERVICES

TOOLS

BUILDING JANITORIAL

AUTOMOTIVE

FORMS/OFFICE SUPPLIES

GENERAL

DATA VOICE

FORM

DISTRIBUTION SERVICES

PRODUCT IDENTIFIER		DESCRIPTION						
ITEM NUMBER	ORD. MULT.	SELL UNIT	STD. PKG.	LEAD TIME			MIN. A	A
			STOCK AVAILABILITY / PA				ORD.	C
280024274 FORM		1487 2B ISS 06-84						
1932905	500	EA	IL	IN	MI	OH	WI	
			33					
IN - Envelope - Outstate. 12 1/2 X 9 1/2 IN Kraft.								
001061761 FORM		1496						
1142216	500	SH	IL	IN	MI	OH	WI	
			33					
IL - Outside Plant Estimating Sheet.								

NETWORK SERVICES

FORM 1497 A									
0007051	100	EA							
IN - Unsafe Plant Report. INDIANA ONLY.									

TOOLS

260339437 FORM		1510 ISS 10-88						
1949040	50	SE	IL	IN	MI	OH	WI	
			33					
IL - Dishonored Check Recharge Memo.								

BUILDING JANITORIAL

300071545 FORM		1510 1 ISS 04-88 L60M20						
N		SE	3200	2			3200	
IL - Dishonored Check Recharge Memo - RPC -2 Sheets per set.								

200005502 FORM		1512 ISS 04-73 J3M20						
N		SE	50	8			3000	
IL - Intra Company Tape Transmittal.								

001035195 FORM		1514 K						
1160069	500	SE	IL	IN	MI	OH	WI	
			33					
MI - Cash Advance Authority and Transmittal.								

AUTOMOTIVE

200004570 FORM		1562 ISS 10-88 J15M20						
N		EA	500	6			15000	
IL - Envelope 9 1/8 x 4 1/2 For Mailing Auditor's Verification Notice.								

FORM 1570 ISS 06-84									
0005361	25	EA							
IN - Circuit Layout Correction Notice. INDIANA ONLY.									

260446133 FORM		1617 1 ISS 04-92 L2M20						
N		BK	10	1			10	
IL - Book - Chicago North Work Assignment.								

260443106 FORM		1617 A ISS 03-92 S20M20						
N		EA	10	4			20000	
IL - BOOK - Repair Work Assignment.								

FORMS/OFFICE SUPPLIES

300093507 FORM		1631 ISS 08-84 S12M22						
1932913	50	SH	IL	IN	MI	OH	WI	
			33					
IN - Directory Requisition.								

GENERAL

280044439 FORM		1641						
N		EA	500	6			75000	

280044470 FORM		1641 E						
N		EA	500	6			25000	

280093279 FORM		1641 F ISS 09-88 J7M24						
N		EA	500	6			10000	

DATA VOICE

PRODUCT IDENTIFIER		DESCRIPTION							
ITEM NUMBER	ORD. MULT.	SELL UNIT	STD. PKG.	LEAD TIME			MIN. A	A	
			STOCK AVAILABILITY / PA				ORD.	C	
FORM 1642 3A									
0005351	25	EA							
IN - Summary of Interstate Toll Business. INDIANA ONLY.									
FORM 1642 3B									
0005352	25	EA							
IN - Summary of Indiana Toll Business. INDIANA ONLY.									
FORM 1653									
0005353	25	EA							
IN - Control of Miscellaneous Account Receivable. INDIANA ONLY.									

300090784 FORM		1657 ISS 08-85						
1932962	25	SE	IL	IN	MI	OH	WI	
			33					
IN - Directory Error Report.								

280040809 FORM		1662 ISS 01-84 J10M24						
N		SE	50	6			10000	
WI - Speed Letter.								

300090792 FORM		1680 ISS 01-86						
1933812	50	SH	IL	IN	MI	OH	WI	
			33					
IN - Authorization For Fixed Expenditure.								

001130798 FORM		1688 S2M20						
5621987	500	SH	IL	IN	MI	OH	WI	
			33					
IL - Residence Service Agreement to Reassign Tel# At Same Location.								

260393103 FORM		1689 5D ISS 08-90 S3M22						
1966085	3000	SH	IL	IN	MI	OH	WI	
			33					
IN - Memorandum Order - Stock Items Only.								

300093515 FORM		1689 5D ISS 12-84						
N		SH	25	4			3000	
Memorandum Order, Stock Items Only.								

280044488 FORM		1697 ISS 01-84						
N		EA	250	6			10000	

FORM 1704 C									
0007065	25	EA							
IN - Life Insurance Payroll Deduction Plan Authorization. INDIANA ONLY.									

FORM 1704 C								
0007065								
IN - Life Insurance Payroll Deduction Plan Authorization. INDIANA ONLY.								

003007390 FORM		1712 ISS 07-80 J5M20						
N		EA	500	4			5000	
IL - DAS/C Discrepancies.								

FORM 1714 ISS 02-89									
0007714	25	SE							
IN - Motor Vehicle Usage & Trouble Report. INDIANA ONLY.									

DISTRIBUTION SERVICES

NETWORK SERVICES

TOOLS

BUILDING JANITORIAL

AUTOMOTIVE

FORMS/OFFICE SUPPLIES

GENERAL

DATA VOICE

PRODUCT IDENTIFIER		DESCRIPTION					
ITEM NUMBER	ORD. MULT.	SELL UNIT	STD. PKG. STOCK AVAILABILITY / PA	LEAD TIME	MIN. ORD.	A	C
FORM		1731	ISS 07-76				
0007067	100	EA	IN - Topical Index Card. INDIANA ONLY.				
300090545 FORM		1738	ISS 05-83				
1932996	50	SH	IL IN MI OH WI	33	IN - Miscellaneous Billing Authority.		
FORM		1738 2	ISS 06-79				
0005358	25	EA	IN - Billing Against Indianapolis Power & Light Company. INDIANA ONLY.				
260330097 FORM		1738 3	ISS 06-88				
1946806	50	SH	IL IN MI OH WI	33	IN - Miscellaneous Billing Authority.		
300090560 FORM		1750 1C	S5M22				
1933002	100	SH	IL IN MI OH WI	33	IN - Job Order.		
260440953 FORM		1754	ISS 02-92 S15M20				
N		EA	200	4	15000	IL - Telephone Service Including Any Directory Advertising (Change of Lessee).	
002077683 FORM		1778	ISS 08-82				
5651083	50	SE	IL IN MI OH WI	33	IL - Order for Identification Work.		
300090578 FORM		1794	ISS 08-85				
N		SH	25	4	5000	Authorization for Wage Loan & Special Wage Payments.	
260432638 FORM		1794	ISS 10-91 S5M22				
1979377	25	SH	IL IN MI OH WI	33	IN - Authorization for Wage Loans, Early Checks and Special Wage Payments.		
260369327 FORM		1821	ISS 01-90 S2M20				
1955815	500	SH	IL IN MI OH WI	33	IL - Report of Damage To Property of Others.		
300093523 FORM		1826					
1933820	100	SH	IL IN MI OH WI	33	IN - Company Memo Pad.		
260380027 FORM		1832	ISS 05-90				
1960534	50	SE	IL IN MI OH WI	33	IL - Commercial Print Purchasing Work Order.		
200006088 FORM		1833 3	ISS 05-89 L1M1L20				
N		SH	3000	2	3000	IL - Service & Equipment Record - Ply.	
002074573 FORM		1838	ISS 09-82				
5650804	500	SH	IL IN MI OH WI	33	IL - Summary of Counter Collections.		

PRODUCT IDENTIFIER		DESCRIPTION					
ITEM NUMBER	ORD. MULT.	SELL UNIT	STD. PKG. STOCK AVAILABILITY / PA	LEAD TIME	MIN. ORD.	A	C
002022481 FORM		1858					
5645267	500	SH	IL IN MI OH WI	33	IL - Disciplinary Record.		
280052044 FORM		1860	ISS 12-86				
1927418	500	SH	IL IN MI OH WI	33	IL - Report of CWA (District 4 App B & C) or IBEW Union Grievance.		
260389580 FORM		1861	ISS 08-90 S12M20				
1965145	500	SH	IL IN MI OH WI	33	IL - Quality Sample Aerial Service.		
260389598 FORM		1862	ISS 08-90 S12M20				
1965152	500	SH	IL IN MI OH WI	33	IL - Quality Sample Underground & Buried Service.		
260389606 FORM		1863	ISS 08-90 S5M20				
1965160	500	SH	IL IN MI OH WI	33	IL - Quality Sample Summary.		
FORM		1912 6					
0007074	100	EA	IN - Biscorn Service Order Memo. INDIANA ONLY.				
FORM		1912 SP					
0003183	100	PD	IN - Contact Memo. INDIANA ONLY.				
280062118 FORM		1925 D					
1934737	100	SH	IL IN MI OH WI	33	IN - Vellum Drafting Form, Size A.		
001062520 FORM		1942 1					
5617746	500	SH	IL IN MI OH WI	33	IL - Questioned Order Memo.		
260331640 FORM		1998	ISS 08-88 S10M20				
1947382	10000	SE	IL IN MI OH WI	33	IL - Restoral Charge Memo.		
260395546 FORM		2004	ISS 10-90 S6M20				
1966861	500	SH	IL IN MI OH WI	33	IL - Report of Damage to Property of Company.		
FORM		2008 F	ISS 09-90				
0007079	1	EA	IN - Ameritech Employee Information System Direct Deposit. INDIANA ONLY.				
280071424 FORM		2026	ISS 05-87 S85M20				
1935098	500	EA	IL IN MI OH WI	33	IL - Notice - Sorry We Missed You.		

DISTRIBUTION SERVICES

FORM

PRODUCT IDENTIFIER		DESCRIPTION					
ITEM NUMBER	ORD. MULT.	SELL UNIT	STD. PKG. STOCK	PKG. AVAILABILITY / PA	LEAD TIME	MIN. ORD.	A C
260322847	FORM	2028	ISS 02-88				
1943183	500	EA	IL IN MI OH WI				
			33				
			IL - Label - Circuit Identification.				

NETWORK SERVICES

0003193	FORM	2029 1	ISS 03-87				
	500	EA					
			IN - Application Record I. INDIANA ONLY.				
0003194	FORM	2029 2	ISS 04-88				
	500	EA					
			IN - Application Record II. INDIANA ONLY.				

TOOLS

5618223	FORM	2033	ISS 01-80	S10M20			
	500	EA	IL IN MI OH WI				
			33				
			IL - Envelope - Loop Assignment Center-Hour Log.				
5655308	FORM	2036	ISS 03-83	S5M20			
	500	SH	IL IN MI OH WI				
			33				
			IL - Denial of Service Work Order Request (DN).				

BUILDING JANITORIAL

280044504	FORM	2040					
N		EA	25	6	15000		
260363486	FORM	2045	ISS 12-83	A35M23			
N		EA	500	2	500		
0006851	FORM	2068 B					
	200	EA					
			INDIANA ONLY.				

AUTOMOTIVE

1933036	FORM	2069	ISS 03-86				
	50	SH	IL IN MI OH WI				
			33				
			IN - Teller's Daily Balance Sheet.				
1933044	FORM	2072	ISS 08-84				
	100	SH	IL IN MI OH WI				
			33				
			IN - Project Notice.				

FORMS/OFFICE SUPPLIES

260363536	FORM	2088	ISS 01-90	A20M23			
N							
0007709	FORM	2093 R	ISS 12-84				
	1	EA					
			IN - US Savings Bond Enrollment Card. INDIANA ONLY.				
260363544	FORM	2096	ISS 06-90	A100M23			
N		EA	25000	2	25000		
0007085	FORM	2101	ISS 12-78				
	25	EA					
			IN - Service Order Memo to Comptrollers. INDIANA ONLY.				

GENERAL

1933051	FORM	2132 2B	ISS 01-87				
	500	EA	IL IN MI OH WI				
			33				
			IN - Envelope - Night Payment 7 X 4 1/8IN Kraft.				

DATA VOICE

PRODUCT IDENTIFIER		DESCRIPTION					
ITEM NUMBER	ORD. MULT.	SELL UNIT	STD. PKG. STOCK	PKG. AVAILABILITY / PA	LEAD TIME	MIN. ORD.	A C
260363593	FORM	2151	ISS 05-72	A2M23			
N		EA	500	2	500		
200004851	FORM	2175 1	ISS 09-84	J10M2C20			
N		EA	600	6	10200		
			IL - Envelope from Micrographics - Northcenter - 2401 W. Grace Tyvek.				
200004869	FORM	2175 2	ISS 09-84	J10M2C20			
N		EA	600	8	10200		
			IL - Envelope - From Micrographics - Marquette Park - 3206 W. 61st St. - Tyvek Matl.				
200004877	FORM	2175 3	ISS 09-84	J10M2C20			
N		EA	600	6	10200		
			IL - Envelope - From Micrographics - Springfield - 529 S. 7th St Tyvek.				
200004885	FORM	2176 1	ISS 09-84	J8M4C20			
N		EA	200	6	8400		
			IL - Envelope - From Micrographics - Northcenter - 2401 W. Grace.				
200004893	FORM	2176 2	ISS 09-84	J8M4C20			
N		EA	200	6	8400		
			IL - Envelope - From Micrographics - Marquette Park - 3206 W. 61st St.				
200004901	FORM	2176 3	ISS 09-84	J8M4C20			
N		EA	200	6	8400		
			IL - Envelope - From Micrographics - Springfield - 529 S. 7th Street.				
200004919	FORM	2177 1	ISS 09-84	J17M20			
N		EA	1000	6	17000		
			IL - Envelope - From Micrographics - Northcenter - 2401 W. Grace Tyvek.				
0003197	FORM	2185	ISS 06-84				
	1000	EA					
			IN - Special Service Request. INDIANA ONLY.				
1933069	FORM	2206 C	ISS 05-79				
	25	SH	IL IN MI OH WI				
			33				
			IN - Report of Minor Injury.				
1933077	FORM	2215 C	ISS 01-84				
	500	EA	IL IN MI OH WI				
			33				
			IN - Envelope - Expanding.				
0003741	FORM	2218	ISS 03-89				
	500	EA					
			IN - Envelope Employment Office Business Reply. INDIANA ONLY.				
0007090	FORM	2225	ISS 09-90				
	1	EA					
			IN - Comprehensive Health Care Plan. INDIANA ONLY.				
0003094	FORM	2244	ISS 07-87				
	1000	SH					
			IN - Payroll Checks Cashed at Service Desk. INDIANA ONLY.				

PRODUCT IDENTIFIER DESCRIPTION

ITEM NUMBER	ORD. MULT.	SELL UNIT	STD. PKG. STOCK AVAILABILITY / PA	LEAD TIME	MIN. ORD.	A C
-------------	------------	-----------	-----------------------------------	-----------	-----------	-----

FORM 2253 ISS 04-82
 0003199 1000 SH
 IN - Envelope - Benefit Committee - 8-7/8IN X 3-7/8IN. INDIANA ONLY.

FORM 2258 2 ISS 12-80
 0007093 50 SH
 IN - Key System Worksheet. INDIANA ONLY.

FORM 2265 ISS 05-80
 0003203 500 EA
 IN - Paycheck Mailing Envelope. INDIANA ONLY.

280024308 FORM 2290 ISS 01-84
 1933085 100 EA IL IN MI OH WI
 33
 IN - Envelope - Coin Box Overflow. 5 1/2 X 3 1/8IN.

FORM 2305 B ISS -69
 0005375 25 EA
 IN - Choice of Hours. INDIANA ONLY.

280040825 FORM 2315 ISS 01-88 J25M24
 N SE 100 6 25000
 WI - Payment Authorization and Approval.

FORM 2317 ISS 02-86
 0006947 25 EA
 IN - Engineering Work Report - Weekly. INDIANA ONLY.

300090404 FORM 2318
 1933093 100 SH IL IN MI OH WI
 33
 IN - Work Schedule.

280042599 FORM 2321 ISS 08-91 J20M24
 N SH 500 4 20000
 WI - Memo - 1 Part.

280042607 FORM 2321 1 ISS 08-91 J40M24
 N EA 500 4 40000
 WI - Memo, 2-part.

280024316 FORM 2327 C ISS 01-84
 1933101 100 EA IL IN MI OH WI
 33
 IN - Envelope - Business Office Records. 5 1/4 X 8IN Kraft.

001051994 FORM 2338 H
 N EA 500 6 10000
 Envelope.

FORM 2365 C
 0007100 50 EA
 IN - Employee's Service Record. INDIANA ONLY.

260358148 FORM 2366 ISS 05-89
 1953026 500 EA IL IN MI OH WI
 33
 IN - Envelope - Pay Check 7 3/4 X 3 11/16IN.

PRODUCT IDENTIFIER DESCRIPTION

ITEM NUMBER	ORD. MULT.	SELL UNIT	STD. PKG. STOCK AVAILABILITY / PA	LEAD TIME	MIN. ORD.	A C
-------------	------------	-----------	-----------------------------------	-----------	-----------	-----

FORM 2378 A
 0007103 1 EA
 IN - Memo for Directory. INDIANA ONLY.

260393111 FORM 2384 ISS 11-90 A15M22
 1966093 25 SE IL IN MI OH WI
 33
 Management Time Report.

FORM 2384 B ISS 05-90
 0003752 200 SE
 IN - Management Time Report-Retired. INDIANA ONLY.

FORM 2384 C ISS 11-90
 0003759 200 EA
 IN - Part Time & Occasional Management Time Sheet. INDIANA ONLY.

FORM 2427 ISS 12-78
 0005382 25 EA
 IN - Authorization for Use of Employee Owned Vehicle. INDIANA ONLY.

200004638 FORM 2433 ISS 08-88 J3M20
 N EA 50 6 3000
 IL - Envelope - Employee Remittance Statement - 7 7/8 X 3 7/8IN.

300090438 FORM 2444 ISS 02-81
 1933135 50 SH IL IN MI OH WI
 33
 IN - Cash Discrepancy Authorization.

300093564 FORM 2451 B ISS 09-75
 1933143 50 SH IL IN MI OH WI
 33
 IN - Request For Special Consideration.

300090446 FORM 2464
 1933150 100 SH IL IN MI OH WI
 33
 IN - Report of Payments to Indiana Bell Telephone Co. Inc.

FORM 2476 A
 0006867 100 EA
 IN - Office Programs. INDIANA ONLY.

FORM 2491 2D ISS 08-87
 0005385 25 EA
 IN - Voucher Check Transmittal. INDIANA ONLY.

002074599 FORM 2501
 5650762 50 SE IL IN MI OH WI
 33
 IL - Report of Collections and Deposits.

FORM 2522 ISS 12-80
 0005386 25 EA
 IN - Weekly Program of Supervisory Activities. INDIANA ONLY.

FORM 2540 ISS 12-80
 0005386 25 EA
 IN - Weekly Program of Supervisory Activities. INDIANA ONLY.

DISTRIBUTION SERVICES

NETWORK SERVICES

TOOLS

BUILDING JANITORIAL

AUTOMOTIVE

FORMS/OFFICE SUPPLIES

GENERAL

DATA VOICE

FORM

DISTRIBUTION SERVICES

PRODUCT IDENTIFIER		DESCRIPTION					
ITEM NUMBER	ORD. MULT.	SELL UNIT	STD. PKG. STOCK AVAILABILITY / PA	LEAD TIME	MIN. ORD.	A C	

280024332 FORM 2548 1F ISS 01-87
 1933184 100 EA IL IN MI OH WI
 33
 IN - Envelope - Disbursement. 9 1/2 X 12 1/2IN, green.

NETWORK SERVICES

280024340 FORM 2548 2E ISS 01-87
 1933192 100 EA IL IN MI OH WI
 33
 IN - Envelope - Disbursement 9 1/2 X 12 1/2IN, blue.

TOOLS

280024357 FORM 2548 3C ISS 01-87
 1933200 100 EA IL IN MI OH WI
 33
 IN - Envelope - Disbursement 9 1/2 X 12 1/2IN, yellow.

280061243 FORM 2548 4D ISS 01-87
 1931907 100 EA IL IN MI OH WI
 33
 IN - Envelope - Disbursement 9 1/2 X 12 1/2IN, pink.

BUILDING JANITORIAL

FORM 2561 B
 0007117 100 EA
 IN - Net Loss, Detail Sheet. INDIANA ONLY.

280060765 FORM 2565 D
 1933838 25 SH IL IN MI OH WI
 33
 IN - Transmittal Sheet.

280061250 FORM 2575 ISS 03-80
 1931923 25 SE IL IN MI OH WI
 33
 IN - Job Order Progress Memo.

AUTOMOTIVE

FORM 2594
 0006921 100 EA
 IN - Hours Overtime Worked. INDIANA ONLY.

FORMS/OFFICE SUPPLIES

300071842 FORM 2611 4 ISS 07-91 J17M20
 N SH 1500 6 17000
 IL - Voucher Check (Harris Bank, Roselle).

300071867 FORM 2611 10 ISS 10-90 L56M20
 N SE 25 2 56000
 IL - Field Draft - Continuous Form (Seaway National Bank).

260403175 FORM 2611 10C ISS10-90 L20
 N SE 1500 2 1500
 Field Draft - Continuous Form (Seaway Natl Bank).

300071875 FORM 2611 21 ISS 01-89 L214M20
 N SH 3200 2 3200
 IL - Sealmate Payroll Check.

GENERAL

280051509 FORM 2611 21R ISS 07-86 J17C20
 N SH 1700 6 1700
 Sealmate Payroll Check - Replacement.

DATA VOICE

280051491 FORM 2611 21S ISS 07-86 J34C20
 N SH 1700 6 3400
 IL - Sealmate Check Special 'S'.

PRODUCT IDENTIFIER		DESCRIPTION					
ITEM NUMBER	ORD. MULT.	SELL UNIT	STD. PKG. STOCK AVAILABILITY / PA	LEAD TIME	MIN. ORD.	A C	

300071883 FORM 2611 23 ISS 07-87 J2M20
 N SH 2000 6 2000
 IL - Security Department Account (The Northern Trust Company).

300071941 FORM 2611 65 ISS 10-89 L1CM20
 N SH 3200 2 3200
 IL - Refund/Commission - American National Bank & Trust Company.

260403159 FORM 2611 90B ISS 12-90 J5M20
 N SH 5000 2 5000
 IL - Check Header Card Blue.

260403167 FORM 2611 90Y ISS 12-90 J5M20
 N SH 5000 6 5000
 IL - Check Header Card Yellow.

200004620 FORM 2617 ISS 03-80 L5M20
 N EA 500 2 500
 IL - Envelope - Coin Telephone Cash Compartment Lock & Key.

001085752 FORM 2618
 5636783 1000 SH IL IN MI OH WI
 33
 IL - RCMAC Action Memo.

002083442 FORM 2618 2 ISS 01-83
 5652743 100 SE IL IN MI OH WI
 33
 IL - RCMAC Action Memo, Customer Trouble Report and Special Studies.

260440466 FORM 2644 ISS 01-92 S60M20
 N SH 500 4 60000
 IL - Adjustment Voucher.

200005031 FORM 2644 1 ISS 09-86 L20M20
 N SH 250 2 250
 IL - CABS - Adjustment Voucher.

260369434 FORM 2644 3 ISS 01-90
 1955898 250 SH IL IN MI OH WI
 33
 IL - IPAS Adjustment Voucher.

001161264 FORM 2646 2 ISS 07-74 J5M20
 N EA 500 4 5000
 IL - Backer Correspondence.

260384375 FORM 2662 ISS 04-90 S2M20
 1962431 100 EA IL IN MI OH WI
 33
 IL - Ameritech Line Backer Maintenance Service. Folds to 3 5/8 x 9IN.

260402870 FORM 2663 ISS 06-90 S4M20
 1968560 1 EA IL IN MI OH WI
 33
 IL - Business Application Guide.

FORM 2683 ISS 06-87
 0007712 25 EA
 IN - United way Enrollment card. INDIANA ONLY.

PRODUCT IDENTIFIER DESCRIPTION

ITEM NUMBER	ORD. MULT.	SELL UNIT	STD. PKG. STOCK AVAILABILITY / PA	LEAD TIME	MIN. ORD.	A C
-------------	------------	-----------	-----------------------------------	-----------	-----------	-----

FORM 2696 A ISS 04-87
 0005392 25 SH
 IN - Payroll Deduction for Pioneer Fees and Dues. INDIANA ONLY.

300090487 FORM 2703 ISS 07-81
 1933218 25 SH IL IN MI OH WI
 33
 IN - Safety Meeting Record.

260418496 FORM 2742 ISS 07-90 L2M20
 N EA 50 4 50
 IL - Brochure 'Small Business - Big Success'.

260418942 FORM 2761 ISS 07-90 S2M20
 1973834 2000 EA IL IN MI OH WI
 33
 IL - Brochure - A Guide To Your Phone Bill.

260392477 FORM 2762 ISS 12-89
 1966028 10 EA IL IN MI OH WI
 33
 IL - Brochure - How to Avoid Repair Charges (English).

260392485 FORM 2762 1 ISS 12-89 S2M20
 1966036 10 EA IL IN MI OH WI
 33
 IL - Brochure - How to Avoid Repair Charges (Spanish).

FORM 2763
 0006815 100 EA
 IN - Employee Record. INDIANA ONLY.

260392493 FORM 2763 ISS 12-89 S2M20
 1966044 10 EA IL IN MI OH WI
 33
 IL - Brochure - Your Partner in Telephone Service (English).

260392501 FORM 2763 1 ISS 12-89 S2M20
 1966051 10 EA IL IN MI OH WI
 33
 IL - Brochure - Your Partner in Telephone Service (Spanish).

FORM 2805
 0006682 25 EA
 IN - Lease Recommendation and Approval Notice, pg1. INDIANA ONLY.

FORM 2805 2B
 0006683 25 EA
 IN - Lease Recommendation and Approval Notice, pg2. INDIANA ONLY.

FORM 2805 2BIR
 0006684 25 EA
 IN - Lease Recommendation and Approval Notice. INDIANA ONLY.

FORM 2820 A
 0005396 25 EA
 IN - Order Unfilled Regrade Log. INDIANA ONLY.

PRODUCT IDENTIFIER DESCRIPTION

ITEM NUMBER	ORD. MULT.	SELL UNIT	STD. PKG. STOCK AVAILABILITY / PA	LEAD TIME	MIN. ORD.	A C
-------------	------------	-----------	-----------------------------------	-----------	-----------	-----

280042649 FORM 2825 3 ISS 04-91 J30M24
 N EA 500 4 30000

260389622 FORM 2825 11 ISS 06-91 J26524
 N PK 3 4 265

260384961 FORM 2825 11A ISS 06-91 J17524
 N PK 175 4 175

260389630 FORM 2825 11B ISS 07-90 J265UNI24
 N PK 3 4 265

260378237 FORM 2825 12 ISS 01-90 J50M24
 N EA 500 4 50000

260405402 FORM 2825 13 ISS 01-90 J35M24
 N SH 500 4 35000

260378245 FORM 2825 14 ISS 01-90 J10M24
 N EA 500 4 10000

260378252 FORM 2825 15 ISS 01-90 J10M24
 N EA 50 4 10000

260378260 FORM 2825 16 ISS 01-90 J10M24
 N EA 500 4 10000

260378278 FORM 2825 17 ISS 01-90 J10M24
 N EA 500 4 10000

260378286 FORM 2825 18 ISS 01-90 J10M24
 N EA 500 4 10000

260378294 FORM 2825 19 ISS 01-90 J10M24
 N EA 500 4 10000

260378302 FORM 2825 20 ISS 01-90 J27M24
 N SH 500 4 27000

260378310 FORM 2825 21 ISS 01-90 J12M24
 N EA 500 4 12000

260378328 FORM 2825 22 ISS 07-90 J15M24
 N EA 500 4 15000

300090230 FORM 2831 A
 1933242 25 SH IL IN MI OH WI
 33
 IN - Construction Charge Memorandum.

FORM 2864 C
 0005402 25 EA
 IN - Exemption Certificate from Tax on News Services. INDIANA ONLY.

FORM 2887 A ISS 01-84
 0007130 500 EA
 IN - Envelope, Trouble Record, 3-1/2IN X 8IN, Manila. INDIANA ONLY.

FORM 2888 ISS 12-89
 0006859 100 EA
 IN - Designed Circuit Cable Transfer List. INDIANA ONLY.

DISTRIBUTION SERVICES

NETWORK SERVICES

TOOLS

BUILDING JANITORIAL

AUTOMOTIVE

FORMS/OFFICE SUPPLIES

GENERAL

DATA VOICE

DISTRIBUTION SERVICES

NETWORK SERVICES

TOOLS

BUILDING JANITORIAL

AUTOMOTIVE

FORMS/OFFICE SUPPLIES

GENERAL

DATA VOICE

FORM

PRODUCT IDENTIFIER		DESCRIPTION					
ITEM NUMBER	ORD. MULT.	SELL UNIT	STD. PKG. STOCK AVAILABILITY / PA	LEAD TIME	MIN. ORD.	A C	
0006857	100	EA	FORM 2888 1 ISS 12-89				
IN - Associated 2888 Loop Layout. INDIANA ONLY.							
0006895	100	EA	FORM 2889 1 ISS 03-80				
IN - Cable Transfer Terminal Regroup Sheet. INDIANA ONLY.							
0005403	25	EA	FORM 2889 2 ISS 11-78				
IN - Cable Transfer Terminal Regroup Sheet. INDIANA ONLY.							
0007133	50	EA	FORM 2889 3				
IN - Pretest Sheet. INDIANA ONLY.							
0005404	25	EA	FORM 2889 4 ISS 11-78				
IN - Cable Transfer Terminal Regroup Sheet DED PT. INDIANA ONLY.							
001063346	FORM	2900					
5620625	500	SH	IL IN MI OH WI				
IL - Cross Section Paper, 6 squares to the inch.							
300093580	FORM	2915	ISS 01-86				
1933283	100	SH	IL IN MI OH WI				
IN - Expenditure Classification and Approval.							
0003223	5000	EA	FORM 2915 CP ISS 01-86				
IN - Expenditure Classification and Approval. INDIANA ONLY.							
260445515	FORM	2925	ISS 02-92 S3M22				
N	EA	25	4	3000			
IN - Building Service Request.							
001052794	FORM	2927 D	S5M21				
1161620	100	EA	IL IN MI OH WI				
MI - Tag, Serialized Inventory, 8-3/8 X 2-3/4IN.							
0007724	1	SH	FORM 2930 A ISS 06-87				
IN - Managerial Skill Evaluation. INDIANA ONLY.							
260397054	FORM	2941	ISS 04-90 S25C20				
1967760	25	EA	IL IN MI OH WI				
IL - Insert - Call Forwarding.							
300090305	FORM	2942	ISS 02-85				
1933317	25	SE	IL IN MI OH WI				
IN - Transfer of Payroll Charges.							
260397062	FORM	2942	ISS 04-90 S25C20				
1967778	25	EA	IL IN MI OH WI				
IL - Insert - Three Way Calling.							

PRODUCT IDENTIFIER		DESCRIPTION					
ITEM NUMBER	ORD. MULT.	SELL UNIT	STD. PKG. STOCK AVAILABILITY / PA	LEAD TIME	MIN. ORD.	A C	
001063395	FORM	2942 1A	ISS 02-69 J15M5C20				
5620989	500	EA	IL IN MI OH WI				
IL - Envelope (Construction Work Orders).							
260397070	FORM	2943	ISS 04-90 S2M5C20				
1967786	25	EA	IL IN MI OH WI				
IL - Insert - Speed Calling.							
260397088	FORM	2944	ISS 04-90 S2M5C20				
1967794	25	EA	IL IN MI OH WI				
IL - Insert - Automatic Callback.							
260397096	FORM	2945	ISS 04-90 S25C20				
1967802	25	EA	IL IN MI OH WI				
IL - Insert - Repeat Dialing.							
260397104	FORM	2946	ISS 04-90 S2M5C20				
1967810	25	EA	IL IN MI OH WI				
IL - Insert - Call Screening.							
260397112	FORM	2947	ISS 04-90 S2M5C20				
1967828	25	EA	IL IN MI OH WI				
IL - Insert - Distinctive Ringing.							
0005407	FORM	2947 B					
25	EA						
IN - Cable Pressurization Monthly Report. INDIANA ONLY.							
260397120	FORM	2948	ISS 04-90 S2M5C20				
1967836	25	EA	IL IN MI OH WI				
IL - Insert - Call Waiting.							
0005408	FORM	2949	ISS 08-82				
25	EA						
IN - Cable Pressurization Air Usage. INDIANA ONLY.							
280045402	FORM	2949	ISS 08-83 J25M5C20				
N	SE	750	6	25500			
WI - Allotment Authorization Confirmation.							
280044512	FORM	2958					
N	EA	500	6	20000			
280054131	FORM	2958 1	I 01-87 J8M24				
N							
WI - Envelope - CABS Priority Mailing Envelope 10 X 121 X 4IN. 4IN Expansion, open 10IN side.							
260380233	FORM	2958 1	ISS 04-90 S2M20				
1960716	500	EA	IL IN MI OH WI				
IL - Call Identification Service - User's Guide.							
260380225	FORM	2958 2	ISS 04-90 S2M20				
1960724	500	EA	IL IN MI OH WI				
IL - Call Identification Service Brochure.							

DISTRIBUTION SERVICES

NETWORK SERVICES

TOOLS

BUILDING JANITORIAL

AUTOMOTIVE

FORMS/OFFICE SUPPLIES

GENERAL

DATA VOICE

PRODUCT IDENTIFIER		DESCRIPTION				
ITEM NUMBER	ORD. MULT.	SELL UNIT	STD. PKG. STOCK AVAILABILITY / PA	LEAD TIME	MIN. ORD.	A C
300079969	FORM	2960	ISS 10-85 S50M20			
1176438	100	EA	IL IN MI OH WI	33		
IL - Brochure, Custom Calling Services.						
260425541	FORM	2960	S ISS 06-91 S2M20			
1977124	100	EA	IL IN MI OH WI	33		
IL - Brochure - Custom Calling Services Instructions (Spanish).						
260348941	FORM	2960	2 ISS 04-89 S75M20			
1951830	100	EA	IL IN MI OH WI	33		
IL - Envelope - Custom Calling Brochure & Clip-It.						
300036555	FORM	2960	3 ISS 11-84			
5109678	200	EA	IL IN MI OH WI	33		
Label - Custom Calling Services-Features Instructions.						
260348933	FORM	2960	5 ISS 04-89			
1951822	50	SH	IL IN MI OH WI	33		
IL - Insert - Custom Calling Instructions.						
260392048	FORM	2960	6 ISS 09-90 S40M20			
1965715	40	SH	IL IN MI OH WI	33		
Illinois Bell Custom Calling Services Reference Guide.						
260437793	FORM	2960	6 ISS 12-91 S40M20			
N		EA	10	4	4000	
IL - BROCHURE - ILLINOIS BELL CUSTOM CALLING SERVICE REFERENCE GUIDE.						
260437082	FORM	2960	6S ISS 12-91			
N		EA	10	4	3000	
IL - Brochure - Ill Bell Custom Calling Services Reference Guide-Spanish.						
260384896	FORM	2964	4 ISS 03-90 S3M20			
1962704	50	EA	IL IN MI OH WI	33		
IL - Brochure - Ameritech Custom Business Service. Folds to 3 5/8in x 9in.						
260384888	FORM	2964	5 ISS 03-90 S4M20			
1962696	50	EA	IL IN MI OH WI	33		
IL - Instruction Booklet - Customer Business Service. Folds in half to 3 1/16in x 9in.						
260419221	FORM	2965	1 ISS 04-91 S5M20			
1974139	50	EA	IL IN MI OH WI	33		
IL - Brochure cover - Ameritech Custom 800 Service.						
260419239	FORM	2965	2 ISS 04-90 S2M20			
1974147	25	EA	IL IN MI OH WI	33		
IL - Custom 800 Service - Chicago Area.						

PRODUCT IDENTIFIER		DESCRIPTION				
ITEM NUMBER	ORD. MULT.	SELL UNIT	STD. PKG. STOCK AVAILABILITY / PA	LEAD TIME	MIN. ORD.	A C
260419247	FORM	2965	3 ISS 04-90 S2M20			
1974154	25	EA	IL IN MI OH WI	33		
IL - Custom 800 Service - Champaign Area.						
260419254	FORM	2965	4 ISS 04-90 S2M20			
1974162	25	EA	IL IN MI OH WI	33		
IL - Custom 800 Service - Metro East Area.						
260419262	FORM	2965	5 ISS 04-90 S2M20			
1974170	25	EA	IL IN MI OH WI	33		
IL - Custom 800 Service - Peoria Area.						
260419270	FORM	2965	6 ISS 04-90 S2M20			
1974188	25	EA	IL IN MI OH WI	33		
IL - Custom 800 Service - Rockford Area.						
260419288	FORM	2965	7 ISS 04-90 S2M20			
1974196	25	EA	IL IN MI OH WI	33		
IL - Custom 800 Service - Springfield Area.						
260419296	FORM	2965	8 ISS 04-90 S2M20			
1974204	25	EA	IL IN MI OH WI	33		
IL - Custom 800 Service - Rock Island Area.						
260396585	FORM	2967	ISS 04-90 S3M5C20			
1967729	1	EA	IL IN MI OH WI	33		
IL - Ameritech Custom Calling Services.						
280047051	FORM	2970	ISS 11-86 S40M20			
1926022	50	EA	IL IN MI OH WI	33		
IL - TAG - Forwarding Calls.						
260327846	FORM	2972	ISS 05-88 S5M20			
1945519	50	EA	IL IN MI OH WI	33		
IL - Brochure - Inside Information From Illinois Bell.						
260396577	FORM	2976	ISS 05-90 S3M5C20			
1967711	50	EA	IL IN MI OH WI	33		
IL - Ameritech Remote Call Forwarding.						
260384870	FORM	2981	ISS 04-90 S10M20			
1962688	100	EA	IL IN MI OH WI	33		
IL - Brochure - Illinois Bell Line Backer Maintenance Service. Folds to 3 3/4in x 8 1/2in.						
260423355	FORM	2981	S ISS 06-91 S2M20			
1976076	2000	EA	IL IN MI OH WI	33		
IL - Brochure Illinois Bell Line-Backer Maintenance Service (Spanish).						
	FORM	2982	C			
0007142	100	EA	IN - Data Processing, Cancelled Calls Label.			
INDIANA ONLY.						

DISTRIBUTION SERVICES

NETWORK SERVICES

TOOLS

BUILDING JANITORIAL

AUTOMOTIVE

FORMS/OFFICE SUPPLIES

GENERAL

DATA VOICE

FORM

PRODUCT IDENTIFIER		DESCRIPTION					
ITEM NUMBER	ORD. MULT.	SELL UNIT	STD. PKG. STOCK AVAILABILITY / PA	LEAD TIME	MIN. ORD.	A C	
001063437	FORM	2990					
5621268	500	EA	IL IN MI OH WI				
			33				
			IL - Envelope - Open end - First Class Mail.				
0007144	1	EA	FORM 2995 B ISS 01-83				
			IN - Report of Visit to Retired Employee. INDIANA ONLY.				
001114602	FORM	3005					
5620807	50	SE	IL IN MI OH WI				
			33				
			IL - Coin Collection Memorandum.				
200004653	FORM	3008	ISS 08-85 J2M20				
N		EA	500	6	2000		
			IL - Envelope - Benefit Department HQ15G, 9 1/2 X 4 1/8IN.				
260413554	FORM	3017 4	ISS 10-90 L100M20				
N		SH	500	2	500		
			IL - Denial Notice (Chicago).				
260436043	FORM	3017 5	ISS 10-90 L25M20				
N		SH	500	4	25000		
			IN - Denial Notice (Suburban).				
260436050	FORM	3017 6	ISS 10-90 L20M20				
N		SH	500	4	20000		
			IL - Denial Notice (State).				
260300462	FORM	3017 9	ISS 11-87 S75M20				
1938621	500	SH	IL IN MI OH WI				
			33				
			Denial Notice - Illness Insert.				
260353602	FORM	3030	ISS 04-89				
1952036	500	SH	IL IN MI OH WI				
			33				
			IL - Exception Time Report - Management.				
260347620	FORM	3038 1	ISS 03-89 S50M20				
1951665	500	SH	IL IN MI OH WI				
			33				
			IL - Confirming Denial Notice CRIS.				
260358502	FORM	3038 2	ISS 07-89 S8M20				
1953174	500	SH	IL IN MI OH WI				
			33				
			IL - Confirming Denial Notice CRIS (Decatur).				
300093606	FORM	3044					
1933333	25	SH	IL IN MI OH WI				
			33				
			IN - Intercept PBX Special Requests.				
280040833	FORM	3044 1	ISS 05-86 J10M24				
N		SE	50	6	10000		
			WI - Forms Management - Forms Requisition.				
260436100	FORM	3045 2	ISS 07-91 S14422				
1980771		BK	IL IN MI OH WI				
			IN - Building Lock Requirements.				

PRODUCT IDENTIFIER		DESCRIPTION					
ITEM NUMBER	ORD. MULT.	SELL UNIT	STD. PKG. STOCK AVAILABILITY / PA	LEAD TIME	MIN. ORD.	A C	
260433198	FORM	3045-1	ISS 07-91 S14422				
1979880	1	BK	IL IN MI OH WI				
			33				
			IN - Best Key Activity Request.				
260341466	FORM	3051ABC	ISS 11-88				
1949719	25	SE	IL IN MI OH WI				
			33				
			IN - Applicant - Tuition Aid/Personal and Career.				
280036989	FORM	3061 1	ISS 07-86 S70M20				
1923755	500	SH	IL IN MI OH WI				
			33				
			IL - Deposit Installment Denial Notice.				
260300470	FORM	3061 2	ISS 11-87 S20M20				
1938654	500	SH	IL IN MI OH WI				
			33				
			IL - Deposit Installment Denial Notice - Non-312 Customers.				
260421334	FORM	3061 3	ISS 10-90 L20M20				
N		SH	500	4	500		
			IL - Deposit Installment Denial Notice - Chicago.				
300090362	FORM	3086	ISS 01-80				
1933341	50	SH	IL IN MI OH WI				
			33				
			IN - Outside Plant Maintenance Report.				
	FORM	3086 3	ISS 02-80				
0006693	25	EA					
			IN - Daily Log. INDIANA ONLY.				
	FORM	3095 B1					
0005414	25	EA					
			IN - Automatic Line Insulation Test Results Summary. INDIANA ONLY.				
	FORM	3095 B2	ISS 09-76				
0005415	25	EA					
			IN - Automatic Line Insulation Test Results Summary. INDIANA ONLY.				
001020973	FORM	3104 3					
1161760	500	EA	IL IN MI OH WI				
			33				
			Tag.				
001002401	FORM	3104 4A					
1161786	500	EA	IL IN MI OH WI				
			33				
			Tag.				
001063502	FORM	3115 1	ISS 03-79 S20M20				
5621540	500	EA	IL IN MI OH WI				
			33				
			IL - Envelope-Plain 12.5in X 9.5in, not for U.S. Mail. Logo is one color - black.				
001113307	FORM	3115 2	ISS 01-77 S15M20				
5620500		EA	IL IN MI OH WI				
			33				
			IL - Envelope - Plain 12 1/2 x 9 1/2 - 1st Class Mail.				

PRODUCT IDENTIFIER		DESCRIPTION				
ITEM NUMBER	ORD. MULT.	SELL UNIT	STD. PKG. STOCK AVAILABILITY / PA	LEAD TIME	MIN. ORD.	A C
001046689		FORM	3120	ISS 02-74	J3M20	
N		EA	500	6	3000	
			IL - Label - C.E. Company Mail.			
300090388		FORM	3124	ISS 09-82		
1933358	50	SH	IL IN MI OH WI	33		
			IN - Summary of Collections.			
280041559		FORM	3133		J50M24	
N		EA	500	4	50000	
			IN -			
300093614		FORM	3133	ISS 10-83		
1933366	50	SH	IL IN MI OH WI	33		
			IN - Transfers-Other Adjustments.			
		FORM	3139	18D	ISS 08-87	
0003234	100	EA				
			IN - Auditor Business Reply Envelope. INDIANA ONLY			
		FORM	3139	19	ISS 04-86	
0003235	1000	EA				
			IN - Auditor Business Reply Envelope. INDIANA ONLY.			
280099284		FORM	3140	ISS 04-87		
1937417	500	EA	IL IN MI OH WI	33		
			IN - Envelope - Check Mailing, 7 3/4 X 3 11/16.			
		FORM	3146		ISS 04-81	
0007159	1	EA				
			IN - CMR Memo Bill. INDIANA ONLY.			
		FORM	3152		ISS 01-83	
0007160	25	EA				
			IN - Indiana General Sales Tax Exemption Certificate. INDIANA ONLY.			
		FORM	3181		ISS 05-82	
0007161	25	EA				
			IN - Service Anniversary Card. INDIANA ONLY.			
		FORM	3185	B	ISS 07-81	
0003703	1	EA				
			IN - Disbursement Monthly Source Listing. INDIANA ONLY.			
300091287		FORM	3207	ISS 01-84	A35M22	
N		SH	6500	2	6500	
			IN - Directory Delivery Stubs.			
002061281		FORM	3220	ISS 03-82	S10M20	
5649582	1000	SH	IL IN MI OH WI	33		
			IL - Ruled paper, 7 vertical columns.			
001063577		FORM	3220	1		
5622209	1000	SH	IL IN MI OH WI	33		
			IL - Ruled paper, 13 vertical columns.			

PRODUCT IDENTIFIER		DESCRIPTION				
ITEM NUMBER	ORD. MULT.	SELL UNIT	STD. PKG. STOCK AVAILABILITY / PA	LEAD TIME	MIN. ORD.	A C
		FORM	3224			
0005419	25	EA				
			IN - Tax Exemption School Church Parish. INDIANA ONLY.			
		FORM	3240	ISS 09-90		
0007163	1	EA				
			IN - Ameritech Employee Information System Credit Union. INDIANA ONLY.			
001063635		FORM	3245	ISS 02-41	S25M20	
5622464	500	EA	IL IN MI OH WI	33		
			IL - Envelope-Intra-company Personal, 9 1/2in X 4 1/8in.			
200004703		FORM	3264	7	ISS 11-69	L20M20
N		EA	500	2	500	
			IL - Envelope - U.S. MAIL - HQ 16E, window 8-7/8 X 3-7/8in.			
200004711		FORM	3264	9	ISS 10-85	J15M20
N		EA	500	6	15000	
			IL - Envelope - Coin Telephone Reminder Notice.			
300050853		FORM	3265	ISS 01-85		
5116806	25	SE	IL IN MI OH WI	33		
			IL - Request For Advance Funds.			
260376405		FORM	3284	2Z		J20M21
N		SE	2	8	20000	
			MI - Weekly Time Report.			
280040858		FORM	3307	ISS 11-84	J5M24	
N		SE	25	6	5000	
			WI - Service Manager Request - Approval to Charge Services.			
300000726		FORM	3318	ISS 01-84		
1156778	500	EA	IL IN MI OH WI	33		
			IL - Application for Telephone Concession.			
001063767		FORM	3319			
5623348	500	SH	IL IN MI OH WI	33		
			IL - Cancellation of Telephone Concession.			
		FORM	3325	W	ISS 11-82	
0005421	25	EA				
			IN - Report of Major Failure or Occurrence. INDIANA ONLY.			
260347943		FORM	3337	ISS 05-89	S10M20	
1951715	1000	EA	IL IN MI OH WI	33		
			IL - PIE Shipping Label.			
260347935		FORM	3337	1	ISS 05-89	
1951707	1000	EA	IL IN MI OH WI	33		
			IL - NCTE Returns/Shipping Label.			

DISTRIBUTION SERVICES
 NETWORK SERVICES
 TOOLS
 BUILDING JANITORIAL
 AUTOMOTIVE
 FORMS/OFFICE SUPPLIES
 GENERAL
 DATA VOICE

FORM

DISTRIBUTION SERVICES

PRODUCT IDENTIFIER		DESCRIPTION						
ITEM NUMBER	ORD. MULT.	SELL UNIT	STD. PKG. STOCK AVAILABILITY / PA	LEAD TIME	MIN. ORD.	A	C	
260385976		FORM	3340	ISS 05-90 S2M22				
1963546	25	SE	IL IN MI OH WI	33				
IN - Authorization for Line Identification.								
300090180		FORM	3343	ISS 05-84				
1933390	50	SH	IL IN MI OH WI	33				
IN - Management Duty List.								
280080532		FORM	3353	ISS 06-87 S40M20				
1936575	3000	SE	IL IN MI OH WI	33				
IL - TRACS Daily Time and Work Report.								

NETWORK SERVICES

TOOLS

BUILDING JANITORIAL

AUTOMOTIVE

FORMS/OFFICE SUPPLIES

GENERAL

DATA VOICE

0005427	100	EA		FORM 3353 A			
IN - Plant Power Calculation Worksheet. INDIANA ONLY.							
001063791		FORM	3358				
5623603	625	EA	IL IN MI OH WI	33			
IL - Envelope-Plain 6 1/2in X 3 5/8in.							
001063809		FORM	3360	S10M20			
1135772	625	EA	IL IN MI OH WI	33			
IL - Envelope - Plain Manila.							
300090156		FORM	3366	ISS 07-80			
1932095	50	SH	IL IN MI OH WI	33			
IN - Daily Work Job Sheet. 50 sheets per book.							
280040866		FORM	3368	ISS 04-90 J10M24			
N		SE	25	6	10000		
WI - Office Supply Requisition.							
002043271		FORM	3369				
5647644	500	SH	IL IN MI OH WI	33			
IL - BI-Weekly Time Record.							
001053529		FORM	3382 H				
1162081	25	EA	IL IN MI OH WI	33			
Envelope.							
300080702		FORM	3399	ISS 08-90 J5M20			
N		SE	1000	8	5000		
IL - Customer Service Report, 3 sheets per set.							
001063833		FORM	3401				
5623785	500	SH	IL IN MI OH WI	33			
IL - Transfer Report.							
001002476		FORM	3408				
5623843	500	SH	IL IN MI OH WI	33			
IL - Plant Retirement Report.							
300043056		FORM	3408 N				
1314278	500	SH	IL IN MI OH WI	33			

PRODUCT IDENTIFIER		DESCRIPTION						
ITEM NUMBER	ORD. MULT.	SELL UNIT	STD. PKG. STOCK AVAILABILITY / PA	LEAD TIME	MIN. ORD.	A	C	
260364351		FORM	3410	ISS 01-90				
1954537	25	SE	IL IN MI OH WI	33				
IL - Application for Leave of Absence.								
260364369		FORM	3410 1	ISS 01-90 S2M20				
N		SE	25	8	2000			
IL - Application For Leave of Absence - Anticipated Disability.								
260436746		FORM	3410 1	ISS 11-91 J1M				
N		SE	500	8	1000			
ASI - Application for Anticipated Disability Leave of Absence.								
260364377		FORM	3410 2	ISS 01-90				
1954495	25	SE	IL IN MI OH WI	33				
IL - Application for Leave of Absence - Care of Newborn or Adopted Child.								
260364385		FORM	3410 3	ISS 01-90				
1954487	25	SE	IL IN MI OH WI	33				
IL - Application for Leave of Absence - Dependent Care.								
260436027		FORM	3410 A	ISS 11-91 J1M				
N		SE	500	8	1000			
ASI - Termination of Leave of Absence.								
300090172		FORM	3437 2	ISS 09-67				
N		SH	100	4	3000			
IN - Cable, Coil Case & Cable Reel Record.								
		FORM	3441	ISS 01-88				
0006796	100	EA						
IN - Disconnect Activity Report. INDIANA ONLY.								
280061342		FORM	3444	ISS 04-81				
1931998	25	SE	IL IN MI OH WI	33				
IN - Authorization for Change In Material Stocked at WESC.								
280041658		FORM	3451	ISS 11-86 J20M24				
N		EA	500	4	20000			
280099383		FORM	3454 B	ISS 02-87 A47M22				
1937623	500	EA	IL IN MI OH WI	33				
IN - Envelope - Check Mailing, 7 3/4 X 3 11/16, white, gummed flap.								
		FORM	3457	ISS 05-83				
0005440	25	EA						
IN - Central Office Puregas Dryers Inspection Maintenance Check List. INDIANA ONLY.								
		FORM	3457 1	ISS 02-83				
0005441	25	EA						
IN - Central Office Dryers Inspection Maintenance Check List. INDIANA ONLY.								
		FORM	3457 2	ISS 02-83				
0005442	25	EA						
IN - Pole Mounted Air Dryer Maintenance List. INDIANA ONLY.								

PRODUCT IDENTIFIER		DESCRIPTION						
ITEM NUMBER	ORD. MULT.	SELL UNIT	STD. PKG. STOCK	PKG. AVAILABILITY / PA	LEAD TIME	MIN. ORD.	A C	
FORM 3460		ISS 08-82						
0005444	25	EA	IN - Moisture Separator Inspection & Maintenance. INDIANA ONLY.					
260364393 FORM		3466 ISS 01-90 S2M20						
N		SE	25		8	2000		
IL - Application For Extension of leave of Absence.								
260436738 FORM		3466 ISS 11-91 J1M						
N		SE	500		8	1000		
ASI - Application for an Extension of Leave of Absence.								
260364401 FORM		3466 1 ISS 01-90						
1954511	25	SE	IL	IN	MI	OH	WI	
33 IL - Application for Extension of Leave of Absence - Care of Newborn or Adopted Child.								
260364419 FORM		3466 2 ISS 01-90 S2M20						
1954503	25	SE	IL	IN	MI	OH	WI	
33 IL - Application for Extension of Leave of Absence - Dependent Care.								
280024407 FORM		3469 C ISS 01-84						
1933416	500	EA	IL	IN	MI	OH	WI	
33 IN - Envelope - Indianapolis 220, 9 1/2 X 12 1/2 Kraft.								
280024415 FORM		3470 B ISS 01-84						
1933424	25	EA	IL	IN	MI	OH	WI	
33 IN - Envelope - Indianapolis 220, 15 X 10 Kraft.								
280024423 FORM		3471 E ISS 01-84						
1933432	500	EA	IL	IN	MI	OH	WI	
33 IN - Envelope - Indianapolis 220.								
001021641 FORM		3475 ISS						
N								
001021641 FORM		3475 G						
1162149	25	SH	IL	IN	MI	OH	WI	
33								
300090222 FORM		3479						
1933457	25	SH	IL	IN	MI	OH	WI	
33 IL - Job Order Log.								
FORM 3481		ISS 03-84						
0005445	25	EA	IN - ASPPP, Missed Due Date Report. INDIANA ONLY.					
300089992 FORM		3487 ISS 02-83						
1933465	25	SE	IL	IN	MI	OH	WI	
33 IN - Contractor Buried Drop Order.								

PRODUCT IDENTIFIER		DESCRIPTION						
ITEM NUMBER	ORD. MULT.	SELL UNIT	STD. PKG. STOCK	PKG. AVAILABILITY / PA	LEAD TIME	MIN. ORD.	A C	
300093648 FORM		3495 ISS 04-79						
1933473	100	SH	IL	IN	MI	OH	WI	
33 IN - Voucher Attachment.								
FORM 3495 1		ISS 10-87						
0007708	500	EA	IN - Voucher Attachment. INDIANA ONLY.					
FORM 3498 1		ISS 02-75						
0003758	1	EA	IN - Treatment Activity. INDIANA ONLY.					
001163799 FORM		3500 ISS 01-81 J2M20						
N		SE	50		8	2000		
IL - Records Request and Withdrawal Slip.								
FORM 3501 A								
0009015	1	EA	IN - Final Account Register. INDIANA ONLY.					
300092442 FORM		3501 A ISS 04-82 J10M22						
N		SH	2850		8	10000		
IN - Final Account Register.								
FORM 3506		ISS 01-79						
0005450	50	EA	IN - C.O.E. Retirements. INDIANA ONLY.					
FORM 3523 2		ISS 01-80						
0007191	50	EA	IN - Final Notice Prior to Disconnection. INDIANA ONLY.					
300090024 FORM		3534 A ISS 09-86						
1933481	25	EA	IL	IN	MI	OH	WI	
33 LABEL - Comptrollers Cash Unit Voucher.								
300090032 FORM		3535 B ISS 08-82						
1933499	100	SH	IL	IN	MI	OH	WI	
33 IN - Label - Comptrollers Service-Orders Account.								
FORM 3542								
0009017	1	EA	IN - Audit Notice. INDIANA ONLY.					
300092467 FORM		3542 ISS 01-84 J5M22						
N		SH	5200		8	5000		
IN - Audlt Notice.								
001064179 FORM		3565 ISS 06-72 S8M20						
7298984	500	SH	IL	IN	MI	OH	WI	
33 IL - Label - Wire Identification.								
FORM 3572								
0009018	1	EA	INDIANA ONLY.					
300092475 FORM		3575 ISS 08-70 J3M22						
N		SH	800		8	3000		
IN - Job Record Sheet.								

DISTRIBUTION SERVICES

NETWORK SERVICES

TOOLS

BUILDING JANITORIAL

AUTOMOTIVE

FORMS/OFFICE SUPPLIES

GENERAL

DATA VOICE

FORM

DISTRIBUTION SERVICES

PRODUCT IDENTIFIER		DESCRIPTION				
ITEM NUMBER	ORD. MULT.	SELL UNIT	STD. PKG. STOCK AVAILABILITY / PA	LEAD TIME	MIN. ORD.	A C

0003251 FORM 3592 A
500 EA
IN - ESS Trunk Record, green. INDIANA ONLY.

NETWORK SERVICES

0003253 FORM 3592 A
500 EA
IN - ESS Trunk Record, yellow. INDIANA ONLY.

0003252 FORM 3592 A
500 EA
IN - ESS Trunk Record, plain. INDIANA ONLY.

TOOLS

300090065 FORM 3632
1933507 25 SH IL IN MI OH WI
33
IN - Siding Release.

260364286 FORM 3636 ISS 09-89
1954396 25 SH IL IN MI OH WI
33
IN - Minor Change In Plans Involving Property Record Item.

BUILDING JANITORIAL

0007205 FORM 3645 1 ISS 04-92
1 EA
IN - Application, Absence Leave for Anticipated Disability. INDIANA ONLY.

0007206 FORM 3645 2 ISS 02-82
10 SE
IN - Application, Absence Leave Newborn Child Care. INDIANA ONLY.

AUTOMOTIVE

300093689 FORM 3656 ISS 08-86
1933531 50 EA IL IN MI OH WI
33
IN - Shipping Label - Plug-In Equipment.

300089901 FORM 3658 ISS 06-80
1933549 25 SH IL IN MI OH WI
33
IN - Request For Transfer Application.

FORMS/OFFICE SUPPLIES

300089919 FORM 3659 A ISS 11-86
1933556 25 SE IL IN MI OH WI
33
IN - Employee Work Performance Evaluation.

300089927 FORM 3660 ISS 09-86
1933747 25 SH IL IN MI OH WI
33
IN - Non-Management Job Vacancy Requisition.

GENERAL

300093697 FORM 3669 ISS 09-83
1933564 25 SE IL IN MI OH WI
33
IN - Restore Service Advice.

260323472 FORM 3687 1 ISS 02-88
1943761 50 SH IL IN MI OH WI
33
IN - Engineering Job-Order Print Sheet.

DATA VOICE

280062241 FORM 3687 2
1934836 50 SH IL IN MI OH WI
33
IN - Work Print Tracing.

PRODUCT IDENTIFIER		DESCRIPTION				
ITEM NUMBER	ORD. MULT.	SELL UNIT	STD. PKG. STOCK AVAILABILITY / PA	LEAD TIME	MIN. ORD.	A C

280062639 FORM 3700 1 ISS 11-83 A660M22
1931196 2000 SH IL IN MI OH WI
33
IN - BISCON Service Order - Residence & Business.

280062621 FORM 3700 21 ISS 02-85 A560M22
1931204 700 SE IL IN MI OH WI
33
IN - Service Order - After TFA Engineering.

260317888 FORM 3700 24 ISS 10-87 A336.6M22
1941047 1700 SE IL IN MI OH WI
33
IN - Biscorn Service Order.

260368881 FORM 3700 26 ISS 11-89 S10M22
1955682 100 SE IL IN MI OH WI
33
IN - Line Or Station Transfer.

300089778 FORM 3700 27 ISS 02-87 5 PLY
N SE 100 4 100
IN - Assignment Work Sheet.

0005461 FORM 3704
25 EA
IN - Payroll Change Memo. INDIANA ONLY.

0007225 FORM 3705
1 EA
IN - Mailing Address Authorization. INDIANA ONLY.

0007226 FORM 3706
1 EA
IN - Prepaid Health Plan Enrollment Card. INDIANA ONLY.

300072246 FORM 3710 3 ISS 08-91 J32M20
N SH 4000 8 32000
IL - United Way/Crusade of Mercy Solicitation Card.

0009025 FORM 3720
1 EA
INDIANA ONLY.

300092558 FORM 3720 ISS 01-84 J3M22
N SH 2850 2 2850
IN - Service Order Fax.

300089786 FORM 3721 ISS 10-85
1933606 500 SH IL IN MI OH WI
33
IN - Miscellaneous Activity.

0007228 FORM 3722 ISS 09-83
50 EA
IN - Installment Billing Advance Payment. INDIANA ONLY.

260302765 FORM 3727 ISS 10-87 S15M20
1939512 250 SH IL IN MI OH WI
33
IL - Service Request.

PRODUCT IDENTIFIER		DESCRIPTION					
ITEM NUMBER	ORD. MULT.	SELL UNIT	STD. PKG. STOCK AVAILABILITY / PA	LEAD TIME	MIN. ORD.	A C	
FORM 3728		ISS 09-90					
0007229	1	EA					
IN - Ameritech Employee Information System Net Check Deposit. INDIANA ONLY.							
300072253 FORM		3731 ISS 12-85 J2M20					
N		SE	2000	8	2000		
IL - List of Employees Eligible to Receive Gold Service Emblems.							
300089810 FORM		3733					
1933614	50	BK	IL	IN MI OH WI	33		
IN - Plant Order.							
FORM 3740							
0009026	1	EA					
INDIANA ONLY.							
FORM 3761							
0007233	50	EA					
IN - Tool Ticket. INDIANA ONLY.							
FORM 3765		ISS 03-84					
0003274	500	EA					
IN - Purchase Order Motor Vehicles. INDIANA ONLY.							
FORM 3777 1		ISS 03-87					
0007235	250	EA					
IN - Envelope, Collection Agency, 9 1/2in x 6 1/2in Kraft. INDIANA ONLY.							
280024431 FORM		3777 1 ISS 04-87 J10M22					
N		EA	250	6	10000		
IN - Envelope - Collection Agency, 9 1/2 X 6 1/2IN Kraft.							
FORM 3777 4		ISS 05-91					
0003766	500	EA					
IN - Envelope - Business Reply. INDIANA ONLY.							
260365390 FORM		3787 ISS 01-89					
1955401	500	EA	IL	IN MI OH WI	33		
IL - Card - Customer Notification.							
300093705 FORM		3806 ISS 10-79 J1M22					
N		SH	500	4	1000		
IN - Cable Location Report.							
FORM 3812		ISS 04-88					
0003276	1000	EA					
IN - BSP Code Transmittal. INDIANA ONLY.							
300089687 FORM		3813 ISS 04-85 S3M22					
1933648	25	SH	IL	IN MI OH WI	33		
IN - Cable Transfer & Cutover Schedule.							
001064369 FORM		3830					
5625863	500	SH	IL	IN MI OH WI	33		
IL - Plain ruled form, 17in X 11in.							

PRODUCT IDENTIFIER		DESCRIPTION					
ITEM NUMBER	ORD. MULT.	SELL UNIT	STD. PKG. STOCK AVAILABILITY / PA	LEAD TIME	MIN. ORD.	A C	
280024464 FORM		3832 2 ISS 10-84					
1933655	500	EA	IL	IN MI OH WI	33		
IN - Envelope - Teller Drop 3 1/2 X 6 1/2, blue.							
280024472 FORM		3832 3 ISS 10-84					
1933663	500	EA	IL	IN MI OH WI	33		
IN - Envelope - Teller Drop 3 1/2 X 6 1/2, green.							
280024480 FORM		3832 4 ISS 10-84					
1933671	500	EA	IL	IN MI OH WI	33		
IN - Envelope - Teller Drop 3 1/2 X 6 1/2, purple.							
280024498 FORM		3832 5 ISS 10-84					
1933689	500	EA	IL	IN MI OH WI	33		
IN - Envelope - Teller Drop 3 1/2 X 6 1/2, orange.							
300089703 FORM		3835 ISS 07-78					
N		SH	25	4	2000		
IN - Trunk Assignment Details.							
280041518 FORM		3846 ISS 05-84 J20M24					
N		EA	25	4	20000		
FORM 3850		ISS 05-87					
0005478	1	EA					
IN - Notifier, Graphics. INDIANA ONLY.							
FORM 3853 1		ISS 03-87					
0005479	1	EA					
IN - Graphics Work Order, Outside. INDIANA ONLY.							
FORM 3855		ISS 09-78					
0003712	1000	3A					
IN - Property of Indiana Bell Return Master Art. INDIANA ONLY.							
260304134 FORM		3862 ISS 11-86					
1940759	1	SE	IL	IN MI OH WI	33		
IN - Management Performance Appraisal Summary.							
FORM 3866		ISS 07-78					
0005482	25	EA					
IN - FM Terminal Transmitter Microwave Radio Log. INDIANA ONLY.							
300093713 FORM		3870 ISS 01-83 S12M22					
1931881	50	SH	IL	IN MI OH WI	33		
IN - Mtr Daily Work Report (A).							
200004745 FORM		3870 ISS 11-75 J20M20					
N		EA	500	6	20000		
IL - Envelope - Time Sheet Mailer 13 X 10IN.							

DISTRIBUTION SERVICES
 NETWORK SERVICES
 TOOLS
 BUILDING JANITORIAL
 AUTOMOTIVE
 FORMS/OFFICE SUPPLIES
 GENERAL
 DATA VOICE

DISTRIBUTION SERVICES
 NETWORK SERVICES
 TOOLS
 BUILDING JANITORIAL
 AUTOMOTIVE
 FORMS/OFFICE SUPPLIES
 GENERAL
 DATA VOICE

FORM

PRODUCT IDENTIFIER		DESCRIPTION					
ITEM NUMBER	ORD. MULT.	SELL UNIT	STD. PKG. STOCK AVAILABILITY / PA	LEAD TIME	MIN. ORD.	A C	
300093721	FORM	3871	ISS 08-79				
1933713	50	SH	IL IN MI OH WI				
			33				
			IN - Mtr Weekly Work Report.				
0003279	500	EA	FORM 3871 A ISS 01-82				
			IN - Mtr Weekly Work Report. INDIANA ONLY.				
300089737	FORM	3873	ISS 07-81				
1931873	50	SH	IL IN MI OH WI				
			33				
			IN - Mtr Daily Work Report For Building Services.				
300093739	FORM	3874	ISS 07-81				
1932103	50	SH	IL IN MI OH WI				
			33				
			IN - Mtr Daily Work Report (B).				
0005484	25	EA	FORM 3875 ISS 06-78				
			IN - Private Service Report. INDIANA ONLY.				
0003714	25	EA	FORM 3878 ISS 02-79				
			IN - PICS/DCPR Shipping Notice. INDIANA ONLY.				
0003280	500	EA	FORM 3879 ISS 05-92				
			IN - Work Order. INDIANA ONLY.				
300072295	FORM	3890 A	ISS 04-80 J20M20				
N		SE	1925	8	20000		
			IL - U.S. Savings Bond Allotment Authorization-Mailer, 4 sheets per set.				
0007259	100	EA	FORM 3897 ISS 01-92				
			IN - Request for Assigned or Additional Vehicles. INDIANA ONLY.				
0007263	25	EA	FORM 3908 ISS 01-85				
			IN - Career Information Management Personnel Request. INDIANA ONLY.				
300089513	FORM	3922	ISS 11-79				
1932954	50	SH	IL IN MI OH WI				
			33				
			IN - ARSB Trouble Report.				
002087583	FORM	3926	ISS 03-83				
5655621	500	SH	IL IN MI OH WI				
			33				
			IL - Plant Work Recommendation.				
001042134	FORM	3939 B					
1162982	500	EA	IL IN MI OH WI				
			33				
			Envelope.				
0006500	100	EA	FORM 3946 ISS 03-87				
			IN - Record of Incentive Awards. INDIANA ONLY.				

PRODUCT IDENTIFIER		DESCRIPTION					
ITEM NUMBER	ORD. MULT.	SELL UNIT	STD. PKG. STOCK AVAILABILITY / PA	LEAD TIME	MIN. ORD.	A C	
			FORM 3955	ISS 05-85			
0006687	50	EA					
			IN - MTR Field Entry, New/Remove Employee to/From MTR. INDIANA ONLY.				
260357371	FORM	3955	ISS 08-89				
1952804	500	SH	IL IN MI OH WI				
			33				
			IL - Wage Loan Request/Agreement.				
300089547	FORM	3956	ISS 05-85				
1932459	50	SH	IL IN MI OH WI				
			33				
			IN - Supplemental Input Document -Mtr Entry Loan/Transfer Employee.				
300089554	FORM	3957	ISS 05-85				
1931865	50	SH	IL IN MI OH WI				
			33				
			Mtr Field Entry, Loan/Transfer Employee.				
200004752	FORM	3963 1	ISS 01-82 J25C20				
N		EA	500	6	2500		
			IL - Envelope - Recovery.				
001064484	FORM	3963 3	ISS 11-76 S10M20				
5626408	500	EA	IL IN MI OH WI				
			33				
			IL - Envelope-Coin Telephone Overflow Coins.				
260344122	FORM	3965	ISS 11-88				
1950006	1	EA	IL IN MI OH WI				
			33				
			IL - Envelope - Messenger Service, 15 X 10 1/2IN w/2IN expansion.				
280024597	FORM	3968	ISS 10-78				
1932947		EA	IL IN MI OH WI				
			33				
			IN - Envelope - Filing, Extra Heavy 10 1/2 X 14 1/2				
			FORM 3977	ISS 01-83			
0003716	1	EA					
			IN - Quick Copy Equipment Request. INDIANA ONLY.				
280060799	FORM	3987	ISS 09-85 S1M22				
1933887	100	SH	IL IN MI OH WI				
			33				
			IN - Mandatory Bond Sticker.				
			FORM 3993	ISS 08-90			
0005517	100	EA					
			IN - Request for Approval Authority. INDIANA ONLY.				
280062605	FORM	3995	ISS 05-82 A1.8M1L22				
1931212	2800	SH	IL IN MI OH WI				
			33				
			IN - Basic Output Report, Status & Test Summary.				
260393137	FORM	3997	ISS 10-90 S2M22				
1966119		SH	IL IN MI OH WI				
			33				
			Weekly Time Report Feeder - Indiana.				

DISTRIBUTION SERVICES

NETWORK SERVICES

TOOLS

BUILDING JANITORIAL

AUTOMOTIVE

FORMS/OFFICE SUPPLIES

GENERAL

DATA VOICE

PRODUCT IDENTIFIER		DESCRIPTION					
ITEM NUMBER	ORD. MULT.	SELL UNIT	STD. STOCK	PKG. AVAILABILITY	LEAD TIME / PA	MIN. ORD.	A C
280060807	FORM	3998	ISS	10-86			
1933879	50	SE	IL	IN MI OH WI	33		
IN - Load and Work Time Record.							
0007275	FORM	4000 B	ISS	03-82			
50	EA						
IN - Pre-Employee Medical History. INDIANA ONLY.							
260324488	FORM	4010 1	ISS	04-88			
1944934	50	SH	IL	IN MI OH WI	33		
IN - Authorization For and Report Of Medical Services.							
260345152	FORM	4010 22	ISS	01-89 S1M22			
1950931	50	SE	IL	IN MI OH WI	33		
IN - Authorization For and Report Of Medical Services.							
0003291	FORM	4025	ISS	03-82			
1000	EA						
IN - Request for Employee Fitness Examination. INDIANA ONLY.							
0003292	FORM	4030	ISS	02-86			
500	EA						
IN - Follow-Up Periodic Health Evaluation. INDIANA ONLY.							
0003293	FORM	4031	ISS	09-85			
1000	EA						
IN - Follow-Up Periodic Health Evaluation. INDIANA ONLY.							
001066703	FORM	4034 C	S8M21				
1163105	500	EA	IL	IN MI OH WI	33		
MI - Envelope - Service Application Card.							
001064591	FORM	4040 1	ISS	10-80 S5M20			
6677781	1	EA	IL	IN MI OH WI	33		
IL - ENVELOPE - Plain, Estimates, 12in X 10in X 1in.							
001064609	FORM	4040 2	ISS	06-79 S25C20			
6677765	1	EA	IL	IN MI OH WI	33		
IL - Envelope - Plain, Estimates, 12 X 10 X 2IN.							
0005521	FORM	4051	ISS	09-83			
25	EA						
IN - Employees Medical-Treatment Record. INDIANA ONLY.							
200002699	FORM	4063 2C	J40M21				
N	EA	500	6	30000			
Envelope.							
200002335	FORM	4063 6C	J15M21				
N	EA	250	6	15000			

PRODUCT IDENTIFIER		DESCRIPTION					
ITEM NUMBER	ORD. MULT.	SELL UNIT	STD. STOCK	PKG. AVAILABILITY	LEAD TIME / PA	MIN. ORD.	A C
001066711	FORM	4063 C	S24M21				
1163147	500	EA	IL	IN MI OH WI	33		
MI - Envelope - General use catalog 9 X 6IN, 24LB brown Kraft.							
001066737	FORM	4065 C					
1163188	500	EA	IL	IN MI OH WI	33		
Envelope.							
0007278	FORM	4080 B	ISS	06-66			
50	EA						
IN - Medical Disability Information Letter for Medical Department use only. INDIANA ONLY.							
002096782	FORM	4104	ISS	02-84 S3M20			
5657221	50	SE	IL	IN MI OH WI	33		
IL - Memo to Dial Admisinstration Switching Dial Clerk							
001064872	FORM	4126					
5627489	500	SH	IL	IN MI OH WI	33		
IL - Weekly Work Schedule.							
001064880	FORM	4128					
5627505	500	SH	IL	IN MI OH WI	33		
IL - Force Planning Schedule.							
260428693	FORM	4151	ISS	08-91 S10M20			
1978106	10000	EA	IL	IN MI OH WI	33		
IL - Request for Customer to Contact Business Office.							
260338413	FORM	4151 2	ISS	08-88			
1948166	500	EA	IL	IN MI OH WI	33		
IL - Request For Customer To Contact Business Office.							
300030426	FORM	4164	ISS	09-84 S25M20			
5107490	500	SH	IL	IN MI OH WI	33		
IL - Statement of Collection.							
0005532	FORM	4165	ISS	02-79			
25	EA						
IN - Medical chart for Medical Department use only. INDIANA ONLY.							
300089638	FORM	4184	ISS	07-85			
1932483	25	SH	IL	IN MI OH WI	33		
IN - Employee Injury Report.							
001020981	FORM	4187 1					
1163360	50	EA	IL	IN MI OH WI	33		
Tag.							
280023920	FORM	4187 2	S15M21				
1922187	500	EA	IL	IN MI OH WI	33		
MI - Money Bag Tag '\$1000 Quarters'.							

DISTRIBUTION SERVICES

NETWORK SERVICES

TOOLS

BUILDING JANITORIAL

AUTOMOTIVE

FORMS/OFFICE SUPPLIES

GENERAL

DATA VOICE

FORM

PRODUCT IDENTIFIER		DESCRIPTION						
ITEM NUMBER	ORD. MULT.	SELL UNIT	STD. PKG.	LEAD TIME	MIN. ORD.	A	C	
			STOCK AVAILABILITY / PA					
280024514	FORM	4200	ISS 01-84					
1932491	500	EA	IL IN MI OH WI					
			33					
IN - Envelope - Medical Director, 8 7/8 X 3 7/8, white.								
001064989	FORM	4216						
5627943	500	EA	IL IN MI OH WI					
			33					
IL - Department Estimate Cover, Department Head Copy.								
260364708	FORM	4216 2	ISS 11-89					
1954578	500	EA	IL IN MI OH WI					
			33					
IL - Department Estimate Cover - Executive Copy.								
260404801	FORM	4217 2	ISS 09-90 S1M20					
1969204	1000	EA	IL IN MI OH WI					
			33					
IL - District Manager-Engineering.								
260404793	FORM	4217 3	ISS 09-90 S1M20					
1969196		EA	IL IN MI OH WI					
			33					
IL - District Manager-Outside Plant Engineering Support.								
260417860	FORM	4217 4	ISS 04-91 S1M20					
1972778	1000	EA	IL IN MI OH WI					
			33					
IL - Project Cover Sheet - General Manager, Customer Services.								
003006210	FORM	4217 5	ISS 01-79 S15020					
N		SH	25	4	150			
IL - Project Cover Sheet - Manager Construction								
003006202	FORM	4217 6	ISS 01-79 S15020					
N		SH	25	4	150			
IL - Project Cover Sheet Transmission Engineer.								
003006194	FORM	4217 7	ISS 01-79 S15020					
N		SH	25	4	150			
IL - Project Cover Sheet - Comptroller's Copy.								
260419643	FORM	4217-1	ISS 09-90 S1M20					
1974501	1000	EA	IL IN MI OH WI					
			33					
IL - Project Cover Sheet - Staff Manager - Evaluation Costs.								
002035046	FORM	4234	ISS 01-81					
5646760	100	EA	IL IN MI OH WI					
			33					
IL - TAG - Mail Service Delivery Record.								
260376439	FORM	4259 L	J21M21					
N		SH	5000	8	21000			
MI - Union/Management Charitable Fund Pledge.								
002081552	FORM	4273 1	ISS 11-82					
5651968	500	SH	IL IN MI OH WI					
			33					
IL - Past Due Notice, Final.								

PRODUCT IDENTIFIER		DESCRIPTION						
ITEM NUMBER	ORD. MULT.	SELL UNIT	STD. PKG.	LEAD TIME	MIN. ORD.	A	C	
			STOCK AVAILABILITY / PA					
002081560	FORM	4274 1	ISS 11-82 S2M20					
5651984	500	SH	IL IN MI OH WI					
			33					
IL - Final Notice.								
	FORM	4300	ISS 03-84					
0005541	25	EA	IL IN MI OH WI					
IN - Application for Appointment as Medical Consultant for Medical Department use only. INDIANA ONLY.								
001054816	FORM	4311 C						
1183600	500	SH	IL IN MI OH WI					
			33					
300069747	FORM	4373	ISS 07-85					
5120998	500	SH	IL IN MI OH WI					
			33					
IL - Busy Study - Customer Line.								
260321328	FORM	4390 1	ISS 01-88					
1942458	500	SH	IL IN MI OH WI					
			33					
IL - Employees report of Occupational Injury or Illness.								
001065135	FORM	4393						
5628925	100	EA	IL IN MI OH WI					
			33					
IL - Folder, Blue.								
002095529	FORM	4477 4						
5101832	500	SH	IL IN MI OH WI					
			33					
IL - Job Activities Coding Form.								
300088341	FORM	4499	ISS 04-86					
1920017	50	SE	IL IN MI OH WI					
			33					
IL - Directory Advertising Memorandum.								
300072386	FORM	4503	ISS 10-90 J9M20					
N		SH	2500	8	9000			
IL - Auditor's Verification Notice.								
001065226	FORM	4505						
6634543	1000	SH	IL IN MI OH WI					
			33					
IL - Memostub.								
300081767	FORM	4521	ISS 01-86					
5125849	25	SE	IL IN MI OH WI					
			33					
IL - Information For Directory Advertising Collection.								
300089372	FORM	4562	ISS 02-79 S15M22					
1932509	50	SH	IL IN MI OH WI					
			33					
IN - Mechanized Daily Time Record.								
300089380	FORM	4565	ISS 02-79					
1932517	50	SH	IL IN MI OH WI					
			33					
IN - Daily/Weekly Work Report Transmittals.								

PRODUCT IDENTIFIER		DESCRIPTION						
ITEM NUMBER	ORD. MULT.	SELL UNIT	STD. PKG. STOCK	PKG. AVAILABILITY	LEAD TIME / PA	MIN. ORD.	A C	
300093770 FORM		4570	ISS 10-86					
1931857	250	SH	IL	IN	MI	OH	WI	
			33					
			IN - Load and Work Time Record.					
FORM		4571	ISS 01-90					
0006861	100	EA	IN - Management Change. INDIANA ONLY.					
FORM		4579	ISS 08-79					
0005564	25	EA	IN - Data Base Add Record. INDIANA ONLY.					
FORM		4581	ISS 07-85					
0005565	25	EA	IN - Subscriber Carrier Requirements, Digital. INDIANA ONLY.					
FORM		4586	ISS 03-79					
0007292	25	EA	IN - Ault Transformer Flyer. INDIANA ONLY.					
280008756 FORM		4587	ISS 04-86					
1921379	50	SH	IL	IN	MI	OH	WI	
			33					
			IL - Label - Illinois Bell Records Center.					
300093796 FORM		4594	ISS 07-79 A12M22					
1932533	50	SH	IL	IN	MI	OH	WI	
			33					
			IN - Confirming Disconnect Notice.					
300093804 FORM		4595	ISS 11-79					
1932541	50	SH	IL	IN	MI	OH	WI	
			33					
			IN - Denial Treatment Notice, Residence Accounts.					
FORM		4598	ISS 10-82					
0003307	500	EA	IN - Letter of Transmittal. INDIANA ONLY.					
260376447 FORM		4601	IH	J45M21				
N		SH	2500	8	45000			
			MI - Collection Report.					
300094174 FORM		4610	ISS 04-79					
1932558	50	SH	IL	IN	MI	OH	WI	
			33					
			IN - ICIS - FA Table Utility Form.					
FORM		4611	ISS 06-81					
0007299	50	SE	IN - Construction Daily Work Schedule MTR. INDIANA ONLY.					
280045428 FORM		4649	ISS 11-79 J12M24					
N		SH	2000	6	12000			
260322722 FORM		4652	ISS 01-88					
N		SH	50	4	5000			
			Employee Attendance/Punctuality Record.					
260395553 FORM		4652	ISS 09-90 S5M22					
1966879	50	SH	IL	IN	MI	OH	WI	
			33					
			IN - Employee Attendance/Punctuality Record.					

PRODUCT IDENTIFIER		DESCRIPTION						
ITEM NUMBER	ORD. MULT.	SELL UNIT	STD. PKG. STOCK	PKG. AVAILABILITY	LEAD TIME / PA	MIN. ORD.	A C	
FORM		4659						
0003718	200	EA	IN - Contractor's Invoice Placing Buried Service Wire. INDIANA ONLY.					
280062746 FORM		4660	ISS 06-79					
1934950	1	BK	IL	IN	MI	OH	WI	
			33					
			Pamphlet Customer Rights.					
FORM		4661	ISS 12-87					
0005591	100	EA	IN - Building Service Call. INDIANA ONLY.					
280024522 FORM		4670	ISS 01-84					
1932574	500	EA	IL	IN	MI	OH	WI	
			33					
			IN - Envelope - Disconnect Notice 7 1/2 X 4 1/2, white.					
FORM		4700	ISS 06-84					
0003318	500	EA	IN - Speakers Bureau Booking Report Form. INDIANA ONLY.					
FORM		4703	ISS 10-80					
0005607	25	EA	IN - Monthly Report of Postage Meter Usage. INDIANA ONLY.					
300089455 FORM		4710	ISS 06-81					
1931840	25	SH	IL	IN	MI	OH	WI	
			33					
			IN - Directory Assistance Charging Exemption Certificate.					
FORM		4711	ISS 08-79					
0007306	50	EA	IN - Directory Assistance Charging Exemption Certificate. INDIANA ONLY.					
FORM		4720	ISS 09-82					
0005620	25	EA	IN - Initial Fault Line Tests. INDIANA ONLY.					
FORM		4723	ISS 01-86					
0003722	500	EA	IN - Motor Vehicle Accident Check List. INDIANA ONLY.					
FORM		4768	ISS 08-79					
0005652	200	EA	IN - Call Back. INDIANA ONLY.					
FORM		4773	ISS 09-90					
0006941	100	EA	IN - Request for Special Assembly of Equipment. INDIANA ONLY.					
FORM		4773 1	ISS 09-90					
0006940	100	EA	IN - Special Assembly Routing Sheet. INDIANA ONLY.					
FORM		4774	ISS 09-90					
0006939	100	EA	IN - Price Quotation for a Special Assembly. INDIANA ONLY.					

DISTRIBUTION SERVICES
 NETWORK SERVICES
 TOOLS
 BUILDING JANITORIAL
 AUTOMOTIVE
 FORMS/OFFICE SUPPLIES
 GENERAL
 DATA VOICE

DISTRIBUTION SERVICES

NETWORK SERVICES

TOOLS

BUILDING JANITORIAL

AUTOMOTIVE

FORMS/OFFICE SUPPLIES

GENERAL

DATA VOICE

FORM

PRODUCT IDENTIFIER		DESCRIPTION					
ITEM NUMBER	ORD. MULT.	SELL UNIT	STD. PKG. STOCK AVAILABILITY / PA	LEAD TIME	MIN. ORD.	A	C
280041740		FORM	4778	ISS 04-83	J10M24		
N		EA	500	4	10000		
Specify Color.							
300089471		FORM	4796	ISS 04-82	S15C22		
1932582	25	SE	IL IN MI OH WI	33			
IN - Notification of Training Completed.							
0005674		FORM	4797	ISS 11-79			
25		EA					
IN - Notification of Completed Courses. INDIANA ONLY.							
0005675		FORM	4798	ISS 10-79			
50		EA					
IN - Course Completion Notification. INDIANA ONLY.							
300089489		FORM	4799	ISS 04-82			
1932590	25	SE	IL IN MI OH WI	33			
IN - Training Course Certification.							
0003324		FORM	4800	ISS 02-88			
25		SE					
IN - Record Retention Assignment Request & Approval. INDIANA ONLY.							
260318191		FORM	4816	ISS 12-83			
1941211	500	SH	IL IN MI OH WI	33			
IL - Application for Payment & Sworn Statement of Contractor & Subcontractor To Owner.							
260371638		FORM	4820	ISS 01-90			
1956128	500	EA	IL IN MI OH WI	33			
IL - Notice - Illinois Bell Working In Your Area.							
260371620		FORM	4820 1	ISS 01-90			
1956110	500	EA	IL IN MI OH WI	33			
IL - Notice Resoration Completed.							
280060823		FORM	4821	ISS 10-79			
1933895	25	SE	IL IN MI OH WI	33			
Request to Examine Personnel Records.							
260426879		FORM	4821	ISS 10-79	S2M22		
N		EA	1	2	1		
Request To Examine Personnel Records.							
0005685		FORM	4822	ISS 10-79			
25		EA					
IN - Authorization for Release of Personal Information. INDIANA ONLY.							
300059888		FORM	4823	ISS 02-85			
5117655	100	EA	IL IN MI OH WI	33			
IL - Remreed Grid Trouble Report.							
0005686		FORM	4823	ISS 10-79			
25		EA					
IN - Authorization List. INDIANA ONLY.							

PRODUCT IDENTIFIER		DESCRIPTION					
ITEM NUMBER	ORD. MULT.	SELL UNIT	STD. PKG. STOCK AVAILABILITY / PA	LEAD TIME	MIN. ORD.	A	C
		FORM	4824	ISS 10-79			
0005687	25	EA					
IN - Internal Disclosure Log. INDIANA ONLY.							
		FORM	4825	ISS 10-79			
0005688	25	EA					
IN - Summary Log of Employee Inspection of Records. INDIANA ONLY.							
		FORM	4836	ISS 04-87			
0005697	25	EA					
IN - Employee Relocation Notification. INDIANA ONLY.							
		FORM	4846	ISS 11-83			
0005704	25	EA					
IN - ICIS/FA-CTMS Table Update/Request Transmittal. INDIANA ONLY.							
		FORM	4852	ISS 01-82			
0003333	5000	EA					
IN - Residence Order. INDIANA ONLY.							
		FORM	4852 1				
0007313	25	EA					
IN - Residence Order Supplement, plain. INDIANA ONLY.							
		FORM	4868	ISS 09-91			
0003075	200	SE					
IN - MTR Daily Work Report. INDIANA ONLY.							
		FORM	4868 1	ISS 09-91			
0006985	200	SE					
IN - MTR Daily Work Report C. INDIANA ONLY.							
300086634		FORM	4878	ISS 03-86			
5127456	50	SE	IL IN MI OH WI	33			
IL - Directory Error Report.							
		FORM	4882	ISS 03-88			
0003110	1000	EA					
IN - Code Point Notification. INDIANA ONLY.							
		FORM	4885	ISS 06-88			
0005725	25	EA					
IN - Budget Transfer Report. INDIANA ONLY.							
		FORM	4886	ISS 07-83			
0003342	500	EA					
IN - Code Point Notification. INDIANA ONLY.							
		FORM	4890	ISS 07-80			
0003343	4000	EA					
IN - Bird Special Service Order. INDIANA ONLY.							
		FORM	4897	ISS 01-84			
0007318	500	EA					
IN - Envelope deposit receipt 6 1/8IN X 4 1/8IN white. INDIANA ONLY.							
		FORM	4898	ISS 01-80			
0005732	25	EA					
IN - Suitability Test for Subscriber Carrier. INDIANA ONLY.							

PRODUCT IDENTIFIER		DESCRIPTION				
ITEM NUMBER	ORD. MULT.	SELL UNIT	STD. PKG. STOCK AVAILABILITY / PA	LEAD TIME	MIN. ORD.	A C
0005733	50	EA	FORM 4899 ISS 05-85			
IN - Clearing Inductive Noise-Sub Lines. INDIANA ONLY.						
0005739	25	EA	FORM 4907 ISS 01-80			
IN - Tips on Applying for Jobs. INDIANA ONLY.						
0003728	500	EA	FORM 4909 ISS 11-80			
IN - Cosmos Report Request INDIANA ONLY.						
260325006	FORM	4929	ISS 06-88			
1945196	25	SE	IL IN MI OH WI			
IL - Request For Billing.						
001055102	FORM	4931	C			
1164921	25	EA	IL IN MI OH WI			
Envelope.						
280044538	FORM	4933				
N		EA	500	6	17000	
260314729	FORM	4937	B ISS 05-91 S100M20			
1940973	500	EA	IL IN MI OH WI			
IL - Envelope - Currency - Business Offices.						
300089257	FORM	4951	ISS 01-83			
1932632	50	SH	IL IN MI OH WI			
IN - Installation Appointments Not Met.						
0006820	100	EA	FORM 4972 ISS 02-82			
IN - Cosmos Trouble Report INDIANA ONLY.						
280046962	FORM	4975	ISS 10-86			
1925990	500	SH	IL IN MI OH WI			
Delayed Order Entered Held Order.						
0005780	25	EA	FORM 4976 ISS 02-80			
IN - AIS Operator Development Summary. INDIANA ONLY.						
0003351	200	EA	FORM 4977 ISS 02-80			
IN - Plug-In Equipment Order. INDIANA ONLY.						
0005781	25	EA	FORM 4978 ISS 07-83			
IN - Information Systems-Time & Cost Estimate. INDIANA ONLY.						
280045477	FORM	4981	ISS 02-84 L1CM24			
N		SH	3000	1	100000	
WI - MTAS.						

PRODUCT IDENTIFIER		DESCRIPTION				
ITEM NUMBER	ORD. MULT.	SELL UNIT	STD. PKG. STOCK AVAILABILITY / PA	LEAD TIME	MIN. ORD.	A C
002081594	FORM	4988	8 ISS 10-82 S260M20			
5652024	500	EA	IL IN MI OH WI			
IL - Envelope - U.S. Mail, white 7 1/2 X 4 1/2IN - Bill Treatment.						
002092013	FORM	4989	ISS 08-83 S40M20			
5656462	250	EA	IL IN MI OH WI			
IL - Envelope, US Mail, No Window Bill Treatment.						
280045485	FORM	4997	ISS 10-83 L125M24			
N		SH	2700	1	125000	
WI - Basic Output Report.						
0005796	25	EA	FORM 4998 ISS 09-85			
IN - ACF2 Data Security Authorization. INDIANA ONLY.						
0007324	50	EA	FORM 4999			
INDIANA ONLY.						
300089281	FORM	4999	ISS 03-80			
1932640	50	SH	IL IN MI OH WI			
IN - Back Order Notice.						
260330733	FORM	5000	ISS 08-88			
1947086	50	SE	IL IN MI OH WI			
IL - Office Supplies Requisition.						
0005800	50	EA	FORM 5002			
IN - MTR Field Entry-Support Input Document. INDIANA ONLY.						
0005800	50	EA	FORM 5002			
IN - MTR Field Entry-Support Input Document. INDIANA ONLY.						
200004786	FORM	5014	ISS 05-84 J10M20			
N		EA	1000	6	10000	
IL - Envelope - Identification Card.						
0006925	50	EA	FORM 5018 ISS 03-80			
IN - Long Distance Inquiries. INDIANA ONLY.						
002075232	FORM	5020	2			
1448589	500	SE	IL IN MI OH WI			
0005810	25	EA	FORM 5021 ISS 05-81			
IN - Anticipated Disability Supl Payroll Information. INDIANA ONLY.						
0003206	500	EA	FORM 5046			
IN - Receipt for Checks. INDIANA ONLY.						

DISTRIBUTION SERVICES
 NETWORK SERVICES
 TOOLS
 BUILDING JANITORIAL
 AUTOMOTIVE
 FORMS/OFFICE SUPPLIES
 GENERAL
 DATA VOICE

DISTRIBUTION SERVICES

NETWORK SERVICES

TOOLS

BUILDING JANITORIAL

AUTOMOTIVE

FORMS/OFFICE SUPPLIES

GENERAL

DATA VOICE

FORM

PRODUCT IDENTIFIER		DESCRIPTION							
ITEM NUMBER	ORD. MULT.	SELL UNIT	STD. PKG. STOCK AVAILABILITY / PA	LEAD TIME	MIN. ORD.	A C			
0005851	200	EA	FORM 5052	ISS 09-80				IN - Trunk Order Crossconnection-Outgoing. INDIANA ONLY.	
0003260	500	EA	FORM 5065	ISS 07-80				IN - Buried Drop Request. INDIANA ONLY.	
0003369	500	EA	FORM 5077	ISS 06-89				IN - Test Battery Data Record. INDIANA ONLY.	
0003371	500	EA	FORM 5079	ISS 04-84				IN - Skills & Work Simulations Test Data Record. INDIANA ONLY.	
0003372	1000	EA	FORM 5080	ISS 05-91				IN - Mini-Course Test Data Record. INDIANA ONLY.	
300089331	N	SH	FORM 5133	ISS 04-82	25	4	2000	IN - Plant Work Report Weekly.	
300089349	1932665	50	FORM 5134	ISS 03-86	IL	IN	MI	OH	WI
					33				
									IN - Loop Maintenance Quality Control Ticket.
0006676	25	EA	FORM 5134 1	ISS 12-85					IN - Loop I&M Quality Performance Record. INDIANA ONLY.
0007337	50	EA	FORM 5135	ISS 04-82					IN - Loop Maintenance Quality Analysis Record. INDIANA ONLY.
0005893	25	EA	FORM 5142	ISS 02-83					IN - Routine Job Order Disposition. INDIANA ONLY.
001163195	N	SH	FORM 5153	ISS 09-84	S2M20	500	4	2000	IL - Biographical Data Sheet.
300095684	1932681	50	FORM 5181	ISS 09-80	IL	IN	MI	OH	WI
					33				
									IN - Label - Teletype Data Job Identification.
0006852	100	EA	FORM 5182	ISS 05-91					IN - Message Detail Study Request-Internal. INDIANA ONLY.
0006853	100	EA	FORM 5183	ISS 05-91					IN - Message Detail Study Request - Customer. INDIANA ONLY.

PRODUCT IDENTIFIER		DESCRIPTION							
ITEM NUMBER	ORD. MULT.	SELL UNIT	STD. PKG. STOCK AVAILABILITY / PA	LEAD TIME	MIN. ORD.	A C			
0003385	2000	EA	FORM 5186	ISS 10-80					IN - Public Services Contact Memo. INDIANA ONLY.
200002731	N	EA	FORM 5200 J	J15M21	650	6	15000		Envelope for mailing time reports to record supervisor - Michigan.
280080300	1936534	50	FORM 5227	ISS 06-87	IL	IN	MI	OH	WI
					33				
									IL - Notification to Data Processing Center.
003007382	N	SH	FORM 5237	ISS 04-88	L136M20	500	2	500	
									IL - Batch Trailer Card.
003006962	N	SH	FORM 5237 1	ISS 04-88	L100M20	500	2	500	
									IL - Batch Header Card 1.
0005950	2525	EA	FORM 5245	ISS 03-87					IN - Forms Notifier. INDIANA ONLY.
001055383	1165944	500	FORM 5248 C		IL	IN	MI	OH	WI
					33				
0005956	25	EA	FORM 5254	ISS 11-80					IN - CDP Header Record. INDIANA ONLY.
200004794	N	EA	FORM 5255 1	ISS 01-89	L25M20	500	2	500	
									IL - Envelope - Customer Mailing (RPC).
200005387	N	EA	FORM 5255 2	ISS 05-86	L50M20	5000	2	500	
									IL - Envelope - Check Return.
260417258	N	EA	FORM 5255 3	ISS 03-91	L20M20	500	2	500	
									IL - Envelope (RPC) - Bedford Pk, no window, 8 3/4in x 4 1/2in.
260417266	N	EA	FORM 5255 4	ISS 03-91	L20M20	500	2	500	
									IL - Envelope (RPC) - Decatur, no window, 8 3/4in x 4 1/2in.
260417241	N	EA	FORM 5256	ISS 03-91	L20M20	500	2	500	
									IL - Envelope (RPC) - Chicago, window, 7 3/4in x 4 1/2in.
260417233	N	EA	FORM 5256 1	ISS 03-91	L20M20	500	2	500	
									IL - Envelope (RPC) - Bedford Pk, window, 7 3/4in x 4 1/2in.
260417225	N	EA	FORM 5256 2	ISS 03-91	L20M20	500	2	500	
									IL - Envelope (RPC) - Decatur, window, 7 3/4in x 4 1/2in.

PRODUCT IDENTIFIER							DESCRIPTION						
ITEM NUMBER	ORD. MULT.	SELL UNIT	STD. PKG. STOCK AVAILABILITY / PA	LEAD TIME	MIN. ORD.	A C							
260426861 FORM							5256 3 ISS 07-91 L12M20						
N		EA	500	2	500		IL - Envelope - RPC- Decatur-window 8 7/8 X 3 7/8.						
260426853 FORM							5256 4 ISS 07-91 L12M20						
N		EA	500	2	500		IL - Envelope - RPC-Bedford Pk - Window - 8 7/8 x 3 7/8.						
260417217 FORM							5261 ISS 03-91 L20M20						
N		EA	500	2	500		IL - Envelope (RPC) - Bedford Pk, no window, 7 3/4in x 4 1/4in.						
260417209 FORM							5261 1 ISS 03-91 L20M20						
N		EA	500	2	500		IL - Envelope (RPC) - Decatur, no window, 7 3/4in x 4 1/4in.						
260417191 FORM							5262 ISS 03-91 L20M20						
N		EA	500	2	500		IL - Envelope (RPC) - Bedford Pk, no window, 7 3/4in x 4 1/2in.						
260417183 FORM							5262 1 ISS 03-91 L20M20						
N		EA	500	2	500		IL - Envelope (RPC) - Decatur, no window 7 3/4in x 4 1/2in.						
		FORM	5266	ISS 12-87									
0005965	100	EA					IN - Checks Returned to Cash Source 112. INDIANA ONLY.						
		FORM	5284	ISS 12-80									
0005969	100	EA					IN - Sickness/Death Benefit Authorization Record. INDIANA ONLY.						
		FORM	5285	ISS 12-80									
0006172	100	EA					IN - Sickness/Death Benefit Authorization Record. INDIANA ONLY.						
		FORM	5290	ISS 01-81									
0006593	100	EA					IN - CDP Table Update Form. INDIANA ONLY.						
		FORM	5291	ISS 12-86									
0005972	50	EA					IN - CDP Transmittal. INDIANA ONLY.						
		FORM	5292	ISS 05-91									
0005973	10	EA					IN - MJE Input Document. INDIANA ONLY.						
300089109 FORM							5306 ISS 01-81						
1932699	50	SH	IL IN MI OH WI	33			IN - Stock Material Card.						
		FORM	5330	ISS 07-81									
0005992	1	EA					IN - Forms Control System PJ569 Update Coding Sheet. INDIANA ONLY.						

PRODUCT IDENTIFIER							DESCRIPTION						
ITEM NUMBER	ORD. MULT.	SELL UNIT	STD. PKG. STOCK AVAILABILITY / PA	LEAD TIME	MIN. ORD.	A C							
FORM							5340 ISS 02-83						
0003424	500	EA					IN - Audio Visual Equipment Request. INDIANA ONLY.						
		FORM	5342	ISS 06-82									
0003426	5000	EA					IN - MVMCC Contact Memo. INDIANA ONLY.						
		FORM	5344	ISS 08-82									
0003427	1	EA					IN - House Service Inspection. INDIANA ONLY.						
001055425 FORM							5344 C						
1168066	100	EA	IL IN MI OH WI	33			Envelope.						
		FORM	5344 D	ISS 03-92									
N							MI - Envelope - Record Posting File.						
		FORM	5355 E		J25C21								
N		EA	250	6	2500								
		FORM	5356	ISS 06-86									
0003145	1	EA					IN - WATS Usage Investigation. INDIANA ONLY.						
		FORM	5380	ISS 09-90									
0007353	1	EA					IN - Dental Plan For Part-Time Employee. INDIANA ONLY.						
		FORM	5381	ISS 11-82									
0007354	1	EA					IN - Marketing Order Memo, page 1. INDIANA ONLY.						
		FORM	5382	ISS 05-81									
0007355	50	SE					IN - Marketing Order Memo, page 2. INDIANA ONLY.						
300089190 FORM							5395 ISS 04-81						
1932715	25	SH	IL IN MI OH WI	33			IN - Employee Contact Record.						
		FORM	5400	ISS 12-86									
0003441	1	EA					IN - Purchase Order, Outside Plant, Tool Purchase Order - Capital Tool Coordinator Only. INDIANA ONLY.						
		FORM	5400 B		J150M21								
N		EA	5600	8	150000		MI - Label - Directory.						
		FORM	5408	ISS 04-88									
0006811	25	EA					IN - Computer Resource Usage Authorization B.M. 10,000. INDIANA ONLY.						
		FORM	5416	ISS 05-81									
0003446	5000	EA					IN - BOCC Exceptional Time. INDIANA ONLY.						

DISTRIBUTION SERVICES
 NETWORK SERVICES
 TOOLS
 BUILDING JANITORIAL
 AUTOMOTIVE
 FORMS/OFFICE SUPPLIES
 GENERAL
 DATA VOICE

FORM

DISTRIBUTION SERVICES

NETWORK SERVICES

TOOLS

BUILDING JANITORIAL

AUTOMOTIVE

FORMS/OFFICE SUPPLIES

GENERAL

DATA VOICE

PRODUCT IDENTIFIER		DESCRIPTION					
ITEM NUMBER	ORD. MULT.	SELL UNIT	STD. PKG. STOCK AVAILABILITY / PA	LEAD TIME	MIN. ORD.	A	C
0007359	25	EA	FORM 5427	ISS 05-81			
IN - Application for Extention of Leave of Absence. INDIANA ONLY.							
0007360	25	EA	FORM 5428	ISS 01-90			
IN - Extension Application for Care of Newborn Children/Adoption Leave of absence. INDIANA ONLY.							
1957761	25	SH	260375936 FORM 5432	ISS 02-90 S5M22	IL IN MI OH WI	33	
IN - Distribution Preparation Miscellaneous Request.							
1953471	1	BK	260359716 FORM 5444	ISS 06-89	IL IN MI OH WI	33	
IN - Network Special Services Trouble Ticket.							
1953208	50	SH	260358536 FORM 5444 1	ISS 06-89 S3M22	IL IN MI OH WI	33	
IN - Network Trouble Ticket Sheets.							
0003451	500	EA	FORM 5445	ISS 06-81			
IN - Estimate and Job Order Review. INDIANA ONLY.							
0003452	200	EA	FORM 5450	ISS 10-84			
IN - Fraud Inquiry. INDIANA ONLY.							
0006771	25	EA	FORM 5460	ISS 02-89			
IN - Performance Trend Record. INDIANA ONLY.							
0006769	25	EA	FORM 5461	ISS 10-87			
IN - Performance Record. INDIANA ONLY.							
0006770	25	EA	FORM 5462	ISS 10-87			
IN - Service Representative and Service Order Writer Training Appraisal. INDIANA ONLY.							
0006885	100	EA	FORM 5483	ISS 03-90			
IN - Public Telephone Location Work Sheet. INDIANA ONLY.							
0009030	1	EA	FORM 5489				
INDIANA ONLY.							
0006776	25	EA	FORM 5492	ISS 10-87			
IN - Pay & Tax Adjustment. INDIANA ONLY.							
1923235	50	SE	280036468 FORM 5501	ISS 05-86	IL IN MI OH WI	33	
IL - Drafting Work Order.							

PRODUCT IDENTIFIER		DESCRIPTION					
ITEM NUMBER	ORD. MULT.	SELL UNIT	STD. PKG. STOCK AVAILABILITY / PA	LEAD TIME	MIN. ORD.	A	C
0006897	100	EA	FORM 5512	ISS 06-90			
IN - Application for Reduction in Interstate Rates. INDIANA ONLY.							
0003473	1000	EA	FORM 5513	ISS 10-81			
IN - Data Processing Center 1 - Job Instruction. INDIANA ONLY.							
0006079	100	EA	FORM 5519	ISS 01-82			
IN - Miscellaneous Accounts Payment Memo. INDIANA ONLY.							
0006080	100	EA	FORM 5520	ISS 12-83			
IN - Miscellaneous Accounts Adjustment Voucher. INDIANA ONLY.							
280000910	N	SH	FORM 5535	ISS 01-84 A40M22	5500	2	5500
IN - Commercial Copy, Miscellaneous Billing.							
0003480	500	EA	FORM 5549	ISS 05-82			
IN - DPC-1 Tape Library Request. INDIANA ONLY.							
1931725	25	SH	300095601 FORM 5553	ISS 06-85 S1M22	IL IN MI OH WI	33	
IN - Motor Vehicle Accident Report.							
0003482	500	EA	FORM 5559	ISS 02-82			
IN - Independent Company Service Order. INDIANA ONLY.							
0006109	1	EA	FORM 5564	ISS 08-86			
IN - Traffic Study Request. INDIANA ONLY.							
0006110	25	EA	FORM 5565	ISS 05-85			
IN - DAS/C Query - 812. INDIANA ONLY.							
1955807	25	SE	260369319 FORM 5566	ISS 03-90 AS10M22	IL IN MI OH WI	33	
IN - Request for Materials.							
0003487	1000	EA	FORM 5575	ISS 09-82			
IN - FA Interview Documentation. INDIANA ONLY.							
0003493	500	EA	FORM 5588	ISS 09-82			
IN - DPC 1 Special Instructions Request. INDIANA ONLY.							
0003497	2000	EA	FORM 5596	ISS 04-90			
IN - Special Services Order Memo - page 1. INDIANA ONLY.							

PRODUCT IDENTIFIER		DESCRIPTION					
ITEM NUMBER	ORD. MULT.	SELL UNIT	STD. PKG. STOCK AVAILABILITY / PA	LEAD TIME	MIN. ORD.	A C	
0003334	5000	EA	FORM 5596 1 ISS 05-86				IN - Special Services Order Memo - SP. INDIANA ONLY.
0006124	1	EA	FORM 5607 ISS 02-82				IN - Medical Expense Plan - Surviving Dependent. INDIANA ONLY.
0005855	100	PD	FORM 5608 ISS 03-86				IN - Data Work Sheet, 50/PD. INDIANA ONLY.
0003502	500	EA	FORM 5609 ISS 03-89				IN - BOCC Alarm Ticket. INDIANA ONLY.
0006927	100	EA	FORM 5614 ISS 10-90				IN - Marketing Compensation Plan. INDIANA ONLY.
0003506	250	EA	FORM 5623 ISS 05-90				IN - Test Battery Data Record - IL. INDIANA ONLY.
260439492	N	BK	FORM 5636 ISS 08-91 S10M22	25	8	10000	IN - Customer Work Invoice.
300095635	1932111	50 SH	FORM 5638 ISS 03-86	IL IN MI OH WI	33		IN - Loop I&M Quality Inspection Tally Sheet.
0003513	50	EA	FORM 5648 ISS 01-88				IN - DA Operator Initial Training/Computer - CCL. INDIANA ONLY.
300095650	1931741	50 SH	FORM 5652 ISS 03-82	IL IN MI OH WI	33		IN - Local Construction Quality Inspection.
260338306	1948158	25 SE	FORM 5652 ISS 11-88 S2M20	IL IN MI OH WI	33		IL - Equipment Request.
260367677	1955377	50 SH	FORM 5654 ISS 11-89 S3M22	IL IN MI OH WI	33		
001055524	1166389	100 EA	FORM 5655 C	IL IN MI OH WI	33		Envelope.
260378799	N	SE	FORM 5661 ISS 01-84 A11M23	50	8	50	OH - Automotive Operations Purchase Order.

PRODUCT IDENTIFIER		DESCRIPTION					
ITEM NUMBER	ORD. MULT.	SELL UNIT	STD. PKG. STOCK AVAILABILITY / PA	LEAD TIME	MIN. ORD.	A C	
0007379	25	EA	FORM 5669 ISS 04-84				IN - Job Evaluation Request/Evaluation Results. INDIANA ONLY.
0003757	25	EA	FORM 5695 ISS 05-82				IN - Reorganization Details. INDIANA ONLY.
6604629	50	SE	001066232 FORM 5700	IL IN MI OH WI	33		IL - Transmittal, Information To Law Department.
1979898	500	BK	260433206 FORM 5705 ISS 07-91 S3M22	IL IN MI OH WI	33		IN - Standards for Customer Premises Inside Wire.
0007388	25	SE	FORM 5707 ISS 05-82				IN - Statement/Premises Work & Materials Furnished. INDIANA ONLY.
1948737	1	BK	260339452 FORM 5709 ISS 10-88	IL IN MI OH WI	33		IN - Outside Plant Trouble Ticket.
1180810	500	EA	002068120 FORM 5710 ISS 04-82 S60M20	IL IN MI OH WI	33		IL - Work Assignment Summary.
0006210	50	EA	FORM 5714 ISS 03-87				IN - Data Entry User Transmittal. INDIANA ONLY.
300095494	N	SH	FORM 5722 ISS 01-86 S5M22	25	4	5000	IN - Station Installation Material List.
0006223	1000	EA	FORM 5742 ISS 06-82				IN - Input/Output Control Card. INDIANA ONLY.
260376496	N	SH	FORM 5742 B J186M21	7500	8	186000	MI - Directory Delivery - Outstate.
0003531	500	EA	FORM 5743 ISS 06-82				IN - Measured Service Investigation. INDIANA ONLY.
0003532	5000	EA	FORM 5745 ISS 06-84				IN - Memo Payment. INDIANA ONLY.
200002343	N	EA	FORM 5746 1E J200M21	500	6	200000	

DISTRIBUTION SERVICES

NETWORK SERVICES

TOOLS

BUILDING JANITORIAL

AUTOMOTIVE

FORMS/OFFICE SUPPLIES

GENERAL

DATA VOICE

DISTRIBUTION SERVICES

NETWORK SERVICES

TOOLS

BUILDING JANITORIAL

AUTOMOTIVE

FORMS/OFFICE SUPPLIES

GENERAL

DATA VOICE

FORM

PRODUCT IDENTIFIER		DESCRIPTION						
ITEM NUMBER	ORD. MULT.	SELL UNIT	STD. STOCK	PKG. AVAILABILITY / PA	LEAD TIME	MIN. ORD.	A C	
260421284 FORM		5747 1 ISS 04-91 S5M22						
1974659	1	SE	IL	IN	MI	OH	WI	
33								
IN - Manual Memo.								
260321336 FORM		5747 1 ISS 12-87						
1942466	50	SE	IL	IN	MI	OH	WI	
33								
Manual Miscellaneous Memo.								
200002350 FORM		5747 1F J25M21						
N		EA	500		6	25000		
FORM		5747 2 ISS 12-87						
0003128	500	EA	IN - Manual Misc Memo - CMR. INDIANA ONLY.					
FORM		5758 ISS 06-84						
0006232	1000	EA	IN - Agency Header B.M. 6000. INDIANA ONLY.					
FORM		5759 ISS 04-84						
0006233	1000	EA	IN - Depositing Bank Teller Header. INDIANA ONLY.					
FORM		5760 ISS 06-82						
0006234	2000	EA	IN - Batch Header B.M. 6000. INDIANA ONLY.					
FORM		5761 ISS 09-82						
0006381	1	EA	IN - CMR Overage. INDIANA ONLY.					
FORM		5762 ISS 09-82						
0006236	25	EA	IN - CMR Shortage. INDIANA ONLY.					
FORM		5763 ISS 06-82						
0006237	25	EA	IN - Cash Payment card. INDIANA ONLY.					
FORM		5764 ISS 06-82						
0006238	25	EA	IN - CMR Batch Trailer Card B.M. 6000. INDIANA ONLY.					
FORM		5765 ISS 06-82						
0006239	25	EA	IN - CMR Large Agency Trailer Card B.M. 6000. INDIANA ONLY.					
300095510 FORM		5766 ISS 06-82						
1931790	25	SE	IL	IN	MI	OH	WI	
33								
IN - BOCC Work/Material Request.								
FORM		5781 ISS 03-84						
0003541	500	EA	IN - DPC #1 Scheduling Information. INDIANA ONLY.					
FORM		5782 ISS 03-84						
0003542	3000	EA	IN - DPC #1 Scheduling Request. INDIANA ONLY.					

PRODUCT IDENTIFIER		DESCRIPTION						
ITEM NUMBER	ORD. MULT.	SELL UNIT	STD. STOCK	PKG. AVAILABILITY / PA	LEAD TIME	MIN. ORD.	A C	
FORM		5785 ISS 10-90						
0006929	100	EA	IN - Lump Sum Merit Awards. INDIANA ONLY.					
FORM		5786 ISS 10-90						
0006931	100	EA	IN - Transition Payments. INDIANA ONLY.					
FORM		5790 ISS 05-85						
0006253	50	EA	IN - DAS/C Query - 317. INDIANA ONLY.					
FORM		5791 ISS 07-82						
0006254	100	EA	IN - Independent Company Message Trunks Availability Status. INDIANA ONLY.					
FORM		5798 ISS 07-82						
0003547	1	EA	IN - Message Trunk Order Authorization. INDIANA ONLY.					
FORM		5808 ISS 11-88						
0006830	50	EA	IN - Service Order Inquiry. INDIANA ONLY.					
FORM		5809 ISS 08-82						
0007406	50	EA	IN - Passenger Profile. INDIANA ONLY.					
FORM		5810 ISS 09-82						
0007407	50	EA	IN - Reservation Log Sheet. INDIANA ONLY.					
FORM		5819						
0002440	200	EA	INDIANA ONLY.					
FORM		5826 ISS 12-83						
0003773			IN - Miscellaneous Accounts Adjustment Voucher. INDIANA ONLY.					
001091222 FORM		5836						
5619403		EA	IL	IN	MI	OH	WI	
33								
IL - PBX Contact & Daily Load Sheet								
260380605 FORM		5836 ISS 04-90 J10M24						
N		SH	50		4	10000		
FORM		5836 ISS 09-82						
0006434	1	EA	IN - Dummy Check. INDIANA ONLY.					
260380613 FORM		5836 1 ISS 04-90 J24						
N		SH	500		4	20000		
FORM		5839 ISS 09-82						
0003195	1	EA	IN - Vision Care Remittance Envelope. INDIANA ONLY.					

DISTRIBUTION SERVICES

NETWORK SERVICES

TOOLS

BUILDING JANITORIAL

AUTOMOTIVE

FORMS/OFFICE SUPPLIES

GENERAL

DATA VOICE

PRODUCT IDENTIFIER DESCRIPTION

ITEM NUMBER	ORD. MULT.	SELL UNIT	STD. PKG. STOCK AVAILABILITY / PA	LEAD TIME	MIN. ORD.	A C
-------------	------------	-----------	-----------------------------------	-----------	-----------	-----

0007411	50	EA	FORM 5840 ISS 02-86			
IN - Contractor Expenditure Log. INDIANA ONLY.						
0007413	25	EA	FORM 5846 ISS 10-82			
IN - Travel Arrangement Notification. INDIANA ONLY.						
0006932	100	EA	FORM 5862 ISS 10-90			
IN - Management Team Incentive Compensation Plan. INDIANA ONLY.						
0006923	100	EA	FORM 5863 ISS 10-87			
IN - CPE Worksheet. INDIANA ONLY.						

300095395	1932129	50	FORM 5864 ISS 03-83	IL IN MI OH WI		
IN - Columnar Ruled Sheet, 40 Lines.						

300095403	1932137	50	FORM 5865 ISS 03-83	IL IN MI OH WI		
IN - Columnar Ruled Sheet, 26 Lines.						

300095411	1931238	50	FORM 5866 ISS 11-82	IL IN MI OH WI		
IN - Manual Transaction.						

200004265	N	EA	FORM 5867 1C J5M21		5000	
MI - ENVELOPE - Pay Drafts and Check Supplemental.						

200004356	N	EA	FORM 5867 2 J180M21		180000	
Envelope.						

200005635	N	EA	FORM 5867 3A J15M21		15000	
-----------	---	----	---------------------	--	-------	--

0006298	100	EA	FORM 5871 ISS 02-86			
IN - Retired Employee Medicare Part B Insurance Premium. INDIANA ONLY.						

0003772			FORM 5873 ISS 02-92			
IN - Vehicle Retirement Check List. INDIANA ONLY.						

0006869	100	EA	FORM 5874 ISS 08-89			
IN - Trailer Inspection. INDIANA ONLY.						

280048000	1926816	3000	FORM 5879 ISS 07-78	IL IN MI OH WI		
IL - TTY Paper, JULIE Dig Notice.						

PRODUCT IDENTIFIER DESCRIPTION

ITEM NUMBER	ORD. MULT.	SELL UNIT	STD. PKG. STOCK AVAILABILITY / PA	LEAD TIME	MIN. ORD.	A C
-------------	------------	-----------	-----------------------------------	-----------	-----------	-----

0006854	100	EA	FORM 5879 ISS 11-89			
IN - Digger Derrick Annual Inspection. INDIANA ONLY.						
0006855	100	EA	FORM 5880 ISS 11-89			
IN - Aerial Lift Annual Inspection. INDIANA ONLY.						
280041781	N	EA	FORM 5896 A ISS 12-83 J35M24		35000	

300095429	1932145	25	FORM 5898 ISS 03-86	IL IN MI OH WI		
IN - Network Distribution Personnel Change Property Reassignment Verification.						

0003562	500	EA	FORM 5909 ISS 12-82			
IN - Request for Vacation Check(s) or Vac/Per Day(s). INDIANA ONLY.						

200002228	N	EA	FORM 5911 A J30M21		30000	
Envelope.						

300095148	1931279	25	FORM 5918 ISS 01-84	IL IN MI OH WI		
IN - Stall Loading Daily Material Order.						

0006330	500	EA	FORM 5927 ISS 08-87			
IN - Allotment Adjustments #03 Record. INDIANA ONLY.						

280062134	1934695	25	FORM 5929 ISS 04-87 S1M22	IL IN MI OH WI		
Individual Account Position Table-Update Form.						

300095189	N	SH	FORM 5930 ISS 04-87 S1M22		1000	
IN - Retention Exception Table Update Form.						

300095205	1934091	50	FORM 5933 ISS 01-83	IL IN MI OH WI		
IN - Account Range Position Table, Update Form.						

0007430	25	EA	FORM 5935 ISS 01-83			
IN - Performance Documentation. INDIANA ONLY.						

260380035	1960526	50	FORM 5951 ISS 04-90 A333M22	IL IN MI OH WI		
IN - Boss SOEDS & DOEDS PLUS Scratch Pad.						

300095247	1931295	50	FORM 5952 ISS 01-83	IL IN MI OH WI		
IN - User Identification Table (Add) Update Form.						

FORM

DISTRIBUTION SERVICES

PRODUCT IDENTIFIER		DESCRIPTION					
ITEM	ORD.	SELL	STD. PKG.	LEAD TIME	MIN.	A	
NUMBER	MULT.	UNIT	STOCK AVAILABILITY / PA		ORD.	C	
300095254 FORM		5952 1 ISS 01-83					
1931303	25	SH	IL	IN	MI	OH	WI
			33				
IN - User Identification Table, Delete, Update Form.							

NETWORK SERVICES

0006360	50	EA					
FORM		5953		ISS 02-87			
IN - 12-Month Performance Summary - RTOC. INDIANA ONLY.							

TOOLS

300095270 FORM		5960 ISS 02-83					
1931329	50	SE	IL	IN	MI	OH	WI
			33				
IN - Buried Service Wire Quality Inspection.							

0007439	50	SH					
FORM		5961		ISS 02-83			
IN - Buried Service Wire Log. INDIANA ONLY.							

0006942	50	EA					
FORM		5978		ISS 03-86			
IN - Inspector's Daily Log. INDIANA ONLY.							

BUILDING JANITORIAL

300095049 FORM		5979 ISS 07-86					
1931337	50	SE	IL	IN	MI	OH	WI
			33				
IN - Time and Material Data Sheet.							

0006977	50	EA					
FORM		5980		ISS 03-83			
IN - Summary of Proposals Received. INDIANA ONLY.							

AUTOMOTIVE

260361373 FORM		5981 ISS 08-89					
1954115	50	SE	IL	IN	MI	OH	WI
			33				
IN - Work Order.							

0006971	50	EA					
FORM		5996		ISS 03-83			
IN - Recommendation of Contractor Application. INDIANA ONLY.							

FORMS/OFFICE SUPPLIES

280000928 FORM		5997 ISS 01-84 J8M22					
N		SH	2700	8	8000		
IN - Directory Delivery Program.							

0004635	1	EA					
FORM		6001 A		ISS 06-87			
IN - REPLACES-FORM 6001 Assessment of Managerial Skills Annual Documentation. INDIANA ONLY.							

GENERAL

0004503	1	EA					
FORM		6001 B		ISS 06-87			
IN - Assessment of Managerial Skills Ongoing Documentation. INDIANA ONLY.							

0006905	1	EA					
FORM		6012		ISS 09-88			
IN - Spec & Proposal for Underground Conduit & Manhole Construction. INDIANA ONLY.							

DATA VOICE

0006906	25	EA					
FORM		6012 1		ISS 04-83			
IN - Schedule UC, Main & Subsidiary Conduit. INDIANA ONLY.							

PRODUCT IDENTIFIER		DESCRIPTION					
ITEM	ORD.	SELL	STD. PKG.	LEAD TIME	MIN.	A	
NUMBER	MULT.	UNIT	STOCK AVAILABILITY / PA		ORD.	C	

FORM		6012 2		ISS 07-83			
0006907	25	EA					
IN - Schedule UM, Manholes. INDIANA ONLY.							

0006908	100	EA					
FORM		6013		ISS 09-88			
IN - Standard Agreement for Outside Plant Construction & MTCE. INDIANA ONLY.							

0006909	25	EA					
FORM		6013 1		ISS 05-83			
IN - Amendment to Standard Agreement for OSP Construction & MTCE. INDIANA ONLY.							

0006910	100	EA					
FORM		6014		ISS 12-91			
IN - Spec & Unit price Proposal for OSP Construction & MTCE. INDIANA ONLY.							

0006916	1	EA					
FORM		6014 1		ISS 12-91			
IN - Schedule U, Underground Plant Items. INDIANA ONLY.							

0006911	1	EA					
FORM		6014 2		ISS 09-88			
IN - Schedule B, Buried Plant & Misc Items. INDIANA ONLY.							

0004634	50	EA					
FORM		6014 3		ISS 09-88			
IN - Schedule T, Time & Material Items. INDIANA ONLY.							

0006912	1	EA					
FORM		6015		ISS 11-86			
IN - Spec & Proposal for Construction of Buried Cable & Associated Facilities. INDIANA ONLY.							

0006913	25	EA					
FORM		6015 1		ISS 10-83			
IN - Schedule B1, Buried Cable & Structure. INDIANA ONLY.							

0006914	25	EA					
FORM		6015 2		ISS 10-83			
IN - Schedule B2, Closures, Terminals, Apparatus. INDIANA ONLY.							

0006915	25	EA					
FORM		6015 3		ISS 10-83			
IN - Schedule B3, Miscellaneous Items. INDIANA ONLY.							

0006387	100	EA					
FORM		6019		ISS 09-85			
IN - BOFADS Worksheet. INDIANA ONLY.							

0006376	25	EA					
FORM		6021		ISS 06-87			
IN - Position Status of Today's Work - RTOC. INDIANA ONLY.							

0007466	50	EA					
FORM		6022		ISS 04-83			
IN - Evaluation of Est Extras on Conduit & Manhole Proposal. INDIANA ONLY.							

PRODUCT IDENTIFIER		DESCRIPTION					
ITEM NUMBER	ORD. MULT.	SELL UNIT	STD. PKG. STOCK AVAILABILITY / PA	LEAD TIME	MIN. ORD.	A C	
0007467	25	EA	FORM 6023 ISS 08-84				IN - Additional Costs Encountered, But Not Included in Bid Price. INDIANA ONLY.
0006924	50	EA	FORM 6026 ISS 05-83				IN - Contractor's Performance Record. INDIANA ONLY.
0006392	100	EA	FORM 6027 ISS 03-90				IN - FDLC/SLC 96/MUX Plug-In Request. INDIANA ONLY.
280099268	1	BK	FORM 6031 3B	IL IN MI OH WI 33			
0007470	1	EA	FORM 6032 ISS 09-88				IN - Spec & Unit Price Proposal, Buried Service Facilities Installation & MTCE. INDIANA ONLY.
0007471	1	EA	FORM 6032 1 ISS 09-88				IN - Schedule D, Buried Service Facilities Items. INDIANA ONLY.
0003586	1	EA	FORM 6071 ISS 02-84				IN - Envelope - Payroll Checks. INDIANA ONLY.
0007473	1	EA	FORM 6073 ISS 07-83				IN - Identifying Key Values Call Human Resources. INDIANA ONLY.
300095122	1	SH	FORM 6074 ISS 07-83	IL IN MI OH WI 33			IN - Supervisor's Identification Inventory Call Human Resources.
0007475	1	EA	FORM 6075				INDIANA ONLY.
0007477	1	EA	FORM 6077 ISS 07-83				IN - Target Job Selection & Self-Analysis Workbook Call Human Resources. INDIANA ONLY.
0007478	1	EA	FORM 6078 ISS 07-83				IN - The Personal Development Worksheet Call Human Resources. INDIANA ONLY.
0006946	50	EA	FORM 6079 ISS 02-84				IN - Buried Service Wire Quality Inspection Summary. INDIANA ONLY.
0007482	25	EA	FORM 6086 ISS 06-83				IN - Exit Interview Information. INDIANA ONLY.

PRODUCT IDENTIFIER		DESCRIPTION					
ITEM NUMBER	ORD. MULT.	SELL UNIT	STD. PKG. STOCK AVAILABILITY / PA	LEAD TIME	MIN. ORD.	A C	
0003589	500	EA	FORM 6087 ISS 06-83				IN - Welding, Cutting or Open Flame Permit. INDIANA ONLY.
260376520	N	SH	FORM 6093 IE	J21 2950	6	740000	MI - Referral.
300094968	N	SE	FORM 6102 ISS 08-84	25	4	1000	IN - Shared Cable Agreement.
300093952	50	SH	FORM 6109 ISS 12-83	IL IN MI OH WI 33			IN - Miscellaneous Accounts Transfer.
280060864	250	EA	FORM 6112 ISS 09-83	IL IN MI OH WI 33			IN - Decal - Shared Cable Agreement.
0007490	1	EA	FORM 6119 ISS 09-83				IN - Administrative Assistant Evaluation. INDIANA ONLY.
0007491	50	EA	FORM 6121 ISS 09-83				IN - Shared Cable Agreement Tag. INDIANA ONLY.
0006453	100	EA	FORM 6122 ISS 11-86				IN - Metro Payroll Check List. INDIANA ONLY.
300093960	50	SH	FORM 6124 ISS 02-84	IL IN MI OH WI 33			IN - Inter-Office Action Memo.
300076437	N	SH	FORM 6131 ISS 04-92 J3M20	3000	8	3000	IL - Tax Return, 2 sheets per set.
280024563	500	EA	FORM 6141 ISS 12-83	IL IN MI OH WI 33			IN - Envelope - Top Priority Mail.
300094992	1	SH	FORM 6142 ISS 01-84	IL IN MI OH WI 33			IN - Ameritech Request for Transfer Application.
0003801	100	EA	FORM 6143 ISS 12-83				IN - Used Material Purchase Order. INDIANA ONLY.
0006467	1	EA	FORM 6144 ISS 08-87				IN - CMR Customer Advisory. INDIANA ONLY.

DISTRIBUTION SERVICES

NETWORK SERVICES

TOOLS

BUILDING JANITORIAL

AUTOMOTIVE

FORMS/OFFICE SUPPLIES

GENERAL

DATA VOICE

DISTRIBUTION SERVICES

FORM

PRODUCT IDENTIFIER		DESCRIPTION					
ITEM NUMBER	ORD. MULT.	SELL UNIT	STD. PKG. STOCK AVAILABILITY / PA	LEAD TIME	MIN. ORD.	A C	

0006470 1000 EA
FORM 6148 ISS 08-85
IN - Pensioner Telephone Service Reimbursement Voucher. INDIANA ONLY.

0006477 25 ES
FORM 6159 ISS 10-85
IN - Switched Access Trouble Log. INDIANA ONLY.

300093978 N
FORM 6160 ISS 12-83
SH 50 4 1000
IN - STC/MAPSS Trouble Ticket.

NETWORK SERVICES

TOOLS

BUILDING JANITORIAL

AUTOMOTIVE

FORMS/OFFICE SUPPLIES

GENERAL

DATA VOICE

0007500 25 EA
FORM 6161 ISS 04-84
IN - 819 Apparatus Case - Splicing Detail. INDIANA ONLY.

0007501 25 EA
FORM 6162 ISS 04-84
IN - 809 Apparatus Case - Splicing Detail. INDIANA ONLY.

300094760 1931444 25 SH
FORM 6163 ISS 01-87
IL IN MI OH WI
33
IN - Metallic System Data Record.

0007503 25 EA
FORM 6164 ISS 12-83
IN - SLC-96 Plug-In Record. INDIANA ONLY.

0007504 50 EA
FORM 6165 P1 ISS 01-84
IN - Access Lines - Summary Monthly Report NO.7. INDIANA ONLY.

0007505 50 EA
FORM 6165 P2 ISS 01-84
IN - Access Lines - Detail Monthly Report NO.7. INDIANA ONLY.

0007506 50 EA
FORM 6165 P3 ISS 01-84
IN - Access Lines - Detail Monthly Report NO.7. INDIANA ONLY.

0007507 50 EA
FORM 6165 P4 ISS 01-84
IN - Access Lines - Detail Monthly Report NO.7. INDIANA ONLY.

0007508 50 EA
FORM 6165 P5 ISS 01-84
IN - Central Office Data Monthly Report NO.7. INDIANA ONLY.

0006479 100 EA
FORM 6168 ISS 01-84
IN - Supplemental Input Cab Batch Control. INDIANA ONLY.

0006926 100 EA
FORM 6169 5 ISS 09-90
IN - ICSC Supp Input Cab Microfiche. INDIANA ONLY.

PRODUCT IDENTIFIER		DESCRIPTION					
ITEM NUMBER	ORD. MULT.	SELL UNIT	STD. PKG. STOCK AVAILABILITY / PA	LEAD TIME	MIN. ORD.	A C	

0006481 100 EA
FORM 6170 ISS 02-84
IN - Supplemental Input Cab CSR Demand Print Request. INDIANA ONLY.

280024571 1931451
FORM 6178 ISS 04-84
EA IL IN MI OH WI
33
IN - Envelope - Miscellaneous Accounts Bills.

280060872 1933937 50 EA
FORM 6182 ISS 03-85
IL IN MI OH WI
33
IN - TAG - Return Material.

0006489 100 EA
FORM 6183 ISS 07-85
IN - Pensioner Telephone Service Reimbursement Voucher. INDIANA ONLY.

300094851 1931477 100 SH
FORM 6184 ISS 02-92 S12M22
IL IN MI OH WI
33
IN - Letterhead, 240 N. Meridian.

280024589 1931485 500 EA
FORM 6189 ISS 02-84
IL IN MI OH WI
33
IN - Envelope - 8939 S. Madison, Indianapolis, IN 46227.

0003534 1 EA
FORM 6201 ISS 03-84
IN - Payroll Register. INDIANA ONLY.

260376538 N
FORM 6218 C J370M21
SH 2700 8 370000
MI - CRIS Accounts Receivable Ledger.

0003610 1 EA
FORM 6222 ISS 04-84
IN - TIRKS/ISO Work Request. INDIANA ONLY.

0006522 100 EA
FORM 6224 ISS 04-84
IN - IPOC/Emergency Telephone Inquiry/From \$AT&T. INDIANA ONLY.

300093986 1931519 50 SH
FORM 6237 ISS 05-84
IL IN MI OH WI
33
IN - BOSS Outage Notation Log.

0006533 25 EA
FORM 6240 ISS 05-84
IN - Personnel Profile. INDIANA ONLY.

0006534 25 EA
FORM 6241 ISS 05-84
IN - Area of Responsibility Profile. INDIANA ONLY.

0003614 5000 EA
FORM 6247 ISS 05-84
IN - Envelope - Invoice Office. INDIANA ONLY.

PRODUCT IDENTIFIER		DESCRIPTION				
ITEM NUMBER	ORD. MULT.	SELL UNIT	STD. PKG. STOCK AVAILABILITY / PA	LEAD TIME	MIN. ORD.	A C
FORM 6251 ISS 06-84						
0003617	1500	EA				
IN - T-Tran Tape Retention Request. INDIANA ONLY.						
260376546 FORM 6252 A J40M21						
N		SH	3000	8	40000	
MI - Directory Delivery Stubs - Regular.						
FORM 6254 ISS 06-84						
0003618	100	EA				
IN - Envelope Business Reply - SDC 8 7/8 X 3 7/8IN. INDIANA ONLY.						
FORM 6261 ISS 12-84						
0003619	500	EA				
IN - Buried Cable Door Hanger. INDIANA ONLY.						
FORM 6269 ISS 01-88						
0006784	25	EA				
IN - Reclamation Center - Salvage Credits. INDIANA ONLY.						
260376553 FORM 6277 C J2CM21						
N		SH	3000	8	200000	
MI - Business Office & Accounting Cash List.						
FORM 6280 ISS 08-84						
0003624	200	EA				
IN - Purchase Agreement. INDIANA ONLY.						
FORM 6289 ISS 11-89						
0003747	250	EA				
IN - CABS Account Inquiry. INDIANA ONLY.						
280060880 FORM 6290 ISS 08-84						
1933952	25	EA	IL IN MI OH WI	33		
IN - TAG - Network Interface Jack.						
260323118 FORM 6291 ISS 02-88						
1943571	1	EA	IL IN MI OH WI	33		
IN - TAG - Network Interface RJ21 Jack.						
FORM 6293 ISS 07-88						
0006555	100	EA				
IN - Central Office Header Document. INDIANA ONLY.						
FORM 6294 ISS 11-87						
0003633	500	EA				
IN - Furniture Purchase Order. INDIANA ONLY.						
FORM 6302						
0003746	200	EA				
INDIANA ONLY.						
300073012 FORM 6304 ISS 10-85 S2M20						
1192435	25	SH	IL IN MI OH WI	33		
IL - Keep Cost Custom Work Authorization, Section I.						

PRODUCT IDENTIFIER		DESCRIPTION				
ITEM NUMBER	ORD. MULT.	SELL UNIT	STD. PKG. STOCK AVAILABILITY / PA	LEAD TIME	MIN. ORD.	A C
300068335 FORM 6305 ISS 07-85						
5120550	500	SH	IL IN MI OH WI	33		
IL - Keep Cost Custom Work Authorization, Section II.						
FORM 6311 ISS 10-84						
0003639	1000	EA				
IN - Maintenance & Repair Service Request. INDIANA ONLY.						
FORM 6321 ISS 10-84						
0006570	100	EA				
IN - WATS Charges Calculation Aid. INDIANA ONLY.						
FORM 6323 ISS 07-88						
0006767	25	SE				
IN - Intercompany Transfer Worksheet. INDIANA ONLY.						
260314703 FORM 6325 ISS 11-84 A540M22						
1940882	2400	SH	IL IN MI OH WI	33		
FORM 6329 1,2 ISS 5-90						
0006900	1	EA				
IN - Centrex Service Request Cover Sheet. INDIANA ONLY.						
FORM 6330 ISS 03-92						
0006797	25	EA				
IN - Centrex System and Feature Requirements. INDIANA ONLY.						
FORM 6331 12 ISS 07-90						
0003150	100	EA				
IN - Centrex Customer Billing Detail. INDIANA ONLY.						
FORM 6332 ISS 11-84						
0003149	300	EA				
IN - Centrex Directory Listings. INDIANA ONLY.						
FORM 6333 ISS 03-91						
0006982	100	SE				
IN - Form 6333-1, Centrex UCO Design. INDIANA ONLY.						
FORM 6334 ISS 11-84						
0003196	300	EA				
IN - Centrex Inter & Intra LATA Circuit Detail. INDIANA ONLY.						
300093994 FORM 6337 ISS 12-84						
1931535	50	SH	IL IN MI OH WI	33		
IN - Contact Memo, ICSC.						
FORM 6339 ISS 01-88						
0006575	25	EA				
IN - Savings Plan for Salaried Employees. INDIANA ONLY.						
FORM 6341 ISS 04-90						
0006886	100	EA				
IN - Centrex ARS Basic Routing Patterns. INDIANA ONLY.						

DISTRIBUTION SERVICES
 NETWORK SERVICES
 TOOLS
 BUILDING JANITORIAL
 AUTOMOTIVE
 FORMS/OFFICE SUPPLIES
 GENERAL
 DATA VOICE

DISTRIBUTION SERVICES

NETWORK SERVICES

TOOLS

BUILDING JANITORIAL

AUTOMOTIVE

FORMS/OFFICE SUPPLIES

GENERAL

DATA VOICE

FORM

PRODUCT IDENTIFIER		DESCRIPTION						
ITEM NUMBER	ORD. MULT.	SELL UNIT	STD. PKG. STOCK AVAILABILITY / PA	LEAD TIME	MIN. ORD.	A C		
0006887	100	EA	FORM 6342 ISS 04-90				IN - Centrex ARS Basic NPA 3 Digit Pattern List. INDIANA ONLY.	
0006888	100	EA	FORM 6343 ISS 04-90				IN - Centrex ARS Basic NPA-NXX6 Digit Pattern List. INDIANA ONLY.	
0006983	50	EA	FORM 6344 ISS 03-92				IN - Centrex Station Detail Sheets 1-4, NBR. INDIANA ONLY.	
0003236	300	EA	FORM 6345 ISS 08-85				IN - Centrex Station Detail Remarks. INDIANA ONLY.	
0005391	25	EA	FORM 6347 ISS 12-84				IN - Centrex Call Pickup Worksheet. INDIANA ONLY.	
0006889	100	EA	FORM 6349 ISS 04-90				IN - Centrex SMDR Request. INDIANA ONLY.	
0006890	100	SE	FORM 6354 123 ISS 4-90				IN - Centrex ARS Basic Home NPA 3 Digit Pattern List. INDIANA ONLY.	
0003646	100	EA	FORM 6355 ISS 05-91				IN - Centrex Letter of Election and Letter of Agency Add. INDIANA ONLY.	
0007533	25	EA	FORM 6356 ISS 12-84				IN - Carrier Billing Program Development Chg. INDIANA ONLY.	
260303706	1	BK	FORM 6357 ISS 09-87	IL	IN	MI	OH	WI
1940338	1	BK		33				
								IN - Coin Repair Ticket.
0006577	100	EA	FORM 6358 ISS 01-85					IN - Referral Indicator Input Record. INDIANA ONLY.
0003754	100	EA	FORM 6359 ISS 07-90					IN - Telephone Equipment Order Face Sheet. INDIANA ONLY.
0005611	1	EA	FORM 6362 ISS 06-88					IN - Centrex - Basic System Pricing Worksheet. INDIANA ONLY.
0006389	1	EA	FORM 6365 ISS 01-88					IN - Enrollment Form. INDIANA ONLY.

PRODUCT IDENTIFIER		DESCRIPTION						
ITEM NUMBER	ORD. MULT.	SELL UNIT	STD. PKG. STOCK AVAILABILITY / PA	LEAD TIME	MIN. ORD.	A C		
0003648	100	EA	FORM 6368 ISS 05-91					IN - Deferred Payment Agreement. INDIANA ONLY.
300094562	50	SH	FORM 6370 ISS 01-85	IL	IN	MI	OH	WI
1931568	50	SH		33				
								IN - Safety Observation.
0003650	1	EA	FORM 6371 ISS 01-85					IN - ISO Billing Statement. INDIANA ONLY.
280060914	1	EA	FORM 6373 ISS 01-85	IL	IN	MI	OH	WI
1933986	1	EA		33				
								System Features & Station Design Requests.
260376561	N	SH	FORM 6373 3	2000	8	25000	J25M21	
								MI - Payroll Register - Weekly and Monthly Paid.
300094570	50	SH	FORM 6376 ISS 01-85	IL	IN	MI	OH	WI
1931576	50	SH		33				
								IN - Print Index.
300094588	50	SH	FORM 6377 ISS 01-85	IL	IN	MI	OH	WI
1931584	50	SH		33				
								IN - Cable Transfer & Cutover Schedule Sequence Work Operation.
300094596	50	SH	FORM 6377 1 ISS 12-86	IL	IN	MI	OH	WI
1931592	50	SH		33				
								IN - Cable Transfer & Cutover Schedule Sequence Work Operation.
300094745	N	SE	FORM 6378 ISS 01-85	25	4	1000		
								IN - Scan-Alert Customer Authorization Letter.
0007542	25	EA	FORM 6379 ISS 03-88					
								IN - Prospective Sales Lead. INDIANA ONLY.
300094406	N	SE	FORM 6379 ISS 03-88 S2M22	25	4	2000		
								IN - Prospect Sales Lead.
0006584	25	EA	FORM 6381 ISS 02-85					
								IN - Ameritech Savings Plan For Salaried Employees. INDIANA ONLY.
0006987	100	ea	FORM 6383 ISS 07-91					
								IN - OPTINET DS1 Service Order Request. INDIANA ONLY.
0007544	25	EA	FORM 6390 ISS 02-85					
								IN - Derived Channel Alarm Customer Authorization Letter. INDIANA ONLY.

PRODUCT IDENTIFIER		DESCRIPTION				
ITEM NUMBER	ORD. MULT.	SELL UNIT	STD. PKG. STOCK AVAILABILITY / PA	LEAD TIME	MIN. ORD.	A C
0006587	25	EA	FORM 6391 ISS 02-85			
IN - CDP Transmittal/IDP Chargeback Report. INDIANA ONLY.						
0003658	1000	EA	FORM 6393 ISS 02-90			
IN - Capital Tool Warehouse Activity Report 264. INDIANA ONLY.						
0006591	1	EA	FORM 6397 ISS 03-85			
IN - AIC Clerical Collection Review. INDIANA ONLY.						
0003660	1000	EA	FORM 6400 ISS 05-89			
IN - Exempt Material Usage Study. INDIANA ONLY.						
0007545	50	EA	FORM 6401 ISS 01-87			
IN - Loop Fiber System Data Record. INDIANA ONLY.						
0007546	50	EA	FORM 6402 ISS 03-85			
IN - Span Line Power Equipment Inventory Record. INDIANA ONLY.						
0007547	50	EA	FORM 6403 ISS 03-85			
IN - Digital Loop Connectivity Record. INDIANA ONLY.						
0007548	25	EA	FORM 6404 ISS 03-85			
IN - Location Record. INDIANA ONLY.						
0006594	25	EA	FORM 6405 ISS 03-85			
INDIANA ONLY.						
0006864	50	SH	FORM 6406 ISS 01-87			
IN - Loop DS-1 Design Record. INDIANA ONLY.						
0007560	25	EA	FORM 6412 ISS 04-85			
IN - SLC-Remote Terminal Site Data Sheet. INDIANA ONLY.						
0006600	25	EA	FORM 6416 ISS 04-88			
IN - Fiber Optic Cable End-to-End Completion Test. INDIANA ONLY.						
0006601	25	EA	FORM 6417 ISS 05-85			
IN - Commutation in Lieu of Relocation, CILOR. INDIANA ONLY.						
0006602	25	EA	FORM 6418 ISS 06-85			
IN - IPLS Directory Assistance Trouble Ticket. INDIANA ONLY.						

PRODUCT IDENTIFIER		DESCRIPTION				
ITEM NUMBER	ORD. MULT.	SELL UNIT	STD. PKG. STOCK AVAILABILITY / PA	LEAD TIME	MIN. ORD.	A C
300094505	FORM	6420	ISS 05-85			
1931626	50	SE	IL IN MI OH WI			
33 IN - Jiffy Memo.						
300094489	FORM	6422	ISS 05-85			
1931634	25	SH	IL IN MI OH WI			
33 IN - Reimbursement For Concession Service.						
0003663	1000	EA	FORM 6423 ISS 05-85			
IN - Envelope - Return Mail - Legal Claims. INDIANA ONLY.						
260386008	FORM	6425	ISS 06-90 S1M22			
1963579	1000	SE	IL IN MI OH WI			
33 IN - Service Representative Handbook Updates.						
0007654	25	EA	FORM 6428 ISS 06-85			
IN - On Campus Student Toll Only Calling Card Application. INDIANA ONLY.						
0003665	1000	EA	FORM 6429 ISS 06-85			
IN - Envelope - Landmark - 9 1/2in x 4 1/8in White. INDIANA ONLY.						
0003666	1000	EA	FORM 6430 ISS 06-85			
IN - Envelope- Landmark - 9 1/2 X 12 1/2IN Kraft. INDIANA ONLY.						
0003667	500	EA	FORM 6431 ISS 06-85			
IN - Add/Change Participant for Pension. INDIANA ONLY.						
0006607	25	EA	FORM 6432 ISS 06-85			
IN - Carrier Billing Adjustment Summary. INDIANA ONLY.						
0006608	25	EA	FORM 6433 ISS 06-85			
IN - Adjustment Activity Summary Log. INDIANA ONLY.						
260393129	FORM	6435	ISS 09-90 S1M22			
1966101	25	SE	IL IN MI OH WI			
33 Move Notification - Indiana.						
0006615	25	EA	FORM 6441 ISS 06-85			
IN - 16ft - Controlled Environmental Vault Housing Record. INDIANA ONLY.						
0006616	25	EA	FORM 6442 ISS 06-85			
IN - 24ft -Controlled Environmental Vault Housing Record. INDIANA ONLY.						

DISTRIBUTION SERVICES
NETWORK SERVICES
TOOLS
BUILDING JANITORIAL
AUTOMOTIVE
FORMS/OFFICE SUPPLIES
GENERAL
DATA VOICE

DISTRIBUTION SERVICES

NETWORK SERVICES

TOOLS

BUILDING JANITORIAL

AUTOMOTIVE

FORMS/OFFICE SUPPLIES

GENERAL

DATA VOICE

FORM

PRODUCT IDENTIFIER		DESCRIPTION					
ITEM NUMBER	ORD. MULT.	SELL UNIT	STD. PKG. STOCK AVAILABILITY / PA	LEAD TIME	MIN. ORD.	A	C
0006617	25	EA	FORM 6443 ISS 06-85				
IN - 16ft X 10ft X 8ft Concrete Hut Housing Record. INDIANA ONLY.							
0006618	25	EA	FORM 6444 ISS 06-85				
IN - 10ft X 8ft X 8ft Concrete Hut Housing Record. INDIANA ONLY.							
300094307	N	SE	FORM 6447 ISS 02-86	25	4	1000	
IN - Microcomputer Maintenance Activity.							
0006621	25	EA	FORM 6450 ISS 07-85				
IN - Employee Record. INDIANA ONLY.							
0006622	25	EA	FORM 6451 ISS 07-85				
IN - Supplementals and Source 112. INDIANA ONLY.							
260376579	N	SH	FORM 6454 1A	2600	8	150000	J150M21
MI - Accounts Interrogation & On-line Print (Facilities).							
260376587	N	SH	FORM 6454 2A	2000	8	210000	J210M21
MI - Error Printout & Line Print (Facilities).							
260359658	1953406	25	FORM 6459 ISS 05-89	SE	IL	IN	MI OH WI
IN - White Pages IBT Query To API Personnel.							
0003671	100	EA	FORM 6462 ISS 07-85				
IN - Request for Payroll Checks - Craft/Management. INDIANA ONLY.							
0006633	25	EA	FORM 6466 ISS 07-85				
IN - Recalled Check Control. INDIANA ONLY.							
0006698	100	EA	FORM 6468 ISS 04-90				
IN - Trunk & Sub PR GN Equipment Retirement Det 57257. INDIANA ONLY.							
0006637	25	EA	FORM 6474 ISS 08-85				
IN - Annoyance Call Log. INDIANA ONLY.							
0006640	25	EA	FORM 6478 ISS 08-85				
IN - Group Insurance Master File Update. INDIANA ONLY.							
0006641	25	EA	FORM 6482 ISS 08-85				
IN - Acknowledge of Receipt Group Insurance Forms. INDIANA ONLY.							

PRODUCT IDENTIFIER		DESCRIPTION					
ITEM NUMBER	ORD. MULT.	SELL UNIT	STD. PKG. STOCK AVAILABILITY / PA	LEAD TIME	MIN. ORD.	A	C
300094331	FORM	6484	ISS 08-85				
1931683	50	SH	IL IN MI OH WI	33			
IN - Dial 1 Plus Equal Access Customer Confirmation.							
0006643	25	EA	FORM 6485 ISS 08-85				
INDIANA ONLY.							
0006643	25	EA	FORM 6485 ISS 08-85				
INDIANA ONLY.							
0006806	25	EA	FORM 6487 ISS 12-87				
IN - Device Data for Transducers. INDIANA ONLY.							
0003674	1000	EA	FORM 6488				
IN - Device Data for Air Flow Devices. INDIANA ONLY.							
0006807	1000	EA	FORM 6489 ISS 12-87				
IN - Device Data for Status Indicators. INDIANA ONLY.							
0003676	25	EA	FORM 6490 ISS 09-85				
IN - Device Data for Loop Resistances. INDIANA ONLY.							
0006650	100	EA	FORM 6498 ISS 01-88				
IN - Management Deferred Pension Eligibility Worksheet. INDIANA ONLY.							
0006653	100	EA	FORM 6503 ISS 09-85				
IN - The Sales Master Planner. INDIANA ONLY.							
0006922	100	EA	FORM 6504 ISS 09-85				
IN - SR Development Activities - RTOC. INDIANA ONLY.							
0006654	100	EA	FORM 6506 ISS 09-90				
IN - Ameritech Employee Information System Uniform Rental. INDIANA ONLY.							
0006656	1000	EA	FORM 6508 ISS 09-85				
IN - OCR Data Entry Transmittal. INDIANA ONLY.							
0006657	100	EA	FORM 6509 ISS 09-85				
IN - Allotment Controls - Adjustments. INDIANA ONLY.							
0006699	50	EA	FORM 6510 ISS 09-85				
IN - Allotment Controls Supplementals/Source 112'S. INDIANA ONLY.							

PRODUCT IDENTIFIER		DESCRIPTION				
ITEM NUMBER	ORD. MULT.	SELL UNIT	STD. PKG. STOCK AVAILABILITY / PA	LEAD TIME	MIN. ORD.	A C
0006658	50	EA	FORM 6511	ISS 09-85		
IN - Record of CNA Calls. INDIANA ONLY.						
0006660	25	EA	FORM 6513	ISS 09-85		
IN - Motor Vehicle Data Card - Ameritech. INDIANA ONLY.						
0006661	25	EA	FORM 6514	ISS 09-85		
IN - Injury Data Card - Ameritech. INDIANA ONLY.						
0003679	500	EA	FORM 6523	ISS 10-85		
IN - NXX Request. INDIANA ONLY.						
0006667	25	EA	FORM 6524	ISS 03-88		
IN - Monthly Time Report. INDIANA ONLY.						
0007526	1	EA	FORM 6529	ISS 01-86		
IN - Authorization for Commuting. INDIANA ONLY.						
280060922	1	EA	FORM 6532	ISS 12-85 S50M22		
1933994			IL IN MI OH WI	33		
IN - Envelope - Depository, Landmark.						
0006669	25	EA	FORM 6535	ISS 12-85		
IN - Interviewing Record. INDIANA ONLY.						
0006702	25	EA	FORM 6536	ISS 04-88		
IN - Monthly Absence Report. INDIANA ONLY.						
280043985		EA	FORM 6537			
N			500	6	10000	
300094380	250	SH	FORM 6537	ISS 01-86		
1934117			IL IN MI OH WI	33		
IN - Sheet Note Paper 4in X 6in w/Logo.						
260330105	25	SH	FORM 6540	ISS 01-88		
1946814			IL IN MI OH WI	33		
IN - Ameritech Employee Injury/Illness Report.						
0006366	1	PD	FORM 6544	ISS 01-86		
IN - Data Systems Change Request Library Update, 50/PD. INDIANA ONLY.						
0006352	1	EA	FORM 6545	ISS 01-86		
IN - Data Systems Change Request Documentation Change. INDIANA ONLY.						
300094398	50	SH	FORM 6546	ISS 01-86		
1931253			IL IN MI OH WI	33		
IN - New Deposit Record.						

PRODUCT IDENTIFIER		DESCRIPTION				
ITEM NUMBER	ORD. MULT.	SELL UNIT	STD. PKG. STOCK AVAILABILITY / PA	LEAD TIME	MIN. ORD.	A C
0006704	25	EA	FORM 6547	ISS 01-86		
IN - Employee Attendance & Punctuality Performance Record. INDIANA ONLY.						
0007648	25	EA	FORM 6548	ISS 01-86		
IN - Record of Switch Outage Time. INDIANA ONLY.						
0006705	25	EA	FORM 6549	ISS 01-86		
IN - Application for Customer Owned Coin Operated Telephone. INDIANA ONLY.						
0007649	50	EA	FORM 6550	ISS 01-86		
IN - Dishonored Multiple Account Check Advice. INDIANA ONLY.						
280062167	25	SE	FORM 6551	ISS 08-85		
1934679			IL IN MI OH WI	33		
ORPS Data Modification.						
0006712	25	EA	FORM 6556			
INDIANA ONLY.						
0005918	25	EA	FORM 6567	ISS 02-86		
IN - IC PO PIC Set Acknowledgement. INDIANA ONLY.						
0007650	50	EA	FORM 6570	ISS 02-86		
IN - Loop I&M Quality Analysis Record. INDIANA ONLY.						
003006996		SE	FORM 6571	ISS 04-83 J4M20		
N			100	8	4000	
IL - Report To Reduce Or Cancel Working Fund Advance.						
260321351	25	SE	FORM 6571	ISS 12-87		
1942482			IL IN MI OH WI	33		
Construction Force Daily Time Report.						
0005327	100	EA	FORM 6572	ISS 06-91		
IN - Optinet Base Rate Service (OBR) Worksheet. INDIANA ONLY.						
280062175	50	SH	FORM 6574	ISS 03-86		
1934752			IL IN MI OH WI	33		
IN - Request For Account Restriction of Long Distance Company.						
0003315	200	EA	FORM 6575	ISS 03-86		
IN - Depository Agreement. INDIANA ONLY.						
0003282	1000	EA	FORM 6577	ISS 05-91		
IN - Centrex Letter of Election - Short Version and Letter of Agency. INDIANA ONLY.						

DISTRIBUTION SERVICES

NETWORK SERVICES

TOOLS

BUILDING JANITORIAL

AUTOMOTIVE

FORMS/OFFICE SUPPLIES

GENERAL

DATA VOICE

FORM

DISTRIBUTION SERVICES

PRODUCT IDENTIFIER		DESCRIPTION						
ITEM NUMBER	ORD. MULT.	SELL UNIT	STD. PKG. STOCK	LEAD TIME AVAILABILITY	MIN. ORD.	A	C	
260359674 FORM		6578	ISS 07-89 A160M22					
1953422	2000	SH	IL	IN	MI	OH	WI	
			33					
		IN - Service Order 8 1/2 X 8 1/2IN.						

NETWORK SERVICES

0006675	25	EA	FORM 6583 ISS 06-86					
		IN - Contract Programmer Evaluation. INDIANA ONLY.						

0005321	50	EA	FORM 6585 ISS 09-88					
		IN - Exchange Carrier Billing Resolution. INDIANA ONLY.						

0005338	25	EA	FORM 6587 ISS 05-90					
		IN - Activity Reporting Card by Volunteer. INDIANA ONLY.						

TOOLS

280041104 FORM		6594	ISS 06-86					
1932673	25	SE	IL	IN	MI	OH	WI	
			33					
		IN - Indiana Bell/Watercom Calling Card Application, package of 25.						

0006378	1	EA	FORM 6595 ISS 10-87					
		IN - Professional Consultant Agreement. INDIANA ONLY.						

BUILDING JANITORIAL

280046467 FORM		6596	ISS 08-86					
1934000	50	SE	IL	IN	MI	OH	WI	
			33					
		IN - Indiana Bell/Watercom Calling Card Activity Sheet.						

0005169	1	PD	FORM 6599 ISS 01-88					
		IN - Directory Assistance Initial Training Call Detail Record, 50/Pad. INDIANA ONLY.						

0006391	25	EA	FORM 6601 ISS 08-86					
		IN - Outside Plant Engineering. INDIANA ONLY.						

AUTOMOTIVE

0006968	100	EA	FORM 6604 ISS 03-91					
		IN - Osha/Environmental Inspection. INDIANA ONLY.						

0006819	1	PD	FORM 6605 ISS 09-86					
		IN - Minority & Women's Business Enterprises New Vendor Notifier, 50 PER PAD. INDIANA ONLY.						

FORMS/OFFICE SUPPLIES

0006818	1	PD	FORM 6606					
		INDIANA ONLY.						

0004626	1	PD	FORM 6607 ISS 09-86					
		IN - Quarterly Sum of Key Statistics - Minority & Women Supplier, 50/Pad. INDIANA ONLY.						

GENERAL

DATA VOICE

PRODUCT IDENTIFIER		DESCRIPTION						
ITEM NUMBER	ORD. MULT.	SELL UNIT	STD. PKG. STOCK	LEAD TIME AVAILABILITY	MIN. ORD.	A	C	

0004630	25	EA	FORM 6609 ISS 09-86					
		IN - Office Safety. INDIANA ONLY.						

0005487	25	EA	FORM 6610 ISS 10-86					
		IN - Information Systems. INDIANA ONLY.						

280048968 FORM		6613	ISS 09-86					
1934711	25	SE	IL	IN	MI	OH	WI	
			33					
		IN - Documentation Order Record.						

0005390	1	EA	FORM 6615					
		INDIANA ONLY.						

0005405	1	EA	FORM 6617 ISS 10-88					
		IN - Building Operations. INDIANA ONLY.						

0005411	1	EA	FORM 6618 ISS 10-88					
		IN - Bell Public Communications. INDIANA ONLY.						

0005416	1	EA	FORM 6619 ISS 10-88					
		IN - Motor Vehicle Operations. INDIANA ONLY.						

0006501	1	PD	FORM 6620 ISS 11-86					
		IN - Review & Diagnostic, 50/PD. INDIANA ONLY.						

0003296	10	M	FORM 6629					
		INDIANA ONLY.						

260328158 FORM		6630	ISS 05-88 S15C22					
1945972	5	PD	IL	IN	MI	OH	WI	
			33					
		IN - Customer Contact Memo - 317 - 812. INDIANA ONLY.						

0005501	100	EA	FORM 6631 ISS 10-88					
		IN - IBAPP Manhole/Hazardous Section. INDIANA ONLY.						

0004625	200	EA	FORM 6632 ISS 11-88					
		IN - Entry Permit. INDIANA ONLY.						

280062209 FORM		6638	ISS 11-86					
1934760	25	SE	IL	IN	MI	OH	WI	
			33					
		IN - Rusco Cardkey Activity Report.						

280062217 FORM		6639	ISS 11-86					
1934778	1	SE	IL	IN	MI	OH	WI	
			33					
		IN - Route Ticket.						

PRODUCT IDENTIFIER		DESCRIPTION					
ITEM NUMBER	ORD. MULT.	SELL UNIT	STD. STOCK	PKG. AVAILABILITY / PA	LEAD TIME	MIN. ORD.	A C
FORM 6642		ISS 04-87					
0005317	1	PD	IN - CABS Usage Error Investigation Request, 50/Pad. INDIANA ONLY.				
260323126 FORM 6643		ISS 02-88					
1943589	25	SH	IL	IN	MI	OH	WI
		33 IN - Drop Damage Work Invoice.					
FORM 6644		ISS 12-86					
0003259	5000	EA	IN - Defective Equipment Tag. INDIANA ONLY.				
FORM 6645		ISS 12-86					
0003247	3000	EA	IN - Expense Tool Request. INDIANA ONLY.				
FORM 6646		ISS 04-87					
0005406	1	PD	IN - Facility Layout Face Sheet, 50/Pad. INDIANA ONLY.				
FORM 6648		ISS 04-87					
0005379	1	EA	IN - Statement for Group Policy No.27857G Ameritech Supplementary Group Life Insurance Premium. INDIANA ONLY.				
FORM 6649		ISS 04-87					
0005420	1	EA	IN - Group Insurance Monthly Premium Statement. INDIANA ONLY.				
FORM 6650		ISS 01-87					
0005344	1	EA	IN - Call Detail Record. INDIANA ONLY.				
FORM 6651		ISS 09-90					
0006651	100	EA	IN - Request for Paid Intercept. INDIANA ONLY.				
FORM 6652		ISS 02-87					
0003594	200	EA	IN - Engineering Work Print Labels. INDIANA ONLY.				
FORM 6652		ISS 09-85					
0003591	1	EA	IN - PICS Bill of Lading. INDIANA ONLY.				
FORM 6654		ISS 02-87					
0005084	1	EA	IN - DLC Integration Implementation. INDIANA ONLY.				
200002400	FORM	6654	C	J5M21			
N	EA	500	6	5000			
		Envelope.					

280099409 FORM 6655		ISS 02-87					
1937599	1	EA	IL	IN	MI	OH	WI
		33 IN - Indiana PICS Recall.					

PRODUCT IDENTIFIER		DESCRIPTION					
ITEM NUMBER	ORD. MULT.	SELL UNIT	STD. STOCK	PKG. AVAILABILITY / PA	LEAD TIME	MIN. ORD.	A C
FORM 6657		ISS 02-87					
0006375	1	EA	IN - Centrex Digital Optional Features Pricing Work Sheet. INDIANA ONLY.				
FORM 6658							
0003133	1	PK	IN - Communication Revenue Protection System Order, 25/PK. INDIANA ONLY.				
FORM 6658 1		ISS 03-87					
0003140	1	EA	IN - Communication Revenue Protection System Order Regional Billing Info. INDIANA ONLY.				
FORM 6658 2		ISS 05-87					
0003238	1	EA	IN - Communication Revenue. INDIANA ONLY.				
FORM 6658 3		ISS 05-87					
0003246	1	EA	IN - Mail Region Report. INDIANA ONLY.				
FORM 6659		ISS 03-87					
0007694	1	EA	IN - Envelope Business - Centrex Deliver Mgr. INDIANA ONLY.				
FORM 6660		ISS 03-87					
0007703	1	EA	IN - Envelope Business Reply Mail - Evansville. INDIANA ONLY.				
FORM 6662		ISS 03-87					
0005498	1	EA	IN - CW174 839 File Update - Comments. INDIANA ONLY.				
FORM 6663		ISS 03-87					
0005853	1	EA	IN - CW 174 839 File Update Lump Sum Payout. INDIANA ONLY.				
FORM 6667		ISS 04-87					
0007702	1	EA	IN - Drop Wire Tag. INDIANA ONLY.				
FORM 6668		ISS 04-87					
0004627	1	PD	IN - Job Status Form, 50/PD. INDIANA ONLY.				
FORM 6669		ISS 04-87					
0006823	25	EA	IN - DSR Cutover Document. INDIANA ONLY.				
260341300 FORM 6670		ISS 10-88					
1949180	50	EA	IL	IN	MI	OH	WI
		33 IN - CSE FEEDBACK.					
FORM 6671		ISS 07-91					
0003270	1	BK	IN - Material Request for Building Operations. INDIANA ONLY.				

DISTRIBUTION SERVICES

NETWORK SERVICES

TOOLS

BUILDING JANITORIAL

AUTOMOTIVE

FORMS/OFFICE SUPPLIES

GENERAL

DATA VOICE

DISTRIBUTION SERVICES

NETWORK SERVICES

TOOLS

BUILDING JANITORIAL

AUTOMOTIVE

FORMS/OFFICE SUPPLIES

GENERAL

DATA VOICE

FORM

PRODUCT IDENTIFIER DESCRIPTION

ITEM NUMBER	ORD. MULT.	SELL UNIT	STD. PKG.	LEAD TIME	MIN. ORD.	A C
			STOCK AVAILABILITY / PA			

FORM 6672 ISS 08-88
0003184 500 EA
IN - Request for Loan Indiana Bell Telephone Co. INDIANA ONLY.

260361381 FORM 6674 ISS 08-89
1954123 100 EA IL IN MI OH WI
33

IN - Project File Folder.

FORM 6679 ISS 06-87
0003522 1 EA
IN - Label - 'Prewired By:' INDIANA ONLY.

FORM 6680 ISS 08-87
0006384 1 EA
IN - Trouble Ticket, PLAIN. INDIANA ONLY.

FORM 6680 ISS 09-87
0006382 1 EA
IN - Trouble Ticket. INDIANA ONLY.

FORM 6681 ISS 05-87
0003255 1 EA
IN - Data Designation Strip. INDIANA ONLY.

FORM 6685 ISS 02-89
0007707 1 PD
IN - Administrative Services Checklist, 50/PD. INDIANA ONLY.

FORM 6687 ISS 07-87
0003518 1 EA
IN - Title Block Standpat. INDIANA ONLY.

FORM 6688 ISS 04-89
0006384 100 EA
IN - Trouble Ticket Plain. INDIANA ONLY.

260300330 FORM 6689 ISS 08-87
1937987 25 EA IL IN MI OH WI
33
IN - Tag - NCTE Equipment, 317.

260300348 FORM 6690 ISS 08-87
1937979 25 EA IL IN MI OH WI
33
IN - Tag - NCTE Equipment, 219.

260300355 FORM 6691 ISS 08-87
1937961 25 EA IL IN MI OH WI
33
IN - Tag - NCTE Equipment, 812.

260442306 FORM 6691 ISS 12-91 S20M22
N EA 100 8 20000
IN - Memo Payment - 2-part.

260300488 FORM 6692 ISS 08-87
1938605 1 EA IL IN MI OH WI
33
IN - Tag - A/C Power Plugs.

FORM 6693 ISS 10-88
0006390 1 EA
IN - 911 Inquiry. INDIANA ONLY.

PRODUCT IDENTIFIER DESCRIPTION

ITEM NUMBER	ORD. MULT.	SELL UNIT	STD. PKG.	LEAD TIME	MIN. ORD.	A C
			STOCK AVAILABILITY / PA			

FORM 6693 1 ISS 10-88
0006831 25 EA
IN - Call-Through Testing 911 Inquiry. INDIANA ONLY.

FORM 6694 ISS 10-87
0006758 1 EA
IN - Adjustment Voucher - Cab. INDIANA ONLY.

FORM 6695 ISS 02-90
0006759 100 EA
IN - Taskmate Project Initiation Request. INDIANA ONLY.

FORM 6697 ISS 02-90
0006761 100 EA
IN - Taskmate Program Name & Description Cover Sheet. INDIANA ONLY.

FORM 6698 ISS 08-87
0006762 1 EA
IN - MCP Change Request. INDIANA ONLY.

FORM 6699 ISS 04-90
0006763 100 EA
IN - MTOS Workflow Error/Abend Report. INDIANA ONLY.

FORM 6700 ISS 01-88
0006765 1 EA
IN - CW SSP Enrollment. INDIANA ONLY.

FORM 6701 ISS 08-87
0006766 1 EA
IN - CW 100 SSP Suspensions & YTD Counters. INDIANA ONLY.

FORM 6702 ISS 09-91
0005278 1 EA
IN - Monthly Pass Request. INDIANA ONLY.

001057264 FORM 6702 1
2735449 7500 SH IL IN MI OH WI
33
MI - General Message Paper - 1 Part.

001068642 FORM 6702 2 A942M21
2628289 SE IL IN MI OH WI
33
MI - General Message Paper - 2 Part.

260302427 FORM 6703 ISS 09-87 S5M22
1939355 25 EA IL IN MI OH WI
33
IN - Approval to Remove Furniture or Equipment from Building.

FORM 6704 ISS 09-87
0003535 500 EA
IN - Circuit History Card. INDIANA ONLY.

FORM 6705 ISS 09-87
0003596 500 EA
IN - Return Material Notification. INDIANA ONLY.

PRODUCT IDENTIFIER							DESCRIPTION						
ITEM NUMBER	ORD. MULT.	SELL UNIT	STD. PKG.	LEAD TIME	MIN. ORD.	A C							
							STOCK AVAILABILITY / PA						
0003098	200	EA	FORM 6706	ISS 09-87	IN - Vendors Daily Work Log. INDIANA ONLY.								
0006777	25	EA	FORM 6709	ISS 06-88	IN - SSP Reconcile Differences. INDIANA ONLY.								
0006775	25	EA	FORM 6710	ISS 11-87	IN - SSP Controls. INDIANA ONLY.								
0006773	25	EA	FORM 6711	ISS 11-87	IN - SSP Reconcilements. INDIANA ONLY.								
260303292	N	EA	FORM 6714	ISS 10-87	25	4	2000	IN - Tag - Firestopped Cable Hole.					
0006768	25	EA	FORM 6715	ISS 10-87	IN - Scot Performance Index. INDIANA ONLY.								
0003604	500	EA	FORM 6716	ISS 10-87	IN - Tiling Layout Sheet. INDIANA ONLY.								
0006772	25	EA	FORM 6717	ISS 10-87	IN - Material order. INDIANA ONLY.								
0003500	1000	EA	FORM 6718	ISS 10-87	IN - Special Trap Request. INDIANA ONLY.								
0003607	100	EA	FORM 6719	ISS 10-87	IN - Conformation of Job Completion. INDIANA ONLY.								
0003091	100	EA	FORM 6720	ISS 10-87	IN - Notification of Revised Completion Dates. INDIANA ONLY.								
0003651	100	EA	FORM 6721 1	ISS 10-87	IN - Method of Procedure Authorization. INDIANA ONLY.								
0003631	100	EA	FORM 6721 2	ISS 10-87	IN - Method of Procedure. INDIANA ONLY.								
0003092	100	EA	FORM 6721 3	ISS 10-87	IN - Method of Procedure. INDIANA ONLY.								
0003731	500	EA	FORM 6722	ISS 11-87	IN - Legend for Indiana Bell Telephone Symbols - Evansville. INDIANA ONLY.								

PRODUCT IDENTIFIER							DESCRIPTION						
ITEM NUMBER	ORD. MULT.	SELL UNIT	STD. PKG.	LEAD TIME	MIN. ORD.	A C							
							STOCK AVAILABILITY / PA						
0003733	800	EA	FORM 6723	ISS 11-87	IN - NSO Trouble Ticket. INDIANA ONLY.								
0003262	250	EA	FORM 6724	ISS 11-87	IN - Audio Cassett Library. INDIANA ONLY.								
0003727	1000	EA	FORM 6725	ISS 01-89	IN - Partners in Progress. INDIANA ONLY.								
0006779	25	EA	FORM 6726	ISS 12-87	IN - DMS 10 Network Switching Performance Measurement Plan. INDIANA ONLY.								
0003729	500	EA	FORM 6727	ISS 12-87	IN - Advertising Revenue. INDIANA ONLY.								
0006785	25	EA	FORM 6728	ISS 12-87	IN - N/T Checklist. INDIANA ONLY.								
0007725	500	EA	FORM 6729	ISS 12-87	IN - ID Authorization Card. INDIANA ONLY.								
0003632	500	EA	FORM 6731	ISS 01-88	IN - Legend for Indiana Bell Telephone Symbols - Columbus. INDIANA ONLY.								
0003630	500	EA	FORM 6732	ISS 01-88	IN - Legend for Indiana Bell Telephone Symbols - New Albany. INDIANA ONLY.								
0006781	25	EA	FORM 6733	ISS 01-88	IN - Job Schedule. INDIANA ONLY.								
0006798	50	EA	FORM 6734	ISS 01-88	IN - CRIS Packet Switching Guide Input. INDIANA ONLY.								
0006793	100	EA	FORM 6735	ISS 04-91	IN - CABS Packet Switching Supplemental Input. INDIANA ONLY.								
0006791	50	EA	FORM 6736	ISS 01-88	IN - RSC Feedback. INDIANA ONLY.								
0003093	500	EA	FORM 6737	ISS 01-88	IN - Legend for Indiana Bell Telephone Symbols - Crawfordsville. INDIANA ONLY.								
0006794	50	EA	FORM 6739	ISS 01-88	IN - Working & Spare TOC Distribution. INDIANA ONLY.								

DISTRIBUTION SERVICES

NETWORK SERVICES

TOOLS

BUILDING JANITORIAL

AUTOMOTIVE

FORMS/OFFICE SUPPLIES

GENERAL

DATA VOICE

FORM

PRODUCT IDENTIFIER		DESCRIPTION							
ITEM NUMBER	ORD. MULT.	SELL UNIT	STD. PKG. STOCK	PKG. AVAILABILITY	LEAD TIME / PA	MIN. ORD.	A C		
0006787	50	EA	FORM 6740	ISS 01-88	INDIANA ONLY.				
0006795	25	EA	FORM 6741	ISS 02-88	IN - MCP General Change. INDIANA ONLY.				
0006834	1	PD	FORM 6742		INDIANA ONLY.				
0007711	50	EA	FORM 6743	ISS 02-88	IN - Buried Cable Hanger. INDIANA ONLY.				
0003261	5000	EA	FORM 6745	ISS 02-88	IN - COE Reused Inventory Tag. INDIANA ONLY.				
0006802	25	EA	FORM 6746	ISS 02-88	IN - COPTS Tariff Violation. INDIANA ONLY.				
1947606	1	PD	260336433 FORM 6747	ISS 08-88	IL	IN	MI	OH	WI
			IN - Repair Visit Charge Post-It.						
1947812	1	PK	260336458 FORM 6748	ISS 08-88	IL	IN	MI	OH	WI
			IN - SNI Informational Door Hangar.						
0006803	25	EA	FORM 6749	ISS 03-88	IN - Billing Analysis Time and Expense Report. INDIANA ONLY.				
1168203	500	EA	001057298 FORM 6749 D		IL	IN	MI	OH	WI
			Envelope.						
0006804	25	EA	FORM 6750	ISS 03-88	IN - Savings Plans Form History. INDIANA ONLY.				
0006805	25	EA	FORM 6751	ISS 03-88	IN - Cash Payment Chart For Insurance. INDIANA ONLY.				
0006810	50	EA	FORM 6752	ISS 03-88	IN - Service Assistant Development Summary. INDIANA ONLY.				
1944819	1	SH	260324447 FORM 6753	ISS 03-88	IL	IN	MI	OH	WI
			IN - Label - Tax District.						

PRODUCT IDENTIFIER		DESCRIPTION							
ITEM NUMBER	ORD. MULT.	SELL UNIT	STD. PKG. STOCK	PKG. AVAILABILITY	LEAD TIME / PA	MIN. ORD.	A C		
0006808	25	EA	FORM 6753	ISS 03-88	IN - WATS Guide Update. INDIANA ONLY.				
0006817	25	EA	FORM 6756	ISS 04-88	IN - Status Code Updates - CP150. INDIANA ONLY.				
1946251	100	SH	260329388 FORM 6757	ISS 05-88	IL	IN	MI	OH	WI
			IN - Jack Identifier.						
1945964	1	PK	260328141 FORM 6758	ISS 05-88 S4022	IL	IN	MI	OH	WI
			IN - Label - Hazard Warning.						
0003584	500	EA	FORM 6759	ISS 05-88	IN - Adjustment Confirmation Dial 1 and Charges. INDIANA ONLY.				
1947374	25	SE	260331632 FORM 6760	ISS 06-88 S1M22	IL	IN	MI	OH	WI
			IN - Cancellation Charge Worksheet.						
0003730	500	EA	FORM 6761	ISS 06-88	IN - Right of Way Department Folder. INDIANA ONLY.				
1946244	5	PD	260329370 FORM 6762	ISS 05-88 S5022	IL	IN	MI	OH	WI
			IN - Customer Contact Memo 219.						
0003078	200	EA	FORM 6764	ISS 06-88	IN - Business Office Investigation, 100 per package. INDIANA ONLY.				
0003756	25	SE	FORM 6765	ISS 06-88	IN - Request for Software. INDIANA ONLY.				
0006822	1	PD	FORM 6766	ISS 06-88	IN - Items Covered in Section Meeting. INDIANA ONLY.				
0006826	25	EA	FORM 6767	ISS 06-88	IN - Commercial Insurance Remittance Worksheet. INDIANA ONLY.				
0006826	25	EA	FORM 6767	ISS 06-88	IN - Commercial Insurance Remittance Worksheet. INDIANA ONLY.				
0003761	100	SE	FORM 6768	ISS 06-88	IN - Approval of Software Request. INDIANA ONLY.				

PRODUCT IDENTIFIER		DESCRIPTION				
ITEM NUMBER	ORD. MULT.	SELL UNIT	STD. PKG. STOCK AVAILABILITY / PA	LEAD TIME	MIN. ORD.	A C
FORM 6769		ISS 07-88				
0003732	500	EA				
IN - Envelope Business Reply Room 795. INDIANA ONLY.						
FORM 6770		ISS 07-88				
0006821	50	EA				
IN - Commitment Referral Form. INDIANA ONLY.						
260336425 FORM		6772 ISS 07-88				
N		SE	25	4	1000	
IN - Customer Easement Agreement.						
260344528 FORM		6774 ISS 08-88				
1950618	1	EA	IL IN MI OH WI	33		
FORM 6775		ISS 09-88				
0006832	25	EA				
IN - Dial-A-Porn Complaint. INDIANA ONLY.						
FORM 6776		ISS 08-88				
0006825	50	EA				
IN - Contact Memo ICSC. INDIANA ONLY.						
FORM 6777		ISS 08-88				
0003734	500	EA				
IN - SARTS/SMAS Trouble Ticket. INDIANA ONLY.						
FORM 6778						
0006827						
INDIANA ONLY.						
FORM 6779		ISS 08-88				
0006838	25	EA				
IN - COG Screening Request. INDIANA ONLY.						
FORM 6780		ISS 08-88				
0006839	25	EA				
IN - COG Screening/Disconnect Notification. INDIANA ONLY.						
FORM 6781		ISS 08-88				
0007723	50	EA				
IN - Have-a-Heart Note Pad. INDIANA ONLY.						
260344536 FORM		6782 ISS 09-88 A70M22				
1950600	500	SH	IL IN MI OH WI	33		
IN - Letterhead - Outstate - Laser.						
FORM 6783		ISS 02-89				
0003740	500	EA				
IN - Direct High Capacity Letter of Election. INDIANA ONLY.						
FORM 6783 A		ISS 08-91				
0003762						
IN - Optinet Base Rate Letter of Election. INDIANA ONLY.						
FORM 6784		ISS 09-84				
0003735	50	SE				
IN - SR Map Test Data Record. INDIANA ONLY.						

PRODUCT IDENTIFIER		DESCRIPTION				
ITEM NUMBER	ORD. MULT.	SELL UNIT	STD. PKG. STOCK AVAILABILITY / PA	LEAD TIME	MIN. ORD.	A C
FORM 6785		ISS 10-88				
0006829	50	EA				
IN - Sale/Removal Form. INDIANA ONLY.						
FORM 6786		ISS 11-88				
0006835	25	EA				
IN - Remote Terminal Site Inspection. INDIANA ONLY.						
FORM 6786 1		ISS 11-88				
0006837	25	EA				
IN - Remote Terminal Site Inspection. INDIANA ONLY.						
FORM 6788		ISS 11-88				
0003736	500	EA				
IN - Cross Box Talk Pair. INDIANA ONLY.						
260339254 FORM		6789 ISS 10-88				
1948729	50	EA	IL IN MI OH WI	33		
IN - Label - ASI Miscellaneous Material.						
260341268 FORM		6790 ISS 10-88				
1949594	1	EA	IL IN MI OH WI	33		
IN - No Access Notice - Residence.						
260341276 FORM		6791 ISS 11-88				
1949602	5	PD	IL IN MI OH WI	33		
IN - Customer Contact Memo - Business.						
FORM 6792		ISS 11-88				
0006836	25	EA				
IN - Ameritech Quotation System Activity Report. INDIANA ONLY.						
FORM 6793		ISS 11-88				
0003737	500	EA				
IN - Check Numbers for Job Setup. INDIANA ONLY.						
FORM 6794		ISS 02-92				
0003738	200	EA				
IN - Request for Budget & Six Year Plan Input. INDIANA ONLY.						
260385984 FORM		6795 ISS 06-90 S5M22				
1963553	50	EA	IL IN MI OH WI	33		
IN - Door Hanger - Cable Locate Acknowledgement.						
260348958 FORM		6799 ISS 03-89				
1951848	10	PD	IL IN MI OH WI	33		
IN - Repair Action Line.						
FORM 6800		ISS 03-89				
0006840	100	EA				
IN - CABS Ssupression of Late Payment Charge. INDIANA ONLY.						
FORM 6801		ISS 06-89				
0006841	100	EA				
IN - Facsimile Data Request. INDIANA ONLY.						

DISTRIBUTION SERVICES
 NETWORK SERVICES
 TOOLS
 BUILDING JANITORIAL
 AUTOMOTIVE
 FORMS/OFFICE SUPPLIES
 GENERAL
 DATA VOICE

DISTRIBUTION SERVICES

NETWORK SERVICES

TOOLS

BUILDING JANITORIAL

AUTOMOTIVE

FORMS/OFFICE SUPPLIES

GENERAL

DATA VOICE

FORM

PRODUCT IDENTIFIER		DESCRIPTION					
ITEM NUMBER	ORD. MULT.	SELL UNIT	STD. PKG. STOCK AVAILABILITY / PA	LEAD TIME	MIN. ORD.	A C	
FORM 6802		ISS 04-89					
0003743	500	EA					
IN - Directory Advertising Cut-Out List. INDIANA ONLY.							
FORM 6803		ISS 04-89					
0006842	100	EA					
IN - Recharge Check Notice. INDIANA ONLY.							
FORM 6805		ISS 05-91					
0006845	100	EA					
IN - Specials Work - Miscellaneous Private Line. INDIANA ONLY.							
FORM 6806		ISS 05-91					
0006846	100	EA					
IN - Specials Work Sheet FX. INDIANA ONLY.							
FORM 6807 1		ISS 06-89					
0006847	100	EA					
IN - Band O WATS Worksheet - 1. INDIANA ONLY.							
FORM 6807 2		ISS 06-89					
0006848	100	EA					
IN - Band O WATS Worksheet - 2. INDIANA ONLY.							
FORM 6808		ISS 06-89					
0006843	100	EA					
IN - VMX Messages Log. INDIANA ONLY.							
FORM 6809		ISS 05-91					
0006849	100	EA					
IN - Centrex Mate Strip. INDIANA ONLY.							
FORM 6810		ISS 06-89					
0003745	100	EA					
INDIANA ONLY.							
FORM 6811		ISS 08-89					
0007716	1	EA					
IN - Service Charge Waiver Approval for Co Sponsored Service Promotion. INDIANA ONLY.							
FORM 6812		ISS 08-89					
0007715	25	EA					
IN - SES-5. INDIANA ONLY.							
260366307 FORM 6813		ISS 11-89					
1955070	1	EA	IL IN MI OH WI				
33 IN - Loop I&M Review.							
FORM 6815		ISS 03-91					
0006981	50	EA					
IN - Performance Record. INDIANA ONLY.							
FORM 6816		ISS 10-89					
0007717	1	EA					
IN - Cable Hole Tag. INDIANA ONLY.							
FORM 6818		ISS 11-89					
0003748	200	EA					
IN - Conduit Delivery. INDIANA ONLY.							

PRODUCT IDENTIFIER		DESCRIPTION					
ITEM NUMBER	ORD. MULT.	SELL UNIT	STD. PKG. STOCK AVAILABILITY / PA	LEAD TIME	MIN. ORD.	A C	
FORM 6819		ISS 11-89					
0003749	200	EA					
IN - Job Order Progress Memo. INDIANA ONLY.							
FORM 6820		ISS 11-89					
0003759	200	EA					
IN - Estimate/Job Order Progress Memo. INDIANA ONLY.							
FORM 6822		ISS 11-89					
0006858	100	EA					
IN - Weekly Performance Trend Record. INDIANA ONLY.							
260367685 FORM 6823		ISS 11-89 S1M22					
1955385	100	SH	IL IN MI OH WI				
33 IN - Fiber Cable Quality Inspection.							
FORM 6825		ISS 01-90					
0007719	1	PD					
IN - Application for Dependent Care Leave of Absence. INDIANA ONLY.							
FORM 6825 1		ISS 01-90					
0007720	1	PD					
IN - Extension Application for Dependent Care Leave of Absence. INDIANA ONLY.							
FORM 6826		ISS 01-90					
0006856	100	EA					
IN - Lump Sum Settlement Worksheet. INDIANA ONLY.							
FORM 6827		ISS 01-90					
0007718	1	SE					
IN - Outside Plant Technician On the Job Training. INDIANA ONLY.							
FORM 6828		ISS 01-90					
0006860	100	EA					
IN - On Job Training-Daily Report. INDIANA ONLY.							
FORM 6829		ISS 01-90					
0006862	100	EA					
IN - Supervisors on Job Training Schedule. INDIANA ONLY.							
FORM 6830		ISS 01-90					
0006863	50	EA					
IN - Training Record. INDIANA ONLY.							
FORM 6832		ISS 01-90					
0006868	100	EA					
IN - Project Request. INDIANA ONLY.							
FORM 6833		ISS 02-90					
0006870	100	EA					
IN - Taskmate Video Tracking Log. INDIANA ONLY.							
FORM 6834		ISS 02-90					
0006873	100	EA					
IN - Taskmate Estimate of Time & Cost Involving Program Development. INDIANA ONLY.							

PRODUCT IDENTIFIER		DESCRIPTION				
ITEM NUMBER	ORD. MULT.	SELL UNIT	STD. PKG. STOCK AVAILABILITY / PA	LEAD TIME	MIN. ORD.	A C
0006871	100	EA	FORM 6835	ISS 03-90		
			IN - HCTS Plug-In Request. INDIANA ONLY.			
0006872	100	EA	FORM 6836	ISS 03-90		
			IN - Taskmate Project Initiation Log. INDIANA ONLY.			
0006879	100	EA	FORM 6837	ISS 03-90		
			IN - Panoramic User Identification Table-Add Update Form. INDIANA ONLY.			
0006878	100	EA	FORM 6838	ISS 03-90		
			IN - Panoramic User Identification Table-Delete Update Form. INDIANA ONLY.			
0006880	100	EA	FORM 6839	ISS 03-90		
			IN - Employee Daily Log. INDIANA ONLY.			
0006881	100	EA	FORM 6840	ISS 03-90		
			IN - Employee Monthly Summary. INDIANA ONLY.			
0006882	100	EA	FORM 6841	ISS 03-90		
			IN - EWD Quality Exercise. INDIANA ONLY.			
0006883	100	EA	FORM 6842	ISS 03-90		
			IN - EWD Group Summary. INDIANA ONLY.			
0007527	1	EA	FORM 6843	ISS 09-90		
			IN - Payroll Deduction Authorization Vision Plan for Part-Time Employees. INDIANA ONLY.			
0006892	100	SE	FORM 6844	1,2,3 ISS 07-91		
			IN - UCD Ordering Information for Use With DMS-100. INDIANA ONLY.			
0006928	100	EA	FORM 6846	ISS 10-90		
			IN - Payroll Deduction Authorization Sponsored Children & Class II Dependents. INDIANA ONLY.			
0006893	100	EA	FORM 6847	ISS 04-90		
			IN - Centrex DMS ARS Basic Routing Pattern. INDIANA ONLY.			
0007721	25	EA	FORM 6849	ISS 05-90		
			IN - Request for Business Cards. INDIANA ONLY.			
0006894	100	EA	FORM 6850	ISS 05-90		
			IN - Centrex Mate Exempt Stations. INDIANA ONLY.			

PRODUCT IDENTIFIER		DESCRIPTION				
ITEM NUMBER	ORD. MULT.	SELL UNIT	STD. PKG. STOCK AVAILABILITY / PA	LEAD TIME	MIN. ORD.	A C
0006898	100	EA	FORM 6851	1234 ISS 05-90		
			IN - Centrex System & Feature Req. DMS Design & Billing Information. INDIANA ONLY.			
0006902	100	EA	FORM 6852	ISS 06-90		
			IN - Individual Performance Summary. INDIANA ONLY.			
0006901	100	EA	FORM 6853	ISS 06-90		
			IN - Operator Development Summary Information. INDIANA ONLY.			
0006938	100	EA	FORM 6855	12345 ISS 11-91		
			IN - DMS Console. INDIANA ONLY.			
0006899	100	EA	FORM 6856	ISS 07-90		
			INDIANA ONLY.			
1969352	1	PD	260404942 FORM 6857 1	ISS 09-90 S5M22	IL IN MI OH WI	33
			IN - Station Form.			
1969345	1	PD	260404934 FORM 6857 2	ISS 09-90 S5M22	IL IN MI OH WI	33
			IN - Station Form.			
1969337	1	PD	260404926 FORM 6857 3	ISS 09-90 S5M22	IL IN MI OH WI	33
			IN - DMS Centrex Station Detail.			
0006944	100	EA	FORM 6858	ISS 08-90		
			IN - Call Detail Records. INDIANA ONLY.			
0006919	100	EA	FORM 6878	ISS 10-90		
			IN - JFC Form/To List Input Into CP051. INDIANA ONLY.			
0006966			FORM 6879	12345		
			IN - ACD Ordering Info For Use With DMS. INDIANA ONLY.			
0006920	100	EA	FORM 6880	ISS 10-90		
			IN - Input to CM007/Operator Services Profile Change. INDIANA ONLY.			
0006945	100	EA	FORM 6881	ISS 10-90		
			IN - Personal Vehicle Reimbursement. INDIANA ONLY.			
0006986	100	EA	FORM 6882	ISS 07-91		
			IN - Telephone Equipment Order Form. INDIANA ONLY.			

DISTRIBUTION SERVICES

NETWORK SERVICES

TOOLS

BUILDING JANITORIAL

AUTOMOTIVE

FORMS/OFFICE SUPPLIES

GENERAL

DATA VOICE

DISTRIBUTION SERVICES

NETWORK SERVICES

TOOLS

BUILDING JANITORIAL

AUTOMOTIVE

FORMS/OFFICE SUPPLIES

GENERAL

DATA VOICE

FORM

PRODUCT IDENTIFIER		DESCRIPTION					
ITEM NUMBER	ORD. MULT.	SELL UNIT	STD. PKG. STOCK AVAILABILITY / PA	LEAD TIME	MIN. ORD.	A C	
0006960	50	EA	FORM 6883 ISS 03-92				IN - DMS 100 Business Set Worksheet. INDIANA ONLY.
0006961	50	EA	FORM 6884 ISS 01-91				IN - DMS 100 M536 Add-On Worksheet. INDIANA ONLY.
0006962	50	EA	FORM 6885 ISS 01-91				IN - DMS 100 M518 Add-On Worksheet. INDIANA ONLY.
0003760	50	EA	FORM 6886 ISS 01-91				IN - COE - Revised Grids. INDIANA ONLY.
0006954	100	EA	FORM 6887 ISS 12-90				INDIANA ONLY.
1979906	2500	SH	260433214 FORM 6888 ISS 08-91 A5CM22	IL IN MI OH WI	33		IN - TIRKS/CIMAP Paper 9 x 4IN Stripped 8 x 4IN 75LB
1980789	50	SH	260436068 FORM 6889 ISS 10-91 S6M22	IL IN MI OH WI	33		IN - Customer Deposit.
1962449	500	EA	260384383 FORM 6919 2E S5C21	IL IN MI OH WI	33		Business Reply Deposit Envelope. REPLACES 6919 2D
N		SE	200003093 FORM 6923		J40M21	8	40000
N		EA	280041906 FORM 6925 ISS 02-82 J5M24			4	5000
N		EA	200002806 FORM 6947 B J10M21			6	10000
N		EA	260376918 FORM 6954 1 J70M21			8	70000
N		SH	260376900 FORM 6954 A J45M21			8	45000
N		EA	450012778 FORM 6981			6	35000
N		EA	280041930 FORM 6982 F ISS 07-89 J3.5M24			4	3500

PRODUCT IDENTIFIER		DESCRIPTION					
ITEM NUMBER	ORD. MULT.	SELL UNIT	STD. PKG. STOCK AVAILABILITY / PA	LEAD TIME	MIN. ORD.	A C	
0003768	1		FORM 6993 ISS 12-91				IN - Range of Work Locations. INDIANA ONLY.
N		SE	260378856 FORM 6995 ISS 04-91 A225M23			2	100
		OH					Memo Bill.
0007559	1	EA	FORM 7000 ISS 09-88				IN - Spec and Time and Equipment Price Proposal. INDIANA ONLY.
0007560	1	EA	FORM 7000 1 ISS 11-85				IN - Schedule LC-Line Clearance Work/Tree Trim. INDIANA ONLY.
0006719	25	EA	FORM 7005 ISS 09-88				IN - Spec & Price Proposal Sub Surface Fac Loc & Marking. INDIANA ONLY.
0006672	25	EA	FORM 7005 1 ISS 11-85				IN - Schedule FL Sub-Surface Fac Loc & Marking. INDIANA ONLY.
0006952	100	EA	FORM 7011 ISS 12-90				IN - Calculation of Interest Worksheet. INDIANA ONLY.
0006954	100	EA	FORM 7012 ISS 12-90				IN - Special Access/Wats AOC initiated notification. INDIANA ONLY.
0006955	50	EA	FORM 7013 ISS 01-91				IN - Integrated Info Network Pricing Sheet. INDIANA ONLY.
0006963	50	EA	FORM 7014 ISS 01-91				IN - Void Issue Accumulator Updates. INDIANA ONLY.
0006975	25	EA	FORM 7016 1-6 ISS 3-91				IN - Ameritech Automatic Call Distribution. INDIANA ONLY.
0006979	50	SE	FORM 7017 2-3 ISS 3-91				IN - DMS Network Class of Service and Dial Access Codes. INDIANA ONLY.
0006967	50	EA	FORM 7018 ISS 03-91				IN - Ameritech Clothing Allowance. INDIANA ONLY.
N		EA	280043993 FORM 7019 ISS 03-92 J4M24			6	2000
		WI					Overflow Coin Envelope 4-7/8 X 3IN, Brown Kraft.

DISTRIBUTION SERVICES

NETWORK SERVICES

TOOLS

BUILDING JANITORIAL

AUTOMOTIVE

FORMS/OFFICE SUPPLIES

GENERAL

DATA VOICE

PRODUCT IDENTIFIER		DESCRIPTION				
ITEM NUMBER	ORD. MULT.	SELL UNIT	STD. PKG. STOCK AVAILABILITY / PA	LEAD TIME	MIN. ORD.	A C
FORM 7019 ISS 06-91						
0003763	100	EA				
IN - This Cable Hole Opened. INDIANA ONLY.						
200002418 FORM 7039 2A J6M21						
N		EA	1000	6	6000	
280040882 FORM 7050 ISS 10-90 J28M24						
N		SE	100	6	28000	
WI - Request for Directory.						
260322110 FORM 7051 ISS 02-88						
1942706	25	EA	IL IN MI OH WI	33		
IL - Label - IBT Equipment - Do Not Remove.						
280044009 FORM 7052 A ISS 03-92 J25M24						
N		EA	500	6	25000	
WI - Envelope - Payment for Authorized Agents.						
280054149 FORM 7052 C J20M24						
N		EA	400	6	20000	
WI - Business Reply Envelope 6 1/2 X 9 1/2IN Brown Kraft 32LB.						
001049220 FORM 7060 ISS 05-81 S4M20						
6618447	50	SE	IL IN MI OH WI	33		
IL - Defective Pair Recovery Order.						
002037059 FORM 7066 1 ISS 04-80						
5646984	50	SH	IL IN MI OH WI	33		
IL - Label - To Report Trouble Without Telephone Number.						
260359633 FORM 7066 2 ISS 07-89 S5M20						
1953380	100	EA	IL IN MI OH WI	33		
IL - Label - Trouble Report/Data Service (1-800-872-2040).						
002078152 FORM 7067 ISS 09-82 S2M20						
5651109	25	EA	IL IN MI OH WI	33		
IL - Label - Special Service Protection.						
300083516 FORM 7073 ISS 10-85						
5126003	25	EA	IL IN MI OH WI	33		
IL - Label - Property of Illinois Bell.						
280008764 FORM 7073 1 ISS 05-86						
1921452	25	EA	IL IN MI OH WI	33		
IL - Label - Placed by Illinois Bell.						
001057860 FORM 7074 D						
1168849	250	EA	IL IN MI OH WI	33		
Envelope.						
260378872 FORM 7108 1 ISS 04-89 S10M23						
N		SE	4000	8	10000	
OH - Confirming Notice.						

PRODUCT IDENTIFIER		DESCRIPTION				
ITEM NUMBER	ORD. MULT.	SELL UNIT	STD. PKG. STOCK AVAILABILITY / PA	LEAD TIME	MIN. ORD.	A C
280044025 FORM 7112						
N		EA	500	6	25000	
260449376 FORM 7112 ISS 03-92 J25M24						
N						
WI - Cash Envelope (for teller use).						
002055366 FORM 7146						
1184572	50	SH	IL IN MI OH WI	33		
IL - Advance Payment/Deposit Card Transmittal.						
280044033 FORM 7167 1 ISS 08-91						
N		EA	500	6	40000	
280044041 FORM 7167 2 ISS 02-92 J50M24						
N		EA	500	6	30000	
WI - Envelope - 10 X 13IN For Directory (With Permit).						
260386321 FORM 7167 3 J10K24						
N		EA	500	6	10000	
280040890 FORM 7170 ISS 05-91						
N		SE	100	6	20000	
WI - Dishonored Check Recharge Advice.						
300043403 FORM 7175 ISS 12-84						
5115311	500	SH	IL IN MI OH WI	33		
IL - Application For Exception From Operator Assistance Charges.						
300043411 FORM 7175 1 ISS 12-84						
5115295	500	SH	IL IN MI OH WI	33		
IL - Application For Exemption From Directory Assistance Charges.						
260442256 FORM 7222 ISS 02-92 S3M20						
N		EA	50	6	3000	
IL - LABEL CAUTION - Used for 911 Service, 2 X 2IN.						
260442264 FORM 7222-1 ISS 02-92 S3M20						
N		EA	50	6	3000	
IL - LABEL CAUTION - Used for 911 Service, 3 X 9/16IN.						
001089564 FORM 7231						
5618702	50	SE	IL IN MI OH WI	33		
IL - Minor Injury Report.						
300030384 FORM 7246 ISS 09-84						
5107193	500	SH	IL IN MI OH WI	33		
IL - Daily Service Representative Status Of Work - RASC.						
260438635 FORM 7257 L2M20						
N		EA	20	4	2000	
IL - JULIE Request To Locate Underground Facilities.						

FORM

DISTRIBUTION SERVICES

PRODUCT IDENTIFIER	DESCRIPTION					
ITEM	ORD.	SELL	STD. PKG.	LEAD TIME	MIN.	A
NUMBER	MULT.	UNIT	STOCK AVAILABILITY / PA		ORD.	C
003006780			FORM	7259	ISS 03-82	L80M20
N		SH	1000	2	1000	
IL - Service Order Corrections - Service Center to I&M.						

NETWORK SERVICES

001145200			FORM	7270		
5623082	250	SH	IL	IN	MI	OH WI
33 IL - Inter-company Services Coordination Universal Service Order Worksheet.						
260366026			FORM	7280	ISS 03-73	A350M23
N		SH	7000	1	7000	
OH - ESS Switching 8 1/2 X 3 1/2.						

TOOLS

260366034			FORM	7281	ISS 03-73	A6CM23
N		SH	3200	2	3200	
200002426			FORM	7302H		J25M21
N		EA	500	6	25000	
MI - Envelope - For Return of 1297 to the Field.						

BUILDING JANITORIAL

280044058			FORM	7304		
N		EA	500	6	5000	
260449368			FORM	7304	ISS 01-87	J15M24
N						
WI - Depository Envelope.						

AUTOMOTIVE

280060237			FORM	7321 P		
1931139	750	SE	IL	IN	MI	OH WI
33						
001153873			FORM	7351		
5624486	150	SH	IL	IN	MI	OH WI
33 IL - Verbal Telephone No./Central Office Equipment Assignments.						

FORMS/OFFICE SUPPLIES

260382270			FORM	7378	ISS 04-90	S2M5C20
1961391	50	SE	IL	IN	MI	OH WI
33 IL - Street Address Notification.						

GENERAL

200002277			FORM	7379 D		J16M21
N		EA	500	6	16000	
Envelope.						
280044066			FORM	7385/7386		
N		EA	500	6	83000	
260406889			FORM	7386	ISS 06-82	J61M8C24
N		EA	300	6	61800	
WI - Treatment Notice Envelope - Milwaukee.						
260394358			FORM	7391 F	ISS 08-90	
N		EA	250	4	10000	

DATA VOICE

260323985			FORM	7397	ISS 04-88	S2M20
1944504	25	EA	IL	IN	MI	OH WI
33 IL - Defective Cable Pair Listing.						
280042110			FORM	7401 20U-37	ISS 12-72	
N		EA	1600	8	24000	

PRODUCT IDENTIFIER	DESCRIPTION					
ITEM	ORD.	SELL	STD. PKG.	LEAD TIME	MIN.	A
NUMBER	MULT.	UNIT	STOCK AVAILABILITY / PA		ORD.	C

280042078			FORM	7401 2-40	ISS 07-80	J40M24
N		SE	1000	8	40800	
280042128			FORM	7401 30-37		J8M24
N		SE	1000	4	8000	
280046301			FORM	7401 37-40-1		
N		EA	3000	2	3000	
280042151			FORM	7401 37-40-1	ISS 05-83	L24
N		SE	1125	2	1125	
280042144			FORM	7401 37-40-2	ISS 05-83	L24
N		SE	1550	2	1550	
280042169			FORM	7401 39	ISS 12-91	J88M24
N		EA	2750	2	88000	
280042177			FORM	7401 51	ISS 06-83	J70M24
N		EA	3000	2	70000	
280042185			FORM	7401 52	ISS 01-86	J5M24
N		SE	500	8	5000	
280041989			FORM	7420	ISS 05-84	J25M24
N		EA	500	4	25000	
280041997			FORM	7429	ISS 09-91	J15M24
N		EA	500	4	15000	
WI - Time Extension To Prevent Disconnection of Service.						
260394366			FORM	7429 B	ISS 09-91	J2M24
N		EA	100	4	2000	
WI - Permanent Disconnect - Business.						
260394374			FORM	7429 C	ISS 09-91	J10M24
N		EA	100	4	10000	
WI - Denial Notice - Student Toll.						
260394382			FORM	7429 F	ISS 08-90	J4M24
N		EA	100	4	4000	
260394390			FORM	7429 G	ISS 09-91	J20M24
N		EA	500	4	20000	
WI - CDN - Student Toll.						
260392063			FORM	7429 H	ISS 09-91	J25M24
N		EA	100	4	25000	
WI - Time Extension for Payment to Prevent Disconnection of Service.						
260394275			FORM	7429 J	ISS 09-91	J5M24
N		EA	500	4	5000	
WI - Permanent Disconnect - Residential.						
260428701			FORM	7429D	ISS 09-91	J5M24
N		SH	100	4	7000	
WI - Disconnection Notice.						
280042011			FORM	7468	ISS 02-73	J5M24
N		EA	500	4	5000	

PRODUCT IDENTIFIER		DESCRIPTION				
ITEM NUMBER	ORD. MULT.	SELL UNIT	STD. PKG. STOCK AVAILABILITY / PA	LEAD TIME	MIN. ORD.	A C
260394408	FORM	7480	A	ISS 08-90	J2M24	
N		EA	250	4	2000	
260394416	FORM	7480	B	ISS 09-91	J15M24	
N		EA	100	4	15000	
WI - Disconnect Notice - Business.						
280060708	FORM	7480	C	ISS 09-91	J25M24	
N		EA	250	4	25000	
WI - Disconnection Notice - Residential.						
260394283	FORM	7480	D	ISS 09-91	J2M24	
N		EA	100	4	2000	
WI - Disconnect Notice - Coin.						
260394291	FORM	7480	E	ISS 09-91	J4M24	
N		EA	100	4	4000	
WI - ARD Cancel - Business.						
260394424	FORM	7481	A	ISS 08-90	J4M24	
N		EA	100	4	4000	
260394432	FORM	7481	C	ISS 08-90	J4M24	
N		EA	100	4	4000	
260394440	FORM	7481	D	ISS 08-90	J1M24	
N		EA	100	4	1000	
260394457	FORM	7482		ISS 08-90	J4M24	
N		EA	100	4	4000	
260394465	FORM	7482	B	ISS 08-90	J1M24	
N		EA	100	4	1000	
260435805	FORM	7483A		ISS 09-91	J17M24	
N		SH	100	4	17000	
WI - Default - Res to Avoid Disconnection.						
280045600	FORM	7509		ISS 09-72	J48M24	
N		SH	6000	6	48000	
WI - Customer Bill.						
260440938	FORM	7542	1	ISS 02-92	S150M20	
N		SH	500	4	150000	
260319793	FORM	7550		ISS 01-88		
1941708	500	SH		IL IN MI OH WI		
33 IL - XTR Daily Control & Security Report.						
001233774	FORM	7551				
5637108	500	SH		IL IN MI OH WI		
33 IL - Extra Employees Added To Payroll.						
002074250	FORM	7552		ISS 06-82	S70M20	
5650705	500	SH		IL IN MI OH WI		
33 IL - XTR Daily Time Record.						
002074288	FORM	7553		ISS 06-82		
5650689	500	SH		IL IN MI OH WI		
33 IL - XTR Daily Time Record - Operator Services.						

PRODUCT IDENTIFIER		DESCRIPTION				
ITEM NUMBER	ORD. MULT.	SELL UNIT	STD. PKG. STOCK AVAILABILITY / PA	LEAD TIME	MIN. ORD.	A C
001234871	FORM	7555				
5637280	1000	SH		IL IN MI OH WI		
33 IL - XTR Transmittal Control, Management.						
300072717	FORM	7556		ISS 04-79	L17M20	
N		SE	1000	2	1000	
IL - XTR Advice - Management, 2 Sheets per set.						
260449392	FORM	7661		ISS 03-92	J10M24	
N						
WI - Envelope for Personal Code Card.						
280044108	FORM	7661		ISS 05-80		
N		EA	500	6	10000	
300077146	FORM	7661	1	ISS 10-85		
5124032	100	SE		IL IN MI OH WI		
33 IL - Marketing Services Assignment Document.						
260404835	FORM	7711	1	ISS 11-90	S2M20	
1969238	1	EA		IL IN MI OH WI		
33 IL - Microfiche to be Destroyed Label.						
260404827	FORM	7711	2	ISS 11-90	S2M20	
1969220	1	EA		IL IN MI OH WI		
33 IL - Label - Records to be Destroyed.						
260390497	FORM	7766		ISS 08-90	S10M20	
1965178	1000	SH		IL IN MI OH WI		
33 IL - Daily Registration.						
260422498	FORM	7770		ISS 05-91	S4M20	
1975649	50	EA		IL IN MI OH WI		
33 IL - Tag DS1 Circuit.						
200005452	FORM	7771	05	ISS 09-87	L6M20	
N		SH	100	2	100	
IL - Vehicle and Special Tool Status Report.						
001213362	FORM	7771	35			
5634782	50	SE		IL IN MI OH WI		
33 IL - Motor Vehicle Requisition.						
260442330	FORM	7771	35	ISS 10-80	S10M20	
N		SE	50	8	10000	
IL - Motor Vehicle Requisition.						
001207182	FORM	7771	51			
5634303	500	SH		IL IN MI OH WI		
33 IL - Motor Vehicle Preventive Maintenance Inspection Report.						
001163526	FORM	7777		ISS 07-82	J15M20	
N		SE	50	8	15000	
IL - Customer Directory File Input.						

DISTRIBUTION SERVICES
 NETWORK SERVICES
 TOOLS
 BUILDING JANITORIAL
 AUTOMOTIVE
 FORMS/OFFICE SUPPLIES
 GENERAL
 DATA VOICE

FORM

DISTRIBUTION SERVICES

PRODUCT IDENTIFIER		DESCRIPTION				
ITEM NUMBER	ORD. MULT.	SELL UNIT	STD. PKG. STOCK AVAILABILITY / PA	LEAD TIME	MIN. ORD.	A C
260378955		FORM	7831 ISS 11-83	J5M23		
N		EA	1100	8	5000	
OH - Long Distance Questions and Claims.						

NETWORK SERVICES

200002459		FORM	7852 1A	J10M21		
N		EA	500	6	10000	
Envelope.						
200002467		FORM	7852 2B	J15M21		
N		EA	500	6	15000	
Envelope.						
200002814		FORM	7852 B	J10M21		
N		EA	500	6	10000	
Envelope.						

TOOLS

280048018		FORM	7880 ISS 03-86			
1926840	1600	SE	IL IN MI OH WI			
33						
IL - TRACS Daily Time and Work Report.						

BUILDING JANITORIAL

260391412		FORM	7890 E	A1MIL200M21		
1965483	2000	SE	IL IN MI OH WI			
33						
Universal Service Order - 2 part.						
260391404		FORM	7891 E	A250M21		
1965475	2750	SH	IL IN MI OH WI			
33						
Universal Service Order Monitor Copy.						

AUTOMOTIVE

001056696		FORM	7893	A1MIL4C98M21		
2273565	2800	SH	IL IN MI OH WI			
33						
280041369		FORM	7895 ISS 05-86	J6M24		
N		EA	100	4	6000	
260419395		FORM	7895 1 ISS 02-91	J25M24		
N		SH	100	4	25000	
WI - High Bill Notice.						

FORMS/OFFICE SUPPLIES

260419056		FORM	7895 2 ISS 03-91	J5M24		
N		SH	100	4	5000	
WI - Directory Advertising Notice.						
280041385		FORM	7923 ISS 08-90	J10M24		
N		EA	500	4	10000	
280041393		FORM	7923 A ISS 08-90	J10M24		
N		EA	500	4	10000	
280041401		FORM	7923 B ISS 02-82	J12M24		
N		EA	500	4	12000	
280041419		FORM	7923 C ISS 03-82	J10M24		
N		EA	500	4	10000	
280041427		FORM	7923 D ISS 08-90	J6M24		
N		EA	500	4	6000	
280041435		FORM	7923 E ISS 08-90	J10M24		
N		EA	500	4	10000	

GENERAL

DATA VOICE

PRODUCT IDENTIFIER		DESCRIPTION				
ITEM NUMBER	ORD. MULT.	SELL UNIT	STD. PKG. STOCK AVAILABILITY / PA	LEAD TIME	MIN. ORD.	A C
280041443		FORM	7923 F ISS 08-90	J7.5M24		
N		EA	500	4	7500	
260394473		FORM	7923 G ISS 08-90	J6M24		
N		EA	500	4	6000	
260394309		FORM	7923 H ISS 08-90	J10M24		
N		EA	100	4	10000	
260394317		FORM	7923 J ISS 08-90	J6M24		
N		EA	100	4	6000	
260394325		FORM	7923 K ISS 08-90	J10M24		
N		EA	100	4	10000	
260394333		FORM	7923 M ISS 08-90	J10M24		
N		EA	500	4	10000	
260394341		FORM	7923 N ISS 08-90	J12M24		
N		EA	500	4	12000	
260394481		FORM	7930 ISS 08-90	J1M24		
N		EA	100	4	1000	
280046442		FORM	7983 ISS 08-90	J18M24		
N		EA	500	4	18000	
280045618		FORM	7990			
N		EA	44000	2	44000	
Cabs Bill, Box/24.						
280045626		FORM	7990 1 ISS 10-90			
N		SH	3000	1	3000	
WI - CABS Bill and CSR Form. Roll/24.						
260319934		FORM	7990 1 ISS 10-90			
N		SH	3000	1	3000	
WI - Cabs Bill Form Customer Copy. Box/24.						
280054172		FORM	7990 3 ISS 10-86	J1M24		
N		EA	1000	6	1000	
WI - Cabs Treatment Envelope.						
280041492		FORM	7999 ISS 09-91	J70M24		
N		EA	100	4	70000	
WI - Adjustment Document.						
001056779		FORM	8025			
2772467	2500	SH	IL IN MI OH WI			
33						
200003127		FORM	8025 1	J250M21		
N		SH	2700	8	250000	
200003135		FORM	8025 2A	J1CM21		
N		SE	1600	8	100000	
001056787		FORM	8026			
2772483	5000	SH	IL IN MI OH WI			
33						
MI - Message Paper.						

PRODUCT IDENTIFIER		DESCRIPTION					
ITEM NUMBER	ORD. MULT.	SELL UNIT	STD. PKG. STOCK AVAILABILITY / PA	LEAD TIME	MIN. ORD.	A C	
260328133 FORM 8048 ISS 06-88							
1945956	500	SH	IL IN MI OH WI 33				
IL - Deferred Work Form.							
260419635 FORM 8048-1 ISS 03-91 S10M20							
1974493	10000	SH	IL IN MI OH WI 33				
IL - Presurvey - Deferred Work Form.							
200003150 FORM 8056 1 L35M21							
N		SE	3300	2	3300		
260376652 FORM 8129 1A J2MIL250M21							
N		SH	2000	8	2250000		
MI - Service Billing Record - 1 Ply.							
260376678 FORM 8238 E J2CM21							
N		SH	2000	8	200000		
MI - NW - Postal/Parcel Labels.							
260417308 FORM 8281 ISS 04-91 S5M20							
1972497	5000	BK	IL IN MI OH WI 33				
IL - Book - Agreement for Installation & Maintenance Services.							
260391420 FORM 8554 D A812M21							
1965491		SE	IL IN MI OH WI 33				
Universal Service Order - 5 part.							
260438700 FORM 8554-1 A812M5C21							
N		SE	1250	8	1250		
MI - Universal Service Order - 3-part.							
260376694 FORM 8704 1 J1MIL21							
N		SH	2600	8	2600		
MI - Aternis Lineprinter Form - Universal.							
260366117 FORM 8805 ISS 09-80 A1MIL7CM23							
N		SH	6900	2	6900		
260303755 FORM 9032 2 ISS 10-87 S2M20							
1940379	1	EA	IL IN MI OH WI 33				
IL - Label - Interface/Demarc.							
260366166 FORM 9094 ISS 06-90 J10M23							
N		SH	1100	8	10000		
260366182 FORM 9103.1 ISS 06-90 A50M23							
N		SH	3500	2	3500		
260366190 FORM 9109 ISS 06-90 A140M23							
N		SE	1500	2	1500		
200002491 FORM 9169 1 J5M21							
N		EA	500	6	5000		
Envelope.							
200002483 FORM 9169 C J150M21							
N		EA	500	6	250000		
Envelope.							

PRODUCT IDENTIFIER		DESCRIPTION					
ITEM NUMBER	ORD. MULT.	SELL UNIT	STD. PKG. STOCK AVAILABILITY / PA	LEAD TIME	MIN. ORD.	A C	
260376744 FORM 9369 C J18M21							
N		SH	2000	8	18000		
MI - Functional Accounting Information - Wallet Card.							
200005684 FORM 9509 ISS 09-87 L480M20							
N		SH	2400	2	2400		
IL - Output Paper 9 1/2 X 11IN 1 Part Blue Horizontal Stripe.							
260395314 FORM 9510 VT-2 J75M21							
N		SE	900	8	75000		
MI - Custom Heavy Weight Teletype.							
300055589 FORM 9742 A							
N		SE	750	4	12500		
260366240 FORM 9780 ISS 06-90 A1600M23							
N		SE	650	2	650		
260379102 FORM 9833 ISS 07-81 J1M23							
N		SE	150	8	1000		
OH - Joint Use and Construction Proposal.							
260379110 FORM 9851 ISS 04-91 J8M23							
N		SE	100	8	8000		
OH - Notice Confirming.							
260379128 FORM 9852 ISS 04-91 J4M23							
N		SE	100	8	4000		
OH - Notice of Returned Check.							
260379136 FORM 9853 ISS 04-91 J8M23							
N		SE	100	8	8000		
OH - Returned Check Disconnection Notice.							
260379151 FORM 9871 ISS 01-91 J8M23							
N		SE	100	8	8000		
OH - Important Notice.							
260378450 FORM 9991 ISS 07-82 A30M23							
N		SH	3650	2	3650		
OH - Teletype Paper - Specially perforated with 7-hole drill.							
260364328 FORM 10012 ISS 12-89							
1954412	100	SE	IL IN MI OH WI 33				
IL - Buried Service Wire Requirement.							
300040581 FORM 10016 ISS 07-79							
5111708	1000	SH	IL IN MI OH WI 33				
IL - Work Order Progress Report.							
260368907 FORM 10021 ISS 03-90 S100M20							
1955708	1	SE	IL IN MI OH WI 33				
IL - Daily Time and Material Report.							
260376785 FORM 10640-1B J2.6MIL21							
N		SH	3000	8	3350000		
MI - Status and Test Summary, white.							

DISTRIBUTION SERVICES

NETWORK SERVICES

TOOLS

BUILDING JANITORIAL

AUTOMOTIVE

FORMS/OFFICE SUPPLIES

GENERAL

DATA VOICE

DISTRIBUTION SERVICES

NETWORK SERVICES

TOOLS

BUILDING JANITORIAL

AUTOMOTIVE

FORMS/OFFICE SUPPLIES

GENERAL

DATA VOICE

FORM

PRODUCT IDENTIFIER		DESCRIPTION				
ITEM NUMBER	ORD. MULT.	SELL UNIT	STD. PKG. STOCK AVAILABILITY / PA	LEAD TIME	MIN. ORD.	A C
260411616		FORM	10668	ISS 05-91	J5M23	
N		SE	100	8	5000	
			OH - Ameritech Operating Co (AOC) Block End User.			
260376793		FORM	10745	B	J1MIL5C21	
N		SH	2000	8	150000	
			MI - CLR Teletype Form.			
260376835		FORM	12020		J400M21	
N		SH	2500	8	2500	
			MI - Carrier Bill - Box Version.			
260395322		FORM	12020	R	J1MIL250M21	
N		SH	45900	8	45900	
			MI - Carrier Bill (Roll Feed Version).			
200005965		FORM	12523		J10M21	
N		EA	250	6	10000	
200005981		FORM	12523	1	J5M21	
N		EA	250	6	5000	
200005973		FORM	12523	2	J5M21	
N		EA	250	6	5000	
260376876		FORM	12558		J50M21	
N		SH	2650	8	50000	
			MI - MARS Agents Transmittal Form.			
260375878		FORM	12625		J600M21	
N		SH	8800	8	600000	
			MI - Scan Page (Bill).			
260395694		FORM	12639		J1MIL281M6C	
N		SH	5200	8	5200	
			MI - OTEPS.			
260449384		FORM	2040	ISS 03-92	J20M24	
N			WI - ENVELOPE - Payroll Change Report.			
		FORM A	55	C	ISS 05-75	
0004172	100	EA	IN - Resummary Tally Sheet. INDIANA ONLY.			
		FORM A	108	D	ISS 10-74	
0004025	25	EA	IN - Payroll Controls. INDIANA ONLY.			
		FORM A	112	A	ISS 11-76	
0004030	100	EA	IN - RC-JFC-EC Validation Table Update. INDIANA ONLY.			
		FORM A	120		ISS 08-87	
0004063	100	EA	IN - Allotment Adjustments - #07 Record. INDIANA ONLY.			
		FORM A	121	1	ISS 05-88	
0004071	100	EA	IN - Master File Adjustments - #01 Record. INDIANA ONLY.			

PRODUCT IDENTIFIER		DESCRIPTION				
ITEM NUMBER	ORD. MULT.	SELL UNIT	STD. PKG. STOCK AVAILABILITY / PA	LEAD TIME	MIN. ORD.	A C
		FORM A	121	2	ISS 05-88	
0004072	100	EA	IN - Master File Adjustments - #02 Record. INDIANA ONLY.			
		FORM A	121	3	ISS 11-88	
0006757	1	EA	IN - Master File Adjustments - #03 Record. INDIANA ONLY.			
		FORM A	121	4	ISS 05-88	
0006764	1	EA	IN - Master File Adjustments - #04 Record. INDIANA ONLY.			
		FORM A	122		ISS 07-85	
0004089	25	EA	IN - Wage Loan Recovered. INDIANA ONLY.			
		FORM A	150		ISS 12-84	
0004091	100	EA	IN - Record Adjustment Form CPR Wire Mileage. INDIANA ONLY.			
		FORM A	151	1	ISS 09-87	
0004092	100	EA	IN - Allotment Controls. INDIANA ONLY.			
		FORM A	151	2	ISS 09-85	
0004093	100	EA	IN - Allotment Controls. INDIANA ONLY.			
		FORM A	153		ISS 01-88	
0004095	25	EA	IN - Account 122-01 Supply Record Control. INDIANA ONLY.			
		FORM A	197		ISS 12-82	
0004100	50	EA	IN - Miscellaneous Source Data for Comb JNL Entry. INDIANA ONLY.			
		FORM A	254	A		
0004112	500	EA	IN - Payroll Correction Memo. INDIANA ONLY.			
		FORM A	262		ISS 06-91	
0004113	100	EA	IN - USDC Identification Records. INDIANA ONLY.			
		FORM A	398			
0004126	1500	EA	IN - Pre-Billing Inquiries. INDIANA ONLY.			
		FORM A	444	1	ISS 02-86	
0004130	1000	EA	IN - Voucher Control. INDIANA ONLY.			
		FORM A	444	2	ISS 02-86	
0004131	200	EA	IN - Voucher Control. INDIANA ONLY.			
		FORM A	444	3	ISS 02-86	
0004132	200	EA	IN - Voucher Control. INDIANA ONLY.			

PRODUCT IDENTIFIER		DESCRIPTION				
ITEM NUMBER	ORD. MULT.	SELL UNIT	STD. PKG. STOCK AVAILABILITY / PA	LEAD TIME	MIN. ORD.	A C
0004133	200	EA	FORM A 444 4 ISS 02-86			
			IN - Voucher Control. INDIANA ONLY.			
0006729	200	EA	FORM A 444 5 ISS 02-86			
			IN - Voucher Control. INDIANA ONLY.			
0006730	200	EA	FORM A 444 6 ISS 02-86			
			IN - Voucher Control. INDIANA ONLY.			
0004149	25	EA	FORM A 479 B			
			IN - Miscellaneous Input Document. INDIANA ONLY.			
0004150	100	EA	FORM A 484			
			IN - Cash Transfer. INDIANA ONLY.			
0004162	1	EA	FORM A 498 B			
			IN - Program Number & Function Code Assignment. INDIANA ONLY.			
0004164	25	EA	FORM A 503 F			
			INDIANA ONLY.			
0004184	25	EA	FORM A 639 ISS 09-81			
			IN - Taxable Prize Given to Employee Under \$100.00. INDIANA ONLY.			
0004185	100	EA	FORM A 642 A ISS 09-82			
			IN - Credit Card Guide Toll Tape Only. INDIANA ONLY.			
0004196	100	EA	FORM A 680 ISS 09-87			
			IN - IBT DOPAC Error Correction Worksheet. INDIANA ONLY.			
0006814	50	EA	FORM A 681 ISS 04-88			
			IN - Project Data Base Update Form. INDIANA ONLY.			
0004199	100	EA	FORM A 694			
			IN - Record Layout. INDIANA ONLY.			
0004202	100	EA	FORM A 704			
			IN - Job Order Master File Update. INDIANA ONLY.			
0006786	100	EA	FORM A 784 ISS 01-90			
			IN - Ameritech Employee Information System. INDIANA ONLY.			

PRODUCT IDENTIFIER		DESCRIPTION				
ITEM NUMBER	ORD. MULT.	SELL UNIT	STD. PKG. STOCK AVAILABILITY / PA	LEAD TIME	MIN. ORD.	A C
0004229	1000	EA	FORM A 793 F ISS 04-82			
			IN - Measured Service Supplemental Guide. INDIANA ONLY.			
0004238	50	EA	FORM A 819			
			IN - CW100 Edit Key punch Worksheet. INDIANA ONLY.			
0004240	100	EA	FORM A 823 1 ISS 03-85			
			IN - Craft Manual Controls. INDIANA ONLY.			
0004243	100	EA	FORM A 826 1			
			IN - Management Controls. INDIANA ONLY.			
0004278	25	EA	FORM A 960 ISS 06-84			
			IN - Wage Distribution Adjustments Only. INDIANA ONLY.			
0003751	200	EA	FORM A 996 ISS 12-89			
			IN - Name & Address Record for Miscellaneous Monthly DA. INDIANA ONLY.			
0004017	25	EA	FORM A 1047 ISS 12-87			
			IN - Distribution Code Request/IDP ChargeBack Authorization. INDIANA ONLY.			
0004019	50	EA	FORM A 1050 A ISS 01-86			
			IN - Transfers for the Allotment Control Book. INDIANA ONLY.			
0006866	100	EA	FORM A 1127 ISS 04-90			
			IN - Comptrollers Memo Order. INDIANA ONLY.			
0004037	25	EA	FORM A 1141 ISS 07-85			
			IN - Wage Loan Control Worksheet. INDIANA ONLY.			
0004040	25	EA	FORM A 1144 A ISS 06-85			
			IN - Savings & Credit Union Remittance Worksheet. INDIANA ONLY.			
0004043	25	EA	FORM A 1149 ISS 06-79			
			IN - Wage Loans Form 1794. INDIANA ONLY.			
0004054	25	EA	FORM A 1177 ISS 05-87			
			IN - Payroll Deduction Authorization. INDIANA ONLY.			
0004059	25	EA	FORM A 1194 ISS 06-80			
			IN - Pack Control DOPAC Key Entry Advice. INDIANA ONLY.			

DISTRIBUTION SERVICES

NETWORK SERVICES

TOOLS

BUILDING JANITORIAL

AUTOMOTIVE

FORMS/OFFICE SUPPLIES

GENERAL

DATA VOICE

DISTRIBUTION SERVICES

NETWORK SERVICES

TOOLS

BUILDING JANITORIAL

AUTOMOTIVE

FORMS/OFFICE SUPPLIES

GENERAL

DATA VOICE

FORM

PRODUCT IDENTIFIER		DESCRIPTION				
ITEM NUMBER	ORD. MULT.	SELL UNIT	STD. PKG. STOCK AVAILABILITY / PA	LEAD TIME	MIN. ORD.	A C
0003005	500	EA	FORM A 1210	ISS 11-87		
			IN - Data Base Add Record. INDIANA ONLY.			
0003011	100	EA	FORM A 1213	19		
			INDIANA ONLY.			
0003013	1500	EA	FORM A 1213	6	ISS 01-79	
			IN - IBT DOPAC Data Base Change Record. INDIANA ONLY.			
0003014	200	EA	FORM A 1213	7	ISS 01-79	
			IN - IBT DOPAC Data Base Change Record. INDIANA ONLY.			
0006874	100	EA	FORM A 1216	ISS 03-90		
			IN - Clear Exact Adjustments. INDIANA ONLY.			
0003019	500	EA	FORM A 1218	1	ISS 07-80	
			IN - IBT DOPAC Data Base Change Record. INDIANA ONLY.			
0003020	1000	EA	FORM A 1218	2	ISS 10-78	
			IN - Estimate Update Form for Segment FA 0505. INDIANA ONLY.			
0004291	25	EA	FORM AA 1	ISS 02-86		
			IN - Other Affirmative Action Activities. INDIANA ONLY.			
0004290	25	EA	FORM AA 1	ISS 02-86		
			IN - Affirmative Action Documentation. INDIANA ONLY.			
0004297	25	EA	FORM AD 162	ISS 05-88		
			IN - Supplemental - S112. INDIANA ONLY.			
0006816	25	EA	FORM AD 444	ISS 05-88		
			IN - Payroll Earnings Record Voucher Control and KeyPunch Worksheet. INDIANA ONLY.			
0004319	25	EA	FORM AD 604	ISS 06-85		
			IN - Allotment Reconciliation. INDIANA ONLY.			
0004322	25	EA	FORM AD 662	ISS 05-85		
			IN - Employee Wage Garnishment & Levy Notification. INDIANA ONLY.			
0004325	500	EA	FORM AD 666			
			IN - Log of Work Prints for Job Orders. INDIANA ONLY.			

PRODUCT IDENTIFIER		DESCRIPTION				
ITEM NUMBER	ORD. MULT.	SELL UNIT	STD. PKG. STOCK AVAILABILITY / PA	LEAD TIME	MIN. ORD.	A C
0005852	25	EA	FORM AM 42	ISS 11-86		
			IN - DMS 100/200 Network Switching Performance. INDIANA ONLY.			
0005854	25	EA	FORM AM 42	1	ISS 11-86	
			IN - DMS 200 Network Switch Performance Measuring Plan. INDIANA ONLY.			
0006903	50	EA	FORM AM 121	PC	ISS 12-90	
			IN - Employee Change Request. Pad of 50. INDIANA ONLY.			
0006943	100	EA	FORM AM 144	ISS 03-88		
			IN - Class III Updates. INDIANA ONLY.			
260376025			FORM AM 151	IL	ISS 03-90	
1959643	500	SH	IL	IN	MI	OH
			33	33	33	33
			IL - US Savings Bond Enrollment.			
0006930	100	EA	FORM AM 153	ISS 09-90		
			IN - Payroll Deduction Authorization Commercial Insurance. INDIANA ONLY.			
0006934	100	EA	FORM AM 159	ISS 07-90		
			IN - Payroll Deduction Authorization Federal Income Tax. INDIANA ONLY.			
0006935	100	EA	FORM AM 168	ISS 05-91		
			IN - Payroll Authorization State Income Tax. INDIANA ONLY.			
260417324			FORM AM 301	ISS 07-91	J5M	
N		BK	250	6	5000	
			ASI - Advancement Profile.			
260413463			FORM AM 306	ISS 02-91	S122M4C	
1971564		SE	IL	IN	MI	OH
			33	33	33	33
			PICS/DCPR Shipping Notice.			
260330550			FORM AM 306	ISS 07-88		
1946947	900	SE	IL	IN	MI	OH
			33	33	33	33
			PICS/DCPR Shipping Notice.			
260413471			FORM AM 307	ISS 02-91	S25M2C	
1971572		SE	IL	IN	MI	OH
			33	33	33	33
			Repair Service Order.			
260330568			FORM AM 307	ISS 07-88		
N		SE	700	8	25200	
			Repair Service Order.			
260353529			FORM AM 308	ISS 01-89		
1952630	4300	SH	IL	IN	MI	OH
			33	33	33	33

PRODUCT IDENTIFIER		DESCRIPTION					
ITEM NUMBER	ORD. MULT.	SELL UNIT	STD. PKG. STOCK AVAILABILITY / PA	LEAD TIME	MIN. ORD.	A C	
260353545	FORM AM	309	ISS 01-89				
1952622	1950	SE	IL IN MI OH WI 33 33 33				
260353560	FORM AM	310 M	ISS 01-89				
1952531	1600	SE	IL IN MI OH WI 33 33 33				
260353578	FORM AM	311	ISS 01-89				
1952556	1400	SE	IL IN MI OH WI 33				
260353586	FORM AM	312	ISS 01-89				
1952580	1100	SE	IL IN MI OH WI 33				
260363916	FORM AM	318	ISS 01-89				
1954339	500	SH	IL IN MI OH WI 33 33 33 33 33				
260375886	FORM AM	318 A	ISS 08-89				
N		SH	1000	4	1000		
260363908	FORM AM	319	ISS 01-89				
1954321	500	SH	IL IN MI OH WI 33 33 33 33 33				
260411467	FORM AM	325	ISS 02-89 L1MIL				
N		SH	1	2	2950		
			IL - MI - OH - Summary Page - box (bill form).				
260411475	FORM AM	325	ISS 02-89 L25MIL				
N		SH	1	2	44000		
			IL - MI - OH - Summary Page - roll (bill form).				
260411509	FORM AM	326	ISS 11-91 L1MIL				
N		SH	1	2	2950		
			MI - Detail Page - box.				
260411525	FORM AM	326	ISS 11-91 L20ML				
N		SH	1	2	44000		
			OH - Detail Page - roll.				
260411517	FORM AM	326	ISS 11-91 L25ML				
N		SH	1	2	44000		
			MI - Detail Page - box.				
260411491	FORM AM	326	ISS 11-91 L36ML				
N		SH	1	2	44000		
			IL - Detail Page - roll.				
260411483	FORM AM	326	ISS 11-91 L430M				
N		SH	1	2	2000		
			IL - Detail Page - box.				
260411533	FORM AM	326	ISS 11-91 L8MIL				
N		SH	1	2	44000		
			WI - Detail Page - roll.				
260411541	FORM AM	327	ISS 04-90 L1MIL				
N		SH	1	2	2950		
			MI & OH - Non-Crisis Summary Page, box.				
260411558	FORM AM	327	ISS 04-90 L1MIL5CM				
N		SH	1	2	44000		
			IL - Non-Crisis Summary Page, roll.				

PRODUCT IDENTIFIER		DESCRIPTION					
ITEM NUMBER	ORD. MULT.	SELL UNIT	STD. PKG. STOCK AVAILABILITY / PA	LEAD TIME	MIN. ORD.	A C	
260411566	FORM AM	327-1	ISS 06-90 L500M				
N		SH	1	2	2750		
			MI - The Scout Duplicate Bill, box.				
260411582	FORM AM	328	ISS 04-90 L1MIL500M				
N		SH	1	2	44000		
			IL - Non-Crisis Detail Page, roll.				
260411574	FORM AM	328	ISS 04-90 L4CM				
N		SH	2950	2	2950		
			MI & OH - Non-Crisis Detail Page, box.				
260411590	FORM AM	330	ISS 02-90 J2M24				
N		SH	100	8	2000		
			Manual Summary Bill.				
260411608	FORM AM	331	ISS 11-91 S5M24				
N		SH	100	4	5000		
			WI - Manual Detail Bill.				
260423777	FORM AM	336	ISS 01-90 L24				
N		EA	2000	6	2000		
			WI - Carrier Envelope - Milwaukee.				
260437868	FORM AM	336	ISS 03-92 L22				
N		EA	2000	6	2000		
			IN - Carrier envelope - Indianapolis.				
260423611	FORM AM	336	ISS 06-89 L20				
N		EA	2000	6	2000		
			IL - Carrier Envelope - Billing Naperville Live Accounts.				
260423652	FORM AM	336	ISS 12-89 L23				
N		EA	2000	6	2000		
			OH - Carrier Envelope - Cleveland.				
260423785	FORM AM	336 1	ISS 01-90 L24				
N		EA	2000	6	2000		
			WI - Carrier Envelope - Milwaukee (Poly Klear).				
260363643	FORM AM	336 1	ISS 01-92 L23				
N		EA	2000	6	2000		
			OH - Envelope Carrier - University Bills.				
260423561	FORM AM	336 1	ISS 07-90 L20				
N		EA	2000	6	2000		
			IL - Carrier Envelope - Billing - Oak Park Final Accounts.				
260423769	FORM AM	336 1	ISS 11-90 L21				
N		EA	2000	6	2000		
			MI - Carrier Envelope - Saginaw.				
260438601	FORM AM	336 2	ISS 01-91 L24				
N		EA	2000	6	2000		
			WI - Envelope Carrier - Student Toll.				
260423710	FORM AM	336 4	ISS 02-91 L8M21				
N		EA	2000	6	2000		
			MI - Carrier Envelope - Saginaw (Poly Klear).				
260437884	FORM AM	338	ISS 03-92 L4M22				
N		EA	500	6	500		
			IN - Envelope - Large Carrier Bill, 1 1/2IN expansion.				

DISTRIBUTION SERVICES
 NETWORK SERVICES
 TOOLS
 BUILDING JANITORIAL
 AUTOMOTIVE
 FORMS/OFFICE SUPPLIES
 GENERAL
 DATA VOICE

DISTRIBUTION SERVICES

NETWORK SERVICES

TOOLS

BUILDING JANITORIAL

AUTOMOTIVE

FORMS/OFFICE SUPPLIES

GENERAL

DATA VOICE

FORM

PRODUCT IDENTIFIER		DESCRIPTION				
ITEM NUMBER	ORD. MULT.	SELL UNIT	STD. PKG. STOCK AVAILABILITY / PA	LEAD TIME	MIN. ORD.	A C
260423579		FORM AM	338	ISS 06-90 L20M		
N		EA	500	6	500	
IL - Envelope - Large Carrier Bill, 1 1/2IN Expansion.						
260423678		FORM AM	338	ISS 12-89 L23		
N		EA	500	6	500	
OH - Envelope - Large Carrier Bill, 1 1/2IN Expansion.						
260423686		FORM AM	338 1	ISS 07-91 L21		
N		EA	500	6	500	
MI - Envelope - Large Carrier Bill, 1 1/2IN Expansion.						
260423587		FORM AM	339	ISS 06-90 L20		
N		EA	500	6	500	
IL - Envelope - Large Carrier Bill, 3/4IN Expansion.						
260423694		FORM AM	339	ISS 07-91 L21		
N		EA	500	6	500	
MI - Envelope - Large Carrier Bill, 3/4IN Expansion.						
260423629		FORM AM	339	ISS 12-89 L23		
N		EA	500	6	500	
OH - Large Carrier Bill - 3/4IN Expansion.						
		FORM AM	341			
0006865	100	EA				
IN - Traffic Study Request. INDIANA ONLY.						
260360466		FORM AM	352	ISS 07-89		
1953661	100	EA	IL IN MI OH WI 33 33 33 33 33			
260426275		FORM AM	375	ISS 07-90 L20		
N		EA	500	6	500	
IL - Envelope - Billing - Naperville Manual Bills - Uncut.						
260426812		FORM AM	376	ISS 07-90 L20		
N		EA	500	6	5000	
IL - Return Billing Envelope - No Return Address - Manual Bills - Uncut, ochre stripe.						
260423744		FORM AM	377	ISS 05-90 L24		
N		EA	800	6	800	
WI - Envelope - Large Carrier, Non-Expansion.						
260423496		FORM AM	377	ISS 06-90 L20		
N		EA	800	6	800	
IL - Envelope - Large Carrier Bill - Non-Expansion.						
260439427		FORM AM	377	ISS 06-90 L83M		
N		EA	800	6	800	
IN - Envelope - Large Carrier Bill - non-expansion.						
260423702		FORM AM	377	ISS 11-90 L21		
N		EA	800	6	800	
MI - Envelope - Large Carrier Bill, Non-Expansion.						

PRODUCT IDENTIFIER		DESCRIPTION				
ITEM NUMBER	ORD. MULT.	SELL UNIT	STD. PKG. STOCK AVAILABILITY / PA	LEAD TIME	MIN. ORD.	A C
260407796		FORM AM	382	ISS 01-91 S12M RGN		
1970970		PD	IL IN MI OH WI 33 33 33 33 33			
RGN - Outside Plant Trouble Investigation Request.						
260407788		FORM AM	383	ISS 01-91 S3M		
1970962	12000	PD	IL IN MI OH WI 33 33 33 33 33			
RGN - Unsatisfactory/Hazardous Plant Condition Report.						
260396593		FORM AM	406	ISS 10-90 S20M20		
1967737	20000	SH	IL IN MI OH WI 33			
IL - Address Form for returned mail.						
260398888		FORM AM	427	ISS 10-90		
N		SE	3	8	1000	
260431598		FORM AM	475	ISS 07-91 S20R020		
1979237	1	RO	IL IN MI OH WI 33			
IL - Retired Plug-in Units. Illinois label.						
260431580		FORM AM	475	ISS 07-91 S20R021		
1979229	1	RO	IL IN MI OH WI			
MI - Retired Plug-in Units. Michigan label.						
260431572		FORM AM	475	ISS 07-91 S20R022		
1979211	1	RO	IL IN MI OH WI 33			
IN - Retired Plug-in Units. Indiana label.						
260431556		FORM AM	475	ISS 07-91 S20R023		
1979195	1	RO	IL IN MI OH WI 33			
OH - Label - Retired Plug-In Units.						
260431564		FORM AM	475	ISS 07-91 S20R024		
1979203	1	RO	IL IN MI OH WI			
WI - Retired Plug-in Units - Wisconsin label.						
260417894		FORM AM	476	ISS 04-91 S6C50		
1972802	25	SH	IL IN MI OH WI 33 33 33 33 33			
Air Core PIC Cable Reclamation Worksheet.						
260417902		FORM AM	477	ISS 04-91 S6C50		
1972810	25	SH	IL IN MI OH WI 33 33 33 33 33			
Air Core PIC Cable Reclamation Documentation.						
260417910		FORM AM	478	ISS 04-91 S6C50		
1972828	25	SH	IL IN MI OH WI 33 33 33 33 33			
Loop Electronics Verification Report of MLT & Alarms Acceptance.						
260417928		FORM AM	479	ISS 04-91 S6C50		
1972836	25	SH	IL IN MI OH WI 33 33 33 33 33			
Defective Pair Priority Testing/Recovery Request.						

PRODUCT IDENTIFIER		DESCRIPTION							
ITEM NUMBER	ORD. MULT.	SELL UNIT	STD. PKG.	LEAD TIME			MIN. ORD.	A C	
			STOCK AVAILABILITY / PA						
260417936 FORM AM 480 ISS 04-91 S6C50									
1972844	25	SH	IL 33	IN 33	MI 33	OH 33	WI 33		
Defective Pair Recovery Administration Plan Follow-up Report.									
260417944 FORM AM 481 ISS 04-91 S6C50									
1972851	25	SH	IL 33	IN 33	MI 33	OH 33	WI 33		
Purged Cable Log.									
260419668 FORM AM 494 ISS 04-91 S700									
1974527	25	SH	IL 33	IN 33	MI 33	OH 33	WI 33		
Subscriber Carrier Line Data Record.									
260419650 FORM AM 495 ISS 04-91 S700									
1974519	25	SH	IL 33	IN 33	MI 33	OH 33	WI 33		
ASI - Initial Fault Line Tests.									
260432901 FORM AM 498 ISS 04-91 J5C									
N		SH	1		4			25	
ALL - Lock label.									
260375910 FORM AM 500 ISS 01-90 S28M									
N		SE	150		6			28050	
ALL - Ameritech Operating Co (AOC) Interexchange Carrier (IC) Memorandum.									
260445366 FORM AM 532 1 ISS 04-92 S20MRGN									
N		EA	50		6			2000	
RGN - Requisition.									
300059490 FORM AM 537 S1M20									
1330373	1	EA	IL 33	IN 33	MI 33	OH 33	WI 33		
Label with outline of five states comprising Ameritech. NO JOB IS SO IMPORTANT AND NO SERVICE IS SO URGENT THAT WE CANNOT TAKE TIME TO PERFORM OUR WORK SAFELY. 2 5/8 X 4 1/2IN.									
260437785 FORM AM 647 ISS 02-92 S17C ALL									
N		SE	50		8			1700	
ALL - Authority Request.									
260436035 FORM AM 654 ISS 11-91 J1M									
N		SE	500		8			1000	
ALL - Application For An Unpaid Departmental Leave of Absence.									
260436746 FORM AM 655 ISS 11-91 J1M									
N		SE	500		8			1000	
ALL - Application For Anticipated Disability Leave of Absence.									
260436738 FORM AM 656 ISS 11-91 J1M									
N		SE	500		8			1000	
ALL - Application For Extension of Leave of Absence.									
260436027 FORM AM 657 ISS 11-91 J1M									
N		SE	500		8			1000	
ALL - Termination of Absence.									

PRODUCT IDENTIFIER		DESCRIPTION							
ITEM NUMBER	ORD. MULT.	SELL UNIT	STD. PKG.	LEAD TIME			MIN. ORD.	A C	
			STOCK AVAILABILITY / PA						
260438643 FORM AM 664 ISS 11-91 J5M									
N		SE	500		8			5000	
ALL - Request For Professional Services.									
260423736 FORM AM 680 ISS 01-91 L21									
N		EA	3000		6			3000	
MI - Return Envelope - no address, ochre stripe.									
260423538 FORM AM 680 ISS 01-92 L20									
N		EA	3000		6			3000	
IL - Return Envelope - No Return Address, ochre stripe.									
260423637 FORM AM 680 ISS 01-92 L23M									
N		EA	3000		6			3000	
OH - Return Envelope - no address Brecksville - ochre stripe.									
260437827 FORM AM 680 ISS 03-92 L22									
N		EA	3000		6			3000	
IN - Return envelope.									
260423595 FORM AM 680 1 ISS 01-92 L23M									
N		EA	3000		6			3000	
OH - Return Envelope - No Adress Akron - ochre stripe.									
260423546 FORM AM 681 ISS 01-92 L20M									
N		EA	3000		6			3000	
IL - Return Envelope - Decatur, blue stripe.									
260423728 FORM AM 681 ISS 01-92 L21									
N		EA	3000		6			3000	
MI - Return Envelope - no address, blue stripe.									
260423660 FORM AM 681 ISS 01-92 L23M									
N		EA	3000		6			3000	
OH - Return Envelope - no address Brecksville - blue stripe.									
260437835 FORM AM 681 ISS 03-92 L22									
N		EA	3000		6			3000	
IN - Return envelope.									
260423793 FORM AM 681 ISS 12-92 L24M									
N		EA	3000		6			3000	
WI - Return Envelope - no address, blue stripe.									
260423645 FORM AM 681 1 ISS 01-92 L23M									
N		EA	3000		6			3000	
OH - Return Envelope - no address Akron - blue stripe.									
260423553 FORM AM 682 ISS 01-92 L20M									
N		EA	3000		6			3000	
IL - Return Envelope - Bedford Park, black stripe.									
260423603 FORM AM 682 ISS 01-92 L23M									
N		EA	3000		6			3000	
OH - Return Envelope - No Adress Akron - black stripe.									
260423751 FORM AM 682 ISS 01-92 L24M									
N		EA	3000		6			3000	
WI - Return Envelope - no address, black stripe.									

DISTRIBUTION SERVICES
 NETWORK SERVICES
 TOOLS
 BUILDING JANITORIAL
 AUTOMOTIVE
 FORMS/OFFICE SUPPLIES
 GENERAL
 DATA VOICE

DISTRIBUTION SERVICES

NETWORK SERVICES

TOOLS

BUILDING JANITORIAL

AUTOMOTIVE

FORMS/OFFICE SUPPLIES

GENERAL

DATA VOICE

FORM

PRODUCT IDENTIFIER		DESCRIPTION				
ITEM NUMBER	ORD. MULT.	SELL UNIT	STD. PKG. STOCK AVAILABILITY / PA	LEAD TIME	MIN. ORD.	A C
260437843	FORM AM	682	ISS 03-92 L22			
N		EA	3000	6	3000	
		IN - Return envelope.				
260437850	FORM AM	683				
N		EA	3000	6	3000	
		OH - ENVELOPE - Return Pre-addressed Cleveland, blue stripe.				
260437850	FORM AM	683	ISS 01-92 L30M23			
N		OH -				
200004836	FORM AM	684	ISS 05-87 L20			
N		EA	500	6	500	
		IL - Envelope Carrier- CABS Marquette.				
200004844	FORM AM	685	ISS 08-87 L20			
N		EA	2500	6	2500	
		IL - Return Envelope - CABS Billing.				
260403738	FORM AM	686	ISS 10-90 L8M20			
N		CE	2000	6	2000	
		IL - Envelope Carrier - UPS Bill Mailing - Naperville.				
260406764	FORM AM	1001	ISS 09-91 L5M			
N		SE	50	2	3500	
		ASI - Request for Documents.				
260413547	FORM AM	1004	ISS 11-85 J3M			
N		SE	150	8	3000	
		FORM AM 1024 B ISS 09-87				
0003525	1	EA				
		IN - Loan Authorization Form. INDIANA ONLY.				
		FORM AM 1567 ISS 11-86				
0006429	1	EA				
		IN - Network Switch Performance Measure Plan Record. INDIANA ONLY.				
		FORM AM 1903 ISS 11-86				
0006670	25	EA				
		IN - 5-ESS Network Switch Performance Measurement. INDIANA ONLY.				
260437777	FORM AM	532	ISS 04-92 S10M REGIONAL			
N		SE	50	8	9666	
		RGN - Requisition.				
		FORM AM 6420 A ISS 11-86				
0004633	25	EA				
		IN - NO. 5XB Network Switch Performance Measure Plan. INDIANA ONLY.				
		FORM AM 6421 A ISS 11-86				
0006363	25	EA				
		IN - 1/1 A ESS Network Switching Performance Measurement. INDIANA ONLY.				
		FORM AM 6422 A ISS 11-86				
0006011	25	EA				
		IN - 3 ESS Network Switching Performance Measure Plan. INDIANA ONLY.				

PRODUCT IDENTIFIER		DESCRIPTION				
ITEM NUMBER	ORD. MULT.	SELL UNIT	STD. PKG. STOCK AVAILABILITY / PA	LEAD TIME	MIN. ORD.	A C
		FORM AM 6424 A ISS 11-86				
0006066	25	EA				
		IN - SXS Network Switch Performance Measure Plan. INDIANA ONLY.				
		FORM AM 6426 A ISS 11-86				
0006156	25	EA				
		IN - 2-2B ESS Network Switching Performance Measure Plan. INDIANA ONLY.				
		FORM AM 6429 ISS 11-86				
0006322	25	EA				
		IN - Network Switching Performance Measure Plan. INDIANA ONLY.				
		FORM AM 6548 ISS 11-86				
0006353	25	EA				
		IN - Network Switch Performance Measurement Plan. INDIANA ONLY.				
260360458	FORM AMBS	18	ISS 06-89			
1953893	500	EA	IL 33	IN 33	MI 33	OH 33
		ALL - Envelope, intra-company.				
300083490	FORM AME	1162	ISS 09-85			
1195479	1	EA	IL 33	IN 33	MI 33	OH 33
		Tag - Plain white cloth tag used in tagging binding post when a breakdown test is applied to the pair associated the binding post. 1 3/8in X 2 13/16in, BSP 634-305-501.				
300081460	FORM AME	1193	ISS 09-85			
1333864	25	EA	IL 33	IN 33	MI 33	OH 33
300067576	FORM AME	3013 B				S100M
1332288	100	EA	IL 18	IN 18	MI 18	OH 18
		Tag - Station ground.				
300081486	FORM AME	4476	ISS 09-85			
1333807	250	EA	IL 33	IN 33	MI 33	OH 33
300083482	FORM AME	4881	ISS 09-85			
1334029	59	EA	IL 33	IN 33	MI 33	OH 33
		Index tab protectors for cable record forms, large.				
300083474	FORM AME	4914	ISS 09-85 S19M			
1334037	1	BK	IL 33	IN 33	MI 33	OH 33
		Label - Sorry, Temporarily Out of Service. For coin telephones, box of 25.				
300081494	FORM AME	5214 2	ISS 09-85			
1333856	500	SH	IL 33	IN 33	MI 33	OH 33
		Central Office Changes Work Item Tally Sheet.				
300081510	FORM AME	5837	ISS 09-85			
1333914	100	SH	IL 33	IN 33	MI 33	OH 33
		Key Designating Tabs.				

DISTRIBUTION SERVICES

NETWORK SERVICES

TOOLS

BUILDING JANITORIAL

AUTOMOTIVE

FORMS/OFFICE SUPPLIES

GENERAL

DATA VOICE

PRODUCT IDENTIFIER		DESCRIPTION					
ITEM	ORD.	SELL	STD. PKG.	LEAD TIME		MIN.	A
NUMBER	MULT.	UNIT	STOCK AVAILABILITY / PA		ORD.	C	
300081528	FORM AME 5840	ISS 09-85					
1333963	500	SH	IL	IN	MI	OH	WI
			33		33		
Equipment Trouble Ticket.							
300083433	FORM AME 5962	ISS 09-85					
5125914	100	EA	IL	IN	MI	OH	WI
			33				
Label - Bell System Fire Extinguishers, all types.							
300081551	FORM AME 6476	ISS 09-85					
1333823	250	EA	IL	IN	MI	OH	WI
			33				
Tag - Defective Material.							
300083458	FORM AME10118	ISS 09-85					
4213009	50	EA	IL	IN	MI	OH	WI
			33				
Tag - Special Attention.							
300083466	FORM AMGN 801	ISS 09-85					
1185702	100	EA	IL	IN	MI	OH	WI
			33	33			
Tag - Special Attention.							
300081569	FORM AMSN 384	ISS 09-85					
1333880	50	SH	IL	IN	MI	OH	WI
			33		33		
Columnar Worksheet, 32 Columns.							
300081577	FORM AMSN 385	ISS 09-85					
1333971	50	SH	IL	IN	MI	OH	WI
			33		33		33
Columnar Worksheet, 32 Columns, 17in X 11in.							

PRODUCT IDENTIFIER		DESCRIPTION					
ITEM	ORD.	SELL	STD. PKG.	LEAD TIME		MIN.	A
NUMBER	MULT.	UNIT	STOCK AVAILABILITY / PA		ORD.	C	
260384938	FORM AS 342	ISS 03-89	S10M20				
1962746		SH	IL	IN	MI	OH	WI
Non-Stock Receiving Label.							
260354964	FORM AS 350						
1952499	1	BK	IL	IN	MI	OH	WI
260439161	FORM AS 369	ISS 01-92	J5M				
N		EA	500		6		5000
ASI - Envelope 9 X 12IN.							
260439179	FORM AS 370	ISS 01-92	J5M				
N		EA	500		6		5000
ASI - Envelope 9 X 12IN.							
260405253	FORM AS 384 A	ISS 11-90	J5M74				
N		EA	5000		6		5000
260405261	FORM AS 384 B	ISS 11-90	J3M74				
N		EA	3000		6		3000
260403258	FORM AS 385	ISS 12-91	J3M				
N		SE	50		8		3000
ASI - Journal Shipping Ticket.							
260438619	FORM AS 386	ISS 09-90	J5M				
N		PD	500		4		5000
ASI - Integrated Fundamental Network Planning.							
260404736	FORM AS 393 1	ISS 12-90	J1M74				
N		EA	1000		6		1000
260404744	FORM AS 393 2	ISS 12-90	J1M74				
N		EA	1000		6		1000
260413562	FORM AS 395	ISS 02-91	J256M				
N		SH	1000		6		256000
260421250	FORM AS 408	ISS 05-91	J5M				
N		SH	50		4		5000
ASI - Corporate Security & Risk Mgmt Contract Memo.							
260421201	FORM AS 409	ISS 05-91	J1M250				
N		SH	50		4		1250
Investigative Cost Detail Log.							
260421219	FORM AS 410	ISS 05-91	J1M				
N		SH	50		4		1000
ASI - Investigative Report.							
260421227	FORM AS 411	ISS 05-91	J1M250				
N		SH	50		4		1250
ASI - Activity Log							
260421235	FORM AS 412	ISS 05-91	J7C50				
N		SH	50		4		750
ASI - Property & Evidence Report.							
260421243	FORM AS 413	ISS 05-91	J1M2C50				
N		SH	50		4		1250
ASI - Statement.							

DISTRIBUTION SERVICES

NETWORK SERVICES

TOOLS

BUILDING JANITORIAL

AUTOMOTIVE

FORMS/OFFICE SUPPLIES

GENERAL

DATA VOICE

FORM

PRODUCT IDENTIFIER		DESCRIPTION				
ITEM	ORD.	SELL	STD. PKG.	LEAD TIME	MIN.	A
NUMBER	MULT.	UNIT	STOCK AVAILABILITY / PA		ORD.	C
260429923	FORM AS	420	ISS 08-91	J1M ASI		
N	SE	100	8	1000		
ASI - Distribution Requisition - Bulk Distribution.						
260441084	FORM AS	426	ISS 09-91	J1M ASI		
N	EA	500	6	1000		
ASI - Treasury Envelope, 9-1/2 X 4-1/2IN.						
260431531	FORM AS	428	ISS 10-91	J1M		
N	SH	100	4	1000		
ASI - Pads - Library and Information Network.						
260431762	FORM AS	431	ISS 09-91	J2M		
N	EA	500	6	2000		
ASI - Treasury Envelope.						
260431770	FORM AS	432	ISS 09-91	J4M		
N	EA	500	6	4000		
ASI - Treasury Envelope.						
260435540	FORM AS	439	ISS 11-91	J3C		
N	SH	100	8	300		
ASI - Wellness Center Transmittal.						
260435532	FORM AS	440	ISS 10-91	J5M		
N	SH	500	4	5000		
ASI - Payroll Report 8 1/2 X 11IN						
260435524	FORM AS	440-1	ISS 10-91	J5C		
N	SH	500	4	500		
ASI - Payroll Report 5 1/2 X 8 1/2IN.						
260438627	FORM AS	441	ISS 11-91	J3M		
N	SH	100	4	3000		
260439039	FORM AS	444	ISS 01-92	J10M		
N	EA	250	8	10000		
AS1 - Label - Data Processing Tapes.						
260441118	FORM AS	446	ISS 02-92	J1M ASI		
N	EA	250	4	1000		
ASI - Authorization for Payroll Deduction.						
260447230	FORM AS	456	ISS 05-92	J5M		
N						
ASI - Corporate Publishing Work Request.						
280023383	FORM ASD	35	ISS 05-86	S25MRGN		
1921916	1	PD	IL IN MI OH WI			
			33 33 33 33			
RGN - Call Memo Pad.						
300022993	FORM ASI	626 B	ISS 02-84			
5104661	1	SE	IL IN MI OH WI			
			33			
Stock Shipment Multiple Adjustment.						
260300033	FORM ASI	4113 1	ISS 01-84			
1937839	50	SE	IL IN MI OH WI			
			33			
ASI - Transportation Order.						
260384946	FORM ASI	4114 1	ISS 02-88	S10M20		
1962753		SE	IL IN MI OH WI			
Non-Stock Shipment Form.						

PRODUCT IDENTIFIER		DESCRIPTION				
ITEM	ORD.	SELL	STD. PKG.	LEAD TIME	MIN.	A
NUMBER	MULT.	UNIT	STOCK AVAILABILITY / PA		ORD.	C
			FORM ASIEC 01	ISS 10-84		
0007568	100	EA				
IN - Engineering Complaint. INDIANA ONLY.						
			FORM ASR 2	ISS 10-84		
0006904	50	EA				
IN - AOC/IEC Memorandum Error Notification. INDIANA ONLY.						
			FORM B 262	ISS 03-92		
0006812	25	EA				
IN - Valid Classes of Service - USOC. INDIANA ONLY.						
			FORM BD 27	ISS 09-80		
0004383	25	EA				
IN - Notice of Change in Address. INDIANA ONLY.						
			FORM BS 367			
0007655	50	EA				
IN - BOFADS Worksheet. INDIANA ONLY.						
			FORM BS 368	ISS 09-85		
0003039	500	EA				
IN - Status of Work Report. INDIANA ONLY.						
			FORM BS 369	ISS 09-85		
0004400	25	EA				
IN - Daily Question Log. INDIANA ONLY.						
			FORM BS 496	ISS 09-85		
0004402	500	EA				
IN - SR Development Summary. INDIANA ONLY.						
			FORM BS 498	ISS 05-84		
0004404	5	EA				
IN - AM Weekly Schedule. INDIANA ONLY.						
			FORM BS 501 A	ISS 06-87		
0006756	1	EA				
IN - SR 12 Month Performance Summary - CSSC. INDIANA ONLY.						
			FORM BS 502	ISS 09-85		
0004405	25	EA				
IN - Monthly Quality Performance Worksheet. INDIANA ONLY.						
			FORM BS 504	ISS 09-85		
0004407	200	EA				
IN - Clerical Collection Review. INDIANA ONLY.						
			FORM BS 531	ISS 09-85		
0003040	200	EA				
IN - Intraday Adjustments. INDIANA ONLY.						
260390703	FORM BS	651 LB	ISS 09-90	S5M20		
1965228	25	SE	IL IN MI OH WI			
			33			
IL - Real Estate Operations Work Request/Requisition.						
			FORM BS 734	ISS 09-85		
0004411	25	EA				
IN - Solution Implementation Plan.0 INDIANA ONLY.						

DISTRIBUTION SERVICES
 NETWORK SERVICES
 TOOLS
 BUILDING JANITORIAL
 AUTOMOTIVE
 FORMS/OFFICE SUPPLIES
 GENERAL
 DATA VOICE

PRODUCT IDENTIFIER		DESCRIPTION				
ITEM NUMBER	ORD. MULT.	SELL UNIT	STD. PKG. STOCK AVAILABILITY / PA	LEAD TIME	MIN. ORD.	A C
0004412	25	EA	FORM BS 830	ISS 09-85		
IN - Data Display Card. INDIANA ONLY.						
0003041	500	EA	FORM BS 983 M	ISS 03-84		
IN - Certification of Right to a Deferred Vested Pension. INDIANA ONLY.						
0003042	500	EA	FORM BS 983 NM	ISS 03-84		
IN - Certification of Right to a Deferred Vested Pension. INDIANA ONLY.						
0004414	25	EA	FORM BS 984 M	ISS 03-84		
IN - Acknowledgement of Receipt. INDIANA ONLY.						
0004420	50	EA	FORM BS 987 M	ISS 03-84		
IN - Election/Decline Joint & Survivor Annuity Deferred Vested Pension. INDIANA ONLY.						
0004421	50	EA	FORM BS 987 NM			
IN - Election/Decline Joint & Survivor Annuity Deferred Vested Pension 0. INDIANA ONLY.						
0004428	50	EA	FORM BS 991 M	ISS 03-84		
IN - Statement of Accrued Pension Benefits. INDIANA ONLY.						
0004429	25	EA	FORM BS 991 NM	ISS 03-84		
IN - Statement of Accrued Pension Benefits. INDIANA ONLY.						
300030368 FORM BS 1115 LB ISS 09-84 S20M20						
5107151	500	SH	IL IN MI OH WI	33		
IL - Customer Satisfaction Evaluation.						
300062320 FORM CE 4378 RSF						
1330977	50	SE	IL IN MI OH WI	33 33		
ASI - Authorization for Stationary Form.						
001021799 FORM CH 4582 A ISS 11-79 S5M20						
5629865	200	SE	IL IN MI OH WI	33		
IL - Directory Advertising Claim & Accuracy Report.						
0007669	1	EA	FORM CL 3538			
IN - Attending Dentists Statement - Connecticut General. INDIANA ONLY.						
260412150 FORM CO 233 ISS 02-81 S3M21						
1971549	100	EA	IL IN MI OH WI	33		
Manila envelope (company).						
200005866			FORM CO 237	ISS 07-88		
N		PD	100	6	3000	

PRODUCT IDENTIFIER		DESCRIPTION				
ITEM NUMBER	ORD. MULT.	SELL UNIT	STD. PKG. STOCK AVAILABILITY / PA	LEAD TIME	MIN. ORD.	A C
200005874			FORM CO 237 A	ISS 07-88		
N		PD	100	6	3000	
200005882			FORM CO 238	ISS 07-88		
N		EA	500	6	250	
200005890			FORM CO 239	ISS 10-91		
N		PD	1	6	1000	
001164458			FORM CRIS0002	ISS 01-88 L20M20		
N		SH	500	2	500	
IL - Controlling Memorandum - Transfer, 8 1/2 X 5 1/2 IN Economy Bond, 16 # canary.						
001164706			FORM CRIS0005	ISS 01-92 L15M20		
N		SH	500	2	500	
IL - Controlling Memorandum - Adjustments.						
003006095			FORM CRIS0006	ISS 03-90 L9M20		
N		SH	500	2	500	
IL - Controlling Memorandum - Transfer Installment Billing.						
0006965	100	EA	FORM DI 514 A	ISS 05-91		
IN - Request for Combined ACN as on OC&C Adjustment Summary Report. INDIANA ONLY.						
0006976	50	PD	FORM DI 782 B	ISS 01-91		
IN - NPA/NXX Report Request (ACNA-Level). INDIANA ONLY.						
0006969	100	EA	FORM DI 782 D	ISS 05-91		
IN - Request for OC&C Adjustment Summary Report. INDIANA ONLY.						
260436035			FORM DL 3410	ISS 11-91 J1M		
N		SE	500	8	1000	
ASI - Application for an Unpaid Departmental Leave of Absence.						
0006790	100	EA	FORM DP 1300 FA-1			
IN - Corporate Accounting Journal Entry. INDIANA ONLY.						
0006789	100	EA	FORM DP 1300 FA-2			
IN - Corporate Accounting Journal Entry. INDIANA ONLY.						
0004513	100	EA	FORM E 447 1A	ISS 02-84		
IN - Upkeep Work Units Special Service Circuit Testing. INDIANA ONLY.						
0003048	500	EA	FORM E 1017	ISS 05-84		
IN - Gas Pressure Testing - Graph of Press Readings. INDIANA ONLY.						

FORM

DISTRIBUTION SERVICES

PRODUCT IDENTIFIER		DESCRIPTION					
ITEM NUMBER	ORD. MULT.	SELL UNIT	STD. PKG. STOCK AVAILABILITY / PA	LEAD TIME	MIN. ORD.	A	C
002090553 FORM E		1162 LB ISS 07-83 S60M20					
5656421	500	EA	IL IN MI OH WI				
			33				
IL - Tag, orange, for Network Wire/Interface labeling.							
300094232 FORM E		2306 ISS 07-85					
1934729	50	SH	IL IN MI OH WI				
			33				
IN - Record of Central Office Equipment Assigned Circuit.							
FORM E 2514		ISS 02-84					
0004500	25	EA					
IN - Day Off Assignment Plan. INDIANA ONLY.							
280079351 FORM E		2920ALB ISS 06-87					
1935932	500	SH	IL IN MI OH WI				
			33				
IL - Daily Time Report For Non-Management.							
FORM E 2924							
0002045	50	SH					
INDIANA ONLY.							
FORM E 4009A71R		ISS 6-78					
0003053	250	EA					
IN - Cable Record. INDIANA ONLY.							
FORM E 4227 G		ISS 05-87					
0003264	1	EA					
IN - Designation Card. INDIANA ONLY.							
FORM E 4419 1		ISS 01-84					
0004510	25	EA					
IN - Central Office Rearrangements/Changes. INDIANA ONLY.							
FORM E 4420		ISS 11-84					
0004511	50	EA					
IN - Central Office Rearrangements/Changes. INDIANA ONLY.							
FORM E 4420 1		ISS 01-84					
0004512	25	EA					
IN - Central Office Rearrangements Changes. INDIANA ONLY.							
FORM E 4475		ISS 09-58					
0004514	25	EA					
IN - Private Service History Card. INDIANA ONLY.							
FORM E 4476		ISS 01-86					
0003054	200	EA					
IN - Private Service History Card. INDIANA ONLY.							
FORM E 4646		ISS 05-87					
0003266	25	EA					
IN - Key Designation Strip. INDIANA ONLY.							
FORM E 4744							
0003055	1	EA					
IN - Register Readings. INDIANA ONLY.							

NETWORK SERVICES

TOOLS

BUILDING JANITORIAL

AUTOMOTIVE

FORMS/OFFICE SUPPLIES

GENERAL

DATA VOICE

PRODUCT IDENTIFIER		DESCRIPTION					
ITEM NUMBER	ORD. MULT.	SELL UNIT	STD. PKG. STOCK AVAILABILITY / PA	LEAD TIME	MIN. ORD.	A	C
400145025 FORM E		4911 ISS 04-65					
1446260	100	EA	IL IN MI OH WI				
			33 33 33 33 33				
ALL - Cable and Wire Color Code Wheel.							
FORM E 4941		ISS 12-65					
0004367	1	EA					
IN - T Carrier-Span Line Record. INDIANA ONLY.							
455017913 FORM E		5132 R					
1175463	50	EA	IL IN MI OH WI				
			33 33 33				
Patch Tag - Red.							
FORM E 5132 R		ISS 01-84					
0004517	50	EA					
IN - Patch Tag - Red. INDIANA ONLY.							
FORM E 5132 W		ISS 01-84					
0004515	25	EA					
IN - Patch Tag - White. INDIANA ONLY.							
455017921 FORM E		5132 W ISS 04-82					
1145938	50	EA	IL IN MI OH WI				
			33				
Label - Patch cord.							
455017939 FORM E		5132 Y					
1176164	50	EA	IL IN MI OH WI				
			33				
FORM E 5132 Y		ISS 01-84					
0004516	25	EA					
IN - Patch Tag - Yellow. INDIANA ONLY.							
FORM E 5175		ISS 06-78					
0004518	25	EA					
IN - Point-To-Point Microwave Radio Technical Log. INDIANA ONLY.							
FORM E 5200							
0003056	500	EA					
IN - Basics of Basic Electricity. INDIANA ONLY.							
FORM E 5214 1							
0007691	50	EA					
IN - Central Office Changes Work Item Tally Sheet - Trunks. INDIANA ONLY.							
260436969 FORM E		5214 1 ISS 11-85 J1M22					
N		SH	50	4	1000		
IN - Central Office Changes Work Item Tally Sheet - Trunks							
FORM E 5214 3							
0006155	1	EA					
INDIANA ONLY.							
FORM E 5231		ISS 07-77					
0004521	100	EA					
IN - ESS Trouble Ticket. INDIANA ONLY.							
260379417 FORM E		5233 ISS 01-81 A15M23					
N		SE	1400	2	1400		
OH - AMA Magnetic Tap Trasnmittal.							

PRODUCT IDENTIFIER DESCRIPTION

ITEM	ORD.	SELL	STD. PKG.	LEAD TIME	MIN.	A
NUMBER	MULT.	UNIT	STOCK AVAILABILITY / PA		ORD.	C

260360474 FORM E 5233 ISS 05-89
 1953679 25 SE IL IN MI OH WI
 33
 IN - AMA/SEBX Tape Transmittal.

FORM E 5246 ISS 08-68
 0003058 1000 EA
 IN - Terminal Label. INDIANA ONLY.

FORM E 5409
 0007571 1 EA
 IN - Work Notes. INDIANA ONLY.

FORM E 5419 ISS 03-84
 0003059 100 EA
 IN - Air Pressure Analysis Program. INDIANA ONLY.

FORM E 5453 ISS 06-67
 0005554 25 EA
 IN - Test & Inspection Summary. INDIANA ONLY.

400425054 FORM E 5486 RGN
 1177162 1 BX IL IN MI OH WI
 33 33
 RGN - No. 5XB System Trouble Recorder Card. Box of 3200.

FORM E 5499 ISS 07-69
 0006741 25 EA
 INDIANA ONLY.

FORM E 5910
 0004527 25 EA
 IN - Trunk Transmission Maintenance Index. INDIANA ONLY.

FORM E 5962 ISS 11-70
 0003060 3000 EA
 IN - Fire Extinguisher Label. INDIANA ONLY.

401697214 FORM E 5991
 5647925 2000 EA IL IN MI OH WI
 33 33 33 33
 ASI - Collection Route Sheet.

300073202 FORM E 5995 LB ISS 06-81 L18M20
 N SH 3600 2 3600
 IL - Route Engineering Card.

FORM E 6006 ISS 12-87
 0006824 25 EA
 IN - Air Conditioning Log Sheet. INDIANA ONLY.

FORM E 6024 ISS 01-88
 0006792 25 EA
 IN - Indiana Bell Monthly EWFDS Log. INDIANA ONLY.

FORM E 6040 ISS 01-88
 0006799 25 EA
 IN - C.E.V. Monthly Log Sheet. INDIANA ONLY.

PRODUCT IDENTIFIER DESCRIPTION

ITEM	ORD.	SELL	STD. PKG.	LEAD TIME	MIN.	A
NUMBER	MULT.	UNIT	STOCK AVAILABILITY / PA		ORD.	C

FORM E 6181 ISS 03-84
 0003063 25 EA
 IN - Trouble Recorder Card - #5 XBAR. INDIANA ONLY.

FORM E 6183 ISS 05-73
 0004529 1000 EA
 IN - ESS Busy Hour Matching Loss. INDIANA ONLY.

FORM E 6193 ISS 02-86
 0003189 500 EA
 IN - PIC Cable Counts. INDIANA ONLY.

FORM E 6209 ISS 01-73
 0003064 25 EA
 IN - List Service Request Memo. INDIANA ONLY.

FORM E 6325 ISS 02-84
 0004530 50 EA
 IN - T Carrier Terminal. INDIANA ONLY.

FORM E 6370 ISS 03-90
 0006877 100 EA
 IN - Load Forecast. INDIANA ONLY.

FORM E 6373 ISS 03-90
 0006875 100 EA
 IN - Daily Force Log Projection. INDIANA ONLY.

FORM E 6374 ISS 03-90
 0006876 100 EA
 IN - Forecast. INDIANA ONLY.

260419601 FORM E 6410 ISS 04-91 S700
 1974469 SH IL IN MI OH WI
 33 33 33 33 33
 ASI - Complement Diagrams.

260419593 FORM E 6414 ISS 04-91 S700
 1974451 SH IL IN MI OH WI
 33 33 33 33 33
 ASI - Test Report Conformance Testing.

FORM E 6457 ISS 03-84
 0004533 1 EA
 IN - DSX - Tag. INDIANA ONLY.

FORM E 6661 1A
 0007576 1 EA
 INDIANA ONLY.

FORM E 6670
 0003753 200 EA
 IN - Tariff Violation Notice. INDIANA ONLY.

FORM E 6723 ISS 05-87
 0003168 1 EA
 IN - Key Designation Tabs. INDIANA ONLY.

FORM E 6906 C ISS 05-78
 0005323 25 EA
 IN - Performance Review. INDIANA ONLY.

DISTRIBUTION SERVICES

NETWORK SERVICES

TOOLS

BUILDING JANITORIAL

AUTOMOTIVE

FORMS/OFFICE SUPPLIES

GENERAL

DATA VOICE

FORM

DISTRIBUTION SERVICES

PRODUCT IDENTIFIER DESCRIPTION

ITEM NUMBER	ORD. MULT.	SELL UNIT	STD. PKG. STOCK AVAILABILITY / PA	LEAD TIME	MIN. ORD.	A C
-------------	------------	-----------	-----------------------------------	-----------	-----------	-----

0003047 5000 EA
 IN - Order Log - File Jacket. INDIANA ONLY.

FORM E 10364

0003597 2000 EA
 IN - Station Number Cards. INDIANA ONLY.

FORM E 10365

0003352 2000 EA
 IN - Station Number Cards. INDIANA ONLY.

FORM E 10610 ISS 06-88

0005168 500 EA
 IN - Verification for New USOC Codes. INDIANA ONLY.

FORM E 10611 ISS 06-88

0005252 25 EA
 IN - Request for New Uniform Service Order Codes USOC. INDIANA ONLY.

FORM EO 42 1 ISS 01-86

0005331 100 EA
 IN - DMS 200 Network Switch Performance Measurement Plan. INDIANA ONLY.

FORM EO 94 ISS 02-84

0004575 25 EA
 IN - Daily Plans. INDIANA ONLY.

FORM EO 122 ISS 08-84

0003069 25 EA
 IN - Installation. INDIANA ONLY.

FORM EO 135 ISS 01-84

0003074 500 EA
 IN - Interexchange Customer Billing Details. INDIANA ONLY.

FORM EO 143 ISS 10-83

0004572 25 EA
 IN - Engineering Complaint. INDIANA ONLY.

300081585 FORM EO 194 ISS 02-84

5125633 100 SH IL IN MI OH WI
 33
 Daily Plans.

FORM EO 195 ISS 08-85

0004576 25 EA
 IN - Individual Performance Summary. INDIANA ONLY.

FORM EO 197 ISS 09-85

0004577 25 EA
 IN - Call Detail Record. INDIANA ONLY.

FORM EO 198 ISS 11-85

0004578 25 EA
 IN - Operator Development Summary - DA. INDIANA ONLY.

300081601 FORM EO 207 1

5125575 50 SH IL IN MI OH WI
 33
 Monthly-Weekly Plans.

NETWORK SERVICES

TOOLS

BUILDING JANITORIAL

AUTOMOTIVE

FORMS/OFFICE SUPPLIES

GENERAL

DATA VOICE

PRODUCT IDENTIFIER DESCRIPTION

ITEM NUMBER	ORD. MULT.	SELL UNIT	STD. PKG. STOCK AVAILABILITY / PA	LEAD TIME	MIN. ORD.	A C
-------------	------------	-----------	-----------------------------------	-----------	-----------	-----

0004581 100 EA
 IN - Planned Daily Development Activities. INDIANA ONLY.

FORM EO 209 ISS 01-86

0005345 100 EA
 IN - Group Monthly Summary. INDIANA ONLY.

FORM EO 210 ISS 02-84

0004582 100 EA
 IN - Diag & Performance Improvement Act Cont. INDIANA ONLY.

260321799 FORM EO 210 LB ISS 01-88

1942649 25 SH IL IN MI OH WI
 33
 IL - Diagnostic and Performance Improvement Activities.

FORM EO 211 ISS 10-84

0004583 100 EA
 IN - Operational Trouble Report. INDIANA ONLY.

300081627 FORM EO 213 1 ISS 09-85

1333815 250 EA IL IN MI OH WI
 33

300081635 FORM EO 213 2 ISS 09-85

N EA 250 4 9500

FORM EO 227 ISS 01-84

0004584 25 EA
 IN - Construction Quality Inspection Worksheet. INDIANA ONLY.

FORM EO 229 ISS 01-84

0004585 25 EA
 IN - Engineering Quality Inspection Worksheet. INDIANA ONLY.

FORM EO 230 ISS 01-84

0004586 25 EA
 IN - Local Quality Inspection Monthly Summary Engineering. INDIANA ONLY.

FORM EO 231 ISS 09-84

0004587 25 EA
 IN - Summary of Defects. INDIANA ONLY.

FORM EO 312 ISS 05-87

0003077 2000 EA
 IN - MAPSS Trouble Ticket. INDIANA ONLY.

FORM EO 313 ISS 02-84

0004589 1000 EA
 IN - MAPSS Inventory Ticket. INDIANA ONLY.

FORM EO 376

0004890 25 WA
 INDIANA ONLY.

FORM EO 380 1 ISS 04-84

0004591 25 EA
 IN - NO.2/2B ESS Control Record PART 1. INDIANA ONLY.

PRODUCT IDENTIFIER		DESCRIPTION															
ITEM NUMBER	ORD. MULT.	SELL UNIT	STD. PKG. STOCK AVAILABILITY / PA	LEAD TIME	MIN. ORD.	A	C										
0004592	100	EA	FORM EO 383	ISS 01-84													
IN - NO. 3 ESS Control Record. INDIANA ONLY.																	
0004593	100	EA	FORM EO 391	ISS 04-84													
IN - NO. 1 ESS Control Record. INDIANA ONLY.																	
0004596	100	EA	FORM EO 428	ISS 08-84													
IN - Work Evaluation Record. INDIANA ONLY.																	
0004597	25	EA	FORM EO 492 1	ISS 02-84													
IN - Central Office Rearrangements & Changes. INDIANA ONLY.																	
0004598	25	EA	FORM EO 501	ISS 04-84													
IN - Individual Employee Daily Record. INDIANA ONLY.																	
0004599	25	EA	FORM EO 504	ISS 01-84													
IN - Engineering Work Order Pre-Survey Worksheet. INDIANA ONLY.																	
0004600	25	EA	FORM EO 507	ISS 01-84													
IN - Forecast of Available Hours. INDIANA ONLY.																	
0006800	50	EA	FORM EO 728	ISS 12-85													
IN - Field Assistance Log. INDIANA ONLY.																	
0007577	50	EA	FORM EO 2307	ISS 01-84													
IN - Record of Central Office Equipment. INDIANA ONLY.																	
0005371	100	EA	FORM EO 4106	ISS 10-85													
IN - Special Service Protection. INDIANA ONLY.																	
1974477		SH	260419619 FORM EO 4108	ISS 04-91 S3C50													
<table border="1"> <tr> <td>IL</td> <td>IN</td> <td>MI</td> <td>OH</td> <td>WI</td> </tr> <tr> <td>33</td> <td>33</td> <td>33</td> <td>33</td> <td>33</td> </tr> </table> ASI - Defective Cable Pairs Report.								IL	IN	MI	OH	WI	33	33	33	33	33
IL	IN	MI	OH	WI													
33	33	33	33	33													
0005797	25	EA	FORM EO 4255	ISS 12-84													
IN - Trunk Outage Log. INDIANA ONLY.																	
0004595	25	EA	FORM EO 4256														
IN - Record of Equipment Outage. INDIANA ONLY.																	
1333930	50	SH	300081643 FORM EO 5231	ISS 08-84													
<table border="1"> <tr> <td>IL</td> <td>IN</td> <td>MI</td> <td>OH</td> <td>WI</td> </tr> <tr> <td>33</td> <td>33</td> <td>33</td> <td>33</td> <td>33</td> </tr> </table> SPCS Trouble Ticket.								IL	IN	MI	OH	WI	33	33	33	33	33
IL	IN	MI	OH	WI													
33	33	33	33	33													

PRODUCT IDENTIFIER		DESCRIPTION															
ITEM NUMBER	ORD. MULT.	SELL UNIT	STD. PKG. STOCK AVAILABILITY / PA	LEAD TIME	MIN. ORD.	A	C										
0004629	50	SH	FORM EO 5451	ISS 07-84													
IN - Preventive Maintenance Schedule. INDIANA ONLY.																	
1333922	25	SH	300081668 FORM EO 5452	ISS 07-84													
<table border="1"> <tr> <td>IL</td> <td>IN</td> <td>MI</td> <td>OH</td> <td>WI</td> </tr> <tr> <td>33</td> <td>33</td> <td>33</td> <td>33</td> <td>33</td> </tr> </table> Text & Inspection Work Order & Record.								IL	IN	MI	OH	WI	33	33	33	33	33
IL	IN	MI	OH	WI													
33	33	33	33	33													
0004601	25	EA	FORM EO 5452	ISS 07-84													
IN - Text & Inspection Work Order & Record. INDIANA ONLY.																	
0004602	25	EA	FORM EO 5457	ISS 08-84													
IN - Central Office Log. INDIANA ONLY.																	
0003742	25	EA	FORM EO 5457 1	ISS 03-89													
IN - Central Office Log - Numbered. INDIANA ONLY.																	
1333989	50	SH	300081676 FORM EO 5461	ISS 08-84													
<table border="1"> <tr> <td>IL</td> <td>IN</td> <td>MI</td> <td>OH</td> <td>WI</td> </tr> <tr> <td>33</td> <td>33</td> <td>33</td> <td>33</td> <td>33</td> </tr> </table> Step-By-Step Trouble Ticket.								IL	IN	MI	OH	WI	33	33	33	33	33
IL	IN	MI	OH	WI													
33	33	33	33	33													
1333955	1	SH	300081684 FORM EO 5479	ISS 08-84													
<table border="1"> <tr> <td>IL</td> <td>IN</td> <td>MI</td> <td>OH</td> <td>WI</td> </tr> <tr> <td>33</td> <td>33</td> <td>33</td> <td>33</td> <td>33</td> </tr> </table> No. 5X Bar Trouble Ticket.								IL	IN	MI	OH	WI	33	33	33	33	33
IL	IN	MI	OH	WI													
33	33	33	33	33													
0006778	25	EA	FORM EO 5491	ISS 08-84													
IN - Training Record. INDIANA ONLY.																	
0004603	25	EA	FORM EO 5695	ISS 04-84													
IN - Trunk Transmission Maintenance Index. INDIANA ONLY.																	
0004606	25	EA	FORM EO 6421 A	ISS 01-86													
IN - NO.1A ESS Network Switching Performance Measurement Plan. INDIANA ONLY.																	
0004607	25	EA	FORM EO 6421 B	ISS 01-84													
IN - NO.1/1A ESS Network Switch Performance Measurement Plan Office Summary. INDIANA ONLY.																	
0004609	25	EA	FORM EO 6422 B	ISS 01-84													
IN - NO.3 ESS Network Switch Performance Measurement Plan Office Summary. INDIANA ONLY.																	
0004610	25	EA	FORM EO 6424 B	ISS 01-84													
IN - SXS Network Switch Performance Measurement Plan Office Summary. INDIANA ONLY.																	

DISTRIBUTION SERVICES

NETWORK SERVICES

TOOLS

BUILDING JANITORIAL

AUTOMOTIVE

FORMS/OFFICE SUPPLIES

GENERAL

DATA VOICE

FORM

DISTRIBUTION SERVICES

PRODUCT IDENTIFIER		DESCRIPTION				
ITEM NUMBER	ORD. MULT.	SELL UNIT	STD. PKG. STOCK AVAILABILITY / PA	LEAD TIME	MIN. ORD.	A C

0004611 25 EA
FORM EO 6424 C ISS 01-84
 IN - SXS Non-OBS Network Switch Performance Measurement Plan Office Summary. INDIANA ONLY.

NETWORK SERVICES

300081692 **FORM EO 6622 ISS 08-84**
 N SH 500 4 3000

300081718 **FORM EO 6837 ISS 08-84**
 5125591 50 SH IL IN MI OH WI
 33
 Work Schedule, Sunday to Saturday Work Week.

TOOLS

300077518 **FORM EO 6838 ISS 08-84**
 1333260 50 SE IL IN MI OH WI
 33 33
 ASI - SCC Work Request.

300077534 **FORM EO 10210 ISS 08-84**
 5124230 50 SE IL IN MI OH WI
 33
 ASI - Work File Face Sheet.

BUILDING JANITORIAL

300081726 **FORM EO 10619 ISS 12-84**
 1333898 25 SH IL IN MI OH WI
 33 33
 SPCS Trouble Ticket, Optional, package of 25.

AUTOMOTIVE

0006782 100 EA
FORM GBE 141 ISS 08-90
 IN - Request for Payment. INDIANA ONLY.

0004645 200 EA
FORM GBE 145 ISS 05-78
 IN - Affidavit and Waiver of Lien. INDIANA ONLY.

0004651 100 EA
FORM GBE 156 ISS 06-86
 IN - Plant Displaced. INDIANA ONLY.

FORMS/OFFICE SUPPLIES

0004705 50 EA
FORM GEE 28
 INDIANA ONLY.

0007670 1 EA
FORM GRP94199
 IN - Vision Care Expense Benefit Claim. INDIANA ONLY.

GENERAL

0006809 50 EA
FORM GTE 12 B ISS 11-88
 IN - Sum of Working Lines and Directory Numbers for ESS. INDIANA ONLY.

0003224 1000 EA
FORM ISD 086
 INDIANA ONLY.

DATA VOICE

280044397 **FORM M 1012 2 ISS 10-90 J15M24**
 N EA 500 6 15000
 WI - Envelope - Appleton Return.

260378229 **FORM M 2825 1 ISS 02-90 J12M24**
 N EA 500 4 12000

PRODUCT IDENTIFIER		DESCRIPTION				
ITEM NUMBER	ORD. MULT.	SELL UNIT	STD. PKG. STOCK AVAILABILITY / PA	LEAD TIME	MIN. ORD.	A C

280040841 **FORM M 3282 ISS 07-84 J10M24**
 N SE 100 6 10000
 WI - Mail Service Receipt.

280041674 **FORM M 4045 ISS 06-84 J20M24**
 N EA 100 4 20000

280041690 **FORM M 4548 ISS 04-81 J6M24**
 N EA 100 4 6000

280041476 **FORM M 7928 ISS 05-82 J35M24**
 N EA 100 4 35000

280041484 **FORM M 7953 ISS 08-82 J5M24**
 N EA 500 4 45000

260330394 **FORM M 7971 7 ISS 08-90 J17M5C24**
 N EA 500 6 17500

0003744 1 EA
FORM MA 2930 ISS 05-89
 IN - Employee Profile. INDIANA ONLY.

280040874 **FORM ME 4104 ISS 06-85 J12M24**
 N SE 100 6 12000
 WI - Notification To Accounting EDP Center Magnetic Tape Recording Location Trouble and Activity.

0005004 25 EA
FORM MO 20 ISS 09-82
 IN - Summary of Significant Medical Conditions. INDIANA ONLY.

260321377 **FORM MP 74 1 ISS 01-88**
 1942359 25 SE IL IN MI OH WI
 33 33 33 33 33
 ASI - Returned Material Notice.

260321385 **FORM MP 74 2 ISS 01-88**
 1942367 50 SE IL IN MI OH WI
 33 33 33 33 33
 ASI - Lower portion of Returned Material Notice, enlarged.

260321401 **FORM MP 74 3 ISS 01-88**
 1942375 1 EA IL IN MI OH WI
 33
 ASI - Tag, Returned Material Notice - IN.

260321419 **FORM MP 74 3 ISS 01-88 S5M**
 1942409 50 EA IL IN MI OH WI
 33
 ASI - Tag, Returned Material Notice - MI.

260321393 **FORM MP 74 3 ISS 02-88 S5M**
 1942383 50 EA IL IN MI OH WI
 33
 ASI - Tag Returned Material Notice - IL.

260381157 **FORM MP 74 3 ISS 05-90 S2M24**
 1961037 50 EA IL IN MI OH WI
 33
 ASI - TAG 'Returned Material Notice' - WI.

PRODUCT IDENTIFIER		DESCRIPTION					
ITEM	ORD.	SELL	STD. PKG.	LEAD TIME	MIN.	A	
NUMBER	MULT.	UNIT	STOCK AVAILABILITY / PA		ORD.	C	
260363197	FORM MP	74	3	ISS 09-89			
1954297	50	EA	IL	IN MI OH WI	33		ASI - TAG, Returned Material Notice - OH.
300012051	FORM MPBS	IN1935					
1197954	50	SE	IL	IN MI OH WI	33		SR&R Repair Form, serialized.
300000007	FORM MPBS	IS1935					
5100057	50	SE	IL	IN MI OH WI	33		Service Repair & Return Order, serialized.
300012036	FORM MPBS	MC1935-1					
1300020	50	SE	IL	IN MI OH WI	33		No Number.
300012028	FORM MPBS	OH1935					
6500017	50	SE	IL	IN MI OH WI	33		Serialized.
300012044	FORM MPBS	WS1935					
8400010	50	SE	IL	IN MI OH WI	33		Serialized.
	FORM NE	281	ISS 03-89				
0003739	100	EA					IN - Current View. INDIANA ONLY.
001220318	FORM PC	876					
5635680	25	SE	IL	IN MI OH WI	33		IL - Summary Gasoline Disbursed From Account 122-003.
	FORM PE	12	ISS 07-78				
0005089	25	SE					IN - Allocation Area Documentation Record. INDIANA ONLY.
	FORM PE	13 A	ISS 03-77				
0005093	25	EA					IN - Additional Costs Encountered Over Bid. INDIANA ONLY.
280099425	FORM PE	15	ISS 07-87				
1937672	25	SE	IL	IN MI OH WI	33		IN - Rearrangement of Telephone Facilities.
	FORM PE	18	ISS 04-80				
0005097	25	EA					IN - Interfaced Plant Data SAC Development. INDIANA ONLY.
	FORM PE	29	ISS 02-83				
0005124	25	EA					IN - Authorization of Additional Job Order Charges. INDIANA ONLY.

PRODUCT IDENTIFIER		DESCRIPTION					
ITEM	ORD.	SELL	STD. PKG.	LEAD TIME	MIN.	A	
NUMBER	MULT.	UNIT	STOCK AVAILABILITY / PA		ORD.	C	
	FORM PE	46	ISS 12-75				
0007596	50	EA					IN - Outside Plant Construction Program Sheet. INDIANA ONLY.
	FORM PE	54 E					
0005167	50	EA					IN - Right-of-Way Request. INDIANA ONLY.
	FORM PE	56	ISS 05-75				
0007598	50	EA					IN - Engineering Work Print. INDIANA ONLY.
280062266	FORM PE	57	ISS 05-75				
1934851	50	SH	IL	IN MI OH WI	33		IN - Engineering Work Print.
280062274	FORM PE	58	ISS 04-75 S2M22				
1934869	50	SH	IL	IN MI OH WI	33		IN - Semi-opaque Drawing Comb F/S.
280062282	FORM PE	59	ISS 05-75				
1934877	50	SH	IL	IN MI OH WI	33		IN - Engineering Work Print, Underground.
280062290	FORM PE	60	ISS 07-75				
1934885	50	SH	IL	IN MI OH WI	33		IN - Engineering Work Print.
280062308	FORM PE	61	ISS 12-75				
1934893	50	SH	IL	IN MI OH WI	33		IL - Engineering Manhole Work Print.
280062316	FORM PE	62	ISS 07-76 S1M22				
1934901	50	SH	IL	IN MI OH WI	33		IN - Velum Record Form.
280062324	FORM PE	63 A	ISS 09-86				
	N	SH	50	4	1000		IN - Conduit Work Print.
	FORM PE	63 B	ISS 06-77				
0007606	50	EA					IN - Conduit Work Print. INDIANA ONLY.
	FORM PE	107	ISS 07-78				
0005088	50	EA					IN - Area Documentation Record. INDIANA ONLY.
	FORM PE	126 A					
0005092	25	EA					IN - Estimate/Project Card. INDIANA ONLY.
	FORM PE	186	ISS 11-78				
0007609	1	EA					IN - Manhole Detail Record. INDIANA ONLY.

DISTRIBUTION SERVICES
 NETWORK SERVICES
 TOOLS
 BUILDING JANITORIAL
 AUTOMOTIVE
 FORMS/OFFICE SUPPLIES
 GENERAL
 DATA VOICE

FORM

DISTRIBUTION SERVICES

PRODUCT IDENTIFIER		DESCRIPTION				
ITEM NUMBER	ORD. MULT.	SELL UNIT	STD. PKG. STOCK AVAILABILITY / PA	LEAD TIME	MIN. ORD.	A C

0007610 1 EA
FORM PE 200 ISS 01-75
 IN - Work Print - Outside Plant Property Record. INDIANA ONLY.

NETWORK SERVICES

0007611 1 EA
FORM PE 201 ISS 01-75
 IN - Work Print - Outside Plant Property Record. INDIANA ONLY.

280062332 FORM PE 202 A1
 1934935 50 SH IL IN MI OH WI
 33
 IN - Conduit Location Record - Mylar, No Grid.

TOOLS

0007623 25 EA
FORM PE 202 A1G
 IN - Conduit Location Record Mylar, No Grid. INDIANA ONLY.

280062340 FORM PE 219 ISS 03-80 S2M22
 N SH 50 4 2000
 IN - Transmission Design Work Sheet.

BUILDING JANITORIAL

280060930 FORM PE 239SP ISS 02-86 22
 N EA 25 4 1000
 IN - Study Map Legend (Stampat)

0005105 100 EA
FORM PE 247 ISS 10-85
 IN - Determination of Billable Amounts. INDIANA ONLY.

AUTOMOTIVE

0005108 50 EA
FORM PE 257 ISS 06-83
 IN - Additional Estimate Charges Authorization. INDIANA ONLY.

0005111 50 EA
FORM PE 259 ISS 08-63
 IN - Cost Computations for Net Loss Billing - REMC. INDIANA ONLY.

FORMS/OFFICE SUPPLIES

0007614 50 EA
FORM PE 266 M ISS 06-66
 IN - Route Layout Sheet. INDIANA ONLY.

0006896 100 EA
FORM PE 275 ISS 06-90
 IN - Certificate of Authentication. INDIANA ONLY.

GENERAL

0005130 100 EA
FORM PE 296 B ISS 09-75
 IN - Job Order Record Log. INDIANA ONLY.

0005134 50 EA
FORM PE 305
 IN - Pencil Copy Request. INDIANA ONLY.

DATA VOICE

0007615 1 EA
FORM PE 314 ISS 06-72
 IN - EFRAP Section Growth Record. INDIANA ONLY.

PRODUCT IDENTIFIER		DESCRIPTION				
ITEM NUMBER	ORD. MULT.	SELL UNIT	STD. PKG. STOCK AVAILABILITY / PA	LEAD TIME	MIN. ORD.	A C

0007616 1 EA
FORM PE 315 A ISS 03-74
 IN - Taper Point Growth Record. INDIANA ONLY.

0005144 25 EA
FORM PE 327 ISS 02-73
 IN - Sale of Plant Detail Sheet. INDIANA ONLY.

0007617 50 EA
FORM PE 423 ISS 07-78
 IN - Route Layout Sheet - Administrative. INDIANA ONLY.

300094059 FORM PE 1000 ISS 03-83
 1932269 50 EA IL IN MI OH WI
 33
 IN - Sticker - Warning - Underground Utilities in This Area.

280060948 FORM PE 1001 ISS 03-83
 1933796 50 EA IL IN MI OH WI
 33
 IN - Sticker - Warning - Underground Utilities in This Area.

280060955 FORM PE 1002 C ISS 02-83
 1933804 50 SH IL IN MI OH WI
 33
 IN - Air Pressure Information Sticker.

0005127 25 EA
FORM PE 2953 ISS 04-83
 IN - Facility Layout and Computation Sheet. INDIANA ONLY.

0007624 50 EA
FORM PE 2962
 IN - Engineering Trunk Work Print. INDIANA ONLY.

0005137 1 EA
FORM PE 4868 1 ISS 05-88
 IN - MTR Daily Work Report - 1 ply, 50/PD. INDIANA ONLY.

0007625 50 EA
FORM PE 6686
 IN - Delta Area Indicator Sticker. INDIANA ONLY.

0007626 50 EA
FORM PE 6690
 IN - Splicers Note Carrier Circuit Sticker. INDIANA ONLY.

0007627 50 EA
FORM PE 6690 1
 IN - Splicers Note - Carrier Circuits in Cable. INDIANA ONLY.

300083441 FORM PER 004 ISS 01-84
 1334011 50 EA IL IN MI OH WI
 33

PRODUCT IDENTIFIER		DESCRIPTION					
ITEM	ORD.	SELL	STD. PKG.	LEAD TIME	MIN.	A	
NUMBER	MULT.	UNIT	STOCK AVAILABILITY / PA		ORD.	C	
FORM PER 189 ISS 07-84							
0003095	200	EA					
IN - Director's Dimension Rating & Data In. Sh. INDIANA ONLY.							
260439054 FORM PF10.098 ISS 09-91 J15C ASI							
N		EA	500	6	1500		
ASI - Purchase Order Envelope.							
260398862 FORM PF10.098 ISS 09-91 L20M ASI							
N		EA	500	6	500		
ASI - Purchase Order envelope, 9 7/8 X 4 1/4IN, 28# white.							
260439047 FORM PF10.098-1 ISS 09-91 J45C ASI							
N		EA	500	6	4500		
ASI - Purchase Order Envelope address: Fleet Avenue, Cleveland, OH.							
260439153 FORM PF10.098-3 ISS 01-91 J15C20							
N		EA	500	6	1500		
IL - Purchase Order Envelope. Address: Randolph Street, Chicago, IL.							
260441423 FORM PF10.099 ISS 04-92 S50M ASI							
N		SE	650	8	50050		
ASI - Purchase Order Forms.							
260405907 FORM PF10.160 2 ISS 09-91 J2M							
N		SE	100	6	2000		
ASI - Standard Purchase Contract (First page of multi-page contract).							
260405915 FORM PF10.160 3 ISS 01-91 J2M							
N		SE	100	6	2000		
ASI - Standard Purchase Contract (last page of multi-page contract).							
260428552 FORM PF10.160 6 ISS 09-91 J1M							
N		SE	100	8	1000		
ASI - Standard Service Contract.							
260398938 FORM PF10.59 ISS 03-87 J55M							
N		SH	2500	8	55000		
ASI - PEARS Non-Processed Order.							
200005536 FORM PM 416 V ISS 03-87 L170M							
N		SH	2000	8	2000		
ASI - Put-Away Label.							
260364294 FORM PM 418 ISS 03-87 S330M							
1954404	1000	SE	IL 33	IN 33	MI 33	OH 33	WI 33
ASI - Manifest.							
280049768 FORM PM 424 IL ISS 03-89 S5C20							
1928325	1	EA	IL 33	IN	MI	OH	WI
280049560 FORM PM 424 IN ISS 03-89 S4C22							
1928333	1	EA	IL 33	IN	MI	OH	WI
280049578 FORM PM 424 MI ISS 03-89							
1928317	25	EA	IL 33	IN	MI	OH	WI

PRODUCT IDENTIFIER		DESCRIPTION					
ITEM	ORD.	SELL	STD. PKG.	LEAD TIME	MIN.	A	
NUMBER	MULT.	UNIT	STOCK AVAILABILITY / PA		ORD.	C	
280049586 FORM PM 424 OH ISS 03-89 S4C23							
1928341	25	EA	IL 33	IN	MI	OH	WI
280049594 FORM PM 424 WI ISS 03-89 S3C24							
1928309	1	EA	IL 33	IN	MI	OH	WI
260324439 FORM PM 425 ISS 06-88							
1944801	100	EA	IL 33	IN	MI	OH	WI 33
260330121 FORM PM 429 IL ISS 06-88							
1946830	1	EA	IL 33	IN	MI	OH	WI
260330139 FORM PM 429 IN ISS 06-88							
1946848	1	EA	IL 33	IN	MI	OH	WI
260330113 FORM PM 429 MI ISS 06-88							
1946822	25	EA	IL 33	IN	MI	OH	WI
260330154 FORM PM 429 OH ISS 06-88							
1946863	1	EA	IL 33	IN	MI	OH	WI
260330147 FORM PM 429 WI ISS 06-88							
1946855	1	EA	IL 33	IN	MI	OH	WI
280049008 FORM PM 434 IL							
1928069	1	EA	IL 33	IN	MI	OH	WI
ASI - Label Tranship Returns - IL.							
280049016 FORM PM 434 IN							
1928101	1	EA	IL 33	IN	MI	OH	WI
ASI - Label Tranship Returns - IN.							
280049024 FORM PM 434 MI							
1928093	1000	EA	IL 33	IN	MI	OH	WI
ASI - Label Tranship Returns - MI.							
280049032 FORM PM 434 OH							
1928119	1	EA	IL 33	IN	MI	OH	WI
ASI - Label Tranship Returns - OH.							
280049040 FORM PM 434 WS							
1928085	1	EA	IL 33	IN	MI	OH	WI
ASI - Label Tranship Returns - WI.							
260331723 FORM PM 436 ISS 02-92 J6M ASI							
1947440	1	EA	IL 33	IN 33	MI 33	OH 33	WI 33
260331731 FORM PM 437 ISS 02-92J6M ASI							
1947457	1	EA	IL 33	IN 33	MI 33	OH 33	WI 33

DISTRIBUTION SERVICES
 NETWORK SERVICES
 TOOLS
 BUILDING JANITORIAL
 AUTOMOTIVE FORMS/OFFICE SUPPLIES
 GENERAL
 DATA VOICE

FORM

DISTRIBUTION SERVICES

PRODUCT IDENTIFIER		DESCRIPTION				
ITEM NUMBER	ORD. MULT.	SELL UNIT	STD. PKG. STOCK AVAILABILITY / PA	LEAD TIME	MIN. ORD.	A C

FORM PNE69121 ISS 05-87
 0003305 1 EA
 IN - Strip Designation. INDIANA ONLY.

NETWORK SERVICES

FORM PPS 1 ISS 01-87
 0007680 1 EA
 IN - Preferred Prescription Service. INDIANA ONLY.

260419387 FORM PR 20 ISS 04-92 J2M REGIONAL
 N SH 250 4 2000
 ASI - Request for Management Personnel.

260419379 FORM PR 36 ISS 01-89 J2M
 N SH 250 4 2000
 ALL - Employee Profile For Management Transfer.

TOOLS

002089571 FORM PV 936 ISS 05-83 S48C20
 5656041 25 SE IL IN MI OH WI
 33
 IL - Credit Ticket for Checks Returned to the Treasurer's Office.

BUILDING JANITORIAL

001158468 FORM PV 956 ISS 08-80 J10M20
 N SE 50 8 10000
 IL - Voucher Packet Control.

260398912 FORM PY 26 2 ISS 11-90 J24M
 N SE 1500 8 24000
 ASI - Transmittal Advice.

AUTOMOTIVE

260433347 FORM PY 650 ISS 11-91 J5CASI
 N SH 100 8 500
 ASI - Telephone Pioneer Transmittal.

260398920 FORM PY 2949 ISS 01-91 J44M4C
 N SE 1400 8 44400
 ASI - Allotment Confirmation Notice.

FORMS/OFFICE SUPPLIES

260435037 FORM PY30 209A ISS 10-91 J6M
 N EA 1 4 6000
 ASI - Employee's Withholding Allowance Certificate W-4.

260433354 FORM PY92 625 ISS 11-91 J5C
 N SH 100 8 500
 ASI - Commercial Insurance Transmittal.

260433370 FORM PY92 630 J5C
 N SH 100 8 500
 ASI - Credit Union Direct Deposit.

GENERAL

260433362 FORM PY92 640 ISS 11-91 J5C
 N SH 100 8 500
 ASI - Committee on Political Education Transmittal.

260420302 FORM PY92 801 ISS 04-91 J10M
 N EA 500 6 10000
 Authorization for Charitable Contributions.

DATA VOICE

300073277 FORM RA 47 ISS 07-81 J30M20
 N SH 6000 8 30000
 IL - Record of Directory Changes.

PRODUCT IDENTIFIER		DESCRIPTION				
ITEM NUMBER	ORD. MULT.	SELL UNIT	STD. PKG. STOCK AVAILABILITY / PA	LEAD TIME	MIN. ORD.	A C

260322896 FORM RC 1 ISS 02-88
 1943225 1 SE IL IN MI OH WI
 33
 IN - Records Retention & Destruction Transmittal.

FORM RC 1 ISS 09-88
 0005207 25 EA
 IN - Relocation Expense Record. INDIANA ONLY.

FORM RC 3 ISS 01-75
 0005201 25 EA
 IN - Certification Statement. INDIANA ONLY.

FORM RC 5 ISS 02-88
 0003099 500 EA
 IN - Request for Reference Service. INDIANA ONLY.

FORM RC 6 ISS 09-83
 0005203 25 EA
 IN - Reg Ref-Not Removed from the Record Center. INDIANA ONLY.

FORM RC 9
 0005206 25 EA
 IN - Security File Transmittal. INDIANA ONLY.

FORM RC 11 ISS 01-75
 0003558 500 EA
 IN - Records Removed Label. INDIANA ONLY.

FORM RE 3 ISS 07-87
 0006751 1 EA
 IN - Annual Statement of Relocation Reimbursement. INDIANA ONLY.

FORM RE 5 ISS 04-87
 0005209 25 EA
 IN - Mortgage Interest Difference Authorization. INDIANA ONLY.

FORM RE 6 ISS 09-84
 0005210 25 EA
 IN - Relocation Tax Expense Notice. INDIANA ONLY.

260412044 FORM SAL 100 ISS 01-92 J1M5C
 N SH 100 4 1500
 ASI - 1992 Schedule of Vacations and Other Time Off.

260398896 FORM SAL 102 ISS 01-92 J12M
 N SH 250 4 12000
 ASI - Attendance Record.

455019430 FORM SD 102
 1217323 50 SE IL IN MI OH WI
 33
 IL - Illinois Bell Telephone Company - AVP-BIS Department - Systems Design Documentation Form.

FORM SE 7
 0005246 25 EA
 IN - Inter-Office Correspondence - Memorandum. INDIANA ONLY.

DISTRIBUTION SERVICES

NETWORK SERVICES

TOOLS

BUILDING JANITORIAL

AUTOMOTIVE

FORMS/OFFICE SUPPLIES

GENERAL

DATA VOICE

PRODUCT IDENTIFIER		DESCRIPTION						
ITEM NUMBER	ORD. MULT.	SELL UNIT	STD. PKG. STOCK AVAILABILITY / PA	LEAD TIME	MIN. ORD.	A C		
0003100	1	EA	FORM SE 45					INDIANA ONLY.
1957753		SE	260375928 FORM SE 45 ISS 06-89	IL IN MI OH WI	33			IN - Request for IBT Official Communication Service.
0007633	150	EA	FORM SN 247 XH					IN - Concession Authority. INDIANA ONLY.
0003104	1	EA	FORM SN 307 B					IN - Sickness Benefit Authorization Record. INDIANA ONLY.
1932244	50	SH	300094075 FORM SN 308 ISS 05-84	IL IN MI OH WI	33			IN - Report of Sickness Disability.
0005259	25	EA	FORM SN 361 C					IN - Bank Deposit Notice Card. INDIANA ONLY.
1932236	50	SH	300094083 FORM SN 385 ISS 04-58	IL IN MI OH WI	33 33			IN - Columnar Work Sheet, 32 Columns, 11 X 17IN.
		EA	260379524 FORM SN 508 ISS 10-83 A2OM23		100	2	2600	OH - Adjustment Voucher, Toll.
1932202	250	SE	300094018 FORM SN 508 ISS 11-84	IL IN MI OH WI	33			IN - Adjustment Voucher.
0003765	500		FORM SN 508 A ISS 11-91					IN - AT&T Adjustment Voucher. INDIANA ONLY.
0003105	300	EA	FORM SN 599 3 ISS 04-85					IN - Settlement of Intercompany Toll Business. INDIANA ONLY.
0007637	25	EA	FORM SN 666 ISS 10-83					IN - Telegrams Charged Back. INDIANA ONLY.
0003106	300	EA	FORM SN 726 ISS 04-89					IN - Original Customer Report of C.O. or other Terminal Equipment Retired at Actual Cost. INDIANA ONLY.
0006750	25	EA	FORM SN 806 C-1-2-3-4 ISS 11-87					IN - Date Established for Term of Employment. INDIANA ONLY.

PRODUCT IDENTIFIER		DESCRIPTION						
ITEM NUMBER	ORD. MULT.	SELL UNIT	STD. PKG. STOCK AVAILABILITY / PA	LEAD TIME	MIN. ORD.	A C		
0003109	300	EA	FORM SN 809 C-1-2-3-4 ISS 11-87					IN - Notice of Revised Date Established for Term of Employment. INDIANA ONLY.
1933762	1	SH	280060971 FORM SN 839 1 ISS 11-78 SIM22	IL IN MI OH WI	33			IN - Record of Payroll Change.
0005264	25	EA	FORM SN 839 SA					IN - Occasional Employees Record. INDIANA ONLY.
0005263	25	EA	FORM SN 839 SUPLB					IN - Overtime Hours for Deferred Service Pension. INDIANA ONLY.
1932210		SH	300094109 FORM SN 866 ISS 01-87	IL IN MI OH WI	33			
0005267	50	EA	FORM SN 875 ISS 12-78					IN - Completion Approvals - Estimate No. INDIANA ONLY.
0005268	50	EA	FORM SN 876 ISS 11-76					IN - Accounts Charged - Estimate No. INDIANA ONLY.
0005269	50	EA	FORM SN 877 ISS 06-82					IN - Plant Item Completion Details. INDIANA ONLY.
1932228	50	SH	300094117 FORM SN 888 D ISS 10-82	IL IN MI OH WI	33			IN - Outside Plant Adjustment Report.
0007641	1	EA	FORM ST 109					IN - Indiana Telephone Sales Tax Exemption Certificate. INDIANA ONLY.
0007643	1	EA	FORM ST 6456 ISS 03-85					IN - Customer Satisfaction Evaluation RTOC. INDIANA ONLY.
0007642	1	EA	FORM ST 6471 ISS 08-85					IN - Foreign National Student Card. INDIANA ONLY.
1969881	1	SH	260405568 FORM SW 4 ISS 12-90 S5M20	IL IN MI OH WI	33			IL - Employee State Withholding Exemption Certificate, 8 1/2 X 3 3/4IN, offset, 60# gray.

FORM

DISTRIBUTION SERVICES

PRODUCT IDENTIFIER		DESCRIPTION				
ITEM NUMBER	ORD. MULT.	SELL UNIT	STD. PKG. STOCK AVAILABILITY / PA	LEAD TIME	MIN. ORD.	A C
FORM T 370 ISS 09-85						
0005282	50	EA				
IN - Checks Returned to Post Office - Undeliverable. INDIANA ONLY.						
FORM TEL 2 ISS 08-90						
0006933	100	EA				
IN - Payroll Deduction Authorization Dependant Group Life Insurance. INDIANA ONLY.						
FORM TEL 2 A ISS 08-90						
0006937	100	EA				
IN - Payroll Deduction Authorization Supplemental Group Life Insurance. INDIANA ONLY.						

NETWORK SERVICES

TOOLS

260428636 FORM TF11.250 ISS 09-91 S2M6C25
1977876 SE IL IN MI OH WI
ASI - Straight Bill of Lading.

260429972 FORM TF.250-14 ISS 04-88 S1M
1978593 100 SE IL IN MI OH WI
ASI - SPECIAL - BILL OF LADING (CAUTION - SCRAP MATERIAL)

BUILDING JANITORIAL

FORM TPA 1 ISS 04-86
0005294 25 EA
IN - Social Organization Activity Report - Pioneers. INDIANA ONLY.

FORM TT 149 ISS 07-87
0006380 1 EA
IN - Indiana Bell Telephone Co. Interoffice Fiber Deployment Plan. INDIANA ONLY.

AUTOMOTIVE

400499232 FORM U 339
1223628 1 CT IL IN MI OH WI
33 33
3500 sheets per carton.

455030510 FORM U 340
1197202 1 CT IL IN MI OH WI
33 33

FORMS/OFFICE SUPPLIES

400435780 FORM U 341
1221697 1 CT IL IN MI OH WI
33 33
1100 sheets per carton.

400435798 FORM U 342
5653907 1 CT IL IN MI OH WI
33
800 sheets per carton.

GENERAL

200004224 FORM W 2 J50M21
N SE 2000 8 50000

300096963 FORM W 2 P
N SE 17000 8 17000
IL - Statement for Recipients of Periodic Annuities, Pensions, Retired Pay, or IRA Payments, 8 1/2 X 4 1/4IN, 3 ply.

DATA VOICE

260443023 FORM W 4 ISS 02-92 S2M20
N EA 25 1 2000
IL -

PRODUCT IDENTIFIER		DESCRIPTION				
ITEM NUMBER	ORD. MULT.	SELL UNIT	STD. PKG. STOCK AVAILABILITY / PA	LEAD TIME	MIN. ORD.	A C
FORM W 4 P ISS 09-84						
0003120	1	EA				
IN - Withhold Certificate for Pension/Annuity Payments. INDIANA ONLY.						
FORM WH 4 ISS 06-91						
0006978	100	EA				
IN - Withholding Certificate for Pension or Annuity Payment. INDIANA ONLY.						

FRAME

400524922 FRAME CABINET LEGAL SIZE 4446-3
N EA 6 3 6

400524906 FRAME CABINET LETTER SIZE 4446-1
6659987 6 SE IL IN MI OH WI
33 33

280011586 FRAME DOCUMENT 2602 L3 8 X 10IN
N EA 1 2 1

280005331 FRAME HANGING FILE LEGAL
0001503 1 EA IL IN MI OH WI

NOW AVAILABLE THROUGH TOUCH-TONE ORDER ENTRY.

280005349 FRAME HANGING FILE LETTER
0001504 1 EA IL IN MI OH WI

NOW AVAILABLE THROUGH TOUCH-TONE ORDER ENTRY.

260409065 FRAME HANGING FOLDER LEGAL B-02
N EA 1 1 1
NOW AVAILABLE THROUGH TOUCH-TONE ORDER ENTRY.

260408968 FRAME HANGING FOLDER LETTER B-01
N EA 1 1 1
NOW AVAILABLE THROUGH TOUCH-TONE ORDER ENTRY.

260409164 FRAME TRANSPARENCY MOUNTING J-51
N BX 1 1 1
White cardboard. Box of 50. NOW AVAILABLE THROUGH TOUCH-TONE ORDER ENTRY.

FRAME CALENDAR

400498077 FRAME CALENDAR 3 MONTHS
7344366 1 EA

FUSER

260422944 FUSER AGENT 8R2955 FOR XEROX 5090
N CT 1 2 1

260368949 FUSER AGENT 8R2955 XEROX 1065
N BT 1 2 1

DISTRIBUTION SERVICES
 NETWORK SERVICES
 TOOLS
 BUILDING JANITORIAL
 AUTOMOTIVE
 FORMS/OFFICE SUPPLIES
 GENERAL
 DATA VOICE

PRODUCT IDENTIFIER		DESCRIPTION				
ITEM NUMBER	ORD. MULT.	SELL UNIT	STD. PKG. STOCK AVAILABILITY / PA	LEAD TIME	MIN. ORD.	A C
260411996		FUSER AGENT FA-1				
N		CT	1	2	1	
		Xerox.				

260436811		FUSER AGENT IBM 3835 #6190656				
N		EA	1	2	1	

PRODUCT IDENTIFIER		DESCRIPTION				
ITEM NUMBER	ORD. MULT.	SELL UNIT	STD. PKG. STOCK AVAILABILITY / PA	LEAD TIME	MIN. ORD.	A C
280051806		HANGER MAGNETIC HANDBAG HOOK				
0001294	1	EA	IL IN MI OH WI			

NOW AVAILABLE THROUGH TOUCH-TONE ORDER ENTRY.

280051764		HANGER MAGNETIC PICTURE HOOK 5LB				
0001290	1	EA	IL IN MI OH WI			

NOW AVAILABLE THROUGH TOUCH-TONE ORDER ENTRY.

280051756		HANGER MAGNETIC PICTURE HOOK 10LB				
0001291	1	EA	IL IN MI OH WI			

NOW AVAILABLE THROUGH TOUCH-TONE ORDER ENTRY.

280051749		HANGER MAGNETIC PICTURE HOOK 15LB				
0001292	1	EA	IL IN MI OH WI			

NOW AVAILABLE THROUGH TOUCH-TONE ORDER ENTRY.

280051772		HANGER MAGNETIC PICTURE HOOK 2-1/2LB				
0001289	1	EA	IL IN MI OH WI			

NOW AVAILABLE THROUGH TOUCH-TONE ORDER ENTRY.

GLUE

280004177		GLUE ELMER'S 4 OZ				
0001001	1	EA				

NOW AVAILABLE THROUGH TOUCH-TONE ORDER ENTRY.

280004185		GLUE STICK .26 OZ				
0001002	1	EA	IL IN MI OH WI			

NOW AVAILABLE THROUGH TOUCH-TONE ORDER ENTRY.

GUIDE

260409867		GUIDE INDEX CARD 5 X 8IN BUFF H-13				
N		BX	1	1	1	

Bristol material, 100 per box, 1/3 cut, plain tab, 5 x 8IN.

260409966		GUIDE TAB CARD SELF TAB H-19				
N		BX	1	1	1	

Bristol material, 100 per box, 1/5 cut.

GUIDE FILE

260409362		GUIDE FILE CARD 5 X 3IN BUFF B-05				
N		BX	1	1	1	

With blank tabs, 100 per box, 1/3 cut, end position. NOW AVAILABLE THROUGH TOUCH-TONE ORDER ENTRY.

260409768		GUIDE FILE CARD 6 X 4IN B-20				
N		BX	1	1	1	

100 per box, 1/5 cut, 5 position. NOW AVAILABLE THROUGH TOUCH-TONE ORDER ENTRY.

260409560		GUIDE FILE CARD 6 X 4IN BUFF B-10				
N		BX	1	1	1	

With blank tabs, 100 per box, 1/3 cut, end position. NOW AVAILABLE THROUGH TOUCH-TONE ORDER ENTRY.

260409669		GUIDE FILE CARD 8 X 5IN BUFF B-16				
N		BX	1	1	1	

With blank tabs, 100 per box, 1/5 cut, interim position. NOW AVAILABLE THROUGH TOUCH-TONE ORDER ENTRY.

HANGER

280051699		HANGER MAGNETIC COAT 2-HOOK				
0001293	1	EA				

NOW AVAILABLE THROUGH TOUCH-TONE ORDER ENTRY.

HIGHLIGHTER

280012238		HIGHLIGHTER 6 COLOR ST STABILO				
0001823	1	SE				

YELLOW-BLUE-GREEN-RED-ORANGE-PINK. NOW AVAILABLE THROUGH TOUCH-TONE ORDER ENTRY.

280006149		HIGHLIGHTER BROAD TIP GREEN				
0001708	1	EA	IL IN MI OH WI			

Stabilo Boss. NOW AVAILABLE THROUGH TOUCH-TONE ORDER ENTRY.

280006164		HIGHLIGHTER BROAD TIP PINK				
0001710	1	EA	IL IN MI OH WI			

Stabilo Boss. NOW AVAILABLE THROUGH TOUCH-TONE ORDER ENTRY.

280006172		HIGHLIGHTER BROAD TIP YELLOW				
0001711	1	EA	IL IN MI OH WI			

Stabilo Boss. NOW AVAILABLE THROUGH TOUCH-TONE ORDER ENTRY.

260432299		HIGHLIGHTER BROAD TIP YELLOW				
0001798	1	EA	IL IN MI OH WI			

Non-flourescent. NOW AVAILABLE THROUGH TOUCH-TONE ORDER ENTRY.

280012501		HIGHLIGHTER SPOTLITER BLUE				
0001789	1	DZ	IL IN MI OH WI			

NOW AVAILABLE THROUGH TOUCH-TONE ORDER ENTRY.

HIGHLIGHTER

DISTRIBUTION SERVICES

PRODUCT IDENTIFIER		DESCRIPTION				
ITEM NUMBER	ORD. MULT.	SELL UNIT	STD. PKG. STOCK AVAILABILITY / PA	LEAD TIME	MIN. ORD.	A C

280012485 HIGHLIGHTER SPOTLITER GREEN
 0001790 1 DZ IL IN MI OH WI
 NOW AVAILABLE THROUGH TOUCH-TONE ORDER ENTRY.

NETWORK SERVICES

280012469 HIGHLIGHTER SPOTLITER ORANGE
 0001791 1 DZ IL IN MI OH WI
 NOW AVAILABLE THROUGH TOUCH-TONE ORDER ENTRY.

TOOLS

280012493 HIGHLIGHTER SPOTLITER PINK
 0001792 1 DZ IL IN MI OH WI
 NOW AVAILABLE THROUGH TOUCH-TONE ORDER ENTRY.

260432281 HIGHLIGHTER SPOTLITER PURPLE
 0001797 1 DZ IL IN MI OH WI
 NOW AVAILABLE THROUGH TOUCH-TONE ORDER ENTRY.

BUILDING JANITORIAL

280012477 HIGHLIGHTER SPOTLITER YELLOW
 0001793 1 DZ IL IN MI OH WI
 NOW AVAILABLE THROUGH TOUCH-TONE ORDER ENTRY.

HOLDER

AUTOMOTIVE

260408406 HOLDER BADGE INSERTIBLE PIN-BACK D-88
 N EA 1 1 1
 3in x 2in.

260408505 HOLDER BADGE INSERTIBLE PIN-BACK D-89
 N EA 1 1 1
 3-1/2 x 2-1/4IN. NOW AVAILABLE THROUGH TOUCH-TONE ORDER ENTRY.

260408604 HOLDER BADGE INSERTIBLE PIN-BACK J-52
 N EA 1 1 1
 4in x 3in.

260408703 HOLDER BADGE INSERTIBLE POCKET D-86
 N EA 1 1 1
 3in x 2in.

401606017 HOLDER BLOTTER 19X24
 1183145 1 EA IL IN MI OH WI
 33 33 33

300024684 HOLDER CARD ID W/CLIP
 N EA 1 2 1
 3 3/4in wide x 3 1/4in high, 2 1/2in front.

260408828 HOLDER COPY MAGNETIC BEIGE E-13
 N EA 1 1 1
 9in x 12in.

260408927 HOLDER COPY MAGNETIC BEIGE E-15
 N EA 1 1 1
 9in x 14in.

GENERAL

FORMS/OFFICE SUPPLIES

DATA VOICE

PRODUCT IDENTIFIER		DESCRIPTION				
ITEM NUMBER	ORD. MULT.	SELL UNIT	STD. PKG. STOCK AVAILABILITY / PA	LEAD TIME	MIN. ORD.	A C

260408729 HOLDER COPY MAGNETIC BLACK E-12
 N EA 1 1 1
 9IN X 12IN.

260409024 HOLDER COPY MAGNETIC BLACK E-16
 N EA 1 1 1
 18in x 12in.

260409321 HOLDER COPY STEEL 1-PIECE PUTTY E-20
 N EA 1 1 1
 7in X 9 1/2in.

260410063 HOLDER DESK BLOTTER BLACK B-22
 N EA 1 1 1
 19in x 24in.

260410360 HOLDER DESK BLOTTER BROWN A-27
 N EA 1 1 1
 19 X 24IN, replacement blotter. NOW AVAILABLE THROUGH TOUCH-TONE ORDER ENTRY.

260410162 HOLDER DESK BLOTTER BROWN B-23
 N EA 1 1 1
 19 X 24IN. NOW AVAILABLE THROUGH TOUCH-TONE ORDER ENTRY.

260410261 HOLDER DESK BLOTTER CLEAR D-77
 N EA 1 1 1
 19 X 24IN, clear plastic sheet. NOW AVAILABLE THROUGH TOUCH-TONE ORDER ENTRY.

260410667 HOLDER ID NECKLACE 30IN 8501 K-11
 N EA 1 1 1
 BLACK. NOW AVAILABLE THROUGH TOUCH-TONE ORDER ENTRY.

260410766 HOLDER ID STRAP 8503 K-12
 N EA 1 1 1
 W/SILVER CLIP. NOW AVAILABLE THROUGH TOUCH-TONE ORDER ENTRY.

400524807 HOLDER LABEL 4445-11 1/5 cut
 N EA 100 3 100

260410865 HOLDER MICROFICHE WHITE B-26
 N EA 1 1 1
 NOW AVAILABLE THROUGH TOUCH-TONE ORDER ENTRY.

280012907 HOLDER OPERATIONS INSTRUCTIONS
 N EA 1 2 1
 116CZ.

260414115 HOLDER PAD JR LEGAL BLACK I-14
 N EA 1 1 1
 Without Clip. NOW AVAILABLE THROUGH TOUCH TONE DATA ENTRY.

260416904 HOLDER PAD LETTER BLACK I-10
 N EA 1 1 1
 Without Clip. NOW AVAILABLE THROUGH TOUCH TONE ORDER ENTRY.

260414214 HOLDER PAD LETTER BLACK I-18
 N EA 1 1 1
 With Clip.

DISTRIBUTION SERVICES

NETWORK SERVICES

TOOLS

BUILDING JANITORIAL

AUTOMOTIVE

FORMS/OFFICE SUPPLIES

GENERAL

DATA VOICE

PRODUCT IDENTIFIER		DESCRIPTION				
ITEM NUMBER	ORD. MULT.	SELL UNIT	STD. PKG. STOCK AVAILABILITY / PA	LEAD TIME	MIN. ORD.	A C
260414016		EA	1	1	1	
Holder PAD LETTER NAVY I-12 Without Clip.						
260414313		EA	1	1	1	
Holder PAD LETTER NAVY I-20 With Clip.						
260408422		EA	1	1	1	
Holder PAPER CLIP MAGNETIC BLACK E-59						
260408521		EA	1	1	1	
Holder PAPER CLIP MAGNETIC WALNUT E-60						
300022944		BX	1	2	1	
Holder REQUISITION PRE-TERM Poly Zip L2-47911, box of 50.						
300049822		EA	1	1	50	
Holder WHISK DC TWO LEAVES						
300049830		EA	1	1	50	
Holder WHISK QC FOUR LEAVES						
300049848		EA	1	1	50	
Holder WHISK TC THREE LEAVES						

HOLE PUNCH

SEE PUNCH.

INDEX

401339049 INDEX AICO POSITION 5 UD 213
5665562 12 SE
Clear tab, buff, 36lbs, rip proof finding edge, 5 tabs per set, clear tab stock.

401339031 INDEX AICO POSITION 8
8674408 12 SE IL IN MI OH WI
33 33 33 33
8 1/2in x 11in.

400524989 INDEX AICO POSITION 15
N SE 1 1
8 1/2in x 11in.

300027588 INDEX ALPHA A-Z 1/26 CUT
8403444 1 SE IL IN MI OH WI
33 33 33 33

260408174 INDEX INSERTABLE 11 X 8 1/2 B-29
N SE 1 1 1
5 per set NOW AVAILABLE THROUGH TOUCH-TONE ORDER ENTRY.

260408273 INDEX INSERTABLE 11 X 8 1/2 B-30
N SE 1 1 1
8 per set NOW AVAILABLE THROUGH TOUCH-TONE ORDER ENTRY.

PRODUCT IDENTIFIER		DESCRIPTION				
ITEM NUMBER	ORD. MULT.	SELL UNIT	STD. PKG. STOCK AVAILABILITY / PA	LEAD TIME	MIN. ORD.	A C
260408075		SE	1	1	1	
INDEX INSERTABLE 14 7/8 X 11 B-28 6 per set. NOW AVAILABLE THROUGH TOUCH-TONE ORDER ENTRY.						
260408372		SE	1	1	1	
INDEX MONTHLY 11 X 8 1/2 B-54 With black leather tabs for 3-ring binder. NOW AVAILABLE THROUGH TOUCH-TONE ORDER ENTRY.						
260408471		SE	1	1	1	
INDEX NUMERIC 11 X 8 1/2 B-55 A1-C-213-50N, 50 tabs.						
400525135		SE	1	2	1	
INDEX SH11 LAMTAB ALPHA						
260408570		PK	1	1	1	
INDEX UNTABBED 11 X 8 1/2 H-57 25 per pack.						

INDEX TELEPHONE LIST

280005042 INDEX TELEPHONE LIST FINDER
0001284 1 EA
Metal with Walnut finish. NOW AVAILABLE THROUGH TOUCH-TONE ORDER ENTRY.

INK

260410774 INK DRAWING 1OZ BOTTLE BLACK B-68
N EA 1 1 1

INK DRY

300027265 INK DRY 6R112 PLUS
8404251 1 CT

280050113 INK DRY 6R121
N CT 1

260422951 INK DRY 6R206 FOR XEROX 5090
N CT 1 2 1

300024635 INK DRY 6R283 PLUS
8402313 1 CT IL IN MI OH WI
33 33 33 33
Four bottles per carton.

260391057 INK DRY NP-3325/3825
N CT 1 2 1
Cannon copier.

260368931 INK DRY XEROX 1065 XT-65
N CT 1 2 1

260322615 INK DRY XT-25
N CT 1 1 1

260322656 INK DRY XT-36
N CT 1 1 1

INK DRY

DISTRIBUTION SERVICES

PRODUCT IDENTIFIER		DESCRIPTION				
ITEM NUMBER	ORD. MULT.	SELL UNIT	STD. PKG. STOCK AVAILABILITY / PA	LEAD TIME	MIN. ORD.	A C
260322623 INK DRY XT-50						
N		CT	1	2	1	
260322649 INK DRY XT-75						
N		CT	1	1	1	
260411970 INK DRY XT-99						
N		CT Xerox.	1	2	1	

NETWORK SERVICES

INK PELLET

260347315 INK PELLET CARTRIDGE SI480						
N		SH	1	2	2	
Dataproducts 310145504 black.						

TOOLS

INK STAMP

401046909 INK STAMP R2880 BLACK 46M						
N		TU	1	4	32	
Stencil ink for Central Office use.						
401046925 INK STAMP R2883 VERMILION						
N		TU	1	10	12	
8 grams per tube.						

BUILDING JANITORIAL

INK STAMP PAD

400527016 INK STAMP PAD BLACK 2 OZ BOTTLE						
1185041	1	BT				
12 dozen per carton.						
260408182 INK STAMP PAD BLACK 2 OZ BOTTLE H-81						
N		BT	1	1	1	
Roll-on. NOW AVAILABLE THROUGH TOUCH-TONE ORDER ENTRY.						
401477401 INK STAMP PAD RED 2 OZ BOTTLE						
1185066	1	BT	IL 33	IN 33	MI 33	OH WI
280006768 INK STAMP PAD RED 2 OZ BOTTLE						
0001758	1	EA	IL	IN	MI	OH WI
NOW AVAILABLE THROUGH TOUCH-TONE ORDER ENTRY.						
260408083 INK STAMP PAD RED 2 OZ BOTTLE H-78						
N		BT	1	1	1	
Roll-on. NOW AVAILABLE THROUGH TOUCH-TONE ORDER ENTRY.						

AUTOMOTIVE

FORMS/OFFICE SUPPLIES

KIT

300097136 KIT RLK LABEL 4396						
N		KT	1	3	1	
KIT SECURITY COMPONENT LOCK						
0001922	1	EA				

GENERAL

DATA VOICE

PRODUCT IDENTIFIER		DESCRIPTION				
ITEM NUMBER	ORD. MULT.	SELL UNIT	STD. PKG. STOCK AVAILABILITY / PA	LEAD TIME	MIN. ORD.	A C

KNIFE

260408281 KNIFE LEWIS SWISS B-38						
N		EA	1	1	1	
NOW AVAILABLE THROUGH TOUCH-TONE ORDER ENTRY.						
260408588 KNIFE X-ACTO A-26						
N		PK	1	1	1	
5 3/8IN long replacement blade. NOW AVAILABLE THROUGH TOUCH-TONE ORDER ENTRY.						
260408489 KNIFE X-ACTO B-37						
N		EA	1	1	1	
5 3/8IN long barrel. NOW AVAILABLE THROUGH TOUCH-TONE ORDER ENTRY.						

LABEL

280005737 LABEL 1 X 1 1/2 (500/PK)						
0001542	1	PK				
Removeable. NOW AVAILABLE THROUGH TOUCH-TONE ORDER ENTRY.						
280005745 LABEL 1 X 3 (250/PK)						
0001543	1	PK	IL	IN	MI	OH WI
Removeable. NOW AVAILABLE THROUGH TOUCH-TONE ORDER ENTRY.						
280005752 LABEL 4 X 2 (120/PK)						
0001544	1	PK	IL	IN	MI	OH WI
Removeable. NOW AVAILABLE THROUGH TOUCH-TONE ORDER ENTRY.						
280005760 LABEL 5 X 3 (40/PK)						
0001545	1	PK	IL	IN	MI	OH WI
Removeable. NOW AVAILABLE THROUGH TOUCH-TONE ORDER ENTRY.						
260364146 LABEL 3 1/2 X 15/16 1-UP						
N		EA	1	2	1000	
31-35-1 Non-removeable.						
260364153 LABEL 3 1/2 X 15/16 FACSIMILE						
N		EA	1	2	1000	
1-UP PS350-1						
260364161 LABEL 3 1/2 X 15/16 P35 EDP						
N		EA	1	2	1000	
Pressure sensitive 1-wide single.						
260322912 LABEL 3.15IN X 5IN CAT 044880						
1943134	1	RO	IL	IN	MI	OH WI
Duratherm buff, 8 rolls per carton, P/N044880. ADC ORDER ITEM ONLY.						
260322904 LABEL 3.5 IN X 1IN CAT 045490						
N		RO	28	2	28	
ADC ORDER ITEM ONLY.						

LABEL CLASSIFICATION

PRODUCT IDENTIFIER							DESCRIPTION						
ITEM NUMBER	ORD. MULT.	SELL UNIT	STD. PKG.	LEAD TIME	MIN. ORD.	A C	ITEM NUMBER	ORD. MULT.	SELL UNIT	STD. PKG.	LEAD TIME	MIN. ORD.	A C
300014255 LABEL 4079S TAGGING													
N		BG	1	2	1		Bag of 120.						
260408984 LABEL ADDRESS SELF-ADHESIVE 5380 B-49													
N		SH	1	1	1		200 per box.						
300027281 LABEL ADDRESS XL-400													
N		BX	1	2	1								
260419411 LABEL BAR CODE PRINTER - PICS													
1974279	1	FL	IL IN MI OH WI										
				33	33		1 1/2 X 3IN, 3891040.						
401341037 LABEL BLANK 4IN X 1 1/2IN S6424													
7431361	1	BX	IL IN MI OH WI										
				04			4 labels per sheet, 40 sheets per box.						
280032095 LABEL BRADY W019													
N		SH	1	2	1								
280032103 LABEL BRADY W024													
N		SH	1	2	1								
842372229 LABEL CLEI MC5A00 842272229													
N		EA	1	5	1								
842372237 LABEL CLEI MC5A00 842372237													
N		EA	1	5	1								
260409081 LABEL CONFIDENTIAL 1/2IN X 1 3/4IN J-48													
N		PK	1	1	1		NOW AVAILABLE THROUGH TOUCH TONE ORDER ENTRY.						
260386040 LABEL CONFIDENTIAL 3IN X 1IN													
1963611	1	RO	IL IN MI OH WI										
				33			Core Litho gloss pressure sensitive removable labels, FC190R, red words.						
280051681 LABEL COPIER 1 X 2 3/4													
0001548	1	BX	IL IN MI OH WI				100 sheets/box. NOW AVAILABLE THROUGH TOUCH-TONE ORDER ENTRY.						
840954531 LABEL DESIGN 840954531													
N		EA	1	8	1								
840954549 LABEL DESIGN 840954549													
N		EA	1	8	1								
843768698 LABEL DESIGN 843768698													
N		EA	1	14	1								
843768706 LABEL DESIGN 843768706													
N		EA	1	14	1								

PRODUCT IDENTIFIER							DESCRIPTION						
ITEM NUMBER	ORD. MULT.	SELL UNIT	STD. PKG.	LEAD TIME	MIN. ORD.	A C	ITEM NUMBER	ORD. MULT.	SELL UNIT	STD. PKG.	LEAD TIME	MIN. ORD.	A C
280005695 LABEL DOT 1/4IN GREEN													
0001538	1	PK	IL IN MI OH WI				450 per box. NOW AVAILABLE THROUGH TOUCH-TONE ORDER ENTRY.						
280005703 LABEL DOT 1/4IN RED													
0001539	1	PK	IL IN MI OH WI				450 per box. NOW AVAILABLE THROUGH TOUCH-TONE ORDER ENTRY.						
260345137 LABEL HECI BAR CODE													
1950923	5000	EA	IL IN MI OH WI										
				33									
280080060 LABEL MAG TAPE REEL													
1936302	1	BX	IL IN MI OH WI										
				33									
260380274 LABEL NFPA 4IN X 4 3/4IN													
1971259	1	EA	IL IN MI OH WI										
				33			Package of 100.						
260384664 LABEL PINFEED 12770													
N		BX	1	2	1		Peel off with blue border.						
260386032 LABEL PRIVATE													
1963603	1	RO	IL IN MI OH WI										
				33	33		Core Litho gloss pressure sensitive removable labels, FC190R, 3in x 1in, red words.						
280032301 LABEL PS350 SELF-ADHESIVE													
N		BX	1	2	1		15/16in x 3 1/2in.						
260409289 LABEL RECTANGULAR 2IN X 4IN WHITE B-56													
N		PK	1	1	1		Removable, AV-56432, 120 per package.						
260325386 LABEL TEL INSERT TIE													
N		EA	1	4	1		88157.						
260421185 LABEL WARNING FIBER OPTIC													
N		CT	500	2	1		Carton of 500.						
401342340 LABEL WRITE/ON W024 14/CARD													
1196683	1	CD	IL IN MI OH WI										
				33									
280005729 LABEL 'CONFIDENTIAL'													
0001541	1	PK	IL IN MI OH WI				125 per package. NOW AVAILABLE THROUGH TOUCH-TONE ORDER ENTRY.						
LABEL CLASSIFICATION													
280032111 LABEL CLASSIFICATION 1277-00													
N		RO	1	2	1		Pink.						

DISTRIBUTION SERVICES
 NETWORK SERVICES
 TOOLS
 BUILDING JANITORIAL
 AUTOMOTIVE
 FORMS/OFFICE SUPPLIES
 GENERAL
 DATA VOICE

LABEL CLASSIFICATION

DISTRIBUTION SERVICES

PRODUCT IDENTIFIER		DESCRIPTION				
ITEM NUMBER	ORD. MULT.	SELL UNIT	STD. PKG. STOCK AVAILABILITY / PA	LEAD TIME	MIN. ORD.	A C

280032129 LABEL CLASSIFICATION 1277-01
 N RO 1 2 1
 Red.

NETWORK SERVICES

280032137 LABEL CLASSIFICATION 1277-02
 N RO 1 2 1
 Light orange.

280032145 LABEL CLASSIFICATION 1277-03
 N RO 1 2 1
 Dark orange.

TOOLS

280032152 LABEL CLASSIFICATION 1277-06
 N RO 1 2 1
 Blue.

LABEL GUMMED

400648036 LABEL GUMMED 3 13/16IN X 1 9/16IN B104
 N CT 1 2 11
 Red or blue border.

LABEL NUMERIC

280032202 LABEL NUMERIC 1282-00
 N BX 1 2 1

280032210 LABEL NUMERIC 1282-01
 N BX 1 2 1

280032228 LABEL NUMERIC 1282-02
 N BX 1 2 1

280032236 LABEL NUMERIC 1282-03
 N BX 1 2 1

280032244 LABEL NUMERIC 1282-04
 N BX 1 2 1

280032251 LABEL NUMERIC 1282-05
 N BX 1 2 1

280032269 LABEL NUMERIC 1282-06
 N BX 1 2 7

280032277 LABEL NUMERIC 1282-07
 N BX 1 2 7

280032285 LABEL NUMERIC 1282-08
 N BX 1 2 1

280032293 LABEL NUMERIC 1282-09
 N BX 1 2 1

BUILDING JANITORIAL

AUTOMOTIVE

FORMS/OFFICE SUPPLIES

GENERAL

DATA VOICE

PRODUCT IDENTIFIER		DESCRIPTION				
ITEM NUMBER	ORD. MULT.	SELL UNIT	STD. PKG. STOCK AVAILABILITY / PA	LEAD TIME	MIN. ORD.	A C

LABEL SELF ADHESIVE

260409487 LABEL SELF ADHESIVE ROUND DARK BLUE B-42

N PK 1 1 1
 1000 per package, 3/4IN diameter. NOW AVAILABLE THROUGH TOUCH-TONE ORDER ENTRY.

260409784 LABEL SELF ADHESIVE ROUND GREEN B-45

N PK 1 1 1
 1000 per package, 3/4IN diameter. NOW AVAILABLE THROUGH TOUCH TONE ORDER ENTRY.

260409388 LABEL SELF ADHESIVE ROUND LITE BLUE B-41

N PK 1 1 1
 1000 per package, 3/4IN diameter. NOW AVAILABLE THROUGH TOUCH TONE ORDER ENTRY.

260409883 LABEL SELF ADHESIVE ROUND ORANGE B-46

N PK 1 1 1
 1000 per package, 3/4IN diameter. NOW AVAILABLE THROUGH TOUCH TONE ORDER ENTRY.

260409982 LABEL SELF ADHESIVE ROUND RED B-48

N PK 1 1 1
 1000 per package, 3/4IN diameter. NOW AVAILABLE THROUGH TOUCH TONE ORDER ENTRY.

260409586 LABEL SELF ADHESIVE ROUND WHITE B-43

N PK 1 1 1
 1000 per package, 3/4IN diameter. NOW AVAILABLE THROUGH TOUCH-TONE ORDER ENTRY.

260409685 LABEL SELF ADHESIVE ROUND YELLOW B-44

N PK 1 1 1
 1000 per package, 3/4IN diameter. NOW AVAILABLE THROUGH TOUCH-TONE ORDER ENTRY.

LAMP

280032319 LAMP 78-8012-3601-5 150W 20V

N EA 1 2 1

260429501 LAMP DDS

N EA 1 2 1

260380357 LAMP EVC

N EA 1 2 1

260380316 LAMP FCS

N EA 1 2 1

PRODUCT IDENTIFIER		DESCRIPTION				
ITEM NUMBER	ORD. MULT.	SELL UNIT	STD. PKG. STOCK AVAILABILITY / PA	LEAD TIME	MIN. ORD.	A C
260380324	N	EA	1	2	1	
LAMP FML						
280015587	N	EA	1	2	1	
LAMP PROJECTOR FCS 150W 24V						
280055856	N	EA	1	2	1	
LAMP REPLACEMENT DED PHILLIPS						
280054586	N	EA	1	2	1	
LAMP REPLACEMENT FKY PHILLIPS For Micron 720.						

LEAD DRAWING

260410386	N	TU	1	1	1	
LEAD DRAWING TURQUOISE 2H B-53 12 per tube.						
260410188	N	TU	1	1	1	
LEAD DRAWING TURQUOISE 3H B-50 12 per tube.						

LEAD MECHANICAL

260410584	N	TU	1	1	1	
LEAD MECHANICAL FABER .9MM H B-71 NOW AVAILABLE THROUGH TOUCH TONE ORDER ENTRY.						
260410683	N	TU	1	1	1	
LEAD MECHANICAL FABER .9MM HB B-72						
260410485	N	TU	1	1	1	
LEAD MECHANICAL FABER .9MM 2H B-70 Faber Castell. NOW AVAILABLE THROUGH TOUCH TONE ORDER ENTRY.						
280006180	0001712	1	TU	IL IN MI OH WI		
LEAD MECHANICAL PENTEL .5MM B NOW AVAILABLE THROUGH TOUCH-TONE ORDER ENTRY.						
260432315	0001799	1	TU	IL IN MI OH WI		
LEAD MECHANICAL PENTEL .5MM F NOW AVAILABLE THROUGH TOUCH-TONE ORDER ENTRY.						
280006198	0001713	1	TU	IL IN MI OH WI		
LEAD MECHANICAL PENTEL .5MM H NOW AVAILABLE THROUGH TOUCH-TONE ORDER ENTRY.						
260410980	N	TU	1	1	1	
LEAD MECHANICAL PENTEL .5MM H H-96						
280006206	0001714	1	TU	IL IN MI OH WI		
LEAD MECHANICAL PENTEL .5MM HB NOW AVAILABLE THROUGH TOUCH-TONE ORDER ENTRY.						

PRODUCT IDENTIFIER		DESCRIPTION				
ITEM NUMBER	ORD. MULT.	SELL UNIT	STD. PKG. STOCK AVAILABILITY / PA	LEAD TIME	MIN. ORD.	A C
260410782	N	TU	1	1	1	
LEAD MECHANICAL PENTEL .5MM HB B-73 NOW AVAILABLE THROUGH TOUCH TONE ORDER ENTRY.						
280006214	0001715	1	TU	IL IN MI OH WI		
LEAD MECHANICAL PENTEL .5MM RED NOW AVAILABLE THROUGH TOUCH TONE ORDER ENTRY.						
260432448	0001835	1	TU	IL IN MI OH WI		
LEAD MECHANICAL PENTEL .5MM 2B NOW AVAILABLE THROUGH TOUCH TONE ORDER ENTRY.						
260410881	N	TU	1	1	1	
LEAD MECHANICAL PENTEL .5MM 2B H-95 NOW AVAILABLE THROUGH TOUCH-TONE ORDER ENTRY.						
260432455	0001836	1	TU	IL IN MI OH WI		
LEAD MECHANICAL PENTEL .5MM 2H NOW AVAILABLE THROUGH TOUCH-TONE ORDER ENTRY.						
260408091	N	TU	1	1	1	
LEAD MECHANICAL PENTEL .5MM 2H H-97 NOW AVAILABLE THROUGH TOUCH-TONE ORDER ENTRY.						
260408190	N	TU	1	1	1	
LEAD MECHANICAL PENTEL .5MM 3H H-98						
260408299	N	TU	1	1	1	
LEAD MECHANICAL PENTEL .5MM 5H I-01						
260408497	N	TU	1	1	1	
LEAD MECHANICAL PENTEL .7MM H I-04						
260408398	N	TU	1	1	1	
LEAD MECHANICAL PENTEL .7MM HB I-03 NOW AVAILABLE THROUGH TOUCH-TONE ORDER ENTRY.						
260408596	N	TU	1	1	1	
LEAD MECHANICAL PENTEL .7MM 2H I-05 NOW AVAILABLE THROUGH TOUCH-TONE ORDER ENTRY.						
260408992	N	TU	1	1	1	
LEAD MECHANICAL SCRIPTO 1.1MM I-38						
260408695	N	TU	1	1	1	
LEAD MECHANICAL SCRIPTO .036 B-66 BLACK B.						
260410089	N	TU	1	1	1	
LEAD .9MM PE-50-9-HB BLACK B-57						

DISTRIBUTION SERVICES

NETWORK SERVICES

TOOLS

BUILDING JANITORIAL

AUTOMOTIVE

FORMS/OFFICE SUPPLIES

GENERAL

DATA VOICE

DISTRIBUTION SERVICES	LEAD PENCIL							PRODUCT IDENTIFIER DESCRIPTION							
	ITEM	ORD.	SELL	STD. PKG.	LEAD TIME	MIN.	A	ITEM	ORD.	SELL	STD. PKG.	LEAD TIME	MIN.	A	
	NUMBER	MULT.	UNIT	STOCK AVAILABILITY / PA		ORD.	C	NUMBER	MULT.	UNIT	STOCK AVAILABILITY / PA		ORD.	C	
NETWORK SERVICES	LEAD PENCIL							280032871							
	900217134							N		PK	1	2		1	
		N	TU	1			1								
					24 per tube long.										
TOOLS	900217142							280032889							
	1187278	1	TU	IL	IN	MI	OH	N		PK	1	2		1	
				33											
BUILDING JANITORIAL	900217100							280032897							
	1199141	1	TU	IL	IN	MI	OH	N		PK	1	2		1	
				33											
AUTOMOTIVE	900217183							280032905							
		N	TU	72		3	72	N		PK	1	2		1	
					24 per tube.										
FORMS/OFFICE SUPPLIES	401799010							280032913							
		N	TU	1			1	N		PK	1	2		1	
					24 per tube.										
GENERAL	LETTER OPENER							LINK							
	SEE OPENER LETTER.							260409099							
								N		BX	1	1		1	
DATA VOICE	LETTERHEAD							LOG DRIVERS							
	300096740							260336417							
		N	EA	500		2	500	1947846	1	SE					
GENERAL	300096757							LUBRICANT							
		N	EA	500		2	500	300024551							
					24 per tube.			N		EA	1	2		1	
GENERAL	300096690							260322680							
		N	EA	500		2	500	N		CT	1	2		1	
					24 per tube.										
GENERAL	300099934							MAGNIFIER							
	1932400	500	SH	IL	IN	MI	OH	260432471							
				33				0001986		EA					
GENERAL	LETTERING NUMERICAL							MANUAL							
	280032822							300025707							
		N	PK	1		2	1	N		EA	12	4		12	
GENERAL	280032830							300025582							
		N	PK	1		2	1	1308833	1	EA	IL	IN	MI	OH	WI
					24 per tube.						33	33			
GENERAL	280032848							300025715							
		N	PK	1		2	1	1308908	1	EA	IL	IN	MI	OH	WI
					24 per tube.						33	33	33		
GENERAL	280032855							260338025							
		N	PK	1		2	1	N		EA	1	2		1	
					24 per tube.						6th edition, spiral.				

PRODUCT IDENTIFIER		DESCRIPTION				
ITEM NUMBER	ORD. MULT.	SELL UNIT	STD. PKG. STOCK AVAILABILITY / PA	LEAD TIME	MIN. ORD.	A C
260325543 MANUAL HARDWARE TIE 01841HW001						
N		EA	1	4	1	
260325535 MANUAL SOFTWARE TIE 01841SW001						
N		EA	1	4	1	
MAP						
280033051 MAP KENOSHA & RACINE COUNTY						
N		EA	1	2	1	
Street Guide.						
MAP LATA 8 1/2IN X 11IN						
0007682	1	EA				
MAP LATA 11IN X 17IN						
0007683	1	EA				
280033077 MAP MILWAUKEE & WAUKESHA COUNTY						
N		EA	1	2	1	
Street Guide.						
280033085 MAP NORTHEASTERN WISCONSIN						
N		EA	1	2	1	
Tear resistant.						
280033093 MAP NORTHWESTERN WISCONSIN						
N		EA	1	2	1	
280033101 MAP SOUTHEASTERN WISCONSIN						
N		EA	1	2	1	
Tear resistant.						
280033119 MAP SOUTHWESTERN WISCONSIN						
N		EA	1	2	1	
260436852 MAP WISCONSIN STATE HIGHWAY						
N		EA	1	2	1	
Rand McNally.						
MARKER						
402734834 MARKER 272 MARKO RED						
1435503	12	EA				
Large tip, permanent ink.						
402734875 MARKER 276 MARKO YELLOW						
N		DZ	1	3	60	
402734883 MARKER 278 MARKO BROWN						
N		DZ	1	3	12	
402661490 MARKER 861 PAPER MATE BLUE						
N		DZ	1	3	60	
402661524 MARKER 864 PAPER MATE GREEN						
N		DZ	1	2	1	
402661557 MARKER 868 PAPER MATE BROWN						
N		EA	1			

PRODUCT IDENTIFIER		DESCRIPTION				
ITEM NUMBER	ORD. MULT.	SELL UNIT	STD. PKG. STOCK AVAILABILITY / PA	LEAD TIME	MIN. ORD.	A C
280006347 MARKER BOLDLINER MEDIUM BLACK						
0001728	1	DZ	IL IN MI OH WI			
NOW AVAILABLE THROUGH TOUCH-TONE ORDER ENTRY.						
280006354 MARKER BOLDLINER MEDIUM BLUE						
0001729	1	DZ	IL IN MI OH WI			
NOW AVAILABLE THROUGH TOUCH-TONE ORDER ENTRY.						
280006362 MARKER BOLDLINER MEDIUM RED						
0001730	1	DZ	IL IN MI OH WI			
NOW AVAILABLE THROUGH TOUCH-TONE ORDER ENTRY.						
402734842 MARKER BROAD TIP PERMANENT INK						
N		DZ	1	2	1	
Large M6 black.						
401445762 MARKER CABLE PWC						
5390948	1	PK	IL IN MI OH WI 33 33			
Package of 3.						
401464243 MARKER CHINA 2663 BLACK 77						
2207100	1	EA	IL IN MI OH WI 33 33			
260334339 MARKER DRY ERASE 4-COLOR SET						
0001822	1	SE	IL IN MI OH WI			
BLACK, BLUE, RED, GREEN. NOW AVAILABLE THROUGH TOUCH-TONE ORDER ENTRY.						
260334354 MARKER DRY ERASE BLACK STABILO						
0001820	1	EA	IL IN MI OH WI			
NOW AVAILABLE THROUGH TOUCH-TONE ORDER ENTRY.						
260334347 MARKER DRY ERASE BLUE STABILO						
0001821	1	EA	IL IN MI OH WI			
NOW AVAILABLE THROUGH TOUCH-TONE ORDER ENTRY.						
280012386 MARKER DRY ERASE FINE POINT 4-COLOR						
0001824	1	SE	IL IN MI OH WI			
BLACK-RED-BLUE-GREEN. NOW AVAILABLE THROUGH TOUCH-TONE ORDER ENTRY.						
260414107 MARKER DRYBOARD EXPO 4COLOR K-17						
N		EA	1	1	1	
260410295 MARKER DRYBOARD EXPO BLACK K-37						
N		EA	1	1	1	
Broad tip. NOW AVAILABLE THROUGH TOUCH-TONE ORDER ENTRY.						
260410493 MARKER DRYBOARD EXPO BLUE K-39						
N		EA	1	1	1	
NOW AVAILABLE THROUGH TOUCH TONE ORDER ENTRY.						

DISTRIBUTION SERVICES

NETWORK SERVICES

TOOLS

BUILDING JANITORIAL

AUTOMOTIVE

FORMS/OFFICE SUPPLIES

GENERAL

DATA VOICE

DISTRIBUTION SERVICES

NETWORK SERVICES

TOOLS

BUILDING JANITORIAL

AUTOMOTIVE

FORMS/OFFICE SUPPLIES

GENERAL

DATA VOICE

MARKER

PRODUCT IDENTIFIER		DESCRIPTION				
ITEM NUMBER	ORD. MULT.	SELL UNIT	STD. PKG. STOCK AVAILABILITY / PA	LEAD TIME	MIN. ORD.	A C

260410998 MARKER DRYBOARD EXPO BROWN K-15
N EA 1 1 1
NOW AVAILABLE THROUGH TOUCH TONE ORDER ENTRY.

260410691 MARKER DRYBOARD EXPO GREEN K-40
N EA 1 1 1
NOW AVAILABLE THROUGH TOUCH TONE ORDER ENTRY.

260410899 MARKER DRYBOARD EXPO ORANGE K-14
N EA 1 1 1
NOW AVAILABLE THROUGH TOUCH-TONE ORDER ENTRY.

260414008 MARKER DRYBOARD EXPO PURPLE K-16
N EA 1 1 1
NOW AVAILABLE THROUGH TOUCH TONE ORDER ENTRY.

260410394 MARKER DRYBOARD EXPO RED K-38
N EA 1 1 1
Broad tip. NOW AVAILABLE THROUGH TOUCH TONE ORDER ENTRY.

260410790 MARKER DRYBOARD EXPO YELLOW K-13
N EA 1 1 1
NOW AVAILABLE THROUGH TOUCH TONE ORDER ENTRY.

401979281 MARKER EXPRESSO 39001 BLACK
N BX 1 2 1
Sanford.

401979299 MARKER EXPRESSO 39002 RED
N BX 1 2 1
Part SN 22901.

400525671 MARKER FELT TIP WRITER BLACK
N DZ 1 2 1
Extra fine slim.

400525689 MARKER FELT TIP WRITER RED
N DZ 1 2 1
Extra fine slim.

280006305 MARKER FINELINER BLACK
0001724 1 DZ IL IN MI OH WI
NOW AVAILABLE THROUGH TOUCH-TONE ORDER ENTRY.

280006313 MARKER FINELINER BLUE
0001725 1 DZ IL IN MI OH WI
NOW AVAILABLE THROUGH TOUCH-TONE ORDER ENTRY.

280006321 MARKER FINELINER GREEN
0001726 1 DZ IL IN MI OH WI
NOW AVAILABLE THROUGH TOUCH-TONE ORDER ENTRY.

PRODUCT IDENTIFIER		DESCRIPTION				
ITEM NUMBER	ORD. MULT.	SELL UNIT	STD. PKG. STOCK AVAILABILITY / PA	LEAD TIME	MIN. ORD.	A C

280006339 MARKER FINELINER RED
0001727 1 DZ IL IN MI OH WI
NOW AVAILABLE THROUGH TOUCH-TONE ORDER ENTRY.

260414206 MARKER HEAVY DUTY BLACK B-86
N EA 1 1 1
Permanent ink. NOW AVAILABLE THROUGH TOUCH TONE ORDER ENTRY.

260414305 MARKER HEAVY DUTY BLUE B-87
N EA 1 1 1
Permanent ink. NOW AVAILABLE THROUGH TOUCH TONE ORDER ENTRY.

260414404 MARKER HEAVY DUTY BROWN B-88
N EA 1 1 1
Permanent ink. NOW AVAILABLE THROUGH TOUCH TONE ORDER ENTRY.

260414503 MARKER HEAVY DUTY GREEN B-89
N EA 1 1 1
Permanent ink. NOW AVAILABLE THROUGH TOUCH TONE ORDER ENTRY.

260414909 MARKER HEAVY DUTY ORANGE B-93
N EA 1 1 1
Permanent ink. NOW AVAILABLE THROUGH TOUCH TONE ORDER ENTRY.

260414800 MARKER HEAVY DUTY PURPLE B-92
N EA 1 1 1
Permanent ink. NOW AVAILABLE THROUGH TOUCH TONE ORDER ENTRY.

260414602 MARKER HEAVY DUTY RED B-90
N EA 1 1 1
Permanent ink. NOW AVAILABLE THROUGH TOUCH TONE ORDER ENTRY.

260414701 MARKER HEAVY DUTY YELLOW B-91
N EA 1 1 1
Permanent ink. NOW AVAILABLE THROUGH TOUCH TONE ORDER ENTRY.

260415500 MARKER HI LITER FELT TIPPED BLUE I-23
N EA 1 1 1
NOW AVAILABLE THROUGH TOUCH TONE ORDER ENTRY.

260415104 MARKER HI LITER FELT TIPPED GREEN B-75
N EA 1 1 1

260415401 MARKER HI LITER FELT TIPPED PINK I-22
N EA 1 1 1

260415302 MARKER HI LITER FELT TIPPED YELLOW B-76
N EA 1 1 1
NOW AVAILABLE THROUGH TOUCH TONE ORDER ENTRY.

260415203 MARKER HI LITER FELT TIPPED YELLOW J-67
N EA 1 1 1
Brite Liner.

PRODUCT IDENTIFIER		DESCRIPTION				
ITEM NUMBER	ORD. MULT.	SELL UNIT	STD. PKG. STOCK AVAILABILITY / PA	LEAD TIME	MIN. ORD.	A C
260415609		MARKER HI LITER PEN BLUE J-68				
N		EA	1	1	1	
260415708		MARKER HI LITER PEN YELLOW J-69				
N		EA	1	1	1	
402661516		MARKER PAPERMATE 863 BLACK				
N		DZ	1	2	1	
260415807		MARKER PEN FELT TIPPED FINE BLACK B-77				
N		EA	1	1	1	
Papermate. NOW AVAILABLE THROUGH TOUCH TONE ORDER ENTRY.						
260415906		MARKER PEN FELT TIPPED FINE BLUE B-78				
N		EA	1	1	1	
Papermate. NOW AVAILABLE THROUGH TOUCH TONE ORDER ENTRY.						
260416003		MARKER PEN FELT TIPPED FINE BROWN B-79				
N		EA	1	1	1	
Papermate. NOW AVAILABLE THROUGH TOUCH TONE ORDER ENTRY.						
260416102		MARKER PEN FELT TIPPED FINE GREEN B-80				
N		EA	1	1	1	
Papermate. NOW AVAILABLE THROUGH TOUCH TONE ORDER ENTRY.						
260416409		MARKER PEN FELT TIPPED FINE ORANGE B-84				
N		EA	1	1	1	
Papermate. NOW AVAILABLE THROUGH TOUCH TONE ORDER ENTRY.						
260416300		MARKER PEN FELT TIPPED FINE PURPLE B-83				
N		EA	1	1	1	
Papermate. NOW AVAILABLE THROUGH TOUCH TONE ORDER ENTRY.						
260416201		MARKER PEN FELT TIPPED FINE RED B-81				
N		EA	1	1	1	
Papermate.						
260416508		MARKER SHARPIE FINE BLACK B-87				
N		EA	1	1	1	
NOW AVAILABLE THROUGH TOUCH TONE ORDER ENTRY.						
260304217		MARKER SHARPIE XFINE BLACK				
0001788	1	DZ	IL IN MI OH WI			
NOW AVAILABLE THROUGH TOUCH-TONE ORDER ENTRY.						
260416607		MARKER SHARPIE XFINE BLACK B-58				
N		PK	1	1	1	
400525713		MARKER WRITER STYLE 150 BROWN				
8671289	12	EA	IL IN MI OH WI	33 33		
Extra fine slim.						

PRODUCT IDENTIFIER		DESCRIPTION				
ITEM NUMBER	ORD. MULT.	SELL UNIT	STD. PKG. STOCK AVAILABILITY / PA	LEAD TIME	MIN. ORD.	A C
280006222		MARKER 'EL MARKO' CHISEL BLACK				
0001716	1	EA	IL IN MI OH WI			
NOW AVAILABLE THROUGH TOUCH-TONE ORDER ENTRY.						
280006230		MARKER 'EL MARKO' CHISEL BLUE				
0001717	1	EA	IL IN MI OH WI			
NOW AVAILABLE THROUGH TOUCH-TONE ORDER ENTRY.						
280006248		MARKER 'EL MARKO' CHISEL BROWN				
0001718	1	EA	IL IN MI OH WI			
NOW AVAILABLE THROUGH TOUCH-TONE ORDER ENTRY.						
280006255		MARKER 'EL MARKO' CHISEL GREEN				
0001719	1	EA	IL IN MI OH WI			
NOW AVAILABLE THROUGH TOUCH-TONE ORDER ENTRY.						
280006263		MARKER 'EL MARKO' CHISEL ORANGE				
0001720	1	EA	IL IN MI OH WI			
NOW AVAILABLE THROUGH TOUCH-TONE ORDER ENTRY.						
280006271		MARKER 'EL MARKO' CHISEL PURPLE				
0001721	1	EA	IL IN MI OH WI			
NOW AVAILABLE THROUGH TOUCH-TONE ORDER ENTRY.						
280006289		MARKER 'EL MARKO' CHISEL RED				
0001722	1	EA	IL IN MI OH WI			
NOW AVAILABLE THROUGH TOUCH-TONE ORDER ENTRY.						
280006297		MARKER 'EL MARKO' CHISEL YELLOW				
0001723	1	EA	IL IN MI OH WI			
NOW AVAILABLE THROUGH TOUCH-TONE ORDER ENTRY.						

MICROFILM

260331038		MICROFILM DIAZO XIDEX DMC				
N		RO	2	1	2	
Duplicate 105mm x 1500ft x 5mil, white stripe.						
260331020		MICROFILM DIAZO XIDEX NO STRIPE				
N		RO	2	1	2	
Duplicate 105mm x 1500ft x 5mil.						
260406756		MICROFILM DRY SILVER 6600DP				
N		RL	6	2	6	
105mm x 100 meters x 4mil.						
260331137		MICROFILM ORIGINAL SILVER 63D1				
N		RO	2	2	20	
ARISXL Datagraphix.						

DISTRIBUTION SERVICES
 NETWORK SERVICES
 TOOLS
 BUILDING JANITORIAL
 AUTOMOTIVE
 FORMS/OFFICE SUPPLIES
 GENERAL
 DATA VOICE

MICROFILM

DISTRIBUTION SERVICES

PRODUCT IDENTIFIER							DESCRIPTION						
ITEM NUMBER	ORD. MULT.	SELL UNIT	STD. PKG. STOCK AVAILABILITY / PA	LEAD TIME	MIN. ORD.	A C							
260331145							MICROFILM ORIGINAL SILVER 64D1						
N		RO	2	2	20		ARIS II Datagraphix.						

NETWORK SERVICES

260331129							MICROFILM ORIGINAL SILVER FUGI						
N		RO	16	2	16		COM SE RL 91 105mm X 75m.						
260338322							MICROFILM VESICULAR SX NO STRIP						
N		RO	2	1	2								
260331053							MICROFILM VESICULAR SX XIDEX						
N		RO	2	1	2		Duplicate 105mm x 1500ft x 5mil, black stripe.						

TOOLS

MOISTENER

280004680							MOISTENER BOTTLE						
0001307	1	EA					NOW AVAILABLE THROUGH TOUCH-TONE ORDER ENTRY.						
001121763							MOISTENER ENVELOPE 15P						
N		EA	1		1								
260415559							MOISTENER FINGER SORTKWIK C-68						
N		EA	1	1	1		Gelatin compound. NOW AVAILABLE THROUGH TOUCH TONE ORDER ENTRY.						

BUILDING JANITORIAL

NAMEPLATE

260325592							NAMEPLATE BLACK ADHESIVE 1 1/2X9IN						
N		EA	1	1	1								
260325576							NAMEPLATE BLACK DS HD SI 1 1/2X9IN						
N		EA	1	1	1								
260301742							NAMEPLATE WALNUT DESK 2X8IN						
N		EA	1	1	1		Gold Holder.						
260301734							NAMEPLATE WALNUT NO HOLDER 2X8IN						
N		EA	1	1	1								
260325584							NAMEPLATE WALNUT WALL 2X8IN						
N		EA	1	1	1		Gold Holder.						

AUTOMOTIVE

FORMS/OFFICE SUPPLIES

GENERAL

NOTARY SEAL

280033358							NOTARY SEAL						
N		EA	1	2	1								

NOTES POST-IT

280006032							NOTES POST-IT 1 1/2 X 2IN YELLOW						
0001631	1	PK					12 per package. NOW AVAILABLE THROUGH TOUCH-TONE ORDER ENTRY.						

DATA VOICE

PRODUCT IDENTIFIER							DESCRIPTION						
ITEM NUMBER	ORD. MULT.	SELL UNIT	STD. PKG. STOCK AVAILABILITY / PA	LEAD TIME	MIN. ORD.	A C							

260416532							NOTES POST-IT 1 1/2 X 2IN YELLOW I-41						
N		DZ	1	1	1		NOW AVAILABLE THROUGH TOUCH TONE ORDER ENTRY.						

260304225							NOTES POST-IT 2 X 3IN BLUE						
0001642	1	EA	IL	IN	MI	OH	WI						
NOW AVAILABLE THROUGH TOUCH TONE ORDER ENTRY.													

260304233							NOTES POST-IT 2 X 3IN GREEN						
0001643	1	EA	IL	IN	MI	OH	WI						
NOW AVAILABLE THROUGH TOUCH TONE ORDER ENTRY.													

260304241							NOTES POST-IT 2 X 3IN PINK						
0001644	1	EA	IL	IN	MI	OH	WI						
NOW AVAILABLE THROUGH TOUCH TONE ORDER ENTRY.													

260304266							NOTES POST-IT 2 X 3IN WHITE						
0001645	1	EA	IL	IN	MI	OH	WI						
NOW AVAILABLE THROUGH TOUCH TONE ORDER ENTRY.													

260304258							NOTES POST-IT 2 X 3IN YELLOW						
0001641	1	EA	IL	IN	MI	OH	WI						
NOW AVAILABLE THROUGH TOUCH TONE ORDER ENTRY.													

280051731							NOTES POST-IT 3 X 3IN BLUE						
0001636	1	EA	IL	IN	MI	OH	WI						
NOW AVAILABLE THROUGH TOUCH TONE ORDER ENTRY.													

280051723							NOTES POST-IT 3 X 3IN GREEN						
0001637	1	EA	IL	IN	MI	OH	WI						
NOW AVAILABLE THROUGH TOUCH TONE ORDER ENTRY.													

280051715							NOTES POST-IT 3 X 3IN PINK						
0001638	1	EA	IL	IN	MI	OH	WI						
NOW AVAILABLE THROUGH TOUCH TONE ORDER ENTRY.													

280051707							NOTES POST-IT 3 X 3IN WHITE						
0001639	1	EA	IL	IN	MI	OH	WI						
NOW AVAILABLE THROUGH TOUCH TONE ORDER ENTRY.													

280006040							NOTES POST-IT 3 X 3IN YELLOW						
0001632	1	EA	IL	IN	MI	OH	WI						
NOW AVAILABLE THROUGH TOUCH TONE ORDER ENTRY.													

260416631							NOTES POST-IT 3 X 3IN YELLOW I-42						
N		PD	1	1	1		100 sheets per pad. NOW AVAILABLE THROUGH TOUCH TONE ORDER ENTRY.						

PRODUCT IDENTIFIER DESCRIPTION

ITEM	ORD.	SELL	STD. PKG.	LEAD TIME	MIN.	A
NUMBER	MULT.	UNIT	STOCK AVAILABILITY / PA	ORD.	ORD.	C

260355540 NOTES POST-IT 3 X 5IN RULED YELLOW
 0001979 1 PD IL IN MI OH WI
 NOW AVAILABLE THROUGH TOUCH TONE ORDER ENTRY.

280006057 NOTES POST-IT 3 X 5IN YELLOW
 0001833 1 EA IL IN MI OH WI
 NOW AVAILABLE THROUGH TOUCH TONE ORDER ENTRY.

260416730 NOTES POST-IT 3 X 5IN YELLOW I-43
 N PD 1 1 1

260416433 NOTES POST-IT 4 1/8 X 2 7/8 YELLOW J-84
 N EA 1 1 1
 Printed Routing/Request pads.

260416334 NOTES POST-IT 4 X 15/16IN K-08
 N EA 1 1 1
 For fax transmittal. NOW AVAILABLE THROUGH TOUCH TONE ORDER ENTRY.

260416938 NOTES POST-IT 4 X 6IN RULED CREAM J-41
 N PD 1 1 1

260304274 NOTES POST-IT 4 X 6IN RULED YELLOW
 0001646 1 EA IL IN MI OH WI
 NOW AVAILABLE THROUGH TOUCH-TONE ORDER ENTRY.

260416839 NOTES POST-IT 4 X 6IN RULED YELLOW J-40
 N PD 1 1 1

260304282 NOTES POST-IT 4 X 6IN YELLOW
 0001847 1 EA IL IN MI OH WI
 NOW AVAILABLE THROUGH TOUCH-TONE ORDER ENTRY.

260355292 NOTES POST-IT FAX MEMO
 0001928 1 PD IL IN MI OH WI
 NOW AVAILABLE THROUGH TOUCH TONE ORDER ENTRY.

260355276 TAPE FLAG REMOVEABLE WHITE
 0001978 1 PK IL IN MI OH WI
 Post-It Notes in dispenser. NOW AVAILABLE THROUGH TOUCH TONE ORDER ENTRY.

260414289 TAPE FLAGS REMOVABLE BLUE J-88
 N EA 1 1 1
 Post-It Notes in a dispenser. NOW AVAILABLE THROUGH TOUCH-TONE ORDER ENTRY.

260414388 TAPE FLAGS REMOVABLE GREEN J-89
 N EA 1 1 1
 Post-It Notes in a dispenser. NOW AVAILABLE THROUGH TOUCH-TONE ORDER ENTRY.

260414487 TAPE FLAGS REMOVABLE RED J-90
 N EA 1 1 1
 Post-It Notes in a dispenser. NOW AVAILABLE THROUGH TOUCH TONE ORDER ENTRY.

PRODUCT IDENTIFIER DESCRIPTION

ITEM	ORD.	SELL	STD. PKG.	LEAD TIME	MIN.	A
NUMBER	MULT.	UNIT	STOCK AVAILABILITY / PA	ORD.	ORD.	C

260414586 TAPE FLAGS REMOVABLE WHITE J-91
 N EA 1 1 1
 Post-It Notes in a dispenser. NOW AVAILABLE THROUGH TOUCH-TONE ORDER ENTRY.

260414685 TAPE FLAGS REMOVABLE YELLOW J-92
 N EA 1 1 1
 Post-It Notes in a dispenser. NOW AVAILABLE THROUGH TOUCH-TONE ORDER ENTRY.

260355516 TAPE FLAGS REMOVEABLE BLUE
 0001974 1 PK IL IN MI OH WI
 Post-It Notes in a dispenser. NOW AVAILABLE THROUGH TOUCH-TONE ORDER ENTRY.

260355284 TAPE FLAGS REMOVEABLE GREEN
 0001975 1 PK IL IN MI OH WI
 Post-It Notes in dispenser. NOW AVAILABLE THROUGH TOUCH TONE ORDER ENTRY.

260355532 TAPE FLAGS REMOVEABLE ORANGE
 0001976 1 PK IL IN MI OH WI
 Post-It Notes in a dispenser. NOW AVAILABLE THROUGH TOUCH-TONE ORDER ENTRY.

260355268 TAPE FLAGS REMOVEABLE RED
 0001973 1 PK IL IN MI OH WI
 Post-It Notes in dispenser. NOW AVAILABLE THROUGH TOUCH TONE ORDER ENTRY.

260355524 TAPE FLAGS REMOVEABLE YELLOW
 0001977 1 PK IL IN MI OH WI
 Post-It Notes in a dispenser. NOW AVAILABLE THROUGH TOUCH-TONE ORDER ENTRY.

NUMBER INDEX

300027273 NUMBER INDEX 1- 5 1/ 5 CUT
 8403493 SE

300027596 NUMBER INDEX 1-10 1/10 CUT
 8403451 SE IL IN MI OH WI
 33 33 33 33

300027604 NUMBER INDEX 1-15 1/15 CUT
 8403477 1 SE IL IN MI OH WI
 33 33 33 33

300027612 NUMBER INDEX 1-31 1/31 CUT
 8403485 SE IL IN MI OH WI
 33 33 33 33

OIL MACHINE

260429527 OIL MACHINE FOR PAPER SHREDDER
 N QT 1 2 1
 Quart Container.

DISTRIBUTION SERVICES

NETWORK SERVICES

TOOLS

BUILDING JANITORIAL

AUTOMOTIVE

FORMS/OFFICE SUPPLIES

GENERAL

DATA VOICE

OPENER LETTER

DISTRIBUTION SERVICES

PRODUCT IDENTIFIER		DESCRIPTION				
ITEM NUMBER	ORD. MULT.	SELL UNIT	STD. PKG. STOCK AVAILABILITY / PA	LEAD TIME	MIN. ORD.	A C

PRODUCT IDENTIFIER		DESCRIPTION				
ITEM NUMBER	ORD. MULT.	SELL UNIT	STD. PKG. STOCK AVAILABILITY / PA	LEAD TIME	MIN. ORD.	A C

OPENER LETTER

280009044 OPENER LETTER
 0001283 1 EA
 NOW AVAILABLE THROUGH TOUCH-TONE ORDER ENTRY.

401349428 OPENER LETTER BENT HANDLE
 N EA 1 3 72
 Commercial style, 9in long, offset handle.

260416805 OPENER LETTER STEEL B-95
 N EA 1 1 1
 NOW AVAILABLE THROUGH TOUCH TONE ORDER ENTRY.

ORGANIZER

280004987 ORGANIZER DESK ADD-A-FILE BEIGE
 0001277 1 EA
 NOW AVAILABLE THROUGH TOUCH-TONE ORDER ENTRY.

280004995 ORGANIZER DESK ADD-A-FILE BLACK
 0001278 1 EA IL IN MI OH WI
 NOW AVAILABLE THROUGH TOUCH-TONE ORDER ENTRY.

PAD PAPER

401351044 PAD PAPER CANARY 4 1/2IN X 6IN
 5651729 10 PD

401351051 PAD PAPER CANARY 5 1/2IN X 8 1/2IN
 5651745 1 PD IL IN MI OH WI
 33 33 33 33

400163440 PAD PAPER PINK 2 1/8IN X 3 1/8IN
 N PD 1 2 1
 100 sheets per pad bound with flex glue.

401357173 PAD PAPER PLAIN 10 7/8IN X 8 3/8IN
 1197236 10 PD IL IN MI OH WI
 33 33
 White, unruled paper, 100 sheets per pad.

280005935 PAD PAPER RULED 5 X 8IN CANARY
 0001618 1 PD IL IN MI OH WI
 NOW AVAILABLE THROUGH TOUCH TONE ORDER ENTRY.

280005943 PAD PAPER RULED 8-1/2 X 11IN CANARY
 0001619 1 PD IL IN MI OH WI

280005950 PAD PAPER RULED 8-1/2 X 14IN CANARY
 0001620 1 PD IL IN MI OH WI

NETWORK SERVICES

TOOLS

BUILDING JANITORIAL

AUTOMOTIVE

FORMS/OFFICE SUPPLIES

GENERAL

DATA VOICE

260414719 PAD PAPER RULED LEGAL BLUE J-70
 N EA 1 1 1
 8 1/2in X 11 3/4in.

260414412 PAD PAPER RULED LEGAL CANARY B-96
 N EA 1 1 1
 8-1/2 x 11-3/4IN. NOW AVAILABLE THROUGH TOUCH TONE ORDER ENTRY.

260414511 PAD PAPER RULED LEGAL CANARY B-97
 N EA 1 1 1
 8-1/2 X 14IN. NOW AVAILABLE THROUGH TOUCH TONE ORDER ENTRY.

260414610 PAD PAPER RULED LEGAL CANARY B-98
 N EA 1 1 1
 5 X 8IN. NOW AVAILABLE THROUGH TOUCH TONE ORDER ENTRY.

400527362 PAD PAPER RULED PUNCHED 7 HOLE
 N PD 60 14 360
 White, 8 1/2in X 11in.

400527347 PAD PAPER RULED UNPUNCHED
 N PD 1 10 360
 White, 8 1/2in x 11in, 100 sheets per pad.

401351226 PAD PAPER SCRATCH 2 1/2IN X 5IN
 4186049 100 PD IL IN MI OH WI
 33 33 33
 Pink, news print, 100 sheets per pad.

400163457 PAD PAPER SCRATCH 3 IN X 5IN
 1205641 1 PD IL IN MI OH WI
 33 33 33 33 33
 Plain white, news print, 100 sheets per pad.

280005976 PAD PAPER SCRATCH 3 IN X 5IN
 0001622 1 PD IL IN MI OH WI
 WHITE. NOW AVAILABLE THROUGH TOUCH-TONE ORDER ENTRY.

280005984 PAD PAPER SCRATCH 5 IN X 8IN
 0001623 1 PD IL IN MI OH WI
 White. NOW AVAILABLE THROUGH TOUCH-TONE ORDER ENTRY.

280005992 PAD PAPER SCRATCH 8 1/2IN X 11IN
 0001624 1 PD IL IN MI OH WI
 White. NOW AVAILABLE THROUGH TOUCH-TONE ORDER ENTRY.

400620015 PAD PAPER SCRATCH UNPUNCHED
 1179911 1 PD IL IN MI OH WI
 33 33 33 33
 5in X 8in.

401350970 PAD PAPER WHITE 2IN X 3IN
 5651661 1 PD IL IN MI OH WI
 33 33

401351028 PAD PAPER WHITE 3IN X 8 3/8IN
 1205609 14 CS IL IN MI OH WI
 33 33 33 33
 Unruled, 10 pads per pack.

PRODUCT IDENTIFIER		DESCRIPTION					
ITEM NUMBER	ORD. MULT.	SELL UNIT	STD. PKG.	LEAD TIME		MIN. ORD.	A C
			STOCK AVAILABILITY / PA				
001170265 PAD PAPER WHITE 5 1/2 X 8 1/2IN							
1205542	1	PD	IL	IN	MI	OH	WI
			33	33	33	33	33
Pad unruled.							
260355433 PAD QUADRILLE 5SQ 17IN X 11IN							
0001972	1	PD	IL	IN	MI	OH	WI
NOW AVAILABLE THROUGH TOUCH-TONE ORDER ENTRY.							
260382601 PAD RECYCLED RULED 8 1/2IN X 11IN							
1961607	1	PD	IL	IN	MI	OH	WI
			33	33	33	33	33
7 Hole Punch. 100 sheets per pad, 16#, white.							
260382619 PAD RECYCLED UNPUNCHED 8 1/2IN X 11IN							
1961615	1	PD	IL	IN	MI	OH	WI
			33	33	33	33	33
100 sheets per pad, 16#, white.							

PAD STAMP

280006735 PAD STAMP FOAM BLACK								
0001755	1	EA						
NOW AVAILABLE THROUGH TOUCH-TONE ORDER ENTRY.								
280006743 PAD STAMP FOAM RED								
0001756	1	EA	IL	IN	MI	OH	WI	
NOW AVAILABLE THROUGH TOUCH-TONE ORDER ENTRY.								
260415658 PAD STAMP FOAM RUBBER BLACK I-71								
N		EA	1		1		1	
3-1/4 X 6-1/4IN #2. NOW AVAILABLE THROUGH TOUCH TONE ORDER ENTRY.								
260415856 PAD STAMP FOAM RUBBER BLACK I-73								
N		EA	1		1		1	
4 1/4 X 7 1/2IN #3.								
260415757 PAD STAMP FOAM RUBBER RED I-72								
N		EA	1		1		1	
3-1/4 X 6-1/4IN #2. NOW AVAILABLE THROUGH TOUCH TONE ORDER ENTRY.								
260415955 PAD STAMP FOAM RUBBER RED I-74								
N		EA	1		1		1	
4 1/4 X 7 1/2IN #3.								
400488813 PAD STAMP INKED FELT 1 BLACK								
1205682	1	EA	IL	IN	MI	OH	WI	
			33	33	33	33	33	
2 3/4in X 4 1/2in X 1/2in.								
260334388 PAD STAMP MICROPORE BLACK								
0001901	1	EA	IL	IN	MI	OH	WI	
2-3/4IN X 4-1/2IN. NOW AVAILABLE THROUGH TOUCH-TONE ORDER ENTRY.								

PRODUCT IDENTIFIER		DESCRIPTION					
ITEM NUMBER	ORD. MULT.	SELL UNIT	STD. PKG.	LEAD TIME		MIN. ORD.	A C
			STOCK AVAILABILITY / PA				
260334370 PAD STAMP MICROPORE RED							
0001902	1	EA	IL	IN	MI	OH	WI
2-3/4IN X 4-1/2IN. NOW AVAILABLE THROUGH TOUCH-TONE ORDER ENTRY.							
280034828 PAD STAMP REPLACEMENT							
N		EA	1		2		1
Triumph Dater.							
280033465 PAD STAMP TRIUMPH SELF-INK							
N		EA	1		2		1
Dater 1 X 1 1/2.							

PAPER

300090958 PAPER 8 1/2 X 11 15# WH 1PLY							
N		CT	1		1		1
081009.							
300090966 PAPER 8 1/2 X 11 15# WH 2PLY							
N		CT	1		1		1
081002.							
260360888 PAPER 8 1/2 X 11 15# WH 3PLY							
N		CT	1		1		1
081000.							
260377502 PAPER 8 1/2 X 11 20# WH							
N		SH	500		1		500
BS20 # Ripple Nekoosa Bond, long grain.							
260377510 PAPER 8 1/2 X 11 20# WH							
N		SH	1		1		500
BS20 # Butler Perfecopy Bond, long grain.							
260377551 PAPER 8 1/2 X 11 60# NA							
N		SH	500		1		500
Nekoosa offset.							
260377494 PAPER 8 1/2 X 11 60# WH							
N		SH	100		1		100
BS60 # offset, Perm Mactac, Novelty Starliner, long grain.							
260377528 PAPER 8 1/2 X 11 60# WH							
N		SH	500		1		500
BS60 # Vellum Nekoosa Opaque offset, long grain.							
260377544 PAPER 8 1/2 X 11 70# TN							
N		SH	1		1		500
BS70 # Vellum Nekoosa Opaque offset, long grain.							
260377395 PAPER 8 1/2 X 11 90# WH							
N		SH	500		1		500
Springhill index, long grain.							
260408257 PAPER 8 1/2 X 5 1/2IN A-77							
N		PK	1		1		1
Filler, 100 sheets per package. NOW AVAILABLE THROUGH TOUCH-TONE ORDER ENTRY.							

DISTRIBUTION SERVICES

NETWORK SERVICES

TOOLS

BUILDING JANITORIAL

AUTOMOTIVE

FORMS/OFFICE SUPPLIES

GENERAL

DATA VOICE

DISTRIBUTION SERVICES
 NETWORK SERVICES
 TOOLS
 BUILDING JANITORIAL
 AUTOMOTIVE
 FORMS/OFFICE SUPPLIES
 GENERAL
 DATA VOICE

PAPER

PRODUCT IDENTIFIER		DESCRIPTION					
ITEM NUMBER	ORD. MULT.	SELL UNIT	STD. STOCK	PKG. AVAILABILITY / PA	LEAD TIME	MIN. ORD.	A C
260339205		PAPER	9 7/8 X 11 15# WH 1PLY				
N		BX	1		3	1	
Moore form 9710J.							
280093121		PAPER	11 X 8 1/2 18# WH 1PLY				
N		CT	1		2	1	
Premium bond, box, blank, no perf, WIL 110008.							
260334511		PAPER	12 X 8 1/2 15# WH 4PLY				
N		CT	900		2	1	
NCR.							
280093154		PAPER	12 X 8 1/2 18# WH 1PLY				
N		CT	1		2	1	
Premium bond, blank, no perf, wil 120008.							
260388269		PAPER	ARDOR WHITE OFFSET 60#				
N		SH	1000		1	5000	
Cut to 5 1/2in x 8 1/2in.							
200005494		PAPER	AVON BLT WH CLS CRST20LB				
N		SH	500		3	10000	
401353404		PAPER	BACK BLUE 8 1/2IN X 11IN				
5652164	250	SH	IL IN MI OH WI				
			33 33 33				
50lb unpunched.							
401353552		PAPER	BACK BLUE 8 7/8IN X 13IN				
N		SH	250		1	50000	
65lb unpunched.							
260364047		PAPER	CHAMPION COPYSOURCE DP				
N		SH	1		2	1	
8 1/2in x 11in, 20# white.							
260358312		PAPER	HP51630A				
N		PK	1		1	1	
260358460		PAPER	HP51630P				
N		PK	1		1	1	
260358320		PAPER	HP92261N				
N		CT	1		1	1	
260384615		PAPER	HP92261N 8 1/2 X 11 INK-JET				
N		BX	1		2	1	
Z-fold continuous.							
260338140		PAPER	IBM 3852/COLOR JET PRINTER				
N		PK	1		1	1	
Continuous form #1669310.							
260361365		PAPER	ID-560 2PLY WT-YE2 11/16				
1954107	1	RO	IL IN MI OH WI				
			31				
280053901		PAPER	MICRO-DESIGN 8-1/2 X 11IN				
N		EA	1		2	1	
Source cassette.							
280042821		PAPER	MICRO-DESIGN 11				
N		EA	1		1	1	
Com cassettes.							

PRODUCT IDENTIFIER		DESCRIPTION					
ITEM NUMBER	ORD. MULT.	SELL UNIT	STD. STOCK	PKG. AVAILABILITY / PA	LEAD TIME	MIN. ORD.	A C
280013624		PAPER	NCR CARBONLESS 6 PLY				
N		CT	1		2	1	
280033770		PAPER	PRINTER 21-1886 11 X 250				
N		CS	1		2	1	
F/RDR printer micron RP707.							
260344163		PAPER	PRINTER TI MD1 707 24/BX				
N		BX	1		2	1	
260408059		PAPER	RULED 6-3/4IN X 3-3/4IN A-76				
N		PK	1		1	1	
Filler, 50 sheets per package.							
260364104		PAPER	SHADE 70 14-7/8 X 11IN				
N		CT	1		2	1	
White 20#, 2700 per carton.							
260384599		PAPER	SHADE 77 14-7/8 X 11IN				
N		CT	1		2	1	
Green Bar, High Brite.							
260384112		PAPER	SHADE 4325 9-1/2 X 11IN				
N		CT	1		2	1	
3 perforations, white, LP, 2500 per case, clean.							
260353461		PAPER	THERMAL 856801				
N		CT	1		1	1	
300027679		PAPER	THERMAL ROLL 8-1/2 X 11IN				
N		CS	1		2	1	
280033820		PAPER	TRACING BLUE 340/10				
N		SH	100		2	100	
280033838		PAPER	TRACING GREEN 340-T15				
N		SH	100		2	3	
PAPER TYPING 20LB ERASABLE							
0001627	1	RM					
001136829		PAPER	UNPUNCHED 8-1/2 X 11IN WHITE				
N		SH	500		1	5000	
500 per package.							
260408158		PAPER	UNRULED 6.75IN X 3.75IN A-75				
N		PK	1		1	1	
Filler, 50 sheets per package, plain.							
260413174		PAPER	VERSATEC LOW HUMIDITY P416				
N		CT	1		2	1	
2 rolls per carton.							
260413158		PAPER	VERSATEC OPAQUE CE-4024-R				
N		CT	1		2	1	
2 rolls per carton.							
280413166		PAPER	VERSATEC OPAQUE CE-4036-R1				
N		CT	1		2	1	
1 roll per carton.							
300027653		PAPER	YELLOW PG-197-M18				
N		PD	1		2	1	

PRODUCT IDENTIFIER		DESCRIPTION				
ITEM NUMBER	ORD. MULT.	SELL UNIT	STD. PKG. STOCK AVAILABILITY / PA	LEAD TIME	MIN. ORD.	A C

PRODUCT IDENTIFIER		DESCRIPTION				
ITEM NUMBER	ORD. MULT.	SELL UNIT	STD. PKG. STOCK AVAILABILITY / PA	LEAD TIME	MIN. ORD.	A C

DISTRIBUTION SERVICES

PAPER ADDING MACHINE

401115134 PAPER ADDING MACHINE 2 1/4IN
 1208009 1 RO
 Adding machine rolls, 2 ply carbonless, NCR.

400499059 PAPER ADDING MACHINE 2 1/4IN
 5652107 1 RO
 IL IN MI OH WI
 33 33 33 33
 2 ply with carbon.

400389243 PAPER ADDING MACHINE 2 9/32IN
 1207985 1 RO
 IL IN MI OH WI
 33 33 33 33
 Plain roll for use on Burrough and other recommended Standard adding/listing machines.

260331707 PAPER ADDING MACHINE 3IN 1 PLY
 N RO 1 2 1

PAPER BOND

300027547 PAPER BOND 8 1/2 X 11 ARDOR WHITE
 8403253 1 SH

400180501 PAPER BOND 8 1/2 X 11 E630
 1110833 500 SH
 IL IN MI OH WI
 33 33 33 33
 Unpunched economy bond.

401711288 PAPER BOND 8 1/2 X 11 STRATHMORE
 N SH 1 2 1

401426689 PAPER BOND MEMO 3IN X 5IN
 6669283 1 SH
 IL IN MI OH WI
 33 33 33 33
 White, 500 Sheets per package, 80 packages per carton.

PAPER CALCULATOR

280033549 PAPER CALCULATOR
 N PK 1 2 1
 For Sharp EL1611, package of 5.

280033705 PAPER CALCULATOR
 N PK 1 2 1
 Model E8181, package of 5 rolls.

280033556 PAPER CALCULATOR LABEL ON BAP4
 N PK 1 2 1
 For Sharp calculator EL8181, 4 per package.

280033796 PAPER CALCULATOR PRINTING
 N EA 1 2 1
 Sharp EL-1182A.

280033531 PAPER CALCULATOR TP25000
 N EA 1 2 1
 For Texas Instrument TI-45.

PAPER CARBON

001185305 PAPER CARBON 8 1/2 X 11 1/2
 1167932 50 SH

401003967 PAPER CARBON A221
 1207480 50 SH
 IL IN MI OH WI
 33 33

300030210 PAPER CARBON DR 660 1112
 8404855 1 PD
 IL IN MI OH WI
 33 33 33 33
 50 sheets per package, 2 packages per box.

401353891 PAPER CARBON E350 5 1/2 X 8 1/2IN
 6668004 500 EA
 IL IN MI OH WI
 33 33

401353909 PAPER CARBON E350 8 1/2 X 13 1/2IN
 N BX 1 2 1
 Superior 3000 Exact

400527594 PAPER CARBON E353 8 1/2 X 11IN
 1207522 50 BX
 IL IN MI OH WI
 33 33 33 33
 100 sheets per package.

401353537 PAPER CARBON PEN 8 1/2 X 13 1/2IN
 4187666 50 SH
 IL IN MI OH WI
 33

NETWORK SERVICES

TOOLS

BUILDING JANITORIAL

PAPER CHART

280016155 PAPER CHART BLUE TRACE THERMAL
 N PD 1 2 1
 11-2925-30.

AUTOMOTIVE

PAPER CLEANING

995872330 PAPER CLEANING CK7188
 1207688 1 EN
 For cleaning the armatures and core faces of relays and ringers, 1/4in wide X 2 1/2in long, BSP 501-250-300. Package of 10.

FORMS/OFFICE SUPPLIES

PAPER CLIP

SEE CLIP PAPER.

PAPER COMPUTER

401407499 PAPER COMPUTER 8 1/2 X 5 1/2 1 15#
 1179879 1 CT
 Premium bond, blank, no perf, BOW 620653.

260376967 PAPER COMPUTER 8 1/2 X 5 1/2 1 18#
 N CT 1 2 1
 MI - Premium Bond, blank, no perfs, 320712.

GENERAL

DATA VOICE

PAPER COMPUTER

DISTRIBUTION SERVICES

PRODUCT IDENTIFIER DESCRIPTION

ITEM	ORD.	SELL	STD. PKG.	LEAD TIME	MIN.	A
NUMBER	MULT.	UNIT	STOCK AVAILABILITY / PA		ORD.	C

401407507 PAPER COMPUTER 8 1/2 X 5 1/2 2 15#
 N CT 1 3 1
 Blended, blank, carbonless, no perf, 8550Q 2PT.

NETWORK SERVICES

300025541 PAPER COMPUTER 8 1/2 X 11 1 15#
 N CT 1 2 1
 Premium bond, blank, no perf, BOW 620654.

260376975 PAPER COMPUTER 8 1/2 X 11 1 15#
 N CT 1 2 1
 Premium bond, blank, no perf, BOW 081997.

300075363 PAPER COMPUTER 8 1/2 X 11 1 15#
 N CT 1 2 1
 Premium bond, 1/2in greenbar, no perf, BOW 081107.

TOOLS

001045319 PAPER COMPUTER 8 1/2 X 11 1 15#
 4306704 3700 CT IL IN MI OH WI
 33 33 33 33 33
 Premium bond, 1/2in greenbar, no perf. BOW 081107.

BUILDING JANITORIAL

300074580 PAPER COMPUTER 8 1/2 X 11 1 15#
 1942078 1 CT IL IN MI OH WI
 33 33 33 33 33
 Premium bond, blank, no perf, BOW 620654.

300075058 PAPER COMPUTER 8 1/2 X 11 2 15#
 N CT 1 2 1
 Blended, blank, carbonless, no perf, 8510Q 2 PT.

AUTOMOTIVE

300072899 PAPER COMPUTER 8 1/2 X 11 2 15#
 N CT 1 2 1
 Blended, 1/2in green bar, carbonless, no perf, 8512TQ 2 PT.

280093055 PAPER COMPUTER 8 1/2 X 11 2 15#
 N CT 1 2 1
 Blended, 1/2in green bar, carbonless, no perf, 8512TQ 2 PT.

FORMS/OFFICE SUPPLIES

260376983 PAPER COMPUTER 8 1/2 X 11 2 16#
 N CT 1 2 1
 Blended, blank, carbonless, no perf, 8510Q 2 PT.

300075066 PAPER COMPUTER 8 1/2 X 11 3 15#
 N CT 1 2 1
 Blended, blank, carbonless, no perf, 8510Q 3 PT.

GENERAL

300072907 PAPER COMPUTER 8 1/2 X 11 3 15#
 N CT 1 2 1
 Blended, 1/2in green bar, carbonless, no perf, 8512TQ 3 PT.

260376991 PAPER COMPUTER 8 1/2 X 11 3 16#
 N CT 1 2 1
 Blended, blank, carbonless, no perf, 8510Q 3 PT.

DATA VOICE

300075074 PAPER COMPUTER 8 1/2 X 11 4 15#
 N CT 1 2 1
 Blended, 1/2in green bar, carbonless, no perf, 18512TQ 4 PT.

PRODUCT IDENTIFIER DESCRIPTION

ITEM	ORD.	SELL	STD. PKG.	LEAD TIME	MIN.	A
NUMBER	MULT.	UNIT	STOCK AVAILABILITY / PA		ORD.	C

260377007 PAPER COMPUTER 8 1/2 X 11 4 16#
 N CT 1 2 1
 Blended, blank, carbonless, no perf, 8512TQ 4 PT.

280052382 PAPER COMPUTER 9 1/2 X 5 1/2 15#
 N CT 1 2 1

280047903 PAPER COMPUTER 9 1/2 X 5 1/2 1 15#
 1926865 6000 CT IL IN MI OH WI
 33 33 33 33 33
 Premium bond, blank, 1/2IN regular perf left and right, WIL Custom 20291.

260388699 PAPER COMPUTER 9 1/2 X 5 1/2 2 15#
 N CT 1 2 1
 Blended, blank, carbonless, no perfs, 9550Q 2 PT.

260377023 PAPER COMPUTER 9 1/2 X 11 1 15#
 N CT 1 2 1
 Premium bond, blank, 1/2in regular perf left & right, WIL 951029.

300074663 PAPER COMPUTER 9 1/2 X 11 1 15#
 1942102 1 CT IL IN MI OH WI
 33 33 33 33 33
 Premium bond, blank, 1/2IN regular perf left & right, WIL 951029.

260392535 PAPER COMPUTER 9 1/2 X 11 1 15#
 N CT 1 2 1
 Premium bond, blank, 1/2IN regular perf left and right, WIL 951029.

300074689 PAPER COMPUTER 9 1/2 X 11 1 18#
 1942094 1 CT IL IN MI OH WI
 33 33 33 33 33
 Premium bond, blank, 1/2in regular perf left & right, WIL 951028.

260377056 PAPER COMPUTER 9 1/2 X 11 1 18#
 N CT 1 2 1
 Premium bond, blank, 1/2IN regular perf left & right side, punched, 3 holes on left side, WIL Custom.

260377031 PAPER COMPUTER 9 1/2 X 11 1 18#
 N CT 1 2 1
 Premium bond, blank, 1/2IN clean edge perf left & right, WIL Custom.

300072949 PAPER COMPUTER 9 1/2 X 11 1 20#
 1942151 1 CT IL IN MI OH WI
 33 33 33 33 33
 Premium bond, blank, 1/2in clean edge perf left & right, BOW 620720.

260377015 PAPER COMPUTER 9 1/2 X 11 1 20#
 N CT 1 2 1
 Premium bond, blank, 1/2in clean edge, perf left & right, BOW 951049.

260396460 PAPER COMPUTER 9 1/2 X 11 1 20#
 N CT 1 2 1
 Premium bond, blank, 1/2in perf, clean edge left & right, WIL 951047.

DISTRIBUTION SERVICES

NETWORK SERVICES

TOOLS

BUILDING JANITORIAL

AUTOMOTIVE

FORMS/OFFICE SUPPLIES

GENERAL

DATA VOICE

PRODUCT IDENTIFIER		DESCRIPTION						
ITEM NUMBER	ORD. MULT.	SELL UNIT	STD. PKG. STOCK AVAILABILITY / PA	LEAD TIME	MIN. ORD.	A	C	
300075116 PAPER COMPUTER 9 1/2 X 11 2 15#								
1942110	1	CT	IL IN MI OH WI 33 33 33					
Blended, blank, carbonless, 1/2in regular perf left & right, 9510QJ 2 PT.								
260377049 PAPER COMPUTER 9 1/2 X 11 2 15#								
N		CT	1	2	1			
Blended, blank, carbonless, 1/2in regular perf left & right, 9510QJ 2 PT.								
260389424 PAPER COMPUTER 9 1/2 X 11 2 15#								
N		CT	1	2	1			
Blended, blank, carbonless, 1/2 regular perfs left and right, 9510QJ 2 PT.								
300075124 PAPER COMPUTER 9 1/2 X 11 3 15#								
1942086	1	CT	IL IN MI OH WI 33					
Blended, blank, carbonless, 1/2in regular perf left & right, 9510QJ 3 PT.								
300075132 PAPER COMPUTER 9 1/2 X 11 4 15#								
N		CT	1	2	1			
Blended, blank, carbonless, 1/2in regular perf left & right, 11-8011.								
280093071 PAPER COMPUTER 9 1/2 X 11 1 20#								
N		CT	1	2	1			
Premium bond, blank, white, 1/2in regular perf, WIL 951027.								
280093113 PAPER COMPUTER 9 7/8 X 11 1 15#								
N		CT	1	2	1			
Premium bond, 1/2in green bar, no perf, BOW 091107.								
300074705 PAPER COMPUTER 9 7/8 X 11 1 15#								
N		CT	1	2	1			
Premium bond, 1/2in green bar, no perf, BOW 091107.								
300075140 PAPER COMPUTER 9 7/8 X 11 2 15#								
N		CT	1	2	1			
Blended, 1/2in green bar, carbonless, no perf, 9712TQ 2 PT.								
300075157 PAPER COMPUTER 9 7/8 X 11 3 15#								
N		CT	1	2	1			
Blended, 1/2in green bar, carbonless, no perf, 9712TQ 3 PT.								
300075165 PAPER COMPUTER 9 7/8 X 11 4 15#								
N		CT	1	2	1			
Blended, 1/2in green bar, carbonless, no perf, 9712TQ 4 PT.								
260377247 PAPER COMPUTER 10 5/8 X 8 1/2 1 15#								
N		CT	1	2	1			
Hi-bulk, roll, blank, no perfs, punched, 3 holes top & bottom, BOW 320448.								
260392006 PAPER COMPUTER 11 X 8 1/2 1 16#								
N		SH	1	2	1			
Hi bulk, blank, roll, no perfs, punched, 3 holes at top & bottom, BOW 420774.								

PRODUCT IDENTIFIER		DESCRIPTION						
ITEM NUMBER	ORD. MULT.	SELL UNIT	STD. PKG. STOCK AVAILABILITY / PA	LEAD TIME	MIN. ORD.	A	C	
260419361 PAPER COMPUTER 11 X 8 1/2 1 16#								
N		SH	1	2	1			
Hi-bulk premium bond, blank, roll, no perfs, punched 3 holes top & bottom, BOW 420617								
260388798 PAPER COMPUTER 11 X 8 1/2 1 16# R								
N		SH	70000	2	70000			
Hi-bulk, blank, roll, no perfs, 3 holes at top & bottom, WIL CUSTOM.								
260377239 PAPER COMPUTER 11 X 8 1/2 1 16# R								
N		SH	70000	2	70000			
Hi-bulk, roll, blank, no perfs, punched, 3 holes top & bottom, WIL Custom.								
260316864 PAPER COMPUTER 11 X 8 1/2 1 18#								
N		SH	1	2	1			
Premium bond, roll, blank, no perf, BOW 420843.								
260304001 PAPER COMPUTER 11 X 8 1/2 1 18# R								
N		SH	70000	2	70000			
Premium bond, blank, roll, no perf, WIL Custom.								
260430558 PAPER COMPUTER 11 X 8 1/2 1 20#								
N		CT	1	2	1			
OH - Premium bond, 1/2in greenbar, punched 3 holes at top & 3 holes at bottom. No perfs. WIL 110469.								
300074754 PAPER COMPUTER 11 3/4 X 8 1/2 1 15#								
N		CT	1	2	1			
Premium bond, 1/2in green bar, no perf, BOW 118107.								
280080797 PAPER COMPUTER 11 3/4 X 8 1/2 2 15#								
N		CT	1	2	1			
Blended, 1/2in green bar, carbonless, no perf.								
300075173 PAPER COMPUTER 11 3/4 X 8 1/2 2 15#								
1942169	1	CT	IL IN MI OH WI 33 33					
Blended, 1/2in green bar, carbonless, no perf, 1183TQ 2 PT.								
300075181 PAPER COMPUTER 11 3/4 X 8 1/2 3 15#								
N		CT	1	2	1			
Blended, 1/2in green bar, carbonless, no perf, 1182TQ 3 PT.								
300075199 PAPER COMPUTER 11 3/4 X 8 1/2 4 12#								
N		CT	1	2	1			
Blended, 1/2in green bar, carbonless, no perf, 1182TQ 4 PT.								
280080805 PAPER COMPUTER 11 3/4 X 8 1/2 4 15#								
N		CT	1	2	1			
Blended, 1/2in green bar, carbonless, no perf, 1182TQ 4PT.								
300075207 PAPER COMPUTER 11 3/4 X 8 1/2 5 12#								
N		CT	1	2	1			
Blended, 1/2in green bar, carbonless, no perf, 1182TQ 5 PT.								
300075215 PAPER COMPUTER 11 3/4 X 8 1/2 6 12#								
N		CT	1	2	1			
Blended, 1/2in green bar, carbonless, no perf, 1182TQ 6 PT.								

PAPER COMPUTER

DISTRIBUTION SERVICES

PRODUCT IDENTIFIER DESCRIPTION

ITEM NUMBER	ORD. MULT.	SELL UNIT	STD. PKG. STOCK AVAILABILITY / PA	LEAD TIME	MIN. ORD.	A C
-------------	------------	-----------	-----------------------------------	-----------	-----------	-----

260377221 PAPER COMPUTER 11 X 8 1/2 1 16#
 N CT 1 2 1
 Hi-bulk, blank, no perfs, (3800 box) 3 holes punched top & bottom, WIL 110009.

260361480 PAPER COMPUTER 11 X 8 1/2 1 16#
 N CT 1 2 1
 Premium bond, box, no perfs, 3 holes punched top & bottom, (3800 box) WIL 110069.

260362876 PAPER COMPUTER 11 X 8 1/2 1 18# R
 N EA 70000 2 70000
 Premium bond, blank, no perfs, roll, punched 3 holes top and 3 holes bottom. WIL Custom.

280093139 PAPER COMPUTER 11 X 8 1/2 1 16#
 N CT 1 2 1
 Hi-bulk, blank, 3 holes punched top & bottom, (3800 box) WIL 110069.

260449467 PAPER COMPUTER 11 X 8-1/2 1 16#
 N
 Hi-bulk blank roll, no perfs. Wisconsin Wilmt#.

260449475 PAPER COMPUTER 11 X 8-1/2 1 16#
 N
 Hi-bulk blank roll, no perfs. Wisconsin BOWTR#.

300043098 PAPER COMPUTER 12 X 8 1/2 1 15#
 1314286 1 CT IL IN MI OH WI
 33 33 33 33 33
 Premium bond, blank, 1/2in green bar, regular perf left & right, BOW 620693.

280093147 PAPER COMPUTER 12 X 8 1/2 1 16#
 N CT 1 2 1
 Premium bond, blank, no perf, BOW 120908.

260392527 PAPER COMPUTER 12 X 8 1/2 1 18#
 N CT 1 2 1
 Premium bond, blank, 1/2in clean edge perf left & right, WIL 120028.

300074788 PAPER COMPUTER 12 X 8 1/2 1 18#
 N CT 1 2 1
 Premium bond, 1/2in clean perf left & right.

260377064 PAPER COMPUTER 12 X 8 1/2 1 18#
 N CT 1 2 1
 Premium bond, blank, 1/2in clean edge perf left & right, WIL 120028.

260392014 PAPER COMPUTER 12 X 8 1/2 1 18# R
 N SH 70000 2 70000
 Roll premium bond, blank, no perforations, 3 holes punched top and bottom, BOW.

260392022 PAPER COMPUTER 12 X 8 1/2 1 18# R
 N SH 70000 2 70000
 Roll premium bond, blank, no perforations, 3 holes punched top and bottom, WIL.

300075264 PAPER COMPUTER 12 X 8 1/2 2 15#
 N CT 1 2 1
 Blended, blank, carbonless, regular perf left & right, 1280QJ 2 PT.

NETWORK SERVICES

TOOLS

BUILDING JANITORIAL

AUTOMOTIVE

FORMS/OFFICE SUPPLIES

GENERAL

DATA VOICE

PRODUCT IDENTIFIER DESCRIPTION

ITEM NUMBER	ORD. MULT.	SELL UNIT	STD. PKG. STOCK AVAILABILITY / PA	LEAD TIME	MIN. ORD.	A C
-------------	------------	-----------	-----------------------------------	-----------	-----------	-----

260431655 PAPER COMPUTER 12 X 8 1/2 4 15#
 N CT 1 2 1
 Blended blank carbonless 1/2IN regular perf left and right. 1280QJ 4 part.

260441712 PAPER COMPUTER 12 X 8-1/2 1 16#
 N SH 70000 2 70000
 Hi-bulk bond, blank, no holes, no vertical perfs. WIL PC087 (Illinois-N).

260441852 PAPER COMPUTER 12 X 8-1/2 1 16#
 N SH 70000 2 70000
 Hi-bulk bond, blank 6-hole punched, 1/2IN vertical perf. WIL PC204 (Illinois).

260388491 PAPER COMPUTER 12 X 11 1 15#
 N CT 1 2 1
 Premium bond, blank, 1/2in perf left and right, vertical perf 3in from left side.

280080763 PAPER COMPUTER 14 7/8 X 8 1/2 1 15#
 N CT 1 2 1
 Blended, 1/2in green bar, no perf, WIL 148609.

260437736 PAPER COMPUTER 14 7/8 X 8 1/2 1 15#
 N CT 1 2 1
 1 ply regular bond hi caliper, 1/8 green bar. WIL 148809.

260443270 PAPER COMPUTER 14 7/8 X 8 1/2 1 16#
 N EA 1 1 1
 Bond, 1/2IN green bar, no perfs. Wil 148199.

280080771 PAPER COMPUTER 14 7/8 X 8 1/2 1 18#
 N CT 1 2 1
 Blended, 1/2in green bar, no perf, WIL 148607.

260377197 PAPER COMPUTER 14 7/8 X 8 1/2 1 18#
 N CT 1 2 1
 Premium bond, 2 colors, 1/8in green & orange speedread, no perf, WIL 142808.

260443288 PAPER COMPUTER 14 7/8 X 8 1/2 1 18#
 N EA 1 1 1
 Premium bond, 1/2IN green bar, no perfs. Wil 148808.

300027687 PAPER COMPUTER 14 7/8 X 8 1/2 1 20#
 N CT 1 2 1
 Premium bond, 1/2in green bar, no perf, WIL 148107.

300072782 PAPER COMPUTER 14 7/8 X 8 1/2 2 15#
 N CT 1 2 1
 Economy bond, 1/2in green bar, carbon interleave, no perf, 1482TE 2PT.

280080789 PAPER COMPUTER 14 7/8 X 8 1/2 2 15#
 N CT 1 2 1
 Blended, 1/2in green bar, carbonless, no perf, 1482TQ 2 PT.

300072790 PAPER COMPUTER 14 7/8 X 8 1/2 3 15#
 N CT 1 2 1
 Economy bond, 1/2IN green bar, carbon interleave, no perf, 1482TE 3 PT.

PRODUCT IDENTIFIER		DESCRIPTION				
ITEM NUMBER	ORD. MULT.	SELL UNIT	STD. PKG. STOCK AVAILABILITY / PA	LEAD TIME	MIN. ORD.	A C
280093212		PAPER COMPUTER	14 7/8 X 11	1 15#		
N		CT	1	2	1	
Premium bond, blank, no perf WIL 141009.						
300084688		PAPER COMPUTER	14 7/8 X 11	1 15#		
N		CT	1	2	1	
Premium bond, blank, no perf, WIL 141009.						
300074952		PAPER COMPUTER	14 7/8 X 11	1 15#		
N		CT	1	2	1	
Economy bond, 1/2in green bar, no perf, WIL 141609.						
300074978		PAPER COMPUTER	14 7/8 X 11	1 15#		
N		CT	1	2	1	
1/2in green bar, 3800, no perf. WIL 141108.						
260377148		PAPER COMPUTER	14 7/8 X 11	1 15#		
N		CT	1	2	1	
260377080		PAPER COMPUTER	14 7/8 X 11	1 15#		
N		CT	1	2	1	
Premium bond, 1/2in greenbar, no perf, BOW 141107.						
260396452		PAPER COMPUTER	14 7/8 X 11	1 15#		
N		CT	1	2	1	
Premium bond, 1/2in green bar, no perf, WIL 141109.						
300045036		PAPER COMPUTER	14 7/8 X 11	1 15#		
1942144	1	CT	IL IN MI OH WI 33 33 33 33 33			
Premium bond, 1/2in green bar, no perf, BOW 620661.						
280047895		PAPER COMPUTER	14 7/8 X 11	1 15#		
1928832	1	CT	IL IN MI OH WI 33 33 33 33 33			
Premium bond, 1/2in green bar, verticle perf down middle of paper.						
260388509		PAPER COMPUTER	14 7/8 X 11	1 16#		
N		BX	1	2	1	
Premium bond, 1/2in green bar, no perf, WIL 141199.						
280093196		PAPER COMPUTER	14 7/8 X 11	1 18#		
N		CT	1	2	1	
Premium bond, 1/2in green bar, no perf, WIL 141108.						
280093238		PAPER COMPUTER	14 7/8 X 11	1 18#		
N		CT	1	2	1	
Premium bond, blank, no perf, WIL 141008.						
260388517		PAPER COMPUTER	14 7/8 X 11	1 18#		
N		BX	1	2	1	
Premium bond, 1/2in green bar, no perf, WIL 141108.						
260377155		PAPER COMPUTER	14 7/8 X 11	1 16#		
N		CT	1	2	1	
Premium bond, blank, 1/2in regular perf left & right, vertical perf 9in from left margin, stripped to 8 1/2 x 11, BOW 141038.						

PRODUCT IDENTIFIER		DESCRIPTION				
ITEM NUMBER	ORD. MULT.	SELL UNIT	STD. PKG. STOCK AVAILABILITY / PA	LEAD TIME	MIN. ORD.	A C
260377130		PAPER COMPUTER	14 7/8 X 11	1 18#		
N		CT	1	2	1	
Premium bond, blank, no perf, WIL 141008.						
300072543		PAPER COMPUTER	14 7/8 X 11	1 20#		
N		CT	1	2	1	
Premium bond, blank, 1/2in clean edge left & right, vertical perf 9in from left margln, stripped to 8 1/2in x 11in, WIL 141037.						
280093204		PAPER COMPUTER	14 7/8 X 11	1 20#		
N		CT	1	2	1	
Premium bond, 1/2in green bar, no perf WIL 141107.						
260395579		PAPER COMPUTER	14 7/8 X 11	1 20#		
N		CT	1	2	1	
Premium bond, 1/2in green bar, no perforations, WIL 141107.						
300075009		PAPER COMPUTER	14 7/8 X 11	1 20#		
N		CT	1	3	1	
Premium bond, verticle columns, green & white, 3 lines per inch, 1413C. REPLACES 1413A.						
260402482		PAPER COMPUTER	14 78 X 11	1 20#		
N		CT	1	2	1	
Premium bond, blank, no perforations, WIL 141007.						
300074986		PAPER COMPUTER	14 7/8 X 11	1 20#		
1942128	1	CT	IL IN MI OH WI 33 33 33 33 33			
Premium bond, blank, no perf, WIL 141007.						
300027895		PAPER COMPUTER	14 7/8 X 11	1 20#		
8403915	1	CT	IL IN MI OH WI 33 33 33 33 33			
Premium bond, 1/2in green bar, no perf, WIL 141107.						
260430673		PAPER COMPUTER	14 7/8 X 11	1 20#		
N		CT	1	2	1	
Premium Bond blank 1/2IN regular perf left and right, vertical perf 9IN from left margin. Stripped 8 1/2 X 11. Willamette 143007 - OHIO.						
260330469		PAPER COMPUTER	14 7/8 X 11	1 20#		
1946889	1	CT	IL IN MI OH WI 33 33 33 33 33			
Premium bond, blank, 1/2in regular perf left and right, vertical perf 9in from left margin, stripped size 8 1/2in x 11in, WIL 143007.						
300074937		PAPER COMPUTER	14 7/8 X 11	2 15#		
N		CT	1	1	1	
300075322		PAPER COMPUTER	14 7/8 X 11	2 15#		
N		CT	1	2	1	
Blended, 1/2in green bar, carbonless, no perf, 1412TQ 2 PT.						
300072733		PAPER COMPUTER	14 7/8 X 11	2 15#		
N		CT	1	1	1	
1413-2.						

DISTRIBUTION SERVICES

NETWORK SERVICES

TOOLS

BUILDING JANITORIAL

AUTOMOTIVE

FORMS/OFFICE SUPPLIES

GENERAL

DATA VOICE

PAPER COMPUTER

DISTRIBUTION SERVICES

PRODUCT IDENTIFIER		DESCRIPTION				
ITEM NUMBER	ORD. MULT.	SELL UNIT	STD. PKG. STOCK AVAILABILITY / PA	LEAD TIME	MIN. ORD.	A C
280080722			PAPER COMPUTER 14 7/8 X 11	2	15#	
N		CT	1	2	1	
Blended, 1/2in green bar, carbon interleave, no perf, 1412T 2 PT.						
300074945			PAPER COMPUTER 14 7/8 X 11	2	15#	
N		CT	1	2	1	
Economy bond, 1/2in green bar, no perf, 1412T 2 PT.						
260377098			PAPER COMPUTER 14 7/8 X 11	2	15#	
N		CT	1	2	1	
Blended, 1/2in green bar, carbonless, no perf, 1412TQ 2 PT.						
260377163			PAPER COMPUTER 14 7/8 X 11	2	16#	
N		CT	1	2	1	
Blended, blank, carbonless, no perf, 1410TQ 2 PT.						
300075017			PAPER COMPUTER 14 7/8 X 11	3	12#	
N		CT	1	1	1	
300072741			PAPER COMPUTER 14 7/8 X 11	3	12#	
N		CT	1	1	1	
1413-3.						
300075330			PAPER COMPUTER 14 7/8 X 11	3	15#	
N		CT	1	2	1	
Blended, 1/2in green bar, carbonless, no perf, 1412TQ 3 PT.						
300075389			PAPER COMPUTER 14 7/8 X 11	3	15#	
N		CT	1	2	1	
Economy bond, 1/2in green bar, carbon interleave, no perf, 1412TE 3 PT.						
280080730			PAPER COMPUTER 14 7/8 X 11	3	15#	
N		CT	1	2	1	
Blended, 1/2in green bar, carbon interleave, no perf, 1412T 3 PT.						
260377106			PAPER COMPUTER 14 7/8 X 11	3	15#	
N		CT	1	2	1	
Blended, 1/2in green bar, carbonless, no perf, 1412TQ 3 PT.						
300075025			PAPER COMPUTER 14 7/8 X 11	4	12#	
N		CT	1	1	1	
300072758			PAPER COMPUTER 14 7/8 X 11	4	12#	
N		CT	1	1	1	
1413-4.						
300075348			PAPER COMPUTER 14 7/8 X 11	4	15#	
N		CT	1	2	1	
Blended, 1/2in green bar, carbonless, no perf, 1412TQ 4 PT.						
260377114			PAPER COMPUTER 14 7/8 X 11	4	15#	
N		CT	1	2	1	
Blended, 1/2in green bar, carbonless, no perf, 1412TQ 4 PT.						

NETWORK SERVICES

TOOLS

BUILDING JANITORIAL

AUTOMOTIVE

FORMS/OFFICE SUPPLIES

GENERAL

DATA VOICE

PRODUCT IDENTIFIER		DESCRIPTION				
ITEM NUMBER	ORD. MULT.	SELL UNIT	STD. PKG. STOCK AVAILABILITY / PA	LEAD TIME	MIN. ORD.	A C

300075033			PAPER COMPUTER 14 7/8 X 11	5	12#	
N		CT	1	2	1	
Blended, 1/2in green bar, carbon interleave, no perf, 1412T 5 PT.						
300075397			PAPER COMPUTER 14 7/8 X 11	5	15#	
N		CT	1	2	1	
Economy bond, 1/2in green bar, carbon interleave, no perf, 1412TE 5 PT.						
260377122			PAPER COMPUTER 14 7/8 X 11	5	15#	
N		CT	1	2	1	
Blended, 1/2in green bar, carbon interleave, no perf, 1412T 5 PT.						
300075355			PAPER COMPUTER 14 7/8 X 11	5	15#	
N		CT	1	2	1	
Blended, 1/2in green bar, carbonless, no perf, 1412TQ 5 PT.						
300072600			PAPER COMPUTER 14 7/8 X 11	6	15#	
N		CT	1	2	1	
Blended, 1/2in green bar, carbonless, no perf, 1412TQ 6PT.						
300072550			PAPER COMPUTER 14 7/8 X 11	6	15#	
N		CT	1	2	1	
Economy bond, 1/2in green bar, carbon interleave, no perf, 1412TE 6PT.						
300072634			PAPER COMPUTER 14 7/8 X 11	6	15#	
N		CT	1	2	1	
Blended, 1/2in green bar, carbon interleave, no perf, 1412T 6PT.						
260443494			PAPER COMPUTER 14 7/8 X 11	1	20#	
N		EA	1	1	1	
Premium bond blank 1/2IN reg perf left and right. WIL 141027.						
260449608			PAPER COMPUTER 9-1/2 X 11	1	20#	
N						
Premium Bond blank, 1/2IN reg perf left and right. Bowater #951029.						
260443502			PAPER COMPUTER 9-1/2 X 11	1	20#	
N		EA	1	1	1	
Premium Bond, blank, 1/2IN clean edge perf left & right. WIL 951047.						

PAPER COPIER

260422381			PAPER COPIER 8 1/2 X 11 20LB BLUE			
N		SH	500	1	500	
Ardor Xero-Bond.						
260422308			PAPER COPIER 8 1/2 X 11 20LB BUFF			
N		SH	500	1	500	
Ardor Xero-Bond.						
260422373			PAPER COPIER 8 1/2 X 11 20LB CANARY			
N		SH	500	1	500	
Ardor Xero-Bond.						

PRODUCT IDENTIFIER		DESCRIPTION				
ITEM NUMBER	ORD. MULT.	SELL UNIT	STD. PKG. STOCK AVAILABILITY / PA	LEAD TIME	MIN. ORD.	A C
260422340		PAPER COPIER	8 1/2 X 11 20LB CHERRY			
N		SH	500	1	500	
		Ardor Xero-Bond.				
260422365		PAPER COPIER	8 1/2 X 11 20LB GOLD			
N		SH	500	1	500	
		Ardor Xero-Bond.				
260422316		PAPER COPIER	8 1/2 X 11 20LB GREEN			
N		SH	500	1	500	
		Ardor Xero-Bond.				
260422324		PAPER COPIER	8 1/2 X 11 20LB IVORY			
N		SH	500	1	500	
		Ardor Xero-Bond.				
260422357		PAPER COPIER	8 1/2 X 11 20LB PINK			
N		SH	500	1	500	
		Ardor Xero-Bond.				
260422332		PAPER COPIER	8 1/2 X 11 20LB SALMON			
N		SH	500	1	500	
		Ardor Xero-Bond.				
260404975		PAPER COPIER	8 1/2 X 11 24LB WHITE			
N		SH	500	1	500	
		Nekoosa Laser 1000.				
260405089		PAPER COPIER	8 1/2 X 11 60LB GREEN			
N		SH	1	1	100	
		Flourescent MACTAC Starliner Pressure Sensitive permanent.				
260405097		PAPER COPIER	8 1/2 X 11 60LB RED			
N		SH	1	1	1	
		Flourescent MACTAC Starliner Pressure Sensitive permanent.				
260404991		PAPER COPIER	8 1/2 X 11 60LB SOFT WHITE			
N		SH	500	1	500	
		Carnival Offset.				
260405105		PAPER COPIER	8 1/2 X 11 60LB YELLOW			
N		SH	1	1	100	
		Flourescent MACTAC Starliner Pressure Sensitive permanent.				
260405014		PAPER COPIER	8 1/2 X 11 70LB BLUE			
N		SH	250	1	250	
		Nekoosa Opaque Offset.				
260405030		PAPER COPIER	8 1/2 X 11 70LB WHITE			
N		SH	250	1	250	
		Nekoosa Linen Text.				
260405071		PAPER COPIER	8 7/8 X 11 60LB SCHEMAC			
N		SH	1	1	1	
		MACTAC Starliner Pressure Sensitive Film.				
260404967		PAPER COPIER	11 X 17 20LB BLUE			
N		SH	500	1	500	
		Ardor, Xero-bond.				
260404959		PAPER COPIER	11 X 17 20LB GREEN			
N		SH	500	1	500	
		Ardor, Xero-bond.				

PRODUCT IDENTIFIER		DESCRIPTION				
ITEM NUMBER	ORD. MULT.	SELL UNIT	STD. PKG. STOCK AVAILABILITY / PA	LEAD TIME	MIN. ORD.	A C
260384581		PAPER COPIER	22 X 34 WHITE			
N		SH	1	2	1	
		Ardor long grain.				
280039595		PAPER COPIER	7HOLE NEKOOSA			
N		SH	250	1	1000	
280039686		PAPER COPIER	BEIGE NEKOOSA			
N		SH	250	1	250	
280039645		PAPER COPIER	BLUE MEAD			
N		SH	5000	1	20000	
280039660		PAPER COPIER	BUFF NEKOOSA			
N		SH	250	1	250	
280039637		PAPER COPIER	CANARY MEAD			
N		SH	5000	1	20000	
280039678		PAPER COPIER	GRAY NEKOOSA			
N		SH	5000	1	20000	
280039611		PAPER COPIER	GREEN MEAD			
N		SH	5000	1	20000	
280039629		PAPER COPIER	PINK MEAD			
N		SH	5000	1	20000	
300031549		PAPER COPIER	XEROX 8 1/2 X 11			
8404988	1	SH	IL IN MI OH WI			
			33 33 33 33 33			
		Unpunched, Nekoosa.				
300098233		PAPER COPIER	XEROX 8 1/2 X 11 3HOLE			
1924670	1	SH	IL IN MI OH WI			
			33 33 33 33 33			
		Mead.				
300080694		PAPER COPIER	XEROX 8 1/2 X 11 7HOLE			
1164079	1	SH	IL IN MI OH WI			
			33 33 33 33 33			
		Mead.				
300025178		PAPER COPIER	XEROX 8 1/2 X 11 BLUE			
1140103	1	SH	IL IN MI OH WI			
			33 33 33 33 33			
		Nekoosa.				
300025160		PAPER COPIER	XEROX 8 1/2 X 11 CANARY			
8403238	1	SH	IL IN MI OH WI			
			33 33 33 33 33			
		Nekoosa.				
300025442		PAPER COPIER	XEROX 8 1/2 X 11 GREEN			
8403790	1	SH	IL IN MI OH WI			
			33 33 33 33 33			
		Nekoosa.				
300025152		PAPER COPIER	XEROX 8 1/2 X 11 PINK			
1190025	1	SH	IL IN MI OH WI			
			33 33 33 33 33			
		Nekoosa.				

DISTRIBUTION SERVICES

NETWORK SERVICES

TOOLS

BUILDING JANITORIAL

AUTOMOTIVE

FORMS/OFFICE SUPPLIES

GENERAL

DATA VOICE

PAPER COPIER

PRODUCT IDENTIFIER		DESCRIPTION						
ITEM NUMBER	ORD. MULT.	SELL UNIT	STD. PKG. STOCK AVAILABILITY / PA	LEAD TIME		MIN. ORD.	A C	
401426663 PAPER COPIER XEROX 8 1/2 X 11 PLAIN								
1104265	1	SH	IL IN MI OH WI 33 33 33 33					
Mead								
300027299 PAPER COPIER XEROX 8 1/2 X 14								
8403741	1	SH	IL IN MI OH WI 33 33 33 33 33					
Unpunched, Mead.								
401501671 PAPER COPIER XEROX 8 1/2 X 14								
N		SH	5000	1	20000			
Unpunched, Nekoosa.								
280047424 PAPER COPIER XEROX 11 X 17 WHITE								
N		SH	2500	1	10000			
Mead								
300027646 PAPER COPIER XEROX 11 X 17 WHITE								
8403758	1	SH	IL IN MI OH WI 33 33 33 33 33					
Mead.								

280039652 PAPER COPIER YELLOW NEKOOSA							
N		SH	250	1	250		

PAPER CROSS SECTION

300024510 PAPER CROSS SECTION 375							
N		CT	1	1	1		
12 pads per carton.							
300024536 PAPER CROSS SECTION 378 BLUE 5 X 5IN PAD							
N		CT	1	2	1		
280005927 PAPER CROSS SECTION D3 22-025							
0001617	1	PD	IL IN MI OH WI				
8-1/2 X 11IN. NOW AVAILABLE THROUGH TOUCH TONE ORDER ENTRY.							

PAPER DRAWING

280033630 PAPER DRAWING GREEN 341-10							
N		SH	1	2	1		
100 sheets per pad.							
280033648 PAPER DRAWING GREEN 341-20							
N		SH	1	2	1		
50 sheets per pad.							
280033622 PAPER DRAWING GREEN 341-T 6							
N		SH	1	2	1		
280033606 PAPER DRAWING GREEN 341-T24							
N		SH	1	2	1		
280033614 PAPER DRAWING GREEN 341-T30							
N		SH	1	2	1		

PRODUCT IDENTIFIER		DESCRIPTION						
ITEM NUMBER	ORD. MULT.	SELL UNIT	STD. PKG. STOCK AVAILABILITY / PA	LEAD TIME		MIN. ORD.	A C	

PAPER DRY SILVER

280033663 PAPER DRY SILVER 735							
N		CT	1	2	1		
18in x 250in, 4 rolls per carton.							
280033671 PAPER DRY SILVER 3M TYPE 795 #1650795							
N		CT	1	2	1		
For microfiche reader printer, 3M, 2 rolls per carton.							
280033655 PAPER DRY SILVER 50085							
N		CT	1	2	1		
8 1/2in x 500ft, 4 rolls per carton.							
260344353 PAPER DRY SILVER 8 1/2 W X 11 H							
N		CT	1	2	1		

PAPER EASEL

260323829 PAPER EASEL 20IN X 34IN							
N		CT	1	2	1		
HED 3 holes, perforated, 4 pads per carton.							
280005802 PAPER EASEL 27IN X 34IN							
0001602	1	PD	IL IN MI OH WI				
NOW AVAILABLE THROUGH TOUCH-TONE ORDER ENTRY.							
300024502 PAPER EASEL 28IN X 34IN CONFERENCE							
8402180	1	PK	IL IN MI OH WI 33 33 33 33				
2hole 3/8in on 28in side.							
300024361 PAPER EASEL 28IN X 34IN LINED							
8402172	1	PK	IL IN MI OH WI 33 33 33 33				
2hole 3/8in on 28in side.							
280005810 PAPER EASEL 45IN X 34IN							
0001603	1	PD	IL IN MI OH WI				
NOW AVAILABLE THROUGH TOUCH-TONE ORDER ENTRY.							

001122886 PAPER EASEL 45IN X 34IN G332 PAD							
N		PD	30	1	30		

401353685 PAPER EASEL 45IN X 35IN 60							
N		PD	1	1	25		

PAPER FASTENER

SEE FASTENER BRASS PAPER.

PAPER FAX

260347257 PAPER FAX 801-6							
N		RO	6	1	6		

DISTRIBUTION SERVICES

NETWORK SERVICES

TOOLS

BUILDING JANITORIAL

AUTOMOTIVE

FORMS/OFFICE SUPPLIES

GENERAL

DATA VOICE

PRODUCT IDENTIFIER		DESCRIPTION						
ITEM NUMBER	ORD. MULT.	SELL UNIT	STD. PKG. STOCK AVAILABILITY / PA	LEAD TIME			MIN. ORD.	A C
280027574 PAPER FAX 8 1/2IN X 328FT ROLL								
1924696	1	RO	IL 33 IN 33 MI 33 OH 33 WI 33	1 1/2in core.				
280027426 PAPER FAX 8 1/2IN X 328FT ROLL								
1925933	6	RO	IL 33 IN 33 MI 33 OH 33 WI 33	1in core.				

280054982 PAPER FAX COMFAX 3A								
N		CT	1	2			1	
3M, carton of 5 rolls.								

PAPER GRAPH

260330691 PAPER GRAPH 1000HP-10 11X17								
N		PD	1	2			1	
280033721 PAPER GRAPH 1000H-4 1/4IN SQUARES								
N		PK	1	2			1	
280054990 PAPER GRAPH 340-32								
N		PK	1	2			1	
Package of 100.								
280055013 PAPER GRAPH 341-10								
N		PK	1	2			1	
Package of 100.								
280055021 PAPER GRAPH 341-20								
N		PK	1	2			1	
Package of 100.								
280055005 PAPER GRAPH 341-T24								
N		PK	1	2			1	
Package of 100.								

PAPER INDEX

401353479 PAPER INDEX 8 1/2 X 11 110 BLUE								
N		SH	1	2			1	
401355656 PAPER INDEX 8 1/2 X 11 110 CANARY								
N		SH	1	3			5000	
401355664 PAPER INDEX 8 1/2 X 11 110 WHITE								
N		SH	1	2			1	

PAPER MEMO

260304290 PAPER MEMO 3IN X 5IN								
0001640	1	PK	NOW AVAILABLE THROUGH TOUCH TONE ORDER ENTRY.					
400573390 PAPER MEMO 4IN X 6IN								
1182477	1	SH	IL 33 IN 33 MI 33 OH 33 WI 33	Unruled, unpunched, 16 lb. Package of 1000 sheets.				

PRODUCT IDENTIFIER		DESCRIPTION						
ITEM NUMBER	ORD. MULT.	SELL UNIT	STD. PKG. STOCK AVAILABILITY / PA	LEAD TIME			MIN. ORD.	A C
300096724 PAPER MEMO LEVEL 3/UP 4 X 6IN								
N		EA	500	2			500	
260302591 PAPER MEMO LEVEL 3/UP 8 X 5IN								
N		EA	250	2			500	
Personalized.								
260302583 PAPER MEMO LEVEL 3/UP 8 1/2 X 5IN								
N		EA	250	2			500	
Personalized.								

PAPER PLOTTER

260446828 PAPER PLOTTER 18 X 24IN 100 SHTS/PKG B20								
N				Opaque Bond.				
260446810 PAPER PLOTTER 18 X 24IN 500 SHTS/PKG B20								
N				Opaque bond.				
260384623 PAPER PLOTTER 23 1/2 X 33 WHITE								
N		PK	1	2			1	
HP9280-0528.								
260342928 PAPER PLOTTER GLOSSY SHEET								
N		BX	1	1			1	
100 sheets per box.								
260358478 PAPER PLOTTER HP17801P								
N		PK	1	1			1	
260358338 PAPER PLOTTER HP17805P								
N		PK	1	1			1	
260342910 PAPER PLOTTER NON-GLOSSY SHEET								
N		BX	1	1			1	
250 sheets per box.								
260342902 PAPER PLOTTER NON-GLOSSY SHEET								
N		BX	50	1			1	
50 sheets per box.								

PAPER PUNCH

SEE PUNCH.

PAPER ROLL

260446802 PAPER ROLL 24IN X 500FT VERSATEC								
N				Low humidity, opaque.				
260338660 PAPER ROLL 3 1/4IN X 3 1/2IN DIAMETER								
1948596	1	CS	IL 33 IN 33 MI 33 OH 33 WI 33	Receipt printer paper for teller locations.				
260384672 PAPER ROLL 8 1/2IN X 11IN 1597855								
N		RO	1	2			1	
Kodak Ektamate 250.								

DISTRIBUTION SERVICES
 NETWORK SERVICES
 TOOLS
 BUILDING JANITORIAL
 AUTOMOTIVE
 FORMS/OFFICE SUPPLIES
 GENERAL
 DATA VOICE

PAPER ROLL

PRODUCT IDENTIFIER		DESCRIPTION					
ITEM NUMBER	ORD. MULT.	SELL UNIT	STD. PKG. STOCK AVAILABILITY / PA	LEAD TIME	MIN. ORD.	A C	
260417704		PAPER ROLL ARDOR BOND 18IN X 500FT					
N		RO	2	2	2		
		20#. 2211340838.					
PAPER SHEET							
400184305		PAPER SHEET 4010					
1208280	500	SH					
		Package of 500.					
400184453		PAPER SHEET 4310					
N			1		500		
280079856		PAPER SHEET 8 1/2IN X 11IN BUFF					
N		SH	1	2	1		
		90lb, 7 hole, 500 per package.					
300031960		PAPER SHEET 8 1/2IN X 11IN WHITE					
1187674	1	PK	IL	IN	MI	OH	WI
			33	33	33	33	33
		24lb.					
400165882		PAPER SHEET A010					
5653642	500	SH	IL	IN	MI	OH	WI
			33	33	33	33	33
400180402		PAPER SHEET E610					
7415224	1	SH	IL	IN	MI	OH	WI
			33	33	33	33	33
		16lb, white, 8 1/2in X 11in, unpunched, economy bond.					
400180451		PAPER SHEET E620					
5324947	500	SH	IL	IN	MI	OH	WI
			33	33	33	33	33
		16lb, canary, 8 1/2in X 11in, unpunched, economy bond.					
400180469		PAPER SHEET E621 8 1/2IN X 11IN					
N			1		500		
		4 hole punch economy bond.					
400180519		PAPER SHEET E631 8 1/2IN X 11IN					
4401802	500	SH	IL	IN	MI	OH	WI
			33	33	33	33	33
		4 hole punch economy bond.					
401353925		PAPER SHEET RD040					
5653741	500	EA	IL	IN	MI	OH	WI
			33	33	33	33	33
		Unpunched, 20lb, pink, bond, 8 1/2in X 11in.					
PAPER TELETYPE							
300025475		PAPER TELETYPE 1 PART					
8403824	1	CT					
		9 1/2in X 5 1/2in.					
300027661		PAPER TELETYPE 1411-00-20					
N		CT	1	6	1		
		No breaks in carton.					
280033846		PAPER TELETYPE 28-95-2-1					
N		CT	1	4	1		

PRODUCT IDENTIFIER		DESCRIPTION					
ITEM NUMBER	ORD. MULT.	SELL UNIT	STD. PKG. STOCK AVAILABILITY / PA	LEAD TIME	MIN. ORD.	A C	
401374814		PAPER TELETYPE 3PLY NCR 4 1/2 233					
N		CT	1	2	1		
300027703		PAPER TELETYPE 5IN X 7IN BLANK					
N		CT	1	6	1		
280047010		PAPER TELETYPE 8 1/2 X 11 20# 1PT					
N		SH	1	3	10		
280047002		PAPER TELETYPE 8 1/2 X 5 1/2 20#					
N		SH	5200	4	5200		
		1 Part.					
400911210		PAPER TELETYPE 8 1/2IN CANARY					
N		CT	1	4	4		
		12 rolls per carton, CA08621.					
300025533		PAPER TELETYPE 810-0-2 WHITE 2-PLY					
N		CT	1	2	1		
300036530		PAPER TELETYPE CE-9511-00-2					
8406454	1	CT	IL	IN	MI	OH	WI
			33	33	33	33	33
		2700 per carton.					
400214128		PAPER TELETYPE CK1920 L1 8 1/2IN					
1208603	1	CT	IL	IN	MI	OH	WI
			33	33	33	33	33
		White paper rolls, 5in in diameter, approximately 390ft per roll. Used for 15, 28, 33, 35 and 37 friction feed 8 1/2in wide platin.					
400214110		PAPER TELETYPE CK1920 L1 8 1/2IN					
1101923	1	CT	IL	IN	MI	OH	WI
			33	33	33	33	33
		12 rolls per carton.					
400695284		PAPER TELETYPE CK8621 WHITE					
1295006	1	CT	IL	IN	MI	OH	WI
			33	33	33	33	33
		8 1/2in X 100ft, 100 rolls per carton.					
280033911		PAPER TELETYPE RB 1411 00-2 1 PLY					
N		CT	1	2	1		
		Dataspeed 40 132 characters with perforated edges.					
280071192		PAPER TELETYPE RB 1411 00-3					
N		CT	1	1	1		
		14-7/8.					
300025459		PAPER TELETYPE RB 9511 00-2					
N		CT	1	8	48		
300025509		PAPER TELETYPE WH 850-0-1					
N		CT	1	6	1		
300025483		PAPER TELETYPE WH 850-0-3					
N		CT	1	2	1		
PEN							
260414818		PEN BEROL FLASH #32 BLACK C-14					
N		EA	1	1	1		

DISTRIBUTION SERVICES
 NETWORK SERVICES
 TOOLS
 BUILDING JANITORIAL
 AUTOMOTIVE
 FORMS/OFFICE SUPPLIES
 GENERAL
 DATA VOICE

PRODUCT IDENTIFIER		DESCRIPTION				
ITEM NUMBER	ORD. MULT.	SELL UNIT	STD. PKG. STOCK AVAILABILITY / PA	LEAD TIME	MIN. ORD.	A C
260415013	PEN	BEROL FLASH #32 BLUE	C-16			
N		EA	1	1	1	
260415112	PEN	BEROL FLASH #32 GREEN	C-17			
N		EA	1	1	1	
260414917	PEN	BEROL FLASH #32 RED	C-15			
N		EA	1	1	1	
260415211	PEN	BIC NON-REFILLABLE BLACK B-99				
N		EA	1	1	1	
		Fine point. NOW AVAILABLE THROUGH TOUCH TONE ORDER ENTRY.				
260415617	PEN	BIC NON-REFILLABLE BLACK C-04				
N		EA	1	1	1	
		Medium point. NOW AVAILABLE THROUGH TOUCH TONE ORDER ENTRY.				
260415518	PEN	BIC NON-REFILLABLE BLUE C-03				
N		EA	1	1	1	
		Fine point. NOW AVAILABLE THROUGH TOUCH TONE ORDER ENTRY.				
260415914	PEN	BIC NON-REFILLABLE BLUE C-07				
N		EA	1	1	1	
		Medium point. NOW AVAILABLE THROUGH TOUCH-TONE ORDER ENTRY.				
260415310	PEN	BIC NON-REFILLABLE GREEN C-01				
N		EA	1	1	1	
		Fine point. NOW AVAILABLE THROUGH TOUCH TONE ORDER ENTRY.				
260415716	PEN	BIC NON-REFILLABLE GREEN C-05				
N		EA	1	1	1	
		Medium point. NOW AVAILABLE THROUGH TOUCH TONE ORDER ENTRY.				
260415419	PEN	BIC NON-REFILLABLE RED C-02				
N		EA	1	1	1	
		Fine point. NOW AVAILABLE THROUGH TOUCH TONE ORDER ENTRY.				
260415815	PEN	BIC NON-REFILLABLE RED C-06				
N		EA	1	1	1	
		Medium point. NOW AVAILABLE THROUGH TOUCH TONE ORDER ENTRY.				
401606132	PEN	CHROMATIC 501 YEL				
N		EA	1		12	
		Pen is gold in color with black yellow insignia & advertising for action in black on body of pen.				
280006560	PEN	CHROMATIC BELL LOGO RED/BLUE				
0001775	1	EA	IL IN MI OH WI			
		NOW AVAILABLE THROUGH TOUCH-TONE ORDER ENTRY.				
400548525	PEN	DESK SET BALLPOINT 1 BLACK				
N		EA	1		12	
		1300.				

PRODUCT IDENTIFIER		DESCRIPTION				
ITEM NUMBER	ORD. MULT.	SELL UNIT	STD. PKG. STOCK AVAILABILITY / PA	LEAD TIME	MIN. ORD.	A C
280012709	PEN	ERASERMATE II DISPOSABLE BLACK				
0001796	1	DZ	IL IN MI OH WI			
		NOW AVAILABLE THROUGH TOUCH-TONE ORDER ENTRY.				
280012741	PEN	ERASERMATE II DISPOSABLE BLUE				
0001794	1	DZ	IL IN MI OH WI			
		NOW AVAILABLE THROUGH TOUCH-TONE ORDER ENTRY.				
280012758	PEN	ERASERMATE II DISPOSABLE RED				
0001795	1	DZ	IL IN MI OH WI			
		NOW AVAILABLE THROUGH TOUCH-TONE ORDER ENTRY.				
260416011	PEN	ERASERMATE II MEDIUM BLACK J-71				
N		EA	1	1	1	
260416110	PEN	ERASERMATE II MEDIUM BLUE J-72				
N		EA	1	1	1	
260416219	PEN	ERASERMATE II MEDIUM RED J-73				
N		EA	1	1	1	
260432323	PEN	ERASERMATE REFILLABLE MEDIUM BLUE				
0001800	1	EA	IL IN MI OH WI			
		NOW AVAILABLE THROUGH TOUCH-TONE ORDER ENTRY.				
260437173	PEN	FLEXGRIP .5MM FINE BLACK				
0001831	1	EA	IL IN MI OH WI			
		NOW AVAILABLE THROUGH TOUCH-TONE ORDER ENTRY.				
260437157	PEN	FLEXGRIP .5MM FINE BLUE				
0001829	1	EA	IL IN MI OH WI			
		NOW AVAILABLE THROUGH TOUCH-TONE ORDER ENTRY.				
260437165	PEN	FLEXGRIP .5MM FINE RED				
0001830	1	EA	IL IN MI OH WI			
		NOW AVAILABLE THROUGH TOUCH-TONE ORDER ENTRY.				
260432356	PEN	FLEXGRIP .7MM BLACK				
0001828	1	EA	IL IN MI OH WI			
		NOW AVAILABLE THROUGH TOUCH-TONE ORDER ENTRY.				
260432331	PEN	FLEXGRIP .7MM BLUE				
0001826	1	EA	IL IN MI OH WI			
		NOW AVAILABLE THROUGH TOUCH-TONE ORDER ENTRY.				
260432349	PEN	FLEXGRIP .7MM RED				
0001827	1	EA	IL IN MI OH WI			
		NOW AVAILABLE THROUGH TOUCH-TONE ORDER ENTRY.				

DISTRIBUTION SERVICES
 NETWORK SERVICES
 TOOLS
 BUILDING JANITORIAL
 AUTOMOTIVE
 FORMS/OFFICE SUPPLIES
 GENERAL
 DATA VOICE

DISTRIBUTION SERVICES

NETWORK SERVICES

TOOLS

BUILDING JANITORIAL

AUTOMOTIVE

FORMS/OFFICE SUPPLIES

GENERAL

DATA VOICE

PEN

PRODUCT IDENTIFIER		DESCRIPTION					
ITEM NUMBER	ORD. MULT.	SELL UNIT	STD. PKG. STOCK AVAILABILITY / PA	LEAD TIME	MIN. ORD.	A C	
280034067			PEN KOH-I-NOOR RAPIDOGRAPH #1				
N		EA	1	2	1		
260416417			PEN PAPERMATE RETRACTABLE BLUE K-34				
N		DZ	1	1	1		
Medium point. NOW AVAILABLE THROUGH TOUCH TONE ORDER ENTRY.							
260416516			PEN PILOT MEDIUM BLACK J-74				
N		EA	1	1	1		
260416615			PEN PILOT MEDIUM BLUE J-75				
N		EA	1	1	1		
260416714			PEN PILOT MEDIUM RED J-76				
N		EA	1	1	1		
280012402			PEN PILOT PRECISE FINE BLACK				
0001810	1	DZ	IL IN MI OH WI				
NOW AVAILABLE THROUGH TOUCH TONE ORDER ENTRY.							
280012410			PEN PILOT PRECISE FINE BLUE				
0001809	1	DZ	IL IN MI OH WI				
NOW AVAILABLE THROUGH TOUCH TONE ORDER ENTRY.							
260304308			PEN PILOT PRECISE FINE GREEN				
0001811	1	DZ	IL IN MI OH WI				
NOW AVAILABLE THROUGH TOUCH TONE ORDER ENTRY.							
280012428			PEN PILOT PRECISE FINE RED				
0001812	1	DZ	IL IN MI OH WI				
NOW AVAILABLE THROUGH TOUCH TONE ORDER ENTRY.							
280012436			PEN PRECISE .5MM X-FINE BLACK				
0001806	1	DZ	IL IN MI OH WI				
Rolling ball. NOW AVAILABLE THROUGH TOUCH-TONE ORDER ENTRY.							
280012444			PEN PRECISE .5MM X-FINE BLUE				
0001805	1	DZ	IL IN MI OH WI				
Rolling ball. NOW AVAILABLE THROUGH TOUCH-TONE ORDER ENTRY.							
260304316			PEN PRECISE .5MM X-FINE GREEN				
0001807	1	DZ	IL IN MI OH WI				
Rolling ball. NOW AVAILABLE THROUGH TOUCH-TONE ORDER ENTRY.							
280012451			PEN PRECISE .5MM X-FINE RED				
0001808	1	DZ	IL IN MI OH WI				
Rolling ball. NOW AVAILABLE THROUGH TOUCH-TONE ORDER ENTRY.							
260416813			PEN RAZOR POINT PI-SWIOPP BLACK C-43				
N		BX	1	1	1		

PRODUCT IDENTIFIER		DESCRIPTION					
ITEM NUMBER	ORD. MULT.	SELL UNIT	STD. PKG. STOCK AVAILABILITY / PA	LEAD TIME	MIN. ORD.	A C	
260416912			PEN RAZOR POINT PI-SWIOPP BLUE C-44				
N		BX	1	1	1		
260414024			PEN RAZOR POINT PI-SWIOPP RED C-70				
N		BX	1	1	1		
280012725			PEN ROLLER .8M MEDIUM BLACK				
0001813	1	DZ	IL IN MI OH WI				
NOW AVAILABLE THROUGH TOUCH-TONE ORDER ENTRY.							
280012717			PEN ROLLER .8M MEDIUM BLUE				
0001814	1	DZ	IL IN MI OH WI				
NOW AVAILABLE THROUGH TOUCH-TONE ORDER ENTRY.							
280012675			PEN ROLLER .8M MEDIUM RED				
0001817	1	DZ	IL IN MI OH WI				
NOW AVAILABLE THROUGH TOUCH-TONE ORDER ENTRY.							
260414628			PEN ROLLING WRITER FINE PT BLACK I-30				
N		EA	1	1	1		
260414727			PEN ROLLING WRITER FINE PT BLUE I-31				
N		EA	1	1	1		
260414925			PEN ROLLING WRITER FINE PT GREEN I-33				
N		EA	1	1	1		
260414826			PEN ROLLING WRITER FINE PT RED I-32				
N		EA	1	1	1		
260414123			PEN ROLLING WRITER MEDIUM BLACK I-25				
N		EA	1	1	1		
260414222			PEN ROLLING WRITER MEDIUM PT BLUE I-26				
N		EA	1	1	1		
260414529			PEN ROLLING WRITER MEDIUM PT BROWN I-29				
N		EA	1	1	1		
260414420			PEN ROLLING WRITER MEDIUM PT GREEN I-28				
N		EA	1	1	1		
260414321			PEN ROLLING WRITER MEDIUM PT RED I-27				
N		EA	1	1	1		
280079393			PEN SHARPIE EXTRA FINE BLACK				
1980243	12	EA	IL IN MI OH WI				
			33 33 33 33 33				
Box of 12.							
280079401			PEN SHARPIE EXTRA FINE RED				
1980227	12	EA	IL IN MI OH WI				
			33 33 33 33 33				
Box of 12.							

DISTRIBUTION SERVICES

NETWORK SERVICES

TOOLS

BUILDING JANITORIAL

AUTOMOTIVE

FORMS/OFFICE SUPPLIES

GENERAL

DATA VOICE

PRODUCT IDENTIFIER		DESCRIPTION						
ITEM NUMBER	ORD. MULT.	SELL UNIT	STD. PKG.	LEAD TIME		MIN. ORD.	A C	
			STOCK AVAILABILITY / PA					
401354329 PEN SHARPIE FINE BLACK								
1980235	12	EA	IL 33	IN 33	MI 33	OH 33	WI 33	
Box of 12								
401354337 PEN SHARPIE FINE RED								
1980219	12	EA	IL 33	IN 33	MI 33	OH 33	WI 33	
Box of 12								
260415021 PEN UNI-BALL FINE PT BLACK C-21								
N		BX	1		1		1	
Faber Castell. NOW AVAILABLE THROUGH TOUCH TONE ORDER ENTRY.								
260422258 PEN UNI-BALL FINE PT BLUE C-28								
N		BX	1		1		1	
Faber Castell.								
260415229 PEN UNI-BALL FINE PT GREEN C-40								
N		DZ	1		1		1	
Faber Castell. NOW AVAILABLE THROUGH TOUCH TONE ORDER ENTRY.								
260415328 PEN UNI-BALL FINE PT RED C-41								
N		BX	1		1		1	
Faber Castell. NOW AVAILABLE THROUGH TOUCH TONE ORDER ENTRY.								
280012592 PEN UNI-BALL FINE .2MM BLACK								
0001776	1	DZ	IL	IN	MI	OH	WI	
Faber Castell. NOW AVAILABLE THROUGH TOUCH TONE ORDER ENTRY.								
280012600 PEN UNI-BALL FINE .2MM BLUE								
0001777	1	DZ	IL	IN	MI	OH	WI	
Faber Castell. NOW AVAILABLE THROUGH TOUCH TONE ORDER ENTRY.								
280012568 PEN UNI-BALL FINE .2MM GREEN								
0001778	1	DZ	IL	IN	MI	OH	WI	
Faber Castell. NOW AVAILABLE THROUGH TOUCH TONE ORDER ENTRY.								
280012550 PEN UNI-BALL FINE .2MM RED								
0001779	1	DZ	IL	IN	MI	OH	WI	
Faber Castell. NOW AVAILABLE THROUGH TOUCH TONE ORDER ENTRY.								
280012618 PEN UNI-BALL MEDIUM .3MM BLACK								
0001780	1	DZ	IL	IN	MI	OH	WI	
Faber Castell. NOW AVAILABLE THROUGH TOUCH TONE ORDER ENTRY.								
280012626 PEN UNI-BALL MEDIUM .3MM BLUE								
0001781	1	DZ	IL	IN	MI	OH	WI	
Faber Castell. NOW AVAILABLE THROUGH TOUCH TONE ORDER ENTRY.								

PRODUCT IDENTIFIER		DESCRIPTION						
ITEM NUMBER	ORD. MULT.	SELL UNIT	STD. PKG.	LEAD TIME		MIN. ORD.	A C	
			STOCK AVAILABILITY / PA					
280012634 PEN UNI-BALL MEDIUM .3MM RED								
0001782	1	DZ	IL	IN	MI	OH	WI	
Faber Castell. NOW AVAILABLE THROUGH TOUCH TONE ORDER ENTRY.								
260415427 PEN UNI-BALL X-FINE PT BLACK J-32								
N		DZ	1		1		1	
Faber Castell Micro-ball. NOW AVAILABLE THROUGH TOUCH TONE ORDER ENTRY.								
260415526 PEN UNI-BALL X-FINE PT BLUE J-33								
N		DZ	1		1		1	
Faber Castell Micro-ball. NOW AVAILABLE THROUGH TOUCH TONE ORDER ENTRY.								
260415625 PEN UNI-BALL X-FINE PT GREEN J-34								
N		DZ	1		1		1	
Faber Castell Micro-ball. NOW AVAILABLE THROUGH TOUCH TONE ORDER ENTRY.								
260415724 PEN UNI-BALL X-FINE PT RED J-35								
N		DZ	1		1		1	
Faber Castell Micro-ball. NOW AVAILABLE THROUGH TOUCH TONE ORDER ENTRY.								
260415823 PEN WRITE BROS FINE PT BLACK C-09								
N		EA	1		1		1	
Papermate.								
260416029 PEN WRITE BROS FINE PT BLUE B-63								
N		EA	1		1		1	
Papermate. NOW AVAILABLE THROUGH TOUCH TONE ORDER ENTRY.								
260415922 PEN WRITE BROS FINE PT RED C-10								
N		EA	1		1		1	
Papermate. NOW AVAILABLE THROUGH TOUCH TONE ORDER ENTRY.								
260416128 PEN WRITE BROS MEDIUM PT BLACK C-11								
N		EA	1		1		1	
Papermate. NOW AVAILABLE THROUGH TOUCH TONE ORDER ENTRY.								
260416425 PEN WRITE BROS MEDIUM PT BLUE B-64								
N		EA	1		1		1	
Papermate. NOW AVAILABLE THROUGH TOUCH TONE ORDER ENTRY.								
260416326 PEN WRITE BROS MEDIUM PT GREEN C-13								
N		EA	1		1		1	
Papermate. NOW AVAILABLE THROUGH TOUCH TONE ORDER ENTRY.								
260416227 PEN WRITE BROS MEDIUM PT RED C-12								
N		EA	1		1		1	
Papermate. NOW AVAILABLE THROUGH TOUCH TONE ORDER ENTRY.								
260355326 PEN W/HIGHLIGHTER BLACK/BLUE								
0001968	1	DZ	IL	IN	MI	OH	WI	
Zebra. NOW AVAILABLE THROUGH TOUCH TONE ORDER ENTRY.								

DISTRIBUTION SERVICES	PEN								PRODUCT IDENTIFIER DESCRIPTION							
	PRODUCT IDENTIFIER		DESCRIPTION						PRODUCT IDENTIFIER		DESCRIPTION					
	ITEM NUMBER	ORD. MULT.	SELL UNIT	STD. PKG. STOCK AVAILABILITY / PA	LEAD TIME	MIN. ORD.	A C	ITEM NUMBER	ORD. MULT.	SELL UNIT	STD. PKG. STOCK AVAILABILITY / PA	LEAD TIME	MIN. ORD.	A C		
NETWORK SERVICES	260355060 PEN W/HIGHLIGHTER BLACK/GREEN 0001969 1 DZ IL IN MI OH WI Zebra. NOW AVAILABLE THROUGH TOUCH TONE ORDER ENTRY.								260334453 PEN BALLPOINT FINE GREEN STABILINER 0001908 1 DZ IL IN MI OH WI NOW AVAILABLE THROUGH TOUCH-TONE ORDER ENTRY.							
	260355334 PEN W/HIGHLIGHTER BLACK/ORANGE 0001971 1 DZ IL IN MI OH WI Zebra. NOW AVAILABLE THROUGH TOUCH TONE ORDER ENTRY.								280006461 PEN BALLPOINT FINE RED PILOT 0001765 1 DZ IL IN MI OH WI NOW AVAILABLE THROUGH TOUCH-TONE ORDER ENTRY.							
	260364492 PEN W/HIGHLIGHTER BLACK/PINK 0001984 1 DZ IL IN MI OH WI Zebra. NOW AVAILABLE THROUGH TOUCH TONE ORDER ENTRY.								260334461 PEN BALLPOINT FINE RED STABILINER 0001907 1 DZ IL IN MI OH WI NOW AVAILABLE THROUGH TOUCH-TONE ORDER ENTRY.							
TOOLS	260355078 PEN W/HIGHLIGHTER BLACK/YELLOW 0001970 1 DZ IL IN MI OH WI Zebra. NOW AVAILABLE THROUGH TOUCH TONE ORDER ENTRY.								280009143 PEN BALLPOINT MEDIUM BLACK BIC 0001733 1 DZ IL IN MI OH WI NOW AVAILABLE THROUGH TOUCH-TONE ORDER ENTRY.							
	PEN BALLPOINT								280006404 PEN BALLPOINT MEDIUM BLACK PILOT 0001769 1 DZ IL IN MI OH WI NOW AVAILABLE THROUGH TOUCH-TONE ORDER ENTRY.							
BUILDING JANITORIAL	280006370 PEN BALLPOINT FINE BLACK BIC 0001731 1 DZ NOW AVAILABLE THROUGH TOUCH-TONE ORDER ENTRY.								260334446 PEN BALLPOINT MEDIUM BLACK STABILINER 0001909 1 DZ IL IN MI OH WI NOW AVAILABLE THROUGH TOUCH-TONE ORDER ENTRY.							
	280006446 PEN BALLPOINT FINE BLACK PILOT 0001763 1 DZ IL IN MI OH WI NOW AVAILABLE THROUGH TOUCH-TONE ORDER ENTRY.								280009150 PEN BALLPOINT MEDIUM BLUE BIC 0001734 1 DZ IL IN MI OH WI NOW AVAILABLE THROUGH TOUCH-TONE ORDER ENTRY.							
AUTOMOTIVE	260334487 PEN BALLPOINT FINE BLACK STABILINER 0001905 1 DZ IL IN MI OH WI NOW AVAILABLE THROUGH TOUCH-TONE ORDER ENTRY.								280006412 PEN BALLPOINT MEDIUM BLUE PILOT 0001760 1 DZ IL IN MI OH WI NOW AVAILABLE THROUGH TOUCH-TONE ORDER ENTRY.							
	280006388 PEN BALLPOINT FINE BLUE BIC 0001732 1 DZ IL IN MI OH WI NOW AVAILABLE THROUGH TOUCH-TONE ORDER ENTRY.								260334438 PEN BALLPOINT MEDIUM BLUE STABILINER 0001910 1 DZ IL IN MI OH WI NOW AVAILABLE THROUGH TOUCH-TONE ORDER ENTRY.							
FORMS/OFFICE SUPPLIES	280006453 PEN BALLPOINT FINE BLUE PILOT 0001764 1 DZ IL IN MI OH WI NOW AVAILABLE THROUGH TOUCH-TONE ORDER ENTRY.								280009168 PEN BALLPOINT MEDIUM GREEN BIC 0001735 1 DZ IL IN MI OH WI NOW AVAILABLE THROUGH TOUCH-TONE ORDER ENTRY.							
	260334479 PEN BALLPOINT FINE BLUE STABILINER 0001906 1 DZ IL IN MI OH WI NOW AVAILABLE THROUGH TOUCH-TONE ORDER ENTRY.								280006438 PEN BALLPOINT MEDIUM GREEN PILOT 0001762 1 DZ IL IN MI OH WI NOW AVAILABLE THROUGH TOUCH-TONE ORDER ENTRY.							
GENERAL	280006479 PEN BALLPOINT FINE GREEN PILOT 0001766 1 DZ IL IN MI OH WI NOW AVAILABLE THROUGH TOUCH-TONE ORDER ENTRY.															
DATA VOICE																

DISTRIBUTION SERVICES

NETWORK SERVICES

TOOLS

BUILDING JANITORIAL

AUTOMOTIVE

FORMS/OFFICE SUPPLIES

GENERAL

DATA VOICE

PRODUCT IDENTIFIER		DESCRIPTION					
ITEM NUMBER	ORD. MULT.	SELL UNIT	STD. PKG. STOCK AVAILABILITY / PA	LEAD TIME	MIN. ORD.	A C	
260334412 PEN BALLPOINT MEDIUM GREEN STABILINER							
0001912	1	DZ	IL IN MI OH WI				
NOW AVAILABLE THROUGH TOUCH-TONE ORDER ENTRY.							
280009176 PEN BALLPOINT MEDIUM RED BIC							
0001736	1	DZ	IL IN MI OH WI				
NOW AVAILABLE THROUGH TOUCH-TONE ORDER ENTRY.							
280006420 PEN BALLPOINT MEDIUM RED PILOT							
0001761	1	DZ	IL IN MI OH WI				
NOW AVAILABLE THROUGH TOUCH-TONE ORDER ENTRY.							
260334420 PEN BALLPOINT MEDIUM RED STABILINER							
0001911	1	DZ	IL IN MI OH WI				
NOW AVAILABLE THROUGH TOUCH-TONE ORDER ENTRY.							
401354352		DZ	1	2	1		
PEN BALLPOINT N-RETR FINE BLACK AF11							
401354360		DZ	1	2	1		
PEN BALLPOINT N-RETR FINE BLUE AF11							
401354469		DZ	1	2	1		
PEN BALLPOINT N-RETR MED BLACK GSM11							
BIC.							
401743083		DZ	1	2	1		
PEN BALLPOINT N-RETR MED BLUE GSM11							
401743091 PEN BALLPOINT PM GREEN BS BIC							
2632083	1	BX	IL IN MI OH WI 33 33				
Non-retractable, medium tip, box of 12.							
401743109 PEN BALLPOINT PM RED BS BIC							
2632109	1	BX	IL IN MI OH WI 33 33 33 33				
Non-retractable, medium tip, box of 12.							
400655692		DZ	1	2	1		
PEN BALLPOINT RETR BLACK MED							
Box of 12.							
280006396 PEN BALLPOINT RETR BLACK MED							
0001737	1	DZ	IL IN MI OH WI				
NOW AVAILABLE THROUGH TOUCH-TONE ORDER ENTRY.							
PEN PLOTTER							
260438767		EA	1	1	1		
PEN PLOTTER 64NDW BLACK .25							
260438759		EA	1	1	1		
PEN PLOTTER 64NDW GREEN .70							

PRODUCT IDENTIFIER		DESCRIPTION					
ITEM NUMBER	ORD. MULT.	SELL UNIT	STD. PKG. STOCK AVAILABILITY / PA	LEAD TIME	MIN. ORD.	A C	
260438734		EA	1	1	1		
PEN PLOTTER 64NDW RED .25							
260438742		EA	1	1	1		
PEN PLOTTER 64NDW RED .70							
260358395		PK	1	1	1		
PEN PLOTTER HP17725T							
260358254		PK	1	1	1		
PEN PLOTTER HP17726T							
260358403		PK	1	1	1		
PEN PLOTTER HP17727T							
260358262		PK	1	1	1		
PEN PLOTTER HP17731T							
260358411		PK	1	1	1		
PEN PLOTTER HP17732T							
260358270		PK	1	1	1		
PEN PLOTTER HP17733T							
260358429		PK	1	1	1		
PEN PLOTTER HP17742T							
260358288		PK	1	1	1		
PEN PLOTTER HP17745T							
260358437		PK	1	1	1		
PEN PLOTTER HP17825P							
260358296		PK	1	1	1		
PEN PLOTTER HP17826P							
260358445		PK	1	1	1		
PEN PLOTTER HP17827P							
260358304		PK	1	1	1		
PEN PLOTTER HP17828P							
260358452		PK	1	1	1		
PEN PLOTTER HP17831P							
260358353		PK	1	1	1		
PEN PLOTTER HP17832P							
260358213		PK	1	1	1		
PEN PLOTTER HP17833P							
260358361		PK	1	1	1		
PEN PLOTTER HP17841P							
260358221		PK	1	1	1		
PEN PLOTTER HP17842P							
260358379		PK	1	1	1		
PEN PLOTTER HP17843P							
260358239		PK	1	1	1		
PEN PLOTTER HP17845P							

DISTRIBUTION SERVICES
 NETWORK SERVICES
 TOOLS
 BUILDING JANITORIAL
 AUTOMOTIVE
 FORMS/OFFICE SUPPLIES
 GENERAL
 DATA VOICE

PEN PLOTTER

PRODUCT IDENTIFIER		DESCRIPTION				
ITEM NUMBER	ORD. MULT.	SELL UNIT	STD. PKG. STOCK AVAILABILITY / PA	LEAD TIME	MIN. ORD.	A C
280358387 PEN PLOTTER HP17847P						
N		PK	1	1	1	
280358247 PEN PLOTTER HP17849P						
N		PK	1	1	1	
260342662 PEN PLOTTER PAPER .03 5/ASSORTED						
N		BX	1	2	1	
HP-17847P (BLK,A,G,B,V) narrow.						
260342654 PEN PLOTTER PAPER .03 5/ASSORTED						
N		BX	1	2	1	
HP-17849P (BR,O,R-V,Y,R) narrow.						
260342670 PEN PLOTTER PAPER .03 5/ASSORTED						
N		BX	1	2	1	
HP-17845P (BLK,R,Y,B,G) narrow.						
260342704 PEN PLOTTER PAPER .03 AQUA						
N		BX	1	2	1	
HP-17829P narrow, 5 per package.						
260342688 PEN PLOTTER PAPER .03 BLACK						
1970418	1	BX	IL IN MI OH WI	04		
HP-17825P narrow 5 per package.						
260342712 PEN PLOTTER PAPER .03 BLUE						
N		BX	1	2	1	
HP-17831P narrow 5 per package.						
260342738 PEN PLOTTER PAPER .03 BROWN						
N		BX	1	2	1	
HP-17835P narrow 5 per package.						
260342696 PEN PLOTTER PAPER .03 GREEN						
N		BX	1	2	1	
HP-17827P narrow 5 per package.						
260342753 PEN PLOTTER PAPER .03 ORANGE						
N		BX	1	2	1	
HP-17839P narrow 5 per package.						
260342761 PEN PLOTTER PAPER .03 RED						
N		BX	1	2	1	
HP-17841P narrow 5 per package.						
260342779 PEN PLOTTER PAPER .03 RED-VIOLET						
N		BX	1	2	1	
HP-17843P narrow 5 per package.						
260342746 PEN PLOTTER PAPER .03 RED-YELLOW						
N		BX	1	2	1	
HP-17837P narrow 5 per package.						
260342720 PEN PLOTTER PAPER .03 VIOLET						
N		BX	1	2	1	
HP-17833P narrow 5 per package.						
260342621 PEN PLOTTER PAPER .07 5/ASSORTED						
N		BX	1	2	1	
HP-17850P (BR,O,R-V,Y,R) wide.						

PRODUCT IDENTIFIER		DESCRIPTION				
ITEM NUMBER	ORD. MULT.	SELL UNIT	STD. PKG. STOCK AVAILABILITY / PA	LEAD TIME	MIN. ORD.	A C
260342647 PEN PLOTTER PAPER .07 5/ASSORTED						
N		BX	1	2	1	
HP-17846P (BLK,R,Y,B,G) wide.						
260342639 PEN PLOTTER PAPER .07 5/ASSORTED						
N		BX	1	2	1	
HP-17848P (BLK,A,G,B,V) wide.						
260342522 PEN PLOTTER PAPER .07 BLACK						
N		BX	1	2	1	
HP-17826P wide 5 per package.						
260342548 PEN PLOTTER PAPER .07 BLUE						
N		BX	1	2	1	
HP-17832P wide 5 per package.						
260342530 PEN PLOTTER PAPER .07 GREEN						
N		BX	1	2	1	
HP-17828P wide 5 per package.						
260342555 PEN PLOTTER PAPER .07 RED						
N		BX	1	2	1	
HP-17842P wide 5 per package.						
260342597 PEN PLOTTER TRNPCY .03 5/ASSORTED						
N		BX	1	2	1	
HP-17749T (BR,O,R-V,Y,R) narrow.						
260342613 PEN PLOTTER TRNPCY .03 5/ASSORTED						
N		BX	1	2	1	
HP-17745T (BLK,R,Y,B,G) narrow.						
260342605 PEN PLOTTER TRNPCY .03 5/ASSORTED						
N		BX	1	2	1	
HP-17747T (BLK,A,G,B,V) narrow.						
260342787 PEN PLOTTER TRNPCY .03 AQUA						
N		BX	1	2	1	
HP-17729T narrow 5 per package.						
260341292 PEN PLOTTER TRNPCY .03 BLACK						
N		BX	1	2	1	
HP-17725T narrow 5 per package.						
260342795 PEN PLOTTER TRNPCY .03 BLUE						
N		BX	1	2	1	
HP-17731T narrow 5 per package.						
260342811 PEN PLOTTER TRNPCY .03 BROWN						
N		BX	1	2	1	
HP-17735T narrow 5 per package.						
260341532 PEN PLOTTER TRNPCY .03 GREEN						
N		BX	1	2	1	
HP-17727T narrow 5 per package.						
260342837 PEN PLOTTER TRNPCY .03 ORANGE						
N		BX	1	2	1	
HP-17739T narrow 5 per package.						
260342845 PEN PLOTTER TRNPCY .03 RED						
N		BX	1	2	1	
HP-17741T narrow 5 per package.						

PRODUCT IDENTIFIER		DESCRIPTION				
ITEM NUMBER	ORD. MULT.	SELL UNIT	STD. PKG. STOCK AVAILABILITY / PA	LEAD TIME	MIN. ORD.	A C
260342852	N	BX	1	2	1	
PEN PLOTTER TRNPCY .03 RED-VIOLET HP-17743T narrow 5 per package.						
260342803	N	BX	1	2	1	
PEN PLOTTER TRNPCY .03 VIOLET HP-17733T narrow 5 per package.						
260342829	N	BX	1	2	1	
PEN PLOTTER TRNPCY .03 YELLOW HP-17737T narrow 5 per package.						
260342589	N	BX	1	2	1	
PEN PLOTTER TRNPCY .06 5/ASSORTED HP-17746T (BLK,R,Y,B,G) wide.						
260342563	N	BX	1	2	1	
PEN PLOTTER TRNPCY .06 5/ASSORTED HP-17750T (BR,O,R-V,Y,R) wide.						
260342571	N	BX	1	2	1	
PEN PLOTTER TRNPCY .06 5/ASSORTED HP-17748T (BLK,A,G,B,V) wide.						
260342894	N	BX	1	2	1	
PEN PLOTTER TRNPCY .06 BLACK HP-17726T wide 5 per package.						
260342878	N	BX	1	2	1	
PEN PLOTTER TRNPCY .06 BLUE HP-17732T wide 5 per package.						
260342886	N	BX	1	2	1	
PEN PLOTTER TRNPCY .06 GREEN HP-17728T wide 5 per package.						
260342860	N	BX	1	2	1	
PEN PLOTTER TRNPCY .06 RED HP-17742T wide 5 per package.						
260438775	N	PK	4	1	1	
PEN PLOTTER WLB-3 RED						

PENCIL

403056898	N	GR	1	2	9	
PENCIL CLERICAL W/O ERASER 2 2/4 Box of 12.						
403056864	N	GR	1	2	9	
PENCIL CLERICAL W/O ERASER #1 Box of 12.						
403056872	N	GR	1	2	9	
PENCIL CLERICAL W/O ERASER #2 Box of 12.						
403056906	N	GR	1	4	9	
PENCIL CLERICAL W/O ERASER #3 Box of 12.						
403056914	N	GR	1	2	9	
PENCIL CLERICAL W/O ERASER #4 Box of 12.						

PRODUCT IDENTIFIER		DESCRIPTION				
ITEM NUMBER	ORD. MULT.	SELL UNIT	STD. PKG. STOCK AVAILABILITY / PA	LEAD TIME	MIN. ORD.	A C
403058340	N	GR	1	2	5	
PENCIL COLOR LEAD W/ERASER Cherry red.						
403058357	1185090	1	GR	IL IN MI OH WI		
PENCIL COLOR LEAD W/ERASER 025 red, Box of 12.						
260416920	N	EA	1	1	1	BLUE J-80
PENCIL COL-ERASE With eraser # 1276. NOW AVAILABLE THROUGH TOUCH TONE ORDER ENTRY.						
260416524	N	EA	1	1	1	BROWN C-42
PENCIL COL-ERASE With eraser # 1272. NOW AVAILABLE THROUGH TOUCH TONE ORDER ENTRY.						
260414131	N	EA	1	1	1	GREEN J-82
PENCIL COL-ERASE With eraser # 1278. NOW AVAILABLE THROUGH TOUCH TONE ORDER ENTRY.						
260416722	N	EA	1	1	1	ORANGE C-46
PENCIL COL-ERASE With eraser # 1295. NOW AVAILABLE THROUGH TOUCH TONE ORDER ENTRY.						
260416821	N	EA	1	1	1	PURPLE C-47
PENCIL COL-ERASE With eraser # 1282. NOW AVAILABLE THROUGH TOUCH TONE ORDER ENTRY.						
260414032	N	EA	1	1	1	RED J-81
PENCIL COL-ERASE With eraser # 1277. NOW AVAILABLE THROUGH TOUCH TONE ORDER ENTRY.						
260416623	N	EA	1	1	1	YELLOW C-45
PENCIL COL-ERASE With eraser # 1279. NOW AVAILABLE THROUGH TOUCH TONE ORDER ENTRY.						
403056922	N	GR	1	2	4	
PENCIL DRAWING B WITH ERASER Box of 12.						
403056989	N	GR	1	2	1	
PENCIL DRAWING B WITH ERASER Box of 12.						
280006628	0001743	1	DZ	IL IN MI OH WI		
PENCIL DRAWING F VENUS NOW AVAILABLE THROUGH TOUCH-TONE ORDER ENTRY.						
403056971	N	GR	1	2	4	
PENCIL DRAWING F WITH ERASER Box of 12.						
280006636	0001744	1	DZ	IL IN MI OH WI		
PENCIL DRAWING H VENUS NOW AVAILABLE THROUGH TOUCH-TONE ORDER ENTRY.						

DISTRIBUTION SERVICES

NETWORK SERVICES

TOOLS

BUILDING JANITORIAL

AUTOMOTIVE

FORMS/OFFICE SUPPLIES

GENERAL

DATA VOICE

PENCIL

PRODUCT IDENTIFIER		DESCRIPTION				
ITEM NUMBER	ORD. MULT.	SELL UNIT	STD. PKG. STOCK AVAILABILITY / PA	LEAD TIME	MIN. ORD.	A C
260414230		PENCIL	DRAWING H W/O ERASER		C-37	
N		BX	1	1	1	
403056948		PENCIL	DRAWING 2B WITH ERASER			
N		GR	1	2	1	
Box of 12.						
401355730		PENCIL	DRAWING 2H EXA 043 17			
N		GR	1		4	
280006651		PENCIL	DRAWING 2H VENUS			
0001746	1	DZ	IL IN MI OH WI			
NOW AVAILABLE THROUGH TOUCH-TONE ORDER ENTRY.						
403056997		PENCIL	DRAWING 2H WITH ERASER			
5648741	1	GR	IL IN MI OH WI			
Package of 12.						
260414537		PENCIL	DRAWING 2H WITH ERASER		C-27	
N		BX	1	1	1	
Turquoise Eagle. NOW AVAILABLE THROUGH TOUCH TONE ORDER ENTRY.						
260414438		PENCIL	DRAWING 2H W/O ERASER		C-26	
N		BX	1	1	1	
Turquoise Eagle.						
260414339		PENCIL	DRAWING 2H W/O ERASER		C-38	
N		BX	1	1	1	
280006669		PENCIL	DRAWING 3H VENUS			
0001747	1	DZ	IL IN MI OH WI			
NOW AVAILABLE THROUGH TOUCH TONE ORDER ENTRY.						
403057003		PENCIL	DRAWING 3H WITH ERASER			
N		GR	1	2	4	
Box of 12.						
280006677		PENCIL	DRAWING 4H VENUS			
0001748	1	DZ	IL IN MI OH WI			
NOW AVAILABLE THROUGH TOUCH-TONE ORDER ENTRY.						
403057011		PENCIL	DRAWING 4H WITH ERASER			
N		GR	1	2	4	
Box of 12.						
403057029		PENCIL	DRAWING 5H WITH ERASER			
6631283	1	BX	IL IN MI OH WI			
33 33						
Box of 12.						
280006644		PENCIL	DRAWING HB VENUS			
0001745	1	DZ	IL IN MI OH WI			
NOW AVAILABLE THROUGH TOUCH-TONE ORDER ENTRY.						
403056930		PENCIL	DRAWING HB WITH ERASER			
N		GR	1	2	4	
Box of 12.						

PRODUCT IDENTIFIER		DESCRIPTION				
ITEM NUMBER	ORD. MULT.	SELL UNIT	STD. PKG. STOCK AVAILABILITY / PA	LEAD TIME	MIN. ORD.	A C
401705207		PENCIL	DRAWING HB WITH ERASER			
5648725		PK	IL IN MI OH WI			
Box of 12.						
403056518		PENCIL	EXEC F W/O ERASER BS			
1209528	12	EA	IL IN MI OH WI			
33 33						
403056534		PENCIL	EXEC 2H W/O ERASER BS			
1209502	12	EA	IL IN MI OH WI			
33						
403056542		PENCIL	EXEC 3H W/O ERASER BS			
1209544	12	EA	IL IN MI OH WI			
33						
403056559		PENCIL	EXEC 4H W/O ERASER BS			
N		GR	1		1	
403056567		PENCIL	EXEC 5H W/O ERASER BS			
N		EA	1		1	
403056468		PENCIL	EXEC HB W/O ERASER BS			
1209486	12	EA	IL IN MI OH WI			
33						
403056427		PENCIL	EXEC #2 W/O ERASER			
N		GR	1	2	9	
Box of 12.						
403056419		PENCIL	EXEC #2 W/O ERASER			
N		GR	1	1	6	
4641, box of 12.						
403056435		PENCIL	EXEC #2 W/O ERASER 2/4			
N		GR	1	2	6	
403056443		PENCIL	EXEC #3 W/O ERASER			
N		GR	1	2	6	
Box of 12.						
403056450		PENCIL	EXEC #4 W/O ERASER			
N		GR	1	2	6	
Box of 12.						
403057904		PENCIL	INDEL LEAD W/O ERSR BLK			
N		GR	1	2	5	
403057888		PENCIL	INDEL LEAD W/O ERSR BLU			
N		GR	1	2	5	
403057912		PENCIL	INDEL LEAD W/O ERSR BRN			
N		GR	1	2	5	
403057995		PENCIL	INDEL LEAD W/O ERSR DK RED			
N		GR	1	2	5	
403057896		PENCIL	INDEL LEAD W/O ERSR GRN			
N		GR	1	2	5	
403058043		PENCIL	INDEL LEAD W/O ERSR LT BLU			
N		GR	1	2	5	

DISTRIBUTION SERVICES

NETWORK SERVICES

TOOLS

BUILDING JANITORIAL

AUTOMOTIVE

FORMS/OFFICE SUPPLIES

GENERAL

DATA VOICE

PRODUCT IDENTIFIER DESCRIPTION

ITEM NUMBER	ORD. MULT.	SELL UNIT	STD. PKG. STOCK AVAILABILITY / PA	LEAD TIME	MIN. ORD.	A C
-------------	------------	-----------	-----------------------------------	-----------	-----------	-----

403058027		PENCIL INDEL LEAD W/O ERSR LT GRN				
N		GR	1	2	5	
403057920		PENCIL INDEL LEAD W/O ERSR ORG				
N		GR	1	2	5	
403057938		PENCIL INDEL LEAD W/O ERSR PRP				
N		GR	1	2	5	
403057987		PENCIL INDEL LEAD W/O ERSR RED				
N		GR	1	2	5	
403057953		PENCIL INDEL LEAD W/O ERSR YWL				
N		GR	1	2	5	

280006602 PENCIL MECHANICAL .5MM BLACK
 0001741 1 EA IL IN MI OH WI
 NOW AVAILABLE THROUGH TOUCH-TONE ORDER ENTRY.

260414636 PENCIL MECHANICAL 0.5MM 9765 C-33
 N EA 1 1 1
 Faber Castell. NOW AVAILABLE THROUGH TOUCH TONE ORDER ENTRY.

260415336 PENCIL MECHANICAL 0.5MM J-42
 N DZ 1 1 1
 Pentel Quicker Clicker, transparent barrel, smoke.

260415534 PENCIL MECHANICAL 0.5MM J-44
 N DZ 1 1 1
 Pentel Quicker Clicker, transparent barrel, blue.

260415633 PENCIL MECHANICAL 0.5MM J-45
 N DZ 1 1 1
 Pentel Quicker Clicker, solid barrel.

260415039 PENCIL MECHANICAL 0.5MM P205A C-30
 N EA 1 1 1
 Black.

260414735 PENCIL MECHANICAL 0.7MM 9766 C-34
 N EA 1 1 1
 Faber Castell. NOW AVAILABLE THROUGH TOUCH TONE ORDER ENTRY.

260415120 PENCIL MECHANICAL 0.7MM P207C BLUE C-31
 N EA 1 1 1

260415237 PENCIL MECHANICAL 0.9MM 9209 C-32
 N EA 1 1 1
 Yellow.

260414834 PENCIL MECHANICAL 0.9MM 9769 C-35
 N EA 1 1 1
 Faber Castell. NOW AVAILABLE THROUGH TOUCH TONE ORDER ENTRY.

401767785 PENCIL MECHANICAL 14MS RED
 N EA 100 3 100
 Package of 10.

PRODUCT IDENTIFIER DESCRIPTION

ITEM NUMBER	ORD. MULT.	SELL UNIT	STD. PKG. STOCK AVAILABILITY / PA	LEAD TIME	MIN. ORD.	A C
-------------	------------	-----------	-----------------------------------	-----------	-----------	-----

260414933		PENCIL MECHANICAL 1.1MM I-37				
N		EA	1	1	1	
				Twist-action.		

280012519 PENCIL MECHANICAL SHARPWRITER
 0001783 1 DZ IL IN MI OH WI
 NOW AVAILABLE THROUGH TOUCH-TONE ORDER ENTRY.

280006610 PENCIL QUICKER CLICKER BLUE
 0001742 1 EA IL IN MI OH WI
 NOW AVAILABLE THROUGH TOUCH-TONE ORDER ENTRY.

260415435 PENCIL QUICKER CLICKER .5MM RED J-43
 N DZ 1 1 1
 Pentel, transparent barrel.

403057227 PENCIL TRU-ARROW #2 W/ERASER
 7461806 1 BX IL IN MI OH WI
 Package of 12.

403056609 PENCIL VECTOR 22/4 001-03
 7461822 1 EA IL IN MI OH WI
 33 33
 Box of 12.

403058076 PENCIL VENUS 1008 GREEN
 1209403 12 EA IL IN MI OH WI
 33 33
 Box of 12.

403058365 PENCIL VENUS 1271 VIOLET/RED
 6631382 1 BX IL IN MI OH WI
 33 33
 Box of 12.

403058241 PENCIL VENUS 1276 WITH ERASER BLUE
 1221564 1 BX IL IN MI OH WI
 33 33 33
 Box of 12.

403058258 PENCIL VENUS 1278 WITH ERASER GREEN
 N GR 1 2 5
 Box of 12.

403058316 PENCIL VENUS 1279 WITH ERASER YELLOW
 6631788 1 BX IL IN MI OH WI
 33 33
 Box of 12.

280006685 PENCIL VENUS VELVET #2
 0001739 1 DZ IL IN MI OH WI
 NOW AVAILABLE THROUGH TOUCH-TONE ORDER ENTRY.

260415732 PENCIL VENUS VELVET #2 2H W/ERASER J-83
 N EA 1 1 1
 Yellow barrel. NOW AVAILABLE THROUGH TOUCH TONE ORDER ENTRY.

DISTRIBUTION SERVICES
 NETWORK SERVICES
 TOOLS
 BUILDING JANITORIAL
 AUTOMOTIVE
 FORMS/OFFICE SUPPLIES
 GENERAL
 DATA VOICE

PENCIL

PRODUCT IDENTIFIER		DESCRIPTION					
ITEM NUMBER	ORD. MULT.	SELL UNIT	STD. PKG. STOCK AVAILABILITY / PA	LEAD TIME	MIN. ORD.	A C	
280006594 PENCIL VENUS VELVET #2.5							
0001740	1	DZ	IL IN MI OH WI				
NOW AVAILABLE THROUGH TOUCH TONE ORDER ENTRY.							
280006693 PENCIL WITH ERASER BLUE							
0001750	1	DZ	IL IN MI OH WI				
NOW AVAILABLE THROUGH TOUCH TONE ORDER ENTRY.							
280006701 PENCIL WITH ERASER GREEN							
0001751	1	DZ	IL IN MI OH WI				
NOW AVAILABLE THROUGH TOUCH TONE ORDER ENTRY.							
280006719 PENCIL WITH ERASER RED							
0001752	1	DZ	IL IN MI OH WI				
NOW AVAILABLE THROUGH TOUCH TONE ORDER ENTRY.							
280006727 PENCIL WITH ERASER YELLOW							
0001753	1	DZ	IL IN MI OH WI				
NOW AVAILABLE THROUGH TOUCH TONE ORDER ENTRY.							
403058068 PENCIL WOODCASE BLUE LEAD							
1209320	12	EA	IL IN MI OH WI 33 33				

PHOTOGRAPHIC SUPPLIES

260429519 FILM 35MM COLOR PRINT ASA-400						
N		EA	1	2	1	
36 Exposure.						
260388277 FILM 35MM SLIDE COLORED ASA-100						
N		EA	1	2	1	
Kodak Ektachrome, 24 exposure.						
280031444 FILM KODACOLOR 120MM (10/BX)						
N		BX	1	2	1	
280031477 FILM POLAROID 600 HI-SPEED COLOR						
N		PK	1	2	1	
Land 604448, 2 pack, 20 picture 8 X 8 CM.						
280031451 FILM POLAROID LAND POLACOLOR						
N		PK	1	2	1	
2 type 668						
280031469 FILM POLAROID LAND SX70						
N		EA	1	2	1	
260429535 FLASHBAR II POLAROID SX70						
N		EA	1	2	1	
280031568 FLASHCUBE GE H1 POWER LONGSHOT						
N		BX	1	2	1	

PRODUCT IDENTIFIER DESCRIPTION

ITEM NUMBER	ORD. MULT.	SELL UNIT	STD. PKG. STOCK AVAILABILITY / PA	LEAD TIME	MIN. ORD.	A C
PIN PUSH						
280005224 PIN PUSH CLEAR Package of 20						
0001414	1	PK				
NOW AVAILABLE THROUGH TOUCH-TONE ORDER ENTRY.						
260415344 PIN PUSH PLASTIC BLUE C-55						
N		BX	1	1	1	
100 per box.						
260415047 PIN PUSH PLASTIC CLEAR C-51						
N		BX	1	1	1	
100 per box. NOW AVAILABLE THROUGH TOUCH-TONE ORDER ENTRY.						
260415443 PIN PUSH PLASTIC GREEN C-56						
N		BX	1	1	1	
100 per box.						
260415245 PIN PUSH PLASTIC RED C-54						
N		BX	1	1	1	
100 per box.						
260415146 PIN PUSH PLASTIC WHITE C-52						
N		BX	1	1	1	
100 per box.						
260416995 PIN PUSH PLASTIC YELLOW C-57						
N		BX	1	1	1	
100 per box.						

PLANNER

260344692 PLANNER 12 MONTH KEITH-CLARK SK2						
N		EA	1	1	1	

PLAQUE SAFETY

300059524 PLAQUE SAFETY 4 1/2IN X 6 3/4IN						
1330381	1	EA				
Plaque with outline of the five states comprising Ameritech. NO JOB IS SO IMPORTANT AND NO SERVICE IS SO URGENT THAT WE CANNOT TAKE TIME TO PERFORM OUR WORK SAFELY.						

POCKET FILE

400547899 POCKET FILE EXPANDABLE PCA						
N		EA	1	2	1	
400547907 POCKET FILE EXPANDABLE PCB						
N		EA	1	2	1	
POCKET FILE LGL 1 3/4IN XPND						
0001523	1	EA				
DIMENSION FOUR CATALOG #F8 1516C.						

DISTRIBUTION SERVICES

NETWORK SERVICES

TOOLS

BUILDING JANITORIAL

AUTOMOTIVE

FORMS/OFFICE SUPPLIES

GENERAL

DATA VOICE

PRODUCT IDENTIFIER		DESCRIPTION				
ITEM NUMBER	ORD. MULT.	SELL UNIT	STD. PKG. STOCK AVAILABILITY / PA	LEAD TIME	MIN. ORD.	A C
POCKET FILE LGL 3 1/2IN XPND						
0001524	1	EA				
DIMENSION FOUR CATALOG #F8 1526E.						
POCKET FILE LTR 1 3/4IN XPND						
0001522	1	EA				
DIMENSION FOUR CATALOG #F8 1514C.						
POCKET FILE LTR 3 1/2IN XPND						
0001525	1	EA				
DIMENSION FOUR CATALOG #F8 1524E.						

POCKET SECRETARY

280079609 POCKET SECRETARY J395 FOLDER						
N		EA	1	2		1

POINTER

280034539 POINTER PENCIL 103434						
N		EA	1	2		1
260339908 POINTER PENCIL STAB ME SM40						
N		BX	1	2		1
260416037 POINTER REFILL #3026R C-48						
N		BX	1	1		1

POST

260416235 POST NYLON TAPERED ENDS 6IN K-05						
N		EA	1	1		1
NOW AVAILABLE THROUGH TOUCH TONE ORDER ENTRY.						
260416136 POST NYLON TAPERED ENDS 10IN I-44						
N		EA	1	1		1
NOW AVAILABLE THROUGH TOUCH TONE ORDER ENTRY.						

PROTECTOR

260414248 PROTECTOR POCKET CLEAR C-59						
N		EA	1	1		1
NOW AVAILABLE THROUGH TOUCH TONE ORDER ENTRY.						
260414347 PROTECTOR SHEET 11 X 8 1/2IN C-60						
N		BX	1	1		1
Matte finish, 50 per box. NOW AVAILABLE THROUGH TOUCH TONE ORDER ENTRY.						
260414446 PROTECTOR SHEET 11 X 8 1/2IN J-85						
N		BX	1	1		1
Clear finish, 50 per box.						

401333166 PROTECTOR SHEET 8 1/2IN X 11IN						
6674986	1	BX	IL	IN	MI	OH
			33	33	33	33
Box of 50.						

PRODUCT IDENTIFIER		DESCRIPTION				
ITEM NUMBER	ORD. MULT.	SELL UNIT	STD. PKG. STOCK AVAILABILITY / PA	LEAD TIME	MIN. ORD.	A C
260414545 PROTECTOR SHEET CL-61013 B-65						
N		BX	1	1		1
3-hole punched, clear vinyl, top load. NOW AVAILABLE THROUGH TOUCH TONE ORDER ENTRY.						

PROTECTOR VINYL

280013376 PROTECTOR VINYL PLASTIC TAG						
N		EA	1	1		1
Size 9. Reusable vinyl plastic tag protector - fits paper tag up to 7 3/8in X 3 3/8in.						

PUNCH

280004672 PUNCH ADJUSTABLE 3-HOLE BLACK						
0001306	1	EA				
NOW AVAILABLE THROUGH TOUCH-TONE ORDER ENTRY.						
260414644 PUNCH HAND STYLE 1-HOLE 1/4IN K-24						
N		EA	1	1		1
NOW AVAILABLE THROUGH TOUCH TONE ORDER ENTRY.						

400548772 PUNCH HOLE ROUND B140 6 9/32IN						
1229906	1	EA	IL	IN	MI	OH
			33	33	33	33
For punching 9/32in round hole where paper is to be fitted in binder. Single hole punch.						

260414743 PUNCH HUMMER 3-HOLE C-50						
N		EA	1	1		1
NOW AVAILABLE THROUGH TOUCH TONE ORDER ENTRY.						
260414842 PUNCH HUMMER EXTRA HEAD B-21						
N		EA	1	1		1
NOW AVAILABLE THROUGH TOUCH TONE ORDER ENTRY.						
260414941 PUNCH HUMMER REPLACEMENT J-29						
N		EA	1	1		1
For handle and shaft. NOW AVAILABLE THROUGH TOUCH TONE ORDER ENTRY.						

401485594 PUNCH PAPER HAND GEM 1/4						
1215335	1	EA	IL	IN	MI	OH
			33	33	33	33

280004664 PUNCH SINGLE HOLE 1/4						
0001305	1	EA	IL	IN	MI	OH
NOW AVAILABLE THROUGH TOUCH-TONE ORDER ENTRY.						

RACK

260415641 RACK BOOK ADJUSTABLE STEEL BLACK F-10						
N		EA	1	1		1
260415849 RACK COMBINATION STEEL BLACK F-01						
N		EA	1	1		1

DISTRIBUTION SERVICES
 NETWORK SERVICES
 TOOLS
 BUILDING JANITORIAL
 AUTOMOTIVE
 FORMS/OFFICE SUPPLIES
 GENERAL
 DATA VOICE

RACK

PRODUCT IDENTIFIER		DESCRIPTION				
ITEM NUMBER	ORD. MULT.	SELL UNIT	STD. PKG. STOCK AVAILABILITY / PA	LEAD TIME	MIN. ORD.	A C
260415740			RACK COMBINATION STEEL TAN	E-99		
N		EA	1	1	1	
260415948			RACK DESK PLASTIC 6-TIER BLACK	E-82		
N		EA	1	1	1	
260416045			RACK DESK PLASTIC 6-TIER SMOKE	E-83		
N		EA	1	1	1	
			NOW AVAILABLE THROUGH TOUCH TONE ORDER ENTRY.			
260415542			RACK SORTING STEEL TAN	F-75		
N		EA	1	1	1	

PRODUCT IDENTIFIER		DESCRIPTION				
ITEM NUMBER	ORD. MULT.	SELL UNIT	STD. PKG. STOCK AVAILABILITY / PA	LEAD TIME	MIN. ORD.	A C

REFILL PEN

260416441			REFILL PEN BLPT FINE PT #11 BLUE	C-23		
N		EA	1	1	1	
			NOW AVAILABLE THROUGH TOUCH TONE ORDER ENTRY.			
260416540			REFILL PEN BLPT FINE PT #12 RED	C-24		
N		EA	1	1	1	
260416649			REFILL PEN BLPT FINE PT #14 BLACK	C-25		
N		EA	1	1	1	
			NOW AVAILABLE THROUGH TOUCH TONE ORDER ENTRY.			

REFILL CALENDAR

280004912			REFILL CALENDAR 3 X 3-3/4			
0001251	1	EA				
			NOW AVAILABLE THROUGH TOUCH-TONE ORDER ENTRY.			
400904603			REFILL CALENDAR PAD E313			
N		EA	1	2	1	
			Perfection 3.			
997506805			REFILL CALENDAR PAD E616			
2626002	1	EA	IL 33	IN 33	MI 33	OH 33
			Perfection 6.			
400488888			REFILL CALENDAR PAD E717			
1149237	1	EA	IL 33	IN 33	MI 33	OH 33
			Jumbo Gem.			
400522108			REFILL CALENDAR PAD E958			
2626028	1	EA	IL 33	IN 33	MI 33	OH 33
			Perfection 52.			

280006537			REFILL PEN BLPT FINE/BLU PILOT			
0001772	1	DZ	IL	IN	MI	OH
			NOW AVAILABLE THROUGH TOUCH TONE ORDER ENTRY.			

280006552			REFILL PEN BLPT FINE/GRN PILOT			
0001774	1	DZ	IL	IN	MI	OH
			NOW AVAILABLE THROUGH TOUCH TONE ORDER ENTRY.			

280006545			REFILL PEN BLPT FINE/RED PILOT			
0001773	1	DZ	IL	IN	MI	OH
			NOW AVAILABLE THROUGH TOUCH TONE ORDER ENTRY.			

260416144			REFILL PEN BLPT MEDIUM PT #1 BLUE	C-19		
N		EA	1	1	1	
			NOW AVAILABLE THROUGH TOUCH TONE ORDER ENTRY.			

260416243			REFILL PEN BLPT MEDIUM PT #2 RED	C-20		
N		EA	1	1	1	
			NOW AVAILABLE THROUGH TOUCH TONE ORDER ENTRY.			

260416342			REFILL PEN BLPT MEDIUM PT #4 BLACK	C-22		
N		EA	1	1	1	
			NOW AVAILABLE THROUGH TOUCH TONE ORDER ENTRY.			

REFILL ERASER

280006115			REFILL ERASER 3/TUBE			
0001705	1	TU				
			NOW AVAILABLE THROUGH TOUCH TONE ORDER ENTRY.			
260355425			REFILL ERASER CLIC 2/PK			
0001966	1	PK	IL	IN	MI	OH
			NOW AVAILABLE THROUGH TOUCH TONE ORDER ENTRY.			
280006123			REFILL ERASER QUICK CLICK			
0001706	1	TU	IL	IN	MI	OH
			NOW AVAILABLE THROUGH TOUCH TONE ORDER ENTRY.			
260432398			REFILL ERASER STAEDTLER			
0001832	1	EA	IL	IN	MI	OH
			NOW AVAILABLE THROUGH TOUCH TONE ORDER ENTRY.			

280006487			REFILL PEN BLPT MED/BLK PILOT			
0001767	1	DZ	IL	IN	MI	OH
			NOW AVAILABLE THROUGH TOUCH TONE ORDER ENTRY.			

280006495			REFILL PEN BLPT MED/BLU PILOT			
0001768	1	DZ	IL	IN	MI	OH
			NOW AVAILABLE THROUGH TOUCH TONE ORDER ENTRY.			

280006503			REFILL PEN BLPT MED/RED PILOT			
0001769	1	DZ	IL	IN	MI	OH
			NOW AVAILABLE THROUGH TOUCH TONE ORDER ENTRY.			

PRODUCT IDENTIFIER		DESCRIPTION					
ITEM NUMBER	ORD. MULT.	SELL UNIT	STD. PKG. STOCK	LEAD TIME AVAILABILITY / PA	MIN. ORD.	A C	
401859335 REFILL PEN FINE BLUE 594							
5621326	1	EA	IL 33	IN 33	MI OH WI		
280012667 REFILL PEN FINE CROSS BLACK							
0001787	1	EA	IL	IN MI OH WI			
NOW AVAILABLE THROUGH TOUCH-TONE ORDER ENTRY.							
280012659 REFILL PEN FINE CROSS BLUE							
0001785	1	EA	IL	IN MI OH WI			
NOW AVAILABLE THROUGH TOUCH-TONE ORDER ENTRY.							
260432406 REFILL PEN FLEXGRIP FINE BLUE							
0001833		EA	IL	IN MI OH WI			
NOW AVAILABLE THROUGH TOUCH-TONE ORDER ENTRY.							
400653960 REFILL PEN JM MEDIUM BLACK							
2736884	1	PK	IL 33	IN 33	MI 33 OH WI		
Package of 12.							
280012642 REFILL PEN MEDIUM CROSS BLACK							
0001786	1	EA	IL	IN MI OH WI			
NOW AVAILABLE THROUGH TOUCH-TONE ORDER ENTRY.							
280012691 REFILL PEN MEDIUM CROSS BLUE							
0001784	1	EA	IL	IN MI OH WI			
NOW AVAILABLE THROUGH TOUCH-TONE ORDER ENTRY.							

REINFORCEMENT

401158720 REINFORCEMENT HOLE NO.12 52-102						
N		CT	1	2		1
260416847 REINFORCEMENTS LABEL CLEAR 1-46						
N		BX	1	1		1
Self-adhesive, 200 per box.						
260416748 REINFORCEMENTS LABEL WHITE 1-45						
N		BX	1	1		1
Self-adhesive, 200 per box. NOW AVAILABLE THROUGH TOUCH TONE ORDER ENTRY.						

REMOVER STAPLE

280009135 REMOVER STAPLE						
0001419	1	EA				
NOW AVAILABLE THROUGH TOUCH-TONE ORDER ENTRY.						
260416946 REMOVER STAPLE WALNUT C-61						
N		EA	1	1		1
NOW AVAILABLE THROUGH TOUCH TONE ORDER ENTRY.						

PRODUCT IDENTIFIER		DESCRIPTION					
ITEM NUMBER	ORD. MULT.	SELL UNIT	STD. PKG. STOCK	LEAD TIME AVAILABILITY / PA	MIN. ORD.	A C	

RIBBON

Printer & Word Processing Ribbons, Cartridges & Printwheels.

280037466 RIBBON						
N		EA	36	11688	TK LP271LP051	
			1	2		1
LP07.						
300041829 RIBBON 037						
8408310	1	EA	IL 33	IN 33	MI OH WI 33	
280034836 RIBBON 037 J						
N		EA	1		2	1
280035221 RIBBON 077						
N		EA	1		2	1
300025244 RIBBON 103						
N		EA	1		2	1
300025269 RIBBON 103 Y BLACK & RED						
N		EA	1			
Standard manifold.						
280035239 RIBBON 104						
N		EA	1		2	1
280035247 RIBBON 107						
N		EA	1		2	1
280035254 RIBBON 137						
N		EA	1		2	1
300025285 RIBBON 147						
N		EA	1		2	1
260345665 RIBBON 157 TTY 43 NYLON/BLACK						
N		EA	1		2	1
260359930 RIBBON 157K						
N		EA	1		2	1
280035262 RIBBON 184						
N		EA	1		2	1
280034851 RIBBON 196						
N		EA	1		2	6
280034869 RIBBON 215 STAMCO						
N		EA	1		2	1
260359906 RIBBON 215C						
N		EA	1		2	1
260359898 RIBBON 215K						
N		EA	1		2	1
260359922 RIBBON 239						
N		EA	1		2	1
260359914 RIBBON 307C						
N		EA	1		1	1

DISTRIBUTION SERVICES

NETWORK SERVICES

TOOLS

BUILDING JANITORIAL

AUTOMOTIVE

FORMS/OFFICE SUPPLIES

GENERAL

DATA VOICE

RIBBON

DISTRIBUTION SERVICES

NETWORK SERVICES

TOOLS

BUILDING JANITORIAL

AUTOMOTIVE

FORMS/OFFICE SUPPLIES

GENERAL

DATA VOICE

PRODUCT IDENTIFIER		DESCRIPTION				
ITEM NUMBER	ORD. MULT.	SELL UNIT	STD. PKG. STOCK AVAILABILITY / PA	LEAD TIME	MIN. ORD.	A C
280035304		RIBBON	389 Y SPOOL			
N		EA	1	2	1	
260413810		RIBBON	416C IBM 7037979 BLACK			
N		EA	1	1	1	
280035312		RIBBON	422 Y SPOOL			
N		EA	1	2	1	
280035189		RIBBON	484			
N		EA	1	2	1	
260384649		RIBBON	505MC 4-COLOR			
N		EA	1	2	1	
300025301		RIBBON	553			
N		EA	1	2	1	
260413802		RIBBON	553C			
N		EA	1	1	1	
260416896		RIBBON	553K			
N		EA	1	2	1	
280035320		RIBBON	554			
N		EA	1	2	1	
280035338		RIBBON	554 Y			
N		EA	1	2	1	
280034893		RIBBON	573			
N		EA	1	2	1	
260416888		RIBBON	598C			
N		EA	1	2	1	
260411624		RIBBON	623C AT&T 577 #623			
N		EA	1	2	1	
260334578		RIBBON	639C IBM PROWRITER 4201			
N		EA	1	2	1	
280051657		RIBBON	640 C IBM PROPR 1040150			
N		EA	1	2	1	
280035361		RIBBON	753 MC			
N		EA	1	2	1	
260341375		RIBBON	777C OTC850-XL PRNTR			
N		EA	1	2	1	
280034919		RIBBON	803 IBM PC			
N		EA	1	2	1	
260364120		RIBBON	804C NEC P5200/5300			
N		EA	1	2	1	
			Printer 50-066 Black.			
260417712		RIBBON	816C AT&T 442 PRINTER			
N		EA	1	2	1	
			Black.			

PRODUCT IDENTIFIER		DESCRIPTION				
ITEM NUMBER	ORD. MULT.	SELL UNIT	STD. PKG. STOCK AVAILABILITY / PA	LEAD TIME	MIN. ORD.	A C
280034927		RIBBON	846 F/DATAPOINT			
N		EA	1	2	1	
			Printer 9281.			
280034935		RIBBON	930			
N		EA	1	2	1	
300025319		RIBBON	949 PLANTRONICS LA-36			
N		EA	1	2	1	
401160197		RIBBON	61218 TTY			
1236786	1	EA	IL IN MI OH WI			
			33 33			
			DISCONTINUE UPON STOCK DEPLETION			
400497178		RIBBON	61418 ALTA SPECIAL			
N		DZ	1	2	1	
997581467		RIBBON	61418 TTY			
N		DZ	1	2	1	
260359955		RIBBON	103			
N		EA	1	2	1	
260359963		RIBBON	103Y			
N		EA	1	2	1	
260347307		RIBBON	1212008 DECWRITER III TTY			
N		BX	1	2	1	
			36-12153-01, black, 6 per box.			
260355037		RIBBON	1299933 QW3 IBM			
N		EA	1	2	1	
260438668		RIBBON	505MJ FOUR COLOR			
N		EA	1	2	1	
280035353		RIBBON	7037980 313C			
N		EA	1	2	1	
280054230		RIBBON	BROTHER HR-15 025C BLACK			
N		EA	1	2	1	
280054313		RIBBON	CARBON 176 BLACK			
N		EA	1	2	1	
			Correctable.			
280034901		RIBBON	DP3121540502			
N		EA	1	2	1	
			Epson 6000, MX100XDP.			
260359880		RIBBON	DP31700-8502			
N		EA	1	2	1	
			MX80XDP.			
260432463		RIBBON	EPSON 7753			
0001987		EA	IL IN MI OH WI			
			NOW AVAILABLE THROUGH TOUCH-TONE ORDER ENTRY.			
280054339		RIBBON	FILM 001/057 BLACK 9/16IN			
N		DZ	1	2	1	

PRODUCT IDENTIFIER		DESCRIPTION				
ITEM NUMBER	ORD. MULT.	SELL UNIT	STD. PKG. STOCK AVAILABILITY / PA	LEAD TIME	MIN. ORD.	A C
280035049		RIBBON	FX100 630C	EPSON		
N		EA	1	2	1	
260422282		RIBBON	HEWLETT PACKARD 92155L	BLACK		
N		EA	1	2	1	
280054206		RIBBON	IBM 4224 #063C	BLACK		
N		EA	1	2	1	
			Multi purpose narrow.			
280054198		RIBBON	IBM 4224 #067C	BLACK		
N		EA	1	2	1	
			Multi purpose wide.			
280054180		RIBBON	IBM 4224 #070C			
N		EA	1	2	1	
			Color accent.			
280051038		RIBBON	IBM 1299300	CASSETTE		
N		EA	1	1	1	
			Correctable.			
280035270		RIBBON	IBM 1299463	CASSETTE		
N		EA	1	2	1	
280035288		RIBBON	IBM 1299463	CASSETTE		
N		EA	1	2	1	
280051046		RIBBON	IBM 1299508	CASSETTE		
N		EA	1	1	1	
			Correctable.			
280054305		RIBBON	IBM 1337765	CASSETTE #WWXGR		
N		EA	1	2	1	
280054297		RIBBON	IBM 1380999	CASSETTE		
N		EA	1	2	1	
280054248		RIBBON	IBM D CORRECTABLE #098			
N		EA	1	2	1	
			Black 5/16in.			
260359948		RIBBON	IBM II CORRECT S-037			
N		EA	1	2	1	
280051012		RIBBON	IBM LIFT-OFF TAPE 1136433			
N		EA	1	1	1	
			Spooled, orange.			
280051053		RIBBON	IBM QUIET 1299790			
N		EA	1	1	1	
			Non-correctable.			
280054263		RIBBON	IBM SELECTRIC II #137J			
N		EA	1	2	1	
			High yield 5/8in.			
280051020		RIBBON	IBM SELECTRIC II 1299095			
N		EA	1	1	1	
			Correctable.			
280054255		RIBBON	IBM SELECTRIC II CART #044			
N		EA	1	2	1	

PRODUCT IDENTIFIER		DESCRIPTION				
ITEM NUMBER	ORD. MULT.	SELL UNIT	STD. PKG. STOCK AVAILABILITY / PA	LEAD TIME	MIN. ORD.	A C
280051061		RIBBON	IBM TECH III 1136391			
N		EA	1	1	1	
260343066		RIBBON	IMAGewriter II BLACK 107L			
N		EA	1	1	1	
280035106		RIBBON	LQP02	MULTISTRIKE		
N		BX	1	2	1	
260357447		RIBBON	LQP03-KA	BLACK BOX OF 6		
N		BX	1	2	1	
300076940		RIBBON	LQP03-KA	DEC CASSETTE		
8412247	1	BX	IL 33	IN 33	MI OH WI 33	
			For use in digital printer. DISCONTINUE UPON STOCK DEPLETION.			
280054222		RIBBON	MARC II CARTRIDGE #374Y			
N		EA	1	2	1	
			Black and red.			
280035114		RIBBON	MICROLINE 84/94 728C			
N		EA	1	2	1	
			Okidata printer.			
280035122		RIBBON	MT160 609255-1	F/PC		
N		CT	1	2	1	
			5 per carton.			
300027554		RIBBON	MX/FX100 630			
N		EA	1	2	1	
			For Epson MX100 1/2in x 30yd.			
280051780		RIBBON	OKIDATA 182			
0001229	1	EA	IL	IN MI OH WI		
			NOW AVAILABLE THROUGH TOUCH TONE ORDER ENTRY.			
260422290		RIBBON	OKIDATA MICROLINE 100 SERIES			
N		EA	1	2	6	
			Black nylon IP-414.			
280035197		RIBBON	P351	TOSHIBA		
N		EA	1	2	1	
260333638		RIBBON	PRINTER TTY MODEL 40			
N		EA	1	8	1	
			02-T491-5NB.			
280035163		RIBBON	R9325	FOR APPLE		
N		EA	1	2	1	
			Imagewriter.			
260360359		RIBBON	S549 NYLON DATASPEED 40			
N		EA	1	2	1	
260330402		RIBBON	SIEMENS PRINTER 9013, #692			
N		EA	1	2	1	
260338132		RIBBON	SIEMENS PT80 PRINTER			
N		EA	6	2	6	

DISTRIBUTION SERVICES
 NETWORK SERVICES
 TOOLS
 BUILDING JANITORIAL
 AUTOMOTIVE
 FORMS/OFFICE SUPPLIES
 GENERAL
 DATA VOICE

RIBBON

DISTRIBUTION SERVICES

PRODUCT IDENTIFIER		DESCRIPTION				
ITEM NUMBER	ORD. MULT.	SELL UNIT	STD. PKG. STOCK AVAILABILITY / PA	LEAD TIME	MIN. ORD.	A C

001213974 RIBBON ST 108 00 DEC
 N EA 1 2 1
 For use in digital printer.

NETWORK SERVICES

260357405 RIBBON TOSHIBA P351SX BLACK
 N EA 1 2 1

RIBBON PRINTER

TOOLS

260334032 RIBBON PRINTER 02-B140
 N EA 1 1 1

260332762 RIBBON PRINTER 02-B191
 N EA 1 1 1

260333893 RIBBON PRINTER 02-BM 96 3/4
 N EA 1 1 1

260331947 RIBBON PRINTER 02-BM114
 N EA 1 1 1

BUILDING JANITORIAL

260334230 RIBBON PRINTER 02-BM122
 N BX 1 1 1

260332887 RIBBON PRINTER 02-BM143
 N BX 1 1 1

260333943 RIBBON PRINTER 02-BM148
 N BX 1 1 1

AUTOMOTIVE

260333927 RIBBON PRINTER 02-BM152
 N EA 1 1 1

260334115 RIBBON PRINTER 02-BM153-ZP
 N BX 1 1 1

260334057 RIBBON PRINTER 02-BM160
 N EA 1 1 1

FORMS/OFFICE SUPPLIES

260332853 RIBBON PRINTER 02-BM171
 N EA 1 1 1

260334214 RIBBON PRINTER 02-BM172
 N EA 1 1 1

260334156 RIBBON PRINTER 02-BM173
 N EA 1 1 1

GENERAL

260334206 RIBBON PRINTER 02-BM188
 N EA 1 1 1

260334222 RIBBON PRINTER 02-BM198
 N EA 1 1 1

260332788 RIBBON PRINTER 02-BM203
 N EA 1 1 1

DATA VOICE

260332796 RIBBON PRINTER 02-BM204
 N EA 1 1 1

260334297 RIBBON PRINTER 02-BM217
 N EA 1 1 1

PRODUCT IDENTIFIER		DESCRIPTION				
ITEM NUMBER	ORD. MULT.	SELL UNIT	STD. PKG. STOCK AVAILABILITY / PA	LEAD TIME	MIN. ORD.	A C

260334263 RIBBON PRINTER 02-BM218
 N EA 1 1 1

260332739 RIBBON PRINTER 02-BM219
 N EA 1 1 1

260333919 RIBBON PRINTER 02-BM221
 N EA 1 1 1

260334123 RIBBON PRINTER 02-BM222
 N EA 1 1 1

260333281 RIBBON PRINTER 02-IP414(1-UP)
 N EA 1 1 1

260333224 RIBBON PRINTER 02-IP441(1-UP)
 N EA 1 1 1

260333307 RIBBON PRINTER 02-IP466(1-UP)
 N EA 1 1 1

260333505 RIBBON PRINTER 02-IP519(1-UP)
 N EA 1 1 1

260333273 RIBBON PRINTER 02-T414-4NB
 N PK 1 1 1

260333406 RIBBON PRINTER 02-T438-4NB
 N PK 1 1 1

260333216 RIBBON PRINTER 02-T441-4NB
 N EA 1 1 1

260333448 RIBBON PRINTER 02-T442-4NB
 N PK 1 1 1

260333570 RIBBON PRINTER 02-T461-5NB
 N EA 1 1 1

260333232 RIBBON PRINTER 02-T464-4NB
 N BX 1 1 1

260333299 RIBBON PRINTER 02-T466-4NB
 N BX 1 1 1

260333208 RIBBON PRINTER 02-T483-4NB
 N BX 1 1 1

260333257 RIBBON PRINTER 02-T484-5NB
 N BX 1 1 1

260333315 RIBBON PRINTER 02-T487-4NB
 N PK 1 1 1

260333109 RIBBON PRINTER 02-T499-4NB
 N BX 1 1 1

260333539 RIBBON PRINTER 02-T500-4NB
 N PK 1 1 1

260333471 RIBBON PRINTER 02-T517-5NB
 N PK 1 1 1

RIBBON TYPEWRITER

PRODUCT IDENTIFIER DESCRIPTION

ITEM NUMBER	ORD. MULT.	SELL UNIT	STD. PKG. STOCK	LEAD TIME AVAILABILITY / PA	MIN. ORD.	A C
-------------	------------	-----------	-----------------	-----------------------------	-----------	-----

260333497 RIBBON PRINTER 02-T519-5NB
N EA 1 1 1

260333513 RIBBON PRINTER 02-T521-4NB
N PK 1 1 1

402617849 RIBBON PRINTER 1136653 IBM
N EA 1 2 1

280054909 RIBBON PRINTER EPSON 1500LQP NYLON 534
N EA 1 2 1
Black.

260334107 RIBBON PRINTER EPSON 8750
0001982 1 EA IL IN MI OH WI
NOW AVAILABLE THROUGH TOUCH-TONE ORDER ENTRY.

260364500 RIBBON PRINTER EPSON GENUINE 8755B
0001983 EA IL IN MI OH WI
NOW AVAILABLE THROUGH TOUCH-TONE ORDER ENTRY.

300025194 RIBBON PRINTER LA10R-06 DEC CASSETTE
8403279 1 BX IL IN MI OH WI
33 33 33 33
For use in digital printer.

280015330 RIBBON PRINTER LA10/100/38/34
N BX 1 2 1

280035098 RIBBON PRINTER LA12-06
N EA 1 2 6

401868476 RIBBON PRINTER LA36R-12 DEC BOX OF 12
5343202 1 BX IL IN MI OH WI
03
For use in digital printer.

260347299 RIBBON PRINTER LA50R-06/LX LA75 DEC
N BX 1 2 1
6 per box, black.

300025202 RIBBON PRINTER LA50R-1D DEC CASSETTE
1133876 1 BX IL IN MI OH WI
33 33 33
For Digital LA50 & LA75 printers, box of 72.

260333901 RIBBON PRINTER LEE DATA 3121 COMPATIBLE
0001981 1 EA IL IN MI OH WI
NOW AVAILABLE THROUGH TOUCH-TONE ORDER ENTRY.

260355508 RIBBON PRINTER TOSHIBA BLACK
N EA 6 1 6
Model P321, P351, P1340, P1351.

260333638 RIBBON PRINTER TTY MODEL 40
0001980 1 EA IL IN MI OH WI
NOW AVAILABLE THROUGH TOUCH-TONE ORDER ENTRY.

PRODUCT IDENTIFIER DESCRIPTION

ITEM NUMBER	ORD. MULT.	SELL UNIT	STD. PKG. STOCK	LEAD TIME AVAILABILITY / PA	MIN. ORD.	A C
-------------	------------	-----------	-----------------	-----------------------------	-----------	-----

RIBBON TYPEWRITER

401361274 RIBBON TYPEWRITER 1 OLYMPIA
N DZ 1 1 1

401361282 RIBBON TYPEWRITER 1A OLYMPIA
N DZ 1 1 1

260331962 RIBBON TYPEWRITER 02-B168
N EA 1 1 1

260333836 RIBBON TYPEWRITER 02-B214
N EA 1 1 1

260332044 RIBBON TYPEWRITER 02-B86HD
N EA 1 1 1

260332630 RIBBON TYPEWRITER 02-B86HY
N EA 1 1 1

260332648 RIBBON TYPEWRITER 02-C40
N BX 1 1 1

260332663 RIBBON TYPEWRITER 02-C41P
N EA 1 1 1

260332150 RIBBON TYPEWRITER 02-T28-P0B
N BX 1 1 1

260332457 RIBBON TYPEWRITER 02-T315-C0B
N PK 1 1 1

260332192 RIBBON TYPEWRITER 02-T340-C0B
N EA 1 1 1

260332101 RIBBON TYPEWRITER 02-T383-DAB
N PK 1 1 1

260332127 RIBBON TYPEWRITER 02-T387-HYB
N PK 1 1 1

260332275 RIBBON TYPEWRITER 02-T392-MSB
N BX 1 1 1

260332416 RIBBON TYPEWRITER 02-T394-COB
N PK 1 1 1

260332556 RIBBON TYPEWRITER 02-T398-C0B
N BX 1 1 1

401361308 RIBBON TYPEWRITER 12215 ROYAL 6A
N DZ 1 2 1

400496964 RIBBON TYPEWRITER 61418 TTY
N DZ 1 2 1
Special ATT spec R-1M item 2.

400548970 RIBBON TYPEWRITER POLY 9/16 R235
N DZ 1 2 12

DISTRIBUTION SERVICES

NETWORK SERVICES

TOOLS

BUILDING JANITORIAL

AUTOMOTIVE

FORMS/OFFICE SUPPLIES

GENERAL

DATA VOICE

RING

PRODUCT IDENTIFIER		DESCRIPTION				
ITEM NUMBER	ORD. MULT.	SELL UNIT	STD. PKG. STOCK AVAILABILITY / PA	LEAD TIME	MIN. ORD.	A C

RING

260414057	N	EA	1	1	1	
RING 1IN DIAMETER C-62						
Ring only, for ring book. NOW AVAILABLE THROUGH TOUCH TONE ORDER ENTRY.						

280005091	0001401	1	BX	IL IN MI OH WI		
RING BOOK 1 INCH DIAMETER						
NOW AVAILABLE THROUGH TOUCH-TONE ORDER ENTRY.						

280005109	0001402	1	BX	IL IN MI OH WI		
RING BOOK 2 INCH DIAMETER						
NOW AVAILABLE THROUGH TOUCH-TONE ORDER ENTRY.						

260414156	N	EA	1	1	1	
RING BOOK (RING ONLY) 1 1/2IN C-63						
Ring only, for ring book. NOW AVAILABLE THROUGH TOUCH TONE ORDER ENTRY.						

RING BINDER

SEE BINDER RING.

RUBBER BAND

SEE BAND RUBBER.

RULER

260414859	N	EA	1	1	1	
RULER 6IN WOOD SINGLE-EDGE C-64						
NOW AVAILABLE THROUGH TOUCH TONE ORDER ENTRY.						

401222104	N	DZ	1	3	12	
RULER 12IN BOXWOOD DOUBLE EDGE						

280005075	0001287	1	EA	IL IN MI OH WI		
RULER 12IN CLEAR PLASTIC						
NOW AVAILABLE THROUGH TOUCH-TONE ORDER ENTRY.						

280005083	0001288	1	EA	IL IN MI OH WI		
RULER 18IN WOOD						
NOW AVAILABLE THROUGH TOUCH-TONE ORDER ENTRY.						

260414958	N	EA	1	1	1	
RULER 18IN WOOD SINGLE-EDGE C-65						
NOW AVAILABLE THROUGH TOUCH TONE ORDER ENTRY.						

401615893	N					
RULER 6IN SINGLE EDGE						

PRODUCT IDENTIFIER		DESCRIPTION				
ITEM NUMBER	ORD. MULT.	SELL UNIT	STD. PKG. STOCK AVAILABILITY / PA	LEAD TIME	MIN. ORD.	A C

260415054	N	EA	1	1	1	
RULER WOOD DOUBLE SIDED 12IN J-86						
NOW AVAILABLE THROUGH TOUCH-TONE ORDER ENTRY.						

SCISSORS

280009036	0001315	1	EA			
SCISSORS 8IN						
NOW AVAILABLE THROUGH TOUCH-TONE ORDER ENTRY.						

260415153	N	EA	1	1	1	
SCISSORS 8IN C-67						
NOW AVAILABLE THROUGH TOUCH TONE ORDER ENTRY.						

260415252	N	EA	1	1	1	
SCISSORS 9IN I-69						
NOW AVAILABLE THROUGH TOUCH TONE ORDER ENTRY.						

260415351	N	EA	1	1	1	
SCISSORS 10IN I-70						

SCISSORS POCKET

455000398	2754481	1	EA	IL IN MI OH WI		
33 33 33 33 33						
Part of first aid boxes and Central Office emergency cabinets.						

SEPARATOR

300025327	8403436	1	SH			
SEPARATOR 8 3/4IN X 11 1/4IN						
3 hole punch, tan, 65# cover stock vellum Nekoosa.						

995871290	N	RL	1	7	1	
SEPARATOR CK07246						

SHARPENER

997585500	1217174	1	EA			
SHARPENER PENCIL APSCO						
Chicago AP1006.						

401185012	1259424	1	EA	IL IN MI OH WI		
SHARPENER PENCIL BOSTON MODEL L						
33 33 33						

260415930	N	EA	1	1	1	
SHARPENER PENCIL ELECTRIC BEIGE I-36						
NOW AVAILABLE THROUGH TOUCH TONE ORDER ENTRY.						

280006586	0001749	1	EA	IL IN MI OH WI		
SHARPENER PENCIL TAN/BRN						
NOW AVAILABLE THROUGH TOUCH-TONE ORDER ENTRY.						

PRODUCT IDENTIFIER DESCRIPTION						
ITEM NUMBER	ORD. MULT.	SELL UNIT	STD. PKG. STOCK AVAILABILITY / PA	LEAD TIME	MIN. ORD.	A C
SHEARS						
400265807			SHEARS OFFICE 8IN S-5			
N		EA	1	2	1	
SHEET INDEX						
SHIELD						
900314568			SHIELD CAP RECEIVER 5IN X 8IN			
1187294	1	BX				
Rough textured tissue for cleaning Operator Services headsets and telephone receiver caps. Not intended for use as facial tissue.						
SHIELD ERASING						
260410634			SHIELD ERASING 3 5/8 X 2 5/8IN J-28			
N		EA	1	1	1	
Metal.						
SLATE MAGIC						
900553611			SLATE MAGIC 3IN X 5IN WITH STYLUS			
N		EA	1	2	1	
Carton of 500.						
SMOCK						
280035502			SMOCK 88064 DMW LARGE			
N		EA	1	2	1	
280035510			SMOCK 88064 DMW MEDIUM			
N		EA	1	2	1	
280035528			SMOCK 88064 DMW SMALL			
N		EA	1	2	1	
260417688			SMOCK 88064 DMW XLARGE BLUE			
N		EA	1	2	1	
280035536			SMOCK 88064 RRX LARGE			
N		EA	1	2	1	
280051582			SMOCK 88064 RRX MEDIUM			
N		EA	1	2	1	
280035544			SMOCK 88064 RRX SMALL			
N		EA	1	2	1	
260417696			SMOCK 88064 RRX XLARGE PINK			
N		EA	1	2	1	

PRODUCT IDENTIFIER DESCRIPTION						
ITEM NUMBER	ORD. MULT.	SELL UNIT	STD. PKG. STOCK AVAILABILITY / PA	LEAD TIME	MIN. ORD.	A C
STAMP						
260338355			STAMP AMERITECH PRIVATE RUBBER			
N		EA	1	2	1	
260338389			STAMP CONFIDENTIAL-PRE INKED			
N		EA	1	2	1	
260338371			STAMP CONFIDENTIAL-RUBBER			
N		EA	1	2	1	
400551099			STAMP DATING 1 1/2			
1167494	1	EA				
IL IN MI OH WI 33						
260339577			STAMP DECLASSIFICATION			
N		EA	1	2	1	
260338363			STAMP PRIVATE-PRE INKED			
N		EA	1	2	1	
STAND CALENDAR						
280004953			STAND CALENDAR BASE PUTTY			
0001254	1	EA				
USED WITH REFILL 3 X 3-3/4. NOW AVAILABLE THROUGH TOUCH-TONE ORDER ENTRY.						
403114788			STAND CALENDAR E17-05 BROWN			
1306845	1	EA				
IL IN MI OH WI 33 33 33 33 33 Plastic Jumbo Gem.						
403114937			STAND CALENDAR E58-05 BROWN			
1306837	1	EA				
IL IN MI OH WI 33 33 33 33 33 Plastic.						
STAND PRINTER						
260354386			STAND PRINTER ACRYLIC 80 COL			
0001926	1	EA				
NOW AVAILABLE THROUGH TOUCH-TONE ORDER ENTRY.						
260354378			STAND PRINTER ACRYLIC 130 COL			
0001927	1	EA				
IL IN MI OH WI NOW AVAILABLE THROUGH TOUCH-TONE ORDER ENTRY.						
STAPLE						
280050212			STAPLE 8R1177			
N		CT	1	2	1	
260355656			STAPLE 6242			
N		BX	1	1	1	

DISTRIBUTION SERVICES
NETWORK SERVICES
TOOLS
BUILDING JANITORIAL
AUTOMOTIVE
FORMS/OFFICE SUPPLIES
GENERAL
DATA VOICE

DISTRIBUTION SERVICES

NETWORK SERVICES

TOOLS

BUILDING JANITORIAL

AUTOMOTIVE

FORMS/OFFICE SUPPLIES

GENERAL

DATA VOICE

STAPLE

PRODUCT IDENTIFIER		DESCRIPTION						
ITEM NUMBER	ORD. MULT.	SELL UNIT	STD. PKG. STOCK AVAILABILITY / PA	LEAD TIME	MIN. ORD.	A	C	
260324603 STAPLE 50050								
N		EA	1	2	1			
260368956 STAPLE 8R2253 XEROX 1065								
N		CT	1	2	1			
260416052 STAPLE BOSTITCH HD 1/4IN C-75								
N		PK	1	1	1			
Heavy Duty, 1000 per box. NOW AVAILABLE THROUGH TOUCH TONE ORDER ENTRY.								
455005553 STAPLE BOSTITCH SB8								
1265181	1	BX	IL 08	IN 08	MI 08	OH	WI	
260416151 STAPLE BOSTITCH STANDARD 1/4IN C-74								
N		BX	1	1	1			
5000 per box. NOW AVAILABLE THROUGH TOUCH TONE ORDER ENTRY.								
260422183 STAPLE CARTRIDGE #50050 SEE PID260324603								
N		CT	1	2	1			
260357090 STAPLE COPIER K555								
N		BX	1	2	1			
260357108 STAPLE COPIER K557								
N		BX	1	2	1			
260357124 STAPLE COPIER K657B								
N		BX	1	2	1			
260446489 STAPLE FOR KODAK 90, 5K CRTRDGE 1438589								
N		EA	1	2	1			
For Kodak 90 copier.								
260446505 STAPLE FOR KODAK 95, 5K CRTRDGE 1626514								
N		EA	1	2	1			
For Kodak 95 copier.								
260360300 STAPLE KODAK 817-8695								
N		BX	1	2	1			
280005307 STAPLE STANDARD								
0001421	1	BX	IL	IN	MI	OH	WI	
NOW AVAILABLE THROUGH TOUCH-TONE ORDER ENTRY.								
400551024 STAPLE SWINGLINE 1/2IN X 1/4IN								
N		BX	1	2	1			
Cohered type for use in Swingline No. 77S and Swingline No. 400S.								
260360334 STAPLE WIRE KODAK 175-5057								
N		BX	1	2	1			

PRODUCT IDENTIFIER		DESCRIPTION						
ITEM NUMBER	ORD. MULT.	SELL UNIT	STD. PKG. STOCK AVAILABILITY / PA	LEAD TIME	MIN. ORD.	A	C	

STAPLE REMOVER
SEE REMOVER STAPLE.

STAPLER
280005281 STAPLER DESK FC-17 BLACK
0001423 1 EA
NOW AVAILABLE THROUGH TOUCH-TONE ORDER ENTRY.

260416250 STAPLER DESK FC-17 BLACK D-39
N EA 1 1 1
NOW AVAILABLE THROUGH TOUCH TONE ORDER ENTRY.

280005273 STAPLER DESK FC-17 GRAY
0001420 1 EA IL IN MI OH WI
NOW AVAILABLE THROUGH TOUCH TONE ORDER ENTRY.

280005299 STAPLER DESK FC-17 PUTTY
0001424 1 EA IL IN MI OH WI
NOW AVAILABLE THROUGH TOUCH TONE ORDER ENTRY.

260416359 STAPLER DESK FC-17 TAN D-40
N EA 1 1 1

260416458 STAPLER DESK FC-17 WALNUT D-41
N EA 1 1 1

260416557 STAPLER DESK GRAY D-42
N EA 1 1 1

402767925 STAPLER MACHINE 444 SWINGLINE
N EA 1 6 1
Heavy duty stapler for frequent use.

900175001 STAPLER SWINGLINE 99 W/REMOVER
N EA 1 2 1

STITCHER WIRE
280050220 STITCHER WIRE 8R1174 FOR XEROX 5090
N RO 1 2 1

STRAP
402052005 STRAP LN93S BSES-4305-7
N EA 12 2 12

STRIP
280035684 STRIP CARRIER PLANHOLD
N RO 1 2 1
Masterfile 075AR 1 roll per box.

PRODUCT IDENTIFIER		DESCRIPTION				
ITEM NUMBER	ORD. MULT.	SELL UNIT	STD. PKG. STOCK AVAILABILITY / PA	LEAD TIME	MIN. ORD.	A C
TAB						
280005463 TAB HANGING FILE CLEAR 1/3 CUT						
0001517	1	BX				
Box of 25. NOW AVAILABLE THROUGH TOUCH-TONE ORDER ENTRY.						
280005471 TAB HANGING FILE CLEAR 1/5 CUT						
0001518	1	BX	IL IN MI OH WI			
Box of 25. NOW AVAILABLE THROUGH TOUCH-TONE ORDER ENTRY.						
260414867 TAB INSERT 1/3 CUT BLUE G-14						
N		BX	1	1	1	
With blank white inserts, 25 per box.						
260415161 TAB INSERT 1/3 CUT CLEAR F-90						
N		BX	1	1	1	
With blank white inserts, 25 per box. NOW AVAILABLE THROUGH TOUCH-TONE ORDER ENTRY.						
260414768 TAB INSERT 1/3 CUT GREEN G-13						
N		BX	1	1	1	
With blank white inserts, 25 per box.						
260414966 TAB INSERT 1/3 CUT PINK G-15						
N		BX	1	1	1	
With blank white inserts, 25 per box.						
260414669 TAB INSERT 1/3 CUT RED G-12						
N		BX	1	1	1	
With blank white inserts, 25 per box.						
260415567 TAB INSERT 1/3 CUT WHITE G-19						
N		SE	1	1	1	
Printed A-Z, 25 tabs.						
260415260 TAB INSERT 1/3 CUT WHITE G-25						
N		BX	1	1	1	
Extra inserts. NOW AVAILABLE THROUGH TOUCH TONE ORDER ENTRY.						
260415062 TAB INSERT 1/3 CUT YELLOW G-16						
N		BX	1	1	1	
With blank white inserts, 25 per box.						
260414164 TAB INSERT 1/5 CUT BLUE G-09						
N		BX	1	1	1	
With blank white inserts, 25 per box. NOW AVAILABLE THROUGH TOUCH-TONE ORDER ENTRY.						
260414560 TAB INSERT 1/5 CUT CLEAR F-89						
N		BX	1	1	1	
With blank white inserts, 25 per box. NOW AVAILABLE THROUGH TOUCH TONE ORDER ENTRY.						
260414065 TAB INSERT 1/5 CUT GREEN G-08						
N		BX	1	1	1	
With blank white inserts, 25 per box. NOW AVAILABLE THROUGH TOUCH-TONE ORDER ENTRY.						

PRODUCT IDENTIFIER		DESCRIPTION				
ITEM NUMBER	ORD. MULT.	SELL UNIT	STD. PKG. STOCK AVAILABILITY / PA	LEAD TIME	MIN. ORD.	A C
260414263 TAB INSERT 1/5 CUT PINK G-10						
N		BX	1	1	1	
With blank white inserts, 25 per box. NOW AVAILABLE THROUGH TOUCH-TONE ORDER ENTRY.						
260416953 TAB INSERT 1/5 CUT RED G-07						
N		BX	1	1	1	
With blank white inserts, 25 per box. NOW AVAILABLE THROUGH TOUCH-TONE ORDER ENTRY.						
260415666 TAB INSERT 1/5 CUT WHITE G-21						
N		SE	1	1	1	
Printed, DAILY 1-31.						
260415369 TAB INSERT 1/5 CUT WHITE G-26						
N		BX	1	1	1	
Extra inserts. NOW AVAILABLE THROUGH TOUCH-TONE ORDER ENTRY.						
260414362 TAB INSERT 1/5 CUT YELLOW G-11						
N		BX	1	1	1	
With blank white inserts, 25 per box. NOW AVAILABLE THROUGH TOUCH-TONE ORDER ENTRY.						
280005414 TAB INSERT BLANK 1/3 CUT						
0001512	1	PK	IL IN MI OH WI			
100 per pack. NOW AVAILABLE THROUGH TOUCH-TONE ORDER ENTRY.						
280005422 TAB INSERT BLANK 1/5 CUT						
0001513	1	PK	IL IN MI OH WI			
100 per pack. NOW AVAILABLE THROUGH TOUCH-TONE ORDER ENTRY.						
280005448 TAB SNAP-ON PLASTIC 2IN						
0001515	1	BX	IL IN MI OH WI			
NOW AVAILABLE THROUGH TOUCH-TONE ORDER ENTRY.						
260415468 TAB SNAP-ON PLASTIC 2IN						
N		PK	1	1	1	G-17
25 per package.						
280005430 TAB SNAP-ON PLASTIC 3-1/2IN						
0001514	1	BX	IL IN MI OH WI			
NOW AVAILABLE THROUGH TOUCH-TONE ORDER ENTRY.						
TAB INDEX						
280005679 TAB INDEX 1/3IN CLEAR STRIP TABBING						
0001536	1	BX				
5FT Per Box. NOW AVAILABLE THROUGH TOUCH-TONE ORDER ENTRY.						
260416755 TAB INDEX 6 X 1 X 1/2IN EXTENSN C-76						
N		PK	1	1	1	
Gray cloth, 12 per pack.						

DISTRIBUTION SERVICES
 NETWORK SERVICES
 TOOLS
 BUILDING JANITORIAL
 AUTOMOTIVE
 FORMS/OFFICE SUPPLIES
 GENERAL
 DATA VOICE

TAB INDEX

DISTRIBUTION SERVICES

PRODUCT IDENTIFIER		DESCRIPTION					
ITEM NUMBER	ORD. MULT.	SELL UNIT	STD. PKG. STOCK AVAILABILITY / PA	LEAD TIME	MIN. ORD.	A	C
260416854		TAB INDEX 6 X 1 X 1/2IN EXTENSN C-82					
N		BX	1	1	1		
Mylar, clear, 5 packs per box, two 6IN strips per package. NOW AVAILABLE THROUGH TOUCH-TONE ORDER ENTRY.							

NETWORK SERVICES

PRODUCT IDENTIFIER		DESCRIPTION					
ITEM NUMBER	ORD. MULT.	SELL UNIT	STD. PKG. STOCK AVAILABILITY / PA	LEAD TIME	MIN. ORD.	A	C
280005620		TAB INDEX CLEAR SET OF 5					
0001531	1	SE	IL IN MI OH WI				
NOW AVAILABLE THROUGH TOUCH-TONE ORDER ENTRY.							

TOOLS

PRODUCT IDENTIFIER		DESCRIPTION					
ITEM NUMBER	ORD. MULT.	SELL UNIT	STD. PKG. STOCK AVAILABILITY / PA	LEAD TIME	MIN. ORD.	A	C
280005646		TAB INDEX CLEAR SET OF 8					
0001533	1	SE	IL IN MI OH WI				
NOW AVAILABLE THROUGH TOUCH-TONE ORDER ENTRY.							

BUILDING JANITORIAL

PRODUCT IDENTIFIER		DESCRIPTION					
ITEM NUMBER	ORD. MULT.	SELL UNIT	STD. PKG. STOCK AVAILABILITY / PA	LEAD TIME	MIN. ORD.	A	C
280005638		TAB INDEX COLOR SET OF 5					
0001532	1	SE	IL IN MI OH WI				
NOW AVAILABLE THROUGH TOUCH-TONE ORDER ENTRY.							

AUTOMOTIVE

PRODUCT IDENTIFIER		DESCRIPTION					
ITEM NUMBER	ORD. MULT.	SELL UNIT	STD. PKG. STOCK AVAILABILITY / PA	LEAD TIME	MIN. ORD.	A	C
280005653		TAB INDEX COLOR SET OF 8					
0001534	1	SE	IL IN MI OH WI				
NOW AVAILABLE THROUGH TOUCH-TONE ORDER ENTRY.							

FORMS/OFFICE SUPPLIES

PRODUCT IDENTIFIER		DESCRIPTION					
ITEM NUMBER	ORD. MULT.	SELL UNIT	STD. PKG. STOCK AVAILABILITY / PA	LEAD TIME	MIN. ORD.	A	C
400469128		TAB INDEX GRAY CLOTH 36 1 X 11IN					
1269944	1	EN	IL IN MI OH WI				
50 tabs per envelope, 12 envelopes per carton, stock 36A reinforcement 5 digit code 59-106.							

GENERAL

PRODUCT IDENTIFIER		DESCRIPTION					
ITEM NUMBER	ORD. MULT.	SELL UNIT	STD. PKG. STOCK AVAILABILITY / PA	LEAD TIME	MIN. ORD.	A	C
400469136		TAB INDEX GRAY CLOTH 7/16 X 11IN					
1269928	1	EN	IL IN MI OH WI				
A strong tab for general indexing, 50 tabs per envelope, 12 envelopes per carton, 59-105.							

DATA VOICE

PRODUCT IDENTIFIER		DESCRIPTION					
ITEM NUMBER	ORD. MULT.	SELL UNIT	STD. PKG. STOCK AVAILABILITY / PA	LEAD TIME	MIN. ORD.	A	C
260410576		TAB INDEX INSERTABLE BLUE H-62					
N		BX	1	1	1		
5FT per box, 1/3IN extension, 6IN strip. NOW AVAILABLE THROUGH TOUCH TONE ORDER ENTRY.							

PRODUCT IDENTIFIER		DESCRIPTION					
ITEM NUMBER	ORD. MULT.	SELL UNIT	STD. PKG. STOCK AVAILABILITY / PA	LEAD TIME	MIN. ORD.	A	C
260410378		TAB INDEX INSERTABLE CLEAR H-58					
N		BX	1	1	1		
5ft per box, 1/3IN extension, 6IN strip. NOW AVAILABLE THROUGH TOUCH TONE ORDER ENTRY.							

PRODUCT IDENTIFIER		DESCRIPTION					
ITEM NUMBER	ORD. MULT.	SELL UNIT	STD. PKG. STOCK AVAILABILITY / PA	LEAD TIME	MIN. ORD.	A	C
260410675		TAB INDEX INSERTABLE RED H-63					
N		BX	1	1	1		
5FT per box, 1/3IN extension, 6IN strip. NOW AVAILABLE THROUGH TOUCH TONE ORDER ENTRY.							

PRODUCT IDENTIFIER		DESCRIPTION					
ITEM NUMBER	ORD. MULT.	SELL UNIT	STD. PKG. STOCK AVAILABILITY / PA	LEAD TIME	MIN. ORD.	A	C
260410477		TAB INDEX INSERTABLE YELLOW H-59					
N		BX	1	1	1		
5FT per box, 1/3IN extension, 6IN strip. NOW AVAILABLE THROUGH TOUCH TONE ORDER ENTRY.							

PRODUCT IDENTIFIER		DESCRIPTION					
ITEM NUMBER	ORD. MULT.	SELL UNIT	STD. PKG. STOCK AVAILABILITY / PA	LEAD TIME	MIN. ORD.	A	C
280005570		TAB INDEX RING BINDER ALPHA					
0001528	1	SE	IL IN MI OH WI				
11 X 8-1/2IN White. NOW AVAILABLE THROUGH TOUCH-TONE ORDER ENTRY.							

PRODUCT IDENTIFIER		DESCRIPTION					
ITEM NUMBER	ORD. MULT.	SELL UNIT	STD. PKG. STOCK AVAILABILITY / PA	LEAD TIME	MIN. ORD.	A	C
280005596		TAB INDEX RING BINDER MONTHLY					
0001530	1	SE	IL IN MI OH WI				
11 X 8-1/2IN White. NOW AVAILABLE THROUGH TOUCH-TONE ORDER ENTRY.							

PRODUCT IDENTIFIER		DESCRIPTION					
ITEM NUMBER	ORD. MULT.	SELL UNIT	STD. PKG. STOCK AVAILABILITY / PA	LEAD TIME	MIN. ORD.	A	C
280005588		TAB INDEX RING BINDER #'S 1-10					
0001529	1	SE	IL IN MI OH WI				
11 X 8-1/2IN White. NOW AVAILABLE THROUGH TOUCH-TONE ORDER ENTRY.							

PRODUCT IDENTIFIER		DESCRIPTION					
ITEM NUMBER	ORD. MULT.	SELL UNIT	STD. PKG. STOCK AVAILABILITY / PA	LEAD TIME	MIN. ORD.	A	C
280005612		TAB INDEX RING BINDER #'S 1-31					
0001547	1	SE	IL IN MI OH WI				
11 X 8-1/2IN White. NOW AVAILABLE THROUGH TOUCH-TONE ORDER ENTRY.							

PRODUCT IDENTIFIER		DESCRIPTION					
ITEM NUMBER	ORD. MULT.	SELL UNIT	STD. PKG. STOCK AVAILABILITY / PA	LEAD TIME	MIN. ORD.	A	C
280005604		TAB INDEX RING BINDER #'S 11-20					
0001546	1	SE	IL IN MI OH WI				
11 X 8-1/2IN White. NOW AVAILABLE THROUGH TOUCH-TONE ORDER ENTRY.							

TACK MAP

260415963		TACK MAP 1/8IN HEAD BLUE J-04					
N		PK	1	1	1		
100 per box. NOW AVAILABLE THROUGH TOUCH-TONE ORDER ENTRY.							
260416169		TACK MAP 1/8IN HEAD GREEN J-06					
N		PK	1	1	1		
100 per box.							
260415864		TACK MAP 1/8IN HEAD RED J-02					
N		PK	1	1	1		
100 per box. NOW AVAILABLE THROUGH TOUCH-TONE ORDER ENTRY.							

TACK THUMB

260420724		TACK THUMB					
N		PK	1	1	1		
Package of 100.							
402830525		TACK THUMB 1/2IN					
N		EA	10	2	10		
280009085		TACK THUMB 3/8IN HEAD					
0001422	1	PK	IL IN MI OH WI				
Package of 100. NOW AVAILABLE THROUGH TOUCH-TONE ORDER ENTRY.							

PRODUCT IDENTIFIER		DESCRIPTION				
ITEM NUMBER	ORD. MULT.	SELL UNIT	STD. PKG. STOCK AVAILABILITY / PA	LEAD TIME	MIN. ORD.	A C
300015526	N	EA	10	2	10	
TACK THUMB 5/8IN BOXES						
300015518	N	EA	10	2	10	
TACK THUMB 9/16IN BOXES						
455005611	N	EA	10	2	10	
TACK THUMB MODERN 3						
400469177	N	EA	1	2	1	
TACK THUMB NOEST 2 Box of 100.						

TAG

401346432	4256842	1000	EA	1T 2 13/16IN X 1 3/8IN		
Plain manilla tag with fiber eyelet and a string.						
401346499	5657361	1	EA	TAG 33 MR	IL IN MI OH WI	33
401346416	2131607	1000	EA	TAG CLOTH PLAIN 10Z STRUNG	IL IN MI OH WI	33
401670674	5657429	100	EA	TAG LINEN WHITE 2IN X 1IN	IL IN MI OH WI	33 33
For use in Central Offices.						
401346465	5657346	1000	EA	TAG MANILA 11PT 3 3/4IN X 1 7/8IN	IL IN MI OH WI	33
125 weight paper, blank, regular patch hole, 12in loop string.						
401295878	5657387	1	EA	TAG MARKING 40B	IL IN MI OH WI	33 33
260439435	N	EA	100	TAG PICS DEFECTIVE MATERIAL		4 5000

TAPE

260446836	N			TAPE BINDING FOR XEROX 5090 8R 2928		
Black, 1 reel per carton.						
260355169	0001948	1	RO	TAPE BOX SEAL 2in X 60YD CLEAR	IL IN MI OH WI	
NOW AVAILABLE THROUGH TOUCH-TONE ORDER ENTRY.						
260416268	N	RO	1	TAPE BOX SEALING 2IN X 60YD J-38		1 1
Clear. NOW AVAILABLE THROUGH TOUCH-TONE ORDER ENTRY.						

PRODUCT IDENTIFIER		DESCRIPTION				
ITEM NUMBER	ORD. MULT.	SELL UNIT	STD. PKG. STOCK AVAILABILITY / PA	LEAD TIME	MIN. ORD.	A C
260368634	N	EA	1	2	1	
TAPE CASSETTE BROTHER TC-40 Red, blue & gold on white.						
260416367	N	RO	1	1	1	
TAPE CELLOPHANE 1/2 X 2592IN C-88 3 inch core. NOW AVAILABLE THROUGH TOUCH-TONE ORDER ENTRY.						
900246869	1228304	1	FO	TAPE CELLOPHANE 1/2IN X 1296IN	IL IN MI OH WI	33 33 33 33 33
280054347	N	EA	1	TAPE COVER-UP 148 BLUE		2 1
280054271	N	EA	1	TAPE COVER-UP 238C		2 1
997600077	1270561	1	RO	TAPE DRAFTING 1IN X 60YD ROLL	IL IN MI OH WI	33 33 33 33 33
260416979	N	RO	1	TAPE FILAMENT 1/2IN 60YD ROLL J-87		1 1
NOW AVAILABLE THROUGH TOUCH-TONE ORDER ENTRY.						
401008222	1100560	1	CS	TAPE KRAFT GUMMED 3IN X 600FT AGP-B	IL IN MI OH WI	33 33 33 33 33
Heavy kraft paper gummed on one side with a water solvent gum. Used for sealing packages, boxes, etc.						
300027414	8403584	1	RO	TAPE MENDING 1/2IN	IL IN MI OH WI	33 33
401008271	N	RO	1	TAPE MENDING 810 3/4IN X 1296IN		2 1
900567314	8370361	1	RO	TAPE PAPER YELLOW 724 3IN X 60YD	IL IN MI OH WI	33 33
For use by supply forces to tranship material.						
260413745	N	BX	72	TAPE SPLICE IBM 3800 267C		2 1
72 rolls per carton. Wisconsin.						

TAPE CORRECTION

280004862	0001326	1	RO	TAPE CORRECTION 1/3 X 600IN		
NOW AVAILABLE THROUGH TOUCH-TONE ORDER ENTRY.						
260416466	N	RO	1	TAPE CORRECTION 1/6 X 600IN C-84		1 1
Single line, CR-16. NOW AVAILABLE THROUGH TOUCH-TONE ORDER ENTRY.						

DISTRIBUTION SERVICES
 NETWORK SERVICES
 TOOLS
 BUILDING JANITORIAL
 AUTOMOTIVE
 FORMS/OFFICE SUPPLIES
 GENERAL
 DATA VOICE

TAPE CORRECTION

DISTRIBUTION SERVICES

PRODUCT IDENTIFIER		DESCRIPTION						
ITEM NUMBER	ORD. MULT.	SELL UNIT	STD. PKG. STOCK AVAILABILITY / PA	LEAD TIME	MIN. ORD.	A	C	

280004854 TAPE CORRECTION 1/6IN X 600IN
 0001325 1 RO IL IN MI OH WI
 NOW AVAILABLE THROUGH TOUCH-TONE ORDER ENTRY.

NETWORK SERVICES

260416565 TAPE CORRECTION 2/6 X 600IN C-85
 N RO 1 1 1
 Double line, CR-26. NOW AVAILABLE THROUGH TOUCH-TONE ORDER ENTRY.

260416664 TAPE CORRECTION 5/6 X 600IN C-86
 N RO 1 1 1
 Five line, CR-56. NOW AVAILABLE THROUGH TOUCH TONE ORDER ENTRY.

TOOLS

001123199 TAPE CORRECTION ADHESIVE 1/6IN WIDE
 N CT 1 2 1

BUILDING JANITORIAL

260355557 TAPE CORRECTION POST-IT 1/3IN
 0001953 1 EA IL IN MI OH WI
 1/3IN X 700IN. NOW AVAILABLE THROUGH TOUCH-TONE ORDER ENTRY.

260355318 TAPE CORRECTION POST-IT 1IN
 0001958 1 EA IL IN MI OH WI
 1IN X 700IN. NOW AVAILABLE THROUGH TOUCH TONE ORDER ENTRY.

AUTOMOTIVE

001123231 TAPE CORRECTION REFILL ONLY
 N EA 1 1

TAPE DISPENSER
 SEE DISPENSER TAPE.

TAPE DYMO
 GLOSSY FINISH

FORMS/OFFICE SUPPLIES

400373593 TAPE DYMO 1/2 X 144IN BLACK
 1102525 1 RO
 Box of 10.

260416763 TAPE DYMO 1/2 X 144IN BLACK C-90
 N RO 1 1 1
 NOW AVAILABLE THROUGH TOUCH-TONE ORDER ENTRY.

260416862 TAPE DYMO 1/2 X 144IN BLUE C-91
 N RO 1 1 1
 NOW AVAILABLE THROUGH TOUCH-TONE ORDER ENTRY.

260416961 TAPE DYMO 1/2 X 144IN BROWN C-92
 N RO 1 1 1

260414073 TAPE DYMO 1/2 X 144IN CLEAR C-93
 N RO 1 1 1

260414172 TAPE DYMO 1/2 X 144IN GOLD C-94
 N RO 1 1 1

GENERAL

DATA VOICE

PRODUCT IDENTIFIER		DESCRIPTION						
ITEM NUMBER	ORD. MULT.	SELL UNIT	STD. PKG. STOCK AVAILABILITY / PA	LEAD TIME	MIN. ORD.	A	C	

260414271 TAPE DYMO 1/2 X 144IN GRAY C-95
 N RO 1 1 1

400373569 TAPE DYMO 1/2 X 144IN GREEN
 2392720 1 RO IL IN MI OH WI
 33 33 33
 Box of 10.

260414370 TAPE DYMO 1/2 X 144IN GREEN C-96
 N RO 1 1 1

260414479 TAPE DYMO 1/2 X 144IN ORANGE C-97
 N RO 1 1 1

260414578 TAPE DYMO 1/2 X 144IN RED C-98
 N RO 1 1 1
 NOW AVAILABLE THROUGH TOUCH-TONE ORDER ENTRY.

260414776 TAPE DYMO 1/2 X 144IN WOODGRAIN D-01
 N RO 1 1 1

260414677 TAPE DYMO 1/2 X 144IN YELLOW C-99
 N RO 1 1 1

260416276 TAPE DYMO 1/4 X 144IN BLACK D-16
 N RO 1 1 1
 NOW AVAILABLE THROUGH TOUCH TONE ORDER ENTRY.

260416375 TAPE DYMO 1/4 X 144IN BLUE D-17
 N RO 1 1 1
 NOW AVAILABLE THROUGH TOUCH-TONE ORDER ENTRY.

260416474 TAPE DYMO 1/4 X 144IN BROWN D-18
 N RO 1 1 1

260416573 TAPE DYMO 1/4 X 144IN CLEAR D-19
 N RO 1 1 1

260415971 TAPE DYMO 1/4 X 144IN GOLD D-13
 N RO 1 1 1

260416672 TAPE DYMO 1/4 X 144IN GRAY D-20
 N RO 1 1 1

260416078 TAPE DYMO 1/4 X 144IN GREEN D-14
 N RO 1 1 1

260416870 TAPE DYMO 1/4 X 144IN ORANGE D-23
 N RO 1 1 1

260416177 TAPE DYMO 1/4 X 144IN RED D-15
 N RO 1 1 1
 NOW AVAILABLE THROUGH TOUCH-TONE ORDER ENTRY.

260416771 TAPE DYMO 1/4 X 144IN WOODGRAIN D-21
 N RO 1 1 1

260414875 TAPE DYMO 3/8 X 144IN BLACK D-02
 N RO 1 1 1
 NOW AVAILABLE THROUGH TOUCH TONE ORDER ENTRY.

PRODUCT IDENTIFIER		DESCRIPTION				
ITEM NUMBER	ORD. MULT.	SELL UNIT	STD. PKG. STOCK AVAILABILITY / PA	LEAD TIME	MIN. ORD.	A C
260414974		TAPE DYMO 3/8 X 144IN BLUE	D-03			
N		RO 1	1	1	1	
NOW AVAILABLE THROUGH TOUCH TONE ORDER ENTRY.						
260415070		TAPE DYMO 3/8 X 144IN BROWN	D-04			
N		RO 1	1	1	1	
260415179		TAPE DYMO 3/8 X 144IN CLEAR	D-05			
N		RO 1	1	1	1	
260415278		TAPE DYMO 3/8 X 144IN GOLD	D-06			
N		RO 1	1	1	1	
260415377		TAPE DYMO 3/8 X 144IN GRAY	D-07			
N		RO 1	1	1	1	
260415476		TAPE DYMO 3/8 X 144IN GREEN	D-08			
N		RO 1	1	1	1	
260415575		TAPE DYMO 3/8 X 144IN ORANGE	D-09			
N		RO 1	1	1	1	
260415674		TAPE DYMO 3/8 X 144IN RED	D-10			
N		RO 1	1	1	1	
NOW AVAILABLE THROUGH TOUCH-TONE ORDER ENTRY.						
260415773		TAPE DYMO 3/8 X 144IN WOODGRAIN	D-11			
N		RO 1	1	1	1	
260415872		TAPE DYMO 3/8 X 144IN YELLOW	D-12			
N		RO 1	1	1	1	

TAPE EMBOSSED

260355250		TAPE EMBOSSED 1/2 X 144IN BLACK				
0001955	1	RO				
NOW AVAILABLE THROUGH TOUCH TONE ORDER ENTRY.						
260355201		TAPE EMBOSSED 1/2 X 144IN BLUE				
0001949	1	RO	IL IN MI OH WI			
NOW AVAILABLE THROUGH TOUCH TONE ORDER ENTRY.						
260355458		TAPE EMBOSSED 1/2 X 144IN RED				
0001952	1	RO	IL IN MI OH WI			
NOW AVAILABLE THROUGH TOUCH TONE ORDER ENTRY.						
260355219		TAPE EMBOSSED 1/2 X 144IN YELLOW				
0001954	1	RO	IL IN MI OH WI			
NOW AVAILABLE THROUGH TOUCH TONE ORDER ENTRY.						
260355466		TAPE EMBOSSED 3/8 X 144IN BLACK				
0001963	1	RO	IL IN MI OH WI			
NOW AVAILABLE THROUGH TOUCH TONE ORDER ENTRY.						

PRODUCT IDENTIFIER		DESCRIPTION				
ITEM NUMBER	ORD. MULT.	SELL UNIT	STD. PKG. STOCK AVAILABILITY / PA	LEAD TIME	MIN. ORD.	A C
260355474		TAPE EMBOSSED 3/8 X 144IN BLUE				
0001961	1	RO	IL IN MI OH WI			
NOW AVAILABLE THROUGH TOUCH TONE ORDER ENTRY.						
260355235		TAPE EMBOSSED 3/8 X 144IN GREEN				
0001960	1	RO	IL IN MI OH WI			
NOW AVAILABLE THROUGH TOUCH TONE ORDER ENTRY.						
260355482		TAPE EMBOSSED 3/8 X 144IN ORANGE				
0001959	1	RO	IL IN MI OH WI			
NOW AVAILABLE THROUGH TOUCH TONE ORDER ENTRY.						
260355243		TAPE EMBOSSED 3/8 X 144IN RED				
0001957	1	RO	IL IN MI OH WI			
NOW AVAILABLE THROUGH TOUCH TONE ORDER ENTRY.						
260355227		TAPE EMBOSSED 3/8 X 144IN YELLOW				
0001962	1	RO	IL IN MI OH WI			
NOW AVAILABLE THROUGH TOUCH TONE ORDER ENTRY.						

TAPERASER

SEE FLUID CORRECTION.

TAPE FILAMENT

400467221		TAPE FILAMENT 193 3/4IN X 60YD				
2774521	64	RO				
A filament tape roll used to seal boxes and cartons.						
001123249		TAPE FILAMENT SCOTCH 3/4IN WIDE				
5671982	1	EA	IL IN MI OH WI			
DISCONTINUE, REPLACED BY TAPE FILAMENT 193 3/4IN X 60YD ROLL.						

TAPE KO-REC-TYPE

260408786		TAPE KO-REC TYPE EXECUTIVE GREEN	E-55			
N		PK 1	1	1	1	
260408885		TAPE KO-REC TYPE EXECUTIVE PINK	E-57			
N		PK 1	1	1	1	
260408687		TAPE KO-REC TYPE EXECUTIVE WHITE	J-39			
N		PK 1	1	1	1	
NOW AVAILABLE THROUGH TOUCH-TONE ORDER ENTRY.						

TAPE LIFT OFF

280035916		TAPE LIFT-OFF	118			
N		EA 1	2	1	1	

DISTRIBUTION SERVICES

NETWORK SERVICES

TOOLS

BUILDING JANITORIAL

AUTOMOTIVE

FORMS/OFFICE SUPPLIES

GENERAL

DATA VOICE

TAPE LIFT OFF

DISTRIBUTION SERVICES

PRODUCT IDENTIFIER		DESCRIPTION				
ITEM NUMBER	ORD. MULT.	SELL UNIT	STD. PKG. STOCK AVAILABILITY / PA	LEAD TIME	MIN. ORD.	A C
280054321		EA	145	1	2	1
N						
280054289		EA	228	1	2	1
N						
280035866		EA	4201	1	2	1
N						
280035874		EA	H118	1	2	1
N						
280035882		EA	H118F	1	2	1
N						
280035890		EA	N118	1	2	1
N						
280035908		EA	N118F	1	2	1
N						

NETWORK SERVICES

TOOLS

BUILDING JANITORIAL

AUTOMOTIVE

FORMS/OFFICE SUPPLIES

GENERAL

DATA VOICE

TAPE MASKING

401349618		RO	1 IN X 60YD	1		
1270728	1					
300027406		RO	2IN X 60YD	24	3	48
N			Permaceel P786.			

280004193 TAPE MASKING 3M 2IN X 60YD
 0001003 1 RO IL IN MI OH WI
 NOW AVAILABLE THROUGH TOUCH-TONE ORDER ENTRY.

280004201 TAPE MASKING 3M 3/4IN X 60YD
 0001004 1 RO IL IN MI OH WI
 NOW AVAILABLE THROUGH TOUCH-TONE ORDER ENTRY.

260414784 TAPE MASKING 60 YARD ROLL J-93
 N EA 1 1 1
 1 inch core. NOW AVAILABLE THROUGH TOUCH-TONE ORDER ENTRY.

260414883 TAPE MASKING 60 YARD ROLL J-94
 N EA 1 1 1
 2 inch core. NOW AVAILABLE THROUGH TOUCH-TONE ORDER ENTRY.

TAPE TRANSPARENT

260417787 TAPE TRANSPARENT 1 X 2592IN J-39
 N RO 1 1 1
 3 inch core. NOW AVAILABLE THROUGH TOUCH-TONE ORDER ENTRY.

260414982 TAPE TRANSPARENT 1/2 X 250IN
 N EA 1 1 1
 Double-sided, with dispenser. NOW AVAILABLE THROUGH TOUCH-TONE ORDER ENTRY.

PRODUCT IDENTIFIER		DESCRIPTION				
ITEM NUMBER	ORD. MULT.	SELL UNIT	STD. PKG. STOCK AVAILABILITY / PA	LEAD TIME	MIN. ORD.	A C

280004268 TAPE TRANSPARENT 3M 1/2IN RED BOX
 0001011 1 RO IL IN MI OH WI
 1/2IN X 1296IN, 1IN CORE. NOW AVAILABLE THROUGH TOUCH-TONE ORDER ENTRY.

280004276 TAPE TRANSPARENT 3M 3/4IN GREEN BOX
 0001012 1 RO IL IN MI OH WI
 NOW AVAILABLE THROUGH TOUCH-TONE ORDER ENTRY.

280004284 TAPE TRANSPARENT 3M 3/4IN RED BOX
 0001013 1 RO IL IN MI OH WI
 3/4IN X 1296IN, 1IN CORE. NOW AVAILABLE THROUGH TOUCH-TONE ORDER ENTRY.

260415088 TAPE TRANSPARENT 3/4 x 1296IN J-15
 N RO 1 1 1
 1 inch core. NOW AVAILABLE THROUGH TOUCH-TONE ORDER ENTRY.

260415187 TAPE TRANSPARENT 3/4 x 2592IN J-16
 N RO 1 1 1
 3 inch core. NOW AVAILABLE THROUGH TOUCH-TONE ORDER ENTRY.

400551065 TAPE TRANSPARENT CLEAR 1/2 X 1296IN
 1271064 1 RO IL IN MI OH WI
 33 33

260414081 TAPE TRANSPARENT MAGIC 1/2 X 450IN C-89
 N RO 1 1 1
 Self-dispenser. NOW AVAILABLE THROUGH TOUCH-TONE ORDER ENTRY.

260414180 TAPE TRANSPARENT MAGIC 1/2 X 800IN K-26
 N RO 1 1 1
 Self-dispenser. NOW AVAILABLE THROUGH TOUCH-TONE ORDER ENTRY.

TAPEWRITER DYMO

260415385 TAPEWRITER DYMO K-25
 N EA 1 1 1
 NOW AVAILABLE THROUGH TOUCH-TONE ORDER ENTRY.

260415484 TAPEWRITER DYMO EXTRA WHEEL K-35
 N EA 1 1 1
 Horizontal 180IN high. NOW AVAILABLE THROUGH TOUCH-TONE ORDER ENTRY.

260415583 TAPEWRITER DYMO EXTRA WHEEL K-36
 N EA 1 1 1
 Vertical 160IN high. NOW AVAILABLE THROUGH TOUCH-TONE ORDER ENTRY.

PRODUCT IDENTIFIER							DESCRIPTION						
ITEM NUMBER	ORD. MULT.	SELL UNIT	STD. PKG. STOCK AVAILABILITY / PA	LEAD TIME	MIN. ORD.	A C							
TELETYPE PAPER													
SEE PAPER TELETYPE.													
TEMPLATE													
260420708			TEMPLATE ADPS FLOW CHART	J-20									
N		EA	1	1	1								
260420690			TEMPLATE COMPUTER DIAGRAM	J-19									
N		EA	1	1	1								
260420716			TEMPLATE STANDARD LOGIC	J-21									
N		EA	1	1	1								
400415345			TEMPLATE SYMBOL	38Y3890									
N		EA	1	2	1								
280052366			TEMPLATE TRIANGLE	JMOS									
N		EA	1	2	1								
TENTCARD TRAINING													
300097185			TENTCARD TRAINING	9 1/2IN									
N		EA	100	2	100								
THUMB TACK													
SEE TACK THUMB.													
TISSUE													
001112051			TISSUE CLEANER LENS	851T									
5250647	1	PK	Case of 18.										
401607908			TISSUE CLEANER LENS DISPENSE PACK										
1150649	1	CS	IL	IN	MI	OH	WI						
			33	33	33	33	33						
For all eyeglasses and precision optics, 74 tissues per pack, 12 packs per carton, 12 cartons per case.													
TONER													
300026846			TONER	995 COPIER									
N		CT	1		6		Carton of 6.						
260417738			TONER	032K									
N		EA	1	2	1								
300041845			TONER	13382000 DRY									
N		CT	2	1	1		2 bottles per carton.						
260382759			TONER	BLACK 3022E									
N		CT	1	1	1								

PRODUCT IDENTIFIER							DESCRIPTION						
ITEM NUMBER	ORD. MULT.	SELL UNIT	STD. PKG. STOCK AVAILABILITY / PA	LEAD TIME	MIN. ORD.	A C							
260330709			TONER	BLACK 6020									
N		CT	1	2	1								
260324512			TONER	BLACK 6060/6130									
N		CT	1	2	1								
260382718			TONER	BLACK 6110									
N		CT	1	1	1								
260382734			TONER	BLACK 6113/6213									
N		CT	1	1	1								
260324553			TONER	BLACK 6215									
N		CT	1	2	1								
260355631			TONER	BLACK 6242									
N		CT	1	1	1								
260382817			TONER	BLACK 6260									
N		CT	1	1	1								
260382833			TONER	BLACK 6272									
N		CT	1	1	1								
260430806			TONER	BLACK 6517									
N		CT	1	1	1								
260430814			TONER	BLACK 6525/6540									
N		CT	1	1	1								
260430830			TONER	BLACK 6550									
N		CT	1	1	1								
260392170			TONER	BLACK 6R234									
N		CT	1	2	1		Xerox 2510.						
260384516			TONER	BLACK 6R245									
N		CT	1	2	1		Xerox 2520.						
260380332			TONER	CARTRIDGE	19544014								
N		EA	1	2	1		MC1000/Starmate reader/printer.						
260338124			TONER	CARTRIDGE	DIGITAL LN03X								
N		EA	1	2	1		AC/LX for LN03 printer.						
260358619			TONER	CARTRIDGE	HP92285A								
N		EA	1	2	1		For Hewlett-Packard DeskJet Series I, Plus & 500 Plus.						
260354360			TONER	CARTRIDGE	HP92295A								
1970483	1	EA	IL	IN	MI	OH	WI						
			31	31	31	31	31						
For Laserjet II, IID, III, & IIID.													
260429543			TONER	CARTRIDGE	IBM 4019, 1380200, 392C								
N		EA	1	2	1								

DISTRIBUTION SERVICES

NETWORK SERVICES

TOOLS

BUILDING JANITORIAL

AUTOMOTIVE

FORMS/OFFICE SUPPLIES

GENERAL

DATA VOICE

TONER

DISTRIBUTION SERVICES

PRODUCT IDENTIFIER		DESCRIPTION					MIN.	A
ITEM	ORD.	SELL	STD. PKG.	LEAD TIME				
NUMBER	MULT.	UNIT	STOCK AVAILABILITY / PA			ORD.	C	
260344312 TONER CARTRIDGE IBM 4216 BLACK								
N		EA	1	1		1		
Pagemaker.								

NETWORK SERVICES

260344387 TONER CARTRIDGE LASERWRITER							
1970301		EA	IL	IN	MI	OH	WI
			04			04	
Black, M0180.							
260384284 TONER CARTRIDGE LN03 SUP-RK-TN							
1965251	1	PK	IL	IN	MI	OH	WI
			33			33	33
Package of 12.							

TOOLS

260367834 TONER CARTRIDGE NEC 20-010							
N		EA	1	2		1	
260412325 TONER CARTRIDGE TEKTRONIX 016-0974-00							
N		PK	1	1		1	
Quick Jet, black.							

BUILDING JANITORIAL

260412333 TONER CARTRIDGE TEKTRONIX 016-0975-00							
N		PK	1	1		1	
Quick Jet, cyan.							
260412317 TONER CARTRIDGE TEKTRONIX 016-0976-00							
N		PK	1	1		1	
Quick Jet, magenta.							
260412309 TONER CARTRIDGE TEKTRONIX 016-0977-00							
N		PK	1	1		1	
Quick Jet, yellow.							

AUTOMOTIVE

260422977 TONER CYAN 1318062							
N		CT	2	2		1	
For Kodak Coloredge Copier.							
260345624 TONER DATAPRODUCTS LAZER 1230							
N		CT	1	2		1	

FORMS/OFFICE SUPPLIES

260446497 TONER FOR KODAK 95 MONOCOMPONENT 1386713							
N		EA	1	2		1	
For Kodak 95 copier.							
260446497 TONER FOR KODAK 95 MONOCOMPONENT 1386713							
N							
For Kodak 95 copier.							

GENERAL

260344130 TONER IBM 3800 PRINTER W/5BAGS							
N		CT	1	1		30	
260436795 TONER IBM 3835 6190649							
N		BX	6	2		1	
260446471 TONER KODAK 90 MONOCOMPONENT 8401408							
N							
For Kodak 90 copier.							

DATA VOICE

260360284 TONER KODAK K COPIER 810-9043							
N		CT	1	2		1	
260360318 TONER KODAK L 808-6597							
N		CT	1	2		1	

PRODUCT IDENTIFIER		DESCRIPTION					MIN.	A
ITEM	ORD.	SELL	STD. PKG.	LEAD TIME				
NUMBER	MULT.	UNIT	STOCK AVAILABILITY / PA			ORD.	C	
260422985 TONER MAGENTA 1660844								
N		CT	2	2		1		
For Kodak Coloredge Copier.								
260337860 TONER MANNESMAN TALLY LP403065								
N		CT	1	2		1		
PN/065K.								
260449038 TONER MINOLTA RP600Z 8910-404 3/BOX								
N								
For microfiche reader/printer.								
260354527 TONER PAGEPRINTER 3812/1348349								
N		CT	1	3		1		
260445135 TONER PITNEY BOWES 9100 802-2 6/CTN								
N		EA	1	2		1		
260445143 TONER PITNEY BOWES 9200/9250 801-9								
N		EA	1	2		1		
260445150 TONER PITNEY BOWES 9300 804-2								
N		EA	1	2		1		
260445168 TONER PITNEY BOWES 9500/9550 804-6								
N		EA	1	2		1		
260344155 TONER PRINTER 7530AJ-409								
N		CT	1	1		1		
3M, MD1.								
280036088 TONER READER/PRINTER 21-1883								
N		CS	1	2		1		
2 bottles per case.								
300027372 TONER READER/PRINTER TYPE								
N		EA	1	1		1		
12 quart bottles per case.								
260423918 TONER RICOH 5397-26 FOR DEC LN03								
N		EA	1	1		1		
260369392 TONER SIEMENS 2300 PRINTER								
N		CT	1	2		1		
260413208 TONER VERSATEC CLEAR DISPERSANT 632								
N		CT	1	2		1		
6 bottles per carton.								
260413190 TONER VERSATEC INTENSIFIER 6041								
N		CT	1	2		1		
48 bottles per carton.								
260413182 TONER VERSATEC PREMIX 6040								
N		CT	1	2		1		
6 bottles per carton.								
260413141 TONER VERSATEC PREMIX TYPE H 4407-3								
N		CT	1	2		1		
2 bottles per carton.								
260436845 TONER WASTE BOTTLE 3M PRINTER 7530J								
N		CT	1	2		1		
7880616031-9.								

PRODUCT IDENTIFIER		DESCRIPTION				
ITEM NUMBER	ORD. MULT.	SELL UNIT	STD. PKG. STOCK AVAILABILITY / PA	LEAD TIME	MIN. ORD.	A C

260422993 TONER YELLOW 1115492
 N CT 2 2 1
 For Kodak Coloredge Copier.

TOOL TAPE EMBOSSING

400374351 TOOL TAPE EMBOSSING 1570-01 W/CASE
 N EA 1 2 1
 Uses 3/8IN and 1/2IN tape.

TRANSPARENCY

260367818 TRANSPARENCY COPIER XF10 W/O STRIP
 N BX 1 2 1

260367826 TRANSPARENCY COPIER XF20 WITH STRIP
 N BX 1 2 1

280005778 TRANSPARENCY FILM 522 CLEAR
 0001801 1 BX IL IN MI OH WI
 Box of 100. NOW AVAILABLE THROUGH TOUCH-TONE ORDER ENTRY.

260358486 TRANSPARENCY FILM HP51630Q
 N CT 1 1 1

280005786 TRANSPARENCY MOUNTING FRAME
 0001802 1 BX IL IN MI OH WI
 Box of 50. NOW AVAILABLE THROUGH TOUCH-TONE ORDER ENTRY.

260358346 TRANSPARENCY PLOTTER HP17702T
 N CT 1 2 1

260429550 TRANSPARENCY PLOTTER HP-17700T
 N EA 1 2 1

300025053 TRANSPARENCY TYPE 3R235
 N BX 1 2 1

TRAY DESK

280005018 TRAY DESK LETTER SMOKE
 0001280 1 EA
 NOW AVAILABLE THROUGH TOUCH TONE ORDER ENTRY.

001029503 TRAY DESK MAHOGANY
 N EA 1 2 1

260420591 TRAY DESK STACKABLE DATA BEIGE E-74
 N EA 1 1 1

260420609 TRAY DESK STACKABLE DATA BLACK E-75
 N EA 1 1 1
 NOW AVAILABLE THROUGH TOUCH-TONE ORDER ENTRY.

PRODUCT IDENTIFIER		DESCRIPTION				
ITEM NUMBER	ORD. MULT.	SELL UNIT	STD. PKG. STOCK AVAILABILITY / PA	LEAD TIME	MIN. ORD.	A C

260420625 TRAY DESK STACKABLE DATA BLUE E-79
 N EA 1 1 1
 NOW AVAILABLE THROUGH TOUCH-TONE ORDER ENTRY.

260420617 TRAY DESK STACKABLE DATA SMOKE E-77
 N EA 1 1 1
 NOW AVAILABLE THROUGH TOUCH-TONE ORDER ENTRY.

260420633 TRAY DESK STACKABLE LETTER BLACK D-25
 N EA 1 1 1
 NOW AVAILABLE THROUGH TOUCH-TONE ORDER ENTRY.

260420674 TRAY DESK STACKABLE LETTER BLUE D-29
 N EA 1 1 1

260420682 TRAY DESK STACKABLE LETTER CRYSTAL D-30
 N EA 1 1 1

260420641 TRAY DESK STACKABLE LETTER GRAY D-26
 N EA 1 1 1
 NOW AVAILABLE THROUGH TOUCH-TONE ORDER ENTRY.

260420666 TRAY DESK STACKABLE LETTER RED D-28
 N EA 1 1 1

260420658 TRAY DESK STACKABLE LETTER SMOKE D-27
 N EA 1 1 1
 NOW AVAILABLE THROUGH TOUCH-TONE ORDER ENTRY.

TRAY POST-IT NOTES

260414040 TRAY 3IN X 5IN BLACK I-34
 N EA 1 1 1
 For Post-it Notes.

260414149 TRAY 3IN X 5IN PUTTY I-39
 N EA 1 1 1
 For Post-it Notes.

TYPEWRITER BRUSH

SEE BRUSH TYPEWRITER.

VIEWER

280042870 VIEWER HAND HELD 8X #208-ACV
 N EA 1 1 1
 Views entire microfiche frame in viewer lens. Primarily used for scanning. Comes with carrying case.

280042888 VIEWER HAND HELD-15X #456-113R
 N EA 1 1 1
 Offers a higher magnification for more detail and clarity. Does not show entire microfiche frame in viewer. Comes with carrying case.

DISTRIBUTION SERVICES

NETWORK SERVICES

TOOLS

BUILDING JANITORIAL

AUTOMOTIVE

FORMS/OFFICE SUPPLIES

GENERAL

DATA VOICE

DISTRIBUTION SERVICES
 NETWORK SERVICES
 TOOLS
 BUILDING JANITORIAL
 AUTOMOTIVE
 FORMS/OFFICE SUPPLIES
 GENERAL
 DATA VOICE

VIEWER

PRODUCT IDENTIFIER		DESCRIPTION				
ITEM NUMBER	ORD. MULT.	SELL UNIT	STD. PKG. STOCK AVAILABILITY / PA	LEAD TIME	MIN. ORD.	A C
280042862 VIEWER PORTABLE MICRO DESIGN						
N		EA	1	1	1	
Portable II with hood extension & high magnification lens.						
280042854 VIEWER PORTABLE MICRO DESIGN						
N		EA	1	1	1	
Portable II with high magnification lens.						
280042839 VIEWER PORTABLE MICRO DESIGN						
N		EA	1	1	1	
Portable II.						
280042847 VIEWER PORTABLE MICRO DESIGN						
N		EA	1	1	1	
Portable II with hood extension.						
WALLET						
300025418 WALLET CUSTOM POCKET 49554						
N		EA	1	2	1	
WASHER FASTENER						
260416086 WASHER FASTENER BRASS #1 D-37						
N		BX	1	1	1	
For hole-punched paper, 100 per box. NOW AVAILABLE THROUGH TOUCH-TONE ORDER ENTRY.						
260416185 WASHER FASTENER BRASS #2 D-38						
N		BX	1	1	1	
For hole-punched paper, 100 per box. NOW AVAILABLE THROUGH TOUCH-TONE ORDER ENTRY.						
WASTE SUMPS						
260337977 WASTE SUMPS 1025/1038 8R3605						
N		CT	1	2	1	
Excess toner collection bottle.						
WASTEBASKET						
260416284 WASTEBASKET BEIGE K-33						
N		EA	1	1	1	
NOW AVAILABLE THROUGH TOUCH TONE ORDER ENTRY.						
280005067 WASTEBASKET GREY MEDIUM ROUND						
0001286	1	EA	IL IN MI OH WI			
NOW AVAILABLE THROUGH TOUCH-TONE ORDER ENTRY.						
WIPER						
400536330 WIPER 297-11 MICRO SHUR						
8126540	1	CS				
Used in cleaning contacts, 4 7/8in x 8 1/4in, 300 per dispenser box, 54 boxes per case.						

PRODUCT IDENTIFIER		DESCRIPTION				
ITEM NUMBER	ORD. MULT.	SELL UNIT	STD. PKG. STOCK AVAILABILITY / PA	LEAD TIME	MIN. ORD.	A C
000246694 WIPER 805-39 SOFT-N-FRESH						
5286443	1	CS	IL IN MI OH WI			
33 33 33 33 33						
White, 14in x 21 1/2in, 40 per dispenser box, 12 boxes per case.						
WRISTREST						
260412655 WRISTREST RIGHT ANGLE 318 STANDARD						
N		EA	1	2	1	
260412663 WRISTREST RIGHT ANGLE 318CD CONDUCTIVE						
N		EA	1	2	1	
260412671 WRISTREST RIGHT ANGLE 322 STANDARD						
N		EA	1	2	1	
260412689 WRISTREST RIGHT ANGLE 322CD CONDUCTIVE						
N		EA	1	2	1	

NOTES

NOTES

SECTION 7 - GENERAL MATERIAL INCLUDED

- FIRST AID AND MEDICAL SUPPLIES
- CUSTOMER PREMISE EQUIPMENT
- PACKING MATERIAL

We are concerned and value your ideas. Please contact the Ameritech Bell Group Catalog Department direct on (708) 248-8313 with questions, corrections and ideas.

Catalog Format

PRODUCT IDENTIFIER		DESCRIPTION				
ITEM NUMBER	ORD. MULT.	SELL UNIT	STD. PKG. STOCK AVAILABILITY / PA	LEAD TIME	MIN. ORD.	A C

Stock Material

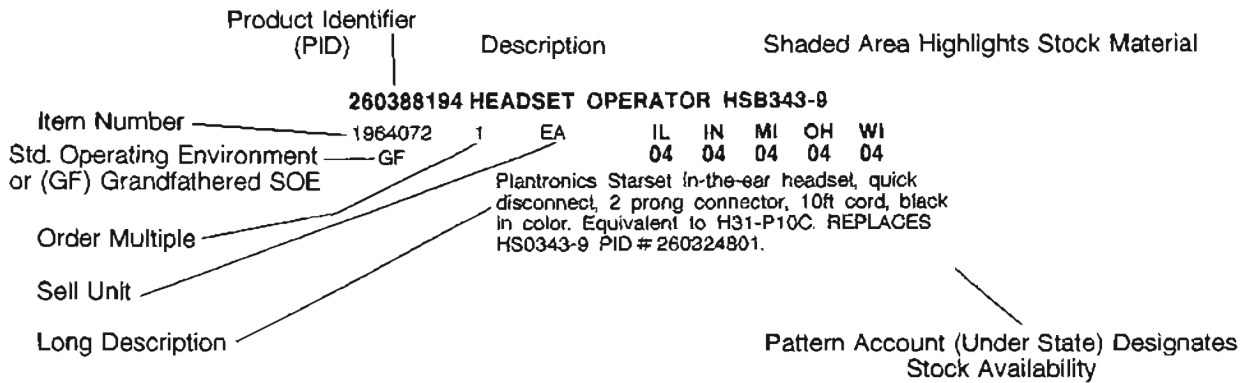

Non-Stock Material

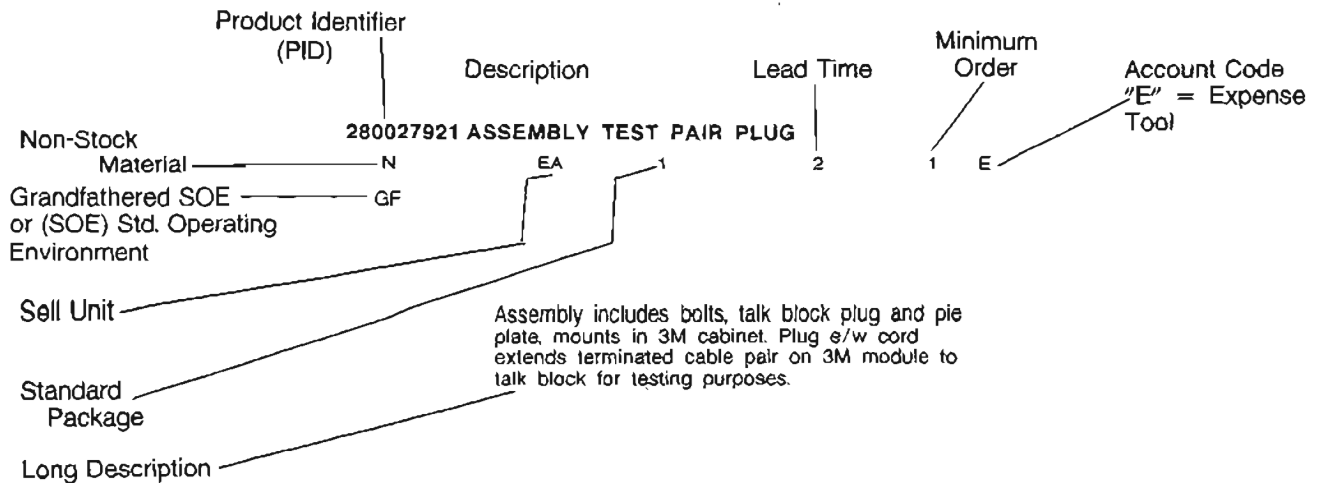

PRODUCT IDENTIFIER		DESCRIPTION					
ITEM NUMBER	ORD. MULT.	SELL UNIT	STD. PKG. STOCK AVAILABILITY / PA	LEAD TIME	MIN. ORD.	A	C
ADAPTER							
101220069 ADAPTER 149B							
1100388	1	EA					
Adapter consists of a small terminal block assembly equipped with one CK16671 L1 and one CK16672 L1 connector. Used with plug ended telephones, BSP 461-200-182.							
102949013 ADAPTER 223D							
1139915	1	EA	IL 04	IN 04	MI 04	OH 04	WI 04
Used to interconnect the 4 A Speakerphone, C680A Transmitter, 108 A Loudspeaker Set and the 851 Power Unit, when an 82 type connecting block cannot be used, BSP 512-700-100.							
103766630 ADAPTER 225A 50							
1227934	1	EA	IL 04	IN 04	MI 04	OH 04	WI 04
Used to adapt D4BU mounting cord to 550 type jacks, BSP 461-630-100.							
103715082 ADAPTER 267A 2							
1301276	1	EA	IL 04	IN 04	MI 04	OH 04	WI 04
Use to connect two 4 conductor modular cords to a modular connecting block, BSP 503-100-100.							
103715652 ADAPTER 267C							
1966895	1	EA	IL 04	IN 04	MI 04	OH 04	WI 04
Splits RJ14C (two line outlet) into two separate lines.							
103786240 ADAPTER 451A							
N		EA	1		2		1
280050782 ADAPTER 9 PIN RECEPTACLE H8575B							
1928499	1	EA	IL 03	IN	MI	OH 03	WI 03
280050790 ADAPTER 25 PIN MALE H8571D							
1928507	1	EA	IL 04	IN	MI	OH	WI 04
260354022 ADAPTER CARD DUAL ASYNC IBM PS/2							
N		EA	1		1		1
IBM PS/2 dual async adapter card.							
260302476 ADAPTER DATA MOUNTING 1830							
1938217	1	EA	IL	IN	MI	OH	WI 59
Used to extend leads.							
280080607 ADAPTER FRAME GB5955LAF							
1936732	1	EA	IL 04	IN 04	MI	OH	WI
DISCONTINUED - ORDER NON STOCK UPON STOCK DEPLETION							
280045162 ADAPTER F/N1890							
N		EA	1		6		1

PRODUCT IDENTIFIER		DESCRIPTION					
ITEM NUMBER	ORD. MULT.	SELL UNIT	STD. PKG. STOCK AVAILABILITY / PA	LEAD TIME	MIN. ORD.	A	C
260404413 ADAPTER IBM PS/2 8514/A							
N		EA	1		1		1
Display adapter, P/N 1887972.							
280080615 ADAPTER MODULAR AA2540A							
N		EA	1		3		1
Adapter used to break 25 pair cable into 12 modularized data paths, both send and receive.							
260427968 ADAPTER PRINTER F/N2101							
N		EA	1				1
Lee Data (Apertus).							
260425277 ADAPTER PRINTER KEYDEX UG-403A							
N		EA	1				1
Keydex Corporation.							
260425285 ADAPTER PRINTER MODEL 6561							
N		EA	1				1
AT&T or Memorex Telex.							
260402748 ADAPTER RS232 F/N5998							
1976852	1	EA	IL	IN	MI	OH 03	WI
For use with F/N5500 or 5510 Remote Communications Module.							
300084944 ADAPTER SUPER MOD TRW SM125							
N		EA	1		2		1
299-24-00-125. A cinch modular adapter which provides access to five lines from one 25 pair connector cable.							
260347828 ADAPTER TERM MUX FN3103							
1951632	1	EA	IL 37	IN	MI	OH	WI
For IBM 3174 Controller.							
260402755 ADAPTER V.35 F/N5999							
1976910	1	EA	IL	IN	MI	OH 03	WI
For 5500 & 5510 Remote Communications Module.							
ADAPTER BRIDGING							
401573837 ADAPTER BRIDGING CK19252 L5							
2648501	1	EA					
Three-way bridging adapter used in connection with wiring plans. For use in multiple installations of data sets, BSP 461-200-182, BSP 590-010-202.							
APPARATUS BLANK							
SEE BLANK APPARATUS.							
APPARATUS MOUNTING							
SEE MOUNTING APPARATUS.							
ASSEMBLY							
260318217 ASSEMBLY BRIDGING CLIP 25 PAIR							
N		PK	2		4		50

DISTRIBUTION SERVICES
 NETWORK SERVICES
 TOOLS
 BUILDING JANITORIAL
 AUTOMOTIVE
 FORMS/OFFICE SUPPLIES
 GENERAL
 DATA VOICE

DISTRIBUTION SERVICES
 NETWORK SERVICES
 TOOLS
 BUILDING JANITORIAL
 AUTOMOTIVE
 FORMS/OFFICE SUPPLIES
 GENERAL
 DATA VOICE

ASSEMBLY

PRODUCT IDENTIFIER		DESCRIPTION						
ITEM NUMBER	ORD. MULT.	SELL UNIT	STD. PKG. STOCK AVAILABILITY / PA	LEAD TIME	MIN. ORD.	A	C	
300055175 ASSEMBLY EARCUSHION OVERHEAD								
5118349	1	EA	IL IN MI OH WI 04 04 04 04					
DISCONTINUE, ORDER NON STOCK UPON STOCK DEPLETION.								

BACKBOX							
400005906 BACKBOX CK16301 L 8							
1165738	1	EA					
Back box for indoor use and is equipped with a power receptacle to which a 2 conductor 4in cord is connected. BSP 463-110-100. DISCONTINUED - ORDER NON-STOCK UPON STOCK DEPLETION.							
400005930 BACKBOX CK16301 L19							
N		EA	1	3	1		
Used with the CK16301 signals. For outdoor use equipped with 3 conductor 4in power cord with weather proof shield on power receptacle, BSP 463-110-100.							

BACKPLANE							
260411905 BACKPLANE 16 SLOT 8-15							
1976704	1	EA					P/N80003852. For Datastar 5000.
260411897 BACKPLANE 16-SLOT 0-7 FOR F/N5020							
1976696	1	EA	IL IN MI OH WI 03				For Datastar 5000. P/N80003822.
260411863 BACKPLANE 8-SLOT FOR F/N5010							
1976670	1	EA	IL IN MI OH WI 03				For Datastar 5000. P/N80003771.

BASE							
102218138 BASE INDICATOR 2A							
2752782	1	EA					A multiple base used when 2 or more external visual signals are required. The 51A or 52A lamps and the 1 type indicator lens must be ordered separately, BSP 463-210-100.
260390836 BASE LOGIC DISPLAY 64501008619							
1970590		EA	IL IN MI OH WI 01 02 02				
280013590 BASE MAGNETIC 800-1500-0							
N		EA	1	2	1		
500044383 BASE MONITOR 40BSE101							
N		EA	1	2	1		
300097169 BASE TERMINAL 723 IVORY							
N		EA	10	2	10		

PRODUCT IDENTIFIER		DESCRIPTION						
ITEM NUMBER	ORD. MULT.	SELL UNIT	STD. PKG. STOCK AVAILABILITY / PA	LEAD TIME	MIN. ORD.	A	C	

BASE KEYBOARD							
500049390 BASE KEYBOARD 40BSE203							
1219790	1	EA					
500049408 BASE KEYBOARD 40BSE204							
N		EA	1	5	1		
500047451 BASE KEYBOARD 45BSE301							
1196105	1	EA	IL IN MI OH WI 04				
001146562 BASE KEYBOARD 45D101/XX							
N		EA	1	4	1		

BATTERY PACK							
SEE PACK BATTERY.							

BATTERY SHELF							
SEE SHELF BATTERY.							

BELT							
260436829 BELT OILER IBM 3835 6190661							
N		EA	1	2	1		

BLANK APPARATUS							
101052033 BLANK APPARATUS 95C 03							
1150839	1	EA					
102161544 BLANK APPARATUS 124A							
N		EA	1	1	100		

BLOCK							
100847052 BLOCK MATRIX 1A1							
1156646	1	EA					A plastic terminal used in key telephone systems, for diode controlled common audible signaling, BSP 461-620-100.
260411426 BLOCK CONNECTING SE625A3-6-50							
N		EA	1	5	10		
260411293 BLOCK CONNECTING SE625B3-4-50							
N		EA	1	5	10		
260393590 BLOCK CONNECTING SE625B4-6-50							
N		EA	1	5	10		

BOARD							
260319579 BOARD COMMUNICATIONS 80000933							
1941559	1	EA					Lee Data communication board, used in all 3274 type controllers. SAME AS PID 260371133

DISTRIBUTION SERVICES

NETWORK SERVICES

TOOLS

BUILDING JANITORIAL

AUTOMOTIVE

FORMS/OFFICE SUPPLIES

GENERAL

DATA VOICE

PRODUCT IDENTIFIER DESCRIPTION

ITEM NUMBER	ORD. MULT.	SELL UNIT	STD. PKG. STOCK AVAILABILITY / PA	LEAD TIME	MIN. ORD.	A C
-------------	------------	-----------	-----------------------------------	-----------	-----------	-----

260437926 BOARD CONTROLLER MAIN 72505657
 N EA 1 4 1
 For Apertus 1324 Printer.

300017712 BOARD INSULATED 24 X 36 X 1 IN
 N EA 1 3 1
 S-83 mineral fiber.

300017704 BOARD INSULATED 24 X 36 X 1/2IN
 N EA 1 2 4
 S-82 mineral fiber.

002079895 BOARD LOGIC M7081YB
 1224436 1 EA IL IN MI OH WI
 04 04 04

000238964 BOARD LOGIC ST 101-00
 1215699 1 EA IL IN MI OH WI
 04 04 04

001213768 BOARD LOGIC ST-101-00 DEC
 1177915 1 EA IL IN MI OH WI
 04 04 04

260369640 BOARD MEMORY COMPAQ SLT 1MB
 N
 P/N 110235-001.

260390786 BOARD SSI 1RMA 37631
 1970533 1 EA IL IN MI OH WI
 01
 CC501003784.

260319694 BOARD STATION
 1941609 1 EA IL IN MI OH WI
 02 02 02
 Lee data station board, connects to coax filter boards. SAME AS PID 260371141

BOARD MEMORY

SEE MEMORY.

BOX

260325527 BOX BATTERY TIE 15324
 N EA 1 4 1

400329736 BOX CK19316 L6
 N EA 25 5 50

400329694 BOX CK20202 L2
 N EA 25 5 25

BRACKET

100013952 BRACKET 75A
 1116541 1 EA
 For attaching 549 (A & B) signal keys to telephone sets. BSP 463-215-100.

001214006 BRACKET POWER 70-15168-00 ST113
 N EA 1 4 1

PRODUCT IDENTIFIER DESCRIPTION

ITEM NUMBER	ORD. MULT.	SELL UNIT	STD. PKG. STOCK AVAILABILITY / PA	LEAD TIME	MIN. ORD.	A C
-------------	------------	-----------	-----------------------------------	-----------	-----------	-----

BROCHURE

260325568 BROCHURE ONYX TIE 01840BRG
 N EA 1 4 1

BUBBLE PACK

SEE PACKING MATERIAL.

BUZZER

100014349 BUZZER 7D 49
 N EA 1 2 1
 Low voltage buzzers for AC or DC signaling. Refer to Tab-A in BSP 501-120-100 for operating voltages.

100014356 BUZZER 7E 49
 N EA 1 1
 Low voltage buzzers for AC or DC signaling. Refer to Tab-A in BSP 501-120-100 for operating voltages.

997912662 BUZZER CK08109 L2
 1183814 1 EA IL IN MI OH WI
 04 04 04 04
 A single coil buzzer used with AC or DC voltages 14 to 30 volts, 50 to 60 cycles, BSP 501-120-100.

400021796 BUZZER CK14458 L1
 N EA 1 2 1

402699011 BUZZER CK20419 L2
 1222091 1 EA IL IN MI OH WI
 04 04 04 04
 A miniature 6 to 10 volt AC buzzer e/w two spade tipped leads and a volume adjusting screw. Can be mounted on one of the dial mounting screws of a telephone set, BSP 501-120-100.

CABINET

260402532 CABINET 4-SLOT FN5005
 N EA 1 4 1

260402540 CABINET 8-SLOT FN5010
 N EA 1 4 1

260402557 CABINET 16-SLOT FN5020
 N EA 1 4 1

002049310 CABINET 1720-5 TRACTOR 80
 1145870 1 EA IL IN MI OH WI
 03 03 03 03
 DISCONTINUE UPON STOCK DEPLETION.

002049302 CABINET 1722-5 TRACTOR 132
 1222273 1 EA IL IN MI OH WI
 03 03 03 03

DISTRIBUTION SERVICES
 NETWORK SERVICES
 TOOLS
 BUILDING JANITORIAL
 AUTOMOTIVE
 FORMS/OFFICE SUPPLIES
 GENERAL
 DATA VOICE

CABINET

PRODUCT IDENTIFIER		DESCRIPTION					
ITEM NUMBER	ORD. MULT.	SELL UNIT	STD. PKG. STOCK AVAILABILITY / PA	LEAD TIME	MIN. ORD.	A C	
260325329		CABINET	1A2 INT TIE 88145				
N		EA	1	4	1		
500045208		CABINET	40CAB201/ZZ				
N		EA	1	5	1		
500027875		CABINET	40CAB251/AB				
N		EA	1	5	1		
500044169		CABINET	40CAB251/ZZ				
N		EA	1	5	1		
500043609		CABINET	40CAB351/AA				
N		EA	1	5	1		
500048285		CABINET	40CAB351/YZ				
N		EA	1	5	1		
500045174		CABINET	40CAB351/ZZ				
N		EA	1	5	1		
260000021		CABINET	40CAB351/ZZ				
N		EA	1		1		
500044367		CABINET	40CAB353/YZ				
N		EA	1	5	1		
500048293		CABINET	40CAB353/YZ				
N		EA	1	5	1		
500046123		CABINET	40CAB371/ZZ				
N		EA	1	5	1		
500047469		CABINET	45CAB401/AAA				
1165316	1	EA	IL IN MI OH WI 03 03 03 03				
Used for Dataspeed 4640 service.							
500047477		CABINET	45CAB701/AAA				
N		EA	1	5	1		
500050398		CABINET	45CAB701/AAA				
1126052	1	EA	IL IN MI OH WI 02 02 02 02 02				

CABLE

260354329		CABLE MODEM	6FT				
N		EA	1	1	1		
Will connect Hayes external modem to any IBM serial port.							
260354311		CABLE MODEM	10FT				
N		EA	1	2	1		
Will connect Hayes external modem to any IBM serial port.							
260436233		CABLE NCR FLEX DISK DRIVE					
N		EA	1	2	1		
NCR brand flex disk drive cable used to connect flex disk to controller.							

PRODUCT IDENTIFIER		DESCRIPTION					
ITEM NUMBER	ORD. MULT.	SELL UNIT	STD. PKG. STOCK AVAILABILITY / PA	LEAD TIME	MIN. ORD.	A C	
260436241		CABLE NCR SCSI FIXED DISK					
N		EA	1	2	1		
NCR brand fixed disk cable used to connect fixed disk drive to controller.							
260354303		CABLE PARALLEL 10FT DB25M TO DB25M					
1970376		EA	IL IN MI OH WI 04 04 04				
Will connect any parallel printer to any IBM parallel printer port, including H-P Laserjet series II, Epson, Okidata, ECT.							
260354295		CABLE PARALLEL 6FT DB25M TO DB25M					
1970384		EA	IL IN MI OH WI 04 04 04				
Will connect any parallel printer to any IBM parallel printer port, including H-P Laserjet series II, Epson, Okidata, etc.							
000238832		CABLE STEP ST112-00					
N		EA	1	4	1		
260325501		CABLE TIE BATTERY BOX 88199					
N		EA	1	4	1		
260325493		CABLE TIE EXP. CAB 25 PAIR 88199					
N		EA	1	4	1		
CABLE INTERFACE							
260359567		CABLE INTERFACE IBM 53F4781					
1953505	1	EA					
Used for IBM feat 5179-1, required to install IBM model 3174 controller.							
CARD							
260366695		CARD	3 COM MCA 523 ETHERNET				
N		EA	1	1	1		
Adapter for PS/2 PC'S - MCA.							
260390810		CARD	16 PORT				
1970541		EA	IL IN MI OH WI 02 02 02 02				
CC106226863.							
500050265		CARD	43FG210/AA/02				
N		EA	1	5	1		
500049234		CARD	45FG110/AE/01				
N		EA	1	5	1		
500050190		CARD	45FG111/BE 01 REFURBISHED				
1129973	1	EA	IL IN MI OH WI 03 03 03 03 03				
Feature card group for data. M/D - NO REPLACEMENT							
500048640		CARD	45FG111/BE/01				
N		EA	1	5	1		

PRODUCT IDENTIFIER		DESCRIPTION					
ITEM NUMBER	ORD. MULT.	SELL UNIT	STD. PKG. STOCK AVAILABILITY / PA	LEAD TIME	MIN. ORD.	A C	
500050208 CARD 45FG111/SF 01							
1150417	1	EA	IL IN MI OH WI 03 03				
Used for DataSpeed 4540 service.							
500051446 CARD 45FG411/AE/01							
N		EA	1	5	1		
260429659 CARD 2 PORT ASYNCHRONOUS 64501009138							
N		EA	1	4	1		
Memorex 6541.							
260437074 CARD 3 COM MCA 3C507							
N		EA	1	2	1		
3 COM Etherlink card 3C507 non-MCA card for use in 8 & 16 bit CPU's.							
260437041 CARD 3 COM MCA 3C507-TP							
N		EA	1	2	1		
3 COM Etherlink card 3C507-TP for non-MCA servers 8 & 16 bit on twisted pair.							
260437058 CARD 3 COM MCA 3C523-TP							
N		EA	1	2	1		
3 COM Etherlink card 3C523-TP for MCA Bus CPU's on twisted pair (10BASE-T).							
260437066 CARD 3 COM MCA 3C527							
N		EA	1	2	1		
3 COM Etherlink card 3C527 32 bit card for file server.							
260437025 CARD 3 COM MCA 3C543							
N		EA	1	2	1		
3 COM Etherlink card 3C543 Nubus for MacIntosh Workstations.							
260437033 CARD 3 COM MCA 3C543-TPX							
N		EA	1	2	1		
3 COM Etherlink card 3C543-TPX Nubus for MacIntosh Workstations on twisted pair.							
260429709 CARD 4 PORT 1174-90R 953452-004							
N		EA	1	4	1		
Memorex Telex.							
260429642 CARD 4 PORT EXPANSION 64501014021							
N		EA	1	4	1		
Memorex 6541.							
260429667 CARD 512K 6541 64501009112							
N		EA	1	4	1		
Memorex 6541.							
260420476 CARD 6530 AUX PRINTER P/N 64500067806							
N		EA	1	4	1		
260420583 CARD ASCII 90R P/N 953455-001-0104							
N		EA	1	4	1		
300052065 CARD C 2121 CODEX 48365							
1330431	1	EA	IL IN MI OH WI 01 01 01 01				
Combination transmit/receive card used in Set Data Codex 48350.							

PRODUCT IDENTIFIER		DESCRIPTION					
ITEM NUMBER	ORD. MULT.	SELL UNIT	STD. PKG. STOCK AVAILABILITY / PA	LEAD TIME	MIN. ORD.	A C	
300060431 CARD CHANNEL TERM M-832							
1140830	1	EA	IL IN MI OH WI 04				
260325402 CARD DIRECTORY TRAY TIE 88159							
N		EA	1	4	1		
260404504 CARD IBM PS/2 3270 CONNECTION							
N		EA	1	1	1		
P/N74F3465.							
260423488 CARD IBM TOKEN RING 16/4							
N		EA	1	1	1		
For use in non-MCA Personal Computers.							
260427000 CARD INTERFACE UNIVERSAL							
N		EA	1	1	1		
000246330 CARD LINE INTERFACE 47041							
N		EA	1	4	1		
260390802 CARD LOGIC ASYNC HOST 846544120							
1970574		EA	IL IN MI OH WI 01 02				
CC501006803.							
260390794 CARD LOGIC SYNC HOST							
1970608		EA	IL IN MI OH WI 04 04				
CC501012066.							
260402235 CARD PCB 2131 MN CLR 72507025							
1968321	1	EA	IL IN MI OH WI 04 04 04 04				
260402268 CARD PCB 2131 VID CLR 72507026							
1968297	1	EA	IL IN MI OH WI 03 03 03				
260360151 CARD PRINTER INTERFACE 1301A							
N		EA	1	4	1		
260385737 CARD STATION PCB 80003001							
N							
260420534 CARD - K 6544 P/N64501003636							
N		EA	1	4	1		
260420542 CARD - X 6544 P/N64501005391							
N		EA	1	4	1		
CARTON - SEE PACKING MATERIAL							
CARTRIDGE							
260323951 CARTRIDGE 3480 BASF							
N		EA	1	4	240		
260325014 CARTRIDGE 3480 DYSAN							
N		EA	1	4	390		

DISTRIBUTION SERVICES
 NETWORK SERVICES
 TOOLS
 BUILDING JANITORIAL
 AUTOMOTIVE
 FORMS/OFFICE SUPPLIES
 GENERAL
 DATA VOICE

DISTRIBUTION SERVICES

CARTRIDGE

PRODUCT IDENTIFIER		DESCRIPTION				
ITEM NUMBER	ORD. MULT.	SELL UNIT	STD. PKG. STOCK AVAILABILITY / PA	LEAD TIME	MIN. ORD.	A C
260325022		CARTRIDGE 3480 STORAGE MASTER				
N		EA	1	4	450	
260388251		CARTRIDGE DATA MINI 3M-2120				
N		BX Rhomat format.	1	2	1	
260384607		CARTRIDGE DATA SYQUEST 45MEG				
N		EA SQ400.	1	2	1	

NETWORK SERVICES

TOOLS

PRODUCT IDENTIFIER		DESCRIPTION				
ITEM NUMBER	ORD. MULT.	SELL UNIT	STD. PKG. STOCK AVAILABILITY / PA	LEAD TIME	MIN. ORD.	A C
260358668		CARTRIDGE INK DESKJET HP 51608A				
1970327	1	EA	IL IN MI OH WI 33 33 33			
Hewlett-Packard.						
260404686		CARTRIDGE POSTSCRIPT				
N		EA	1	2	1	
For Hewlett-Packard Models II/IIP/III and IIID Laserjet Printers, P/N33438P.						

BUILDING JANITORIAL

PRODUCT IDENTIFIER		DESCRIPTION				
ITEM NUMBER	ORD. MULT.	SELL UNIT	STD. PKG. STOCK AVAILABILITY / PA	LEAD TIME	MIN. ORD.	A C
260344346		CARTRIDGE PRINTER THINKJET BLACK				
N		EA	1	1	1	
Hewlett-Packard HP92261A.						
260358650		CARTRIDGE PRINTHEAD BLACK 51604A				
1970343	1	EA	IL IN MI OH WI 04			
Hewlett-Packard.						

AUTOMOTIVE

PRODUCT IDENTIFIER		DESCRIPTION				
ITEM NUMBER	ORD. MULT.	SELL UNIT	STD. PKG. STOCK AVAILABILITY / PA	LEAD TIME	MIN. ORD.	A C
260358635		CARTRIDGE PRINTHEAD BLACK 51606A				
N		EA	1	2	1	
Hewlett-Packard.						
260358676		CARTRIDGE PRINTHEAD BLACK 92261A				
1970335	1	EA	IL IN MI OH WI 04 04 04			
Hewlett-Packard.						

FORMS/OFFICE SUPPLIES

PRODUCT IDENTIFIER		DESCRIPTION				
ITEM NUMBER	ORD. MULT.	SELL UNIT	STD. PKG. STOCK AVAILABILITY / PA	LEAD TIME	MIN. ORD.	A C
260358643		CARTRIDGE PRINTHEAD CLEAR 51606C				
1970350	1	EA	IL IN MI OH WI 04 04 04			
Hewlett-Packard.						

GENERAL

PRODUCT IDENTIFIER		DESCRIPTION				
ITEM NUMBER	ORD. MULT.	SELL UNIT	STD. PKG. STOCK AVAILABILITY / PA	LEAD TIME	MIN. ORD.	A C
260404652		CASE CARRYING DICONIX 150				
N		EA	1	2	1	
Fits either Parallel or Serial Diconix 150 Portable Printers.						
280071549		CASE PELICAN 1400				
N		EA	1	2	1	
Use with respiratory equipment.						

DATA VOICE

PRODUCT IDENTIFIER		DESCRIPTION				
ITEM NUMBER	ORD. MULT.	SELL UNIT	STD. PKG. STOCK AVAILABILITY / PA	LEAD TIME	MIN. ORD.	A C
CAULK FIRE BARRIER						
SEE FIRE BARRIER.						
CHANNEL SERVICE UNIT						
SEE MODEM T1 CSU, SECTION 8000.						

PRODUCT IDENTIFIER		DESCRIPTION				
ITEM NUMBER	ORD. MULT.	SELL UNIT	STD. PKG. STOCK AVAILABILITY / PA	LEAD TIME	MIN. ORD.	A C
CHARGER						
260421359		CHARGER FOR GAS MONITOR 115V				
N		EA	1	3	1	
SINGLE UNIT P/N1810-0123.						

PRODUCT IDENTIFIER		DESCRIPTION				
ITEM NUMBER	ORD. MULT.	SELL UNIT	STD. PKG. STOCK AVAILABILITY / PA	LEAD TIME	MIN. ORD.	A C
CHASSIS						
000238865		CHASSIS RIB 70-13859-00(ST109)				
N		EA	1	4	1	

PRODUCT IDENTIFIER		DESCRIPTION				
ITEM NUMBER	ORD. MULT.	SELL UNIT	STD. PKG. STOCK AVAILABILITY / PA	LEAD TIME	MIN. ORD.	A C
CHIP INTEL						
260404611		CHIP INTEL 1MB 1M80				
N		EA	1	1	1	
For use with Intel aboveboard plus/8, 9 chips equal 1MB memory, order in sets of 9.						

PRODUCT IDENTIFIER		DESCRIPTION				
ITEM NUMBER	ORD. MULT.	SELL UNIT	STD. PKG. STOCK AVAILABILITY / PA	LEAD TIME	MIN. ORD.	A C
260404629		CHIP INTEL 1MB SIMMS 80NS				
N		EA	1	1	1	
For use with Intel Aboveboard MC32, 1 chip equals 1MB of memory, P/N1M80SIMMS.						

PRODUCT IDENTIFIER		DESCRIPTION				
ITEM NUMBER	ORD. MULT.	SELL UNIT	STD. PKG. STOCK AVAILABILITY / PA	LEAD TIME	MIN. ORD.	A C
260366752		CHIP INTEL 80287-10				
N		EA	1	1	1	
For use in IBM PS/2 model 60, 30-286, 50Z-031 & -061.						

PRODUCT IDENTIFIER		DESCRIPTION				
ITEM NUMBER	ORD. MULT.	SELL UNIT	STD. PKG. STOCK AVAILABILITY / PA	LEAD TIME	MIN. ORD.	A C
260366901		CHIP INTEL 80387-16				
N		EA	1	1	1	
For use in IBM PS/2 model 80-041 & -071.						

PRODUCT IDENTIFIER		DESCRIPTION				
ITEM NUMBER	ORD. MULT.	SELL UNIT	STD. PKG. STOCK AVAILABILITY / PA	LEAD TIME	MIN. ORD.	A C
260395678		CHIP INTEL 80387-20				
N		EA	1	1	1	
Math coprocessor, works in IBM PS/2 model 70-061.						

PRODUCT IDENTIFIER		DESCRIPTION				
ITEM NUMBER	ORD. MULT.	SELL UNIT	STD. PKG. STOCK AVAILABILITY / PA	LEAD TIME	MIN. ORD.	A C
260366737		CHIP INTEL 80387-20				
N		EA	1	1	1	
For use in IBM PS/2 model 70-121 & Compaq 386/20E.						

PRODUCT IDENTIFIER		DESCRIPTION				
ITEM NUMBER	ORD. MULT.	SELL UNIT	STD. PKG. STOCK AVAILABILITY / PA	LEAD TIME	MIN. ORD.	A C
260366893		CHIP INTEL 80387-25				
N		EA	1	1	1	
For use in IBM PS/2 model 70-A21 & Compaq 386/25.						

PRODUCT IDENTIFIER		DESCRIPTION				
ITEM NUMBER	ORD. MULT.	SELL UNIT	STD. PKG. STOCK AVAILABILITY / PA	LEAD TIME	MIN. ORD.	A C
260366729		CHIP INTEL 80387-33				
N		EA	1	1	1	

PRODUCT IDENTIFIER		DESCRIPTION				
ITEM NUMBER	ORD. MULT.	SELL UNIT	STD. PKG. STOCK AVAILABILITY / PA	LEAD TIME	MIN. ORD.	A C
260366885		CHIP INTEL 80387-SX				
N		EA	1	1	1	
For use in IBM PS/2 model 55SX & ALL Compaq 386S PC'S.						

PRODUCT IDENTIFIER DESCRIPTION

ITEM NUMBER	ORD. MULT.	SELL UNIT	STD. PKG. STOCK AVAILABILITY / PA	LEAD TIME	MIN. ORD.	A C
-------------	------------	-----------	-----------------------------------	-----------	-----------	-----

260395660 CHIP INTEL 80387-SX 16
 N EA 1 1 1
 Math coprocessor chip, works in PS/2 model 555X PC.

CHIP MEMORY

280070202 CHIP MEMORY 256K 120NS EACH 6525612
 N EA 1 1 1

CIRCUIT PACK

SEE PACK CIRCUIT.

CLEANING UNIT

260344320 CLEANING UNIT-IBM 4216 PAGERMAKER
 N EA 1 1 1

CLIP

300055407 CLIP CLOTHING PACKAGE OF 10
 N PK 1 4 1
 Used with Headsets.

COMPUTER

SEE PERSONAL COMPUTER.

CONNECTOR

280045121 CONNECTOR QUICK LINK F/N1271
 1925503 1 EA
 Lee Data, Port Expansion.

260360177 CONNECTOR QUICK LINK F/N1961
 1970491 1 EA IL IN MI OH WI
 04 04 04 04

280043506 CONNECTOR QUICK LINK F/N1963 DISPLAY
 N EA 1 4 1
 Lee Data.

280045139 CONNECTOR QUICK LINK F/N1965 DISPLAY
 N EA 1 6 1
 Lee Data, Controller.

CONSOLE

260325295 CONSOLE 80-BUTTON TIE 89555-A
 N EA 1 4 1

260441902 CONSOLE ENHANCED POSITION A97GAL532
 N EA 1 6 1

500028345 CONSOLE OPERATOR 40K101/CAK
 N EA 1 5 1

PRODUCT IDENTIFIER DESCRIPTION

ITEM NUMBER	ORD. MULT.	SELL UNIT	STD. PKG. STOCK AVAILABILITY / PA	LEAD TIME	MIN. ORD.	A C
-------------	------------	-----------	-----------------------------------	-----------	-----------	-----

300008745 CONSOLE OPERATOR 40K101/CAK
 N EA 1 2 1

260000054 CONSOLE OPERATOR 40K101/CAK
 1996520 1 EA IL IN MI OH WI
 04 04 04 04

500045968 CONSOLE OPERATOR 40K104/DAB
 1185777 1 EA IL IN MI OH WI
 04 04 04 04 04

500046008 CONSOLE OPERATOR 40K105/CAA
 N EA 1 5 1

500050711 CONSOLE OPERATOR 40K203/GAB
 N EA 1 5 1

260000062 CONSOLE OPERATOR 43K101/CAA
 1996538 1 EA IL IN MI OH WI
 04 04

260441910 CONSOLE STANDARD POSITION A97GAL531
 N EA 1 6 1

103835138 CONSOLE TELEPHONE 126C6Y-50L DR
 N EA 1 1

102873619 CONSOLE TELEPHONE 27A-9T L/HOUSING
 1195131 1 EA IL IN MI OH WI
 04

102873668 CONSOLE TELEPHONE 47A-6T L/HOUSING
 N EA 1 8 1

103155578 CONSOLE TELEPHONE 600D2-A
 N EA 1 2 1

CONTROLLER

280045220 CONTROLLER 32 DEV FN 411A
 1925578 1 EA
 Lee Data B EXP-9.6K ADP.

500043989 CONTROLLER 40C204/BA
 N EA 1 5 1

260000070 CONTROLLER 40C303/AA/001
 1996546 1 EA IL IN MI OH WI
 01 01 01 01

500046529 CONTROLLER 40C303/AC/003
 N EA 1 5 1

500048574 CONTROLLER 40C303/AD
 1145474 1 EA IL IN MI OH WI
 01 01 01 01 01
 Refurbished only.

500048475 CONTROLLER 45C310/XXX/999
 1176495 1 EA IL IN MI OH WI
 04 04 04 04 04
 Controller for dataspeed 4540.

DISTRIBUTION SERVICES

NETWORK SERVICES

TOOLS

BUILDING JANITORIAL

AUTOMOTIVE

FORMS/OFFICE SUPPLIES

GENERAL

DATA VOICE

DISTRIBUTION SERVICES

NETWORK SERVICES

TOOLS

BUILDING JANITORIAL

AUTOMOTIVE

FORMS/OFFICE SUPPLIES

GENERAL

DATA VOICE

CONTROLLER

PRODUCT IDENTIFIER		DESCRIPTION					
ITEM NUMBER	ORD. MULT.	SELL UNIT	STD. PKG. STOCK AVAILABILITY / PA	LEAD TIME	MIN. ORD.	A	C
500049184		CONTROLLER	45C320/AAD/999				
N		EA	1	2	1		
			Used in a 4420/2 buffered display terminal.				
500047485		CONTROLLER	45C340/AAA/999				
N		EA	1	5	1		
500050216		CONTROLLER	45C340/AAE/999				
1161034	1	EA	IL IN MI OH WI 01 01 01 01 01				
			Controller for dataspeed 4540.				
500047493		CONTROLLER	45C340/AAF/999				
N		EA	1	5	1		
260000088		CONTROLLER	45C340/AAF/999				
1996553	1	EA	IL IN MI OH WI 01 01 01 01 01				
500050232		CONTROLLER	45C340/AAH/999				
N		EA	1	5	1		
260323431		CONTROLLER	1804-8A1				
1943837	1	EA	IL IN MI OH WI 01				
			DATA CAP SEL CL.				
260406913		CONTROLLER	6542 T-TOP				
N		EA	1	4	1		
			CC501009120.				
501006779		CONTROLLER	6544				
N		EA	1	4	1		
260320379		CONTROLLER	6561				
1941252	1	EA	IL IN MI OH WI 04 04 04 04				
			CC500064449.				
260406905		CONTROLLER	6562 PRINT #64846623502				
N		EA	1	3	1		
260390851		CONTROLLER	DUAL DRIVE				
1970582		EA	IL IN MI OH WI 01				
			CC501008486.				
300074523		CONTROLLER	MASTER DAVOX #CL06-01				
1172577	1	EA	IL IN MI OH WI 01 01				
			DISCONTINUE UPON STOCK DEPLETION.				
260429626		CONTROLLER	MINI 6541 64501013973				
N		EA	1	4	1		
			Memorex.				
260420567		CONTROLLER	MMTLX 90R				
N		EA	1	3	1		
			P/N 900281-102-01.				
280045212		CONTROLLER	REMOTE 16PORT FN 308				
N		EA	1	6	1		
			Lee Data.				

PRODUCT IDENTIFIER		DESCRIPTION					
ITEM NUMBER	ORD. MULT.	SELL UNIT	STD. PKG. STOCK AVAILABILITY / PA	LEAD TIME	MIN. ORD.	A	C
280079278		CONTROLLER	TERMINAL 3174-01R				
1935643	1	EA	IL IN MI OH WI 01				
			W/1046, 9000, 9016, 9017, new replacement is 3174-11R.				
260368998		CONTROLLER	TERMINAL 3174-11R				
1955534	1	EA	IL IN MI OH WI 01 01				
			W/RS-232. Includes features 1048, 9010, 9016, 9021 (used for V.24). Must order PT #25F8490 if using for V.35.				
260425129		CONTROLLER	TERMINAL IBM 3174-61R				
N							
260425137		CONTROLLER	TERMINAL IBM 3174-91R				
N							
280042979		CONTROLLER	W/FN5250 F/N 413				
1924746	1	EA	IL IN MI OH WI 01 01				
			Lee Data.				
COPROCESSOR							
260404512		COPROCESSOR	INTEL 80287XLT MATH				
N		EA	1	1	1		
CORD							
002078038		CORD	1PWCO4P24J DE100F				
N		EA	1	4	1		
101426401		CORD	3P 2A				
N		EA	1	12	1		
260402029		CORD	4FT 84-0468-0-004 RS232				
1968081	1	EA	IL IN MI OH WI 09				
			Used to connect DPN-100/5 Peripheral Interface Module (QPA164) packet switch to the General Data Comm modem shelf.				
260330949		CORD	8 PIN 2FT TAILS 7FT				
N		EA	1	3	1		
260330956		CORD	8 PIN 2FT TAILS 14FT				
N		EA	1	3	1		
280000670		CORD	182827-084-LINE 7FT				
N		EA	1	4	1		
102360682		CORD	D 6AB 87 LONG				
1311118	1	EA	IL IN MI OH WI 04 04 04 04 04				
			A straight conductor mounting cord, silver satin, used with the 701B Telephone Set, Princess, BSP 501-140-103.				

PRODUCT IDENTIFIER		DESCRIPTION					
ITEM NUMBER	ORD. MULT.	SELL UNIT	STD. PKG. STOCK AVAILABILITY / PA	LEAD TIME	MIN. ORD.	A	C
102937588		CORD D	6AP 87 XLONG				
N		EA	6	3	6		
Six conductor modular mounting cord used with telephone sets where more than one feature is required, individually packaged, BSP 502-501-102.							
103939633		CORD D	8AH 87 7FT				
N		EA	1	3	1		
103684791		CORD D	50AB 87 7FT 6IN				
5514760	1	EA	IL IN MI OH WI 04 04				
Individually packaged. DISCONTINUE - ORDER NON STOCK UPON STOCK DEPLETION							
102318318		CORD H4CJ	50 LONG				
1168492	1	EA	IL IN MI OH WI 59				
Individually packaged, retractable, 4 conductor, colored, handset cords, for use with G3AR, G3BR, G5GR handsets, BSP 501-140-102. DISCONTINUE UPON STOCK DEPLETION							
102394319		CORD	L4BY-PN8354-8596 10FT				
N		EA	1	5	4		
100145275		CORD	L4CA VINYL 8366 15FT				
N		EA	1	5	7		
A 4 conductor retractable cord arranged for use with 52 type head telephone set and 396A 3 plug, BSP 501-140-120.							
102526456		CORD M	1R 4				
2823005	1	EA	IL IN MI OH WI 04 04 04 04				
102526464		CORD M	1R 4 3/4				
2823062	1	EA	IL IN MI OH WI 04 04 04				
102292554		CORD M	13F 87 5FT 6IN				
1311183	1	EA	IL IN MI OH WI 04 04 04				
103267852		CORD M	16N 87 1FT				
5103598	1	EA	IL IN MI OH WI 04 04				
260390752		CORD M	25B 50FT				
N		EA	1	3	1		
100159854		CORD S	3B SLATE W/310 GRAY 4FT				
1134734	1	EA	IL IN MI OH WI 04 04 04 04				
DISCONTINUE, ORDER NON STOCK UPON STOCK DEPLETION							
100861160		CORD S	3B SLATE W/310 GRAY 6FT				
N		EA	1	3	1		
100159862		CORD S	3B SLATE W/310 RED 4FT				
N		EA	1	3	1		
103289856		CORD W	4DD 16FT BLACK M/D				
1956037	1	EA	IL IN MI OH WI 04 04 04 04				
REPLACED BY CORD W4DG (1956307).							

PRODUCT IDENTIFIER		DESCRIPTION					
ITEM NUMBER	ORD. MULT.	SELL UNIT	STD. PKG. STOCK AVAILABILITY / PA	LEAD TIME	MIN. ORD.	A	C
402387963		CORD CK	20340 L 3 10FT				
1192286	1	EA	IL IN MI OH WI 04				
400931770		CORD CK	20908 L 3 CLOCK				
N		EA	1	8	1		
260353727		CORD EXTENSION	HOST 8730-00				
1952168	1	EA	IL IN MI OH WI 04				
To be used in central offices with Set Tel Head 905-0558. DISCONTINUE UPON STOCK DEPLETION							
280000514		CORD HAND	6FT 901800 072				
N		EA	1	4	1		
280026584		CORD HAND	6FT 901809 072				
N		EA	1	4	1		
280000936		CORD HAND	6FT 901813 072				
N		EA	1	4	1		
280000654		CORD HAND	9FT 901800 108				
N		EA	1	4	1		
280000944		CORD HAND	9FT 901809 108				
N		EA	1	4	1		
280000951		CORD HAND	9FT 901813 108				
N		EA	1	4	1		
260325469		CORD MOUNTING	TIE 7FT 89086				
N		EA	1	4	1		
260325477		CORD MOUNTING	TIE 14FT 89087				
N		EA	1	4	1		
SEE PID 102479896							
100151729		CORD P	2CT				
N		EA	1	14	1		
102808581		CORD P	2EF 1FT 4IN RED/BLACK				
2664763	1	EA	IL IN MI OH WI 59 59 59 59				
Intended for use with 302 & 303 type connector used in ESS central offices. Jackless straight cord/w 2 tinsel conductors, bulk pack.							
103105276		CORD P	2FL 1FT 4IN RED/BLUE				
N		EA	1	1	2		
Individual pack.							
103105268		CORD P	2FL 1FT 4IN RED/BLUE				
N		EA	1	1	5		
Bulk pack.							
103643987		CORD P	2FM 1FT 4IN				
N		EA	1	4	3		
Individual pack.							
280013913		CORD PJ	86 WITH PJ05IR PLUGS				
N		EA	1	4	3		

DISTRIBUTION SERVICES

NETWORK SERVICES

TOOLS

BUILDING JANITORIAL

AUTOMOTIVE

FORMS/OFFICE SUPPLIES

GENERAL

DATA VOICE

CORD

DISTRIBUTION SERVICES

PRODUCT IDENTIFIER		DESCRIPTION				
ITEM NUMBER	ORD. MULT.	SELL UNIT	STD. PKG. STOCK AVAILABILITY / PA	LEAD TIME	MIN. ORD.	A C

260361092 CORD PJ 98 DUAL PATCH 10FT
 N EA 1 4 1
 With PJ8 Plugs.

NETWORK SERVICES

402834378 CORD PJ 694 DUAL 3 CONVERSION 8 FC
 N EA 1 4 2

260361084 CORD PJ 696 DUAL PATCH 12FT
 N EA 1 4 2
 Bantam conversion.

TOOLS

401917976 CORD PJ 712 PATCH 1FT
 1944041 1 EA IL IN MI OH WI
 04 04 04

402443196 CORD PJ 713 SINGLE 3-CONDUCTOR
 N EA 1 4 7

402310874 CORD PJ 714 SINGLE 3-CONDUCTOR
 N EA 1 4 7

BUILDING JANITORIAL

401765557 CORD PJ 715 SINGLE 3-CONDUCTOR
 N EA 1 4 7

401887476 CORD PJ 716 SINGLE 3-CONDUCTOR
 N EA 1 4 6
 36in, 3 conductor-single plug bottom patch cord.
 Color - Gray.

402032049 CORD PJ 718 SINGLE 3-CONDUCTOR
 N EA 1 4 6

AUTOMOTIVE

401765565 CORD PJ 720 SINGLE 3-CONDUCTOR
 N EA 1 4 6
 60in, 3 conductor-single plug bantam patch cord.
 Color - Gray.

402032056 CORD PJ 722 3-CONDUCTOR
 1940403 1 EA IL IN MI OH WI
 04 04 04 04

FORMS/OFFICE SUPPLIES

402484778 CORD PJ 762 DUAL 3 CONDUCTOR 1FT
 N EA 1 4 4
 Bantam.

402530802 CORD PJ 764 DUAL 3 CONDUCTOR 2FT
 N EA 1 4 4
 Bantam.

GENERAL

402074181 CORD PJ 765 DUAL 3 CONDUCTOR 30IN
 N EA 1 4 5
 Bantam.

401766134 CORD PJ 766 DUAL PATCH 3FT
 N EA 1 4 4
 Bantam.

401275326 CORD PJ 770 DUAL PATCH 5FT
 N EA 1 4 3
 Bantam.

DATA VOICE

402258271 CORD PJ 772 DUAL 3-CONDUCTOR
 N EA 1 4 4

PRODUCT IDENTIFIER		DESCRIPTION				
ITEM NUMBER	ORD. MULT.	SELL UNIT	STD. PKG. STOCK AVAILABILITY / PA	LEAD TIME	MIN. ORD.	A C

401767686 CORD PJ 944 CONVERSION
 1940437 1 EA IL IN MI OH WI
 04 04 04 04
 Used with DSX-1 and DSX-1C. 48in Bantam to Weeco 310.

401767694 CORD PJ 946 CONVERSION
 1940445 1 EA IL IN MI OH WI
 59 59 59 59 59
 72in, 3 conductor-single plug patch cord. Used to inter face standard jack and jackfield to bantam jack and jackfield when patching or testing circuits.

402096259 CORD PJ 948 CONVERSION
 1940452 1 EA IL IN MI OH WI
 59 59 59 59 59
 96in, Plastic jacketed 3 conductor-single plug on each end of cord.

402310890 CORD PJ 950 SINGLE CONVERSION
 N EA 1 4 3

401918008 CORD PJ 952 CONVERSION CORD
 1940460 1 EA IL IN MI OH WI
 59 59 59 59 59
 A 12ft 3-conductor single patch cord e/w Plug 310 on one end, the other end e/w Mini-plug. Used to interface standard jack and jack field to bantam jack for patching or testing circuits.

260303904 CORD PJ 1212 3-CONDUCTOR
 1940478 1 EA IL IN MI OH WI
 04 04 04 04

260361076 CORD PJ 1530 DUAL PATCH 30FT
 N EA 1 4 2
 Bantam.

260325485 CORD TIE LINE 89088
 N EA 1 4 1

401246509 CORD WEATHERPROOF B CA08734 L1
 1198457 1 EA IL IN MI OH WI
 04 04 04 04 04
 50ft, 3 conductor, 16 gauge, stranded. Provides telephone interconnect between dock & boat in a marina or service pad for recreational vehicle in trailer park, BSP 461-220-101. Arrowhart WE16599.

401686787 CORD WEATHERPROOF C 50FT
 N EA 1 4 1
 Arrowhart WE16716.

260325436 CORD WHITE TIE 6FT 12442
 N EA 1 4 1

260325444 CORD WHITE TIE 9FT 12443
 N EA 1 4 1

260325451 CORD WHITE TIE 13FT 12444
 N EA 1 4 1

PRODUCT IDENTIFIER DESCRIPTION

ITEM NUMBER	ORD. MULT.	SELL UNIT	STD. PKG. STOCK AVAILABILITY / PA	LEAD TIME	MIN. ORD.	A C
-------------	------------	-----------	-----------------------------------	-----------	-----------	-----

CORD EXTENSION

260344916 CORD EXTENSION 10 FT

1950865 1 EA
3 conductor, 14 gauge, 15 amp.

280021155 CORD EXTENSION 2283-25

N EA 1 2 1

CORD PATCH

260338710 CORD PATCH 1FT CC1072N

1948570 1 EA
Standard size coaxial. CP1041 Plug.

260338686 CORD PATCH 2FT CC1552N

1948547 1 EA IL IN MI OH WI
04 04 04 04
Midsize coaxial. CP1540 Plug.

260338694 CORD PATCH 6FT CC1082N

1948554 1 EA IL IN MI OH WI
04 04 04 04
Standard size coaxial. CP1041 Plug.

260341433 CORD PATCH 6FT CC1556N

1949818 1 EA IL IN MI OH WI
04 04 04 04
Midsize coaxial. CP1540N Plug.

260338702 CORD PATCH 10FT CC1090N

1948562 1 EA IL IN MI OH WI
04 04 04 04
Standard size coaxial. CP1041 Plug.

260341458 CORD PATCH 10FT CC1550N

1949800 1 EA IL IN MI OH WI
04 04 04 04
Midsize coaxial. CP1540N Plug.

CORD REEL

SEE REEL CORD.

CORD SHIELDED

260324389 CORD SHIELDED 8 PIN 15FT

1944728 1 EA
023-800062.

260324397 CORD SHIELDED 8 PIN 30FT

1944736 1 EA IL IN MI OH WI
04 04 04 04
023-800061.

CORD TEST

260405345 CORD TEST F-013576 1135 RIGHT 24FT

1969535 1 EA

PRODUCT IDENTIFIER DESCRIPTION

ITEM NUMBER	ORD. MULT.	SELL UNIT	STD. PKG. STOCK AVAILABILITY / PA	LEAD TIME	MIN. ORD.	A C
-------------	------------	-----------	-----------------------------------	-----------	-----------	-----

260405337 CORD TEST F-013577 1136 RIGHT 8FT

1969527 1 EA IL IN MI OH WI
04 04 04 04

260405352 CORD TEST F-013578 1134 8FT

1969543 1 EA IL IN MI OH WI
04 04 04 04

102315017 CORD TEST P3BH 3FT SLATE

1150334 1 EA IL IN MI OH WI
04 04 04 04
For use with 100A conference systems.

102314705 CORD TEST P3BH 6FT SLATE

1310680 1 EA IL IN MI OH WI
04 04 04 04
3 conductor patching cord assemblies equipped with a No. 121A cord weight, bulk pack.

102314739 CORD TEST P3BH 12FT SLATE

5502864 1 EA IL IN MI OH WI
04 04 04 04
For use with 100A conference systems.

CORDAGE

HEAVY DUTY. BSP 159-440-001.

996328704 CORDAGE CK15141 16/2 SOSJO

1146308 1 FT

997303375 CORDAGE CK15143 14/3 SJO

1146381 1 FT IL IN MI OH WI
04 04 04 04 04

400132700 CORDAGE CK19167 16/3 SOSJO

4133942 1 FT IL IN MI OH WI
04 04 04 04

COUPLER

300009594 COUPLER VOICE 1692-15 L2

N EA 1 5 1

COVER

400461257 COVER CK20458 L1

1311589 1 EA
Three connector with bracket and screws for call directors and consoles. BSP 461-200-103.

300055423 COVER EARP HOUSING PACKAGE OF 10

N PK 1 2 1

COVER KEY

280015058 COVER KEY 2018 BLACK

N EA 1 2 1

280015074 COVER KEY 2019 IVORY

N EA 1 2 1

DISTRIBUTION SERVICES

NETWORK SERVICES

TOOLS

BUILDING JANITORIAL

AUTOMOTIVE

FORMS/OFFICE SUPPLIES

GENERAL

DATA VOICE

DISTRIBUTION SERVICES

COVER KEY

PRODUCT IDENTIFIER		DESCRIPTION					
ITEM NUMBER	ORD. MULT.	SELL UNIT	STD. STOCK	PKG. AVAILABILITY / PA	LEAD TIME	MIN. ORD.	A C
280015082 COVER KEY 2027 ASH							
N		EA	1		2	1	

NETWORK SERVICES

PRODUCT IDENTIFIER		DESCRIPTION					
ITEM NUMBER	ORD. MULT.	SELL UNIT	STD. STOCK	PKG. AVAILABILITY / PA	LEAD TIME	MIN. ORD.	A C
300080082 COVER KEY KC-6 BEIGE							
1111450	1	EA	IL	IN	MI	OH	WI
			04	04	04	04	04
Used with the key TKM-6 TR Base.							

PRODUCT IDENTIFIER		DESCRIPTION					
ITEM NUMBER	ORD. MULT.	SELL UNIT	STD. STOCK	PKG. AVAILABILITY / PA	LEAD TIME	MIN. ORD.	A C
300080090 COVER KEY KC-6 BLACK							
1199398	1	EA	IL	IN	MI	OH	WI
			04	04	04	04	04
Used with the key TKM-6 TR Base.							

PRODUCT IDENTIFIER		DESCRIPTION					
ITEM NUMBER	ORD. MULT.	SELL UNIT	STD. STOCK	PKG. AVAILABILITY / PA	LEAD TIME	MIN. ORD.	A C
300080108 COVER KEY KC-6 IVORY							
1169359	1	EA	IL	IN	MI	OH	WI
			04	04	04	04	04
Used with the key TKM-6 TR Base.							

TOOLS

CUP

PRODUCT IDENTIFIER		DESCRIPTION					
ITEM NUMBER	ORD. MULT.	SELL UNIT	STD. STOCK	PKG. AVAILABILITY / PA	LEAD TIME	MIN. ORD.	A C
260433222 CUP 6IN UTILITY SAFETY WHIRLIGIG							
N		EA	1		5	1	

BUILDING JANITORIAL

DATA MOUNTING

SEE RACK, SECTION 8000.

DATA SET

SEE MODEM, SECTION 8000.

AUTOMOTIVE

DETECTOR LOOP

PRODUCT IDENTIFIER		DESCRIPTION					
ITEM NUMBER	ORD. MULT.	SELL UNIT	STD. STOCK	PKG. AVAILABILITY / PA	LEAD TIME	MIN. ORD.	A C
402064042 DETECTOR LOOP S64-1							
1195495	1	EA	A loop sensing device which is used to detect a telephone that is off-hook. Used where a telephone is not equipped with A and A1 wiring to provide an output ground.				

FORMS/OFFICE SUPPLIES

PRODUCT IDENTIFIER		DESCRIPTION					
ITEM NUMBER	ORD. MULT.	SELL UNIT	STD. STOCK	PKG. AVAILABILITY / PA	LEAD TIME	MIN. ORD.	A C
300083532 DETECTOR LOOP S64-5RA							
N		EA	1		2	1	

DIAL

PRODUCT IDENTIFIER		DESCRIPTION					
ITEM NUMBER	ORD. MULT.	SELL UNIT	STD. STOCK	PKG. AVAILABILITY / PA	LEAD TIME	MIN. ORD.	A C
102442571 DIAL 6GA3							
N		EA	1			1	

PRODUCT IDENTIFIER		DESCRIPTION					
ITEM NUMBER	ORD. MULT.	SELL UNIT	STD. STOCK	PKG. AVAILABILITY / PA	LEAD TIME	MIN. ORD.	A C
102315033 DIAL 8AA							
N		EA	1			1	

PRODUCT IDENTIFIER		DESCRIPTION					
ITEM NUMBER	ORD. MULT.	SELL UNIT	STD. STOCK	PKG. AVAILABILITY / PA	LEAD TIME	MIN. ORD.	A C
102329554 DIAL 8CA58							
N		EA	1			1	
Speakerphone dial for 600 & 800 type telephone sets. BSP 501-162-100.							

PRODUCT IDENTIFIER		DESCRIPTION					
ITEM NUMBER	ORD. MULT.	SELL UNIT	STD. STOCK	PKG. AVAILABILITY / PA	LEAD TIME	MIN. ORD.	A C
102329562 DIAL 8FA							
N		EA	1		2	1	

GENERAL

DATA VOICE

PRODUCT IDENTIFIER		DESCRIPTION					
ITEM NUMBER	ORD. MULT.	SELL UNIT	STD. STOCK	PKG. AVAILABILITY / PA	LEAD TIME	MIN. ORD.	A C
102244779 DIAL 9CA60							
5233304	1	EA	IL	IN	MI	OH	WI
			04	04	04	04	04
For use on all general purpose sets. BSP 501-162-101.							

PRODUCT IDENTIFIER		DESCRIPTION					
ITEM NUMBER	ORD. MULT.	SELL UNIT	STD. STOCK	PKG. AVAILABILITY / PA	LEAD TIME	MIN. ORD.	A C
102525557 DIAL 9CAM							
N		EA	1			1	

PRODUCT IDENTIFIER		DESCRIPTION					
ITEM NUMBER	ORD. MULT.	SELL UNIT	STD. STOCK	PKG. AVAILABILITY / PA	LEAD TIME	MIN. ORD.	A C
300013539 DIAL 11C							
1190314	1	EA	IL	IN	MI	OH	WI
			04	04	04	04	04
Dial for Set Hand 1013B, BSP 106-020-113.							

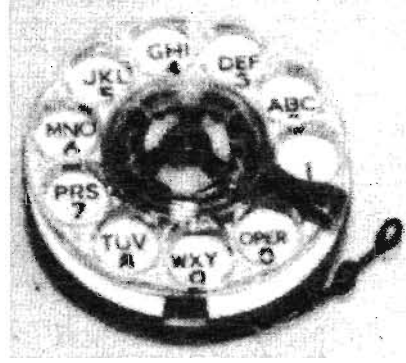

PRODUCT IDENTIFIER		DESCRIPTION					
ITEM NUMBER	ORD. MULT.	SELL UNIT	STD. STOCK	PKG. AVAILABILITY / PA	LEAD TIME	MIN. ORD.	A C
103257333 DIAL 35BC3A							
N		EA	1			1	

PRODUCT IDENTIFIER		DESCRIPTION					
ITEM NUMBER	ORD. MULT.	SELL UNIT	STD. STOCK	PKG. AVAILABILITY / PA	LEAD TIME	MIN. ORD.	A C
103747457 DIAL 72H3A							
1172221	1	EA	IL	IN	MI	OH	WI
			04	04	04	04	04
An electronically switched 12 button dial used with 2500 series telephone sets, BSP 501-164-115, BSP 501-165-117.							

PRODUCT IDENTIFIER		DESCRIPTION					
ITEM NUMBER	ORD. MULT.	SELL UNIT	STD. STOCK	PKG. AVAILABILITY / PA	LEAD TIME	MIN. ORD.	A C
102905973 DIAL 83A2B IN							
N		EA	1			1	

PRODUCT IDENTIFIER		DESCRIPTION					
ITEM NUMBER	ORD. MULT.	SELL UNIT	STD. STOCK	PKG. AVAILABILITY / PA	LEAD TIME	MIN. ORD.	A C
102999240 DIAL 1035AF3A 03 SP BLACK							
N		EA	1			1	
A 12 button touch-tone dial intended for use in conjunction with a regular subscribers tel set							

PRODUCT IDENTIFIER		DESCRIPTION					
ITEM NUMBER	ORD. MULT.	SELL UNIT	STD. STOCK	PKG. AVAILABILITY / PA	LEAD TIME	MIN. ORD.	A C
102999265 DIAL 1035AF3A 51 GREEN							
N		EA	1			1	
A 12 button touch-tone dial intended for use in conjunction with a regular subscribers tel set							

PRODUCT IDENTIFIER		DESCRIPTION					
ITEM NUMBER	ORD. MULT.	SELL UNIT	STD. STOCK	PKG. AVAILABILITY / PA	LEAD TIME	MIN. ORD.	A C
103873949 DIAL 2870A1 50 IVORY							
N		EA	1			1	
An adjunct touch-tone dialer to provide repertory dialog service for use with multi-button telephone sets.							

PRODUCT IDENTIFIER		DESCRIPTION					
ITEM NUMBER	ORD. MULT.	SELL UNIT	STD. STOCK	PKG. AVAILABILITY / PA	LEAD TIME	MIN. ORD.	A C
250036704 DIAL 2870A1 50 ATTIS							
N							

PRODUCT IDENTIFIER		DESCRIPTION					
ITEM NUMBER	ORD. MULT.	SELL UNIT	STD. STOCK	PKG. AVAILABILITY / PA	LEAD TIME	MIN. ORD.	A C
260406632 DIAL INTERCOM KC-19							
N		EA	1		2	1	

PRODUCT IDENTIFIER		DESCRIPTION					
ITEM NUMBER	ORD. MULT.	SELL UNIT	STD. STOCK	PKG. AVAILABILITY / PA	LEAD TIME	MIN. ORD.	A C
280000704 DIAL ROTARY 003-00-00G							
N		EA	1		4	1	

PRODUCT IDENTIFIER		DESCRIPTION					
ITEM NUMBER	ORD. MULT.	SELL UNIT	STD. PKG. STOCK AVAILABILITY / PA	LEAD TIME	MIN. ORD.	A	C
280000985		DIAL	ROTARY 003-09-00G				
N		EA	1	4	1		
280000993		DIAL	ROTARY 003-13-00G				
N		EA	1	4	1		
DISK							
280036963		DISK	0436-47 LARGE				
N		PK	1	3	1		
280036930		DISK	1436-46 SMALL				
N		PK	1	3	1		
280036948		DISK	LARGE WITH FOAM COVER				
N		PK	1	4	1		Package of 10.
300044179		DISK	SAFETY TELCO II				
N		EA	1	2	1		
280036922		DISK	SMALL WITH FOAM COVER				
N		PK	1	4	1		Package of 10.
DISPLAY							
260390844		DISPLAY	14IN COLOR 64501011035				
1970558	1	EA					
300007143		DISPLAY	4503 10AO				
N		EA	1	5	1		
500047519		DISPLAY	4503-10AO				
N		EA	1	5	1		
500054333		DISPLAY	56D202YAC				
1946764	1	EA	IL IN MI OH WI 02 04 01 03				Display for 5620 terminal.
500054549		DISPLAY	56D202YAF				
1935775	1	EA	IL IN MI OH WI 01 01 01 01				
500041678		DISPLAY	56D502AAA				
N		EA	1	4	1		
300060738		DISPLAY	BUFFERED 5420 TTY				
1151118	1	EA	IL IN MI OH WI 01 01 01 01				
300060746		DISPLAY	BUFFERED 5420 2TTY				
1107813	1	EA	IL IN MI OH WI 01 01 01 01				
260302948		DISPLAY	FLUSH MOUNT NJ00514A-1 L4				
1940015	1	EA	IL IN MI OH WI 04				Used with the enhanced E911 Emergency Reporting System.

PRODUCT IDENTIFIER		DESCRIPTION					
ITEM NUMBER	ORD. MULT.	SELL UNIT	STD. PKG. STOCK AVAILABILITY / PA	LEAD TIME	MIN. ORD.	A	C
260404447		DISPLAY	IBM PS/2 MODEL 8514				
N		EA	1	1	1		Color VGA display, P/N8514001.
500044235		DISPLAY	LOGIC 40DL291/BR				
N		EA	1	4	1		
260395603		DISPLAY	NEC 3FGX COLOR VGA MONITOR				
N		EA	1	1	1		P/N JC-1532VMA. Replaces the NEC 3D & 3DS Monitor.
280079252		DISPLAY	STATION 3192 D10				
1935676	1	EA	IL IN MI OH WI 01 01				REPLACED BY 260381058.
260381058		DISPLAY	STATION 3472 FG1				
1960997	1	EA	IL IN MI OH WI 01 01				W/9122 keyboard, 122 keys.
260426325		DISPLAY	VIDEO TERMINAL 1000 W/KEYBOARD				
N		EA	1	4	1		1003301-35.
260426325		DISPLAY	VIDEO TERMINAL 1000 W/KEYBOARD				
N		EA	1	4	1		1003301-35.
260359617		DISPLAY	VIDEO VT320-CA				
N		EA	1	5	1		
260359591		DISPLAY	VIDEO VT320-FA				
N		EA	1	5	1		
260359609		DISPLAY	VIDEO VT340-DA				
1953521	1	EA	IL IN MI OH WI 02				
260402045		DISPLAY	VIDEO VT420-CA				
1968107	1	EA	IL IN MI OH WI 03 03 03				Stadard keyboard and 1 year on-site warranty.
260402052		DISPLAY	VIDEO VT420-FA				
1968115	1	EA	IL IN MI OH WI 01 01 01				W. P. keyboard and 1 year on-site warranty.
260420419		DISPLAY	(AMBER) WITH KEYBOARD				
N		EA	1	4	1		P/N3383-71F-FC0352/FC3026.
260420427		DISPLAY	(GREEN) WITH KEYBOARD				
N		EA	1	3	1		P/N3383-71F-FC0352/FC3026.

DISTRIBUTION SERVICES
 NETWORK SERVICES
 TOOLS
 BUILDING JANITORIAL
 AUTOMOTIVE
 FORMS/OFFICE SUPPLIES
 GENERAL
 DATA VOICE

DISTRIBUTION SERVICES	DRIVE							PRODUCT IDENTIFIER DESCRIPTION						
	ITEM	ORD.	SELL	STD. PKG.	LEAD TIME	MIN.	A	ITEM	ORD.	SELL	STD. PKG.	LEAD TIME	MIN.	A
	NUMBER	MULT.	UNIT	STOCK AVAILABILITY / PA		ORD.	C	NUMBER	MULT.	UNIT	STOCK AVAILABILITY / PA		ORD.	C
NETWORK SERVICES	DISPLAY COLOR							EXPANDER						
	SEE MONITOR.							843051210 EXPANDER 843051210						
	DRIVE							843051228 EXPANDER 843051228						
	260422043							N		EA			9	1
260422043 DRIVE 5.25IN W/NCR ADAPTER SYSTEM														
	N		EA	1	1	1		N		EA	1	9	1	
5.25IN external disk drive w/adapter for NCR MCA PC. Adapter installed when ordered with PC.														
TOOLS	260404264 DRIVE DISK COMPAQ LTE							102949476 EXTENDER 18A BOARD						
		N		EA	1	1	1	N		EA	16	6	16	
	Compaq external 5.25in disk drive for Deskpro 386S/386-20E and laptops, P/N113637-001.							280014879 EXTENDER CARD 12212196						
		N		EA	1	1	1	N		EA	1	2	1	
260395587 DRIVE DISK IBM PS/2 1.2MB 360K							280014887 EXTENDER CARD 82318700							
	N		EA	1	1	1	N		EA	1	2	1		
IBM floppy disk drive, PN4869002.							280014895 EXTENDER CARD 82318800							
280095993 DRIVE EXTERNAL PS/2 5.25 IBM							401683701 EXTENDER LAMP 21075							
	N		EA	1	1	1	N		EA	1	2	1		
Floppy disk drive.							N							
260420559 DRIVE HARD P/N 64501006647							N							
	N		EA	1	4	1	Dracon type lamp extended for 4 circuits and up to 96 lamps.							
000238873 DRIVE RIBBON 70-11446-00 ST108							FACE PLATE							
	N		EA	1	4	1	SEE PLATE FACE.							
DRUM							FAN							
260345640 DRUM DATA PRODUCTS LZR1230 25K LONG-LIFE							000238931 FAN 35 CFM 12-12581-00							
	N		EA	1	2	1	N		EA	1	4	1		
300023033 DRUM FIBERGLASS 30GAL							FILM							
5104752	1	EA	IL	IN	MI	OH	WI	260338157 FILM SHRINK 10475150 75GA/CF						
			04					N		RO	1	2	1	
Lock strip cover.							D955 Cryovac. FOR ADC USAGE ONLY.							
260345863 DRUM MANNESMANN TALLY/MT910 160K							300040839 FILM STRETCH 90G 20IN X 5000FT ROLL							
	N		EA	1	2	1	N		RO	1	3	64		
ELIMINATOR							280036294 FILM STRETCH WRAP HAND 12IN WIDE							
260427422 ELIMINATOR COAX F/N1889							N							
	N		EA	1	1	1	QL1-2205, 4 rolls per case.							
Lee Data.							FILTER							
260427414 ELIMINATOR COAX F/N1988							260436829 FILTER FINE IBM 3835 6190660							
	N		EA	1	1	1	N		EA	1	2	1		
Lee Data.							260421383 FILTER REPLACEMENT SP200 P/N1702-4597							
ENCLOSURE							N							
260411947 ENCLOSURE DATA CABINET GL300 BL							N							
	N		EA	1	3	1	For gas monitor CMX271.							

PRODUCT IDENTIFIER		DESCRIPTION					
ITEM NUMBER	ORD. MULT.	SELL UNIT	STD. PKG. STOCK AVAILABILITY / PA	LEAD TIME	MIN. ORD.	A C	
103846770 FILTER Z100B							
1956359	1	EA	IL IN MI OH WI 18 18 18 18				
FIRMWARE							
260319595 FIRMWARE BSC COMMUNICATIONS ASCII							
N		EA	1	4	1		
Lee Data ASCII language chip.							
260319603 FIRMWARE EBCDIC 13300216							
N		EA	1	4	1		
Lee Data EBCDIC language chip.							
FUSE							
002080075 FUSE 2.5A 90-07879-00 SLO BLO 250V							
N		EA	1	2	10		
002080059 FUSE 3.0A 90-07218-00 SLO BLO							
N		EA	1	2	10		
002079978 FUSE 5.0A 12-09070 SUB MINI 125V							
N		EA	10	4	10		
002080067 FUSE 5.0A 90-07222-00 SLO BLO 250V							
N		EA	1	2	10		
002080083 FUSE 6.0A 90-09320-00 SLO BLO 32V							
N		EA	1	2	10		
FUSER							
260354519 FUSER 3812/1348331 PAGEPRINTER							
N		EA	1	3	1		
260345632 FUSER LZR1230 DATAPRODUCTS							
N		EA	1	2	1		
260417720 FUSER UNIT MT910 329K							
N		EA	1	2	1		
PN403966-03.							
GEAR							
500006671 GEAR 28 B1							
N		EA	1	8	1		
Set of gears.							
521612952 GEAR 28 C1 161295							
N		EA	1	8	4		
Set of gears.							
GEAR IDLER							
002080034 GEAR IDLER 70-09694-00							
N		EA	1	24	1		

PRODUCT IDENTIFIER		DESCRIPTION					
ITEM NUMBER	ORD. MULT.	SELL UNIT	STD. PKG. STOCK AVAILABILITY / PA	LEAD TIME	MIN. ORD.	A C	
GENERATOR							
260427059 GENERATOR MULTI-TONE							
N		EA	1	1	1		
P/N22017-001							
GUIDE USER							
260420468 GUIDE USER 3.4 P/N 64406124123							
N		EA	1	4	1		
260390760 GUIDE USER CC501003909							
N		EA	1	3	1		
6500 Display 45401N.							
260390828 GUIDE USER CC501008841							
N		EA	1	4	1		
6538/6539 display.							
HANDBOOK							
260325550 HANDBOOK FTR TIE 01841HB001							
N		EA	1	4	1		
HOUSING							
102987872 HOUSING 8A							
N		EA	1	3	1		
102276987 HOUSING 832A 3							
1301341	1	EA	IL IN MI OH WI 04 04 04 04 04				
Housing for the 830, 2830, 831, 2831, 832 and 2832 tel set base, BSP 518-450-100. DISCONTINUE UPON STOCK DEPLETION							
102276979 HOUSING 832A 50							
1137638	1	EA	IL IN MI OH WI 04 04 04 04				
DISCONTINUE UPON STOCK DEPLETION							
102283652 HOUSING 851A 3							
1311662	1	EA	IL IN MI OH WI 04 04 04 04 04				
Housing for the 851A1M and/or 2851 A1M Telephone Set, BSP 503-601-101.							
102283660 HOUSING 851A 50							
1178590	1	EA	IL IN MI OH WI 04 04 04 04				
DISCONTINUED - REPLACED BY HOUSING 851A 3							
102539152 HOUSING 852A 3							
N		EA	1		1		
280028762 HOUSING 860061-000 BLACK							
N		EA	4	4	1		
280028770 HOUSING 860061-009 IVORY							
N		EA	4	4	1		

DISTRIBUTION SERVICES

NETWORK SERVICES

TOOLS

BUILDING JANITORIAL

AUTOMOTIVE

FORMS/OFFICE SUPPLIES

GENERAL

DATA VOICE

PRODUCT IDENTIFIER		DESCRIPTION					
ITEM NUMBER	ORD. MULT.	SELL UNIT	STD. STOCK	PKG. AVAILABILITY / PA	LEAD TIME	MIN. ORD.	A C
401246699 JACK WEATHERPROOF MALE B							
2609842	1	EA	IL 04	IN 04	MI 04	OH 04	WI
CA08731 L1. Flush mounted, chrome plated male jack with hinged screw cover. For use with Cord Weatherproof B (1198457) for boats and recreational vehicles. Nonregulated USOC JHB, BSP 461-220-1							
401246715 JACK WEATHERPROOF MALE B							
2609867	1	EA	IL 04	IN 04	MI 04	OH 04	WI
CA08733. Male jack mounts in Box Outlet B (2609800). Used with Cord Weatherproof B (1198457) for installation on a boat or recreational vehicle. Non-regulated USOC JK3, BSP 461-220-101. Arrowhart.							

KEY							
102741923 KEY 549 A1 60							
1136341	1	EA					
100287085 KEY 551 A 50 IVORY							
1302943	1	EA	IL 04	IN 04	MI 04	OH 04	WI 04
A single position nonlocking push button used to operate signals. BSP 512-220-100.							
100287143 KEY 551 A 60 BEIGE							
2769463	1	EA	IL 04	IN 04	MI 04	OH 04	WI 04
BSP 512-220-100.							
101546364 KEY 635 A5							
N		EA					1
Six illuminated buttons capped with clear plastic. A Lamp 53A provided within each plunger. BSP 512-230-100.							
101915577 KEY 635 AF5C							
1120311	1	EA	IL 04	IN 04	MI 04	OH 04	WI 04
DISCONTINUED - ORDER NON STOCK							
101915585 KEY 635 AG5C							
1216564	1	EA	IL 05	IN 04	MI 04	OH 04	WI 04
DISCONTINUED, ORDER NON STOCK UPON STOCK DEPLETION							
102486107 KEY 635 BP5C							
N		EA				13	25
101879708 KEY 635 G5C							
1204743	1	EA	IL 04	IN 04	MI 04	OH 04	WI 04
Consists of six illuminated locking buttons topped with square caps for six pickups. Use on Set Tel 630, BSP 502-603-100.							
100290857 KEY 640 G 60							
1161182	1	EA	IL 04	IN 04	MI	OH	WI
DISCONTINUED - ORDER NON STOCK							

PRODUCT IDENTIFIER		DESCRIPTION					
ITEM NUMBER	ORD. MULT.	SELL UNIT	STD. STOCK	PKG. AVAILABILITY / PA	LEAD TIME	MIN. ORD.	A C
101538791 KEY 647 A5C							
1104059	1	EA	IL 04	IN 04	MI 04	OH 04	WI 04
Nine line pick-up button with line hold button, Red, E/W Chaining switch used for 10 and 20 button sets, BSP 512-230-101.							
280024753 KEY 2018 BLACK COVER							
N		EA				1	1
100289503 KEY 6017 J							
N		EA				2	1
840164545 KEY 840164545							
1165712	1	EA	IL 05	IN 04	MI 04	OH	WI
DISCONTINUE, ORDER NON STOCK UPON STOCK DEPLETION							
260323977 KEY ASSEMBLY 000637-00E							
N		EA				4	48
401789276 KEY CK21776 L2							
N		EA				8	25
A miniature transfer key. Can be mounted on telephone sets with Bracket 77A (1116525). Also see Cover CK21776 L101-3 - L101-61. BSP 512-210-101.							
401789292 KEY CK21776 L4							
N		EA				8	25
A miniature transfer key. Can be mounted on telephone sets with Bracket 77A (1116525). Also see Cover CK21776 L101-3 - L101-61. BSP 512-210-101.							
401789318 KEY CK21776 L6							
N		EA				8	25
A miniature transfer key. Can be mounted on telephone sets with Bracket 77A (1116525). Also see Cover CK21776 L101-3 - L101-61. BSP 512-210-101.							
401789326 KEY CK21776 L7							
N		EA				8	5
A miniature transfer key. Can be mounted on telephone sets with Bracket 77A (1116525). Also see Cover CK21776 L101-3 - L101-61. BSP 512-210-101.							
401789334 KEY CK21776 L8							
N		EA				8	25
A miniature transfer key. Can be mounted on telephone sets with Bracket 77A (1116525). Also see Cover CK21776 L101-3 - L101-61. BSP 512-210-101.							
401789342 KEY CK21776 L9							
N		EA				8	25
A miniature transfer key. Can be mounted on telephone sets with Bracket 77A (1116525). Also see Cover CK21776 L101-3 - L101-61. BSP 512-210-101.							
280014994 KEY SPECIAL B847771							
N		EA				2	1
An allen wrench used to lock SLC 96-36 & 80 type cabinets.							

DISTRIBUTION SERVICES

NETWORK SERVICES

TOOLS

BUILDING JANITORIAL

AUTOMOTIVE

FORMS/OFFICE SUPPLIES

GENERAL

DATA VOICE

KEY

DISTRIBUTION SERVICES

PRODUCT IDENTIFIER		DESCRIPTION					
ITEM NUMBER	ORD. MULT.	SELL UNIT	STD. PKG. STOCK AVAILABILITY / PA	LEAD TIME	MIN. ORD.	A C	

280024761 KEY TKM 6 2001 TRANSFER
N EA 1 2 1

280015090 KEY TKM 6 2001 TRANSFER
N EA 1 2 3

NETWORK SERVICES

000238006 KEY TKM 6B
5211847 1 EA IL IN MI OH WI
04 04 04 04 04

401789979 KEY TKM 6G
1193912 1 EA IL IN MI OH WI
04 04 04 04 04

TOOLS

001237361 KEY TKM 6MBB BASE
N EA 1 2 5

401789987 KEY TKM 6TR BASE
1148551 1 EA IL IN MI OH WI
04 04 04 04 04
A miniature transfer key. Can be mounted on the telephone sets. Mounting bracket available upon special request.

BUILDING JANITORIAL

401790001 KEY TKM 9TR BASE
N EA 1 1 5

401790027 KEY TKM 12 BASE
1226753 1 EA IL IN MI OH WI
04 04 04 04 04

AUTOMOTIVE

KEY TELEPHONE UNIT
SEE UNIT TELEPHONE KEY.

KEYBOARD

500046818 KEYBOARD 40K003AAB
N EA 1 4 1

500048582 KEYBOARD 40K003AAC
N EA 1 5 1

500049283 KEYBOARD 40K201GAD
N EA 1 5 1

500046057 KEYBOARD 40KDA101
N EA 1 5 1
Display amp.

500047550 KEYBOARD 45K301GAA/02
N EA 1 5 1

500050729 KEYBOARD 45K301GAA/02
N EA 1 2 1
CC500050729.

GENERAL

500047543 KEYBOARD 45K301GAA/03
1134056 1 EA IL IN MI OH WI
03 03 03 03 03
Keyboard without mag strip reader. Used for Dataspeed 4540 service.

DATA VOICE

PRODUCT IDENTIFIER		DESCRIPTION					
ITEM NUMBER	ORD. MULT.	SELL UNIT	STD. PKG. STOCK AVAILABILITY / PA	LEAD TIME	MIN. ORD.	A C	

500053814 KEYBOARD 56K228AAM
1924829 1 EA IL IN MI OH WI
03 03 03 03 03
Keyboard to go with Printer 53P101BAC.

500066493 KEYBOARD 56K310ACV
N EA 1 5 1

500066758 KEYBOARD 56K330ACQ
1936526 1 EA IL IN MI OH WI
04 04

260339494 KEYBOARD 56K340AAV
1949016 1 EA IL IN MI OH WI
03 03 03 03

500053681 KEYBOARD 56K342ABR
1946772 1 EA IL IN MI OH WI
04 04 04 04
Keyboard for 5620 terminal.

500054515 KEYBOARD 56K370ACK
1935791 1 EA IL IN MI OH WI
04 04 04

000238824 KEYBOARD 70-17630-03 ST103-00
N EA 1 4 1

260396361 KEYBOARD 87 KEY L/P 82500502
1967588 1 EA IL IN MI OH WI
03 03

260390877 KEYBOARD 122 KEY
1970566 1 EA IL IN MI OH WI
04 04 04
CC501007462.

280043019 KEYBOARD 122 KEY F/N2293
1924761 1 EA IL IN MI OH WI
03 03 03 03

260432851 KEYBOARD 102-KY 710/711-MT CC406601120
N EA 1 2 1

260420435 KEYBOARD 122 KEY (6471F)
N EA 1 4 1
P/N64106073026.

001214030 KEYBOARD DEC ST-103-00
N EA 1 2 1

260395637 KEYBOARD ENHANCED COMPAQ SLT
N EA 1 1 1
External keyboard for use with SLT/286 & 386 desktop expansion unit, P/N110562-001.

260438551 KEYBOARD NCR VT220 #34153-K450-0000
N EA 1 4 1

260304092 KEYBOARD VT220
1940668 1 EA IL IN MI OH WI
04 04 04 04
Can be used with Liberty Turbo One Terminal (260304100).

PRODUCT IDENTIFIER DESCRIPTION

ITEM NUMBER	ORD. MULT.	SELL UNIT	STD. PKG. STOCK AVAILABILITY / PA	LEAD TIME	MIN. ORD.	A C
-------------	------------	-----------	-----------------------------------	-----------	-----------	-----

260318266 KEYBOARD WYSE WORD PROCESSING
 N EA 1 3 1

KIT

002078772 KIT ADAPTER TAK-2P
 N EA 1 2 1

260325311 KIT AUXILARY LINK TIE 88166
 N EA 1 4 1

280031964 KIT CLEANING READER 31-0014
 N EA 1 2 1

260440490 KIT DECAL 5025 3IN
 N KT 1 3 10

260404454 KIT IBM PS/2 80MB INTERNAL TAPE
 N EA 1 1 1
 Backup, P/N 30F5280.

260404421 KIT IBM PS/2 8514 MEMORY EXPANSION
 N EA 1 1 1
 For 8514 display, P/N1887989.

300062411 KIT INSTALLATION CK22811 L5
 1196576 1 EA IL IN MI OH WI
 04 04 04 04

000238899 KIT POWER SUPPLY 54-1304400 ST106
 N EA 1 4 1
 4A-LA120-PS.

000260067 KIT TRUNK ADAPTER FCC
 N EA 1 2 1

260344304 KIT USER MAINTENANCE LN03
 1965244 1 PK IL IN MI OH WI
 33 33 33 33
 SUP-RK-80PLUS. Package of 6.

260325360 KIT WALL MOUNTING TIE
 N EA 1 4 1
 88179.

KIT FIRST AID

260370036 KIT FIRST AID CLEAR VIEW EMPTY 05-41-10
 1955930 1 EA
 NOTE: First-Aid Kits are furnished without contents. Use the following (*CONTENT) information when stocking or restocking the kits.

300075447 *BANDAGE 1IN ADHESIVE
 1333138 1 PK IL IN MI OH WI
 33 33 33 33 33
 Package of 16.

300075421 *BANDAGE 2IN OFFSET
 1333187 1 PK IL IN MI OH WI
 33 33 33 33 33
 Package of 4 compresses.

PRODUCT IDENTIFIER DESCRIPTION

ITEM NUMBER	ORD. MULT.	SELL UNIT	STD. PKG. STOCK AVAILABILITY / PA	LEAD TIME	MIN. ORD.	A C
-------------	------------	-----------	-----------------------------------	-----------	-----------	-----

300028024 *BANDAGE 4IN OFFSET
 1333195 1 PK IL IN MI OH WI
 33 33 33 33 33
 Package of one compress.

260370044 *BANDAGE FINGERTIP/KNUCKLE 5/4
 1955922 1 PK IL IN MI OH WI
 33 33 33 33 33
 Package includes five fingertip and four knuckle bandages.

260339843 *BREATHER RESCUE
 1949396 1 PK IL IN MI OH WI
 34 34 34 34 34
 Package of one.

300027216 *COLD-PAK NORTON
 1333179 1 PK IL IN MI OH WI
 33 33 33 33 33
 Package of one.

260339841 *GLOVES DISPOSABLE/MEDICAL WASTE BAG
 1949404 1 BG IL IN MI OH WI
 34 34 34 34
 Bag of 2. Includes Medical Waste Bag for disposal 02/09/90.

280027368 *PAD WOUND CLEANSING
 1922211 1 PK IL IN MI OH WI
 33 33 33 33 33
 Package of 10.

300027356 *SWAB IODINE PVP 02-12-01
 1333211 1 PK IL IN MI OH WI
 34 34 34 34 34
 Package of 10.

002090520 *SWAB STING KILL
 1333229 1 PK IL IN MI OH WI
 34 34 34 34 34
 Package of 10. Used to relieve bee sting discomfort.

KTU

SEE UNIT TELEPHONE KEY.

LEE DATA

SEE APERTUS/LEE DATA IN SECTION 8.

LINE CONTROLLER

260319637 LINE CONTROLLER ASYNC PCB
 N EA 1 4 1
 Lee Data, REV E, ASYNC Controller, one per eight ASYNC PCB.

LOGIC DISPLAY

260401856 LOGIC DISPLAY 6520 501008601
 N EA 1 4 1

DISTRIBUTION SERVICES

NETWORK SERVICES

TOOLS

BUILDING JANITORIAL

AUTOMOTIVE

FORMS/OFFICE SUPPLIES

GENERAL

DATA VOICE

DISTRIBUTION SERVICES	MEMORY							MEMORY							
	PRODUCT IDENTIFIER		DESCRIPTION					PRODUCT IDENTIFIER		DESCRIPTION					
	ITEM NUMBER	ORD. MULT.	SELL UNIT	STD. PKG. STOCK AVAILABILITY / PA	LEAD TIME	MIN. ORD.	A C	ITEM NUMBER	ORD. MULT.	SELL UNIT	STD. PKG. STOCK AVAILABILITY / PA	LEAD TIME	MIN. ORD.	A C	
	LOOP DETECTOR								260404314 MEMORY COMPAQ 4MB SLT 386S/20						
	SEE DETECTOR LOOP.								N EA 1 1 1 Module for laptop PC's, P/N118305-001.						
	MEMORY								260404553 MEMORY CUMULUS 1MB 121209						
	260359088 MEMORY 1MB LASERJET								N EA 1 1 1 Exact replacement for COMPAQ P/N110235-001.						
	N EA 1 2 1 Hewlett-Packard, upgrade board.								260404561 MEMORY CUMULUS 1MB 121214						
	260404694 MEMORY 1MB LASERJET 33474B								N EA 1 1 1 Exact replacement for COMPAQ P/N117081-001.						
	N EA 1 2 1 Hewlett Packard, for use in IIP/III/IIID Laserjet printers.								260393053 MEMORY CUMULUS 2MB 121114						
	260359096 MEMORY 4MB LASERJET II & IID								N EA 1 1 1 Exact replacement for IBM P/N6450604.						
	1970293 1 EA IL IN MI OH WI 04 Hewlett-Packard, for use in II/IIID upgrade boards. HP 33445B.								260404520 MEMORY CUMULUS 2MB 121115						
	260319652 MEMORY 512K PCB								N EA 1 4 1 Exact replacement for IBM P/N6450608.						
	N EA 1 4 1 Lee Data 512K memory board, expansion unit only. SAME AS PID 260371182								260404538 MEMORY CUMULUS 2MB 121118						
	260438577 MEMORY 1MB COLOR GRAPHICS X-TERMINAL								N EA 1 1 1 Exact replacement for IBM P/N6450379.						
	N EA 1 4 1								260404579 MEMORY CUMULUS 2MB 121215						
	260438536 MEMORY 1MB LOGIC X-TERMINAL								N EA 1 1 1 Exact replacement for COMPAQ P/N117081-002.						
	N EA 1 4 1 NCR #3414-F005-0000.								260404546 MEMORY CUMULUS 4MB 121211						
	260420575 MEMORY 2MB 90R P/N953453-004-72								N EA 1 1 1 Exact replacement for IBM P/N87F9977.						
	N EA 1 3 1								260404462 MEMORY IBM 34F3077						
	260438585 MEMORY 4MB COLOR GRAPHICS X-TERMINAL								N EA 1 1 1 PS/2 80386 2-14MB memory expansion option.						
	N EA 1 4 1 NCR #3414-F016-0000.								260354196 MEMORY IBM 6450603						
	260438544 MEMORY 4MB LOGIC X-TERMINAL								N EA 1 1 1 PS/2 1MB memory module used to expand P/N6450605.						
	N EA 1 4 1 NCR #3414-F006-0000.								260354204 MEMORY IBM 6450604						
	260404322 MEMORY COMPAQ 1MB LTE 386S								N EA 1 1 1 PS/2 2MB memory module used to expand P/N6450605.						
	N EA 1 1 1 Module for laptop computer, P/N121125-001.								260404470 MEMORY IBM 6450608						
	260404298 MEMORY COMPAQ 1MB SLT 386S/20								N EA 1 1 1 PS/2 2MB system board.						
	N EA 1 1 1 Module for laptop PC's, P/N118303-001.								260366778 MEMORY IBM 6450609						
	260404306 MEMORY COMPAQ 2MB SLT 386S/20								N EA 1 1 1 PS/2 PC model 50, 555X and 60.						
	N EA 1 1 1 Module for laptop PC's, P/N118304-001.								260404488 MEMORY IBM 6451060						
	260404330 MEMORY COMPAQ 4MB LTE 386S								N EA 1 1 1 PS/2 4MB system memory expansion.						
	N EA 1 1 1 Module for laptop computer, P/N121125-002.								260404496 MEMORY IBM 87F9977						
	260404280 MEMORY COMPAQ 4MB SLT 286								N EA 1 1 1 PS/2 4MB memory module kit.						
	N EA 1 1 1 P/N110237-001.								260404587 MEMORY INTEL ABOVEBOARD MC32 W/4MB						
									N EA 1 1 1 For use in IBM PS/2 Model 70 and 80.						

DISTRIBUTION SERVICES

NETWORK SERVICES

TOOLS

BUILDING JANITORIAL

AUTOMOTIVE

FORMS/OFFICE SUPPLIES

GENERAL

DATA VOICE

PRODUCT IDENTIFIER		DESCRIPTION				
ITEM NUMBER	ORD. MULT.	SELL UNIT	STD. PKG. STOCK AVAILABILITY / PA	LEAD TIME	MIN. ORD.	A C
260404603 MEMORY INTEL ABOVEBOARD PLUS/2 W/2MB						
N		EA	1	1	1	
For use in IBM PS/2 Model 50 and 60.						
260404595 MEMORY INTEL ABOVEBOARD PLUS/8 W/2MB						
N		EA	1	1	1	
For use in IBM PC/XT/AT and PS/2 Model 30 and 30-286 PC's.						
260436225 MEMORY NCR 2MB 386SX/MC-20						
N		EA	1	2	1	
NCR Brand 2MB RAM upgrade for NCR 386SX/MC-20 PC's.						

MICRO CHIP

260330923 MICRO CHIP LD 13300001 E PROM						
1947127	1	EA				
Micro chip used in Lee Data-Module Logic Color ASYNC Feature 2049.						
260330931 MICRO CHIP LD 13846710 SPECIAL						
1947135	1	EA	IL IN MI OH WI			
Micro chip used on Controller Printer Unit feature 1303A.						

MODULE

260402714 MODULE 4MB TLM F/N5720						
1976449	1	EA				
Token Ring Lan Module.						
260402607 MODULE 4-PORT PDM F/N5215						
1976233	1	EA	IL IN MI OH WI			
Plug Compatible Device Module.						
260402722 MODULE 16/4MB TLM F/N5725						
1976472	1	EA	IL IN MI OH WI			
Token Ring Lan Module.						
260402698 MODULE 16-PORT ACM F/N5630						
1976381	1	EA	IL IN MI OH WI			
Asynchronous Communication Module.						
260402565 MODULE 16-PORT LDM F/N5100						
1976142	1	EA	IL IN MI OH WI			
128 LU coaxial (LDM).						

PRODUCT IDENTIFIER		DESCRIPTION				
ITEM NUMBER	ORD. MULT.	SELL UNIT	STD. PKG. STOCK AVAILABILITY / PA	LEAD TIME	MIN. ORD.	A C
260402581 MODULE 16-PORT LDM F/N5115						
1976738	1	EA	IL IN MI OH WI			
Upgrade LDM.						
260402615 MODULE 16-PORT PDM F/N5230						
1976761	1	EA	IL IN MI OH WI			
128 LU, Plug Compatible Device Module.						
260402631 MODULE 16-PORT TDM F/N5300						
1976266	1	EA	IL IN MI OH WI			
AT&T Device Module.						
260402656 MODULE 3270 R5232 RCM F/N5500						
1976290	1	EA	IL IN MI OH WI			
Remote Communication Module.						
260402664 MODULE 3270 V.35 RCM F/N5510						
1976324	1	EA	IL IN MI OH WI			
Remote Communication Module.						
260402573 MODULE 32-PORT LDM F/N5110						
1976175	1	EA	IL IN MI OH WI			
128 LU coaxial (LDM).						
260402599 MODULE 32-PORT LDM F/N5120						
1976209	1	EA	IL IN MI OH WI			
128 LU, twisted pair (LDM).						
260403035 MODULE 32-PORT PDM F/N5235						
1976795	1	EA	IL IN MI OH WI			
Plug Compatible Device Module.						
260402623 MODULE 32-PORT PDM F/N5240						
1976829	1	EA	IL IN MI OH WI			
Twisted pair, Plug Compatible Device Module.						
260325352 MODULE 88171 20 BTN TIE						
N		EA	1	4	1	
260325410 MODULE 88172 PAPER TRAY TIE						
N		EA	1	4	1	
260325337 MODULE 88176 20 BTN/DSPL TIE						
N		EA	1	4	1	
260402672 MODULE ACM ASYNC F/N5610						
1976357	1	EA	IL IN MI OH WI			
Asynchronous Communication Module.						
300062403 MODULE COMM VOICE CK22811 L1						
1197491	1	EA	IL IN MI OH WI			
260402706 MODULE ETHERNET LAN F/N5710						
1976415	1	EA	IL IN MI OH WI			
ELM.						

DISTRIBUTION SERVICES

MODULE

PRODUCT IDENTIFIER DESCRIPTION

ITEM ORD. SELL STD. PKG. LEAD TIME MIN. A
NUMBER MULT. UNIT STOCK AVAILABILITY / PA ORD. C

260369608 MODULE EXPANSION DESKTOP COMPAQ SLT
N
Expansion base, alias Docking Module. P/N 110059-001.

NETWORK SERVICES

260404272 MODULE EXT COMPAQ LTE & SLT
N EA 1 1 1
Compaq external storage module for LTE, LTE/286 & SLT/286, P/N117079-001.

260402649 MODULE LCM F/N5400
1976886 1 EA IL IN MI OH WI
03 03 03 03
Local Communication Module.

TOOLS

002087013 MODULE LN GROUND 41403
1139261 1 EA IL IN MI OH WI
58 58 58 58
To be used as an extended Network Interface for extensions on Coin Service.

BUILDING JANITORIAL

260319660 MODULE LOGIC COLOR ASYNC F/N 2049
1941492 1 EA IL IN MI OH WI
01 01 01 01
Lee data all-in-one logic module, base or pizza board for 2131 windowing CRT.

280044975 MODULE LOGIC WINDOW F/N2035
1925529 1 EA IL IN MI OH WI
01 01
89002043.

AUTOMOTIVE

280044967 MODULE LOGIC WINDOW F/N2036
1925545 1 EA IL IN MI OH WI
01 01 01 01
89002044.

260411830 MODULE LSM F/N 5091
1976506 1 EA IL IN MI OH WI
03 03 03 03
For Datastar 5000.

FORMS/OFFICE SUPPLIES

002038735 MODULE STATION RMB 01 W4
N EA 1 4 1

002038651 MODULE STATION RMB 03
N EA 1 2 1

002038768 MODULE STATION RMB 50
N EA 1 5 1

GENERAL

MONITOR

260000096 MONITOR 40MN101/AA
1996561 1 EA

500051677 MONITOR 40MN103/AA
1222794 1 EA IL IN MI OH WI
04 04 04 04 04

500064746 MONITOR 40MN104/AA
1930651 1 EA IL IN MI OH WI
04 04 04 04 04

DATA VOICE

PRODUCT IDENTIFIER DESCRIPTION

ITEM ORD. SELL STD. PKG. LEAD TIME MIN. A
NUMBER MULT. UNIT STOCK AVAILABILITY / PA ORD. C

260318274 MONITOR 53D 710/AAA
1941245 1 EA IL IN MI OH WI
04
DISCONTINUE UPON STOCK DEPLETION.

260403589 MONITOR 14IN VGA F/N2156
1968883 1 EA IL IN MI OH WI
02 02 02 02
Lee Data.

260420443 MONITOR 15IN AMBER P/N64106202575
N EA 1 4 1

260420450 MONITOR 15IN GREEN P/N64106202583
N EA 1 4 1

280045204 MONITOR ASSEMBLY F/N1222
1926014 1 EA IL IN MI OH WI
04 04 04 04

260319611 MONITOR ASSEMBLY F/N2131
1941575 1 EA IL IN MI OH WI
01 01 01 01
Lee Data CRT windowing monitor.

260402037 MONITOR ASSEMBLY AMBER F/N1222Z
1968099 1 EA IL IN MI OH WI
03 03

260990015 MONITOR FIBROUS AEROSOL
N EA 1 4 1

260354121 MONITOR IBM 8514 COLOR VGA
N EA 1 1 1
IBM PS/2 color monitor model 8514. 16in screen, VGA compatible. Stand tilts and swivels. 1028 x 768 supported resolution.

260447107 MONITOR IBM MODEL 8513 COLOR VGA
N
P/N 8513001.

250009594 MONITOR MODULE DML45
N

260420377 MONITOR NEC 4D/4DS MULTISYNC
1975318 1 EA IL IN MI OH WI
01
Color VGA display.

260432513 MONITOR NEC 4D/4DS MULTISYNC
N

260447115 MONITOR NEC MODEL 4FG COLOR VGA
N
P/N 1531VMA. Replaces the NEC 4D & 4DS color VGA monitors.

300087343 MONITOR TELTREND LSM 9601
1165639 1 EA IL IN MI OH WI
04 04 04 04

PRODUCT IDENTIFIER							DESCRIPTION						
ITEM NUMBER	ORD. MULT.	SELL UNIT	STD. PKG. STOCK AVAILABILITY / PA	LEAD TIME	MIN. ORD.	A C							

MOTOR

002079952 MOTOR 70-15388 SERVO

1188615 1 EA
Used in Digital Equipment Corp. T1000 and LA120 printers.

001214014 MOTOR ST-111-00 DEC

1193391 1 EA IL IN MI OH WI
04 04 04 04

001214022 MOTOR ST-112-00 DEC

1159574 1 EA IL IN MI OH WI
04 04

250070380 MOTOR UNIT 28C

1994491 1 EA IL IN MI OH WI
04 04 04 04

MOUNTING APPARATUS

100321322 MOUNTING APPARATUS 16C

1148015 1 EA
A metal frame work assembled on a wood composition backboard used with 117A and B cover, 25 7/8in X 16 1/8in. Part of 200D & E KTU, BSP 463-140-200. DISCONTINUE, ORDER NON STOCK UPON STOCK DEPLETION

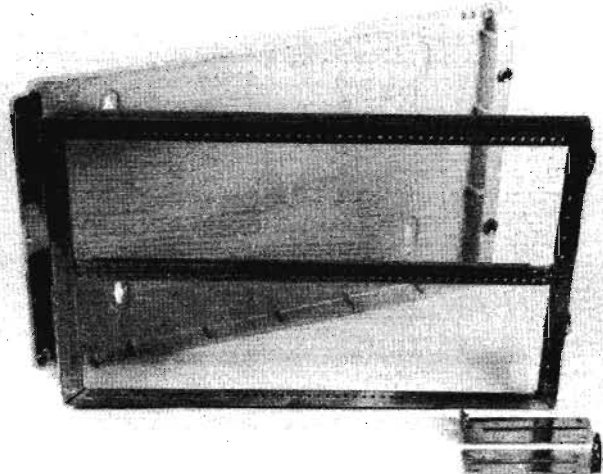

100321322

MOUNTING DATA

101771426 MOUNTING DATA 27B1

N EA 1 2 1

PRODUCT IDENTIFIER							DESCRIPTION						
ITEM NUMBER	ORD. MULT.	SELL UNIT	STD. PKG. STOCK AVAILABILITY / PA	LEAD TIME	MIN. ORD.	A C							

103195871 MOUNTING DATA 40A4

1180653 1 EA IL IN MI OH WI
03 03 03 03 03

For use in multiple installations of data sets used on switched telephone network, BSP 590-102-131.

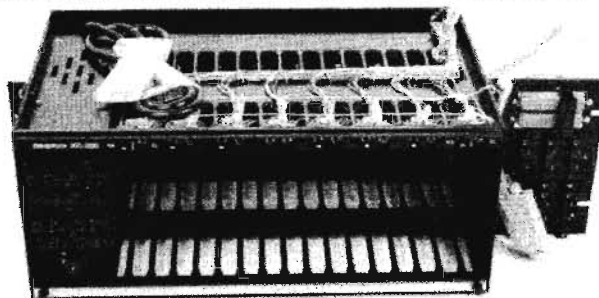

1180653

102300167 MOUNTING DATA 40B1 M/D

1222596 1 EA IL IN MI OH WI
04 04 04 04 04

MANUFACTURE DISCONTINUED.

102361086 MOUNTING DATA 42A1

N EA 1 2 1

102906013 MOUNTING DATA 44A2

N EA 1 2 1

Provides housing for set data auxiliary 829CL1, BSP 590-102-134.

102969250 MOUNTING DATA 46A2

1158170 1 EA IL IN MI OH WI
03 03 03 03 03

Provides interconnection of bell system data sets and customer provided modems up to eight, BSP 590-102-136.

102479250 MOUNTING DATA 46C1

N EA 1 10 1

103000188 MOUNTING DATA 46C2

N EA 1 2 1

102393394 MOUNTING DATA 47A1

1217315 1 EA IL IN MI OH WI
04 04 04 04 04

260339569 MOUNTING DATA 47B1

N EA 1 6 1

COMCODE 103942546.

103872040 MOUNTING DATA 47B1

N EA 1 4 1

DISTRIBUTION SERVICES

NETWORK SERVICES

TOOLS

BUILDING JANITORIAL

AUTOMOTIVE

FORMS/OFFICE SUPPLIES

GENERAL

DATA VOICE

DISTRIBUTION SERVICES

MOUNTING DATA

PRODUCT IDENTIFIER		DESCRIPTION					
ITEM NUMBER	ORD. MULT.	SELL UNIT	STD. STOCK	PKG. AVAILABILITY	LEAD TIME / PA	MIN. ORD.	A C

102393402 MOUNTING DATA 47B1
 1147645 1 EA IL IN MI OH WI
 04 04 04 04 04

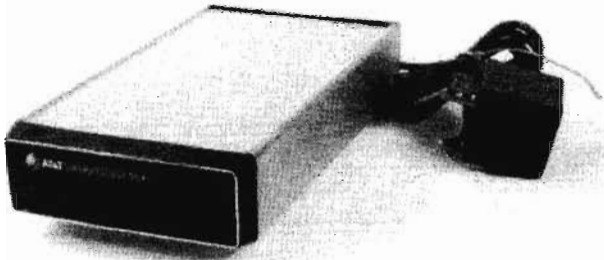

1147645

NETWORK SERVICES

TOOLS

102960630 MOUNTING DATA 47D2
 1175398 1 EA IL IN MI OH WI
 04 04 04 04 04
 Same as 47D1 except the interface assembly brings out additional leads provided by the 212A HA and 212ARHA.

102581485 MOUNTING DATA 48A1 L 1/2
 N EA 1 2 1

102458718 MOUNTING DATA 50A1
 N EA 1 2 1

102807187 MOUNTING DATA 52A2
 1166371 1 EA IL IN MI OH WI
 04 04 04 04 04
 A housing, interface assembly, transformer and cord for use with DAS 801C, BSP 590-102-142.

102945938 MOUNTING DATA 59A1
 1174193 1 EA IL IN MI OH WI
 04 04 04 04 04
 Provides housing and interface connections for one DAS 829 type with one 48ERI or 48FRI data unit, BSP 590-102-144.

103112470 MOUNTING DATA 62A1
 N EA 1 2 1

103628186 MOUNTING DATA 63A2
 N EA 1 2 1

103872214 MOUNTING DATA 63A2
 1166090 1 EA IL IN MI OH WI
 04 04 04 04 04
 Single Mounting for Dataphone II.

260000104 MOUNTING DATA 63A2
 1996579 1 EA IL IN MI OH WI
 04 04 04 04 04

103655759 MOUNTING DATA 64A2
 N EA 1 2 1

105171359 MOUNTING DATA 64A3
 1940106 1 EA IL IN MI OH WI
 04 04 04 04 04

103748265 MOUNTING DATA 97A4
 1216093 1 EA IL IN MI OH WI
 04 04 04 04 04

BUILDING JANITORIAL

AUTOMOTIVE

FORMS/OFFICE SUPPLIES

GENERAL

DATA VOICE

PRODUCT IDENTIFIER		DESCRIPTION					
ITEM NUMBER	ORD. MULT.	SELL UNIT	STD. STOCK	PKG. AVAILABILITY	LEAD TIME / PA	MIN. ORD.	A C

MOUNTING

101266187 MOUNTING JACK 270A-60
 N EA 1 14 1

MOUNTING PLATE

SEE PLATE MOUNTING.

MOUNTING ROD

SEE ROD MOUNTING.

MOUSE

260395652 MOUSE BUS W/WINDOWS 3.0
 N EA 1 2 1
 Microsoft bus mouse packaged with windows, 3.0 software, includes card to be installed in PC, software bundled 3.5in and 5.25in media.

260354048 MOUSE MICRO SOFT PS/2
 N EA 1 1 1
 Plugs into PS/2 PC'S next to keyboard. Does not require additional serial or bus port. Mouse, driver, 2.0 software included.

260436274 MOUSE MICRO SOFT SERIAL PS/2
 N EA 1 2 1
 Microsoft Mouse for all PC's. Will connect to mouse plug of PS/2 or serial port of any PC. Includes drivers. 3.5 & 5.25IN media.

260354055 MOUSE MS PS/2 W/WINDOWS 3.1 MICROSOFT
 1975326 10 EA IL IN MI OH WI
 04
 Plugs into PS/2 PC'S next to keyboard. Does not require additional serial or bus port. Mouse, driver, and windows 3.1 software included.

260432521 MOUSE SERIAL WITH WINDOWS 3.1
 N

260395645 MOUSE SERIAL W/WINDOWS 3.0
 N EA 1 2 1
 Microsoft serial mouse packaged with windows, 3.0 software, mouse works with PS/2 PCs and any PC with serial port, software bundled 3.5in and 5.25in media.

MULTIPLEXER

260427430 MULTIPLEXER COAX F/N1991
 N EA 1 4
 Lee Data.

PACK BATTERY

260404355 PACK BATTERY COMPAQ LTE/386S
 N EA 1 1 1
 Compaq enhanced nickel cadmium battery pack for LTE/386S.

PACKING MATERIAL & EQUIPMENT

PRODUCT IDENTIFIER		DESCRIPTION				
ITEM NUMBER	ORD. MULT.	SELL UNIT	STD. PKG. STOCK AVAILABILITY / PA	LEAD TIME	MIN. ORD.	A C
260358890 PACK BATTERY THINKJET PRINTER						
N		EA	1	2	1	
Hewlett Packard, nickelcadmium battery pack for battery powered Thinkjet Printer.						

PRODUCT IDENTIFIER		DESCRIPTION				
ITEM NUMBER	ORD. MULT.	SELL UNIT	STD. PKG. STOCK AVAILABILITY / PA	LEAD TIME	MIN. ORD.	A C
103202875 PACK CIRCUIT LC 338						
N		EA	1	8	1	

PACKING MATERIAL & EQUIPMENT

PACK CIRCUIT						
260303078 PACK CIRCUIT D STME33 1831						
1940148	1	EA				
Used to extend leads.						
103061842 PACK CIRCUIT HG 4B						
N		EA	1	18	1	
103061867 PACK CIRCUIT HG 12B						
N		EA	1	18	1	
103061875 PACK CIRCUIT HG 13B						
N		EA	1	18	1	
102469533 PACK CIRCUIT HG 16B						
N		EA	1	13	1	
103061925 PACK CIRCUIT HG 21B						
N		EA	1	18	1	
103061933 PACK CIRCUIT HG 22B						
N		EA	1	18	1	
102363074 PACK CIRCUIT HG 23						
N		EA	1	2	1	
102558475 PACK CIRCUIT HG 24						
N		EA	1	13	1	
103061958 PACK CIRCUIT HG 27B						
N		EA	1	18	1	
102244829 PACK CIRCUIT HK 6						
N		EA	1	13	1	
103881884 PACK CIRCUIT HK 9						
N		EA	1	13	1	
102556537 PACK CIRCUIT JY 2						
N		EA	1	2	1	
102697331 PACK CIRCUIT KD 11B						
N		EA	1	13	1	
102370525 PACK CIRCUIT KD 14						
N		EA	1	13	1	
102697364 PACK CIRCUIT KD 16B						
N		EA	1	13	1	
103962429 PACK CIRCUIT LC 96B						
N		EA	1	8	1	
103202842 PACK CIRCUIT LC 335V2						
N		EA	1	8	1	

900207903 BAG BURLAP NO 1 150LB 27 X 44IN						
1153973	1	EA				
Used to hold miscellaneous items for shipment.						
401129465 BAG PAPER 2LB						
1106047	50	EA	IL 32	IN 32	MI 32	OH 32 WI 32
401128392 BAG PAPER 10LB KRAFT GROCERY STYLE						
1210146	50	BG	IL 32	IN 32	MI 32	OH 32 WI 32
400474813 BAG PAPER 16LB KRAFT						
1106146	50	EA	IL 32	IN 32	MI 32	OH 32 WI 32
401128434 BAG PAPER 25LB						
1183574	50	EA	IL 32	IN 32	MI 32	OH 32 WI 32
900207945 BAG PAPER 70LB						
1106005	1	EA	IL 32	IN 32	MI 32	OH 32 WI 32
16in X 10in X 43 3/4in.						
260339031 BAG SHOPPING 18 X 18 3/4 X 7IN						
1948695	1	EA	IL 32	IN 32	MI 32	OH 32 WI 32
401332564 BOX 17 1/2IN X 6IN X 9IN						
N		EA	1	3	500	
Corrugated.						
401332572 BOX 17 1/2IN X 11 1/4IN X 5 1/8IN						
1115162	1	EA	IL 32	IN 32	MI 32	OH 32 WI 32
Cardboard.						
401332580 BOX TOTE 19 3/8IN X 15 9/16IN X 7IN						
1153122	1	EA	IL 32	IN 32	MI 32	OH 32 WI 32
Box carried on telephone trucks for packing telephone sets and other small equipment removed from customer's premise.						
401613104 BOX TOTE COVER						
4134882	1	EA	IL 32	IN 32	MI 32	OH 32 WI 32
300087152 CARDBOARD D3						
4213355	1	EA	IL 32	IN 32	MI 32	OH 32 WI 32
DISCONTINUE UPON STOCK DEPLETION						
300087202 CARDBOARD D4						
4213363	1	EA	IL 32	IN 32	MI 32	OH 32 WI 32

DISTRIBUTION SERVICES

NETWORK SERVICES

TOOLS

BUILDING JANITORIAL

AUTOMOTIVE

FORMS/OFFICE SUPPLIES

GENERAL

DATA VOICE

PACKING MATERIAL & EQUIPMENT

DISTRIBUTION SERVICES

PRODUCT IDENTIFIER		DESCRIPTION					
ITEM NUMBER	ORD. MULT.	SELL UNIT	STD. PKG. STOCK AVAILABILITY / PA	LEAD TIME	MIN. ORD.	A C	
300087145 CARDBOARD DXL2							
4213330	1	EA	IL IN MI OH WI 32				
DISCONTINUE UPON STOCK DEPLETION							

NETWORK SERVICES

280048950 CARGOTAINER 40IN X 40IN X 24IN						
N		EA	1	4	1000	
900216524 CARTON 1061						
2221648	1	EA	IL IN MI OH WI 32 32 32 32			
900219445 CARTON 2017						
7331504	1	EA	IL IN MI OH WI 32 32 32 32			

TOOLS

900219452 CARTON 4052						
5178285	1	EA	IL IN MI OH WI 32 32 32 32			
12 3/4in X 9 1/2in X 7 3/4in.						
002047165 CARTON 4444						
4197061	1	EA	IL IN MI OH WI 32 32 32 32			

BUILDING JANITORIAL

002095347 CARTON 8IN X 8IN X 4IN						
1460303	1	EA	IL IN MI OH WI 32 32 32 32 32			
Packing carton with logo, 200lb test, for shipping SR&R to vendor.						

AUTOMOTIVE

002095354 CARTON 10IN X 4IN X 4IN						
1460287	1	EA	IL IN MI OH WI 32 32 32 32 32			
200lb test. DISCONTINUE UPON STOCK DEPLETION.						

FORMS/OFFICE SUPPLIES

002095362 CARTON 10IN X 6IN X 6IN						
1460261	1	EA	IL IN MI OH WI 32 32 32 32 32			
Packing carton with logo, 200lb test, for shipping SR&R to vendor.						
300006368 CARTON 11 1/2 X 8 1/2 X 5IN						
1213678	1	EA	IL IN MI OH WI 32 32			

GENERAL

300006343 CARTON 11 1/2 X 8 1/2 X 7IN						
4200121	1	EA	IL IN MI OH WI 32 32 32 32			
300006376 CARTON 11 1/2 X 8 1/2 X 3 1/4IN						
4200154	1	EA	IL IN MI OH WI 32 32			

DATA VOICE

260357876 CARTON 11 1/2 X 9 3/4 X 4IN						
N		EA	1	1	1	
260357843 CARTON 11 1/2 X 9 3/4 X 12IN						
N		EA	1	2	1	
260357835 CARTON 11 1/2 X 9 3/4 X 14IN						
N		EA	1	2	1	
260357918 CARTON 11 1/2 X 9 3/4 X 16IN						
N		EA	1	2	1	

PRODUCT IDENTIFIER		DESCRIPTION					
ITEM NUMBER	ORD. MULT.	SELL UNIT	STD. PKG. STOCK AVAILABILITY / PA	LEAD TIME	MIN. ORD.	A C	
260357900 CARTON 11 1/2 X 9 3/4 X 18IN							
N		EA	1	2	1		
260357892 CARTON 11 1/2 X 9 3/4 X 20IN							
N		EA	1	2	1		
260357884 CARTON 11 1/2 X 9 3/4 X 3 1/4IN							
N		EA	1	1	1		
260357868 CARTON 11 1/2 X 9 3/4 X 5IN							
N		EA	1	2	1		
260357850 CARTON 11 1/2 X 9 3/4 X 6IN							
N		EA	1	2	1		
002095289 CARTON 12IN X 6IN X 6IN							
1460360	1	EA	IL IN MI OH WI 32 32 32 32 32				
Packing carton with logo, 200lb test, for shipping SR&R to vendor.							
260357926 CARTON 12IN X 9IN X 14IN							
N		EA	1	2	1		
300006806 CARTON 12IN X 10IN X 10IN							
1303669	1	EA	IL IN MI OH WI 32 32 32 32 32				
Packing carton with logo for shipping SR&R to vendor.							
002095248 CARTON 14IN X 10IN X 10IN							
1460345	1	EA	IL IN MI OH WI 32 32 32 32 32				
Packing carton with logo for shipping SR&R to vendor.							
260357959 CARTON 14IN X 12IN X 20IN							
N		EA	1	2	1		
002095420 CARTON 16IN X 12IN X 12IN							
1460485	1	EA	IL IN MI OH WI 32 32 32 32 32				
Packing carton with logo, 200lb test, for shipping SR&R to vendor.							
260405279 CARTON 18IN X 12IN X 2 1/2IN							
1969477	1	EA	IL IN MI OH WI 32				
260357942 CARTON 18IN X 12IN X 4IN							
N		EA	1	2	1		
260357934 CARTON 18IN X 12IN X 10IN							
N		EA	1	2	1		
002095412 CARTON 18IN X 18IN X 18IN							
1460469	1	EA	IL IN MI OH WI 32 32 32 32 32				
Packing carton with logo, 200lb test, for shipping SR&R to vendor.							
300060878 CARTON 20IN X 5IN X 4IN							
1225896	1	EA	IL IN MI OH WI				
With logo, ADC ONLY.							

PACKING MATERIAL & EQUIPMENT

DISTRIBUTION SERVICES

NETWORK SERVICES

TOOLS

BUILDING JANITORIAL

AUTOMOTIVE

FORMS/OFFICE SUPPLIES

GENERAL

DATA VOICE

PRODUCT IDENTIFIER		DESCRIPTION					
ITEM NUMBER	ORD. MULT.	SELL UNIT	STD. PKG. STOCK AVAILABILITY / PA	LEAD TIME	MIN. ORD.	A C	
002095313		CARTON	20IN X 12IN X 12IN				
1460402	1	EA	IL IN MI OH WI 32 32 32 32 32				
Packing carton with logo for shipping SR&R to vendor.							
002095404		CARTON	20IN X 16IN X 16IN				
1460444	1	EA	IL IN MI OH WI 32 32 32 32 32				
Packing carton with logo, 275lb test, for shipping SR&R to vendor.							
900218389		CARTON	20IN X 20IN X 20IN				
1131391	1	EA	IL IN MI OH WI 32				
With logo.							
002095339		CARTON	21IN X 14IN X 15IN				
1459842	1	EA	IL IN MI OH WI 32 32 32 32 32				
Packing carton with logo, 200lb test, for shipping SR&R to vendor.							
002095396		CARTON	23IN X 14IN X 11IN				
1460220	1	EA	IL IN MI OH WI 32 32 32 32 32				
Packing carton with logo, 275lb test, for shipping SR&R to vendor.							
300060886		CARTON	24IN X 6IN X 4IN W/LOGO				
N		EA	1	3	700		
260357967		CARTON	24IN X 12IN X 12IN				
N		EA	1	2	1		
002095388		CARTON	26IN X 18IN X 19IN				
1460428	1	EA	IL IN MI OH WI 32 32 32 32 32				
Packing carton with logo, 275lb test, for shipping SR&R to vendor.							
280054925		CARTON	36IN X 12IN X 12IN W/LOGO				
1929927	1	EA	IL IN MI OH WI 32 32 32 32				
ADC ONLY.							
401359203		CARTON COVER	2017				
1217653	1	EA	IL IN MI OH WI 32 32				
DISCONTINUE UPON STOCK DEPLETION							
900219403		CARTON FIBER BOARD	BOTTOM				
2309021	1	EA	IL IN MI OH WI 32 32				
24in X 16in X 8 1/2 in.							
000237701		CARTON KIT	A				
N							
000237719		CARTON KIT	B				
N							
000237719		CARTON KIT	B				
1173294	1	EA	IL IN MI OH WI 32 32				
DISCONTINUE UPON STOCK DEPLETION							

PRODUCT IDENTIFIER		DESCRIPTION					
ITEM NUMBER	ORD. MULT.	SELL UNIT	STD. PKG. STOCK AVAILABILITY / PA	LEAD TIME	MIN. ORD.	A C	
900219460		CARTON PS	4084				
5178301	1	EA	IL IN MI OH WI 32 32 32				
DISCONTINUE UPON STOCK DEPLETION							
401140074		CARTON PS	8704				
1224659	1	EA	IL IN MI OH WI 32 32				
DISCONTINUE UPON STOCK DEPLETION							
402614226		CARTON RETURN TUBE	R4868A				
5104786	1	EA	IL IN MI OH WI 32 32 32 32 32				
300023157		CARTON SALVAGE	SC4430				
5104778	1	EA	IL IN MI OH WI 32 32 32 32				
001025816		CARTON TTP	24 3/4 X 16 3/8 X 2IN				
2309062	1	EA	IL IN MI OH WI 32				
900335605		CONTAINER CORRUGATED	DOUBLE WALL				
2627687	1	EA	IL IN MI OH WI 32 32				
42in X 42in X 24in.							
280016510		MAILER UNIT	2611 TAPE				
N		EA	1	2	1		
600ft, 1200ft, 2400ft.							
900508458		MATERIAL PACKING	AIRCAP SC240				
1127761	1	RO	IL IN MI OH WI 32 32 32				
260323415		MATERIAL PACKING	BUBBLE 10535				
1943712	1	CT	IL IN MI OH WI 32 32 32 32 32				
280026196		MATERIAL PACKING	BUBBLE 12IN AS				
1922203	1	BD	IL IN MI OH WI 32 32 32 32 32				
12IN X 1/2IN X 250FT, Packing material for general use.							
260357264		MATERIAL PACKING	BUBBLE 24IN				
1952747	1	BD	IL IN MI OH WI 32 32				
24IN X 1/2IN X 250FT, Packing material for general use.							
002008449		MATERIAL PACKING	BUBBLE SC120				
1197178	1	CT	IL IN MI OH WI 32 32 32 32 32				
12in X 175ft, Protective packaging of delicate test sets and other types of equipment requiring maximum protection, perforated every 12in for easy separation.							
401350905		MATERIAL PACKING	JUTE B1 27IN				
8138602	1	BX	IL IN MI OH WI 33 33				
DISCONTINUE UPON STOCK DEPLETION							
401148655		MATERIAL PACKING	KIMPACK 12IN				
1139618	1	EA	IL IN MI OH WI 32 32				
DISCONTINUE UPON STOCK DEPLETION							

PACKING MATERIAL & EQUIPMENT

DISTRIBUTION SERVICES	PRODUCT IDENTIFIER		DESCRIPTION						
	ITEM	ORD.	SELL	STD. PKG.	LEAD TIME		MIN.	A	
	NUMBER	MULT.	UNIT	STOCK AVAILABILITY / PA		ORD.	C		
	997127543	1	EA	IL	IN	MI	OH	WI	PACK BLISTER CK19382 L1 DISCONTINUE UPON STOCK DEPLETION
	1195453	1	EA	04	04				
	997127568	1	EA	IL	IN	MI	OH	WI	PACK BLISTER CK19382 L3 DISCONTINUE UPON STOCK DEPLETION
	8127688	1	EA	04	04				
	997127576	1	EA	IL	IN	MI	OH	WI	PACK BLISTER CK19382 L4 DISCONTINUE UPON STOCK DEPLETION
	8127605	1	EA	04	04				
	300023298	1	EA	IL	IN	MI	OH	WI	PALLET SALVAGE SC4430B
	1215830	1	EA	32	32	32	32		
	001015478	1	RO	IL	IN	MI	OH	WI	PAPER BOGUS TXL 24IN W X 91N D Packing material.
	1220731	1	RO	31					
	401351879	1	RO	IL	IN	MI	OH	WI	PAPER WRAP KRAFT 24IN 30LB
	1189357	1	RO	33	33	33	33	33	
	401353669	1	SH	IL	IN	MI	OH	WI	PAPER WRAP SHEET 24 X 36IN 30LB
	5654202	1	SH	33	33	33	33		
	401153929	1	SH	IL	IN	MI	OH	WI	PAPER WRAP SHEET 24 X 36IN 40LB
	1208769	1	SH	33	33	33			
	300025350	1	RO	IL	IN	MI	OH	WI	TAPE FILAMENT 1/2IN X 60FT ROLL DISCONTINUE, REPLACED BY TAPE FILAMENT 193 3/4IN X 60YD ROLL
	8403568	1	RO	32	32	32	32		
	300032018	1	RO	IL	IN	MI	OH	WI	TAPE PS-3 3IN X 170YD Used for sealing boxes when returning material to material distribution centers.
	8405134	1	RO	32	32	32		32	
	260301593	N	RL	1	1			1	TAPE SEALING ID432 2IN X 55FT POLY Clear, Rex.
	280035965	N	RO	1	2			1	TAPE SEALING PERMACELL 2 Tan.
	002043552	1	RO	IL	IN	MI	OH	WI	TAPE SEALING PRESSTIX 2IN X 120YD
	2732107	1	RO	32	32	32	32	32	ST 32
	260409594	N	EA	1	1			1	TUBE MAILING 24IN X 2 1/4IN J-64 NOW AVAILABLE THROUGH TOUCH-TONE ORDER ENTRY.

NETWORK SERVICES	PRODUCT IDENTIFIER		DESCRIPTION							
	ITEM	ORD.	SELL	STD. PKG.	LEAD TIME		MIN.	A		
	NUMBER	MULT.	UNIT	STOCK AVAILABILITY / PA		ORD.	C			
	260409693	N	EA	1	1			1	TUBE MAILING 36IN X 2 1/4IN J-65 NOW AVAILABLE THROUGH TOUCH-TONE ORDER ENTRY.	
	260409792	N	EA	1	1			1	TUBE MAILING 42IN X 2 1/4IN J-66 NOW AVAILABLE THROUGH TOUCH TONE ORDER ENTRY.	
	900166232	1283549	1	EA	IL	IN	MI	OH	TWINE POLISHED 18 1/2LB	
						33	33			
	401667423	1283564	1	EA	IL	IN	MI	OH	TWINE POLISHED 24 1/2 LB	
						33	33	33	33	
	PAD									
	260364138	N	BX	1	2			1	PAD TX 801 TEXPADS Box of 80. Magnetic tape head cleaner.	
	260359138	N	BX	1	8			1	PAD TX1301 CLEANING Magnetic tape head cleaner, commercial equivalent of TX801, 80 pads per box.	
	PAD MOUSE									
	260432539	1975417	1	EA					1	PAD MOUSE 8IN X 9 1/2IN Pad used to protect PC mouse from dust and dirt. Approximate size, colors vary.
	260429477	N	EA	1	2			1	PAD MOUSE WAVE 03-95112 9 1/2 X 11IN, Blue.	
	PAGECOM									
	280022120	N	EA	1	1			1	PAGECOM MODEL A04EAC2468AC Frequency, 451.300	
	PANEL									
	101590941	1156950	1	EA					1	PANEL 584C A 4in X 23in mounting arranged to mount 13 separately obtained plug-in 400 or 401 type KTU, authorized sub 584B, BSP 518-270-101.
	102587722	N	EA	1	14			1	PANEL 626A	
	001125376	1219055	1	EA	IL	IN	MI	OH	PANEL GB10550A TELEPHONE SET	
					04	04				

PRODUCT IDENTIFIER		DESCRIPTION				
ITEM NUMBER	ORD. MULT.	SELL UNIT	STD. PKG. STOCK AVAILABILITY / PA	LEAD TIME	MIN. ORD.	A C
260341516 PANEL GB30194 COMMUNICATION						
1949768	1	EA	IL IN MI OH WI 04			
402022362 PANEL GLASS PC7R SIDE						
N		EA	10	9	10	
280037425 PANEL LINE CARD MOUNTING						
N		EA	1	2	1	
0319-0200 5B319A, SANBAR.						

PRODUCT IDENTIFIER		DESCRIPTION				
ITEM NUMBER	ORD. MULT.	SELL UNIT	STD. PKG. STOCK AVAILABILITY / PA	LEAD TIME	MIN. ORD.	A C
PHOTOCONDUCTOR						
260339890 PHOTOCONDUCTER UNIT IBM 3812						
N		EA	1	2	1	
Page Printer 1348347.						
260344338 PHOTOCONDUCTOR UNIT IBM 4216						
N		EA	1	1	1	
Pagemaker.						

PCB

SEE CARD.

PLATE

PEDESTAL

500027834 PEDESTAL 40CAB901/AC						
N		EA	1	4	1	
500036603 PEDESTAL 40CAB901/AF						
N		EA	1	2	1	
500036611 PEDESTAL 40CAB901/AG						
N		EA	1	4	1	
500044094 PEDESTAL 40CAB901/AJ						
N		EA	1	5	1	
500046230 PEDESTAL 40CAB902/AA						
N		EA	1	5	1	
500046495 PEDESTAL 40CAB904/AA						
N		EA	1	5	1	

PLATE FACE

300006384 PLATE FLUSH FS2 IVORY						
1153924	1	EA				
Package of 2.						
260437710 PLATE MOUNTING 733M MAGNETIC						
N						
260437702 PLATE MOUNTING ADHESIVE 733						
N		EA	50	3	5000	
260437694 PLATE MOUNTING ADHESIVE 734						
N		EA	50	3	2000	
260437686 PLATE MOUNTING MAGNETIC 734M						
N		EA	50	3	2000	

PHONE BEAM

300023314 PHONE BEAM IR101-01 50PIN						
N		EA	1	4	1	

300023306 PHONE BEAM IR101-02W4WIRE						
1306928	1	EA	IL IN MI OH WI 04 04 04			
DISCONTINUED - ORDER NON STOCK						

280047606 PHONE BEAM IR101-03						
N		EA	1	3	1	
Direct replacement for the 4A Speaker phone systems.						

PHONE DESK

280019522 PHONE DESK TOP R-TEC CHARGE						
N		EA	1	2	1	
Card w/carrier selection key pad 76-011-99.						

PLATE FACE

102598752 PLATE FACE 2830B 73						
N		EA	1		1	
102598760 PLATE FACE 2830B 75						
1302877	1	EA	IL IN MI OH WI 04 04 04 04			
DISCONTINUE, ORDER NON STOCK UPON STOCK DEPLETION						
102598786 PLATE FACE 2830B 80						
1229872	1	EA	IL IN MI OH WI 04 04 04 59			
For set tel 2830 A1M, muted ivory, BSP 503-701-101. DISCONTINUE, ORDER NON STOCK UPON STOCK DEPLETION						
102598802 PLATE FACE 2833A 70						
1301408	1	EA	IL IN MI OH WI 04 04 04 04			
For the 2833A and C telephone set, charcoal, BSP 518-450-102. DISCONTINUE, ORDER NON STOCK UPON STOCK DEPLETION						
102598844 PLATE FACE 2833A 75						
1310763	1	EA	IL IN MI OH WI 04 04 04 04			
DISCONTINUED - ORDER NON STOCK UPON STOCK DEPLETION						

DISTRIBUTION SERVICES
NETWORK SERVICES
TOOLS
BUILDING JANITORIAL
AUTOMOTIVE
FORMS/OFFICE SUPPLIES
GENERAL
DATA VOICE

DISTRIBUTION SERVICES

NETWORK SERVICES

TOOLS

BUILDING JANITORIAL

AUTOMOTIVE

FORMS/OFFICE SUPPLIES

GENERAL

DATA VOICE

PLATE FACE

PRODUCT IDENTIFIER		DESCRIPTION					
ITEM NUMBER	ORD. MULT.	SELL UNIT	STD. PKG. STOCK AVAILABILITY / PA	LEAD TIME	MIN. ORD.	A C	
102648649 PLATE FACE 2852A 70							
N		EA	1		1		
Used for a 2851AM telephone set, charcoal. See Table A of BSP for colored housing and co-ordinated face plates, BSP 503-601-101. DISCONTINUE, ORDER NON STOCK UPON STOCK DEPLETION							
102648706 PLATE FACE 2852A 80							
1202234	1	EA	IL IN MI OH WI 04 04 04 04				
DISCONTINUE, ORDER NON STOCK UPON STOCK DEPLETION							
102932142 PLATE FACE 2872B1 108							
1186742	1	EA	IL IN MI OH WI 04				
DISCONTINUE, ORDER NON STOCK UPON STOCK DEPLETION							
102932159 PLATE FACE 2872B1 109							
N		EA	1				
840597694 PLATE FACE 840597694							
1109348	1	EA	IL IN MI OH WI 04 04 04 04				
DISCONTINUED - ORDER NON STOCK UPON STOCK DEPLETION							
280028747 PLATE FACE 860031-009 IVORY							
N		EA	10	4	1		
280028754 PLATE FACE 860031-013 BEIGE							
N		EA	10	4	1		
PLOTTER							
260425145 PLOTTER HP 7475A OPTION 1							
N		EA	1		1		
Hewlett Packard.							
260425186 PLOTTER HP 7550A							
N		EA	1		1		
Hewlett Packard.							
PLUG							
102601440 PLUG 478A 03							
1178095	1	EA					
A flexible twin-double conductor plug. It contains a 616P miniature jack and a 100 ohm one watt resistor. It is intended for use with G-15 and K1 type headsets.							
102601457 PLUG 478A 50							
N		EA	1	1	1		
Used with cord, H4DU 58 std.							
102601465 PLUG 478A 58 WHITE							
N		EA	1	11	1		

PRODUCT IDENTIFIER		DESCRIPTION					
ITEM NUMBER	ORD. MULT.	SELL UNIT	STD. PKG. STOCK AVAILABILITY / PA	LEAD TIME	MIN. ORD.	A C	

102645264 PLUG 478B 50							
1204313	1	EA	IL IN MI OH WI 04 04 04 04				
A twin double conductor plug similar to a 478A except not e/w resistor.							
300055308 PLUG ACOUSTICAL BL							
N		PK	1	4	1		
Package of 10.							
260438411 PLUG RUBBER CONDUIT SQUARE							
N							
PORT EXPANSION							
280044959 PORT EXPANSION ASYNC F/N1293A							
1925370	1	EA					
280044942 PORT EXPANSION ASYNC F/N1294A							
N		EA	1	6	1		
280044934 PORT EXPANSION ASYNC F/N1295A							
N		EA	1	6	1		
PRINTED CIRCUIT BOARD							
SEE CARD.							
PRINthead							
002079929 PRINthead ASSEMBLY 70-15085							
1172858	1	EA					
See Head Print Assembly 70-15085-00 (PID000238857).							
000238857 PRINthead ASSEMBLY 70-15085-00							
N		EA	1	4	1		
ST107. If old model has Diecast Carriage, then order Stk/Item 1213990 and 70-14533-01 Non-Stk, If old model has PLASTIC CARRIAGE, then order Stk/Item 1213990 only.							
001213990 PRINthead ASSEMBLY ST107-00							
1221200	1	EA	IL IN MI OH WI 04 04 04 04 04				
30-27655-01							
260435466 PRINthead FACIT C6510 P/N SXX1030011/3							
N		EA	1	3	1		
260435177 PRINthead P/N 290886-014							
1980201		EA	IL IN MI OH WI 04				
PRINTWHEEL							
280034596 PRINTWHEEL 1353778 12 SCRIPT							
N		EA	1	2	1		
For IBM displaywriter.							
280034604 PRINTWHEEL 1353796 COURIER 15 PITCH							
N		EA	1	2	1		

PRODUCT IDENTIFIER		DESCRIPTION					
ITEM NUMBER	ORD. MULT.	SELL UNIT	STD. PKG. STOCK AVAILABILITY / PA	LEAD TIME	MIN. ORD.	A	C

PRODUCT IDENTIFIER		DESCRIPTION					
ITEM NUMBER	ORD. MULT.	SELL UNIT	STD. PKG. STOCK AVAILABILITY / PA	LEAD TIME	MIN. ORD.	A	C

DISTRIBUTION SERVICES

PROCESSOR

PULLEY

260319686 PROCESSOR PCB 80003015 M/D
 1941500 1 EA
 Lee Data processor board, used in all 3274 type controllers. MANUFACTURER DISCONTINUED - NO REPLACEMENT.

000238907 PULLEY 20T 12-15239-00
 N EA 1 4 1
000238915 PULLEY 30T 12-12446-00
 N EA 1 4 1

NETWORK SERVICES

260319678 PROCESSOR PCB MULTI-PORT
 1941484 1 EA IL IN MI OH WI
 02 02
 Lee Data ASYNC processor board, one per eight ASYNC ports.

PUMP

260421367 PUMP ELECTRIC ASPIRATOR SP200
 N EA 1 3 1
 For gas monitor CMX271, P/N1810-0180.
260421375 PUMP HAND P/N 1810-1022
 N EA 1 3 1
 Pump hand for gas monitor CMX271.

TOOLS

PROTECTOR SURGE

An electrical device designed specifically to protect computer and communications equipment against voltage surge, spikes and transients.

280057142 PROTECTOR SURGE 5300 PS
 N EA 1 1 1
 6 foot cord, 6 outlet strip, plastic housing, EFI.

RECEIVER

280000712 RECEIVER 184936-101
 N EA 1 4 1

BUILDING JANITORIAL

280057159 PROTECTOR SURGE DPI 153
 N EA 1 1 1
 Direct plug-in, 2 outlet, plastic housing, EFI.

RECEPTACLE

260390570 RECEPTACLE WASTE 20IN X 32IN
 N EA 1 3 1
 Justrite Cease Fire 26630.

AUTOMOTIVE

280057084 PROTECTOR SURGE IB2-0
 N EA 1 1 1
 Direct plug-in, 2 outlets, metal housing, Triplite.

280057092 PROTECTOR SURGE IB2-6
 N EA 1 1 1
 6 foot cord, 2 outlets, metal housing, Triplite.

REGULATOR

260422142 REGULATOR FLOW P/N1810-0933
 N EA 1 3 1
 W/pressure guage.

FORMS/OFFICE SUPPLIES

280057100 PROTECTOR SURGE IB4-6
 1943803 1 EA IL IN MI OH WI
 31 31 31 31 31
 8ft cord, 4 outlets, metal housing, Triplite.

280057118 PROTECTOR SURGE IB6-6
 1937466 1 EA IL IN MI OH WI
 31 31 31 31 31
 6 foot cord, 6 outlets, metal housing, Triplite.

RELAY

400219499 RELAY CK16301 L15
 N EA 1 4 1
 Used with CK16301 Horn and Bell. Auxiliary signal used with telephone stations to meet special requirements for loud and distinctive tone signals, BSP 463-110-100.

GENERAL

280057126 PROTECTOR SURGE IB8-15
 N EA 1 1 1
 15 foot cord, 8 outlets, metal housing, Triplite.

260382262 PROTECTOR SURGE OPERATOR
 1961490 1 EA IL IN MI OH WI
 03 03
 Electrical surge protector for operator positions. Protects against electrical/lightning surges through telephone system. ITW LINX Part #MP2-90-68.

REST SHOULDER

260343058 REST SHOULDER TELEPHN PEARL GRY SOFT 133
 1949974 1 EA
 DISCONTINUE AND FORWARD TO REST SHOULDER TELEPHONE 872201 UPON STOCK DEPLETION.

DATA VOICE

280057134 PROTECTOR SURGE SK6-6
 N EA 1 1 1
 6 foot cord, 6 outlets, plastic housing, Triplite.

280043399 PROTECTOR SURGE TMC 428 2-OUTLET
 1924985 1 EA IL IN MI OH WI
 31 31 31
 W/O Cord. Triplite.

REST SHOULDER

DISTRIBUTION SERVICES

PRODUCT IDENTIFIER		DESCRIPTION					
ITEM NUMBER	ORD. MULT.	SELL UNIT	STD. PKG. STOCK AVAILABILITY / PA	LEAD TIME	MIN. ORD.	A C	

250303102 REST SHOULDER TELEPHONE 872201
 1940155 1 EA IL IN MI OH WI
 18 18
 An adhesive mounted shoulder rest for use with most handsets. DISCONTINUE UPON STOCK DEPLETION

NETWORK SERVICES

260343041 REST SHOULDER TELEPHONE ASH SOFT 115
 1949966 1 EA IL IN MI OH WI
 18
 DISCONTINUE AND FORWARD TO REST SHOULDER TELEPHONE 872201 UPON STOCK DEPLETION

TOOLS

260441878 REST SHOULDER TELEPHONE BLACK SOFT 101
 N EA 24 2 24

RINGER

100666288 RINGER C4A
 1168211 1 EA
 Used with 500 type telephone sets, BSP 501-250-303.

260382593 RINGER TONE SR100
 N EA 1 4 1

SAF-T-RACK

280037474 SAF-T-RACK SEAT MOUNT
 N EA 1 3 1

280037482 SAF-T-RACK WALL MOUNT
 N EA 1 1 1

SCREEN

260358601 SCREEN ANTI-GLARE 18016C-D
 N EA 1 2 1
 For Lee Data F/N2131.

SENSOR

SET DATA

103062584 SET DATA 103 JR L1
 1145458 1 EA

103185955 SET DATA 108 D L1A
 N EA 1 2 1
 A FDX, FSK, serial-transmission unit which provides low-speed data transmission over 2 or 4 wire private line facilities.

103182069 SET DATA 108 E L1A
 N EA 1 3 1
 A single plug-in card consisting of two printed circuit boards mounted together in piggy-back arrangement.

GENERAL

DATA VOICE

PRODUCT IDENTIFIER		DESCRIPTION					
ITEM NUMBER	ORD. MULT.	SELL UNIT	STD. PKG. STOCK AVAILABILITY / PA	LEAD TIME	MIN. ORD.	A C	

102906476 SET DATA 108 F L1
 1146035 1 EA IL IN MI OH WI
 37 37 37 37 37
 Low speed private line data set used in applications requiring EIA interface with terminal equipment.

102902723 SET DATA 108 G L1
 1116798 1 EA IL IN MI OH WI
 37 37 37 37 37
 Low speed private line data set used in applications requiring EIA interface with terminal equipment.

102898640 SET DATA 108 H L1
 N EA 1 6 1

102898657 SET DATA 108 J L1
 1148130 1 EA IL IN MI OH WI
 37 37 37 37 37
 Low speed private line data set used in applications requiring current interface with terminal equipment.

102931003 SET DATA 113 DR L1
 N EA 1 11 1

103070108 SET DATA 202 SR L1C
 N EA 1 2 1

260000153 SET DATA 208 A L1B
 1996629 1 EA IL IN MI OH WI
 01 01 01 01 01

102949872 SET DATA 208 BR L1C-R
 N EA 1 3 1

102402336 SET DATA 209 A L1
 1157453 1 EA IL IN MI OH WI
 01 01 01 01 01

260000161 SET DATA 212 A L1A
 1996637 1 EA IL IN MI OH WI
 01 01 01 01 01

260000195 SET DATA 2024 A L1A
 1996660 1 EA IL IN MI OH WI
 01 01 01 01 01



1996660

250015237 SET DATA 208 A L1B
 N

DISTRIBUTION SERVICES

NETWORK SERVICES

TOOLS

BUILDING JANITORIAL

AUTOMOTIVE

FORMS/OFFICE SUPPLIES

GENERAL

DATA VOICE

PRODUCT IDENTIFIER		DESCRIPTION					
ITEM NUMBER	ORD. MULT.	SELL UNIT	STD. PKG. STOCK AVAILABILITY / PA	LEAD TIME	MIN. ORD.	A C	
103043394		SET DATA AUXILIARY 801 CR L1					
N		EA	1	2	1		
An automatic calling unit that provides a means for business machines to automatically originate dataphone calls on touch tone lines.							
102860301		SET DATA AUXILIARY 829 BL1A					
N		EA	1	2	1		
102860319		SET DATA AUXILIARY 829 C L1A					
N		EA	1	2	1		
102949864		SET DATA AUXILIARY 830 BL 1A					
N		EA	1	12	1		
SET TELEPHONE							
280049263		SET TELEPHONE 0254-00 MBA-21M					
N		EA	1	4	1		
Black.							
280049271		SET TELEPHONE 0254-09 MBA-21M					
1928200	1	EA	IL IN MI OH WI				
				04			
Ivory.							
280049289		SET TELEPHONE 0254-13 MBA-21M					
N		EA	1	4	1		
Beige.							
300093358		SET TELEPHONE 2500-00 OBA-39M					
N		EA	1	6	432		
Black.							
300093366		SET TELEPHONE 2500-09 OBA-39M					
N		EA	1	6	432		
Ivory.							
280026220		SET TELEPHONE 2500-09 MBA-44M					
N		EA	1	4	432		
Logo, Ivory.							
300093374		SET TELEPHONE 2500-13 OBA-39M					
1923953	1	EA	IL IN MI OH WI				
				04 04 04 04			
Full modular, tap, S dial, Message Waiting, beige desk set.							
280053299		SET TELEPHONE 2500-44 MBA-20F					
1928754	1	EA	IL IN MI OH WI				
				04			
Ash.							
300080835		SET TELEPHONE 2500-BE-CW 007M					
1167734	1	EA	IL IN MI OH WI				
				04 04 04 04			
260000336		SET TELEPHONE 2500-SM 60 BEIGE					
1996801	1	EA	IL IN MI OH WI				
				04 04 04 04			
260000351		SET TELEPHONE 2565-HKM 60 BEIGE					
1996033	1	EA	IL IN MI OH WI				
				04 04 04 04			

PRODUCT IDENTIFIER		DESCRIPTION					
ITEM NUMBER	ORD. MULT.	SELL UNIT	STD. PKG. STOCK AVAILABILITY / PA	LEAD TIME	MIN. ORD.	A C	
103229852		SET TELEPHONE 2585-LKMS 03 BLACK					
8405308	1	EA	IL IN MI OH WI				
				04 04 04 04			
300093440		SET TELEPHONE 2576-00 OBA-40M					
N		EA	1	4	1		
Black.							
300093457		SET TELEPHONE 2576-09 OBA-40M					
N		EA	1	4	1		
Ivory.							
300093465		SET TELEPHONE 2576-13 OBA-40M					
N		EA	1	4	1		
Beige.							
103295739		SET TELEPHONE 2634-DAMS 1 60 BEIGE					
1117523	1	EA	IL IN MI OH WI				
				04			
102563376		SET TELEPHONE 2662-A1M 60 BEIGE					
N		EA	1	4	1		
103337622		SET TELEPHONE 2683-AAMS1 60 BEIGE					
N		EA	1		1		
280049339		SET TELEPHONE 3200-09 MBA-21M					
N		EA	1	6	1		
An ivory touch-tone Trendline desk telephone set equipped with extra length mounting cords.							
260324421		SET TELEPHONE INTERQUARTZ 9853					
1945923	1	EA	IL IN MI OH WI				
				04 04 04 04			
Single line telephone with redial, memory, tap, and built-in speaker. DISCONTINUE UPON STOCK DEPLETION							
280071598		SET TELEPHONE KXT-2325 PANASONIC					
N		EA	1	1	1		
280071606		SET TELEPHONE KXT-2345 PANASONIC					
N		EA	1	1	1		
300091469		SET TELEPHONE TRILLIUM T1000					
N		EA	1	12	15		
Single line feature phone.							
SET TELEPHONE HAND							
280028812		SET HAND 006513-OC2 N/M 4IN CORD					
N		EA	30	4	1		
Beige.							
102828647		SET HAND G 4BM-03 BLACK					
N		EA	1	4	1		
102936887		SET HAND G 7BM-03 BLACK					
N		EA	1	4	1		

DISTRIBUTION SERVICES

SHELF

PRODUCT IDENTIFIER		DESCRIPTION				
ITEM NUMBER	ORD. MULT.	SELL UNIT	STD. PKG. STOCK AVAILABILITY / PA	LEAD TIME	MIN. ORD.	A C

SET OF GEARS

SEE GEAR.

NETWORK SERVICES

SHELF

260411962 SHELF STATIONARY 19IN 7206-E1A
N EA 1 3 1

001096056 SHELF SURFACE LAXX-KC TLPTR1000
N EA 1 2 1

002037380 SHELF SURFACE LAXX-KC TPTR1000
N EA 1 2 1

002052587 SHELF SURFACE LAXX-KC TPTR1000
N EA 1 2 1

002037406 SHELF SURFACE WIRE LAXX-KD
N EA 1 2 1
Wire shelf used as a paper handling device associated with teleprinter LAS12-CA and LAS12-CB.

001130863 SHELF SURFACE WORK LAXX/KC
1141770 1 EA IL IN MI OH WI
04 04 04 04
A shelf which may be mounted on the left or right side of teleprinter, LAS12-CA or LAS12-CB, to provide additional work surface.
DISCONTINUE UPON STOCK DEPLETION.

002052579 SHELF WIRE BASKET LAXX-KD PAPER
N EA 1 2 1

000238162 SHELF WIRE BASKET LAXX-KD TPTR
N EA 1 4 1

001096106 SHELF WIRE BASKET LAXX-NC
N EA 1 2 1

001199520 SHELF WIRE BASKET LAXX-NC PA DEC
N EA 1 3 1

000238196 SHELF WIRE BASKET LAXX-NC PAPER
N EA 1 3 1
Basket attached to printer to catch paper.

SIGN

280012956 SIGN 231 A
N EA 1 4 1

SIGN ROAD

260437561 SIGN FACE OVERLAY PATCH 'LEFT LANE'
N EA 1 4 1
Duralatch or Velcro P-04409 48IN.

260437553 SIGN FACE OVERLAY PATCH 'LEFT LANE'
N EA 1 4 1
Duralatch or Velcro P-04408 36IN.

TOOLS

BUILDING JANITORIAL

AUTOMOTIVE

FORMS/OFFICE SUPPLIES

GENERAL

DATA VOICE

PRODUCT IDENTIFIER		DESCRIPTION				
ITEM NUMBER	ORD. MULT.	SELL UNIT	STD. PKG. STOCK AVAILABILITY / PA	LEAD TIME	MIN. ORD.	A C

260437538 SIGN FACE OVERLAY PATCH 'LEFT LANE/CENTE'
N EA 1 4 1
R LANE' Duralatch or Velcro P-03931 36IN.

260437546 SIGN FACE OVERLAY PATCH 'LEFT LANE/CENTE'
N EA 1 4 1
R LANE' Duralatch or Velcro P-03930 48IN.

260437652 SIGN FACE OVERLAY PATCH 'SHOULDER' 36IN
N EA 1 4 1
P-03952.

260437660 SIGN FACE OVERLAY PATCH 'SHOULDER' 48IN
N EA 1 4 1
P-03953.

260437322 SIGN FACE - FLAGGER SYMBOL
N EA 1 4 1
Velcro SA-03643 48IN.

260437298 SIGN FACE - FLAGGER SYMBOL
N EA 1 4 1
Duralatch DL-03642 36IN.

260437314 SIGN FACE - FLAGGER SYMBOL
N EA 1 4 1
Duralatch DL-03643 48IN.

260437306 SIGN FACE - FLAGGER SYMBOL
N EA 1 4 1
Velcro SA-03642 36IN.

260440086 SIGN FACE - WORKER SYMBOL
N EA 1 4 1
Duralatch DL-03640 36IN.

260440094 SIGN FACE - WORKER SYMBOL
N EA 1 4 1
Duralatch DL-03641 48IN.

260440177 SIGN FACE - WORKER SYMBOL
N EA 1 4 1
Velcro SA-03640 36IN.

260440185 SIGN FACE - WORKER SYMBOL
N EA 1 4 1
Velcro SA-03641 48IN.

260449087 SIGN FACE 'END ROAD WORK'
N Duralatch DL-05079 48IN.

260437256 SIGN FACE 'FLAGGER AHEAD'
N EA 1 4 1
Duralatch DL-04094 36IN.

260437280 SIGN FACE 'FLAGGER AHEAD'
N EA 1 4 1
Velcro SA-04095 48IN.

260437272 SIGN FACE 'FLAGGER AHEAD'
N EA 1 4 1
Duralatch DL-04095 48IN.

PRODUCT IDENTIFIER							DESCRIPTION						
ITEM	ORD.	SELL	STD. PKG.	LEAD TIME	MIN.	A	ITEM	ORD.	SELL	STD. PKG.	LEAD TIME	MIN.	A
NUMBER	MULT.	UNIT	STOCK AVAILABILITY / PA		ORD.	C	NUMBER	MULT.	UNIT	STOCK AVAILABILITY / PA		ORD.	C
260437264 SIGN FACE 'FLAGGER AHEAD'													
N		EA	1	4	1		Velcro SA-04094 36IN.						
260437330 SIGN FACE 'LEFT LANE CLOSED-MERGE RIGHT'													
N		EA	1	4	1		Duralatch DL-04104 36IN.						
260437348 SIGN FACE 'LEFT LANE CLOSED-MERGE RIGHT'													
N		EA	1	4	1		Velcro SA-04104 36IN.						
260437363 SIGN FACE 'LEFT LANE CLOSED-MERGE RIGHT'													
N		EA	1	4	1		Velcro SA-04105 48IN.						
260437355 SIGN FACE 'LEFT LANE CLOSED-MERGE RIGHT'													
N		EA	1	4	1		Duralatch DL-04105 48IN.						
260440078 SIGN FACE 'ONE LANE ROAD AHEAD'													
N		EA	1	4	1		Duralatch DL-03650 48IN.						
260440060 SIGN FACE 'ONE LANE ROAD AHEAD'													
N		EA	1	4	1		Duralatch DL-03649 36IN.						
260440151 SIGN FACE 'ONE LANE ROAD AHEAD'													
N		EA	1	4	1		Velcro SA-03649 36IN.						
260440169 SIGN FACE 'ONE LANE ROAD AHEAD'													
N		EA	1	4	1		Velcro SA-03650 48IN.						
260440201 SIGN FACE 'RIGHT LANE CLOSED AHEAD'													
N		EA	1	4	1		Velcro SA-03658 48IN.						
260440110 SIGN FACE 'RIGHT LANE CLOSED AHEAD'													
N		EA	1	4	1		Duralatch DL-03658 Changeable Legends 48IN.						
260440193 SIGN FACE 'RIGHT LANE CLOSED AHEAD'													
N		EA	1	4	1		Velcro SA-03657 36IN.						
260440102 SIGN FACE 'RIGHT LANE CLOSED AHEAD'													
N		EA	1	4	1		Duralatch DL-03657 Changeable Legends 36IN.						
260437389 SIGN FACE 'RIGHT LANE CLOSED-MERGE LEFT'													
N		EA	1	4	1		Velcro SA-04102 36IN.						
260437371 SIGN FACE 'RIGHT LANE CLOSED-MERGE LEFT'													
N		EA	1	4	1		Duralatch DL-04102 36IN.						

PRODUCT IDENTIFIER							DESCRIPTION						
ITEM	ORD.	SELL	STD. PKG.	LEAD TIME	MIN.	A	ITEM	ORD.	SELL	STD. PKG.	LEAD TIME	MIN.	A
NUMBER	MULT.	UNIT	STOCK AVAILABILITY / PA		ORD.	C	NUMBER	MULT.	UNIT	STOCK AVAILABILITY / PA		ORD.	C
260437397 SIGN FACE 'RIGHT LANE CLOSED-MERGE LEFT'													
N		EA	1	4	1		Duralatch DL-04102 48IN.						
260437405 SIGN FACE 'RIGHT LANE CLOSED-MERGE LEFT'													
N		EA	1	4	1		Velcro SA-04102 48IN.						
260440219 SIGN FACE 'ROAD WORK AHEAD'													
N		EA	1	4	1		Velcro SA-04205 36IN. (Changeable legends).						
260440136 SIGN FACE 'ROAD WORK AHEAD'													
N		EA	1	4	1		Duralatch DL-04206 Changeable Legends 48IN.						
260440227 SIGN FACE 'ROAD WORK AHEAD'													
N		EA	1	4	1		Velcro SA-04206 48IN. (Changeable legends).						
260437439 SIGN FACE 'ROAD WORK AHEAD'													
N		EA	1	4	1		Duralatch DL-04097 48IN.						
260440128 SIGN FACE 'ROAD WORK AHEAD'													
N		EA	1	4	1		Duralatch DL-04205 Changeable Legends 36IN.						
260437421 SIGN FACE 'ROAD WORK AHEAD'													
N		EA	1	4	1		Velcro SA-04096 36IN.						
260437447 SIGN FACE 'ROAD WORK AHEAD'													
N		EA	1	4	1		Velcro SA-04097 48IN.						
260437413 SIGN FACE 'ROAD WORK AHEAD'													
N		EA	1	4	1		Duralatch DL-04096 36IN.						
260437488 SIGN FACE 'UTILITY WORK AHEAD'													
N		EA	1	4	1		Velcro SA-04204 48IN.						
260437470 SIGN FACE 'UTILITY WORK AHEAD'													
N		EA	1	4	1		Duralatch DL-04204 48IN.						
260437462 SIGN FACE 'UTILITY WORK AHEAD'													
N		EA	1	4	1		Velcro SA-04203 36IN.						
260437454 SIGN FACE 'UTILITY WORK AHEAD'													
N		EA	1	4	1		Duralatch DL-04203 36IN.						
260437520 SIGN FACE 'WORKERS AHEAD'													
N		EA	1	4	1		Velcro SA-04091 48IN.						
260437512 SIGN FACE 'WORKERS AHEAD'													
N		EA	1	4	1		Duralatch DL-04091 48IN.						

DISTRIBUTION SERVICES

NETWORK SERVICES

TOOLS

BUILDING JANITORIAL

AUTOMOTIVE

FORMS/OFFICE SUPPLIES

GENERAL

DATA VOICE

SIGN ROAD

DISTRIBUTION SERVICES

PRODUCT IDENTIFIER		DESCRIPTION				
ITEM NUMBER	ORD. MULT.	SELL UNIT	STD. PKG. STOCK AVAILABILITY / PA	LEAD TIME	MIN. ORD.	A C

260437504 SIGN FACE 'WORKERS AHEAD'
N EA 1 4 1
Velcro SA-03989 36IN.

NETWORK SERVICES

260437496 SIGN FACE 'WORKERS AHEAD'
N EA 1 4 1
Duralatch DL-03989 36IN.

PRODUCT IDENTIFIER		DESCRIPTION				
ITEM NUMBER	ORD. MULT.	SELL UNIT	STD. PKG. STOCK AVAILABILITY / PA	LEAD TIME	MIN. ORD.	A C

260441464 SIGN TRUCK MOUNT BRACKET SA-2626
N EA 1 4 1
Locks 4812 base in place.

260440144 SIGN TRUCK-MOUNT BRACKET-LOCKS
N EA 1 4 1
4814 Base In Place SA-03322.

SIGN ROAD ACCESSORIES

SIGN SAFETY

TOOLS

260437579 CROSSBRACE FOR 36IN SIGN
N EA 1 4 1
Velcro, no flags. SA-03630.

260437611 CROSSBRACE FOR 36IN SIGN
N EA 1 4 1
Duralatch, 3 flags. DLX-03592.

260437587 CROSSBRACE FOR 36IN SIGN
N EA 1 4 1
Duralatch, no flags. DLX-03630.

BUILDING JANITORIAL

260437629 CROSSBRACE FOR 36IN SIGN
N EA 1 4 1
Velcro, 3 flags. SA-03592.

260437603 CROSSBRACE FOR 48IN SIGN
N EA 1 4 1
Velcro, no flags. SA-03631.

AUTOMOTIVE

260437595 CROSSBRACE FOR 48IN SIGN
N EA 1 4 1
Duralatch, no flags. DLX-03631.

260437637 CROSSBRACE FOR 48IN SIGN
N EA 1 4 1
Duralatch, 3 flags. DLX-03593.

FORMS/OFFICE SUPPLIES

260437645 CROSSBRACE FOR 48IN SIGN
N EA 1 4 1
Velcro, 3 flags. SA-03593.

260437215 SIGN BRACKET FOR RIGID SIGN SA-01729
N EA 1 4 1
(SA does not imply Velcro).

260437223 SIGN BRACKET FOR ROLL-UP SIGN SA-05428
N EA 1 4 1
(SA does not imply Velcro in this case).

GENERAL

260348115 SIGN STORAGE BAG SA-03942
N EA 1 3 1
Holds two signs.

260348123 SIGN STORAGE BAG SA-04504
N EA 1 3 1
Holds one sign stand.

260437249 SIGN STORAGE BOX - DUAL COVERED SA-05441
N EA 1 4 1

DATA VOICE

260437231 SIGN STORAGE BOX - DUAL OPEN - SA-05440
N EA 1 4 1

280003658 SIGN 119 MZ 'HOLDER FOR EAR MUFFS'
N EA 1 4 3
Red letters on white, 14IN x 12IN wide.

280002643 SIGN 133 MZ 'CAUTION-HEARING PROTECTION'
N EA 1 4 4
NEEDED.' Red & white, 6IN tall X 12IN wide.

280013004 SIGN 133 QZ 'NO EXIT'
N EA 1 4 1
Red on white, 8IN X 12IN.

280011818 SIGN 134 EZ 'THIS DOOR MUST BE LOCKED'
N EA 1 4 1
5IN X 8IN.

280024696 SIGN 401A FLAME SYMBOL
N EA 1 4 1
Safety hazard sign, 11IN X 18IN.

280012964 SIGN 113 NZ CALENDAR THREE MONTH DISPLAY
N EA 1 4 1
29-5/8IN X 13-1/2IN wide.

280012980 SIGN 133GZ 'CAUTION - REMOVE JEWELRY'
N EA 1 4 1
9IN X 16IN.

280003625 SIGN 134BZ 'LOOK UP BEFORE MOVING'
N EA 1 4 15
Red letters on white, size - 7IN X 2 1/2IN.

280012972 SIGN 199DZ 'FIRST AID' KIT HOLDER
N EA 1 4 1
Rounded corners.

400268249 SIGN B CA07768 'NO SMOKING'
1138115 1 EA IL IN MI OH WI
33 33 33 33 33
Orange letters on white sign used in or near manholes consisting of an aluminum plate 15in x 5in with spring, BSP 620-135-100.

280011875 SIGN D140 'NO OPEN FLAME'
N EA 1 1 1
M Omni.

280002791 SIGN D140 'WARNING - EAR MUFFS NEEDED'
N EA 1 2 1

PRODUCT IDENTIFIER		DESCRIPTION					
ITEM NUMBER	ORD. MULT.	SELL UNIT	STD. PKG. STOCK AVAILABILITY / PA	LEAD TIME	MIN. ORD.	A C	
260384797 SIGN GS-13 'NO SMOKING'							
1962597		EA	IL 33 IN 33 MI OH WI 33				

280003641 SIGN WARNING HUSKY 36IN KIT						
N		EA	1	4		1
H1360-36 EG/AL, MEN WORKING.						

280012998 SIGN 'CABLE VAULT ENTRANCE'						
N		EA	1	4		1
Style 230A.						

280003666 SIGN 'CAUTION - AUTO START'						
N		EA	1	1		1
Black on orange, 10IN X 6IN.						

SILICONE FOAM

SEE FIRE BARRIER.

SOFTWARE

SEE SECTION 8.

SPRING

280024845 SPRING PACK F TYPE						
N		EA	1	1		1

STAND

260359054 STAND PRINTER 80 COLUMN						
1970459	1	EA				
Ring King, smoked gray acrylic 80 column printer stand.						

260358858 STAND PRINTER 132 COLUMN						
1970426	1	EA	IL 04 IN 04 MI OH WI			
Ring King, smoked gray acrylic 132 column printer stand.						

260420492 STAND PRINTER 6571/577						
N		EA	1	4		1
P/N64524274214.						

260422068 STAND PRINTER FOR 1324 PRINTER F/N1397						
1976019	1	EA	IL 03 IN MI OH WI 03			
Lee Data.						

STRIP POWER

400323929 STRIP POWER CK20129 L 1						
1163378	1	EA				
24 AC outlets on a 5ft power strip with mounting brackets and a 5ft cord.						

402574156 STRIP POWER CK22291 L1						
N		EA	1	3		1

PRODUCT IDENTIFIER		DESCRIPTION					
ITEM NUMBER	ORD. MULT.	SELL UNIT	STD. PKG. STOCK AVAILABILITY / PA	LEAD TIME	MIN. ORD.	A C	
260411954 STRIP POWER RACKMOUNT 6 POSITION							
N		EA	1	3		1	
#7219							

SUPPLIES MEDICAL

300061066 CLEANSER POISON OAK & IVY 4OZ						
6511212	1	EA				



300061066

402332018 CONTAINER E/W EYEDROPER CK20951						
N		EA	1	4		1

280012832 HOLDER BOTTLE EYEWASH 120BZ						
N		EA	1	2		1

402536049 KIT EYEWASH CK21527 L3						
1920637	1	KT	IL 33 IN 33 MI 33 OH 33 WI 33			
Eyewash kit for use in flushing foreign particles from eyes.						

280418728 KIT INFECTIOUS DISEASE						
1973602	1	EA	IL 34 IN 34 MI 34 OH 34 WI			
12-70-03.						

402536106 SOLUTION EYEWASH QUART CK21527 L4						
8143206	1	EA	IL 34 IN 34 MI 34 OH 34 WI			
A neutralizing eyewash solution in quart plastic bottle. Used to provide eyewash facilities on construction vehicles, 12 quart bottles per case.						

SUPPLY POWER

260411814 SUPPLY POWER 24V 10AMP FOR F/N5005						
1976647	1	EA				
For Datastar 5000.						

260411848 SUPPLY POWER 300W FOR F/N5010						
1976662	1	EA	IL 03 IN MI OH WI 03 03			
For Datastar 5000. P/N83200034.						

500031901 SUPPLY POWER 40PSU/101						
1178251	1	EA	IL 04 IN MI OH WI 04 04 04			

DISTRIBUTION SERVICES

NETWORK SERVICES

TOOLS

BUILDING JANITORIAL

AUTOMOTIVE

FORMS/OFFICE SUPPLIES

GENERAL

DATA VOICE

SUPPLY POWER

DISTRIBUTION SERVICES

PRODUCT IDENTIFIER		DESCRIPTION						
ITEM NUMBER	ORD. MULT.	SELL UNIT	STD. PKG. STOCK AVAILABILITY / PA	LEAD TIME	MIN. ORD.	A	C	

500044409 SUPPLY POWER 40PSU/102
 1216374 1 EA IL IN MI OH WI
 04 04 04 04 04

NETWORK SERVICES

260411871 SUPPLY POWER 600W FOR F/N5020
 1976688 1 EA IL IN MI OH WI
 03 03 03
 For Datastar 5000.

260385919 SUPPLY POWER 83200027
 N

TOOLS

260319702 SUPPLY POWER BASE
 1941518 1 EA IL IN MI OH WI
 04 04
 Lee data power supply, base unit controller only.

260319710 SUPPLY POWER EXPANSION
 1941526 1 EA IL IN MI OH WI
 04
 Lee data power supply, expansion unit controller only.

BUILDING JANITORIAL

260393889 SUPPLY POWER PCB 72507033
 1966499 1 EA IL IN MI OH WI
 03 03

SUPPRESSOR

280020587 SUPPRESSOR RINGING 90 VOLT AC
 N EA 1 2 1
 Elect Ext Ringer 187.

SWAB

260411632 SWAB 9300-0468
 N PK 1 1 1
 Hewlett Packard.

AUTOMOTIVE

SWITCH

260411889 SWITCH 16 X 16 FOR F/N5020
 1976621 1 EA
 For Datastar 5000.

260411822 SWITCH 4X4 W/BACKPLANE FOR F/N5005
 1976654 1 EA IL IN MI OH WI
 03 03 03
 For Datastar 5000. P/N80003960.

260411855 SWITCH 8 X 8 FOR F/N5010
 1976597 1 EA IL IN MI OH WI
 03
 For Datastar 5000.

FORMS/OFFICE SUPPLIES

260318282 SWITCH A-B BLACK BOX SW025A
 N EA 1 2 1
 DB-25 Full 25 Pin Switchable. Cust Acct # 003410040.

GENERAL

260368378 SWITCH A-B PARALLEL 25 PIN
 N EA 1 2 1

DATA VOICE

PRODUCT IDENTIFIER		DESCRIPTION						
ITEM NUMBER	ORD. MULT.	SELL UNIT	STD. PKG. STOCK AVAILABILITY / PA	LEAD TIME	MIN. ORD.	A	C	

400273942 SWITCH CK19504 L1
 2788927 1 EA IL IN MI OH WI
 04 04 04 04 04

A small switch with a face plate and an associated box to house the switch. Used as cutoff for ringers, bells, buzzers, battery supply, etc.

TABLE

500047584 TABLE 45CAB502/AAA 45IN
 1128959 1 EA
 Used for Dataspeed 4540 service.

500047592 TABLE 45CAB503/AAA
 N EA 1 5 1

TAPE

260447131 TAPE BACKUP MAYNARD 60MB P/N 10508
 N
 Internal unit, software included. For MCA Business Machines only.

260413752 TAPE CARTRIDGE 3480 CARLISLE MTC PLUS
 N EA 1 1 210

260413760 TAPE CARTRIDGE 3480 EPOCH MTC
 N EA 1 1 210

260437678 TAPE GUMMED FILAMENT KRAFT 3IN
 N CS 10 3 120

260433081 TAPE ISLE MARKING 2IN X 54FT
 N RL 1 4 1
 Roll - yellow and black striped.

260433099 TAPE ISLE MARKING 3IN X 54FT
 N RL 1 4 1
 Roll - yellow and black striped.

260413778 TAPE MAGNETIC REEL 1200FT SEAL
 N EA 1 1 200
 Carlisle Summit.

260413786 TAPE MAGNETIC REEL 2400FT SEAL
 N EA 1 1 500
 Carlisle Summit.

TAPE PICS

260302302 TAPE PICS IN ORANGE/WHITE 2IN
 1939140 1 RO

280099599 TAPE PICS IN ORANGE/WHITE 3IN
 1937706 1 CS IL IN MI OH WI
 ADC ORDER ITEM ONLY.

260347885 TAPE PICS IS GREEN/BLACK 3IN
 1163303 1 RO IL IN MI OH WI
 32

PRODUCT IDENTIFIER		DESCRIPTION					
ITEM NUMBER	ORD. MULT.	SELL UNIT	STD. PKG. STOCK AVAILABILITY / PA	LEAD TIME		MIN. ORD.	A C
260301759	1	RO	IL IN MI OH WI	09			
1936688 TAPE PICS MI BLUE/WHITE 2IN							
280099607	1	CS	IL IN MI OH WI				
1937714 TAPE PICS MI BLUE/WHITE 3IN							
ADC ORDER ITEM ONLY.							
260330600	1	RO	IL IN MI OH WI	32			
1947010 TAPE PICS OH PURPLE/WHITE 2IN							
260322185	1	RO	IL IN MI OH WI	32			
1942714 TAPE PICS WI YELLOW/WHITE 2IN							
260320403	1	RO	IL IN MI OH WI				
1942060 TAPE PICS WI YELLOW/WHITE 3IN							
260343108	1	RO	IL IN MI OH WI	32			
1949990 TAPE PICS 'FRAGILE' 2IN							
260338264	1	RO	IL IN MI OH WI				
1948075 TAPE PICS 'FRAGILE' 3IN							
ADC ORDER ITEM ONLY.							
260369129	1	RO	IL IN MI OH WI				
1955757 TAPE PICS -'ADC-FOR PICS INVENTORY ONLY'							
Self adhesive.							

TELEPRINTER							
260000377	1	EA					
1996058 TELEPRINTER 1000R0							
500047113		EA	1	5	1		
N TELEPRINTER 4310AAA							
500047261		EA	1	5	1		
N TELEPRINTER 4310AAE							
500047279		EA	1	5	1		
N TELEPRINTER 4310AAF							
500047287		EA	1	5	1		
N TELEPRINTER 4310AAH							
500047295	1	EA	IL IN MI OH WI	01 01 01 01			
1311993 TELEPRINTER 4320AAA							
500047303		EA	1	5	1		
N TELEPRINTER 4320AAE							
500047311		EA	1	5	1		
N TELEPRINTER 4320AAF							
500046909		EA	1	5	1		
N TELEPRINTER 4320AAK							

PRODUCT IDENTIFIER		DESCRIPTION					
ITEM NUMBER	ORD. MULT.	SELL UNIT	STD. PKG. STOCK AVAILABILITY / PA	LEAD TIME		MIN. ORD.	A C
500047345		EA	1	5	1		
N TELEPRINTER 4320AAL							
002037372	1	EA	IL IN MI OH WI	01 01 01			
1219626 TELEPRINTER LAS12-CA							
002037364	1	EA	IL IN MI OH WI	01 01			
1141614 TELEPRINTER LAS12-CB							

TEMPLATE							
260420484		EA	1	4	1		
N TEMPLATE KEYBOARD 652X/653X 64523486041							

TOOTHPICK							
401009857		CS					
5264929 TOOTHPICK FLAT 4							
401047261	1	CS	IL IN MI OH WI	33 33 33 33 33			
1278267 TOOTHPICK ROUND							

TP NUMBERED PARTS							
520035999	TP 3599	NUT					
N	EA	1	4	292			
520036401	TP 3640	WASHER					
N	EA	1	4	3500			
520070020	TP 7002	WASHER					
N	EA	1	4	1750			
520413824	TP 41382	SPRING					
N	EA	1	4	700			
524522240	TP 52224	CABLE					
N	EA	1	5	2			
520805813	TP 80581	SPRING					
N	EA	1	4	700			
260379912	TP100076	WINDER PAPER					
N	EA	1	4	1			
521196485	TP119648	RETAINING RING					
N	EA	3500	4	3500			
521196493	TP119649	RING					
1111278	1	EA	IL IN MI OH WI	04 04 04			
DISCONTINUE, ORDER NON STOCK UPON STOCK DEPLETION							
521196519	TP119651	RETAINING RING					
N	EA	1	4	1750			

DISTRIBUTION SERVICES
 NETWORK SERVICES
 TOOLS
 BUILDING JANITORIAL
 AUTOMOTIVE
 FORMS/OFFICE SUPPLIES
 GENERAL
 DATA VOICE

TP NUMBERED PARTS

DISTRIBUTION SERVICES

PRODUCT IDENTIFIER		DESCRIPTION				
ITEM NUMBER	ORD. MULT.	SELL UNIT	STD. PKG. STOCK AVAILABILITY / PA	LEAD TIME	MIN. ORD.	A C
521196527	TP119652	E	RING			
N		EA	1	4	1750	

NETWORK SERVICES

521196535	TP119653	R	RETAINING RING			
N		EA	1750	4	1750	
521201392 TP120139 FUSE						
1418244	1	EA	IL 04 IN 04 MI 04 OH 04 WI 04			
DISCONTINUE, ORDER NON STOCK UPON STOCK DEPLETION						

TOOLS

521250159	TP125015	W	WASHER			
N		EA	1	4	875	
521299198 TP129919 FUSE						
1342329	1	EA	IL 04 IN 04 MI 04 OH 04 WI 04			
Used to protect printer & other electrical items from harmful electrical voltages. DISCONTINUE, ORDER NON STOCK UPON STOCK DEPLETION						

BUILDING JANITORIAL

521299206	TP129920	F	FUSE			
N		EA	1	4	40	
521425546	TP142554	H	HOOK			
N		EA	1	2	14	
521425553 TP142555 HOOK						
5357566	1	EA	IL 04 IN 04 MI 04 OH 04 WI 04			
DISCONTINUE, ORDER NON STOCK UPON STOCK DEPLETION						

AUTOMOTIVE

521433060	TP143306	F	FUSE			
1140277	1	EA	IL 04 IN 04 MI 04 OH 04 WI 04			
Protection from harmful electrical voltage. DISCONTINUE, ORDER NON STOCK UPON STOCK DEPLETION						

FORMS/OFFICE SUPPLIES

521433078	TP143307	F	FUSE			
N		EA	1	4	40	
521500256	TP150025	C	CLUTCH			
N		EA	1	5	1	
521500439	TP150043	S	SHOE			
N		EA	1	2	1	
521500447	TP150044	S	SHOE			
N		EA	1	2	7	
521511527	TP151152	S	SCREW			
N		EA	1	4	1750	

GENERAL

521513945	TP151394	B	BRUSH			
1132456	1	EA	IL 04 IN 04 MI 04 OH 04 WI 04			
DISCONTINUE, ORDER NON STOCK UPON STOCK DEPLETION						

DATA VOICE

521592840	TP159284	G	GEAR			
N		EA	1	2	11	

PRODUCT IDENTIFIER		DESCRIPTION				
ITEM NUMBER	ORD. MULT.	SELL UNIT	STD. PKG. STOCK AVAILABILITY / PA	LEAD TIME	MIN. ORD.	A C

521592857	TP159285	G	GEAR			
N		EA	1	4	1	
521925693	TP192569	S	SELR ASSEMBLY			
N		EA	1	4	1	
521926386	TP192638	S	SHAFT			
N		EA	1	4	1	
521950030	TP195003	S	SHAFT ASSEMBLY			
N		EA	1	4	1	
521952515	TP195251	A	ARMT			
N		EA	1	4	2	
521974642	TP197464	D	DIODE			
N		EA	1	4	292	
523047405	TP304740	H	HEAD ASSEMBLY			
N		EA	1	4	7	
523159895	TP315989	R	RESISTOR			
N		EA	1	4	270	
523188225	TP318822	T	TRANSISTOR			
N		EA	1	4	5	
523188357	TP318835	T	TRANSISTOR			
N		EA	1	4	17	
523215333	TP321533	C	CAPACITOR			
N		EA	1	4	18	

523219558 TP321955 FUSE						
1190439	1	EA	IL 04 IN 04 MI 04 OH 04 WI 04			
Protection from harmful electrical voltage. DISCONTINUE, ORDER NON STOCK UPON STOCK DEPLETION						

523335883	TP333588	L	LAMP CONTROL PANEL			
N		EA	1	4	15	
523407013	TP340701	K	KEYTOP			
N		EA	1	4	61	

523407146 TP340714 KEYTOP						
2614222	1	EA	IL 04 IN 04 MI 04 OH 04 WI 04			
DISCONTINUE, ORDER NON STOCK UPON STOCK DEPLETION						

523407203 TP340720 KEYSWITCH						
2614248	1	EA	IL 04 IN 04 MI 04 OH 04 WI 04			

523407211 TP340721 KEYSWITCH						
1230987	1	EA	IL 04 IN 04 MI 04 OH 04 WI 04			
A repeat keyswitch for a model 40 printer.						

PRODUCT IDENTIFIER		DESCRIPTION					
ITEM NUMBER	ORD. MULT.	SELL UNIT	STD. PKG. STOCK AVAILABILITY / PA	LEAD TIME	MIN. ORD.	A C	
523407229 TP340722 KEYSWITCH							
1191650	1	EA	IL 04 IN 04 MI 04 OH 04 WI 04				
A latching keyswitch for a model 40 printer. DISCONTINUE, ORDER NON STOCK UPON STOCK DEPLETION							
523408193 TP340819 KEYTOP SCREW UP							
N		EA	1	2	61		
523408268 TP340826 KEYTOP							
N		EA	1	2	61		
523408367 TP340836 KEYTOP SCREW DOWN							
N		EA	1	2	61		
523408896 TP340889 KEYTOP							
N		EA	1	2	61		
523408904 TP340890 KEYTOP							
N		EA	1	4	61		
523408946 TP340894 KEYTOP							
N		EA	1	4	61		
523408953 TP340895 KEYTOP SEG ADV							
N		EA	1	4	61		
523408987 TP340898 KEYTOP							
N		EA	1	4	26		
523415024 TP341502 TUBE							
N		EA	1	11	1		
523415461 TP341546 FASTENER DRIVE							
N		EA	1	4	587		
523415594 TP341559 CABLE ASSEMBLY							
N		EA	1	4	5		
523415685 TP341568 TRANSISTOR							
N		EA	1	4	9		
523415693 TP341569 TRANSISTOR							
N		EA	1	4	11		
523415701 TP341570 TRANSISTOR							
N		EA	1	4	5		
523415800 TP341580 SUPPORT							
N		EA	1	4	219		
523416477 TP341647 TERMINAL							
N		EA	1	4	67		
300008869 TP341648 TERMINAL							
N		EA	1	2	66		
523416550 TP341655 KNOB							
N		EA	1	4	292		
523416865 TP341686 FUSE							
N		EA	1	4	1		
Protection from harmful electrical voltage.							

PRODUCT IDENTIFIER		DESCRIPTION					
ITEM NUMBER	ORD. MULT.	SELL UNIT	STD. PKG. STOCK AVAILABILITY / PA	LEAD TIME	MIN. ORD.	A C	
523417970 TP341797 SCREW							
N		EA	1	4	700		
523418937 TP341893 CABLE NON EXT							
N		EA	1	2	1		
523418952 TP341895 CABLE PRINTER							
N		EA	1	2	1		
523456036 TP345603 CABLE							
N		EA	1	2	1		
523461036 TP346103 KEYTOP S/R							
N		EA	1	2	61		
523461044 TP346104 KEYTOP							
N		EA	61	2	61		
523461051 TP346105 KEYTOP							
N		EA	1	2	61		
523461069 TP346106 KEYTOP							
N		EA	1	5	61		
523461077 TP346107 KEYTOP							
N		EA	1	4	26		
523461085 TP346108 KEYTOP							
N		EA	1	4	26		
523461101 TP346110 KEYTOP TAB SET							
N		EA	1	4	61		
523461119 TP346111 KEYTOP							
N		EA	1	4	61		
523461218 TP346121 KEYTOP							
N		EA	1	4	26		
523462117 TP346211 KEY SWITCH							
N		EA	1	2	2		
300008877 TP346359 KEY SWITCH							
1159418	1	EA	IL 04 IN 04 MI 04 OH 04 WI 04				
523467314 TP346731 SHIELD 132 COLUMN PRINTER							
N		EA	1	10	1		
523467322 TP346732 SHIELD 80 COLUMN PRINTER							
N		EA	1	10	1		
524001013 TP400101 HAMR BANK ASSEMBLY							
N		EA	1	4	1		
524001385 TP400138 SPRING RETURN							
N		EA	1	4	14		
524001575 TP400157 ANTIFREEZE STRIP							
N		EA	1	4	60		
524002268 TP400226 SPRING							
N		EA	1	4	72		

DISTRIBUTION SERVICES
 NETWORK SERVICES
 TOOLS
 BUILDING JANITORIAL
 AUTOMOTIVE
 FORMS/OFFICE SUPPLIES
 GENERAL
 DATA VOICE

TP NUMBERED PARTS

DISTRIBUTION SERVICES

PRODUCT IDENTIFIER		DESCRIPTION					
ITEM NUMBER	ORD. MULT.	SELL UNIT	STD. PKG. STOCK AVAILABILITY / PA	LEAD TIME	MIN. ORD.	A	C

524002755 TP400275 ARM BANK ASSEMBLY
N EA 1 13 1

524003779 TP400377 FRONT/CASTING
N EA 1 13 1

NETWORK SERVICES

524004504 TP400450 ROLLER
1117887 1 EA IL IN MI OH WI
04 04 04 04
DISCONTINUE, ORDER NON STOCK UPON STOCK DEPLETION

524004702 TP400470 LINE FEED ASSEMBLY
N EA 1 5 1

260376363 TP400524 STRAP MARKER
N EA 1 2 1

524005980 TP400598 CABLE ASSEMBLY
N EA 1 4 3

524006210 TP400621 SSI ASSEMBLY/CABLE
N EA 1 4 1

TOOLS

BUILDING JANITORIAL

524006293 TP400629 TYPECARRIER
1186437 1 EA IL IN MI OH WI
04 04 04 04 04

524006301 TP400630 BELT
2633602 1 EA IL IN MI OH WI
04 04 04 04 04

524006319 TP400631 BELT
2633628 1 EA IL IN MI OH WI
04 04 04 04 04

524006327 TP400632 BELT
2633644 1 EA IL IN MI OH WI
04 04 04 04 04
Belt toothed used for model 40 printer as line feed clutch belt.

AUTOMOTIVE

FORMS/OFFICE SUPPLIES

524006343 TP400634 BELT
2633669 1 EA IL IN MI OH WI
04 04 04 04 04

524006350 TP400635 BELT
1182212 1 EA IL IN MI OH WI
04 04 04 04 04

GENERAL

524006459 TP400645 TYPECARRIER
1131474 1 EA IL IN MI OH WI
04 04 04 04 04

524006525 TP400652 BELT LINE FEED MECHANICAL
N EA 1 13 35

524007754 TP400775 TYPECARRIER
1402420 1 EA IL IN MI OH WI
04 04 04 04
DISCONTINUE, ORDER NON STOCK UPON STOCK DEPLETION

DATA VOICE

PRODUCT IDENTIFIER		DESCRIPTION					
ITEM NUMBER	ORD. MULT.	SELL UNIT	STD. PKG. STOCK AVAILABILITY / PA	LEAD TIME	MIN. ORD.	A	C

524007770 TP400777 TYPECARRIER
1225599 1 EA IL IN MI OH WI
04 04 04 04 04
Typecarrier for Dataspeed 40, 132 column, printer. Used for Dataspeed 40 service.

524007788 TP400778 TYPECARRIER
N EA 1 5 1
DISCONTINUE, ORDER NON STOCK UPON STOCK DEPLETION

524007804 TP400780 TYPECARRIER
1149377 1 EA IL IN MI OH WI
04 04 04 04 04

524007838 TP400783 TYPECARRIER
1158543 1 EA IL IN MI OH WI
04 04 04 04 04

524007846 TP400784 TYPECARRIER
1175422 1 EA IL IN MI OH WI
04 04 04 04 04

524007853 TP400785 TYPECARRIER
1115451 1 EA IL IN MI OH WI
04 04 04 04 04

524008877 TP400887 TYPECARRIER
1146324 1 EA IL IN MI OH WI
04 04 04 04 04

524009982 TP400998 LINEFEED ASSEMBLY
N EA 1 13 2
Magnet.

524011079 TP401107 MASK
N EA 1 4 4

524012002 TP401200 COPYHOLDER
N EA 1 4 1

524015203 TP401520 MODULE
N EA 1 13 1

524015310 TP401531 TOP
N EA 1 5 2

524015328 TP401532 TOP TABLE 29IN
N EA 1 5 2

524015336 TP401533 TABLE TOP
N EA 1 5 2

524016409 TP401640 CABLE PRIN EXT
N EA 1 2 2

524016417 TP401641 CABLE OPCON
N EA 1 2 2

524016433 TP401643 CABLE CON
N EA 1 2 1

524016821 TP401682 STRAP
N EA 1 13 5

PRODUCT IDENTIFIER		DESCRIPTION					
ITEM NUMBER	ORD. MULT.	SELL UNIT	STD. PKG. STOCK AVAILABILITY / PA	LEAD TIME	MIN. ORD.	A	C
524019114 TP401911 TOP TABLE							
N		EA	1	5	2		
524019122 TP401912 TOP							
N		EA	1	5	2		
524019130 TP401913 TOP							
1177238	1	EA	IL 04 IN 04 MI 04 OH 04 WI 04				
DISCONTINUE, ORDER NON STOCK UPON STOCK DEPLETION							
524019148 TP401914 TOP							
N		EA	1	5	2		
524019155 TP401915 TOP							
N		EA	1	5	2		
524024023 TP402402 MOTOR							
1130047	1	EA	IL 04 IN 04 MI 04 OH 04 WI 04				
524024080 TP402408 CAB ASSEMBLY							
N		EA	1	4	1		
524024205 TP402420 RIBBON FEED							
1230318	1	EA	IL 04 IN 04 MI 04 OH 04 WI 04				
524024445 TP402444 PRINTER RIBBON							
4211805	1	EA	IL 04 IN 04 MI 04 OH 04 WI 04				
524024601 TP402460 ASSEMBLY TRACTOR							
N		EA	1	2	1		
524024726 TP402472 GEAR							
N		EA	1	4	8		
300009479 TP402477 KNOB							
N		EA	1	2	7		
524025079 TP402507 TRACTOR FEED							
1141432	1	EA	IL 04 IN 04 MI 04 OH 04 WI 04				
524025087 TP402508 TRACTOR FEED							
1126892	1	EA	IL 04 IN 04 MI 04 OH 04 WI 04				
524025707 TP402570 ASSEMBLY FORM OUT							
1185181	1	EA	IL 04 IN 04 MI 04 OH 04 WI 04				
Mechanical assembly for TTY printer.							
524025715 TP402571 BELT							
N		EA	1	2	1		
524025723 TP402572 BELT							
5153767	1	EA	IL 04 IN 04 MI 04 OH 04 WI 04				
Print belt for TTY printer. DISCONTINUE, ORDER NON STOCK UPON STOCK DEPLETION							

PRODUCT IDENTIFIER		DESCRIPTION					
ITEM NUMBER	ORD. MULT.	SELL UNIT	STD. PKG. STOCK AVAILABILITY / PA	LEAD TIME	MIN. ORD.	A	C
524025764 TP402576 BELT							
N		EA	1	4	7		
524025772 TP402577 BELT							
N		EA	1	5	7		
524025780 TP402578 BELT 8 1/2 FFO							
N		EA	1	2	7		
DISCONTINUE, ORDER NON STOCK UPON STOCK DEPLETION							
524025863 TP402586 BELT SET							
N		EA	1	2	1		
524025871 TP402587 BELT SET							
N		EA	1	5	2		
Model 40 tractor.							
524026135 TP402613 SWITCH ASSEMBLY							
1152751	1	EA	IL 04 IN 04 MI 04 OH 04 WI 04				
For power control to TTY printer. DISCONTINUE, ORDER NON STOCK UPON STOCK DEPLETION							
524026218 TP402621 SWITCH ASSEMBLY							
1162339	1	EA	IL 04 IN 04 MI 04 OH 04 WI 04				
524026606 TP402660 PAPER HANDLING ASSEMBLY							
1142190	1	EA	IL 04 IN 04 MI 04 OH 04 WI 04				
524026861 TP402686 PARTS/SHIELD							
1407627	1	EA	IL 04 IN 04 MI 04 OH 04 WI 04				
524027588 TP402758 BAR BACK UP							
N		EA	1	2	1		
300008885 TP402778 INDICATOR							
N		EA	1	2	110		
300008893 TP402779 CORD							
N		EA	1	2	1		
300008919 TP402781 ADAPTER							
N		EA	1	2	1		
300008901 TP402782 PLUG							
N		EA	1	2	1		
524027984 TP402798 SHIELD							
1202770	1	EA	IL 04 IN 04 MI 04 OH 04 WI 04				
Used to protect printer from foreign objects and/or substances.							
524028404 TP402840 EXTRACTOR							
1432823	1	EA	IL 04 IN 04 MI 04 OH 04 WI 04				
Used to feed paper through TTY printer. DISCONTINUE, ORDER NON STOCK UPON STOCK DEPLETION							

DISTRIBUTION SERVICES
 NETWORK SERVICES
 TOOLS
 BUILDING JANITORIAL
 AUTOMOTIVE
 FORMS/OFFICE SUPPLIES
 GENERAL
 DATA VOICE

TP NUMBERED PARTS

DISTRIBUTION SERVICES

PRODUCT IDENTIFIER		DESCRIPTION						
ITEM NUMBER	ORD. MULT.	SELL UNIT	STD. PKG. STOCK AVAILABILITY / PA	LEAD TIME			MIN. ORD.	A C
524028776 TP402877 BELT								
1417345	1	EA		IL 04	IN 04	MI 04	OH 04	WI 04

NETWORK SERVICES

524029360	TP402936	MOD KIT						
N		EA	1			4		11
524029451	TP402945	BRACKET & MASK						
N		EA	1			2		1
260390711	TP403158	KIT						
N		EA	1			4		1

TOOLS

260390729	TP403159	KIT						
N		EA	1			4		1
524033990	TP403399	MOD KIT						
N		EA	1			13		2
524034006	TP403400	MOD KIT						
N		EA	1			4		1

BUILDING JANITORIAL

524034048	TP403404	CABLE						
N		EA	1			13		2
524035672	TP403567	MOD KIT/HOLDER						
N		EA	1			13		2
524037850 TP403785 FAN BT2A1 BISCUIT								
1170472	1	EA		IL 04	IN 04	MI 04	OH 04	WI 04

AUTOMOTIVE

524048998	TP404899	CKT INTEG						
N		EA	1			4		10
524050507	TP405050	DIST ASSEMBLY						
N		EA	1			13		1
524051398	TP405139	CABLE						
N		EA	1			13		1

FORMS/OFFICE SUPPLIES

524051406	TP405140	CABLE						
N		EA	1			13		1
524052370	TP405237	CABLE						
N		EA	1			4		2
524052388	TP405238	CABLE						
N		EA	1			4		2

GENERAL

524052396	TP405239	CABLE						
N		EA	1			4		2
524052479	TP405247	CABLE						
N		EA	1			5		389
524053014	TP405301	CABLE						
N		EA	1			4		1

DATA VOICE

524053022	TP405302	CABLE						
N		EA	1			4		1

PRODUCT IDENTIFIER		DESCRIPTION						
ITEM NUMBER	ORD. MULT.	SELL UNIT	STD. PKG. STOCK AVAILABILITY / PA	LEAD TIME			MIN. ORD.	A C

524053030	TP405303	CABLE						
N		EA	1			4		1

524053048	TP405304	CABLE						
N		EA	1			4		1

524053063	TP405306	CABLE						
N		EA	1			5		2

524053089	TP405308	CABLE						
N		EA	1			4		2

524053113	TP405311	CABLE						
N		EA	1			13		2

524053725	TP405372	CABLE						
N		EA	1			4		1

524053899	TP405389	CABLE TERMINAL BOX						
N		EA	1			2		2

524053907	TP405390	TERMINAL BLOCK						
N		EA	1			13		1

524055449	TP405544	PAPER RACK						
N		EA	1			4		3

524055571	TP405557	FOOT						
N		EA	1			5		3

524055639	TP405563	SET OF PARTS						
N		EA	1			2		1

524056116	TP405611	POWER CORD						
N		EA	1			2		9

524056710	TP405671	SET OF PARTS						
N		EA	1			5		1

524058294	TP405829	MOUNTING BRACKET						
N		EA	1			4		6

524060365	TP406036	CABLE ASSEMBLY						
N		EA	1			2		1

524060399	TP406039	CABLE ASSEMBLY						
N		EA	1			13		1

524060472	TP406047	MOD KIT						
N		EA	1			2		2

524061900 TP406190 SET OF PARTS:								
1180422	1	EA		IL 04	IN 04	MI 04	OH 04	WI 04
DISCONTINUE ORDER NON STOCK UPON STOCK DEPLETION								

524062049	TP406204	MOD KIT						
N		EA	1			5		1

524062734	TP406273	MOD KIT						
N		EA	1			4		5

PRODUCT IDENTIFIER		DESCRIPTION					
ITEM NUMBER	ORD. MULT.	SELL UNIT	STD. PKG. STOCK AVAILABILITY / PA	LEAD TIME	MIN. ORD.	A	C
524063187 TP406318 SSI CABLE 500FT REEL							
1168278	1	SL	IL 04	IN 04	MI 04	OH 04	WI 04
Cable for Dataspeed 4540 Installation, BSP 582-300-200.							
524063195 TP406319 CABLE 2000FT REEL							
1173518	1	SL	IL 04	IN 04	MI 04	OH 04	WI 04
524063708 TP406370 MOD KIT FM ACC							
N		EA	1		5		1
524070240 TP407024 MOD KIT							
N		EA	1		5		1
524070257 TP407025 SET OF PARTS							
N		EA	1		5		1
524070265 TP407026 SET OF PARTS							
N		EA	1		5		1
524070422 TP407042 SET OF PARTS							
N		EA	1		5		4
524070430 TP407043 SET OF PARTS							
N		EA	1		2		1
524070885 TP407088 SWITCH							
1227272	1	EA	IL 04	IN 04	MI 04	OH 04	WI 04
Part of 407090 AC sw assm, late design, on 40CAB302/22. Printer cabinet core for forms access. Used for repair, BSP 582-212-700. DISCONTINUE, ORDER NON STOCK UPON STOCK DEPLETION.							
524070901 TP407090 AC SWTCH ASSEMBLY							
N		EA	1		4		1
524071008 TP407100 SET OF PARTS							
N		EA	1		5		1
524072162 TP407216 HOLDERS							
1188995	1	EA	IL 04	IN 04	MI 04	OH 04	WI 04
524072857 TP407285 DISTR AC PANEL ASSEMBLY							
1213819	1	EA	IL 04	IN 04	MI 04	OH 04	WI 04
524080157 TP408015 FAN ASSEMBLY							
N		EA	1		2		1
524080504 TP408050 FAN ASSEMBLY							
N		EA	1		2		1
524080652 TP408065 DATASET CABLE							
N		EA	1		4		1
524080660 TP408066 CABLE							
N		EA	1		5		1
524080819 TP408081 LABEL							
N		EA	1		4		27

PRODUCT IDENTIFIER		DESCRIPTION					
ITEM NUMBER	ORD. MULT.	SELL UNIT	STD. PKG. STOCK AVAILABILITY / PA	LEAD TIME	MIN. ORD.	A	C
524083938 TP408393 TYPECARRIER							
N		EA	1		2		1
524085222 TP408522 TYPE CARRIER							
N		EA	1		2		1
524086469 TP408646 TEST ASSEMBLY							
N		EA	1		13		1
524089620 TP408962 KEYSWITCH							
N		EA	1		13		2
524100013 TP410001 CIRCUIT CARD							
N		EA	1		4		1
524100021 TP410002 CIRCUIT CARD							
N		EA	1		13		1
524100039 TP410003 CIRCUIT CARD							
N		EA	1		13		1
524100146 TP410014 CIRCUIT CARD							
N		EA	1		2		1
524100153 TP410015 CIRCUIT CARD							
N		EA	1		2		1
524100187 TP410018 CIRCUIT CARD							
N		EA	1		2		1
524100195 TP410019 CIRCUIT CARD							
N		EA	1		13		1
REPLACES TP410155 CIRCUIT CARD							
524100716 TP410071 CIRCUIT CARD							
1175414	1	EA	IL 04	IN 04	MI 04	OH 04	WI 04
524100724 TP410072 CIRCUIT CARD							
1176354	1	EA	IL 04	IN 04	MI 04	OH 04	WI 04
524106408 TP410076 CIRCUIT CARD							
N		EA	1		5		1
524100765 TP410076 CIRCUIT CARD							
1128256	1	EA	IL 04	IN 04	MI 04	OH 04	WI 04
524101102 TP410110 CIRCUIT CARD							
1228262	1	EA	IL 04	IN 04	MI 04	OH 04	WI 04
524101409 TP410140 CIRCUIT CARD							
N		EA	1		2		1
524101417 TP410141 CIRCUIT CARD							
1201327	1	EA	IL 04	IN 04	MI 04	OH 04	WI 04
DISCONTINUE, ORDER NON STOCK UPON STOCK DEPLETION							
524101425 TP410142 CIRCUIT CARD ASSEMBLY							
N		EA	1		4		1

DISTRIBUTION SERVICES

NETWORK SERVICES

TOOLS

BUILDING JANITORIAL

AUTOMOTIVE

FORMS/OFFICE SUPPLIES

GENERAL

DATA VOICE

TP NUMBERED PARTS

DISTRIBUTION SERVICES

PRODUCT IDENTIFIER		DESCRIPTION						
ITEM NUMBER	ORD. MULT.	SELL UNIT	STD. PKG. STOCK AVAILABILITY / PA	LEAD TIME	MIN. ORD.	A	C	

524101508 TP410150 CIRCUIT CARD
 1132738 1 EA IL IN MI OH WI
 04 04 04 04
 Printer interface card. DISCONTINUE, ORDER NON STOCK UPON STOCK DEPLETION

NETWORK SERVICES

524101516 TP410151 CIRCUIT CARD ASSEMBLY
 N EA 1 2 1

524102654 TP410265 CIRCUIT CARD
 N EA 1 13 1

524102878 TP410287 CIRCUIT CARD
 N EA 1 13 1

TOOLS

524102910 TP410291 CIRCUIT CARD
 N EA 1 13 1

524103116 TP410311 CIRCUIT CARD
 N EA 1 2 1

BUILDING JANITORIAL

524103132 TP410313 CIRCUIT CARD
 1129395 1 EA IL IN MI OH WI
 04 04 04 04 04

524103140 TP410314 CIRCUIT CARD
 N EA 1 13 1

524103199 TP410319 CIRCUIT CARD
 N EA 1 5 1

AUTOMOTIVE

524103520 TP410352 CIRCUIT CARD
 N EA 1 13 1

524103538 TP410353 CIRCUIT CARD
 N EA 1 13 1

524104007 TP410400 CIRCUIT CARD
 N EA 1 13 1

FORMS/OFFICE SUPPLIES

524104015 TP410401 CIRCUIT CARD
 N EA 1 13 1

524104064 TP410406 CIRCUIT CARD
 N EA 1 6 1

260000385 TP410411 CIRCUIT CARD
 N EA 1 3 1

GENERAL

524104320 TP410432 CIRCUIT CARD
 N EA 1 2 1

524104346 TP410434 CIRCUIT CARD
 N EA 1 6 1

524104361 TP410436 CIRCUIT CARD
 N EA 1 5 1

524104619 TP410461 CIRCUIT CARD
 N EA 1 2 1

DATA VOICE

524104643 TP410464 CIRCUIT CARD
 N EA 1 5 1

PRODUCT IDENTIFIER		DESCRIPTION						
ITEM NUMBER	ORD. MULT.	SELL UNIT	STD. PKG. STOCK AVAILABILITY / PA	LEAD TIME	MIN. ORD.	A	C	

524104650 TP410465 CIRCUIT CARD
 N EA 1 2 1

524105095 TP410509 CIRCUIT CARD
 N EA 1 13 1

300009057 TP410524 CIRCUIT CARD ASSEMBLY
 N EA 1 2 1

524105251 TP410525 CIRCUIT CARD
 N EA 1 13 1

524106564 TP410656 CIRCUIT CARD ASSEMBLY
 1194811 1 EA IL IN MI OH WI
 04 04 04 04 04

524106572 TP410657 CIRCUIT CARD ASSEMBLY
 1152926 1 EA IL IN MI OH WI
 04 04 04 04 04
 A circuit card for a dataspeed 40/0. DISCONTINUE, ORDER NON STOCK UPON STOCK DEPLETION

524106705 TP410670 CIRCUIT CARD ASSEMBLY
 N EA 1 4 1

524106713 TP410671 CIRCUIT CARD
 N EA 1 2 1

524106721 TP410672 CIRCUIT CARD
 1225094 1 EA IL IN MI OH WI
 04 04 04 04 04
 DISCONTINUE, ORDER NON STOCK UPON STOCK DEPLETION

524106747 TP410674 CIRCUIT CARD
 N EA 1 13 1

524106754 TP410675 CIRCUIT CARD
 N EA 1 13 1

524106762 TP410676 CIRCUIT CARD
 1199752 1 EA IL IN MI OH WI
 04 04 04 04 04
 DISCONTINUE, ORDER NON STOCK UPON STOCK DEPLETION

524106770 TP410677 CIRCUIT CARD
 N EA 1 13 1

524106788 TP410678 CIRCUIT CARD
 N EA 1 2 1

524106796 TP410679 CIRCUIT CARD
 1225268 1 EA IL IN MI OH WI
 04 04 04 04 04
 DISCONTINUE, ORDER NON STOCK UPON STOCK DEPLETION

524106804 TP410680 CIRCUIT CARD
 N EA 1 13 1

PRODUCT IDENTIFIER		DESCRIPTION						
ITEM NUMBER	ORD. MULT.	SELL UNIT	STD. PKG. STOCK AVAILABILITY / PA	LEAD TIME	MIN. ORD.	A	C	
524107273 TP410727 CIRCUIT CARD								
1135491	1	EA	IL IN MI OH WI 04 04 04 04 04					
DISCONTINUE, ORDER NON STOCK UPON STOCK DEPLETION								
524107323 TP410732 CIRCUIT CARD								
N		EA	1	13	1			
524107349 TP410734 CIRCUIT CARD								
N		EA	1	13	1			
524107356 TP410735 CIRCUIT CARD								
N		EA	1	13	1			
DISCONTINUE, ORDER NON STOCK UPON STOCK DEPLETION								
524107372 TP410737 CIRCUIT CARD								
1183673	1	EA	IL IN MI OH WI 04 04 04 04 04					
524107406 TP410740 LOGIC CARD/CIRCUIT								
1142794	1	EA	IL IN MI OH WI 04 04 04 04 04					
524107455 TP410745 CIRCUIT CARD								
N		EA	1	13	1			
524107554 TP410755 CARD ASSEMBLY								
N		EA	1	5	1			
524107703 TP410770 CIRCUIT CARD								
1192542	1	EA	IL IN MI OH WI 04 04 04 04 04					
DISCONTINUE, ORDER NON STOCK UPON STOCK DEPLETION								
524107711 TP410771 CIRCUIT CARD								
N		EA	1	2	1			
524107851 TP410785 CIRCUIT CARD								
N		EA	1	13	1			
524108529 TP410852 CIRCUIT CARD								
1123273	1	EA	IL IN MI OH WI 04 04 04 04 04					
524108537 TP410853 CIRCUIT CARD								
1203935	1	EA	IL IN MI OH WI 04 04 04 04 04					
524108545 TP410854 CIRCUIT CARD								
1128165	1	EA	IL IN MI OH WI 04 04 04 04 04					
524108552 TP410855 CIRCUIT CARD								
N		EA	1	13	1			
524113792 TP411379 KEYTOP SET								
N		EA	1	4	1			
524113800 TP411380 KEYTOP SET								
N		EA	1	4	5			
524119013 TP411901 CIRCUIT CARD								
N		EA	1	2	1			

PRODUCT IDENTIFIER		DESCRIPTION						
ITEM NUMBER	ORD. MULT.	SELL UNIT	STD. PKG. STOCK AVAILABILITY / PA	LEAD TIME	MIN. ORD.	A	C	
524124658 TP412465 CABLE ASSEMBLY								
N		EA	1	5	1			
CC # 524124658								
524124666 TP412466 CABLE ASSEMBLY								
N		EA	1	5	1			
CC # 524124666								
524161742 TP416174 CABLE ASSEMBLY								
N		EA	1	5	1			
CC # 524161742								
524272408 TP427240 ASSEMBLY TRACTOR								
1935734	1	EA	IL IN MI OH WI 04 04 04 04 04					
Attached to printer to feed continuous formpaper.								
524272507 TP427250 TRACTOR FEED								
1924886	1	EA	IL IN MI OH WI 04 04 04 04 04					
260314315 TP427260 PINFEED PLATEN								
N		EA	1	2	1			
A pinfeed used with the 5310 1AOA printer. Used with the E911 system.								
524272937 TP427293 TRACTOR FEED								
1926196	1	EA	IL IN MI OH WI 04 04 04 04 04					
Used to feed continuous paper thru printer.								
260314307 TP427358 STATIC ELIMINATOR								
N		EA	1	2	1			
For 5310 1AOA printer designed for use with the E911 System. DISCONTINUE, ORDER NON STOCK UPON STOCK DEPLETION.								
300076783 TP427360 RIBBON CARTRIDGE								
1333096	1	PK	IL IN MI OH WI 33 33 33 33 33					
Package of 6. Cartridge for 5310 printers.								
260390737 TP427421 PEDESTAL W/CASTERS								
1970525		EA	IL IN MI OH WI					
260390745 TP427422 PAPER ACCUMULATOR RACK								
1970517		EA	IL IN MI OH WI 04 04 04 04					
524301363 TP430136 COVER								
N		EA	1	4	5			
524301454 TP430145 TIMING BELT								
N		EA	1	2	12			
524301546 TP430154 LINE FEED MOTOR W/CABLE								
1167114	1	EA	IL IN MI OH WI 04 04 04 04					
DISCONTINUE, ORDER NON STOCK UPON STOCK DEPLETION								
524302171 TP430217 BRIDGE ASSEMBLY								
N		EA	1	13	6			
524303112 TP430311 PEDESTAL								
N		EA	1	4	1			

DISTRIBUTION SERVICES

NETWORK SERVICES

TOOLS

BUILDING JANITORIAL

AUTOMOTIVE

FORMS/OFFICE SUPPLIES

GENERAL

DATA VOICE

TP NUMBERED PARTS

DISTRIBUTION SERVICES

PRODUCT IDENTIFIER		DESCRIPTION					
ITEM NUMBER	ORD. MULT.	SELL UNIT	STD. PKG. STOCK AVAILABILITY / PA	LEAD TIME	MIN. ORD.	A C	
524303336		TP430333	HOLDER				
N		EA	1	4	7		

PRODUCT IDENTIFIER		DESCRIPTION					
ITEM NUMBER	ORD. MULT.	SELL UNIT	STD. PKG. STOCK AVAILABILITY / PA	LEAD TIME	MIN. ORD.	A C	
524522141		TP452214	LABEL				
N		EA	1	4	146		

NETWORK SERVICES

PRODUCT IDENTIFIER		DESCRIPTION					
ITEM NUMBER	ORD. MULT.	SELL UNIT	STD. PKG. STOCK AVAILABILITY / PA	LEAD TIME	MIN. ORD.	A C	
524304847		TP430484	CARTRIDGE W/RIBBON				
1447540	1	PK	IL IN MI OH WI 31 31 31 31 31				
Used for the 43 Printer, package of 6.							
524305661		TP430566	SWITCH				
N		EA	1	4	8		

PRODUCT IDENTIFIER		DESCRIPTION					
ITEM NUMBER	ORD. MULT.	SELL UNIT	STD. PKG. STOCK AVAILABILITY / PA	LEAD TIME	MIN. ORD.	A C	
524522190		TP452219	MAINTENANCE KIT				
1227116	1	EA	IL IN MI OH WI 04 04 04 04 04				
SSI connectors for Dataspeed 4540 SCC and 5 KDs for use with SSI cable.							
524522208		TP452220	MAINTENANCE KIT				
1151472	1	EA	IL IN MI OH WI 04 04 04 04 04				

TOOLS

PRODUCT IDENTIFIER		DESCRIPTION					
ITEM NUMBER	ORD. MULT.	SELL UNIT	STD. PKG. STOCK AVAILABILITY / PA	LEAD TIME	MIN. ORD.	A C	
260323449		TP430658	KIT MODIFICATION SSI EIA				
1943829	1	EA	IL IN MI OH WI 04 04 04 04 04				
TTY 524306586							
524307006		TP430700	POWER SUPPLY ASSEMBLY				
1105676	1	EA	IL IN MI OH WI 04 04 04 04 04				
Model 43, 3ft cable for paper tape unit, 4250AAA.							

PRODUCT IDENTIFIER		DESCRIPTION					
ITEM NUMBER	ORD. MULT.	SELL UNIT	STD. PKG. STOCK AVAILABILITY / PA	LEAD TIME	MIN. ORD.	A C	
524522232		TP452223	CABLE				
N		EA	1	5	2		
524522257		TP452225	CABLE				
N		EA	1	5	1		
524522265		TP452226	CABLE				
N		EA	1	5	2		

BUILDING JANITORIAL

PRODUCT IDENTIFIER		DESCRIPTION					
ITEM NUMBER	ORD. MULT.	SELL UNIT	STD. PKG. STOCK AVAILABILITY / PA	LEAD TIME	MIN. ORD.	A C	
524307329		TP430732	NUTS WITH LOCKWASH				
N		EA	1	4	350		
300029204		TP430750	MODEM 153 A1				
N		EA	1	4	1		
524307808		TP430780	POWER SUPPLY				
N		EA	1	13	1		

PRODUCT IDENTIFIER		DESCRIPTION					
ITEM NUMBER	ORD. MULT.	SELL UNIT	STD. PKG. STOCK AVAILABILITY / PA	LEAD TIME	MIN. ORD.	A C	
524522273		TP452227	CABLE				
N		EA	1	5	2		
524522281		TP452228	CABLE				
N		EA	1	5	1		
524522422		TP452242	TOOL				
N		EA	1	2	1		

AUTOMOTIVE

PRODUCT IDENTIFIER		DESCRIPTION					
ITEM NUMBER	ORD. MULT.	SELL UNIT	STD. PKG. STOCK AVAILABILITY / PA	LEAD TIME	MIN. ORD.	A C	
524308509		TP430850	PRINthead ASSEMBLY				
1164236	1	EA	IL IN MI OH WI 04 04 04 04 04				
524309002		TP430900	MOD KIT/ANSBCK				
N		EA	1	4	1		
524309101		TP430910	MOD KIT				
N		EA	1	4	1		

PRODUCT IDENTIFIER		DESCRIPTION					
ITEM NUMBER	ORD. MULT.	SELL UNIT	STD. PKG. STOCK AVAILABILITY / PA	LEAD TIME	MIN. ORD.	A C	
300078037		TP453324	TRACTOR LEFT SIDE				
N		EA	1	4	5		
524533254		TP453325	TRACTOR MECHANICAL				
N		EA	1	4	5		
524546306		TP454630	RIBBON SHIELD				
N		EA	1	4	12		

FORMS/OFFICE SUPPLIES

PRODUCT IDENTIFIER		DESCRIPTION					
ITEM NUMBER	ORD. MULT.	SELL UNIT	STD. PKG. STOCK AVAILABILITY / PA	LEAD TIME	MIN. ORD.	A C	
524513405		TP451340	MOD KIT				
N		EA	1	14	1		
524513652		TP451365	SPACER				
N		EA	1	4	39		

PRODUCT IDENTIFIER		DESCRIPTION					
ITEM NUMBER	ORD. MULT.	SELL UNIT	STD. PKG. STOCK AVAILABILITY / PA	LEAD TIME	MIN. ORD.	A C	
260395561		TP455200	PRINthead FOR 5310/20				
N		EA	1	4	1		
260318225		TP456827	CABLE 10FT V35				
N		EA	1	3	1		

GENERAL

PRODUCT IDENTIFIER		DESCRIPTION					
ITEM NUMBER	ORD. MULT.	SELL UNIT	STD. PKG. STOCK AVAILABILITY / PA	LEAD TIME	MIN. ORD.	A C	
524521010		TP452101	POWER SUPPLY				
1215756	1	EA	IL IN MI OH WI 04 04 04 04 04				
524521549		TP452154	CABLE ASSEMBLY				
N		EA	1	4	2		
For maintenance use for Dataspeed 4540.							
524521572		TP452157	DECAL				
N		EA	1	4	27		
524521911		TP452191	VENT ASSEMBLY				
N		EA	1	13	1		

TRANSFORMER							
ITEM NUMBER	ORD. MULT.	SELL UNIT	STD. PKG. STOCK AVAILABILITY / PA	LEAD TIME	MIN. ORD.	A C	
100769603		TRANSFORMER	2564 N				
N		EA	1	2	1		
280000761		TRANSFORMER	181768-101 12-13 VOLTS				
N		EA	1	4	1		
T 60/60 HAZ 4.8VA							
401923778		TRANSFORMER	CK21239 L 5				
1160093	1	EA	IL IN MI OH WI 04 04 04 04 04				
DISCONTINUED - ORDER NON STOCK UPON STOCK DEPLETION							

DATA VOICE

PRODUCT IDENTIFIER		DESCRIPTION					
ITEM NUMBER	ORD. MULT.	SELL UNIT	STD. PKG. STOCK AVAILABILITY / PA	LEAD TIME	MIN. ORD.	A C	
524522133		TP452213	LABEL				
N		EA	1	4	146		

TRANSFORMER NEUTRALIZING							
ITEM NUMBER	ORD. MULT.	SELL UNIT	STD. PKG. STOCK AVAILABILITY / PA	LEAD TIME	MIN. ORD.	A C	
100759315		TRANSFORMER	NEUTRALIZING				
1171975	1	EA	IL IN MI OH WI 04				

PRODUCT IDENTIFIER		DESCRIPTION						
ITEM NUMBER	ORD. MULT.	SELL UNIT	STD. PKG. STOCK AVAILABILITY / PA	LEAD TIME	MIN. ORD.	A	C	
TRANSMITTER								
103971933	N	EA	1	4	1			
TRANSMITTER 680AE-60								
280000720	N	EA	1	4	1			
TRANSMITTER 075555-101								
401732219	1301838	1	EA	IL 04	IN 04	MI 04	OH 04	WI 04
TRANSMITTER CK16664 L3 50 IVORY								
TRANSMITTER UNIT								
SEE UNIT TRANSMITTER.								
TRAY								
260325394	N	EA	1	4	1			
TRAY DIRECTORY TELEPHONE								
Tie 88158.								
UNIT								
260325519	N	EA	1	4	1			
UNIT AUXILIARY LINK								
TIE 88165.								
280022690	N	EA	1	2	1			
UNIT DISPLAY VM1002								
260325303	N	EA	1	4	1			
UNIT MAIN LINE TIE 88175								
300064862	N	EA	1	2	1			
UNIT PAGING ACCESS KA-380								
Provides paging access to an external amplifier.								
500049341	N	EA	1	4	1			
UNIT PAPER TAPE 4250AAA								
102089315	N	EA	1	4	1			
UNIT SERVICE KEY 551C								
A factory wired 1A2 key telephone system package to mount 4ea 499 type KTU e/w power.								
300060464	1193698	1	EA	IL 04	IN 04	MI 04	OH 04	WI 04
UNIT STATION M-822								
Station unit of an asynchronous data communication network which allows simultaneous transmission of voice and data over existing telephone loops.								
UNIT CHANNEL								
102278918	N	EA	1	9	1			
UNIT CHANNEL SERVICE 550A L1/2								

PRODUCT IDENTIFIER		DESCRIPTION						
ITEM NUMBER	ORD. MULT.	SELL UNIT	STD. PKG. STOCK AVAILABILITY / PA	LEAD TIME	MIN. ORD.	A	C	
102278926	N	EA	1	9	1			
UNIT CHANNEL SERVICE 550A L1/3								
102278934	N	EA	1	9	1			
UNIT CHANNEL SERVICE 550A L1/4								
A 9.6 KB/S digital interface used for full-duplex operation in 4-wire private line applications.								
102278942	N	EA	1	9	1			
UNIT CHANNEL SERVICE 550A L1/5								
A 56 KB/S digital interface used for full-duplex operation in 4-wire private line applications.								
102417649	N	EA	1	10	1			
UNIT CHANNEL SERVICE 551A L1								
UNIT DATA								
103070272	1223602	1	EA					
UNIT DATA 48ER1								
Backup CLU to derive a four wire backup channel over the switched network.								
UNIT POWER								
103225090	N	EA	1	13	1			
UNIT POWER 20 B 4								
102411329	1221036	1	EA	IL 04	IN 04	MI 04	OH 04	WI 04
UNIT POWER 90 B 1								
For use with up to ten 620A, 641A or 642A modular key system panels, BSP 518-215-419.								
102272911	1132902	1	EA	IL 04	IN 04	MI 04	OH 04	WI 04
UNIT POWER 95 B 1								
Basic power unit for Touch-A-Matic dialers, rotary or touch-tone, BSP 503-603-101.								
103150850	N	EA	1	17	1			
UNIT POWER 289 A 2								
UNIT SERVICE								
102393683	N	EA	1	2	1			
UNIT SERVICE DATA 500AW								
103625711	N	EA	1	9	1			
UNIT SERVICE DATA 500B L1/2								
103625729	N	EA	1	9	1			
UNIT SERVICE DATA 500B L1/3								
103625737	1159921	1	EA	IL 01	IN 01	MI 01	OH 01	WI 01
UNIT SERVICE DATA 500B L1/4								
A 9.6 KB/S digital signal converter used for full-duplex operation in 4-wire private line applications.								

DISTRIBUTION SERVICES
 NETWORK SERVICES
 TOOLS
 BUILDING JANITORIAL
 AUTOMOTIVE
 FORMS/OFFICE SUPPLIES
 GENERAL
 DATA VOICE

UNIT SERVICE

DISTRIBUTION SERVICES

PRODUCT IDENTIFIER		DESCRIPTION					
ITEM NUMBER	ORD. MULT.	SELL UNIT	STD. PKG. STOCK AVAILABILITY / PA	LEAD TIME	MIN. ORD.	A	C
103625745			UNIT SERVICE DATA	500B	L1/5		
N		EA	1	10	1		
A 56 KB/S digital signal converter used for full-duplex operation in 4-wire private line applications.							

NETWORK SERVICES

PRODUCT IDENTIFIER		DESCRIPTION					
ITEM NUMBER	ORD. MULT.	SELL UNIT	STD. PKG. STOCK AVAILABILITY / PA	LEAD TIME	MIN. ORD.	A	C
260318308			UNIT SERVICE DIGITAL	629045-000-001			
1941310	1	EA	IL IN MI OH WI				
			01				
DISCONTINUE - ORDER NON STOCK UPON STOCK DEPLETION							

TOOLS

PRODUCT IDENTIFIER		DESCRIPTION					
ITEM NUMBER	ORD. MULT.	SELL UNIT	STD. PKG. STOCK AVAILABILITY / PA	LEAD TIME	MIN. ORD.	A	C
300036449			UNIT SERVICE OBSERVING KM	330B			
1181693	1	EA	IL IN MI OH WI				
			04 04 04 04				
A 30 line, self-contained service observing unit. Provides for selective access to each of thirty lines by dialing a 2 digit number.							

PRODUCT IDENTIFIER		DESCRIPTION					
ITEM NUMBER	ORD. MULT.	SELL UNIT	STD. PKG. STOCK AVAILABILITY / PA	LEAD TIME	MIN. ORD.	A	C
300036456			UNIT SERVICE OBSERVING KMX	333B			
1220798	1	EA	IL IN MI OH WI				
			04 04 04 04				
Used with service observing unit KM330B to expand capacity by 30 additional lines.							

BUILDING JANITORIAL

PRODUCT IDENTIFIER		DESCRIPTION					
ITEM NUMBER	ORD. MULT.	SELL UNIT	STD. PKG. STOCK AVAILABILITY / PA	LEAD TIME	MIN. ORD.	A	C
260000492			UNIT TELEPHONE KEY	400D			
1996173	1	EA					

PRODUCT IDENTIFIER		DESCRIPTION					
ITEM NUMBER	ORD. MULT.	SELL UNIT	STD. PKG. STOCK AVAILABILITY / PA	LEAD TIME	MIN. ORD.	A	C
102379880			UNIT TELEPHONE KEY	401B			
1194837	1	EA	IL IN MI OH WI				
			04 04 04 04				

AUTOMOTIVE

PRODUCT IDENTIFIER		DESCRIPTION					
ITEM NUMBER	ORD. MULT.	SELL UNIT	STD. PKG. STOCK AVAILABILITY / PA	LEAD TIME	MIN. ORD.	A	C
300088408			UNIT TELEPHONE KEY	4000-208			
1920579	1	EA	IL IN MI OH WI				
			04 04 04 04				
A plug-in unit for a 1A2 key telephone system for C.O. or PBX line circuit unit, BSP 518-220-400.							

FORMS/OFFICE SUPPLIES

PRODUCT IDENTIFIER		DESCRIPTION					
ITEM NUMBER	ORD. MULT.	SELL UNIT	STD. PKG. STOCK AVAILABILITY / PA	LEAD TIME	MIN. ORD.	A	C
001186048			UNIT TELEPHONE KEY	LC400H			
1130534	1	EA	IL IN MI OH WI				
			04 04				
DISCONTINUED - REPLACED BY UNIT TEL KEY 400D UPON STOCK DEPLETION							

PRODUCT IDENTIFIER		DESCRIPTION					
ITEM NUMBER	ORD. MULT.	SELL UNIT	STD. PKG. STOCK AVAILABILITY / PA	LEAD TIME	MIN. ORD.	A	C
002056463			UNIT TELEPHONE KEY	TC1900			
N		EA	1	6	1		

PRODUCT IDENTIFIER		DESCRIPTION					
ITEM NUMBER	ORD. MULT.	SELL UNIT	STD. PKG. STOCK AVAILABILITY / PA	LEAD TIME	MIN. ORD.	A	C
260416789			UNIT TRANSFER	MT910, P/N 403066-01			
N		EA	1	2	1		
Mannesmann-Tally 161K							

DATA VOICE

PRODUCT IDENTIFIER		DESCRIPTION					
ITEM NUMBER	ORD. MULT.	SELL UNIT	STD. PKG. STOCK AVAILABILITY / PA	LEAD TIME	MIN. ORD.	A	C
100828557			UNIT TRANSMITTER	NI 1628			
N		EA	1	4	1		

PRODUCT IDENTIFIER		DESCRIPTION					
ITEM NUMBER	ORD. MULT.	SELL UNIT	STD. PKG. STOCK AVAILABILITY / PA	LEAD TIME	MIN. ORD.	A	C
100828573			UNIT TRANSMITTER	T1			
1109496	1	EA	IL IN MI OH WI				
			04 04 04 04				
Used in F4, F5, G1, G2, G3, G4 and G5 handsets, BSP 501-230-100.							

SEE GUIDE USER.

PRODUCT IDENTIFIER		DESCRIPTION					
ITEM NUMBER	ORD. MULT.	SELL UNIT	STD. PKG. STOCK AVAILABILITY / PA	LEAD TIME	MIN. ORD.	A	C
260990056			VACUUM ASBESTOS BACK-PACK				
N		EA	1	4	1		
Hako Minuteman 390-1.							

SEE COUPLER VOICE.

PRODUCT IDENTIFIER		DESCRIPTION					
ITEM NUMBER	ORD. MULT.	SELL UNIT	STD. PKG. STOCK AVAILABILITY / PA	LEAD TIME	MIN. ORD.	A	C
842701716			WASHER	842701716			
N		EA	1	15	1		

PRODUCT IDENTIFIER		DESCRIPTION					
ITEM NUMBER	ORD. MULT.	SELL UNIT	STD. PKG. STOCK AVAILABILITY / PA	LEAD TIME	MIN. ORD.	A	C
996217741			WASHER LOCK SPRING	SS .190 REG			
N		EA	1	2	1		

PRODUCT IDENTIFIER		DESCRIPTION					
ITEM NUMBER	ORD. MULT.	SELL UNIT	STD. PKG. STOCK AVAILABILITY / PA	LEAD TIME	MIN. ORD.	A	C
400891545			WASHER SEALING	K 25 PK 4			
N							

PRODUCT IDENTIFIER		DESCRIPTION					
ITEM NUMBER	ORD. MULT.	SELL UNIT	STD. PKG. STOCK AVAILABILITY / PA	LEAD TIME	MIN. ORD.	A	C
500048160			WINDER PAPER	40PWU102			
N		EA	1	2	1		

PRODUCT IDENTIFIER		DESCRIPTION					
ITEM NUMBER	ORD. MULT.	SELL UNIT	STD. PKG. STOCK AVAILABILITY / PA	LEAD TIME	MIN. ORD.	A	C
300017696			WOOL INSULATING	S-81			
N		BX	1	3	1		

NOTES

NOTES

SECTION 8 - DATA/VOICE **MATERIAL INCLUDED**

- PERSONAL COMPUTER EQUIPMENT
- PRINTER EQUIPMENT
- TELEPHONES AND RELATED EQUIPMENT
- TERMINALS AND RELATED EQUIPMENT
- SOFTWARE

The DATA/VOICE Section is designed to assist the end-user in selecting and ordering specific Standard Operating Environment (SOE) equipment.

Due to the large scope of this project and publishing deadlines, a number of products have not been converted to the DATA/VOICE Section. Non-SOE material located in this section will continue until stock is depleted.

We are concerned and value your ideas. Please contact the Ameritech Bell Group Catalog Department direct on (708) 248-8313 with questions, corrections and ideas.

Catalog Format

PRODUCT IDENTIFIER		DESCRIPTION				
ITEM NUMBER	ORD. MULT.	SELL UNIT	STD. PKG.	LEAD TIME	MIN. ORD.	A C

Stock Material

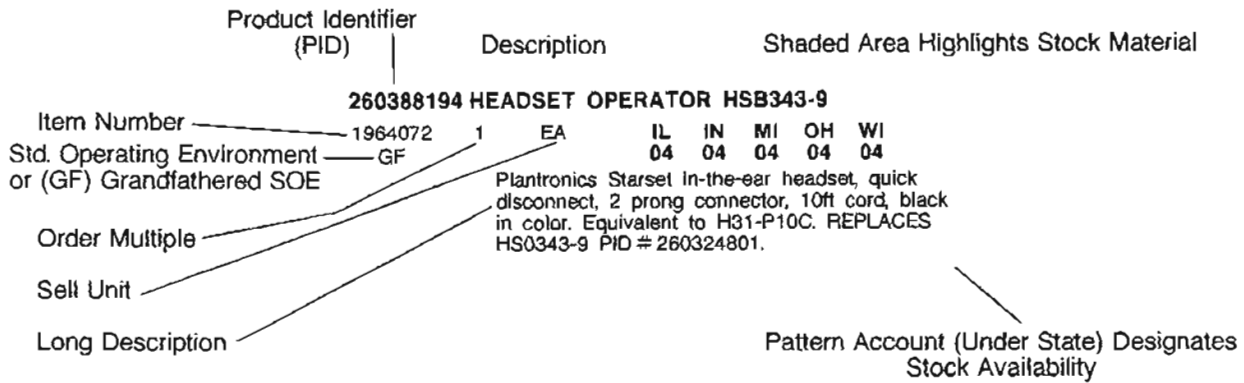

Non-Stock Material

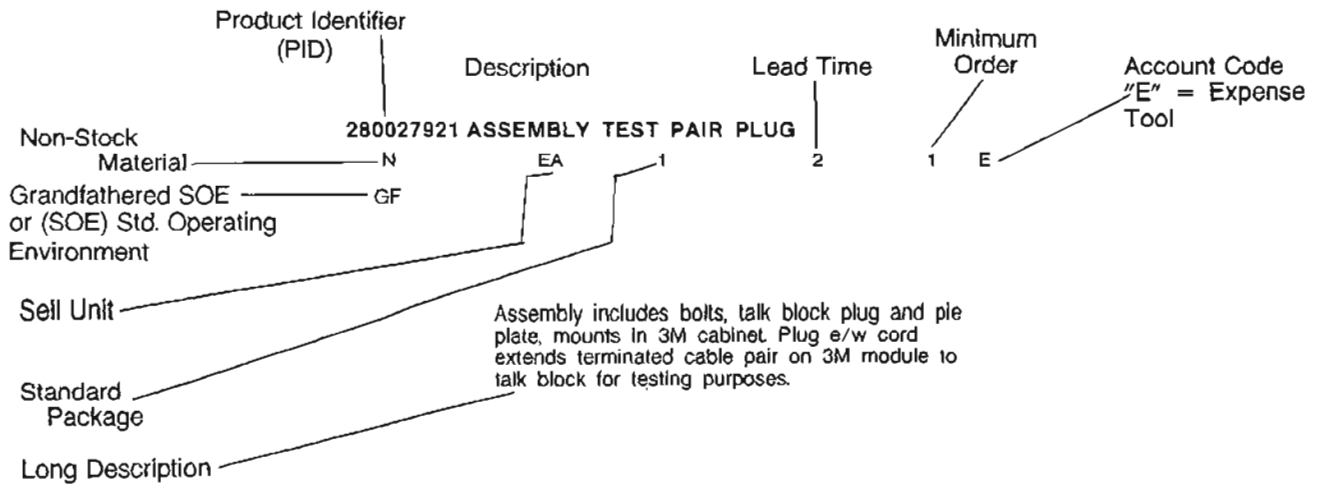

DISTRIBUTION SERVICES

NETWORK SERVICES

TOOLS

BUILDING JANITORIAL

AUTOMOTIVE

FORMS/OFFICE SUPPLIES

GENERAL

DATA VOICE

PRODUCT IDENTIFIER		DESCRIPTION				
ITEM	ORD.	SELL	STD. PKG.	LEAD TIME	MIN.	A
NUMBER	MULT.	UNIT	STOCK AVAILABILITY / PA		ORD.	C

PRODUCT IDENTIFIER		DESCRIPTION				
ITEM	ORD.	SELL	STD. PKG.	LEAD TIME	MIN.	A
NUMBER	MULT.	UNIT	STOCK AVAILABILITY / PA		ORD.	C

APERTUS/LEE DATA MAINTENANCE SPARES

260393640 ADAPTER CABLE		83700513				
1966481	1	EA				
260424197 ADAPTER RS232		F/N5998				
1976845	1	EA	IL	IN	MI	OH WI
						03
For use with 5500 or 5510 Remote Control Modules.						
260396122 ADAPTER SYSM PCB		80001232				
1967349		EA	IL	IN	MI	OH WI
			03			03
260424288 ADAPTER V.35		F/N5999				
1976902	1	EA	IL	IN	MI	OH WI
						03
260402110 ARM IDLER 1361		72500877				
1968172	1	EA	IL	IN	MI	OH WI
						03 03
260402102 ARM IDLER CATCH 1361		72500883				
1968164	1	EA	IL	IN	MI	OH WI
						03 03
260393863 ASSEMBLY COLOR GRAPHIC		83250148				
1966457	1	EA	IL	IN	MI	OH WI
			03			03
260402094 ASSEMBLY DENSITY CONTROL 1361		72500895				
1968156	1	EA	IL	IN	MI	OH WI
						03 03
260393665 ASSEMBLY SHUTTLE		72500712				
1966580	1	EA	IL	IN	MI	OH WI
			03			
260396163 BACKPLANE 4 POSITION		80001460				
1967380	1	EA	IL	IN	MI	OH WI
						03 03
260396072 BACKPLANE 6 POSITION		80000432				
1967299	1	EA	IL	IN	MI	OH WI
						03 03
260429774 BACKPLANE 8 SLOT		F/N5010				
1978221	1	EA	IL	IN	MI	OH WI
260396403 BACKPLANE 12 POSITION		80000433				
1967620	1	EA	IL	IN	MI	OH WI
						03
260429790 BACKPLANE 16 SLOT 0-7		F/N5020				
1978262	1	EA	IL	IN	MI	OH WI
260429816 BACKPLANE 16 SLOT 8-15		F/N5020				
1978288	1	EA	IL	IN	MI	OH WI
260393657 BATTERY		55580005				
1966598	1	EA	IL	IN	MI	OH WI
			03			03

260402078 BELT KIT 1361		72500906				
1968131	1	EA	IL	IN	MI	OH WI
						03 03
260395702 BELT PAPERFEED		72500710				
1966929	1	EA	IL	IN	MI	OH WI
						03 03
260395801 BELT PAPERFEED		72501516				
1967026	1	EA	IL	IN	MI	OH WI
						03 03
260395710 BELT SHUTTLE		72500711				
1966937	1	EA	IL	IN	MI	OH WI
						03 03
260395819 BELT SHUTTLE		72501517				
1967034	1	EA	IL	IN	MI	OH WI
						03 03
260396437 BOARD 8 STATION		83800020				
1967653	1	EA	IL	IN	MI	OH WI
						03 03
260396254 BOARD ADAPTER COAXIAL		82100049				
1967471	1	EA	IL	IN	MI	OH WI
						03
260385265 BOARD BACKPLANE PWB		80002300				
1962829	1	EA	IL	IN	MI	OH WI
			03			03
260372438 BOARD BACKPLANE PWB		80002301				
1958439	1	EA	IL	IN	MI	OH WI
			03			03
260392444 BOARD COMMUNICATIONS 56K		80002151				
1965996	1	EA	IL	IN	MI	OH WI
			03	03		
Used on FN1893A.						
260402763 BOARD DEFLECTION		80001082				
1968966	1	EA	IL	IN	MI	OH WI
			03			03
260393749 BOARD DEFLECTION		80001083				
1966309	1	EA	IL	IN	MI	OH WI
			03			03
260395892 BOARD HAMMER DRIVER		72501509				
1967117	1	EA	IL	IN	MI	OH WI
						03 03
260395959 BOARD LOGIC A 7		72501512				
1967174	1	EA	IL	IN	MI	OH WI
						03 03
260395983 BOARD LOGIC B10		72501513				
1967208	1	EA	IL	IN	MI	OH WI
						03
260385273 BOARD MOTHER		80000110				
1962837	1	EA	IL	IN	MI	OH WI
			03	03		03

APERTUS/LEE DATA MAINTENANCE SPARES

DISTRIBUTION SERVICES

PRODUCT IDENTIFIER		DESCRIPTION				
ITEM NUMBER	ORD. MULT.	SELL UNIT	STD. PKG. STOCK AVAILABILITY / PA	LEAD TIME	MIN. ORD.	A C

PRODUCT IDENTIFIER		DESCRIPTION				
ITEM NUMBER	ORD. MULT.	SELL UNIT	STD. PKG. STOCK AVAILABILITY / PA	LEAD TIME	MIN. ORD.	A C

NETWORK SERVICES

TOOLS

BUILDING JANITORIAL

AUTOMOTIVE

FORMS/OFFICE SUPPLIES

GENERAL

DATA VOICE

260385281	1	EA	IL 03	IN 03	MI 03	OH 03	WI 03	80000111
1962845	1	EA	IL 03	IN 03	MI 03	OH 03	WI 03	80000112
260371653	1	EA	IL 03	IN 03	MI 03	OH 03	WI 03	80000770
1962852	1	EA	IL 03	IN 03	MI 03	OH 03	WI 03	80000771
260385307	1	EA	IL 03	IN 03	MI 03	OH 03	WI 03	80000772
1962068	1	EA	IL 03	IN 03	MI 03	OH 03	WI 03	80000773
260383922	1	EA	IL 03	IN 03	MI 03	OH 03	WI 03	72506641
1967829	1	EA	IL 03	IN 03	MI 03	OH 03	WI 03	80001600
260372313	1	EA	IL 03	IN 03	MI 03	OH 03	WI 03	72500700
1968701	1	EA	IL 03	IN 03	MI 03	OH 03	WI 03	82100082
260403415	1	EA	IL 03	IN 03	MI 03	OH 03	WI 03	80001641
1967852	1	EA	IL 03	IN 03	MI 03	OH 03	WI 03	80001171
260372347	1	EA	IL 03	IN 03	MI 03	OH 03	WI 03	80001172
1967852	1	EA	IL 03	IN 03	MI 03	OH 03	WI 03	80001173
260371901	1	EA	IL 03	IN 03	MI 03	OH 03	WI 03	80001110
1968132	1	EA	IL 03	IN 03	MI 03	OH 03	WI 03	80001111
260402151	1	EA	IL 03	IN 03	MI 03	OH 03	WI 03	80000410
1968420	1	EA	IL 03	IN 03	MI 03	OH 03	WI 03	
260396197	1	EA	IL 03	IN 03	MI 03	OH 03	WI 03	
1967414	1	EA	IL 03	IN 03	MI 03	OH 03	WI 03	
260392451	1	EA	IL 03	IN 03	MI 03	OH 03	WI 03	
1966002	1	EA	IL 03	IN 03	MI 03	OH 03	WI 03	
260396221	1	EA	IL 03	IN 03	MI 03	OH 03	WI 03	
1967448	1	EA	IL 03	IN 03	MI 03	OH 03	WI 03	
260396015	1	EA	IL 03	IN 03	MI 03	OH 03	WI 03	
1967232	1	EA	IL 03	IN 03	MI 03	OH 03	WI 03	
260403282	1	EA	IL 03	IN 03	MI 03	OH 03	WI 03	
1968586	1	EA	IL 03	IN 03	MI 03	OH 03	WI 03	
260393715	1	EA	IL 03	IN 03	MI 03	OH 03	WI 03	
1966275	1	EA	IL 03	IN 03	MI 03	OH 03	WI 03	
260395777	1	EA	IL 03	IN 03	MI 03	OH 03	WI 03	
1966994	1	EA	IL 03	IN 03	MI 03	OH 03	WI 03	

260396098	1	EA	IL 03	IN 03	MI 03	OH 03	WI 03	80001140
1967323	1	EA	IL 03	IN 03	MI 03	OH 03	WI 03	80001310
260372339	1	EA	IL 03	IN 03	MI 03	OH 03	WI 03	84000040
1967845	1	EA	IL 03	IN 03	MI 03	OH 03	WI 03	84000041
260385786	1	EA	IL 03	IN 03	MI 03	OH 03	WI 03	80000510
1963348	1	EA	IL 03	IN 03	MI 03	OH 03	WI 03	80000511
260371729	1	EA	IL 03	IN 03	MI 03	OH 03	WI 03	80000510
1957944	1	EA	IL 03	IN 03	MI 03	OH 03	WI 03	80000511
260385331	1	EA	IL 03	IN 03	MI 03	OH 03	WI 03	80000511
1962894	1	EA	IL 03	IN 03	MI 03	OH 03	WI 03	80000511
260371737	1	EA	IL 03	IN 03	MI 03	OH 03	WI 03	80000511
1957951	1	EA	IL 03	IN 03	MI 03	OH 03	WI 03	80000511
260371778	1	EA	IL 03	IN 03	MI 03	OH 03	WI 03	80008000
1957993	1	EA	IL 03	IN 03	MI 03	OH 03	WI 03	80008001
260385323	1	EA	IL 03	IN 03	MI 03	OH 03	WI 03	80008001
1962886	1	EA	IL 03	IN 03	MI 03	OH 03	WI 03	80002200
260385349	1	EA	IL 03	IN 03	MI 03	OH 03	WI 03	80002201
1962902	1	EA	IL 03	IN 03	MI 03	OH 03	WI 03	80002201
260385356	1	EA	IL 03	IN 03	MI 03	OH 03	WI 03	80002201
1962910	1	EA	IL 03	IN 03	MI 03	OH 03	WI 03	80002201
260371224	1	EA	IL 03	IN 03	MI 03	OH 03	WI 03	80001171
1957266	1	EA	IL 03	IN 03	MI 03	OH 03	WI 03	80001172
260385364	1	EA	IL 03	IN 03	MI 03	OH 03	WI 03	80001172
1962928	1	EA	IL 03	IN 03	MI 03	OH 03	WI 03	80001173
260385372	1	EA	IL 03	IN 03	MI 03	OH 03	WI 03	80001173
1962936	1	EA	IL 03	IN 03	MI 03	OH 03	WI 03	80001173
260372529	1	EA	IL 03	IN 03	MI 03	OH 03	WI 03	80001173
1958702	1	EA	IL 03	IN 03	MI 03	OH 03	WI 03	80001173
260371794	1	EA	IL 03	IN 03	MI 03	OH 03	WI 03	80001110
1958017	1	EA	IL 03	IN 03	MI 03	OH 03	WI 03	80001110
260385380	1	EA	IL 03	IN 03	MI 03	OH 03	WI 03	80001111
1972944	1	EA	IL 03	IN 03	MI 03	OH 03	WI 03	80001111
260385398	1	EA	IL 03	IN 03	MI 03	OH 03	WI 03	80000410
1962951	1	EA	IL 03	IN 03	MI 03	OH 03	WI 03	80000410

PRODUCT IDENTIFIER							DESCRIPTION										
ITEM NUMBER	ORD. MULT.	SELL UNIT	STD. PKG. STOCK AVAILABILITY / PA	LEAD TIME			MIN. ORD.	A C	ITEM NUMBER	ORD. MULT.	SELL UNIT	STD. PKG. STOCK AVAILABILITY / PA	LEAD TIME			MIN. ORD.	A C
260371661			CARD COAX FILTER	80000411													
1957886	1	EA	IL IN MI OH WI 03 03 03 03														
260403506			CARD COAXIAL L I/F F/N1437L														
1968784		EA	IL IN MI OH WI 03														
260385406			CARD COLOR GRAPHIC	80007061													
1962969	1	EA	IL IN MI OH WI 03 03 03														
260385414			CARD COMMUNICATION	80000930													
1962977	1	EA	IL IN MI OH WI 03 03														
260385422			CARD COMMUNICATION	80000931													
1962985	1	EA	IL IN MI OH WI 03 03														
260385430			CARD COMMUNICATION	80000932													
1962993	1	EA	IL IN MI OH WI 03 03 03														
260371679			CARD COMMUNICATION	80000933													
1957894	1	EA	IL IN MI OH WI 03 03 03 03														
260372149			CARD CONTROLLER	72500880													
1958348	1	EA	IL IN MI OH WI 03 03 03														
260403654			CARD CPU	72506645													
1968933	1	EA	IL IN MI OH WI 03														
260372446			CARD CPU/MEMORY	80002311													
1958421	1	EA	IL IN MI OH WI 03 03														
260385448			CARD CPU/MEMORY	80002312													
1963009	1	EA	IL IN MI OH WI 03 03														
260372453			CARD DISK CONTROLLER	82100034													
1958413	1	EA	IL IN MI OH WI 03 03														
260372354			CARD DISK HARD	82100024													
1957860	1	EA	IL IN MI OH WI 03 03 03														
260385455			CARD DISK HARD	82100027													
1963017	1	EA	IL IN MI OH WI 03														
260385463			CARD DISPLAY GENERATOR	80002380													
1963025	1	EA	IL IN MI OH WI 03 03 03														
260385471			CARD DISPLAY GENERATOR	80002381													
1963033	1	EA	IL IN MI OH WI 03 03														
260372669			CARD DISPLAY GENERATOR	83250141													
1958579	1	EA	IL IN MI OH WI 03 03 03														

PRODUCT IDENTIFIER							DESCRIPTION										
ITEM NUMBER	ORD. MULT.	SELL UNIT	STD. PKG. STOCK AVAILABILITY / PA	LEAD TIME			MIN. ORD.	A C	ITEM NUMBER	ORD. MULT.	SELL UNIT	STD. PKG. STOCK AVAILABILITY / PA	LEAD TIME			MIN. ORD.	A C
260372560			CARD DISPLAY GENERATOR	83250142													
1958660	1	EA	IL IN MI OH WI 03 03 03 03														
260417878			CARD DISPLAY GENERATOR	83250143													
1972786	1	EA	IL IN MI OH WI														
260372552			CARD DISPLAY GENERATOR	83250144													
1958678	1	EA	IL IN MI OH WI 03 03 03														
260372545			CARD DISPLAY GENERATOR	83250145													
1958686	1	EA	IL IN MI OH WI 03 03 03														
260385489			CARD DISPLAY GENERATOR	84000014													
1963041	1	EA	IL IN MI OH WI 03 03 03														
260385497			CARD DISPLAY GENERATOR	84000015													
1963058	1	EA	IL IN MI OH WI 03 03 03														
260385505			CARD DISPLAY GENERATOR	84000017													
1963066	1	EA	IL IN MI OH WI 03 03 03														
260385513			CARD DISPLAY GENERATOR	84000019													
1963074	1	EA	IL IN MI OH WI 03 03 03														
260385521			CARD DISPLAY GENERATOR	84000050													
1963082	1	EA	IL IN MI OH WI 03														
260385539			CARD DISPLAY GENERATOR	84000055													
1963090	1	EA	IL IN MI OH WI 03 03 03														
260385547			CARD DISPLAY GENERATOR	84000056													
1963108	1	EA	IL IN MI OH WI 03 03 03														
260385554			CARD DRIVE/RECEIVER	80000380													
1963116	1	EA	IL IN MI OH WI 03 03 03														
260385562			CARD DRIVE/RECEIVER	80000381													
1963124	1	EA	IL IN MI OH WI 03 03 03														
260371810			CARD DRIVE/RECEIVER	80000382													
1958033	1	EA	IL IN MI OH WI 03 03 03														
260370879			CARD I/O PCB	72500879													
1956912	1	EA	IL IN MI OH WI 03 03 03														
260371802			CARD LOCAL I/O	80001250													
1958025	1	EA	IL IN MI OH WI 03														
260371760			CARD MEMORY BATTERY BACKUP	80002202													
1957985	1	EA	IL IN MI OH WI 03 03 03 03														

DISTRIBUTION SERVICES
 NETWORK SERVICES
 TOOLS
 BUILDING JANITORIAL
 AUTOMOTIVE
 FORMS/OFFICE SUPPLIES
 GENERAL
 DATA VOICE

APERTUS/LEE DATA MAINTENANCE SPARES

DISTRIBUTION SERVICES

PRODUCT IDENTIFIER		DESCRIPTION						
ITEM NUMBER	ORD. MULT.	SELL UNIT	STD. PKG. STOCK AVAILABILITY / PA	LEAD TIME	MIN. ORD.	A	C	

PRODUCT IDENTIFIER		DESCRIPTION						
ITEM NUMBER	ORD. MULT.	SELL UNIT	STD. PKG. STOCK AVAILABILITY / PA	LEAD TIME	MIN. ORD.	A	C	

NETWORK SERVICES

260371927	1	EA	IL IN MI OH WI 03 03 03	72500703			
-----------	---	----	----------------------------	----------	--	--	--

260372206	1	EA	IL IN MI OH WI 03 03 03	84000029			
-----------	---	----	----------------------------	----------	--	--	--

TOOLS

260372461	1	EA	IL IN MI OH WI 03	82100038			
-----------	---	----	----------------------	----------	--	--	--

260385703	1	EA	IL IN MI OH WI 03	84000030			
-----------	---	----	----------------------	----------	--	--	--

260385588	1	EA	IL IN MI OH WI 03	82100042			
-----------	---	----	----------------------	----------	--	--	--

260371919	1	EA	IL IN MI OH WI 03	72500701			
-----------	---	----	----------------------	----------	--	--	--

260393889	EA	IL IN MI OH WI 03 03 03 03	72507033				
-----------	----	-------------------------------	----------	--	--	--	--

260371786	1	EA	IL IN MI OH WI 03 03 03 03	80001370			
-----------	---	----	-------------------------------	----------	--	--	--

260372651	1	EA	IL IN MI OH WI 03	1334 72505518			
-----------	---	----	----------------------	---------------	--	--	--

260385596	1	EA	IL IN MI OH WI 03 03	80003010			
-----------	---	----	-------------------------	----------	--	--	--

BUILDING JANITORIAL

260385646	1	EA	IL IN MI OH WI 03	80001340			
-----------	---	----	----------------------	----------	--	--	--

260385604	1	EA	IL IN MI OH WI 03 03	80003011			
-----------	---	----	-------------------------	----------	--	--	--

260385653	1	EA	IL IN MI OH WI 03	80001341			
-----------	---	----	----------------------	----------	--	--	--

260385612	1	EA	IL IN MI OH WI 03 03	80003012			
-----------	---	----	-------------------------	----------	--	--	--

260371836	1	EA	IL IN MI OH WI 03 03	80001342			
-----------	---	----	-------------------------	----------	--	--	--

260385620	1	EA	IL IN MI OH WI 03 03	80003013			
-----------	---	----	-------------------------	----------	--	--	--

AUTOMOTIVE

260385661	1	EA	IL IN MI OH WI 03	80001343			
-----------	---	----	----------------------	----------	--	--	--

260385638	1	EA	IL IN MI OH WI 03 03	80003014			
-----------	---	----	-------------------------	----------	--	--	--

260385679	1	EA	IL IN MI OH WI 03 03	80001490			
-----------	---	----	-------------------------	----------	--	--	--

260371695	1	EA	IL IN MI OH WI 03 03 03 03	80003015			
-----------	---	----	-------------------------------	----------	--	--	--

FORMS/OFFICE SUPPLIES

260385687	1	EA	IL IN MI OH WI 03 03	80001491			
-----------	---	----	-------------------------	----------	--	--	--

260371943	1	EA	IL IN MI OH WI 03 03 03	72500706			
-----------	---	----	----------------------------	----------	--	--	--

260372073	1	EA	IL IN MI OH WI 03 03	80001492			
-----------	---	----	-------------------------	----------	--	--	--

260403472	1	EA	IL IN MI OH WI 03	72506644			
-----------	---	----	----------------------	----------	--	--	--

260371844	1	EA	IL IN MI OH WI 03	80001640			
-----------	---	----	----------------------	----------	--	--	--

260372479	1	EA	IL IN MI OH WI 03	82100039			
-----------	---	----	----------------------	----------	--	--	--

GENERAL

260371851	1	EA	IL IN MI OH WI 03 03 03 03	80002372			
-----------	---	----	-------------------------------	----------	--	--	--

260385711	1	EA	IL IN MI OH WI 03	80002851			
-----------	---	----	----------------------	----------	--	--	--

260385695	1	EA	IL IN MI OH WI 03 03 03	80002373			
-----------	---	----	----------------------------	----------	--	--	--

260372586	1	EA	IL IN MI OH WI 03	80002853			
-----------	---	----	----------------------	----------	--	--	--

DATA VOICE

260371877	1	EA	IL IN MI OH WI 03 03	83250056			
-----------	---	----	-------------------------	----------	--	--	--

260385729	1	EA	IL IN MI OH WI 03 03	80002854			
-----------	---	----	-------------------------	----------	--	--	--

260371893	1	EA	IL IN MI OH WI 03 03 03	83250057			
-----------	---	----	----------------------------	----------	--	--	--

260385737	1	EA	IL IN MI OH WI 03 03	80003001			
-----------	---	----	-------------------------	----------	--	--	--

PRODUCT IDENTIFIER		DESCRIPTION							
ITEM NUMBER	ORD. MULT.	SELL UNIT	STD. PKG. STOCK AVAILABILITY / PA	LEAD TIME			MIN. ORD.	A C	
260371887		CARD STATION PCB 80003002							
1957902	1	EA	IL IN MI OH WI 03 03 03 03						
260385745		CARD SYSTEM ADAPTER 80000780							
1963306	1	EA	IL IN MI OH WI 03						
260385752		CARD SYSTEM ADAPTER 80000781							
1963314	1	EA	IL IN MI OH WI 03						
260372321		CARD SYSTEM ADAPTER 80000782							
1957837	1	EA	IL IN MI OH WI 03						
260396130		CARD SYSTEM ADAPTER 80001232							
1967356	1	EA	IL IN MI OH WI 03						
260385760		CARD SYSTEM ADAPTER 80001610							
1963322	1	EA	IL IN MI OH WI 03						
260372628		CARD SYSTEM ADAPTER 80001611							
1958611	1	EA	IL IN MI OH WI 03						
260385778		CARD SYSTEM ADAPTER 80002410							
1963330	1	EA	IL IN MI OH WI 03						
260372511		CARD SYSTEM ADAPTER 80002411							
1958710	1	EA	IL IN MI OH WI 03						
260371935		CARD WIRE DRIVER 72500705							
1958165	1	EA	IL IN MI OH WI 03						
260395785		COIL HAMMER ASSEMBLY 72501507							
1967000	1	EA	IL IN MI OH WI 03						
260370754		COLLAR TRACTOR DRIVE 72500780							
1956797	1	EA	IL IN MI OH WI 03						
260402391		CONTROLLER PCB 1361 72500880							
1968453	1	EA	IL IN MI OH WI 03						
260319587		CONTROLLER PRINTER F/N1303A							
1941617	1	EA	IL IN MI OH WI 03						
Lee data unit for Model 40 Printer, equipped with SPR #86-284, 88000830.									
260395843		DETECTOR PAPER MOTION 72501524							
1967067	1	EA	IL IN MI OH WI 03						
260396346		DISK 5.25IN 1/2 HGT 82500066							
1967562	1	EA	IL IN MI OH WI 03						

PRODUCT IDENTIFIER		DESCRIPTION							
ITEM NUMBER	ORD. MULT.	SELL UNIT	STD. PKG. STOCK AVAILABILITY / PA	LEAD TIME			MIN. ORD.	A C	
260396312		DISK TPI 1/2 HGT-96 82500064							
1967539	1	EA	IL IN MI OH WI 03						
260393830		DISPLAY TE5154 82501032							
1966416	1	EA	IL IN MI OH WI 03						
260386024		DRIVE DISK 82500059							
1963587	1	EA	IL IN MI OH WI 03						
260371703		DRIVE DISK 82500093							
1957928	1	EA	IL IN MI OH WI 03						
260372594		DRIVE DISK 720K 82500086							
1958512	1	EA	IL IN MI OH WI 03						
260372503		DRIVE FLOPPY 1.2MG 82500067							
1958652	1	EA	IL IN MI OH WI 03						
260403381		DRIVE FLOPPY 1.44M 72506620							
1968669	1	EA	IL IN MI OH WI 03						
260372487		DRIVE FLOPPY 1.6MG 82500094							
1958389	1	EA	IL IN MI OH WI 03						
260393772		DRIVE HARD 82500069							
1966333	1	EA	IL IN MI OH WI 03						
260385802		DRIVE HARD 10MBS70 82500065							
1963363	1	EA	IL IN MI OH WI 03						
260372388		DRIVE HARD 10MBS70 87100006							
1958488	1	EA	IL IN MI OH WI 03						
260372404		DRIVE HARD 20MB 87100093							
1958462	1	EA	IL IN MI OH WI 03						
260403530		DRIVE HARD 20MEG 82503111							
1968818	1	EA	IL IN MI OH WI 03						
260372495		DRIVE HARD 40MEG 82501053							
1958371	1	EA	IL IN MI OH WI 03						
260386230		DRIVE HARD 40MEG 82501060							
1963645	1	EA	IL IN MI OH WI 03						
260403563		DRIVE HARD 40MEG 82503112							
1968842	1	EA	IL IN MI OH WI 03						
260411228		DRIVE HARD DISK 82500069							
1971044	1	EA	IL IN MI OH WI 03						

DISTRIBUTION SERVICES
 NETWORK SERVICES
 TOOLS
 BUILDING JANITORIAL
 AUTOMOTIVE
 FORMS/OFFICE SUPPLIES
 GENERAL
 DATA VOICE

APERTUS/LEE DATA MAINTENANCE SPARES

DISTRIBUTION SERVICES

NETWORK SERVICES

TOOLS

BUILDING JANITORIAL

AUTOMOTIVE

FORMS/OFFICE SUPPLIES

GENERAL

DATA VOICE

PRODUCT IDENTIFIER	DESCRIPTION						
ITEM NUMBER	ORD. MULT.	SELL UNIT	STD. PKG. STOCK AVAILABILITY / PA	LEAD TIME	MIN. ORD.	A	C
260396049			DRIVE MOTOR RIBBON	72501536			
1967265	1	EA	IL IN	MI OH WI	03 03		
260370762			DRIVE SPLN TRACTOR	72500781			
1956805	1	EA	IL IN	MI OH WI	03 03		
260393608			FAN ASSEMBLY	72500720			
1966382	1	EA	IL IN	MI OH WI	03 03		
260395769			FAN ASSEMBLY	72501504			
1966986	1	EA	IL IN	MI OH WI	03 03		
260393624			FAN ASSEMBLY	83230022			
1966432	1	EA	IL IN	MI OH WI	03 03		
260417290			FAN ASSEMBLY	83230031			
1972471	1	EA	IL IN	MI OH WI	03 03		
260402086			GUIDE ASSEMBLY 1381	72500901			
1968149	1	EA	IL IN	MI OH WI	03 03		
260395827			GUIDE RIBBON ASSY LT	72501521			
1967042	1	EA	IL IN	MI OH WI	03 03		
260395835			GUIDE RIBBON ASSY RT	72501522			
1967059	1	EA	IL IN	MI OH WI	03 03		
260395728			HARNESS	72500725			
1966945	1	EA	IL IN	MI OH WI	03 03		
260395736			HARNESS	72500726			
1966952	1	EA	IL IN	MI OH WI	03 03		
260402185			KEYBOARD 84 KEY 880	82501590			
1968396	1	EA	IL IN	MI OH WI	03 03		
260385828			KEYBOARD 122 KEY	82501552			
1963389	1	EA	IL IN	MI OH WI	03 03		
260385836			KEYBOARD 122 KEY	82501553			
1963397	1	EA	IL IN	MI OH WI	03 03		
260385844			KEYBOARD 122 KEY	82501555			
1963405	1	EA	IL IN	MI OH WI	03 03		
260372810			KEYBOARD 122 KEY	82502553			
1958629	1	EA	IL IN	MI OH WI	03 03		
260385851			KEYBOARD 122 KEY	82502753			
1963413	1	EA	IL IN	MI OH WI	03 03		

PRODUCT IDENTIFIER	DESCRIPTION						
ITEM NUMBER	ORD. MULT.	SELL UNIT	STD. PKG. STOCK AVAILABILITY / PA	LEAD TIME	MIN. ORD.	A	C
260402219			KEYBOARD 122 KEY 880	82501573			
1968362	1	EA	IL IN	MI OH WI	03 03		
260372602			KEYBOARD 122 KEY TW	82501550			
1958637	1	EA	IL IN	MI OH WI	03 03		
260385810			KEYBOARD 122 KEY TW	82501551			
1963371	1	EA	IL IN	MI OH WI	03 03		
260395850			MASK RIBBON	72501525			
1967075	1	EA	IL IN	MI OH WI	03 03		
260396098			MEMORY 128K PCB F/N1103				
1967915	1	EA	IL IN	MI OH WI	03 03		
260423975			MODULE ACM ASYNC	F/N5610 85000005			
1976340	1	EA	IL IN	MI OH WI	03 03		
Asynchronous Communications Module.							
260423991			MODULE ACM ASYNC	F/N5630 85000011			
1976373	1	EA	IL IN	MI OH WI	03 03		
16 port Asynchronous Communications Module.							
260372214			MODULE COLOR SHIFT	72500851			
1958280	1	EA	IL IN	MI OH WI	03 03		
260424049			MODULE ELM	F/N5710 85000018			
1976407	1	EA	IL IN	MI OH WI	03 03		
Ethernet Lan Module.							
260424189			MODULE LCM	F/N5400			
1976878	1	EA	IL IN	MI OH WI	03 03		
Local Communications Module.							
260423819			MODULE LDM 16 PORT	F/N5100			
1976134	1	EA	IL IN	MI OH WI	03 03		
16 port 128LU Coax-L Device Module.							
260423835			MODULE LDM 32 PORT	F/N5110 85000003			
1976167	1	EA	IL IN	MI OH WI	03 03		
32 port 128LU Coax-L Device Module.							
260423850			MODULE LDM 32 PORT	F/N5120 85000012			
1976191	1	EA	IL IN	MI OH WI	03 03		
32 port Twisted Pair 128LU Coax-L Device Module.							
260424106			MODULE LSM	F/N5090 85000023			
1976498	1	EA	IL IN	MI OH WI	03 03		
Loader Service Module for F/N5005, 5010, 5020.							

APERTUS/LEE DATA MAINTENANCE SPARES

PRODUCT IDENTIFIER		DESCRIPTION					
ITEM NUMBER	ORD. MULT.	SELL UNIT	STD. PKG. STOCK AVAILABILITY / PA	LEAD TIME	MIN. ORD.	A C	
260403449		MODULE MEMORY	72506642				
1968727	1	EA	IL IN MI OH WI	03			
260423884		MODULE PDM 4 PORT F/N5215	85000017				
1976225	1	EA	IL IN MI OH WI	03 03 03			
4 port Plug Compatible Device Module.							
260424239		MODULE PDM 16 PORT F/N5230					
1976753	1	EA	IL IN MI OH WI	03 03 03			
Plug Compatible Device Module.							
260424221		MODULE PDM 32 PORT F/N5235					
1976787	1	EA	IL IN MI OH WI	03 03 03			
Plug Compatible Device Module.							
260424163		MODULE PDM 32 TWPR F/N5240					
1976811	1	EA	IL IN MI OH WI	03 03 03			
32 twisted pair 128LU Plug Compatible Device Module.							
260372305		MODULE PRINTER	72505530 1344				
1958199	1	EA	IL IN MI OH WI	03 03 03			
260423934		MODULE RCM RS232 F/N5500	85000008				
1976282	1	EA	IL IN MI OH WI	03 03 03			
Remote Communications Module.							
260423959		MODULE RCM V.35 F/N5500	85000009				
1976316	1	EA	IL IN MI OH WI	03 03 03			
Remote Communications Module.							
260423900		MODULE TDM 16 PORT F/N5300	89005000				
1976258	1	EA	IL IN MI OH WI	03 03 03			
16 port AT&T Device Module.							
260424064		MODULE TLM F/N5720	85000021				
1976431	1	EA	IL IN MI OH WI	03 03 03			
4MB Token Ring Lan Module.							
260424080		MODULE TLM 16 4MB F/N5725	85000022				
1976464	1	EA	IL IN MI OH WI	03 03 03			
Token Ring Lan Module.							
260396288		MONITOR 1240	82500004				
1967505	1	EA	IL IN MI OH WI	03			
260403597		MONITOR 14IN VGA	82504610				
1968875	1	EA	IL IN MI OH WI	03			
260388087		MONITOR ASSEMBLY	82500006				
1964023	1	EA	IL IN MI OH WI	03			

PRODUCT IDENTIFIER		DESCRIPTION					
ITEM NUMBER	ORD. MULT.	SELL UNIT	STD. PKG. STOCK AVAILABILITY / PA	LEAD TIME	MIN. ORD.	A C	
260385869		MONITOR ASSEMBLY	82500007				
1963421	1	EA	IL IN MI OH WI	03 03 03			
260393806		MONITOR ASSEMBLY	82500727				
1966366	1	EA	IL IN MI OH WI	03			
260374152		MONITOR ASSEMBLY	82501025				
1958041	1	EA	IL IN MI OH WI	03			
260371869		MONITOR ASSEMBLY	82501040				
1958090	1	EA	IL IN MI OH WI	03 03			
260372578		MONITOR ASSEMBLY	82501042				
1958645	1	EA	IL IN MI OH WI	03 03 03 03			
260403357		MONITOR ASSEMBLY	82501044				
1968990	1	EA	IL IN MI OH WI	03			
260436076		MONITOR ASSEMBLY	F/N2131				
1980730		EA	IL IN MI OH WI				
260372156		MOTOR CARRIAGE	72500885				
1958330	1	EA	IL IN MI OH WI	03 03 03			
260372289		MOTOR LINE FEED	72505528				
1958215	1	EA	IL IN MI OH WI	03			
260372172		MOTOR PAPER STEP	72500898				
1958314	1	EA	IL IN MI OH WI	03 03 03			
260371968		MOTOR PAPERFEED	72500707				
1958561	1	EA	IL IN MI OH WI	03 03 03			
260371976		MOTOR RIBBON DRIVE	72500708				
1958553	1	EA	IL IN MI OH WI	03 03 03			
260372271		MOTOR RIBBON DRIVE	72505527				
1958223	1	EA	IL IN MI OH WI	03			
260393681		MOTOR SHUTTLE	72500735				
1966242	1	EA	IL IN MI OH WI	03 03 03			
260372297		MOTOR SHUTTLE	72505529				
1958207	1	EA	IL IN MI OH WI	03			
260370796		NUT COLLAR	72500784				
1956839	1	EA	IL IN MI OH WI	03 03			
260393632		PANEL CABLE OPERATOR	83700082				
1966473	1	EA	IL IN MI OH WI	03 03			

DISTRIBUTION SERVICES

NETWORK SERVICES

TOOLS

BUILDING JANITORIAL

AUTOMOTIVE

FORMS/OFFICE SUPPLIES

GENERAL

DATA VOICE

APERTUS/LEE DATA MAINTENANCE SPARES

DISTRIBUTION SERVICES

PRODUCT IDENTIFIER		DESCRIPTION						MIN. A
ITEM	ORD.	SELL	STD. PKG.	LEAD TIME				
NUMBER	MULT.	UNIT	STOCK AVAILABILITY / PA		ORD.	C		

260372180 PANEL CONTROL 83250100
 1958306 1 EA IL IN MI OH WI
 03 03 03

NETWORK SERVICES

260372081 PANEL CONTROL ASSMBLY 83250014
 1958504 1 EA IL IN MI OH WI
 03 03 03

260372099 PANEL REAR 3287 83250015
 1958363 1 EA IL IN MI OH WI
 03 03 03

260370937 PANEL REAR ASSEMBLY 83250106
 1956979 1 EA IL IN MI OH WI
 03 03 03

TOOLS

260402334 PCB 1222 MAIN MONO 72507030
 1968248 1 EA IL IN MI OH WI
 03 03 03

260402300 PCB 1222 VIDEO MONO 72507029
 1968271 1 EA IL IN MI OH WI
 03 03 03

BUILDING JANITORIAL

260402243 PCB 2131 MAIN CLEAR 72507025
 1968339 1 EA IL IN MI OH WI
 03 03 03

260402276 PCB 2131 VIDEO CLEAR 72507026
 1968305 1 EA IL IN MI OH WI
 03 03 03

AUTOMOTIVE

260372412 PCB COLOR GRAPHICS 83250089
 1958454 1 EA IL IN MI OH WI
 03 03 03

260391073 PRINTER MONO 82500601
 1965392 1 EA IL IN MI OH WI
 03 03 03
 Lee Data, non-color, 400CPS.

FORMS/OFFICE SUPPLIES

260371950 PRINTER PERSONAL WORKSTATION 89004002
 1958181 1 EA IL IN MI OH WI
 03 03 03

260372008 PRINthead 72500722
 1958546 1 EA IL IN MI OH WI
 03 03 03

260372164 PRINthead 72500897
 1958322 1 EA IL IN MI OH WI
 03 03 03

GENERAL

260370804 PULLEY PAPERFERD MOTOR 72500785
 1956847 1 EA IL IN MI OH WI
 03 03 03

260370770 PULLEY TRACTOR DRIVE 72500782
 1956813 1 EA IL IN MI OH WI
 03 03 03

260370788 SCREW COLLAR 72500783
 1956821 1 EA IL IN MI OH WI
 03 03 03

DATA VOICE

PRODUCT IDENTIFIER		DESCRIPTION						MIN. A
ITEM	ORD.	SELL	STD. PKG.	LEAD TIME				
NUMBER	MULT.	UNIT	STOCK AVAILABILITY / PA		ORD.	C		

260402136 SENSOR HOME 1361 72500860
 1968198 1 EA IL IN MI OH WI
 03 03 03

260402128 SENSOR PAPER 1361 72500861
 1968180 1 EA IL IN MI OH WI
 03 03 03

260402680 SOFTWARE LIBRARY F/N5612
 1976639 1 EA IL IN MI OH WI
 03 03
 ASCII emulation.

260395793 SPRING HAMMER ASSEMBLY 72501508
 1967018 1 EA IL IN MI OH WI
 03 03 03

260392428 STATION EXPANSION COAX F/N1272
 1965970 1 EA IL IN MI OH WI
 03 03
 87100102. Used on FN1270.

260392436 STATION EXPANSION TWISTED PAIR F/N1271
 1965988 1 EA IL IN MI OH WI
 03 03
 87100064. Used on FN1271.

260385877 SUPPLY POWER 55500009
 1963439 1 EA IL IN MI OH WI
 03 03 03

260385885 SUPPLY POWER 55500013
 1963447 1 EA IL IN MI OH WI
 03 03 03

260371828 SUPPLY POWER 55500015
 1958058 1 EA IL IN MI OH WI
 03 03 03 03

260371885 SUPPLY POWER 55500022
 1958118 1 EA IL IN MI OH WI
 03 03 03

260372123 SUPPLY POWER 72500878
 1958355 1 EA IL IN MI OH WI
 03 03 03 03

260395926 SUPPLY POWER 72501510
 1967141 1 EA IL IN MI OH WI
 03 03 03

260403308 SUPPLY POWER 72506619
 1968610 1 EA IL IN MI OH WI
 03 03 03

260403332 SUPPLY POWER 72506643
 1968636 1 EA IL IN MI OH WI
 03 03 03

260403621 SUPPLY POWER 72506649
 1968909 1 EA IL IN MI OH WI
 03 03 03

260371745 SUPPLY POWER 83200006
 1957969 1 EA IL IN MI OH WI
 03 03 03

APERTUS/LEE DATA MAINTENANCE SPARES

PRODUCT IDENTIFIER		DESCRIPTION						
ITEM NUMBER	ORD. MULT.	SELL UNIT	STD. PKG. STOCK AVAILABILITY / PA	LEAD TIME	MIN. ORD.	A C		
260385893		SUPPLY POWER 83200015						
1963454	1	EA	IL IN MI OH WI 03 03					
260385901		SUPPLY POWER 83200017						
1963462	1	EA	IL IN MI OH WI 03 03					
260371752		SUPPLY POWER 83200021						
1957977	1	EA	IL IN MI OH WI 03 03 03 03					
260372370		SUPPLY POWER 83200022						
1958496	1	EA	IL IN MI OH WI 03 03					
260385919		SUPPLY POWER 83200027						
1963470	1	EA	IL IN MI OH WI 03 03					
260371711		SUPPLY POWER 83200028						
1957936	1	EA	IL IN MI OH WI 03 03 03 03					
260385927		SUPPLY POWER 83200029						
1963488	1	EA	IL IN MI OH WI 03 03					
260385935		SUPPLY POWER 83200030						
1963496	1	EA	IL IN MI OH WI 03 03 03					
260385943		SUPPLY POWER 83200031						
1963504	1	EA	IL IN MI OH WI 03 03 03					
260372420		SUPPLY POWER 200 WATT 55500027						
1958447	1	EA	IL IN MI OH WI 03 03					
260429857		SUPPLY POWER 24 VOLT 10 AMP						
1978163	1	EA	IL IN MI OH WI 03 03 03					
260429832		SUPPLY POWER 300 WATT F/N5010						
1978205		EA	IL IN MI OH WI 03 03 03					
260429733		SUPPLY POWER 600 WATT F/N5020						
1978247	1	EA	IL IN MI OH WI 03 03 03					
260402367		SUPPLY POWER F/N1222 72507032						
1968214	1	EA	IL IN MI OH WI 03 03					
260372836		SUPPLY POWER F/N1344 72505516						
1958603	1	EA	IL IN MI OH WI 03					
260372644		SUPPLY POWER F/N1344 72505517						
1958595	1	EA	IL IN MI OH WI 03					
260393921		SUPPLY POWER HI-VOLT 55500005						
1966531	1	EA	IL IN MI OH WI 03					

PRODUCT IDENTIFIER		DESCRIPTION						
ITEM NUMBER	ORD. MULT.	SELL UNIT	STD. PKG. STOCK AVAILABILITY / PA	LEAD TIME	MIN. ORD.	A C		
260393954		SUPPLY POWER LO-VOLT 55500012						
1966564	1	EA	IL IN MI OH WI 03					
260393897		SUPPLY POWER PCB 72507033						
1966507		EA	IL IN MI OH WI 03 03 03					
260429758		SWITCH 4 X 4 W/BACKPLANE						
1978189		EA	IL IN MI OH WI 03					
260424130		SWITCH 8 X 8 F/N5010 85000006						
1976589	1	EA	IL IN MI OH WI 03 03 03					
260424122		SWITCH 16 X 16 F/N5020 85000007						
1976613	1	EA	IL IN MI OH WI 03 03 03					
260393616		SWITCH LOW PAPER 72500718						
1966390	1	EA	IL IN MI OH WI 03 03 03					
260395868		SWITCH PAPER OUT 72501537						
1967083	1	EA	IL IN MI OH WI 03 03					
260395744		TRACTOR ASSEMBLY LEFT 72501502						
1966960	1	EA	IL IN MI OH WI 03 03					
260395751		TRACTOR ASSEMBLY RIGHT 72501503						
1966978	1	EA	IL IN MI OH WI 03 03					
260370721		TRACTOR LEFT 72500714						
1956763	1	EA	IL IN MI OH WI 03 03 03					
260370846		TRACTOR LEFT 72500871						
1956888	1	EA	IL IN MI OH WI 03 03 03					
260370739		TRACTOR RIGHT 72500715						
1956771	1	EA	IL IN MI OH WI 03 03 03					
260370853		TRACTOR RIGHT 72500872						
1956896	1	EA	IL IN MI OH WI 03 03 03					
260396379		TYPEWRITER KB 82500502						
1967596	1	EA	IL IN MI OH WI 03					
260385950		UNIT TAPE BACKUP 82500063						
1963512	1	EA	IL IN MI OH WI 03					
260372396		UNIT TAPE BACKUP 87100026						
1958470	1	EA	IL IN MI OH WI 03					

DISTRIBUTION SERVICES
 NETWORK SERVICES
 TOOLS
 BUILDING JANITORIAL
 AUTOMOTIVE
 FORMS/OFFICE SUPPLIES
 GENERAL
 DATA VOICE

DISTRIBUTION SERVICES

APERTUS/LEE DATA MAINTENANCE SPARES

PRODUCT IDENTIFIER		DESCRIPTION						
ITEM NUMBER	ORD. MULT.	SELL UNIT	STD. PKG. STOCK AVAILABILITY / PA	LEAD TIME	MIN. ORD.	A	C	

260424262 UPGRADE LDM 16 PORT F/N5115
 1976720 1 EA IL IN MI OH WI
 03 03 03
 128LU Coax-L Device Module.

NETWORK SERVICES

BAR CODE EQUIPMENT

260445879 INTERMEC 1261 DIGITAL WAND P/N
 1261A0101

N

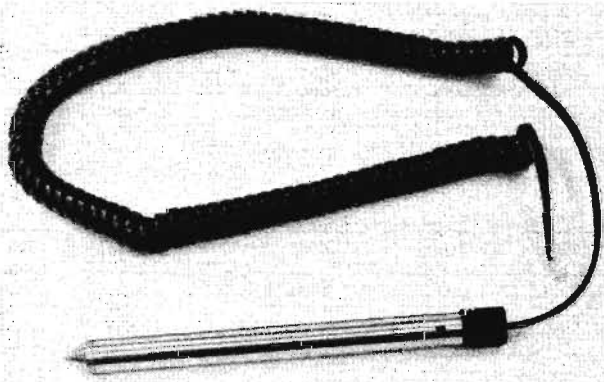

260445879

TOOLS

BUILDING JANITORIAL

260445895 INTERMEC 1545 INTERFACE CABLE P/N
 052900

N

Used to interface the 1545 Laser Scanner to
 the Portable Reader.

260445887 INTERMEC 1545 LASER SCANNER P/N 1545A

N

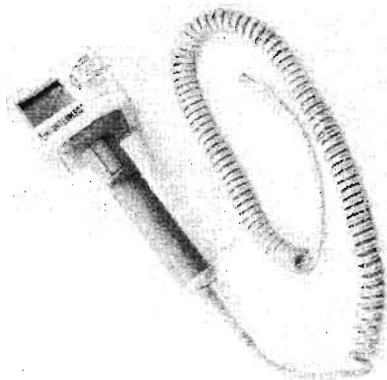

260445887

260445960 INTERMEC 8646 BAR CODE PRINTER
 THERMAL

N

TRANSFER P/N8646B0112.

AUTOMOTIVE

FORMS/OFFICE SUPPLIES

GENERAL

DATA VOICE

PRODUCT IDENTIFIER		DESCRIPTION						
ITEM NUMBER	ORD. MULT.	SELL UNIT	STD. PKG. STOCK AVAILABILITY / PA	LEAD TIME	MIN. ORD.	A	C	

260445853 INTERMEC 9440 BAR CODE READER

N

With 128K RAM. Does not include cord or
 wand. P/N 9440C020.



260445853

260445861 INTERMEC 9445 BAR CODE READER

N

With Integral Laser & 128K RAM. P/N
 9445C020102.



260445861

260445986 INTERMEC CABLE 25-25 PIN COMM DOCK TO
 PC

N

/XT. P/N 048668.

260445978 INTERMEC CABLE 9-25 PIN COMM DOCK TO
 PC/

N

AT. P/N 048693.

260446000 INTERMEC CABLE PCLM IBM PC/AT P/N
 047279

N

260445994 INTERMEC CABLE PCLM IBM PC/XT P/N
 047279

N

260445937 INTERMEC CARRYING CASE 9440 P/N 056047

N

DISTRIBUTION SERVICES

NETWORK SERVICES

TOOLS

BUILDING JANITORIAL

AUTOMOTIVE

FORMS/OFFICE SUPPLIES

GENERAL

DATA VOICE

PRODUCT IDENTIFIER		DESCRIPTION					A
ITEM NUMBER	ORD. MULT.	SELL UNIT	STD. PKG. STOCK AVAILABILITY / PA	LEAD TIME	MIN. ORD.		C

260445952 INTERMEC COMMUNICA DOCK TO UNLOAD DATA

N P/N 40D001.

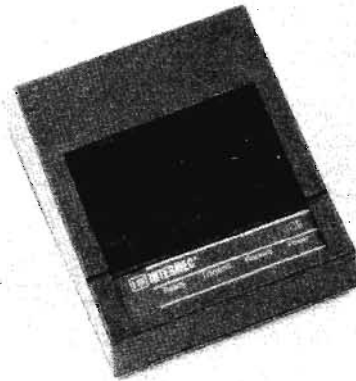

260445952

260446018 INTERMEC LABELS 3 X 1IN THERMAL TRANSFER

N Carton, P/N 049114.

260445911 INTERMEC NICAD BATTERY CHARGER/DISCHARGE

N P/N 40ZA02.



260445911

260445903 INTERMEC NICAD BATTERY SPARE P/N 048106

N

260445929 INTERMEC NICAD CHARGING STA POWER SUPPLY

N P/N 047793.

260446026 INTERMEC RIBBON THERMAL TRANS P/N 048523

N Carton.

260445945 INTERMEC SHLDR/BELT STRAP CARRYING CASE

N P/N 056541. For carrying case for portable bar code reader.

PRODUCT IDENTIFIER		DESCRIPTION					A
ITEM NUMBER	ORD. MULT.	SELL UNIT	STD. PKG. STOCK AVAILABILITY / PA	LEAD TIME	MIN. ORD.		C

CABINET DATA

401220546 CABINET DATA CK20018 L12A

N EA 1 4 1

401399456 CABINET DATA CK20018 L15A

1132308 1 EA IL IN MI OH WI
04 04 04 04 04

Cabinet for housing data sets and associated equipment at multiple data set installations, BSP 590-010-201.

401399464 CABINET DATA CK20018 L15B

N EA 1 4 1

401174909 CABINET DATA KS20018 L11A

1140467 1 EA IL IN MI OH WI
04 04 04 04 04

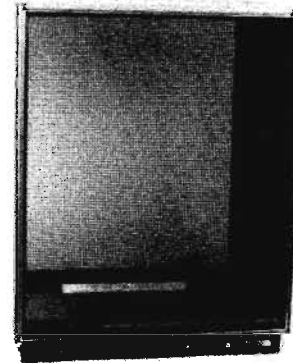

1140467

400408316 SHELF CK20018 L9C

N EA 1 4 2

401509773 SHELF CK20018 L9D

1104158 1 EA IL IN MI OH WI
04 04 04 04 04

Shelving associated with CK20018 L15A Data Cabinets. Used for stacking of various data sets, mounts on a 23in frame, BSP 590-010-201.

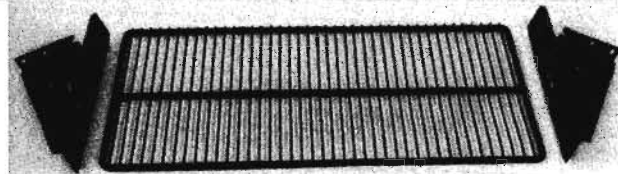

1104158

CALLER ID

260387402 DISPLAY CALLER ID 64- 1

N EA 1 2 1

260387394 DISPLAY CALLER ID SL-10

N EA 1 2 1

CORD DATA

DISTRIBUTION SERVICES

PRODUCT IDENTIFIER							DESCRIPTION						
ITEM	ORD.	SELL	STD. PKG.	LEAD TIME	MIN.	A	ITEM	ORD.	SELL	STD. PKG.	LEAD TIME	MIN.	A
NUMBER	MULT.	UNIT	STOCK AVAILABILITY / PA		ORD.	C	NUMBER	MULT.	UNIT	STOCK AVAILABILITY / PA		ORD.	C

NETWORK SERVICES

CORD DATA

260407697 CORD 4FT 84-0497-0-004 V.35
 1970848 1 EA
 Used to connect the resource module peripheral interface module (V.35 type) packet switch to the general DataComm modem shelf.

260407671 CORD 15FT 84-0468-0-015 RS232
 1970822 1 EA IL IN MI OH WI
 04
 Used to connect the DPN100/5 module peripheral interface module (QPA164) packet switch to the general DataComm modem shelf.

260407705 CORD 15FT 84-0497-0-015 V.35
 1970855 1 EA IL IN MI OH WI
 04
 Used to connect the resource module peripheral interface module (V.35 type) packet switch to the general DataComm modem shelf.

260407689 CORD 20FT 84-0468-0-020 RS232
 1970830 1 EA IL IN MI OH WI
 04
 Used to connect the DPN100/5 module peripheral interface module (QPA164) packet switch to the general DataComm modem shelf.

260407713 CORD 20FT 84-0497-0-020 V.35
 1970863 1 EA IL IN MI OH WI
 04
 Used to connect the resource module peripheral interface module (V.35 type) packet switch to the general DataComm modem shelf.

260407663 CORD 25FT 84-0468-0-025 RS232
 1970814 1 EA IL IN MI OH WI
 04
 Used to connect the DPN100/5 module peripheral interface module (QPA164) packet switch to the general DataComm modem shelf.

260407721 CORD 25FT 84-0497-0-025 V.35
 1970871 1 EA IL IN MI OH WI
 04
 Used to connect the resource module peripheral interface module (V.35 type) packet switch to the general DataComm modem shelf.

260407655 CORD 30FT 84-0468-0-030 RS232
 1970806 1 EA IL IN MI OH WI
 04
 Used to connect the DPN100/5 module peripheral interface module (QPA164) packet switch to the general DataComm modem shelf.

260407648 CORD 30FT 84-0497-0-030 V.35
 1970798 1 EA IL IN MI OH WI
 04
 Used to connect the resource module peripheral interface module (V.35 type) packet switch to the general DataComm modem shelf.

260327739 CORD DATA M 8K 87 5FT 6IN GCC
 1945436 1 EA IL IN MI OH WI
 04 04 04 04 04

TOOLS

BUILDING JANITORIAL

AUTOMOTIVE

FORMS/OFFICE SUPPLIES

GENERAL

DATA VOICE

PRODUCT IDENTIFIER							DESCRIPTION						
ITEM	ORD.	SELL	STD. PKG.	LEAD TIME	MIN.	A	ITEM	ORD.	SELL	STD. PKG.	LEAD TIME	MIN.	A
NUMBER	MULT.	UNIT	STOCK AVAILABILITY / PA		ORD.	C	NUMBER	MULT.	UNIT	STOCK AVAILABILITY / PA		ORD.	C

260327721 CORD DATA M13F 5 6FT GCC
 1945428 1 EA IL IN MI OH WI
 03
 DISCONTINUE, ORDER NON STOCK UPON STOCK DEPLETION

260327770 CORD DATA M16M 87 1FT GCC
 1945477 1 EA IL IN MI OH WI
 04 04 04
 DISCONTINUE, ORDER NON STOCK UPON STOCK DEPLETION

260327754 CORD DATA M16N 87 1FT GCC
 1945451 1 EA IL IN MI OH WI
 04 04
 DISCONTINUE, ORDER NON STOCK UPON STOCK DEPLETION

102269636 CORD DATA M25A 50FT
 N EA 1 3 1

260327705 CORD DATA M25A 87 9FT GCC
 1945402 1 EA IL IN MI OH WI
 04 04 04 04 04

102269628 CORD DATA M25A 87 25FT
 1952150 1 EA IL IN MI OH WI
 04

260327697 CORD DATA M25B 87 10FT GCC
 1945394 1 EA IL IN MI OH WI
 04 04 04 04 04

260327663 CORD DATA M25B 87 25FT GCC
 1945360 1 EA IL IN MI OH WI
 04 04 04 04 04

260345079 CORD DATA M25C 5FT
 N EA 1 3 1
 Female to female.

260327762 CORD DATA M4AS 87 7FT GCC
 1945469 1 EA IL IN MI OH WI
 04 04 04 04 04

260327747 CORD DATA M4AU 87 7FT GCC
 1945444 1 EA IL IN MI OH WI
 04 04 04 04 04

DISABLED SERVICES EQUIPMENT

403961469 AMP PORT TELEPHONE ACOUSTIC MODEL 300
 N EA 6 8 24

103314928 LARYNX ARTIFICIAL 5E60
 N EA 1 5 1

300032141 PORTA PRINTER PLUS
 1178152 1 EA IL IN MI OH WI
 04 04

260419403 SET HAND W6-500M-00
 N EA 1 2 1

PRODUCT IDENTIFIER DESCRIPTION

ITEM NUMBER	ORD. MULT.	SELL UNIT	STD. PKG. STOCK AVAILABILITY / PA	LEAD TIME	MIN. ORD.	A C
-------------	------------	-----------	-----------------------------------	-----------	-----------	-----

260366414 SIGNALLER DOORBELL WATCHMAN

N EA 1 4 1
Used by the hearing impaired to flash lamp when doorbell is ringing. Manufactured by Ultratec.

260374186 SIGNALLER PHONEMASTER WATCHMAN

N EA 1 4 1
Used by the hearing impaired to flash a lamp when the telephone rings. Ultratec.

260366422 SIGNALLER RECEIVER WATCHMAN

N EA 1 4 1
This is a master unit used by the hearing impaired to capture signals from all the other Watchman Signallers in the house. Manufactured by Ultratec.

260374178 SIGNALLER SOUNDMASTER WATCHMAN

N EA 1 4 1
Used by the hearing impaired to flash lamp when there is a sound. the unit will adjust to flash at different speeds for different sounds. Manufactured by Ultratec.

405856352 SPEAKERPHONE RC3000

N
Designed for the Motion Impaired. Use in conjunction with Sip & Puff Switch and several other switches to assist the Motion Impaired with communication.

280012022 SUPERPRINT TDD MODEL 400

1921569	1	EA	IL	IN	MI	OH	WI
			04	04			

260365796 T.D.D. SUPERCOM

N EA 1 4 1
Ultra-Tec telecommunications device for the deaf, with 8,000 characters of memory, printer port for external printer, 20 character display, auto answer, keyboard or memory dialing.

260366356 T.D.D. SUPERPRINT 400E

N EA 1 4 1
Ultra-Tec telecommunications device for the deaf, with memory to save and send messages, 24 character printer, 20 character display, auto-answer TDD Announcer(built-in voice) rechargeable battery case

PRODUCT IDENTIFIER DESCRIPTION

ITEM NUMBER	ORD. MULT.	SELL UNIT	STD. PKG. STOCK AVAILABILITY / PA	LEAD TIME	MIN. ORD.	A C
-------------	------------	-----------	-----------------------------------	-----------	-----------	-----

HEADSET

260432760 ADAPTER HEADSET M10C MODULAR

1979633 1 EA
SOE

Plantronics low-compression, modular adapter with rotary volume control and mute switch, which is the bottom half of a headset. The headset top must also be ordered to make a complete headset.

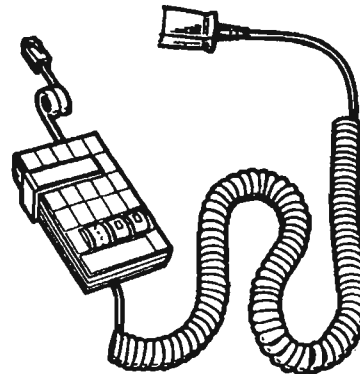

260432760

260432737 ADAPTER HEADSET P10C 2-PRONG

1979609	1	EA	IL	IN	MI	OH	WI
SOE			04			04	04

Plantronics low-compression, 2-prong adapter with rotary volume control, which is the bottom half of a headset. The headset top must also be ordered to make a complete headset.

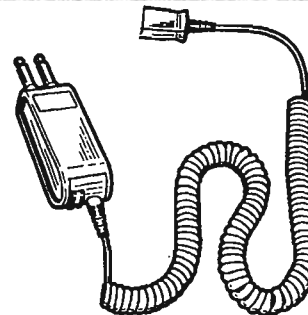

1979609

280036856 HEADSET 909-0452 AAQ M/D

1926642	1	EA	IL	IN	MI	OH	WI
GF			04	04		04	04

GN NETCOM Over-the-head. No quick disconnect.

300051976 HEADSET 0451 AC W/5FT CORD

5118331	1	EA	IL	IN	MI	OH	WI
GF			04	04		04	

GN NETCOM 808-0433 No mute switch, no volume control.

300055183 HEADSET 0451 AMP W/5FT CORD

5118356	1	EA	IL	IN	MI	OH	WI
GF			04	04	04	04	

GN NETCOM 808-0451 No mute switch, no quick disconnect. With volume control.

DISTRIBUTION SERVICES

NETWORK SERVICES

TOOLS

BUILDING JANITORIAL

AUTOMOTIVE

FORMS/OFFICE SUPPLIES

GENERAL

DATA VOICE

HEADSET

PRODUCT IDENTIFIER		DESCRIPTION						
ITEM	ORD.	SELL	STD. PKG.	LEAD TIME		MIN.	A	
NUMBER	MULT.	UNIT	STOCK AVAILABILITY / PA		ORD.	C		
260377627 HEADSET OPERATOR 303-0452								
1959817	1	EA	IL	IN	MI	OH	WI	
GF			04	04	04	04	04	
Over-the-Head.								
260388194 HEADSET OPERATOR H31-P10C								
1964072	1	EA	IL	IN	MI	OH	WI	
GF			04	04	04	04	04	
Plantronics Starset in-the-ear headset, quick disconnect, 2 prong connector, 10ft cord, black in color. Equivalent to HSB343-9 PID # 260324801.								
260388178 HEADSET OPERATOR H32-P10C								
1964056	1	EA	IL	IN	MI	OH	WI	
GF			04	04	04	04	04	
Plantronics Starset in-the-ear operator headset, 2 prong connector, 10ft cord, black, no quick disconnect. Equivalent to H32-P10C. REPLACES HS0308-9 PID # 260325642.								
260432711 HEADSET OPERATOR H42-P10C								
1979583	1	EA	IL	IN	MI	OH	WI	
SOE			04			04	04	
Plantronics low-compression, 2-prong Mirage (over-the-ear) style complete headset, rotary volume control, no quick disconnect.								
260388202 HEADSET OPERATOR H51-P10C								
1964080	1	EA	IL	IN	MI	OH	WI	
GF			04	04	04	04	04	
Plantronics Supra monaural headband style headset, quick disconnect, 2 prong connector, 10FT cord, black in color. Equivalent to HSB552-9. REPLACES HS0552-9 PID # 260324819.								
260385257 HEADSET OPERATOR H52-P10C								
1962811	1	EA	IL	IN	MI	OH	WI	
GF			04	04	04	04	04	
Plantronics Supra monaural headband style headset, no quick disconnect, 10FT cord, 2 prong connector, black in color. Equivalent to HSB550-9. REPLACES HS0550-9, PID # 260324827.								
260388186 HEADSET OPERATOR H61-P10C								
1964064	1	EA	IL	IN	MI	OH	WI	
GF			04	04	04	04	04	
Plantronics Supra binaural headband style headset, quick disconnect, 2 prong connector, 10FT cord, black in color. Equivalent to HSB556-9. Replaces HS0556-9, PID 260324793.								
260388210 HEADSET OPERATOR H62-P10C								
1964098	1	EA	IL	IN	MI	OH	WI	
GF			04	04	04	04	04	
Plantronics Supra binaural headband style headset, no quick disconnect, 2 prong connector, 10FT cord, black in color. Equivalent to HSB554-9. Replaces HSO554-9, PID 260324835.								

PRODUCT IDENTIFIER		DESCRIPTION						
ITEM	ORD.	SELL	STD. PKG.	LEAD TIME		MIN.	A	
NUMBER	MULT.	UNIT	STOCK AVAILABILITY / PA		ORD.	C		

260388228 HEADSET OPERATOR HSB309-9 SUPERVISOR							
1964148	1	EA	IL	IN	MI	OH	WI
SOE			04	04	04	04	04
Plantronics Starset in-the-ear supervisor headset, no quick disconnect, with a push-to talk switch, 2 prong connector, 10ft cord, black REPLACES HS0309-9 PID # 260324843.							

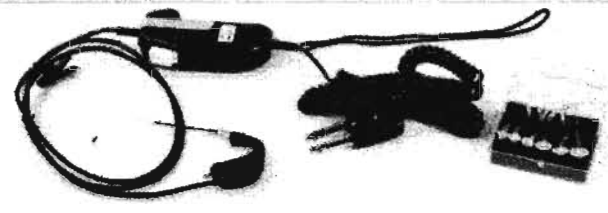

1964148

260426341 HEADSET OPERATOR HSB409-9 SUPERVISOR							
N		EA					
GF				1		5	1

Plantronics Mirage style headset, on-the-ear, monaural, supervisor push-to-talk switch, 10FT cord.

260388236 HEADSET OPERATOR HSB551-9 SUPERVISOR							
1964155	1	EA	IL	IN	MI	OH	WI
SOE			04	04	04	04	04

Plantronics Supra monaural headband style supervisor headset, no quick disconnect, with a push-to-talk switch, 10FT cord, 2-prong connector, black REPLACES HS0551-9 PID # 260324850.

260388244 HEADSET OPERATOR HSB553-9 SUPERVISOR							
1964163	1	EA	IL	IN	MI	OH	WI
GF			04	04	04	04	04

Plantronics Supra binaural headband style supervisor headset, no quick disconnect with a push-to-talk switch, 2 prong connector, 10FT cord, black in color. REPLACES HS0553-9 PID # 260324868.

260338553 HEADSET SMH1396-01							
1948430	1	EA	IL	IN	MI	OH	WI
GF				04			04

Plantronics low compression modular Starset.

260432752 TOP HEADSET H31 STARSET							
1979625	1	EA	IL	IN	MI	OH	WI
SOE			04	04		04	04

Plantronics STARSET (in-the-ear) style headset top. The bottom adapter (modular or 2-prong) must also be ordered to make a complete headset.

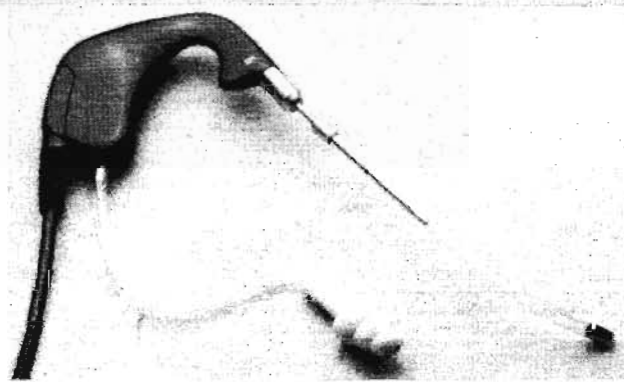

1979625

DISTRIBUTION SERVICES

NETWORK SERVICES

TOOLS

BUILDING JANITORIAL

AUTOMOTIVE

FORMS/OFFICE SUPPLIES

GENERAL

DATA VOICE

DISTRIBUTION SERVICES

NETWORK SERVICES

TOOLS

BUILDING JANITORIAL

AUTOMOTIVE

FORMS/OFFICE SUPPLIES

GENERAL

DATA VOICE

PRODUCT IDENTIFIER		DESCRIPTION					
ITEM NUMBER	ORD. MULT.	SELL UNIT	STD. STOCK	PKG. AVAILABILITY / PA	LEAD TIME	MIN. ORD.	A

260432745 TOP HEADSET H41 MIRAGE

1979617	1	EA	IL 04	IN 04	MI	OH 04	WI 04	
---------	---	----	-------	-------	----	-------	-------	--

Plantronics Mirage (over-the-ear) style headset top. The bottom adapter must also be ordered to make a complete headset.

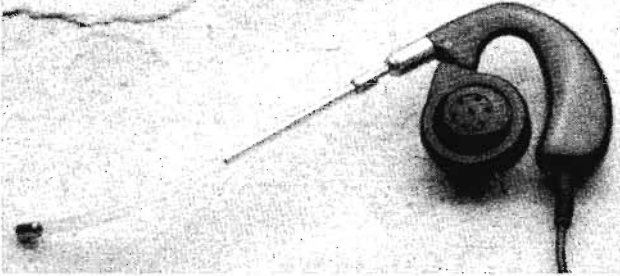

1979617

260432778 TOP HEADSET H51 SUPRA MONAURAL

1979641	1	EA	IL 04	IN 04	MI	OH 04	WI 04	
---------	---	----	-------	-------	----	-------	-------	--

Plantronics Supra monaural (over-the-head) style headset top. The bottom adapter (modular or 2-prong) must be ordered to make a complete headset.

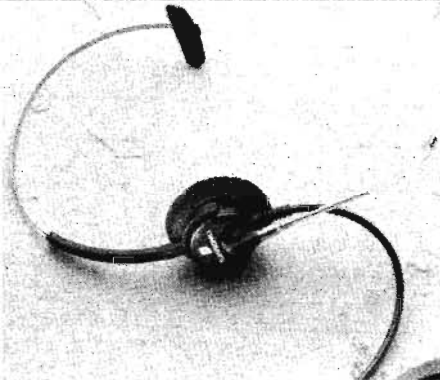

1979641

260432729 TOP HEADSET H61 SUPRA BINAURAL

1979591	1	EA	IL 04	IN 04	MI	OH 04	WI 04	
---------	---	----	-------	-------	----	-------	-------	--

Plantronics Supra binaural (over-the-head) headset top, the bottom adapter (modular or 2-prong) must also be ordered to make a complete headset.

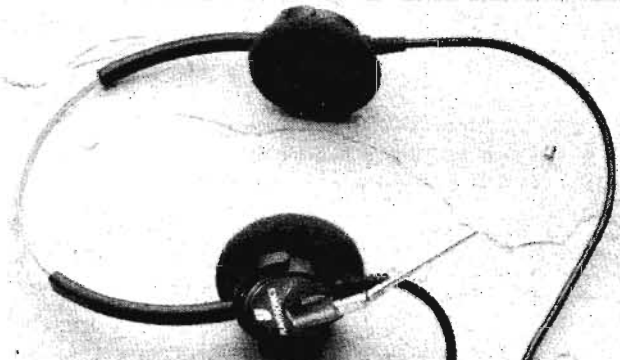

1979591

PRODUCT IDENTIFIER		DESCRIPTION					
ITEM NUMBER	ORD. MULT.	SELL UNIT	STD. STOCK	PKG. AVAILABILITY / PA	LEAD TIME	MIN. ORD.	A

HEADSET ACCESSORIES

260386628 ADAPTER HEADSET 500A 96

1963900	1	PK						
---------	---	----	--	--	--	--	--	--

Used to connect a standard headset to an ISDN telephone.

260376009 EARCUSHION FOAM 15729-02

1957795	1	PR	IL 12	IN 12	MI 12	OH 12	WI 12	
---------	---	----	-------	-------	-------	-------	-------	--

Plantronics earm cushion for Supra headsets. Nutmeg in color.

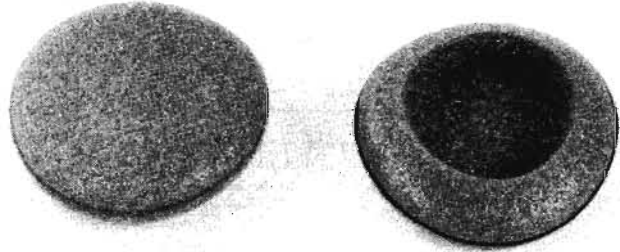

1957795

260375977 EARCUSHION LEATHERETTE 19025-02

1957803	1	PR	IL 12	IN 12	MI	OH 12	WI 12	
---------	---	----	-------	-------	----	-------	-------	--

Plantronics leatherette earm cushion for Supra headsets. Use of these may increase ability to hear.

300055373 EARHOOK FOR HEADSET

N		PK			1		4		1
---	--	----	--	--	---	--	---	--	---

Package of 10.

300055415 EARPHONE-470 OHM

N		EA			1		2		1
---	--	----	--	--	---	--	---	--	---

260375951 HEADBAND TENSIONER 17876-01

1957787	1	EA	IL 12	IN 12	MI	OH 12	WI 12		E
---------	---	----	-------	-------	----	-------	-------	--	---

Plantronics accessory which allows for a more custom fit of Supra headset headband.

260441928 JACKBOX HEADSET A97001085

N		EA			1		6		1
---	--	----	--	--	---	--	---	--	---

402363360 JACKSET JS0180-2 TYPE

1168252	1	EA	IL 04	IN 04	MI 04	OH 04	WI 04	
---------	---	----	-------	-------	-------	-------	-------	--

Provides the interface between a standard telephone and 2-prong headset. 6 1/2FT cable must be hardwired to the telephone and is ivory in color.

402363352 JACKSET JSB180-1 TYPE

1176719	1	EA	IL 04	IN 04	MI 04	OH 04	WI 04	
---------	---	----	-------	-------	-------	-------	-------	--

Provides the interface between a standard telephone and 2-prong headset. 18IN cable must be hardwired to the telephone and is ivory in color.

DISTRIBUTION SERVICES

NETWORK SERVICES

TOOLS

BUILDING JANITORIAL

AUTOMOTIVE

FORMS/OFFICE SUPPLIES

GENERAL

DATA VOICE

HEADSET SPARE PARTS

PRODUCT IDENTIFIER		DESCRIPTION						
ITEM NUMBER	ORD. MULT.	SELL UNIT	STD. PKG. STOCK AVAILABILITY / PA	LEAD TIME	MIN. ORD.	A	C	

HEADSET SPARE PARTS

401542014 EARPIECE CK20778 L26A 09288-02

N EA 1 2 1
Single eartip for the Plantronics Starset II, size 2 or Small.

401500657 EARPIECE CK20778 L27A 09288-03

N EA 1 2 1
Single eartip for the Plantronics Starset II, size 3 or Medium.

401873567 EARPIECE CK20778 L27A 09289-03

5301663 1 EA IL IN MI OH WI
04 04 04 04
Single eartip for Plantronics Starset I, size 3 or Medium.

401873575 EARPIECE CK20778 L28 09288-04

N EA 1 2 10
Single eartip for Plantronics Starset II, size 4 or Large.

401873583 EARPIECE CK20778 L29A 09288-05

N EA 1 3 5
Single eartip for Plantronics Starset II, size 5 or Extra-large.

401873534 EARPIECE HEADSET 09289-01

N EA 1 3 1
Single eartip for Plantronics Starset I, size 1 or Extra-small.

280080268 EARPIECE LARGE FOAM COVER

1936237 1 PK IL IN MI OH WI
04 04 04 04 04
GN Netcom 1436-50 Spare cover for 900 Series headset. Package of 10.

280036450 EARPIECE LARGE VINYL COVER

1923193 1 PK IL IN MI OH WI
04 04 04 04
GN Netcom 1436-55 spare cover for 900 Series Headset. Package of 10.

280080276 EARPIECE SMALL FOAM COVER

1936229 1 PK IL IN MI OH WI
04 04 04 04
GN Netcom 1436-48 eartip for 800 Series Headset. Package of 10.

280079807 EARPIECE SMALL VINYL COVER

1936260 1 PK IL IN MI OH WI
04 04 04 04
Package of 10.

PRODUCT IDENTIFIER		DESCRIPTION						
ITEM NUMBER	ORD. MULT.	SELL UNIT	STD. PKG. STOCK AVAILABILITY / PA	LEAD TIME	MIN. ORD.	A	C	

300055340 EARTIP FOAM CONICAL

1131714 1 PK IL IN MI OH WI
04 04 04 04 04
GN Netcom 1436-12 eartip for 800 Series Headset. Pkg/10.



1131714

280080284 EARTIP FOAM CYLINDRICAL

1936278 1 PK IL IN MI OH WI
04 04 04 04
GN Netcom eartip. Package of 10.

280080292 EARTIP PLASTIC CONICAL

1936211 1 PK IL IN MI OH WI
04 04 04 04 04
Package of 10.

300055316 EARTIP PLASTIC DOME

1923185 1 PK IL IN MI OH WI
04 04
Package of 36.

280079690 EARTIP PLASTIC DOME

1936245 1 PK IL IN MI OH WI
04 04 04 04
GN Netcom 1436-21 eartip for 800 Series Headset. Pkg/10.

280080250 EARTIP PLASTIC MUSHROOM

1936252 1 PK IL IN MI OH WI
04 04 04 04
GN Netcom 1436-11 eartip for 800 Series Headset.

300055332 EARTIP PLASTIC MUSHROOM

5118414 1 PK IL IN MI OH WI
04 04 04
GN Netcom eartip. Package of 36.

400693388 TUBE ACOUSTIC 17593-01

1311480 1 EA IL IN MI OH WI
04 04 04 04 04
Plantronics replacement voice tube for use with all CK20778 Headsets except noise cancelling models.

LAN CONNECTIVITY PRODUCTS STAR-TEK

260444591 CONVERTER RS232/RS485 10039

N

Intelligent converter includes local/remote communications cable. Specify #15700 Local DB9 to DB9, #15701 Local DB9 to DB232, or #15702 Remote DB9 to RS232.

LAN CONNECTIVITY PRODUCTS SYNOPTICS

PRODUCT IDENTIFIER DESCRIPTION

ITEM NUMBER	ORD. MULT.	SELL UNIT	STD. PKG. STOCK AVAILABILITY / PA	LEAD TIME	MIN. ORD.	A C
-------------	------------	-----------	-----------------------------------	-----------	-----------	-----

260444609 DUAL RATE MEDIA FILTER (DRMF) 11153 8FT
N

Provides twisted pair attachment for Token Ring devices. DB9 male connects to the Token Ring adapter card in attaching node and RJ45 plug provides connection to twisted pair wiring network.

260437751 DUAL RATE MEDIA FILTER (DRMF) 11153B 8FT

1981308 SOE	1	EA	IL 04	IN 04	MI 04	OH 04	WI 04
-------------	---	----	-------	-------	-------	-------	-------

Provides twisted pair attachment for token ring devices. DB-9 connects to the token ring adapter card in attaching node, & RJ45 plug provides connection to twisted pair wiring network. FOR REPAIR ONLY

260437769 DUAL RATE MEDIA FILTER (DRMF)11153B 25FT

1981290 SOE	1	EA	IL 04	IN 04	MI 04	OH 04	WI 04
-------------	---	----	-------	-------	-------	-------	-------

Provides twisted pair attachment for token ring devices. DB-9 connects to the token ring adapter card in attaching node, & RJ45 plug provides connection to twisted pair wiring network. FOR REPAIR ONLY

260444617 IMAU 828AT-5 10035

N

Intelligent Multi-station Access Unit for use on Token Ring LANs. Supports 4Mbps & 16Mbps over IBM Data Grade Media (DGM) shielded twisted pair cable.

260444625 IMAU 828AT-6 10037

N

Intelligent Multi-station Access Unit for use on Token Ring LANs. Supports 4Mbps & 16Mbps over Type 3 unshielded telephone twisted pair media.



260444625

260436217 IMAU 828AT-6 10037

1980656	1	EA	IL 04	IN 04	MI 04	OH 04	WI 04
---------	---	----	-------	-------	-------	-------	-------

Intelligent Multi-station Access Unit for use on Token Ring LANs. Supports 4Mbps & 16Mbps over IBM Type 3 unshielded telephone twisted pair media. FOR REPAIR ONLY.

260444633 IMAU 828AT-7 10043

N

Intelligent Multi-station Access Unit for use on Token Ring LANs. Supports 4Mbps & 16Mbps over unshielded telephone twisted pair media.



260444633

PRODUCT IDENTIFIER DESCRIPTION

ITEM NUMBER	ORD. MULT.	SELL UNIT	STD. PKG. STOCK AVAILABILITY / PA	LEAD TIME	MIN. ORD.	A C
-------------	------------	-----------	-----------------------------------	-----------	-----------	-----

LAN CONNECTIVITY PRODUCTS SYNOPTICS

260444559 ADAPTER DCE 808

N

DB25 Male to RJ45 DCE Adapter for Model 3395 Terminal Server.

260444542 ADAPTER DTE 807

N

DB25 Female to RJ45 DTE Adapter for Model 3395 Terminal Server.

260444567 ADAPTER DTE 809

N

DB9 Female to RJ45 DTE Adapter for Model 3395 Terminal Server.

260444575 ADAPTER RJ45 TO 50 PIN 810

N

Adapts from 8 RJ45 Connectors to a 50-pin Connector.

260444443 BACKPLANE ETHERNET/TOKEN RING 980-255

N

Includes Redundant Power Supply for Model 3000 Premises Concentrator.

260444435 BACKPLANE FDDI/ETHRNT/TOKEN RING 980-179

N

For Model 3000 Concentrator.

260444450 BACKPLANE FDDI/ETHRNT/TOKEN RING 980-275

N

Includes Ethernet, Token Ring, and Redundant Power Supply for Model 3000 Premises Concentrator.

260444583 BRACKET WALLMOUNT 980-240

N

Wallmount bracket for Model 354-ST Token Ring Fiber Optic Extender.

260444468 CABLE GUIDE 980-169

N

Cable guide for 19IN Rack Mount for System 3000 Concentrator.

260443874 CONCENTRATOR AREA 2310-02-A

N

10BASE-T preconfigured 36-port Ethernet Concentrator includes Power Supply, IP Firmware, and license for Advanced Network Interface Management Agent.

260443866 CONCENTRATOR DEPARTMENT 3030-04

N

Includes Chassis, Backplane with Ethernet, 2 Token Ring buses, dedicated Network Interface Management buses and Power Supply.

DISTRIBUTION SERVICES

NETWORK SERVICES

TOOLS

BUILDING JANITORIAL

AUTOMOTIVE

FORMS/OFFICE SUPPLIES

GENERAL

DATA VOICE

LAN CONNECTIVITY PRODUCTS SYNOPTICS

DISTRIBUTION SERVICES
NETWORK SERVICES
TOOLS
BUILDING JANITORIAL
AUTOMOTIVE
FORMS/OFFICE SUPPLIES
GENERAL
DATA VOICE

PRODUCT IDENTIFIER		DESCRIPTION				
ITEM NUMBER	ORD. MULT.	SELL UNIT	STD. PKG. STOCK AVAILABILITY / PA	LEAD TIME	MIN. ORD.	A C
260443825						
CONCENTRATOR PREMISES 3000-04-HW						
N						
Includes chassis, backplane with Ethernet, 2 Token Ring buses, dedicated network management interface buses & 460 watt power supply.						
260443833						
CONCENTRATOR PREMISES 3000-04-R2						
N						
Chassis with Model 3100R Summing Module, 2 Model 3002 460-watt power supplies and Ethernet, Token Ring and Redundant Power Supply Backplanes.						
260443841						
CONCENTRATOR PREMISES 3000-05						
N						
Chassis with Model 3002 460-watt Power Supply and FDDI, Ethernet, and Token Ring Backplanes.						
260443858						
CONCENTRATOR PREMISES 3000-05-R2						
N						
Chassis with Model 3100R Summing Module. 2 Model 3002 460 watt power supplies, FDDI, Ethernet, Token Ring & redundant power supply backplanes.						
260443882						
CONCENTRATOR WORKGROUP 2810-02-A						
N						
Managed 10BASE-T with IP Firmware includes license for Advanced Network Interface Management Agent.						
260443890						
CONCENTRATOR WORKGROUP 2810-04						
N						
Managed 10BASE-T with IP Firmware, Advanced Local Load Capability includes license for Advanced Network Interface Management Agent.						
260444351						
EXTENDER TOKEN RING FIBER OPTIC 354-ST						
N						
Token Ring Fiber Optic Lobe Extender up to 2KM.						
260444500						
FACE PLATE 1-SLOT 760-035						
N						
For Model 3000 Premises Concentrator.						
260444518						
FACE PLATE 2-SLOT 760-093						
N						
For Model 3000 Premises Concentrator.						
260444526						
FACE PLATE 3-SLOT 760-041						
N						
For Model 3000 Premises Concentrator.						
260444534						
FACE PLATE 5-SLOT 760-034						
N						
For Model 3000 Premises Concentrator.						
260444492						
FAN INTAKE FILTER 980-106						
N						
For Model 3000 Premises Concentrator.						
260444476						
KIT RACKMOUNT 19IN 980-111						
N						
Model 3030 or Model 2310 Concentrator 19IN Rackmount Kit.						

PRODUCT IDENTIFIER		DESCRIPTION				
ITEM NUMBER	ORD. MULT.	SELL UNIT	STD. PKG. STOCK AVAILABILITY / PA	LEAD TIME	MIN. ORD.	A C
260444096						
KIT ROUTER 4MB MEMORY OPTION 975-071						
N						
4MB Memory Option Kit for Model 3386 Remote Ethernet Router.						
260444187						
KIT ROUTER SOFTWARE MEDIA 725-02						
N						
5.25IN MS-DOS Floppy Disk Software Media Kit for Local/Remote Routers.						
260444195						
KIT ROUTER SOFTWARE MEDIA 725-03						
N						
QIC-24 Cartridge Tape Software Media Kit for Local/Remote Routers.						
260444237						
KIT ROUTER SOFTWARE MEDIA 726-01						
N						
3.50IN SPACRstation Floppy Disk Software Media Kit with X.25/Frame Relay Option for Remote Router.						
260444252						
KIT ROUTER SOFTWARE MEDIA 726-02						
N						
5.25IN MS-DOS Floppy Disk Software Media Kit with X.25/Frame Relay Option for Remote Router.						
260444211						
KIT ROUTER SOFTWARE MEDIA 726-03						
N						
QIC-24 Cartridge Tape Software Media Kit for Remote Routers with X.25/Frame Relay Option.						
260444120						
KIT ROUTER X.25/FRAME RELAY OPT 726-04						
N						
X.25 Frame Relay - Firmware Option Kit for Model 3386 Remote Ethernet Router.						
260444245						
KIT TERMINAL SERVER SOFTWARE 975-042						
N						
Terminal Server Software Kit 9-track 1600 bpi VMS Format (US Version) includes manual.						
260444286						
KIT TERMINAL SERVER SOFTWARE 975-043						
N						
Terminal Server Software Kit 5.25IN DSHD DOS Format (US Version) includes manual.						
260444294						
KIT TERMINAL SERVER SOFTWARE 975-044						
N						
Terminal Server Software Kit SS1 Format (US Version) includes manual.						
260444310						
KIT TERMINAL SERVER SOFTWARE 975-045						
N						
Terminal Server Software Kit VMS TK50 Format (US Version) includes manual.						
260444328						
KIT TERMINAL SERVER SOFTWARE 975-046						
N						
Terminal Server Software Kit QIC-24 Format (US Version) includes manual.						
260444336						
KIT TERMINAL SERVER SOFTWARE 975-047						
N						
Terminal Server Software Kit Ultrix TK50 Format (US Version) includes manual.						

LAN CONNECTIVITY PRODUCTS SYNOPTICS

PRODUCT IDENTIFIER							DESCRIPTION
ITEM NUMBER	ORD. MULT.	SELL UNIT	STD. PKG. STOCK AVAILABILITY / PA	LEAD TIME	MIN. ORD.	A C	DESCRIPTION
260444484							KIT WALLMOUNT 980-112 N For Model 3030 or Model 2310 Concentrator.
260444369							MEDIA FILTER 550A N Token Ring Unshielded Twisted Pair Lobe.
260444377							MEDIA FILTER 551 N Token Ring Unshielded Twisted Pair Repeater.
260443429							MEDIA FILTER TOKEN RING INTEGRATED 955 N For unshielded twisted pair lobe connections, 15FT.
260444039							MODULE ETHERNET 3314-ST-02-A N Network Management Module with ST FOIRL Fiber Port, RS232 Port, IP Firmware and license for Advanced Network Management Agent.
260444021							MODULE ETHERNET NETWORK MGMT 3313-02-A N Includes AUI Port, RS232 Port, IP Firmware and license for Advanced Network Management Agent.
260444419							MODULE FAN TRAY 980-108 N For Model 3000 Premises Concentrator.
260444070							MODULE FDDI NETWORK MANAGEMENT 3910S-04 N With Local Load capability. Includes license for Advance Network Management Agent.
260443924							MODULE HOST ETHERNET 10BASE-T 3307 N 50-pin TELCO-D Connector provides communication channels to compatible 508A 10BASE-T transceivers, network interface cards, or other host module ports. Supports 12 host connections.
260443932							MODULE HOST ETHERNET 10BASE-T 3308A N Features 12 RJ45 connectors to provide communication channels to compatible Ethernet host devices and Ethernet modules over UTP WIRE (USE IN COMPLIANCE W/AMERITECH PREMISE WIRING STANDARDS DOCUMENT).
260443908							MODULE HOST ETHERNET THIN NET 3301 N Provides eight 10BASE-T compatible BNC connectors to support connections to compatible Ethernet host devices.
260443916							MODULE HOST FIBER OPTIC ETHERNET 3304-ST N Provides FOIRL compatible signaling to Ethernet host devices via six dual ST type fiber connectors.

PRODUCT IDENTIFIER							DESCRIPTION
ITEM NUMBER	ORD. MULT.	SELL UNIT	STD. PKG. STOCK AVAILABILITY / PA	LEAD TIME	MIN. ORD.	A C	DESCRIPTION
260444013							MODULE HOST FIBER OPTIC FDDI 3904 N
260444005							MODULE HOST STP FDDI 3902 N Shielded Twisted Pair FDDI.
260443973							MODULE REPEATER 3532 N Token Ring Shielded Twisted Pair (STP).
260443981							MODULE REPEATER 3534-ST N Token Ring Fiber Optic.
260443940							MODULE RETIMING 3333 N Ethernet with AUI port.
260443957							MODULE RETIMING 3334-ST N Ethernet with ST FOIRL fiber port.
260443965							MODULE TOKEN RING HOST 3502-A N (STP/UTP). Provides 12 host communications channels to support Token Ring stations and compatible Token Ring modules operating at 4Mbps to 16Mbps.
260444047							MODULE TOKEN RING NETWORK MGMT 3512A N With Shielded Twisted Pair Ring-In/Ring-Out. Includes License for Advanced Network Management Agent.
260444054							MODULE TOKEN RING NETWORK MGMT 3514-ST-A N With Fiber Optic Repeater. Includes license for Advanced Network Management Agent.
260443999							MODULE TOKEN RING RI/RO STP 3552 N Shielded Twisted Pair Ring-In/Ring-Out with 2 DB-9 connectors.
260444385							POWER SUPPLY 3002 N 460 watt Power Supply Module for Model 3000 Premises Concentrator.
260444427							POWER SUPPLY AND FAN UNIT 980-113 N For Model 3030 Department Concentrator.
260444344							POWER SUPPLY REDUNDANT 3100R N Redundant Power Supply Summing Module for Model 3000 Premises Concentrator.
260444393							POWER SUPPLY REDUNDANT 975-069 N Upgrade Kit for Model 3000 Chassis. Ethernet and Token Ring, Redundant Power Supply Backplane and 3100R Summing Module.

DISTRIBUTION SERVICES

NETWORK SERVICES

TOOLS

BUILDING JANITORIAL

AUTOMOTIVE

FORMS/OFFICE SUPPLIES

GENERAL

DATA VOICE

DISTRIBUTION SERVICES

NETWORK SERVICES

TOOLS

BUILDING JANITORIAL

AUTOMOTIVE

FORMS/OFFICE SUPPLIES

GENERAL

DATA VOICE

LAN CONNECTIVITY PRODUCTS SYNOPTICS

PRODUCT IDENTIFIER DESCRIPTION

ITEM NUMBER	ORD. MULT.	SELL UNIT	STD. PKG. STOCK AVAILABILITY / PA	LEAD TIME	MIN. ORD.	A C
-------------	------------	-----------	-----------------------------------	-----------	-----------	-----

260444401 POWER SUPPLY REDUNDANT 975-111
N
Upgrade Kit for Model 3000 Chassis. FDDI/Ethernet/Token Ring/Redundant Power Supply Backplane and 3100R Summing Module.

260444112 ROUTER LOCAL ETHERNET 3383
N
Includes AUI Port and Right-To-Use License.

260444138 ROUTER LOCAL ETHERNET FOIRL 3384-ST
N
Includes FOIRL Fiber Port and Right-To-Use License.

260444146 ROUTER REMOTE ETHERNET 3386-01
N
Includes Right-To-Use License.

260444161 ROUTER REMOTE ETHERNET 3386-02
N
With 4MB Memory Option. Includes Right-To-Use License.

260444179 ROUTER REMOTE ETHERNET 3386-03
N
With 4MB Memory Option and X.25/Frame Relay Option. Includes Right-To-Use License.

260444278 TERMINAL SERVER 3395-01
N
With TCP/IP Support.

260444203 TERMINAL SERVER 3395-02
N
With TCP/IP and LAT Support, includes LAT license.

260444229 TERMINAL SERVER LAT UPGRADE SU3395-A
N
LAT Upgrade License for Terminal Server.

260444260 TRANSCEIVER 10BASE-T 508A
N

260444302 TRANSCEIVER 504-ST
N
Ethernet Fiber Optic.

PRODUCT IDENTIFIER DESCRIPTION

ITEM NUMBER	ORD. MULT.	SELL UNIT	STD. PKG. STOCK AVAILABILITY / PA	LEAD TIME	MIN. ORD.	A C
-------------	------------	-----------	-----------------------------------	-----------	-----------	-----

MODEM 0/ 300 BPS

300036316 GDC 108-3M RACKMOUNT
1142570 1 EA
SOE
300 bps full duplex asynchronous modem designed to operate over unconditioned 2- or 4-wire voice grade circuits point-to-point or multipoint. HOUSED IN THE GDC DS-1 or DS-6R-1 RACK.

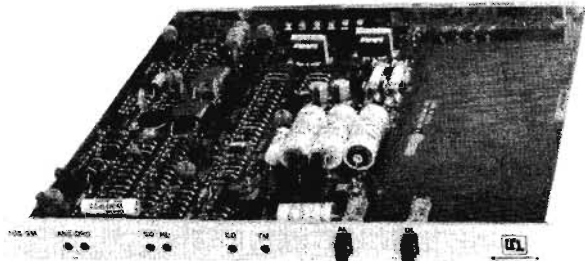

300036316

300064805 GDC DC-108-3M STANDALONE

1172783 1 EA IL IN MI OH WI
SOE 04 04 04 04 04
300 bps full duplex asynchronous modem designed to operate over unconditioned 2- or 4-wire voice grade circuits point-to-point or multi-point.

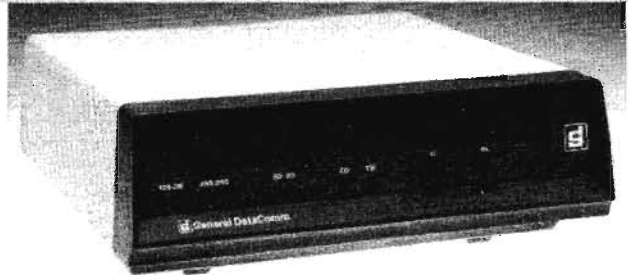

1172783

260963178 GDC DC-108-3M STANDALONE WITH CORD

1236612 1 EA IL IN MI OH WI
SOE
300 bps full duplex asynchronous modem designed to operate over unconditioned 2- or 4-wire voice-grade circuits point-to-point or multi-point. Includes cord for current loop.

PRODUCT IDENTIFIER		DESCRIPTION				
ITEM NUMBER	ORD. MULT.	SELL UNIT	STD. PKG. STOCK AVAILABILITY / PA	LEAD TIME	MIN. ORD.	A C

MODEM 300/ 1200 BPS

103044285 AT&T 212AR

1131227 1 EA
GF

Full duplex, sync/async and automatic answer.

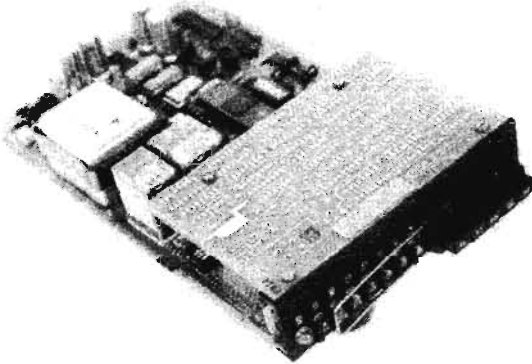

103044285

300080777 GDC 212A/ED PLUS

1172460 1 EA IL IN MI OH WI
GF 04 04 04

Asynchronous, full duplex 'AT' compatible and built-in auto-dialer.

280079294 NEC N-212AR STANDALONE M/D

1935916 1 EA IL IN MI OH WI
GF 04 04 04

Sync/async, 2-wire full duplex dial-up. DISCONTINUED UPON STOCK DEPLETION - REPAIR & RETURN ONLY.

280079633 NEC N-212BR RACKMOUNT M/D

N EA 1 2 1
GF

Synchronous/async, 2-wire full duplex dial-up. DISCONTINUED UPON STOCK DEPLETION - REPAIR & RETURN ONLY.

280079625 NEC N-212BR STANDALONE M/D

N EA 1 4 1
GF

Synchronous/async, 2-wire full duplex dial-up. DISCONTINUED UPON STOCK DEPLETION - REPAIR & RETURN ONLY.

MODEM 300/ 1800 BPS

260000138 AT&T 202T L1

1996603 1 EA
GF

Asynchronous, half duplex or full duplex private line, point-to-point/multipoint.

PRODUCT IDENTIFIER		DESCRIPTION				
ITEM NUMBER	ORD. MULT.	SELL UNIT	STD. PKG. STOCK AVAILABILITY / PA	LEAD TIME	MIN. ORD.	A C

102998275 AT&T 202T L1A

1191049 1 EA IL IN MI OH WI
GF 03 03 03 03 03

Asynchronous, half or full duplex private line, point-to-point/multi-point.

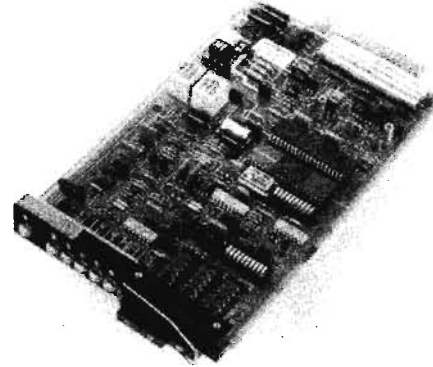

1191049

260442512 NEC I-202T

N EA 1 4 1
Dual Modem Card P/N18-01131-000.

280060096 NEC N-202T RACKMOUNT

1938100 1 EA IL IN MI OH WI
SOE 04 04 04 04 04

0-1800 bps on C2 conditioned lines, 0-1400 bps on unconditioned lines, 0-1200 bps with reverse channel asynchronous full duplex 4 wire private line or half duplex 2 wire. HOUSED IN THE NEC N40B1 RACK.

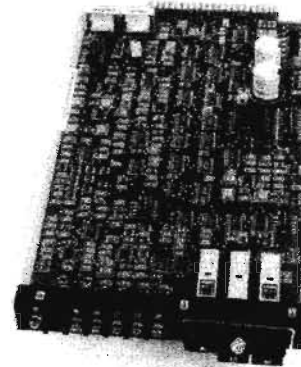

1938100

DISTRIBUTION SERVICES
NETWORK SERVICES
TOOLS
BUILDING JANITORIAL
AUTOMOTIVE
FORMS/OFFICE SUPPLIES
GENERAL
DATA VOICE

DISTRIBUTION SERVICES

NETWORK SERVICES

TOOLS

BUILDING JANITORIAL

AUTOMOTIVE

FORMS/OFFICE SUPPLIES

GENERAL

DATA VOICE

MODEM 300/ 1800 BPS

PRODUCT IDENTIFIER DESCRIPTION

ITEM NUMBER	ORD. MULT.	SELL UNIT	STD. PKG. STOCK AVAILABILITY / PA	LEAD TIME	MIN. ORD.	A C
-------------	------------	-----------	-----------------------------------	-----------	-----------	-----

280060088 NEC N-202T STANDALONE

1938092	1	EA	IL IN MI OH WI
SOE			04 04 04 04 04

0-1800 bps on C2 conditioned lines, 0-1400 bps on unconditioned lines, 0-1200 bps on reverse channel asynchronous full duplex 4-wire private lines or half duplex 2-wire lines.

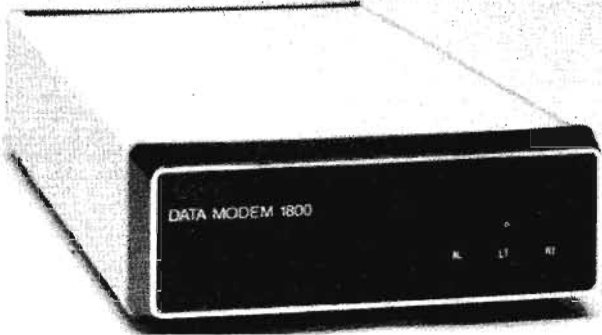

1938092

PRODUCT IDENTIFIER DESCRIPTION

ITEM NUMBER	ORD. MULT.	SELL UNIT	STD. PKG. STOCK AVAILABILITY / PA	LEAD TIME	MIN. ORD.	A C
-------------	------------	-----------	-----------------------------------	-----------	-----------	-----

260425830 GDC DC 2400 ASM RACKMOUNT

1983668		EA	IL IN MI OH WI
SOE			04

Sync or async, full duplex point-to-point or multi-point data communications over unconditioned 4-wire private lines. HOUSED IN THE DS-1 or DS-6R-1 RACK.

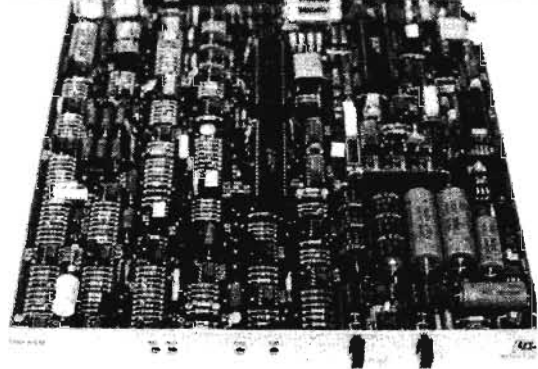

1983668

MODEM 300/ 2400 BPS**103065272 AT&T 201CR**

N	EA	1	2	1
GF				

Synchronous, 2-wire half duplex.

103945531 AT&T 2024A DATAPHONE-II RACKMOUNT

1197350	1	EA	IL IN MI OH WI
SOE			01 01 01 01 01

A synchronous 4-wire full-duplex point-to-point or multipoint analog private line. HOUSED IN AT&T 64A3 RACK. PRODUCT PLACED ON LIMITED AVAILABILITY NEW OR REMANUFACTURED AVAILABILITY BY AT&T.

260000187 AT&T 2024A DATAPHONE-II STANDALONE

1996652	1	EA	IL IN MI OH WI
SOE			01 01 01 01 01

Synchronous, 4-wire full duplex point-to-point analog private-line modem. PRODUCT PLACED ON LIMITED AVAILABILITY NEW OR REMANUFACTURED AVAILABILITY BY AT&T.

260446166 GDC DC 2400 ASM STANDALONE

1984161			IL IN MI OH WI
---------	--	--	----------------

Sync or async, full duplex point-to-point or multi-point data communications over unconditioned 4-wire private lines.

280021858 GDC DC 2412 STANDALONE M/D

N	EA	1	2	1
GF				

Sync/async, full duplex, 2-wire switched network or private line. DISCONTINUED - REPAIR & RETURN ONLY.

260449269 HAYES 2400B V-SERIES SMARTMODEM

N
PC card data speed of 300/1200/2400 bps, sync & async, error-control 2-wire dial-up.

260449277 HAYES 2400P SMARTMODEM MCA

N
PC card is a plug-in board designed specifically for IBM PS/2 Micro Channel computers. Sync and async, data speed 300/1200/2400 bps.

300091436 MULTITECH MT224ER5 RACKMOUNT

1920975	1	EA	IL IN MI OH WI
SOE			03 03

Async and sync over both dial-up and 2-wire leased lines. MNP error correction, classes 3, 4 & 5. HOUSED IN THE CC-216 RACK.

280060062 NEC N201C RACKMOUNT M/D

1938084	1	EA	IL IN MI OH WI
GF			04 04 04 04

Synchronous 2-wire half duplex, 4-wire full duplex, leased line. DISCONTINUED UPON STOCK DEPLETION - REPAIR & RETURN ONLY.

PRODUCT IDENTIFIER DESCRIPTION

ITEM NUMBER	ORD. MULT.	SELL UNIT	STD. PKG. STOCK AVAILABILITY / PA	LEAD TIME	MIN. ORD.	A C
-------------	------------	-----------	-----------------------------------	-----------	-----------	-----

280060054 NEC N201C STANDALONE M/D
 1938076 1 EA IL IN MI OH WI
 GF 04 04 04 04
 Synchronous 2-wire half duplex, 4-wire full duplex, leased line. DISCONTINUED UPON STOCK DEPLETION - REPAIR & RETURN ONLY.

280079666 NEC N2420/30HN RACKMOUNT M/D
 N EA 1 5 1
 GF
 Sync/async, 2-wire full duplex. DISCONTINUED UPON STOCK DEPLETION - REPAIR & RETURN ONLY.

280079658 NEC N2420/30HN STANDALONE M/D
 N EA 1 5 1
 GF
 Sync/async, 2-wire full duplex. DISCONTINUED UPON STOCK DEPLETION - REPAIR & RETURN ONLY.

260321997 NEC N2420/30HNE RACKMOUNT M/D
 N EA 1 2 1
 GF
 Sync/async, 2-wire full duplex. DISCONTINUED UPON STOCK DEPLETION - REPAIR & RETURN ONLY.

260321989 NEC N2420/30HNE STANDALONE M/D
 N EA 1 2 1
 GF
 Sync/async, 2-wire full duplex. DISCONTINUED UPON STOCK DEPLETION - REPAIR & RETURN ONLY.

280060039 NEC N2420/30S RACKMOUNT M/D
 N EA 1 2 1
 GF
 Sync/async, 2-wire full duplex security modem. DISCONTINUED UPON STOCK DEPLETION - REPAIR & RETURN ONLY.

280060021 NEC N2420/30S STANDALONE M/D
 N EA 1 5 1
 GF
 Sync/async, 2-wire full duplex security modem. DISCONTINUED UPON STOCK DEPLETION - REPAIR & RETURN ONLY.

PRODUCT IDENTIFIER DESCRIPTION

ITEM NUMBER	ORD. MULT.	SELL UNIT	STD. PKG. STOCK AVAILABILITY / PA	LEAD TIME	MIN. ORD.	A C
-------------	------------	-----------	-----------------------------------	-----------	-----------	-----

260425608 NEC N2435E STANDALONE
 1981043 1 EA IL IN MI OH WI
 SOE 04 04 04 04
 Replaces N2431 Standalone. Synchronous/asynchronous auto-dialers, v.42 BIS, MNP Class 5 data compression, password-protected, remote operation, complete diagnostics, 2-wire dial/leased line.

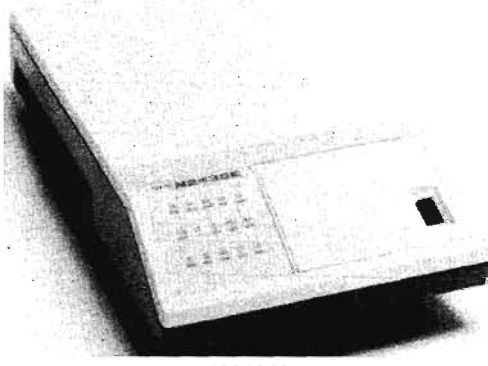

1981043

260422936 PENRIL DATALINK 1200/2400 RACKMOUNT
 1977660 1 EA IL IN MI OH WI
 SOE
 Full duplex 2-wire switched or leased lines, sync or asyn. Hayes or Penril compatible auto dialer number storage, MNP error correction (optional).HOUSED IN THE 1608-01 RACK.

260407846 PENRIL DATALINK 1200/2400 STANDALONE
 1977678 1 EA IL IN MI OH WI
 SOE
 Full duplex 2-wire switched or leased line, sync or async, Hayes or Penril compatible auto dialer number storage, MNP error correction (optional).



1977678

MODEM 300/ 4800 BPS

103091898 AT&T 2048A DATAPHONE II RACKMOUNT/SA
 1186759 1 EA
 SOE
 Synchronous 4-wire full duplex analog private line, point-to-point. HOUSED IN 64A3-AC OR 64D1-DC RACK. PRODUCT PLACED ON LIMITED AVAILABILITY NEW/REMANUFACTURED AVAILABILITY BY AT&T.

DISTRIBUTION SERVICES
 NETWORK SERVICES
 TOOLS
 BUILDING JANITORIAL
 AUTOMOTIVE
 FORMS/OFFICE SUPPLIES
 GENERAL
 DATA VOICE

DISTRIBUTION SERVICES

MODEM 300/ 4800 BPS

PRODUCT IDENTIFIER DESCRIPTION

ITEM	ORD.	SELL	STD. PKG.	LEAD TIME	MIN.	A
NUMBER	MULT.	UNIT	STOCK AVAILABILITY / PA		ORD.	C

103091922 AT&T 2048C DATAPHONE II RACKMOUNT/SA
 N
 SOE EA 1 2 1

Synchronous 4-wire full duplex, multi-point. HOUSED IN 64A3-AC OR 64D1-DC RACK. PRODUCT PLACED ON LIMITED AVAILABILITY NEW/REMANUFACTURED AVAILABILITY BY AT&T.

260366273 NEC I-2432E RACKMOUNT

1955047	1	EA	IL	IN	MI	OH	WI
SOE			01	01	01	01	01

Sync/async, 2 auto-dialers, MNP Class 5, data compression 2 modems per card. HOUSED IN I-1000E RACK & I1000N RACK.

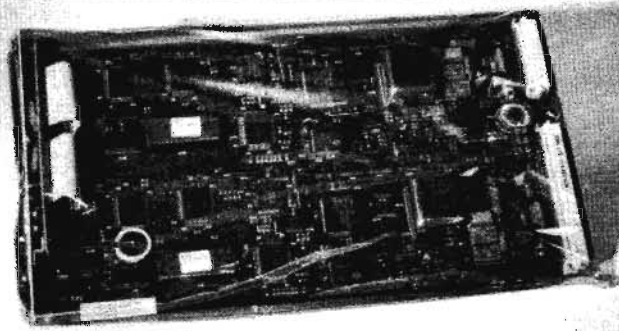

1955047

280079682 NEC N-4810-II RACKMOUNT

1938209	1	EA	IL	IN	MI	OH	WI
SOE			01	01			

Designed for a 2-wire switched network line. Operates in 4-wire point-to-point/multi-point and 2-wire leased line and has a built-in bisync auto-dialer. HOUSED IN SRO 801-U 19IN OR 23IN RACK.

280079674 NEC N-4810-II STANDALONE

1938191	1	EA	IL	IN	MI	OH	WI
SOE			01	01			

Designed for a 2-wire switched network line. Operates in a 4-wire point-to-point/multi-point and 2-wire leased line & has a built-in bisync auto-dialer.



1938191

NETWORK SERVICES

TOOLS

BUILDING JANITORIAL

AUTOMOTIVE

FORMS/OFFICE SUPPLIES

GENERAL

DATA VOICE

PRODUCT IDENTIFIER DESCRIPTION

ITEM	ORD.	SELL	STD. PKG.	LEAD TIME	MIN.	A
NUMBER	MULT.	UNIT	STOCK AVAILABILITY / PA		ORD.	C

MODEM 300/19200 BPS

260425814 GDC DC-596-V RACKMOUNT

1982744
 SOE EA

Full duplex 2-wire switched, or 2- or 4-wire point-to-point private line, sync/async MNP5 and V.42 bis. HOUSED IN DS-1 or DS-6R-1 RACK.

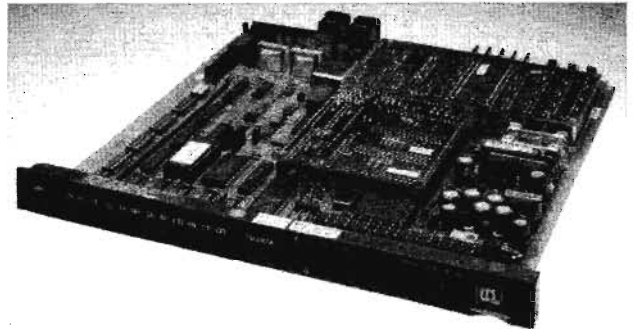

260425814

260447024 GDC DT-596-V STANDALONE

N

Full duplex 2-wire switched, or 2- or 4-wire point-to-point private line, sync/async MNP5 and V.42 bis.

260392402 NEC ADDED FEATURE SECURITY MODULE OPTION

1971093	1	EA	IL	IN	MI	OH	WI
SOE			04	04	04	04	04

For the N-9635E-2 three levels of call back security standard, programmed pass through, supports up to 64 users, sync & async.

260388350 NEC DISPLAY CONTROL MODULE

1974600	1	EA	IL	IN	MI	OH	WI
SOE			03				

Controller is portable - can be used to transfer configurations or run advanced diagnostics on all of the N-9635E-2 at a site.

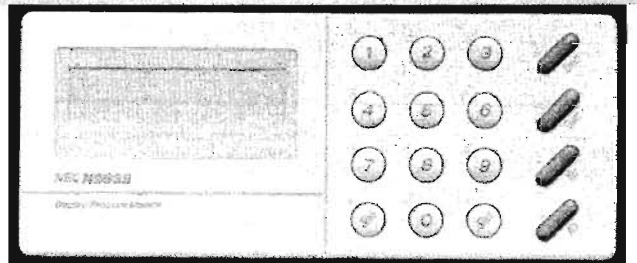

1974600

260442496 NEC 19635E/SECURITY RACKMOUNT

N

EA 1 4 1
 Dial-up 2- or 4-wire leased line, MNP, Class 4&5, Autodial, Hayes and V.25 BIS, V.32, V.42, & V.42 BIS.

PRODUCT IDENTIFIER		DESCRIPTION				MIN.	A
ITEM NUMBER	ORD. MULT.	SELL UNIT	STD. PKG.	LEAD TIME	ORD.	C	

260388301 NEC I-9632E RACKMOUNT
 1966697 1 EA IL IN MI OH WI
 SOE 01 01 01 01 01
 2-wire dial & 2- & 4-wire leased line, auto-dial backup, sync/async, MNP class 2-4 error two modem per card. HOUSED IN THE I-1000E & I-1000N RACK

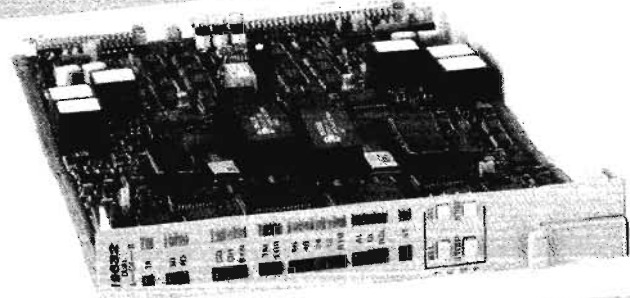

1966697

260388319 NEC I-9635E RACKMOUNT
 1974634 1 EA IL IN MI OH WI
 SOE 01 01 01 01
 Hayes compatible, MNP error control-CCITT V.42 Lamp & MNP class 2-4, sync & async, full duplex, 1 modem per card. HOUSED IN THE I-1000E & I-1000N RACK

260442504 NEC I-9635E + RACKMOUNT
 N EA 1 4 1
 Dial-up 2- or 4-wire leased line, MNP, Class 4&5, Autodial, Hayes and V.25 BIS, V.32, V.42 & V.42 BIS.

260442538 NEC N9635E + STANDALONE W/ CONTROLLER
 N EA 1 4 1
 V.32 B15 P/N 19-02581-000.

260442520 NEC N9635E + STANDALONE W/O CONTROLLER
 N EA 1 4 1
 V.32 B15 P/N 19-02561-000.

260388335 NEC N-9635E-2 STANDALONE W/CONTROLLER
 1966689 1 EA IL IN MI OH WI
 SOE 01 01 01 01 01
 CCITT V.42 BIS & MNP Class 5, sync/async, 2- or 4-wire lease line, full duplex, Hayes AT command set & automatic dialer.

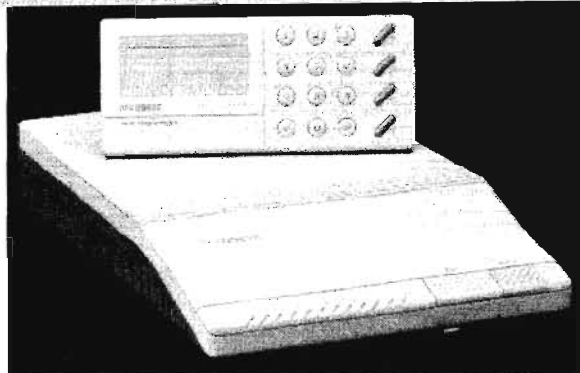

1966689

PRODUCT IDENTIFIER		DESCRIPTION				MIN.	A
ITEM NUMBER	ORD. MULT.	SELL UNIT	STD. PKG.	LEAD TIME	ORD.	C	

260388343 NEC N-9635E-2 STANDALONE W/O CONTROLLER
 1974626 1 EA IL IN MI OH WI
 SOE 01 01 01 01
 CCITT V.42 BIS & MNP Class 5, sync/async, 2- or 4-wire lease line, full duplex, Hayes AT command set & automatic dialer.

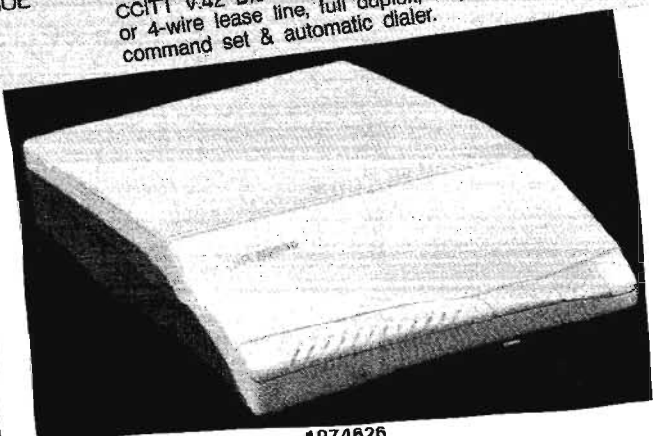

1974626

MODEM 1200/ 1800 BPS
260440359 GDC DC 202T RACKMOUNT
 1982702 EA
 1200/1800 BPS full or half duplex asynchronous; 2- or 4-wire; voice grade private line. HOUSED IN DS-1 or DS-6R-1 RACKS.

260447438 GDC DC 202T STANDALONE
 N
 1200/1800 BPS full or half duplex asynchronous, 2- or 4-wire voice grade private line.

MODEM 1200/ 2400 BPS
260447404 GDC DC 201C/L RACKMOUNT
 N
 Synchronous 2- or 4-wire, point-to-point or multi-point, private line; 2-wire half duplex switch network. HOUSED IN DS-1 OR DS-6R-1 RACK.

260447412 GDC DC 201C/L STANDALONE
 N
 Synchronous 2- or 4-wire, point-to-point or multi-point, private line; 2-wire half duplex switch network.

MODEM 2400/ 4800 BPS
260425624 PENRIL DATALINK 4800 RACKMOUNT
 N EA 1 4 1
 SOE
 Half duplex over 2-wire, full duplex 4-wire private line, half duplex over single dial-up or duplex over 2 dial-up lines. Sync/async, MNP error correction. HOUSED IN 1608-01 RACK.

DISTRIBUTION SERVICES
 NETWORK SERVICES
 TOOLS
 BUILDING JANITORIAL
 AUTOMOTIVE
 FORMS/OFFICE SUPPLIES
 GENERAL
 DATA VOICE

DISTRIBUTION SERVICES

NETWORK SERVICES

TOOLS

BUILDING JANITORIAL

AUTOMOTIVE

FORMS/OFFICE SUPPLIES

GENERAL

DATA VOICE

MODEM 2400/ 4800 BPS

PRODUCT IDENTIFIER		DESCRIPTION					
ITEM NUMBER	ORD. MULT.	SELL UNIT	STD. PKG. STOCK AVAILABILITY / PA	LEAD TIME	MIN. ORD.	A C	
260425616 PENRIL DATALINK 4800 STANDALONE							
N		EA	1	4	1		
SOE							
Half duplex over 2-wire, full duplex 4-wire private line, half duplex over single dial-up or duplex over 2 dial-up lines. Sync/async, MNP error correction.							

MODEM 2400/ 9600 BPS

260425780 AT&T 839A DATAPHONE II RACKMOUNT CARD						
N		EA	1	3	1	
SOE						
Dial backup unit, point-to-point or multipoint. HOUSED IN THE 111A1 RACK.						

260449293 AT&T 839B DATAPHONE II STANDALONE						
N						
Dial back-up unit, point-to-point or multi-point.						

102860293 AT&T AUX SET 829A L1A						
2678862	1	EA	IL	IN	MI	OH
			03	03	03	03
A 4-wire data transmission aid, equipped with loop back.						

260425665 BLACK BOX SHM-NPR 2-WIRE FEMALE S/A						
N		EA	1	2	1	
SOE						
Non-powered 2-wire full duplex short-haul modem.						

260425657 BLACK BOX SHM-NPR 2-WIRE MALE S/A						
N		EA	1	2	1	
SOE						
Non-powered 2-wire full duplex short-haul modem.						

MODEM 2400/19200 BPS

260425699 BLACK BOX SHM-NPR FEMALE STANDALONE						
N		EA	1	2	1	
SOE						
Full duplex 4-wire point-to-point, to connect two async devices.						

260425681 BLACK BOX SHM-NPR MALE STANDALONE						
N		EA	1	2	1	
SOE						
Full duplex 4-wire point-to-point, to connect two async devices.						

PRODUCT IDENTIFIER		DESCRIPTION					
ITEM NUMBER	ORD. MULT.	SELL UNIT	STD. PKG. STOCK AVAILABILITY / PA	LEAD TIME	MIN. ORD.	A C	
260360136 GDC DC-2020 RACKMOUNT							
N		EA	1	5	1		
SOE							
Half duplex 2-wire; full duplex 4-wire, point-to-point/multi-point, synchronous. HOUSED IN DS-1 OR DS-6R-1 RACK.							

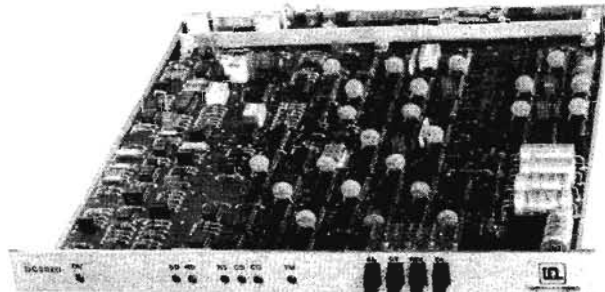

260360136

260360144 GDC DC-2020 STANDALONE						
N		EA	1	4	1	
SOE						
Half duplex 2-wire; full duplex 4-wire, point-to-point/multi-point, synchronous.						

260466166 GDC DC 2400 ASM STANDALONE						
1984161			IL	IN	MI	OH
			03	03	03	03
Sync or async, full duplex point-to-point or multi-point data communications over unconditioned 4-wire private lines.						

MODEM 4800/ 9600 BPS

103872503 AT&T 2096A DATAPHONE II RM/SA						
1186585	1	EA				
SOE						
Synchronous 4-wire, full duplex analog point-to-point private line. HOUSED IN 64A3-AC OR 64D1-DC RACK. PRODUCT PLACED ON LIMITED AVAILABILITY NEW/REMANUFACTURED AVAILABILITY BY AT&T.						

260449301 AT&T 2096C DATAPHONE II RM/SA						
N						
Synchronous full-duplex analog multi-point private line. HOUSED IN 64A3-AC OR 64D1-DC RACK. PRODUCT PLACED ON LIMITED AVAILABILITY. NEW/REMANUFACTURED AVAILABILITY BY AT&T.						

PRODUCT IDENTIFIER DESCRIPTION

ITEM NUMBER	ORD. MULT.	SELL UNIT	STD. PKG. STOCK AVAILABILITY / PA	LEAD TIME	MIN. ORD.	A C
-------------	------------	-----------	-----------------------------------	-----------	-----------	-----

280050998 GDC DC 9600RPA RACKMOUNT
 1928564 1 EA IL IN MI OH WI
 SOE 01 01
 Sync/async, 4-wire point-to-point/multi-point private line. HOUSED IN DS-1 OR DS-6R-1 RACK.

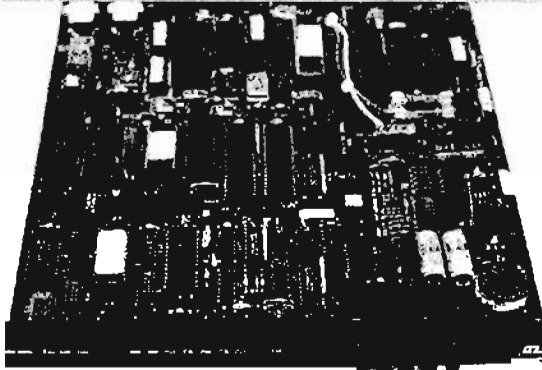

1928564

280053081 GDC DC 9600RPA STANDALONE
 1928580 1 EA IL IN MI OH WI
 SOE 01 01
 Sync/async, 4-wire point-to-point/multi-point private line.



1928580

280053125 GDC DC 9600SPA RACKMOUNT
 1928515 1 EA IL IN MI OH WI
 SOE 37
 Sync/async, 4-wire point-to-point leased line, full duplex. HOUSED IN DS-1 OR DS-6R-1 RACK.

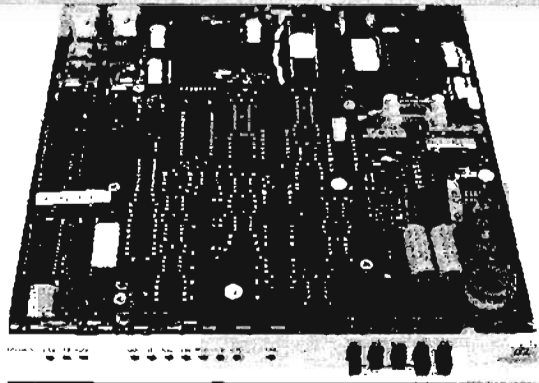

1928515

PRODUCT IDENTIFIER DESCRIPTION

ITEM NUMBER	ORD. MULT.	SELL UNIT	STD. PKG. STOCK AVAILABILITY / PA	LEAD TIME	MIN. ORD.	A C
-------------	------------	-----------	-----------------------------------	-----------	-----------	-----

280053133 GDC DC 9600SPA STANDALONE
 1928531 1 EA IL IN MI OH WI
 SOE 01 01
 Sync/async, 4-wire point-to-point private line, full duplex.



1928531

300080785 GDC LCM 1010A RACKMOUNT
 N EA 1 4 1
 SOE
 Full duplex, 4-wire; half duplex 2- or 4-wire asynchronous point-to-point, data rates up to 9600 bps. HOUSED IN CMP-100 RACK.



300080785

300080793 GDC LCM 1010A STANDALONE
 N EA 1 4 1
 SOE
 Full duplex, 4-wire; half duplex 2- or 4-wire asynchronous point-to-point, data rates up to 9600 bps.



300080793

260321930 NEC DPS 9630 V.32 RACKMOUNT
 N EA 1 5 1
 SOE
 Full duplex 2-wire or 4-wire, error correction, sync/async, auto-dial backup function. HOUSED IN SRO-604 RACK.

260321922 NEC DPS 9630 V.32 STANDALONE
 N EA 1 4 1
 SOE
 Full duplex, 2-wire or 4-wire, error correction, sync/async, auto-dial backup function.

DISTRIBUTION SERVICES

NETWORK SERVICES

TOOLS

BUILDING JANITORIAL

AUTOMOTIVE

FORMS/OFFICE SUPPLIES

GENERAL

DATA VOICE

DISTRIBUTION SERVICES

NETWORK SERVICES

TOOLS

BUILDING JANITORIAL

AUTOMOTIVE

FORMS/OFFICE SUPPLIES

GENERAL

DATA VOICE

MODEM 4800/ 9600 BPS

PRODUCT IDENTIFIER DESCRIPTION

ITEM NUMBER	ORD. MULT.	SELL UNIT	STD. PKG. STOCK AVAILABILITY / PA	LEAD TIME	MIN. ORD.	A C
-------------	------------	-----------	-----------------------------------	-----------	-----------	-----

002027993 TEK-COM ADL RACKMOUNT
 1201897 1 EA IL IN MI OH WI
 SOE 04
 Async full duplex point-to-point/multipoint, requires 4-wire leased line. HOUSED IN TC-810 RACK.

002028009 TEK-COM ADL STANDALONE
 1178814 1 EA IL IN MI OH WI
 SOE 04
 Async, full duplex point-to-point or multi-point. Operation requires 4-wire leased line.

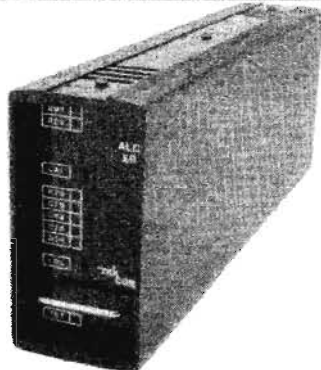

1178814

MODEM 4800/9600/19200 BPS

260425848 GDC LCM 1020A RACKMOUNT
 N EA 1 4 1
 SOE
 Full duplex 4-wire; half duplex 2- or 4-wire asynchronous point-to-point, data rates up to 19,200kbps. HOUSED IN CMP-100 RACK.

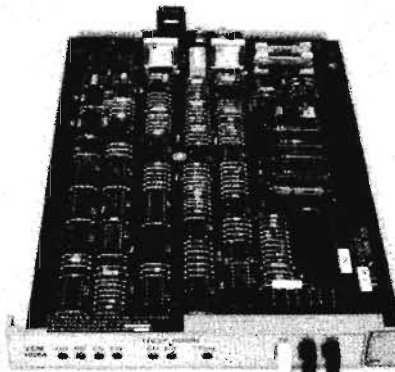

260425848

260447099 GDC LCM 1020A STANDALONE
 N
 Full duplex 4-wire, half-duplex 2- or 4-wire synchronous point-to-point speeds up to 19.2 KBPS.

PRODUCT IDENTIFIER DESCRIPTION

ITEM NUMBER	ORD. MULT.	SELL UNIT	STD. PKG. STOCK AVAILABILITY / PA	LEAD TIME	MIN. ORD.	A C
-------------	------------	-----------	-----------------------------------	-----------	-----------	-----

MODEM 4800 BPS

260441415 GDC DC 208B/A RACKMOUNT
 1982710 EA
 4800 BPS full duplex over unconditioned 4-wire voice grade circuits or half duplex over 2-wire switched network; point-to-point or multi-point. HOUSED IN DS-1 OR DS-6R-1 RACKS.

260447446 GDC DC 208B/A STANDALONE
 N
 Full duplex 4-wire, half duplex 2-wire, synchronous.

300080736 GDC DC 208B/A STANDALONE
 1139139 1 EA IL IN MI OH WI
 GF 37 37 37 37
 Full duplex 4-wire; half duplex 2-wire, synchronous.

280022211 GDC DC 4800 RACKMOUNT
 N EA 1 2 1
 GF
 Synchronous, 4-wire or 2-wire, point-to-point or multi-point. HOUSED IN THE DS-1 OR DS-6R-1 RACK.

260360201 GDC DC 4800 STANDALONE
 N EA 1 4 1
 GF
 Synchronous, 4-wire or 2-wire, point-to-point or multi-point.

260447040 GDC DC 2030 RACKMOUNT
 N
 2-wire half-duplex, 4-wire full duplex, point-to-point or multi-point and CCITT standard V.35. HOUSED IN DS-1 OR DS-6R-1 RACK.

260447073 GDC DC 2030 STANDALONE
 N
 2-wire half duplex, 4-wire full duplex, point-to-point or multi-point and CCITT standard V.35 interface.

MODEM DSU/CSU

260382536 AT&T 2556A L1A/2 DSU RACKMOUNT
 1961557 1 EA
 SOE
 Point-to-point and multi-point, full duplex 4-wire private line, and data speeds of 56 kbps.

260449285 AT&T 2556B DSU STANDALONE
 N
 Analog private line, point-to-point or multi-point, 4-wire private line, and data speed of 56 kbps.

260449574 AT&T 2596B DSU STANDALONE
 N
 Sync/async, point-to-point, data speeds of 2.4, 4.8, 9.6 kbps.

DISTRIBUTION SERVICES
 NETWORK SERVICES
 TOOLS
 BUILDING JANITORIAL
 AUTOMOTIVE
 FORMS/OFFICE SUPPLIES
 GENERAL
 DATA VOICE

PRODUCT IDENTIFIER		DESCRIPTION				
ITEM NUMBER	ORD. MULT.	SELL UNIT	STD. PKG. STOCK AVAILABILITY / PA	LEAD TIME	MIN. ORD.	A C

260449491 BLACK BOX MD990B CSU/DSU V.35 S/A
 N

4-wire full or half duplex, point-to-point or multi-point, data speeds of 2.4, 4.8, and 9.6 kbps.

260449509 CODEX 2171 LDM RACKMOUNT

N

Synchronous, point-to-point or multi-point, 4-wire full or half duplex, 2-wire half duplex, and data speeds of 1.2 to 19,200 bps. HOUSED IN 2170 RACK.

260449517 CODEX 2171 LDM STANDALONE

N

Synchronous, point-to-point or multi-point, 4-wire full or half duplex, 2-wire half duplex, and data speeds of 1.2 to 19,200 bps.

260449525 CODEX 2172 LDM STANDALONE

N

Point-to-point or multi-point, 4-wire full or half duplex & 2-wire half duplex, and data rate of 32, 48, 56, 64, 72, 80 KBPS.

260353412 GDC ADAPTER CABLE V.35 FOR DC500C/UXR RM

1952069	1	EA	IL 04	IN	MI	OH	WI 04
---------	---	----	----------	----	----	----	----------

This adapter cable manufactured by GDC is used whenever a rack mounted DSU DC500A-56K SR is mounted into a chassis. P/N 070H002-001.

300084324 GDC DC 500A/SR RACKMOUNT M/D

1920413	1	EA	IL 03	IN	MI	OH	WI
---------	---	----	----------	----	----	----	----

DISCONTINUED UPON STOCK DEPLETION.

260394010 GDC DC 500C/UXR RACKMOUNT

1966648	1	EA	IL 02	IN	MI	OH	WI 02
---------	---	----	----------	----	----	----	----------

Sync/async, full duplex, point-to-point, 4-wire, data rates of 2.4, 4.8, 9.6 and 56kbps. HOUSED IN DS-1 OR DS-6R-1 RACK.

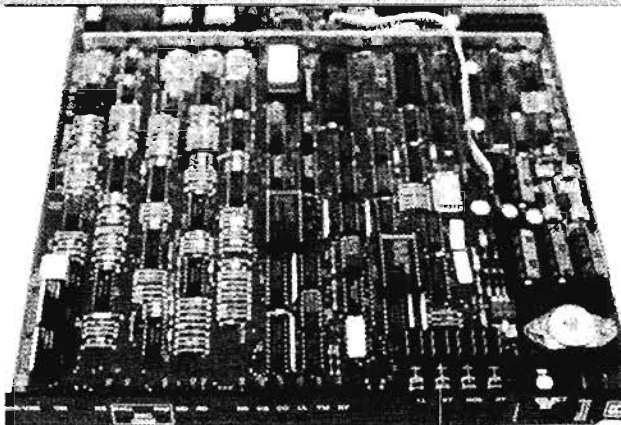

1966648

PRODUCT IDENTIFIER		DESCRIPTION				
ITEM NUMBER	ORD. MULT.	SELL UNIT	STD. PKG. STOCK AVAILABILITY / PA	LEAD TIME	MIN. ORD.	A C

260393988 GDC DC 500C/UXR STANDALONE

1986614	1	EA	IL 02	IN	MI	OH	WI 02
---------	---	----	----------	----	----	----	----------

Sync/async, full duplex, point-to-point, 4-wire, data rates of 2.4, 4.8, 9.6, & 56kbps.

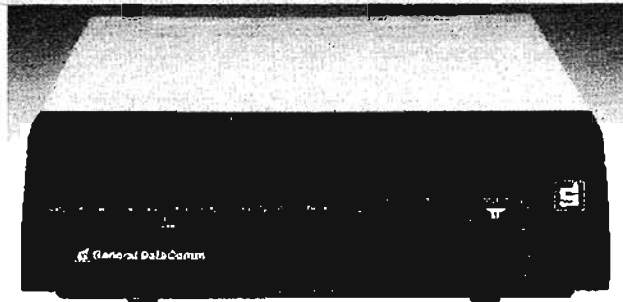

1986614

260434588 GDC DC 500G/UXR RACKMOUNT

N	EA	1	3	1
---	----	---	---	---

Sync/async, full duplex, DDS S/C: Point-to-point/multipoint, 2.4, 4.8, 9.6, 19.2 & 56kbps; 64K DDS clear channel: point-to-point only, no secondary channel with 64K. HOUSED IN DS-1 OR DS-6R-1 RACK.

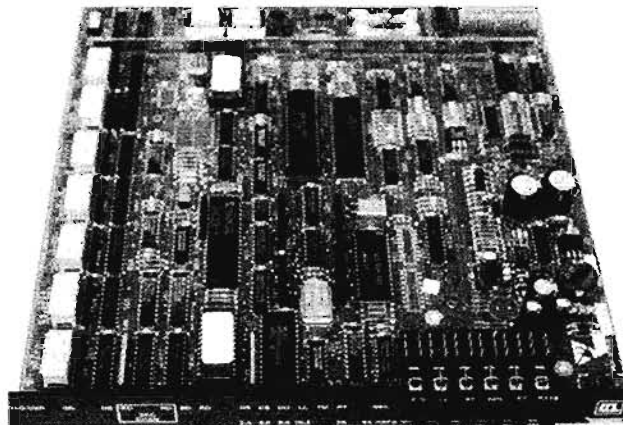

260434568

260434550 GDC DC 500G/UXR STANDALONE

N	EA	1	3	1
---	----	---	---	---

Sync/async, full duplex, DDS S/C: Point-to-point/multipoint, 2.4, 4.8, 9.6, 19.2 & 56kbps; 64K DDS clear channel: point-to-point only, no secondary channel with 64K.



260434550

DISTRIBUTION SERVICES

NETWORK SERVICES

TOOLS

BUILDING JANITORIAL

AUTOMOTIVE

FORMS/OFFICE SUPPLIES

GENERAL

DATA VOICE

MODEM DSU/CSU

PRODUCT IDENTIFIER

DESCRIPTION

ITEM NUMBER	ORD. MULT.	SELL UNIT	STD. PKG. STOCK AVAILABILITY / PA	LEAD TIME	MIN. ORD.	A C
-------------	------------	-----------	-----------------------------------	-----------	-----------	-----

260449004 NEC I-5650 56K R V.35 DSU/CSU RACKMOUNT

N

Full or half duplex simplex, point-to-point or multi-point, sync/async, data rates of 56 kbps. HOUSED IN I-1000E & I-1000N RACK.

260388327 NEC I-5650 9.6KB DSU/CSU RACKMOUNT

N
SOE

EA 1 4 1

Full of half duplex simplex, point-to-point or multi-point, sync/async, and data rates of 2.4, 4.8, 9.6 KBPS. HOUSED IN I-1000E OR I-1000N RACK.

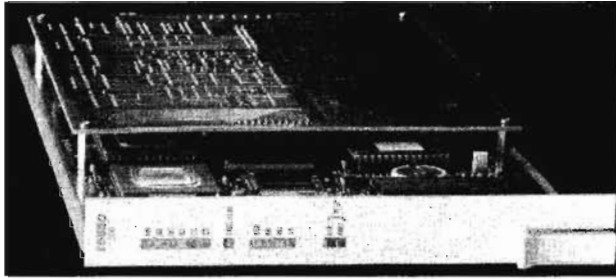

260388327

260449012 NEC I-5650 R V.24 +

N

Full or half duplex simplex, point-to-point or multi-point, sync/async, and data rates of 2.4, 4.8, 9.6, 19.2 KBPS. HOUSED IN I-1000E OR I-1000N RACK.

260449046 NEC N500A 56K DSU/CSU STANDALONE

N

4-wire full duplex, half duplex simplex, point-to-point and multi-point, data rates 56 KBPS.

260449061 NEC N500A 56K RACKMOUNT

N

4-wire full duplex, half duplex simplex, point-to-point and multi-point, data rates 56 KBPS. HOUSED IN I-1000E & I-1000N RACK.

260449053 NEC N500A 9.6 KB RACKMOUNT

N

4-wire full duplex, half duplex simplex, point-to-point and multi-point, data rates 2.4, 4.8, & 9.6 KBPS. HOUSED IN I-1000E & I-1000N RACK.

260449020 NEC N500A 9.6KB DSU/CSU STANDALONE

N

4-wire full duplex, half duplex simplex, point-to-point and multi-point, data rates 2.4, 4.8 & 9.6 KBPS.

260449079 NEC N500A STANDALONE V.24 +

N

4-wire full duplex, half duplex simplex, point-to-point and multi-point, data rates of 2.4, 4.8, 9.6, 19.2 KBPS.

PRODUCT IDENTIFIER

DESCRIPTION

ITEM NUMBER	ORD. MULT.	SELL UNIT	STD. PKG. STOCK AVAILABILITY / PA	LEAD TIME	MIN. ORD.	A C
-------------	------------	-----------	-----------------------------------	-----------	-----------	-----

MODEM T-1 CSU

260449533 DIGITAL LINK DL551X EXTENDED T-1 CSU

N

Used to connect customer premise voice or data equipment to 1.544 Mbit/s T-1 carrier services. MUST ORDER BRACKET DL-1002 PID #260447123 & CABLE PID #260447149.

260449541 DIGITAL LINK T1-ISO DL551A CSU S/A

N

Connects premise equipment such as PBX's, T-1 Multiplexers, T-1 Voice Compressors, DACS, channel banks and front end processors.

260449558 TELLABS 411T-1 CSU SHELF

N

Provides customer premise T-1 equip. with a telephone company span line interface that is in full compliance with the Bell System Tech Reference. Use 14.9007 Rack Adapter Kit to mount in 19 or 23IN.

MODEM T-1 DSU/CSU

260447123 DIGITAL LINK DL1002 RACKMOUNT BRACKET

N

Used for mounting one DL551VX DSU/CSU or two DL551V CSU.

260436209 DIGITAL LINK DL551VX T-1 DSU/CSU

1980664 1

EA

IL

IN

MI

OH

WI

04

04

04

04

04

With DLMS Option. FOR REPAIR ONLY.



1980664

260447180 DIGITAL LINK DL551VX T-1 DSU/CSU W/DLMS

N

Used to connect customer remise data terminal equipment (DTE) to 1.544 Mbit/s T1 carrier services. MUST ORDER BRACKET DL-1002 PID 260447180 AND CABLE PID #260447149.

260447149 SMARTJACK CABLE P/N Q0391-124C

N

Order one for each DL551VX T-1 DSU/CSU. Replaces DL1033 Cable.

260449566 VERILINK CONNECT T-1 DSU/CSU

N

Shelf allows you to connect networks and devices operating at data rates from 56kbps to 1.544MB/s to the T-1 network. Adaptable to 19 or 23 inch Telco rack.

260450697 IBM PC DOS PROFESSIONAL II WORKSTATION

N

Package includes IBM Model 8590OLF E/W 8MB RAM, 400MB Fixed Disk, MS Windows 3.1 W/Mouse, PC-DOS 5.0, NEC 3FGX Monitor & Internal Tape backup.

PRODUCT IDENTIFIER DESCRIPTION

ITEM	ORD.	SELL	STD. PKG.	LEAD TIME	MIN.	A
NUMBER	MULT.	UNIT	STOCK AVAILABILITY / PA	ORD.		C

PERSONAL COMPUTER EQUIPMENT

260445812 APPLE CARD ETHERNET NR P/N M0417LL/A
N

260445804 APPLE CARD TOKEN RING 4/16 NR
N
P/N M0415LL/A.

260445820 APPLE EXTENDED KEYBOARD P/N M0312
N

260445770 APPLE PC PACKAGE INCLUDES APPLE MAC LC
N
4MB RAM, 80MB Fixed Disk, MAC Extended Keyboard, 12in RGB Monitor, SAM and 7.0 Operating System. All software loaded by vendor.

260445788 APPLE PC PACKAGE INCLUDES APPLE MAC SI
N
5MB RAM, 80MB Fixed Disk, Enhanced Keyboard, 13IN Hi-Res Monitor, SAM and 7.0 Operating System. All software loaded by vendor.

260445762 APPLE PC PACKAGE LAPTOP/NOTEBOOK
N
Apple Powerbook 170, 8MB RAM, 80MB Fixed Disk, 2400/9600 Fax/Modem, SAM and 7.0 Operating System. SOE approved Laptop/Notebook Apple Powerbook 170.

260445796 APPLE PC PACKAGE STAFF WORKSTATION II
N
Apple Mac IICI E/W 8MB RAM and D 80MB Fixed Disk, System 7.0, SAM, Extended Keyboard, and 13IN Hi-Res Monitor. SOE approved Staff Workstation II (Apple).

260448998 APPLE PC PKG PROFESSIONAL WORKSTATION
N
Includes Apple Quadra 950 8/230 E/W Extended Keyboard II (M0312), 16IN Cplor monitor, System 7.0 and SAM. SOE approved professional workstation (Apple).

260404363 COMPAQ CARRYING CASE LTE/386S
N EA 1 1 1
Nylon, P/N121287-001.

260404348 COMPAQ ENHANCED MODEM 2400 LTE/386S
N EA 1 1 1
Compaq enhanced 2400 baud modem for LTE/386s laptop, P/N121033-001.

260404231 COMPAQ LTE MODEL 20
N EA 1 1 1
Compaq laptop PC model 20, PN117000-003.

260404256 COMPAQ LTE/386 MODEL 20-60
N EA 1 1 1
Compaq laptop PC LTE 386S/20 model 60, PN121100-003.

PRODUCT IDENTIFIER DESCRIPTION

ITEM	ORD.	SELL	STD. PKG.	LEAD TIME	MIN.	A
NUMBER	MULT.	UNIT	STOCK AVAILABILITY / PA	ORD.		C

260404249 COMPAQ LTE/386S MODEL 20-30
N EA 1 1 1
Compaq laptop PC LTE 386S/20 model 30, PN121100-002.

260395611 COMPAQ SLT/386S MODEL 60
N EA 1 1 1
Compaq laptop PC, P/N118200-003.

260395629 COMPAQ SLT/386S MODEL 120
N EA 1 1 1
Compaq laptop PC, P/N118200-004.

260448634 IBM PC PACKAGE DOS WORKSTATION II
N
Includes PC model 8590OH5 E/W 4MB RAM, 80MB Fixed Disk, MS Windows 3.1 and Mouse, IBM PC DOS 5.0, and NEC 3FGX monitor. SOE approved staff Workstation II (DOS).

260448642 IBM PC PACKAGE #7
N
Includes PC model 8590OH9 W/IBM PC DOS 5.0, Microsoft Mouse and Windows 3.1.

260448659 IBM PC PKG DOS PROFESSIONAL WORKSTATION
N
Includes PC model 8590OL9 E/W 8MB RAM, 160MB fixed disk, MS Windows 3.1 and mouse, IBM PC DOS 5.0 and NEC 3FGX monitor and internal tape backup. SOE approved staff workstation (DOS).

260445838 IBM TAPE BACKUP KIT (DOS) P/N92F3434
N

260445846 IBM TAPE BACKUP KIT (OS/2) P/N87F9830
N

260421987 MACINTOSH IICI 5/80 MB W/SAM
N EA 1 2 1
Apple M5718LL/A including Cache.

260444880 NCR 3335 W/200MB
N
This package includes NCR 3432-1104101 style Keyboard, 200MB Fixed Disk, 4MB Ram, IBM PC/DOS 5.0, and Windows 3.1. Vendor-installed software.

260436266 NCR 386SX MC/20 PC BASIC
N EA 1 2 1
Basic NCR 386SX/MC-20 PC. Includes 3.5IN floppy drive, keyboard, 1 parallel and 1 serial port, and 2MB RAM. No fixed disk or 2MB upgrade.

260423454 NCR ASCOT WORKSTATION 52MB
N EA 1 1 1
Includes: NCR 386SX/MC20 100MB E/W 2MB memory upgrade, IBM T-R Card, NEC 4DS Monitor and IBM PC-DOS 5.0.

260436258 NCR BASIC CPU 386SX W/MEMORY UPGRADE
N EA 1 2 1
NCR 386SX/MC-20 PC equipped with 2MB memory upgrade. No fixed disk. Total 4MB RAM.

DISTRIBUTION SERVICES

NETWORK SERVICES

TOOLS

BUILDING JANITORIAL

AUTOMOTIVE

FORMS/OFFICE SUPPLIES

GENERAL

DATA VOICE

PERSONAL COMPUTER EQUIPMENT

DISTRIBUTION SERVICES

PRODUCT IDENTIFIER		DESCRIPTION					
ITEM NUMBER	ORD. MULT.	SELL UNIT	STD. PKG. STOCK AVAILABILITY / PA	LEAD TIME	MIN. ORD.	A C	

260445747 NCR PC PACKAGE 3433-2000
 N
 Includes 101 Keyboard, SCSI Adapter, 4MB EDAC MEMORY, 200MB Fixed Disk, NEC 3FGX Monitor, IBM PC/DOS 5.0, & Microsoft Mouse W/Windows 3.1. Software loaded by vendor.

NETWORK SERVICES

260420328 NCR PC PACKAGE DOS ASCOT NCR 3421-2210
 N EA 1 1 1
 PC E/W 4MB upgrade (8MB total), ibm pc dos 5.0, Microsoft Windows 3.1 with Mouse, and NEC 4DS Monitor. SOE Approved Staff Workstation I (DOS Ascot).

TOOLS

260420336 NCR PC PACKAGE DOS-NON-ASCOT 3421-2410
 1975268 1 EA IL IN MI OH WI
 01
 PC packaged W/2MB upgrade (4MB total), NEC 3FGX monitor, Microsoft Windows with Mouse, and IBM PC-DOS 5.0. SOE Approved Workstation I (DOS-Non Ascot).

BUILDING JANITORIAL

260432547 NCR PC PACKAGE SX100
 N
 260445754 TOSHIBA PC PACKAGE T2200SX LAPTOP/NOTEBK
 N
 E/W 80MB Fixed Disk, 4MB RAM, DOS 5.0, 2400/9600 Fax/Modem Fabric Carrying Case. SOE approved Laptop/Notebook DOS.

AUTOMOTIVE

PRINTER EQUIPMENT
 260422035 APERTUS/LEE DATA 400CPS F/N1324B
 1976001 1 EA
 W/O Stand.

FORMS/OFFICE SUPPLIES

280043068 APERTUS/LEE DATA F/N1361
 1924803 1 EA IL IN MI OH WI
 GF 01 01 01
 Universal High Speed Monochromatic.

260427661 APPLE IMAGEWRITER II
 N EA 1 1
 260446075 APPLE LASERWRITER IIG W/TONER & LETTER
 N
 CASSETTE Apple B0815LL/A with 8MB of memory.

GENERAL

260446083 APPLE UNIVERSAL MONITOR STAND P/N M0403
 N

260390901 AT&T/TELETYPE 400CPS SSI 6571
 1970509 1 EA IL IN MI OH WI
 SOE 02 02 02
 CC405705419.

DATA VOICE

260000120 AT&T/TELETYPE 40P101/ZZ
 1996595 1 EA IL IN MI OH WI
 01 01 01 01 01
 DISCONTINUED - ORDER NON STOCK UPON STOCK DEPLETION

PRODUCT IDENTIFIER		DESCRIPTION					
ITEM NUMBER	ORD. MULT.	SELL UNIT	STD. PKG. STOCK AVAILABILITY / PA	LEAD TIME	MIN. ORD.	A C	

500046115 AT&T/TELETYPE 40P102/ZZ
 1149740 1 EA IL IN MI OH WI
 01 01 01 01 01

250070414 AT&T/TELETYPE 40P151/ZZ
 1994525 1 EA IL IN MI OH WI
 01 01 01

500046214 AT&T/TELETYPE 40P154/ZZ
 1165811 1 EA IL IN MI OH WI
 01 01 01 01 01

500047568 AT&T/TELETYPE 40P204/ZZ
 1186676 1 EA IL IN MI OH WI
 01 01 01 01 01

260425228 AT&T/TELETYPE 444
 N EA 1 1

500053756 AT&T/TELETYPE 5310
 1121350 1 EA IL IN MI OH WI
 GF 01 01 01 01

500053798 AT&T/TELETYPE 5320-1A0A CC#500053798
 N EA 1 3 1

501002521 AT&T/TELETYPE 53P101BAC
 1935254 1 EA IL IN MI OH WI
 GF 01 01 01 01 01
 A printer designed for use with the E911 system. Keyboard 56K228AAM-See section K.

260322276 AT&T/TELETYPE 53P101BAE M/D NO REPLACMNT
 1942698 1 EA IL IN MI OH WI
 GF 01 01 01 01 01

260388624 AT&T/TELETYPE 572-9500 DR 10IN
 1965236 1 EA IL IN MI OH WI
 SOE 01 01 01 01 01
 80 Column, 9 Pin, Dot Matrix, CC406152983.

260366105 AT&T/TELETYPE 573 9-WIRE CC#406152975
 1955450 1 EA IL IN MI OH WI
 SOE 01 01 01 01 01

260425152 DATA PRODUCTS 8070 PLUS
 N EA 1 4 1

260381066 DATA PRODUCTS 9030 DUAL
 1961003 1 EA IL IN MI OH WI
 04 04
 80 column with serial interface, print wires 9, speed CPS 300, with RS232.

260381033 DATA PRODUCTS 9040 DUAL
 1960971 1 EA IL IN MI OH WI
 01 01
 132 column with serial interface, print wires 9, speed CPS 300, with RS232.

260425160 DEC LA210
 N EA 1 1

PRODUCT IDENTIFIER		DESCRIPTION						
ITEM NUMBER	ORD. MULT.	SELL UNIT	STD. PKG. STOCK AVAILABILITY / PA	LEAD TIME	MIN. ORD.	A	C	
280050857 DEC LA75-S-AA								
1928705	1	EA	IL IN MI OH WI 01					
260425202 DEC LASER MODEL LN03 PLUS								
N		EA	1		1			
260404637 DICONIX 150P								
N		EA	1	2	1			
Diconix 150 plus portable printer, parallel interface, requires 5 NICAD C batteries.								
260404645 DICONIX 150S								
N		EA	1	2	1			
Diconix 150 plus portable printer, serial interface, requires 5 NICAD C batteries.								
260354287 EPSON FX 850 W/10FT CABLE								
1970368	1	EA	IL IN MI OH WI 04 04 04					
260354279 EPSON FX 1050 WITH 10FT CABLE								
1970400	1	EA	IL IN MI OH WI 04 04 04 04					
9 pin dot matrix, 132 column, 264 CPS draft, 54 CPS near letter quality, tractor feed included.								
260354253 EPSON LQ 870 W/10FT PARALLEL CABLE								
N		EA	1	2	1			
SOE Replaces LQ-850.								
260436886 EPSON LQ1170								
N		EA	1	2	1			
Includes 10FT par cable, dot matrix letter quality, 132 column, 24 pin. Replaces PID 260354246.								
260425301 EPSON LQ2550								
N		EA	1		1			
260403670 FACIT C6510								
1970285	1	EA	IL IN MI OH WI 02 02					
260354352 HEWLETT PACKARD DESKJET 500 W/10FT CABLE								
1970434	1	EA	IL IN MI OH WI 04 04 04					
Ported for serial or parallel connection. 240 CPS draft quality, 100 CPS letter quality. Replaces the Deskjet Plus parallel printer cable required for PC connection, basic warranty.								
260425194 HEWLETT PACKARD INKJET HP 2225D								
N		EA	1		1			
RS-232 Serial Version.								
260436951 HEWLETT PACKARD LASERJET III W/TONER								
N		EA	1	2	1			
Includes parallel cable & 2MB upgrade (installed).								
260428339 HEWLETT PACKARD LASERJET III WITH TONER								
1977900	1	EA	IL IN MI OH WI 02 02					

PRODUCT IDENTIFIER		DESCRIPTION						
ITEM NUMBER	ORD. MULT.	SELL UNIT	STD. PKG. STOCK AVAILABILITY / PA	LEAD TIME	MIN. ORD.	A	C	
260354345 HEWLETT PACKARD LASERJET III W/O TONER								
1970475	1	EA	IL IN MI OH WI 02 02					
W/Parallel printer cable for attachment to PC and basic warranty, order with PID 260354360 (Toner).								
260440037 HEWLETT PACKARD LASERJET III-S1								
N		EA	1	2	1			
Includes toner, 10FT parallel cable & 4MB memory upgrade.								
260404678 HEWLETT PACKARD LASERJET IIP-PLUS W/10FT								
N		EA	1	2	1			
SOE Series IIP Printer P/N33471A. Replaces the LaserJet IIP.								
260359062 HEWLETT PACKARD PAINTJET CENTRONICS								
N		EA	1	2	1			
SOE								
260358866 HEWLETT PACKARD PAINTJET SERIAL PRINTER								
N		EA	1	2	1			
SOE								
260425178 ICOT MODEL 560								
N		EA	1		1			
260429683 MEMOREX/TELEX 1324AOZ 900430-102								
N		EA	1	4	1			
260420500 MEMOREX/TELEX 250CPS 900236-103								
N		EA	1	4	1			
260420518 MEMOREX/TELEX 400CPS 900236-101								
N		EA	1	4	1			
260444799 MEMOREX/TELEX DOT MATRIX 6573-S14 400CPS								
N		EA	1	4	1			
260422027 NCR 577 CC#406217158								
1975490	1	EA	IL IN MI OH WI 01 01 01 01					
SOE								
260425210 TALARIS LASER 1590-LN								
N		EA	1		1			
260425335 TEXAS INSTRUMENT OMNILASER 2108								
N		EA	1		1			
RACK								
300087269 GDC DS-1 ADAPTER EARS								
1920249	1	PR						
SOE For GDC DS-1 shelf.								

DISTRIBUTION SERVICES
 NETWORK SERVICES
 TOOLS
 BUILDING JANITORIAL
 AUTOMOTIVE
 FORMS/OFFICE SUPPLIES
 GENERAL
 DATA VOICE

DISTRIBUTION SERVICES
 NETWORK SERVICES
 TOOLS
 BUILDING JANITORIAL
 AUTOMOTIVE
 FORMS/OFFICE SUPPLIES
 GENERAL
 DATA VOICE

RACK

PRODUCT IDENTIFIER DESCRIPTION

ITEM NUMBER	ORD. MULT.	SELL UNIT	STD. PKG. STOCK AVAILABILITY / PA	LEAD TIME	MIN. ORD.	A C
-------------	------------	-----------	-----------------------------------	-----------	-----------	-----

300087277 GDC DS-1 RACK ENCLOSURE
 1920264 1 EA IL IN MI OH WI
 SOE 04 04 04
 Accepts up to 16 rackmount modems, AC powered. For shelf adapters, order item address 1920249.

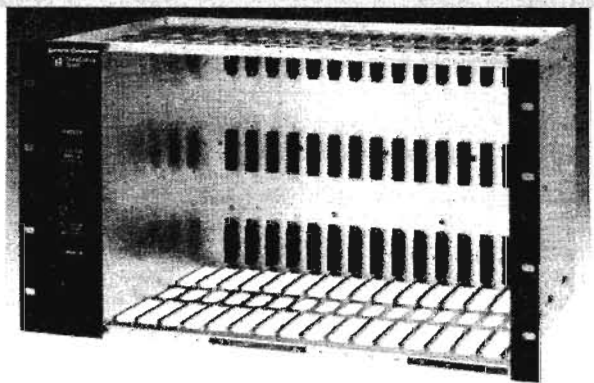

1920264

260440383 GDC DS-6R-1 ADAPTER BRACKET
 1982728 EA IL IN MI OH WI
 04
 Adapter for 26IN mounting. P/N 010J025-002.

260440342 GDC DS-6R-1 RACK ENCLOSURE
 1982736 EA IL IN MI OH WI
 04
 Accepts up to 16 DataComm modems, 48V DC powered. Includes bracket for 19IN or 23IN mounting.

300091444 MULTITECH CC 216 RACK
 N EA 1 1
 For up to 16ea MT224ER Cards. Requires 1ea PS216A Power Supply.

280079641 NEC N40A3 RACK M/D
 1938043 1 EA IL IN MI OH WI
 SOE 37 37 37 37
 Houses N212BR cards. DISCONTINUED UPON STOCK DEPLETION.

280060070 NEC N40B1 RACK
 1938050 1 EA IL IN MI OH WI
 SOE 37 37 37 37
 Houses up to (8) N-201C-L1A/3B (w/reverse channel) or (8) N-201C-L1H modem PC card assemblies ('circuit packs') or up to (16) N-202T-L1A rack. 110 volt PS.

260321948 NEC SR0604 RACK
 1947333 1 EA IL IN MI OH WI
 SOE
 Houses up to 6 DSP-9630 type modems.

260424312 NEC SR0801-U RACK
 N EA 1 4 1
 SOE
 Houses up to eight N-4810-II cards for 19 inch mount.

PRODUCT IDENTIFIER DESCRIPTION

ITEM NUMBER	ORD. MULT.	SELL UNIT	STD. PKG. STOCK AVAILABILITY / PA	LEAD TIME	MIN. ORD.	A C
-------------	------------	-----------	-----------------------------------	-----------	-----------	-----

280060047 NEC SR0801-U RACK
 1938068 1 EA IL IN MI OH WI
 SOE
 Houses up to eight N-4810-II cards for 23IN mount.

260422928 PENRIL DATACOMM DATALINK RACK 1608-01
 1977629 1 EA IL IN MI OH WI
 SOE 01 01 01 01 01
 Multiple modem mounting enclosure for housing up to 8 Datalink 1200/14.4 kbps modems.

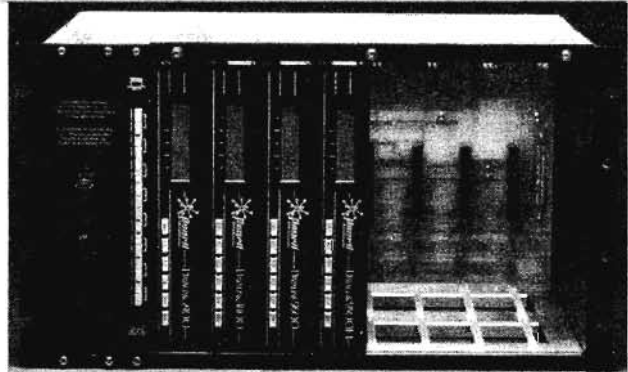

1977629

RACK CHASSIS

260437892 CABLE ADAPTER I-SERIES TO NCTE 5FT
 1981332

260437900 CABLE I-SERIES DIAL-UP ADAPTER 5FT
 1981316 IL IN MI OH WI
 08 08 08

260437918 CABLE NCTE/I-SERIES TURNOVER 5FT
 1981324 IL IN MI OH WI

260445499 NEC ADAPTER BRACKET FOR I-1000N CHASSIS
 1984310 IL IN MI OH WI
 Brackets for mounting I1000N chassis with AT&T # 5ESS installation. NEC P/N 32-16300-027.

260445465 NEC ADAPTER BRACKET FOR I-1000N CHASSIS
 1984302 IL IN MI OH WI
 Adapter required to mount I-1000N Chassis for NT DMS100 installations. NEC P/N 32-16300-027.

260445507 NEC CABLE ASSEMBLY FOR I-1000N CHASSIS
 1984328 IL IN MI OH WI
 Set of 6 cables for I-1000N chassis. 50 pin Telco Connector to 8-position, keyed modular plug used to connect the leased line jacks and the dial jacks. NEC P/N 42-02190-000.

PRODUCT IDENTIFIER DESCRIPTION

ITEM NUMBER	ORD. MULT.	SELL UNIT	STD. PKG. STOCK AVAILABILITY / PA	LEAD TIME	MIN. ORD.	A C
-------------	------------	-----------	-----------------------------------	-----------	-----------	-----

260442462 NEC I-1000N CO CHASSIS
 1984278 EA IL IN MI OH WI
 Compact chassis provides complete control of your dial-up, leased line for DDS Network. Holds up to 32 modems in one rack. **MUST ORDER I-1001E CONTROLLER OR I-1002E SUBCONTROLLER AND 110V OR 48V PS.**

RACK CONTROLLER

260338066 NEC I-1001E INTELLIGENT CONTROLLER
 1951616 1 EA
 SOE

Each controller can command up to 16 chassis with a maximum of 504 modems. It can monitor, test and configure locally or remotely through the network. For NEC I-1000E & I-1000N Rack.

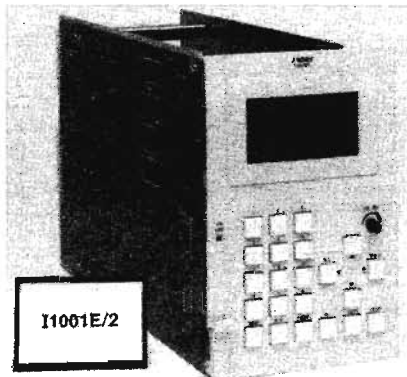

I1001E/2

260338066

RACK POWER

300091451 MULTITECH POWER SUPPLY PS216A
 N EA 11 1
 Converts 115VAC to DC Voltages for CC216 Rack.

260442470 NEC PS006 -48V DC POWER SUPPLY
 1984286 EA IL IN MI OH WI
 For I-1000N Central Office Chassis only. P/N 40-07190-000. Order 2 for redundant power.

260442488 NEC PS007 110V POWER SUPPLY
 1984294 EA IL IN MI OH WI
 For NEC I-1000N Central Office chassis only. P/N 40-07200-000. Order 2 for redundant power.

PRODUCT IDENTIFIER DESCRIPTION

ITEM NUMBER	ORD. MULT.	SELL UNIT	STD. PKG. STOCK AVAILABILITY / PA	LEAD TIME	MIN. ORD.	A C
-------------	------------	-----------	-----------------------------------	-----------	-----------	-----

260388376 NEC PS-002 -48 VOLT DC POWER SUPPLY
 N EA 1 4 1
 SOE

For existing NEC I-1000E chassis only. Order 2 for redundant power. This PS-002 will NOT fit I-1000N Rack.

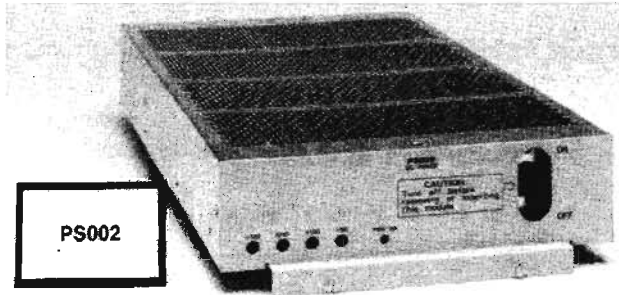

PS002

260388376

260370317 NEC PS-003 110V AC POWER SUPPLY

1956086 1 EA IL IN MI OH WI
 SOE 04 04 04 04

Use only for NEC I-1000E chassis. Order 2 for redundant power. Will NOT fit I-1000N CO Rack.



PS003

1956086

RACK SUBCONTROLLER

260338074 NEC I-1002E SUBCONTROLLER
 1951533 1 EA
 SOE

Provides communications and control to all I series products in the chassis. It provides a control point to configure, test & monitor. For NEC I-1000E & I-1000N Rack.



I1002E/2

260338074

DISTRIBUTION SERVICES

NETWORK SERVICES

TOOLS

BUILDING JANITORIAL

AUTOMOTIVE

FORMS/OFFICE SUPPLIES

GENERAL

DATA VOICE

DISTRIBUTION SERVICES

SOFTWARE

PRODUCT IDENTIFIER		DESCRIPTION				
ITEM NUMBER	ORD. MULT.	SELL UNIT	STD. PKG. STOCK AVAILABILITY / PA	LEAD TIME	MIN. ORD.	A C

SOFTWARE

260390778 ATTACHMATE CC501004626						
N		EA	1	4	1	
3270 #1020-021.						
260424627 ATTACHMATE EXTRA! EXTRA! FOR DOS V2.23						
N		EA	1	2	1	
Bundled 3.5 & 5.25IN Diskettes.						
260431010 ATTACHMATE EXTRA-WINDOWS V3.1						
N		EA	1	2	1	
Bundled 3.5 & 5.25IN Diskettes.						
260413869 CROSSTALK FOR WINDOWS V1.2						
1976391	1	EA	IL IN MI OH WI	04		
Bundled 3.5 & 5.25IN Diskettes.						
260347364 CROSSTALK MK V2.01						
N		EA	1	2	1	
Bundled 3.5 & 5.25IN Diskettes.						
260424395 DATA DESK PROFESSIONAL 3.4						
N		EA	1	2	1	
Operating System MAC.						
260432554 DCA/CROSSTALK CORP CROSSTALK FOR WINDOWS						
N						
5.25IN Diskettes.						
260347372 DCA/CROSSTALK CORP CROSSTALK MK4 5.25IN						
N		EA	1	2	1	
260424585 DOUBLE HELIX II 3.5 OPERATING SYSTEM MAC						
N		EA	1	2	1	
260366828 FASTBACK PLUS V3.0 BUNDLED 3.5 & 5.25IN						
N		EA	1	2	1	
Diskettes.						
260366851 FORMTOOL GOLD						
N		EA	1	2	1	
3.5IN Diskettes.						
260413844 GAZELLE SYSTEMS BACKIT 3.5IN DISKETTES						
N		EA	1	2	1	
BACKIT software for DOS-based PC's, most current version.						
260367594 HARVARD GRAPHICS V 3.0 FOR DOS 3.5IN						
N		EA	1	2	1	
Diskettes packaged with Drawpartner.						
260358932 HARVARD GRAPHICS V 3.0 FOR DOS 5.25IN						
N		EA	1	2	1	
Bundled with Drawpartner software 5.25IN media.						
280054875 HAYES SMARTCOM 3.3 OPERATING SYSTEM MAC						
N		EA	1	2	1	

NETWORK SERVICES

TOOLS

BUILDING JANITORIAL

AUTOMOTIVE

FORMS/OFFICE SUPPLIES

GENERAL

DATA VOICE

PRODUCT IDENTIFIER		DESCRIPTION				
ITEM NUMBER	ORD. MULT.	SELL UNIT	STD. PKG. STOCK AVAILABILITY / PA	LEAD TIME	MIN. ORD.	A C

280071242 IBM DOS 3.30						
N		EA	1	1	1	
Standard IBT PC operating system.						
260425368 IBM DOS 5.0 ALO UP 3						
N		EA	1	2	1	
License to make one copy of IBM PC-DOS 5.0 3.5IN. License only. No media or documentation.						
260425376 IBM DOS 5.0 ALO UP 5						
N		EA	1	2	1	
License to make one copy of IBM PC-DOS 5.0 5.25IN. License only. No media or documentation.						
260368477 IBM PC DOS 3.3 STANDALONE						
N		EA	1	2	1	
260368360 IBM PC DOS 4.01 STANDALONE						
N		EA	1	1	1	
5.25IN. Use this PID when ordering DOS without a PC system.						
260425400 IBM PC DOS 5.0 3.5IN						
N		EA	1	2	1	
Full package to be used on systems currently operating non-IBM PC DOS. i.e. COMPAQ, NCR, ZENITH, etc, etc.						
260425418 IBM PC DOS 5.0 5.25IN						
N		EA	1	2	1	
Full package to be used on systems currently operating non IBM PC DOS. i.e. COMPAQ, NCR, ZENITH, etc, etc.						
260426879 IBM PC DOS 5.0 DOCS						
N		EA	1	1	1	
Documentation concerning the use of IBM PC DOS, from IBM.						
260425384 IBM PC DOS 5.0 UPGRADE 3.5						
N		EA	1	2	1	
5.0 Upgrade to be used on systems currently operating with IBM PC DOS.						
260429865 IBM PC DOS 5.0 UPGRADE 3.5IN						
N		EA	1	2	1	
To be used on non-IBM PC's.						
260429873 IBM PC DOS 5.0 UPGRADE 5.25IN						
N		EA	1	2	1	
IBM PC-DOS 5.0 Upgrade to be used on non-IBM PC's.						
260425392 IBM PC DOS 5.0 UPGRADE 5.25IN						
N		EA	1	2	1	
To be used on systems currently operating with IBM PC-DOS.						
260429899 IBM PC DOS 5.0 UPGRADE LICENSE ONLY						
N		EA	1	2	1	
Allows owner to make a copy of full upgrade on 5.25IN non-IBM PC's.						
260429881 IBM PC DOS 5.0 UPGRADE LICENSE ONLY						
N		EA	1	2	1	
Allows owner to make copy of full upgrade on 3.5IN non-IBM PC's.						

PRODUCT IDENTIFIER		DESCRIPTION				
ITEM NUMBER	ORD. MULT.	SELL UNIT	STD. PKG. STOCK AVAILABILITY / PA	LEAD TIME	MIN. ORD.	A C
260358916		LOTUS 1-2-3 V2.01	3.5IN			
N		EA	1	2	1	
280054883		LOTUS 1-2-3 V2.3 FOR DOS	3.5IN DISKETTES			
N		EA	1	2	1	
260347414		LOTUS FREELANCE PLUS 4.0	MEDIA			
N		EA	1	2	1	
		Graphics program for DOS, 3.5IN disks.				
260358700		LOTUS SYMPHONY V2.0	3.5IN			
N		EA	1	1	1	
260358718		LOTUS SYMPHONY V2.0	5.25IN			
N		EA	1	1	1	
260417027		MAC PROJECT II 2.5				
N		EA	1	2	1	
		Operating System MAC by Claris.				
260413976		MAC240 BY WHITE PINES.				
N		EA	1	2	1	
		Most current version.				
260413984		MAC241 BY WHITE PINES				
N		EA	1	2	1	
		Most current version.				
260417035		MACDRAW II 1.0 OPERATING SYSTEM	MAC			
N		EA	1	2	1	
		By Claris.				
260424569		MACMASTER 6.1 OPERATING SYSTEM	MAC			
N		EA	1	2	1	
260429691		MEMOREX-TELEX 1174-90R	956656-001			
N		EA	1	4	1	
260420526		MEMOREX-TELEX 3.2.1 REL P/N	64106072242			
N		EA	1	4	1	
		For 6544.				
260429634		MEMOREX-TELEX 3.4 6541	953525002			
N		EA	1	4	1	
		Memorex.				
260429675		MEMOREX-TELEX 3.4.1	64953504004			
N		EA	1	4	1	
		For the 6544.				
260443163		MICROGRAPHICS DESIGNER V3.1 FOR	3.5IN			
N		EA	1	2	1	
		Professional Freeform Graphics for the Windows environment.				
260443171		MICROGRAPHICS WINDOWS DRAW V3.0 FOR	3.5			
N		EA	1	2	1	
		Professional Freeform Graphics for the Windows environment.				
260427950		MICROSOFT COMMON PRESENTATION	SYSTEM			
N		EA	1	2	1	
		Operating System MS DOS.				

PRODUCT IDENTIFIER		DESCRIPTION				
ITEM NUMBER	ORD. MULT.	SELL UNIT	STD. PKG. STOCK AVAILABILITY / PA	LEAD TIME	MIN. ORD.	A C
260432562		MICROSOFT EXCEL				
N						
260431002		MICROSOFT EXCEL 3.0				
N		EA	1	2	1	
		Operating System MAC.				
260369541		MICROSOFT EXCEL 3.0 WINDOWS				
1975359	1	EA	IL IN MI OH WI 04			
		Bundled 3.5 & 5.25IN diskettes.				
260449756		MICROSOFT EXCEL 4.0 UPGRADE	3.5IN			
N						
		End-user must supply serial number with request for material.				
260449764		MICROSOFT EXCEL 4.0 UPGRADE	5.25IN			
N						
		End-user must supply serial number with request for material.				
260424510		MICROSOFT MS DOS 3.3 MS DOS	3.5IN DISKS			
N		EA	1	2	1	
260413877		MICROSOFT MS OFFICE FOR WINDOWS				
N		EA	1	2	1	
		Latest version, packaged with 3.5IN diskettes.				
260413836		MICROSOFT MS POWERPOINT FOR WINDOWS				
N		EA	1	2	1	
		Microsoft, latest version, packaged with 3.5 and 5.25IN diskettes.				
260368394		MICROSOFT MS WINDOWS 3.0	5.25IN			
N		EA	1	2	1	
		Sold bundled 3.5in and 5.25in diskettes.				
260368386		MICROSOFT MS WINDOWS 3.1	3.5IN			
N		EA	1	2	1	
		For DOS.				
260443130		MICROSOFT SPCL UPG TO MS WORD FOR	WINDOW			
N						
		Version 2.0, 5.25IN. No charge for customers purchasing V 1.0 after 10/01/91 and before 12/31/91. Customer must provide original P.O. number.				
260443122		MICROSOFT SPCL UPG TO MS WORD FOR	WINDOW			
N						
		Version 2.0 Special Upgrade, 3.5IN. No charge for customers purchasing v 1.0 after 10/01/91 and before 12/31/91. Customer must provide original P.O. number.				
260449772		MICROSOFT UPGR TO WINDOWS 3.1 &	EXCEL4.0			
N						
		3.5IN. End-user must furnish serial number with request for material.				

DISTRIBUTION SERVICES

NETWORK SERVICES

TOOLS

BUILDING JANITORIAL

AUTOMOTIVE

FORMS/OFFICE SUPPLIES

GENERAL

DATA VOICE

DISTRIBUTION SERVICES
 NETWORK SERVICES
 TOOLS
 BUILDING JANITORIAL
 AUTOMOTIVE
 FORMS/OFFICE SUPPLIES
 GENERAL
 DATA VOICE

SOFTWARE

PRODUCT IDENTIFIER		DESCRIPTION				
ITEM NUMBER	ORD. MULT.	SELL UNIT	STD. PKG. STOCK AVAILABILITY / PA	LEAD TIME	MIN. ORD.	A C
260449780			MICROSOFT UPGR TO WINDOWS 3.1 & EXCEL4.0			
N			5.25IN. End-user must furnish serial number with request for material.			
260448675			MICROSOFT WINDOWS 3.1 P/N M5894 5.25IN			
N						
260448667			MICROSOFT WINDOWS 3.1 P/N M5895 3.5IN			
N						
260448691			MICROSOFT WINDOWS 3.1 P/N M6021			
N			With Bus Mouse.			
260448683			MICROSOFT WINDOWS 3.1 P/N M6041			
N			With PS/2 Mouse.			
260424544			MICROSOFT WORD 5.0 OPERATING SYSTEM MAC			
N		EA	1	2	1	
260358924			MICROSOFT WORD FOR DOS V5.5			
N		EA	1	1	1	
			3.5IN Disks.			
260358726			MICROSOFT WORD FOR DOS V5.5			
N		EA	1	1	1	
			With 5.25IN Disks.			
260432570			MICROSOFT WORD FOR WINDOWS			
N						
260375761			MICROSOFT WORD FOR WINDOWS V2.0			
N			Bundled 3.5 & 5.25 diskettes.			
260422076			MICROSOFT WORD V5.5 OPERATING SYSTEM DOS			
N			3.5IN Diskettes.			
260438593			NCR COLOR LANBOOT D440-0031-1000			
N		EA	1	4	1	
260438569			NCR MONO LANBOOT			
N		EA	1	4	1	
			NCR #D440-0030-1000.			
260427943			NIGHT WATCH 1.03 BY KENT MARSH LTD			
N		EA	1	2	1	
			Operating System MAC.			
280071325			NORTON COMMANDER 3.0 BY SYMANTEC			
N		EA	1	2	1	
280071333			NORTON UTILITY ADVANCED BY KENT MARSH LT			
N		EA	1	2	1	
260424387			PAGEMAKER 4.0 FOR WINDOWS 3.5IN			
N		EA	1	2	1	
			Operating System MS Windows.			

PRODUCT IDENTIFIER		DESCRIPTION				
ITEM NUMBER	ORD. MULT.	SELL UNIT	STD. PKG. STOCK AVAILABILITY / PA	LEAD TIME	MIN. ORD.	A C
260366927			PARADOX 3.5 BUNDLED 3.5&5.25IN DISKETTES			
N		EA	1	2	1	
260424551			PERSONAL COMPUTING HFS BACKUP 3.0			
N		EA	1	2	1	
			Operating System MAC.			
260424577			PERSUASION 2.1 OPERATING SYSTEM MAC			
N		EA	1	2	1	
260443148			PERSUASION FOR WINDOWS V 2.0 FOR 3.5IN			
N		EA	1	2	1	
			Standard presentation graphics for the Windows environment.			
260422118			SAM V3.06 OPERATING SYSTEM MAC			
N		EA	1	2	1	
260424452			SAS BASIC 6.03			
N		EA	1	2	1	
			Operating System MS DOS.			
260424460			SAS STAT 6.03			
N		EA	1	2	1	
			Operating System MS DOS.			
260424536			SIM PC MASTER V6.1 FOR DOS 3.5IN DISKET			
N		EA	1	2	1	
			Operating System MS DOS.			
260424486			TIMELINE 5.0 3.5IN BY SYMANTEC			
N		EA	1	2	1	
			Operating System MS DOS.			
260448709			UPGRADE TO MS WINDOWS 3.1 5.25IN			
N			P/N M5896.			
260448725			UPGRADE TO MS WINDOWS 3.1 W/TRUETYPE			
N			Dual Media. P/N M5708.			
260347398			WORDPERFECT 5.1 3.5IN			
N		EA	1	2	1	
			Media Word Processing Program.			
260347406			WORDPERFECT 5.1 5.25IN			
N		EA	1	2	1	
			Media Word Processing Program.			
260429584			PAGEMAKER 4.2 OPERATING SYSTEM MAC			
N		EA	1	2	1	
260424494			WATCHDOG 5.1 BY FISHER INTL SYSTEMS			
N		EA	1	2	1	
			Operating System MS DOS.			

TELEPHONE EQUIPMENT ISDN						
ITEM NUMBER	ORD. MULT.	SELL UNIT	STD. PKG. STOCK AVAILABILITY / PA	LEAD TIME	MIN. ORD.	A C
105197784			ADAPTER 440A 4 AT&T			
N		EA	1	3	1	

PRODUCT IDENTIFIER		DESCRIPTION				
ITEM NUMBER	ORD. MULT.	SELL UNIT	STD. PKG. STOCK AVAILABILITY / PA	LEAD TIME	MIN. ORD.	A C
103985933	N	EA	1	4	1	BOARD ASYNC ENHANCEMENT 2000A-L3
103895645	N	EA	1	3	1	CORD DW8A-DE 10FT AT&T
405056581	N	EA	1	4	1	FILTER ELECTRONIC FSV-192A
406040550	N	EA	1	2	1	MODULE NT1M200
405131558	N	EA	1	3	1	PACK CIRCUIT ISDN NT1P
105675466	N	EA	1	2	1	SET TELEPHONE 7505 TAD02B-215
105676944	N	EA	1	2	1	SET TELEPHONE 7506 TAD02B-215
105678296	N	EA	1	3	1	SET TELEPHONE ISDN 7507TAD02B-215 AT&T
405509852	N	EA	1	4	1	SUPPLY POWER WP90110-L7
104380753	N	EA	1	2	1	UNIT POWER 353 A AT&T
105442735	N	EA	1	4	1	UNIT SERVICE DATA 2000A L4
105345318	N	EA	1	4	1	UNIT SERVICE DATA 7500AL2 AT&T
405897133	N	EA	1	4	1	UNIT TERMINATION NT1U 200
405131137	N	EA	1	2	1	UNIT TERMINATION NT1U RACK MOUNT

TELEPHONE EQUIPMENT MOBILE

260386271	N	EA	1	3	1	ANTENNA MAGNETIC MOUNT For Set Telephone Mobile AC250TP
260386289	N	EA	1	3	1	CASE CARRYING FOR AC250TP
300055639	5116939	1	EA	IL 09 IN 09 MI OH WI		JACK ESD GROUNDING E 1717-M12-F07-1224E modified, .150 inside diameter X 9/16in deep, no threads.
260392717	N	EA	1	4	1	KIT CONVENIENCE FOR OKI 700
260386297	N	EA	1	3	1	SET TELEPHONE MOBILE AC250

PRODUCT IDENTIFIER		DESCRIPTION				
ITEM NUMBER	ORD. MULT.	SELL UNIT	STD. PKG. STOCK AVAILABILITY / PA	LEAD TIME	MIN. ORD.	A C
260386263	N	EA	1	3	1	SET TELEPHONE MOBILE AC250TP
260395215	N	EA	1	4	1	SET TELEPHONE MOBILE OKI 700

TELEPHONE SET

280000274	1921700	1	EA			TELEPHONE SET 0500-13 MBA 44M M/D NO REPLACEMENT.
280000217	N	EA	1	4	1	TELEPHONE SET 0500-13 MBA-20M Beige.
280000191	N	EA	1	4	1	TELEPHONE SET 0550-00 MBA-20M Black.
280000209	N	EA	1	4	1	TELEPHONE SET 0550-09 MBA-20M Ivory.
280000035	1923854	1	EA	IL 04 IN 04 MI OH WI 04		TELEPHONE SET 0554-00 MBA-20M Rotary dial, modular type, black wall telephone set.
280000068	N	EA	1	4	1	TELEPHONE SET 0554-00 MBA-44M Black.
280000043	N	EA	1	4	1	TELEPHONE SET 0554-09 MBA-20M Ivory.
280000076	N	EA	1	6	1	TELEPHONE SET 0554-09 MBA-44M Ivory.
280000050	N	EA	1	4	1	TELEPHONE SET 0554-13 MBA-20M Beige.
280000084	1930008	1	EA	IL 04 IN 04 MI OH WI 04 04		TELEPHONE SET 0554-13 MBA-44M Beige.
103870465	N	EA	1	4	1	TELEPHONE SET 2500SM-60
280000159	N	EA	1	4	1	TELEPHONE SET 2500-00 MBA-20F W/FLAS, Black.
300093291	1927970	1	EA	IL 04 IN 04 MI OH WI		TELEPHONE SET 2500-00 MBA-20M A single line, modular, black desk telephone set.

DISTRIBUTION SERVICES

NETWORK SERVICES

TOOLS

BUILDING JANITORIAL

AUTOMOTIVE

FORMS/OFFICE SUPPLIES

GENERAL

DATA VOICE

DISTRIBUTION SERVICES

TELEPHONE SET

PRODUCT IDENTIFIER		DESCRIPTION				
ITEM NUMBER	ORD. MULT.	SELL UNIT	STD. PKG. STOCK	LEAD TIME AVAILABILITY / PA	MIN. ORD.	A C

300093382 TELEPHONE SET 2500-00 MBA-27M
N EA 1 4 1
Black

300093325 TELEPHONE SET 2500-00 MBA-44M

1928228 1 EA IL IN MI OH WI
04 04 04
A single line, full modular, black desk set with A lead control.

300093309 TELEPHONE SET 2500-09 MBA-20M

N EA 1 4 1
A single line, full modular, tap, Ivory desk telephone set.

300093390 TELEPHONE SET 2500-09 MBA-27M

N EA 1 4 1
Ivory.

300093333 TELEPHONE SET 2500-09 MBA-44M

1927426 1 EA IL IN MI OH WI
04 04 04 04
Ivory.

300093317 TELEPHONE SET 2500-13 MBA-20M

N EA 1 4 1
Beige.

300093408 TELEPHONE SET 2500-13 MBA-27M

N EA 1 4 1
Beige.

300093341 TELEPHONE SET 2500-13 MBA-44M

1927442 1 EA IL IN MI OH WI
04 04 04 04
Beige.

280000167 TELEPHONE SET 2500-45 MBA-20F

N EA 1 4 1
W/FLAS, Ivory.

103870432 TELEPHONE SET 2500-SM 03 BLACK

1161398 1 EA IL IN MI OH WI
04 04 04 04
A common battery desk type touch-tone telephone set intended for use on 1A and 1A1 key telephone systems and 4A speakerphone systems, BSP 502-510-100.

103870622 TELEPHONE SET 2514-BMW 50 IVORY

1216879 1 EA IL IN MI OH WI
04 04 04 04
A modular, touchtone dial desk telephone set for use on 1A1 and 1A2 key telephone systems equipped with turnbutton key for optional operators headset, BSP 502-503-110.

103870663 TELEPHONE SET 2514-BMW 60 BEIGE

1312942 1 EA IL IN MI OH WI
04 04 04 04

300080579 TELEPHONE SET 2554-00 MBA-20M

1218529 1 EA IL IN MI OH WI
04 04 04 04
A modular, touch-tone dial, single line black wall telephone set.

PRODUCT IDENTIFIER DESCRIPTION

ITEM NUMBER	ORD. MULT.	SELL UNIT	STD. PKG. STOCK	LEAD TIME AVAILABILITY / PA	MIN. ORD.	A C
-------------	------------	-----------	-----------------	-----------------------------	-----------	-----

280049230 TELEPHONE SET 2554-00 MBA-44M

1928820 1 EA IL IN MI OH WI
04 04 04 04
A touch-tone, full modular, black wall telephone set with 9ft cord.

300093481 TELEPHONE SET 2554-09 MBA-20M

1925883 1 EA IL IN MI OH WI
04 04 04 04
Ivory.

280049248 TELEPHONE SET 2554-09 MBA-44M

N EA 1 4 1
Ivory.

300093499 TELEPHONE SET 2554-13 MBA-20M

1923839 1 EA IL IN MI OH WI
04 04 04 04
Beige.

280049255 TELEPHONE SET 2554-13 MBA-44M

1928861 1 EA IL IN MI OH WI
04 04 04 04
Beige.

103388294 TELEPHONE SET 2563-HBMS 03 BLACK

1203190 1 EA IL IN MI OH WI
04 04 04 04
A modular, touch-tone dial, 6 button key desk telephone set equipped with headset jack for use with optional headset, BSP 502-543-400.

103388351 TELEPHONE SET 2563-HBMS 60 BEIGE

N EA 1 4 1

280049354 TELEPHONE SET 2564-00 MBA-40M

N EA 1 4 1
Black.

280049362 TELEPHONE SET 2564-09 MBA-40M

N EA 1 4 1
Ivory.

280049370 TELEPHONE SET 2564-13 MBA-40M

N EA 1 4 1
Beige.

280049388 TELEPHONE SET 2565-00 MBA-42M

1928960 1 EA IL IN MI OH WI
04 04 04 04
Black.

280049404 TELEPHONE SET 2565-13 MBA-42M

N EA 1 4 1
Beige.

280049396 TELEPHONE SET 2565-44 MBA-42M

1928986 1 EA IL IN MI OH WI
04 04 04 04
Ash.

103874269 TELEPHONE SET 2565-HKMS 03 BLACK

N EA 1 3 1
Modular, touch-tone dial, 6 button key telephone set, used with 1A, 1A1, 1A2 or 6A Telephone Systems, BSP 502-503-104, BSP 502-503-106, BSP 502-525-100, BSP 502-543-400.

NETWORK SERVICES

TOOLS

BUILDING JANITORIAL

AUTOMOTIVE

FORMS/OFFICE SUPPLIES

GENERAL

DATA VOICE

PRODUCT IDENTIFIER		DESCRIPTION						
ITEM NUMBER	ORD. MULT.	SELL UNIT	STD. PKG. STOCK AVAILABILITY / PA	LEAD TIME			MIN. ORD.	A C
103229787 TELEPHONE SET 2565-HKMS 50 IVORY								
1149864	1	EA	IL IN MI OH WI 04 04 04 04					
103229837 TELEPHONE SET 2565-HKMS 60 BEIGE M/D								
1214817	1	EA	IL IN MI OH WI 04 04 04 04					
103295499 TELEPHONE SET 2630-DAMS 1 60 BEIGE								
1312702	1	EA	IL IN MI OH WI 04 04 04 04					
Call director.								
103295614 TELEPHONE SET 2631 DAMS 1 60								
1183525	1	EA	IL IN MI OH WI 04 04 04 04					
280028630 TELEPHONE SET 2830-00 MBA-46M								
1922443	1	EA	IL IN MI OH WI 04 04 04 04					
A black, modular, touch-tone dial, 10 button key telephone set, desk type, with operator recall button.								
280049420 TELEPHONE SET 2830-13 MBA-46M								
N		EA	1	4			1	
Beige.								
280049412 TELEPHONE SET 2830-44 MBA-46M								
1951053	1	EA	IL IN MI OH WI 04 04 04 04					
Ash.								
102401106 TELEPHONE SET 2830-CM 03 BLACK								
1230441	1	EA	IL IN MI OH WI 04 04 04 04					
A modular, touchtone dial, 10 button key desk telephone set, BSP 503-701-101.								
102401163 TELEPHONE SET 2830-CM 60 BEIGE								
1158832	1	EA	IL IN MI OH WI 04 04 04 04					
103246278 TELEPHONE SET 2830-FM 60 BEIGE								
1180794	1	EA	IL IN MI OH WI 04 04 04 04					
Use refurbished per Hanby.								
280028648 TELEPHONE SET 2831-00 MBA-46M								
1922427	1	EA	IL IN MI OH WI 04 04 04 04					
A black, modular, touch-tone dial, 20 button key desk telephone set with operator recall button.								
280049446 TELEPHONE SET 2831-13 MBA-46M								
1929943	1	EA	IL IN MI OH WI 04 04 04 04					
Beige.								
280049438 TELEPHONE SET 2831-44 MBA-46M								
N		EA	1	4			1	
Ash.								
102403003 TELEPHONE SET 2831-CM 50 IVORY								
1226019	1	EA	IL IN MI OH WI 04 04 04 04					
A modular, touch-tone dial, 20 button key desk telephone set, BSP 503-702-101.								

PRODUCT IDENTIFIER		DESCRIPTION						
ITEM NUMBER	ORD. MULT.	SELL UNIT	STD. PKG. STOCK AVAILABILITY / PA	LEAD TIME			MIN. ORD.	A C
102403052 TELEPHONE SET 2831-CM 60 BEIGE								
1230375	1	EA	IL IN MI OH WI 04 04 04 04					
103246351 TELEPHONE SET 2831-FM 60 BEIGE								
1149872	1	EA	IL IN MI OH WI 04 04 04 04					
102851755 TELEPHONE SET 2851 CM-60								
N		EA	1	4			1	
102851698 TELEPHONE SET 2851CM-3 SP								
N		EA	1	4			1	
102596137 TELEPHONE SET 2852-AM 03 BLACK								
1165886	1	EA	IL IN MI OH WI 04 04 04 04					
A touch-tone dial, 10 button key wall telephone set similar in appearance to the 2851A, BSP 503-701-102.								
102596145 TELEPHONE SET 2852-AM 50 IVORY								
1108217	1	EA	IL IN MI OH WI 05 04 04 04					
102596194 TELEPHONE SET 2852-AM 60 BEIGE								
1129338	1	EA	IL IN MI OH WI 04 04 04 04					
280099946 TELEPHONE SET 2861-13 MBA-56M								
N		EA	1	4			1	
Beige.								
280099953 TELEPHONE SET 2861-44 MBA-56M								
N		EA	1	4			1	
Ash.								
103873113 TELEPHONE SET 2872 A2M 60 M/D								
1150854	1	EA	IL IN MI OH WI 04 04 04 04					
Six button key telephone with 30 button Touch-A-Matic dialer. Manufacturer discontinued, refurbished-only available.								
103871083 TELEPHONE SET 2993-C01 ATTIS								
1312207	1	EA	IL IN MI OH WI 04 04 04 04					
260422746 TELEPHONE SET 3300-00 MBA-20M								
N		EA	1	6			1	
260422241 TELEPHONE SET 3300-00-MBA-44M								
N		EA	1	4			1	
260411343 TELEPHONE SET 3300-09 MBA-20M								
1971234	1	EA	IL IN MI OH WI 04 04 04 04					
260422753 TELEPHONE SET 3300-13 MBA-20M								
N		EA	1	4			1	
260422233 TELEPHONE SET 3300-13-MBA-44M								
N		EA	1	5			1	

DISTRIBUTION SERVICES
 NETWORK SERVICES
 TOOLS
 BUILDING JANITORIAL
 AUTOMOTIVE
 FORMS/OFFICE SUPPLIES
 GENERAL
 DATA VOICE

DISTRIBUTION SERVICES

TELEPHONE SET

PRODUCT IDENTIFIER		DESCRIPTION				
ITEM NUMBER	ORD. MULT.	SELL UNIT	STD. PKG. STOCK	LEAD TIME AVAILABILITY / PA	MIN. ORD.	A C

280000001		TELEPHONE SET	3554-00	MBA-20M		
N		EA	1	4	1	
		Black.				

280000019		TELEPHONE SET	3554-09	MBA-20M		
N		EA	1	4	1	
		Ivory.				

280000027		TELEPHONE SET	3554-13	MBA-20M		
N		EA	1	4	1	
		Beige.				

NETWORK SERVICES

TOOLS

PRODUCT IDENTIFIER		DESCRIPTION				
ITEM NUMBER	ORD. MULT.	SELL UNIT	STD. PKG. STOCK	LEAD TIME AVAILABILITY / PA	MIN. ORD.	A C
280324140		TELEPHONE SET	KXT-2365			
1945675	1	EA	IL 04	IN 04	MI 04	OH 04
			WI 04			
		Panasonic speakerphone with LED display, 28-number speed dial, hold, flash & mute keys. Ash.				

PRODUCT IDENTIFIER		DESCRIPTION				
ITEM NUMBER	ORD. MULT.	SELL UNIT	STD. PKG. STOCK	LEAD TIME AVAILABILITY / PA	MIN. ORD.	A C
280324132		TELEPHONE SET	KXT-3145			
1945667	1	EA	IL 04	IN 04	MI 04	OH 04
			WI 04			
		Panasonic 2-line telephone with automatic dialer, 3-way conferencing, electronic hold, speakerphone, save redial, and memo save. Ash.				



1945667

280071614		TELEPHONE SET	KXT-3155			
N		EA	1	3	1	
		Panasonic 2-line speakerphone w/LED display, 28-number speed dial, hold, 3-way conferencing, ash.				

260368527		TELEPHONE SET	KX-T2322			
N		EA	1	2	1	
		Panasonic single line telephone w/LED display, 30 programmable numbers (no speakerphone). Ash.				

260368410		TELEPHONE SET	KX-T2335			
N		EA	1	4	1	
		Panasonic Single line set with 28 number speed dial, flash key, hold, redial, (no speakerphone). Ash.				

260368535		TELEPHONE SET	KX-T2342			
N		EA	1	2	1	
		Panasonic single line speakerphone w/15 number speed dial (no LED display, no re-dial, no hold).				

BUILDING JANITORIAL

AUTOMOTIVE

FORMS/OFFICE SUPPLIES

GENERAL

DATA VOICE

PRODUCT IDENTIFIER		DESCRIPTION				
ITEM NUMBER	ORD. MULT.	SELL UNIT	STD. PKG. STOCK	LEAD TIME AVAILABILITY / PA	MIN. ORD.	A C

260368428		TELEPHONE SET	KX-T2355			
N		Panasonic single-line telephone w/28-number speed dial, hold, speakerphone, flash redial. No LED display.				

260420120		TELEPHONE SET	KX-T3110			
N		EA	1	2	1	
		Panasonic 2-line telephone w/20 number speed dial, 3-way conference, hold, re-dial, and flash keys (ash). No speakerphone, no LED display.				

260368543		TELEPHONE SET	KX-T3142			
N		EA	1	2	1	
		Panasonic 2-line set w/automatic dialing, electronic hold & speakerphone.				

260368550		TELEPHONE SET	KX-T3145B			
N		Panasonic 2-line telephone w/automatic dialer, 3-way conference, electronic hold, speakerphone, save redial, memo dial. Black.				

260368444		TELEPHONE SET	KX-T3155B			
N		EA	1	2	1	
		Panasonic 2-line speakerphone w/LED display, 28-number speed dial, hold, 3-way conferencing, black.				

260420138		TELEPHONE SET	KX-T3620			
N		EA	1	2	1	
		Panasonic cordless telephone w/flexible rubber antenna, re-dial, and flash keys, 10 speed dial numbers, low battery indicator.				

260430723		TELEPHONE SET	LINEBACKER ITT			
1978874	1	EA	IL	IN	MI	OH
			WI			
		ITT Cortelco 8125 Trendline telephone, used only for the Linebacker Program.				

260339801		TELEPHONE SET	LINEBACKER NTI			
1949727	1	EA	IL 25	IN 25	MI 25	OH 25
			WI 25			
		Northern Telecom Symphony 1000 telephone (used only for the Linebacker Program).				

104198775		TELEPHONE SET	TRIMLINE 210	IVORY		
N		EA	1	3	1	

280022401		TELEPHONE SET	VOICE EXPRESS	VX41CBG		
1930743	1	EA	IL 04	IN 04	MI 04	OH 04
			WI 04			
		VX-41B Cordial Voice Express telephone, graphite grey housing, for use with 1A2 and PBX systems, hands free speakerphone, 41 number memory. A direct replacement for Set Tel 2872.				

TELEPHONE EQUIPMENT MERIDIAN

260412192		MODULE 18	BUTTON	NT4X38EA	ASH	
N		EA	1	4	1	
		18-button add-on module M518 for the Northern Telecom Meridian ISDN telephones.				

TELEPHONE EQUIPMENT - MISCELLANEOUS

PRODUCT IDENTIFIER DESCRIPTION

ITEM NUMBER	ORD. MULT.	SELL UNIT	STD. PKG. STOCK AVAILABILITY / PA	LEAD TIME	MIN. ORD.	A C
-------------	------------	-----------	-----------------------------------	-----------	-----------	-----

260446356 MODULE 18-BUTTON NT4X38 BLACK

N

18-button add-on module M518 for the Northern Telecom Meridian ISDN telephones.

260416193 SET TELEPHONE MERIDIAN NT4X31 ASH

1972711	1	EA	IL IN MI OH WI 04 04
---------	---	----	-------------------------

M5112, An electronic multi-line telephone, hands free, 5 fixed feature buttons, 10 programmable keys, operating on 2 wire, to be used on a DMS Centrex only.

260416094 SET TELEPHONE MERIDIAN NT4X31 BLACK

1972703	1	EA	IL IN MI OH WI 04
---------	---	----	----------------------

M5112, An electronic multi-line telephone, hands free, 5 fixed feature buttons, 10 programmable keys, operating on 2 wire, to be used on a DMS Centrex only.

260415492 SET TELEPHONE MERIDIAN NT4X35 ASH

1972646	1	EA	IL IN MI OH WI 04
---------	---	----	----------------------

M5009, 3 fixed keys, 9 programmable feature, directory keys with 8 LCD indicators, equipt with speaker for on-hook dialing, intercom & alert tones, to be used on DMS Centrex only.

260415591 SET TELEPHONE MERIDIAN NT4X35 BLACK

1972653	1	EA	IL IN MI OH WI 04
---------	---	----	----------------------

M5009, 3 fixed keys, 9 programmable feature, directory keys with 8 LCD indicators, equipt with speaker for on-hook dialing, intercom & alert tones, to be used on DMS Centrex only.

260415997 SET TELEPHONE MERIDIAN NT4X36 ASH

1972695	1	EA	IL IN MI OH WI 04 04
---------	---	----	-------------------------

M5209, LCD display, 3 fixed keys, 9 programmable feature, muted dialing, to be used on DMS Centrex only.

260415898 SET TELEPHONE MERIDIAN NT4X36 BLACK

1972687	1	EA	IL IN MI OH WI 04
---------	---	----	----------------------

M5209, LCD display, 3 fixed keys, 9 programmable feature, muted dialing, to be used on DMS Centrex only.

260415799 SET TELEPHONE MERIDIAN NT4X37 ASH

1972679	1	EA	IL IN MI OH WI 04 04
---------	---	----	-------------------------

M5312, LCD display, 5 fixed keys, 10 programmable feature, speakerphone, to be used on DMS Centrex only.

260415690 SET TELEPHONE MERIDIAN NT4X37 BLACK

1972681	1	EA	IL IN MI OH WI 04
---------	---	----	----------------------

M5312, LCD display, 5 fixed keys, 10 programmable feature, speakerphone, to be used on DMS Centrex only.

PRODUCT IDENTIFIER DESCRIPTION

ITEM NUMBER	ORD. MULT.	SELL UNIT	STD. PKG. STOCK AVAILABILITY / PA	LEAD TIME	MIN. ORD.	A C
-------------	------------	-----------	-----------------------------------	-----------	-----------	-----

TELEPHONE EQUIPMENT - MISCELLANEOUS

260420112 ADAPTER AC KX-A10

N		EA	1	2	1	
---	--	----	---	---	---	--

AC power adapter for use with all Panasonic telephones, instead of the required batteries.

280057365 ADAPTER KEYSTRIP KBA5LGG

1930677	1	EA	IL IN MI OH WI 04 04 04 04
---------	---	----	-------------------------------

A Comdial 6-button (5 line and hold button) keystrip which connects to the Comdial Voice Express tel set. Graphite gray.

280057381 ADAPTER KEYSTRIP KBA9GG

1930685	1	EA	IL IN MI OH WI 04 04 04 04
---------	---	----	-------------------------------

A Comdial 10-button keystrip (9 line and hold button) which connects to the Comdial Voice Express tel set. Graphite gray.

102094323 BASE INDICATOR 1A

2752766	1	EA	IL IN MI OH WI 04 04 04 04
---------	---	----	-------------------------------

A single lamp indicator base intended as a visual signal at the subscriber stations. The 51A or 52A lamp and the 1 type indicator lens are ordered separately, BSP 463-210-100.

102247392 BASE SET TELEPHONE 2831CM

1190959	1	EA	IL IN MI OH WI 04 04 04 04
---------	---	----	-------------------------------

A twenty button touchtone modular key telephone set with mounting cord. Housing 832A, Plate Face 2833A, Set Hand G15A and Cord H4DU must be ordered separately, BSP 503-701-101. DISCONTINUE

102865664 BASE SET TELEPHONE 2851CM

N		EA	1	3	1	
---	--	----	---	---	---	--

A six button dial modular wall telephone for use with key telephone systems. BSP 503-601-101.

280000449 BASE SET TELEPHONE OA61 00 FBA

N		EA	1	4	1	
---	--	----	---	---	---	--

280000456 BASE SET TELEPHONE OA61 09 FBA

N		EA	1	4	1	
---	--	----	---	---	---	--

280000464 BASE SET TELEPHONE OA61-13-FBA DESK

N		EA	1	4	1	
---	--	----	---	---	---	--

280000373 BASE SET TELEPHONE OACI-00-FBA WALL

1921163	1	EA	IL IN MI OH WI 04 04
---------	---	----	-------------------------

DISCONTINUED - ORDER NON-STOCK UPON STOCK DEPLETION.

280000472 BASE SET TELEPHONE OACI-09-FBA WALL

N		EA	1	4	1	
---	--	----	---	---	---	--

280000506 BASE SET TELEPHONE OACI-13-FBA WALL

1923920	1	EA	IL IN MI OH WI 04 04
---------	---	----	-------------------------

403302912 BATTERY CK21906 L9

N		EA	1	2	1	
---	--	----	---	---	---	--

DISTRIBUTION SERVICES

NETWORK SERVICES

TOOLS

BUILDING JANITORIAL

AUTOMOTIVE

FORMS/OFFICE SUPPLIES

GENERAL

DATA VOICE

TELEPHONE EQUIPMENT - MISCELLANEOUS

DISTRIBUTION SERVICES

PRODUCT IDENTIFIER		DESCRIPTION				
ITEM NUMBER	ORD. MULT.	SELL UNIT	STD. PKG. STOCK AVAILABILITY / PA	LEAD TIME	MIN. ORD.	A C
100007368		BELL	7C			
N		EA	1	5	1	

NETWORK SERVICES

PRODUCT IDENTIFIER		DESCRIPTION				
ITEM NUMBER	ORD. MULT.	SELL UNIT	STD. PKG. STOCK AVAILABILITY / PA	LEAD TIME	MIN. ORD.	A C
400009957		BELL	CK16301 L3			
N		EA	1	3	3	
A 6in, vibrating, 110V AC operated bell, equipped with volume control, BSP 463-110-100.						
103985925		BOARD SYNC/ACU ENHANCEMENT	2000A-L2			
N		EA	1	4	1	

TOOLS

PRODUCT IDENTIFIER		DESCRIPTION				
ITEM NUMBER	ORD. MULT.	SELL UNIT	STD. PKG. STOCK AVAILABILITY / PA	LEAD TIME	MIN. ORD.	A C
002079580		BRACKET	67B			
N		EA	1	3	1	
Used on relay rack for mounting KTU 201B on 1A and 1A1 key telephone systems, 23in long. BSP 463-140-100.						
100013895		BRACKET	70A			
N		EA	1	6	1	
For mounting CK type buzzers in 500 type sets. BSP 501-120-100.						

BUILDING JANITORIAL

PRODUCT IDENTIFIER		DESCRIPTION				
ITEM NUMBER	ORD. MULT.	SELL UNIT	STD. PKG. STOCK AVAILABILITY / PA	LEAD TIME	MIN. ORD.	A C
100013960		BRACKET	76A			
N		EA	1	2	1	
For attaching 549 (C & D) signal keys to telephone sets. BSP 463-215-100.						
100013978		BRACKET	77A			
1116525	1	EA	IL IN MI OH WI 04 04 04 04 04			
Used to attach keys to side of telephone sets. BSP 463-215-100.						

AUTOMOTIVE

PRODUCT IDENTIFIER		DESCRIPTION				
ITEM NUMBER	ORD. MULT.	SELL UNIT	STD. PKG. STOCK AVAILABILITY / PA	LEAD TIME	MIN. ORD.	A C
845881333		BUTTON LOUD ASSEMBLY				
N		EA	1	4	1	
260412077		CABLE TRANSCEIVER	BNE3K-05			
N		EA	1	2	1	

FORMS/OFFICE SUPPLIES

PRODUCT IDENTIFIER		DESCRIPTION				
ITEM NUMBER	ORD. MULT.	SELL UNIT	STD. PKG. STOCK AVAILABILITY / PA	LEAD TIME	MIN. ORD.	A C
300080686		CONNECTOR PLUG	225395-2			
1222158	1	EA	IL IN MI OH WI 18			
300080678		CONNECTOR RECEPTACLE	225396-2 AMP			
5125278	1	EA	IL IN MI OH WI 18			
101426492		CORD	3P 6A 1FT SLATE			
1135962	1	EA	IL IN MI OH WI 04 04 04 04 04			

GENERAL

PRODUCT IDENTIFIER		DESCRIPTION				
ITEM NUMBER	ORD. MULT.	SELL UNIT	STD. PKG. STOCK AVAILABILITY / PA	LEAD TIME	MIN. ORD.	A C
101426534		CORD	3P 6F 10FT SLATE			
N		EA	1	2	1	
101426559		CORD	3P 6H 15FT SLATE			
N		EA	1	4	1	
101426583		CORD	3P 7A 6FT SLATE			
1136002	1	EA	IL IN MI OH WI 04 04 04 04 04			
Three-conductor P3E cord e/w two 310 plugs.						

DATA VOICE

PRODUCT IDENTIFIER		DESCRIPTION				
ITEM NUMBER	ORD. MULT.	SELL UNIT	STD. PKG. STOCK AVAILABILITY / PA	LEAD TIME	MIN. ORD.	A C
102872470		CORD	8AA 87 XLONG			
N		EA	1	3	1	

PRODUCT IDENTIFIER		DESCRIPTION				
ITEM NUMBER	ORD. MULT.	SELL UNIT	STD. PKG. STOCK AVAILABILITY / PA	LEAD TIME	MIN. ORD.	A C
102416658		CORD	D 4BT 87 LONG			
1111807	1	EA	IL IN MI OH WI 04 04 04 04			
A clear plastic cord, individually packaged.						

PRODUCT IDENTIFIER		DESCRIPTION				
ITEM NUMBER	ORD. MULT.	SELL UNIT	STD. PKG. STOCK AVAILABILITY / PA	LEAD TIME	MIN. ORD.	A C
102416666		CORD	D 4BT 87 STANDARD			
1194555	1	EA	IL IN MI OH WI 04 04 04 04			
Individually packaged.						

PRODUCT IDENTIFIER		DESCRIPTION				
ITEM NUMBER	ORD. MULT.	SELL UNIT	STD. PKG. STOCK AVAILABILITY / PA	LEAD TIME	MIN. ORD.	A C
102999059		CORD	D 4BY 87 14FT			
1173450	1	EA	IL IN MI OH WI 04 04 04 04			

PRODUCT IDENTIFIER		DESCRIPTION				
ITEM NUMBER	ORD. MULT.	SELL UNIT	STD. PKG. STOCK AVAILABILITY / PA	LEAD TIME	MIN. ORD.	A C
102937604		CORD	D 6AP 87 LONG IP			
1178350	1	EA	IL IN MI OH WI 04 04 04 04			

PRODUCT IDENTIFIER		DESCRIPTION				
ITEM NUMBER	ORD. MULT.	SELL UNIT	STD. PKG. STOCK AVAILABILITY / PA	LEAD TIME	MIN. ORD.	A C
102937620		CORD	D 6AP 87 STD IP			
N		EA	1	2	1	

PRODUCT IDENTIFIER		DESCRIPTION				
ITEM NUMBER	ORD. MULT.	SELL UNIT	STD. PKG. STOCK AVAILABILITY / PA	LEAD TIME	MIN. ORD.	A C
102872496		CORD	D 8AA 87 LONG			
N		EA	1	3	1	
Individually packaged.						

PRODUCT IDENTIFIER		DESCRIPTION				
ITEM NUMBER	ORD. MULT.	SELL UNIT	STD. PKG. STOCK AVAILABILITY / PA	LEAD TIME	MIN. ORD.	A C
102872512		CORD	D 8AA 87 STANDARD			
1130195	1	EA	IL IN MI OH WI 04 04 04 04			
Individually packaged cord used to connect a 503CM or 2503 CM telephone set to a 635A connecting block.						

PRODUCT IDENTIFIER		DESCRIPTION				
ITEM NUMBER	ORD. MULT.	SELL UNIT	STD. PKG. STOCK AVAILABILITY / PA	LEAD TIME	MIN. ORD.	A C
102796968		CORD	D 8W 50 LONG			
1311126	1	EA	IL IN MI OH WI 04 04 04 04			
Individually packaged.						

PRODUCT IDENTIFIER		DESCRIPTION				
ITEM NUMBER	ORD. MULT.	SELL UNIT	STD. PKG. STOCK AVAILABILITY / PA	LEAD TIME	MIN. ORD.	A C
104229281		CORD	D 8W 87 2FT 6IN			
N		EA	1	2	1	

PRODUCT IDENTIFIER		DESCRIPTION				
ITEM NUMBER	ORD. MULT.	SELL UNIT	STD. PKG. STOCK AVAILABILITY / PA	LEAD TIME	MIN. ORD.	A C
103786802		CORD	D 8W 87 14FT			
N		EA	1	2	1	

PRODUCT IDENTIFIER		DESCRIPTION				
ITEM NUMBER	ORD. MULT.	SELL UNIT	STD. PKG. STOCK AVAILABILITY / PA	LEAD TIME	MIN. ORD.	A C
103786828		CORD	D 8W 87 25FT			
N		EA	1	2	1	

PRODUCT IDENTIFIER		DESCRIPTION				
ITEM NUMBER	ORD. MULT.	SELL UNIT	STD. PKG. STOCK AVAILABILITY / PA	LEAD TIME	MIN. ORD.	A C
103848792		CORD	DW 4ASE 2FT			
N		EA	1	2	1	

PRODUCT IDENTIFIER		DESCRIPTION				
ITEM NUMBER	ORD. MULT.	SELL UNIT	STD. PKG. STOCK AVAILABILITY / PA	LEAD TIME	MIN. ORD.	A C
103895660		CORD	DW 4ASE 10FT AT&T			
N		EA	1	2	1	

PRODUCT IDENTIFIER		DESCRIPTION				
ITEM NUMBER	ORD. MULT.	SELL UNIT	STD. PKG. STOCK AVAILABILITY / PA	LEAD TIME	MIN. ORD.	A C
103895652		CORD	DW 8ADE 100FT AT&T			
N		EA	1	3	1	

PRODUCT IDENTIFIER		DESCRIPTION				
ITEM NUMBER	ORD. MULT.	SELL UNIT	STD. PKG. STOCK AVAILABILITY / PA	LEAD TIME	MIN. ORD.	A C
103002705		CORD	F76BA000740C87 7FT			
N		EA	1	5	1	
Individually packaged 4 conductor cord, spade tipped on one end, modular on the other, used to move a non-standard special tel set from a hardwire environment to a modular one.						

PRODUCT IDENTIFIER		DESCRIPTION				
ITEM NUMBER	ORD. MULT.	SELL UNIT	STD. PKG. STOCK AVAILABILITY / PA	LEAD TIME	MIN. ORD.	A C
103002671		CORD	F76BA000740C87 102999059			
N		EA	1	3	1	

TELEPHONE EQUIPMENT - MISCELLANEOUS

PRODUCT IDENTIFIER		DESCRIPTION					
ITEM NUMBER	ORD. MULT.	SELL UNIT	STD. PKG. STOCK AVAILABILITY / PA	LEAD TIME	MIN. ORD.	A C	
103895629 CORD F82BA0007 10FT							
4255646	1	EA	IL IN MI OH WI 18 18 18 18				
Individually packaged, double ended, modular, two pair, inside wiring cable. May be used to connect registration jacks to common equipment or for station installation.							
103895637 CORD F82BA0007 100FT MODULAR							
4255703	1	EA	IL IN MI OH WI 18				
Individually packaged, modular, two pair, cord 100ft in length. Has gray PVC insulation.							
102526480 CORD M 1R 7 1/2							
2823187	1	EA	IL IN MI OH WI 04 04 04 04 04				
102812773 CORD M 4AR 29 5 3/4							
1175091	1	EA	IL IN MI OH WI 04 04 04 04 04				
101930816 CORD P 2AY BR							
N		EA	1	9		1	
Equipped with 2ea Plug 352A.							
100160415 CORD S3B SLATE W/310 RED 8FT							
N		EA	1	3		1	
400980413 CORD CK14532 L 3 M/D							
3136184	1	EA	IL IN MI OH WI 31 31 31				
Used in conjunction with Panel Power 1A1 (1178616). DISCONTINUE UPON STOCK DEPLETION							
997365952 CORD CK14532 L16 10FT GREY							
1214593	1	EA	IL IN MI OH WI 31 31 31 31 31				
Used in conjunction with Panel Power 1A1 (1178616).							
401448121 CORD CK14532 L24 6FT							
1131805	1	EA	IL IN MI OH WI 31 31 31 31 31				
A 6 foot power cord used with Panel Power 1A1 (1178616).							
401957543 CORD CK16935 L27 72IN							
1166827	1	EA	IL IN MI OH WI 31 31 31 31 31				
Used with Unit Service Key 551C (PID 102089315) & Panel Power 1A1 (1168616).							
401957568 CORD CK16935 L29							
1196972	1	EA	IL IN MI OH WI 31 31 31 31 31				
Used in conjunction with Panel Power 1A1 (1168616).							
102796976 CORD D 8W 50 STD IP							
N		EA	1	3		1	
103730321 CORD DW8A-DE 25FT							
N		EA	1	3		1	
102318276 CORD H 4CJ 3 LONG							
N		EA	1	4		1	

PRODUCT IDENTIFIER		DESCRIPTION					
ITEM NUMBER	ORD. MULT.	SELL UNIT	STD. PKG. STOCK AVAILABILITY / PA	LEAD TIME	MIN. ORD.	A C	
102402658 CORD HANDSET H4DU 60 STANDARD BEIGE							
N		EA	1	3		1	
Individually packaged.							
102658671 CORD HANDSET H4DU 139 M/D							
N		EA	1	5		2000	
REPLACED BY 260366281.							
102401445 CORD HANDSET H4DU-03 12FT BLACK							
1104257	1	EA	IL IN MI OH WI 04 04 04 04 04				
Individually packaged, 4 conductor, plug ended, retractable, colored, hand set cord for use with modular telephone sets, G15 handsets, BSP 503-100-100.							
260366281 CORD HANDSET H4DU-139 12FT GRAY							
1955054	1	EA	IL IN MI OH WI 04 04				
104236856 CORD HANDSET H4DU-3 25FT BLACK							
N		EA	6	3		6	
102402526 CORD HANDSET H4DU-50 12FT IVORY							
1104281	1	EA	IL IN MI OH WI 04 04 04 04 04				
Individually packaged.							
104236872 CORD HANDSET H4DU-50 25FT IVORY							
N		EA	1	3		1	
102402542 CORD HANDSET H4DU-51 12FT							
N							
Modular, Moss green.							
104236914 CORD HANDSET H4DU-53 25FT RED							
N		EA	6	2		6	
102402609 CORD HANDSET H4DU-58 12FT WHITE							
N		EA	1	3		1	
Individually packaged.							
104236955 CORD HANDSET H4DU-58 25FT WHITE							
N		EA	6	2		6	
102402641 CORD HANDSET H4DU-60 12FT BEIGE							
1311175	1	EA	IL IN MI OH WI 04 04 04 04 04				
Individually packaged.							
104236971 CORD HANDSET H4DU-60 25FT BEIGE							
N		EA	6	2		6	
102808961 CORD M8P STD							
N		EA	1	8		1	
102479896 CORD MOD LINE D4BU-29 14FT SILVER SATIN							
1139659	1	EA	IL IN MI OH WI 04 04 04 04 04				
Individually packaged.							
102479888 CORD MOD LINE D4BU-29 25FT SILVER SATIN							
1225805	1	EA	IL IN MI OH WI 04 04 04 04 04				
Individually packaged.							

DISTRIBUTION SERVICES
NETWORK SERVICES
TOOLS
BUILDING JANITORIAL
AUTOMOTIVE
FORMS/OFFICE SUPPLIES
GENERAL
DATA VOICE

TELEPHONE EQUIPMENT - MISCELLANEOUS

DISTRIBUTION SERVICES

PRODUCT IDENTIFIER		DESCRIPTION					
ITEM NUMBER	ORD. MULT.	SELL UNIT	STD. PKG. STOCK AVAILABILITY / PA	LEAD TIME	MIN. ORD.	A	C
102903317			CORD MOD LINE D4BU-29 2FT SILVER SATIN				
1193730	1	EA	IL 04	IN 04	MI 04	OH 04	WI 04
Transparent 4 conductor polyvinylchloride jacketed cord w/polyester insulated tinsel conductor, equipped w/polycarbonated push-to-lock type plug, BSP 503-100-100.							

NETWORK SERVICES

102479904			CORD MOD LINE D4BU-29 7FT SILVER SATIN				
1198416	1	EA	IL 04	IN 04	MI 04	OH 04	WI 04

103789301			CORD MOD LINE D4BU-29 8FT SILVER SATIN				
N		EA	1	4	1		

TOOLS

100169960			COVER BLOCK 117A				
1143354	1	EA	IL 08	IN	MI	OH 08	WI

102299245			DIAL 3543D M/D SEE PID 103747457				
2601740	1	EA	IL 04	IN 04	MI 04	OH 04	WI 04

102242468			DIAL 35AF3A				
1187849	1	EA	IL 04	IN 04	MI 04	OH 04	WI 04
Used on 2500, 2600 type telephone and provides switching for use with speakerphone, BSP 501-164-115.							

102298643			DIAL 35AG3A				
1139576	1	EA	IL 04	IN 04	MI 04	OH 04	WI 04
Touch-tone dial used in 2872 A1M telephone set, Touch-A-Matic, BSP 503-603-101.							

102802345			DIAL 35AY3A				
1224469	1	EA	IL 04	IN 04	MI 04	OH 04	WI 04

101205011			DIAL 35F3A M/D NO REPLACEMENT				
N		EA	1	4	1		

101820017			DIAL 35Y3A				
N		EA	1	3	1		

101390243			DIAL 66A3C M/D NO REPLACEMENT				
N		EA	1	4	1		

280000696			DIAL TT004200 EPG				
N		EA	2	4	2		
Replacement dial for the ITT 3500 type sets.							

260318167			DIAL TT004600 OPG				
N		EA	1	4	1		

102980042			EXTENDER 32A				
N		EA	1	1	1		

102977725			EXTENDER RINGER 603A				
N		EA	1	4	1		

AUTOMOTIVE

FORMS/OFFICE SUPPLIES

GENERAL

DATA VOICE

PRODUCT IDENTIFIER		DESCRIPTION					
ITEM NUMBER	ORD. MULT.	SELL UNIT	STD. PKG. STOCK AVAILABILITY / PA	LEAD TIME	MIN. ORD.	A	C
996697330			HORN CK16301 L5				
N		EA	1	4	4		
An AC operated horn signal having an energy peak between 1500 and 3000 cycles per second. Maximum volume output is 105 DB, BSP 463-110-100.							

102276912			HOUSING 832A 60				
N		EA	1	3	1		

280080649			HOUSING WEATHERPROOF GB5955H				
1936708	1	EA	IL 04	IN 04	MI	OH	WI
Housing for outdoor application of wall mount single line telephone. Must be ordered with adapter frame GB 5955 LAF and set tel 2554. DISCONTINUE UPON STOCK DEPLETION							

100210251			INDICATOR 18C 49				
1184622	1	EA	IL 04	IN 04	MI	OH	WI
DISCONTINUE UPON STOCK DEPLETION							

103157160			INDICATOR 24B 16 50				
N		EA	1	4	1		

102640331			ISOLATOR 28A				
1133835	1	EA	IL 18	IN 18	MI 18	OH 18	WI
A solid state device used to extend ringing range and provide ringer isolation on party line service.							

102042496			JACK 616D				
1176974	1	EA	IL 04	IN 04	MI 04	OH 04	WI 04
DISCONTINUE, ORDER NON STOCK UPON STOCK DEPLETION							

101171205			KEY 412 A				
N		EA	1	2	1		

100284975			KEY 498 A				
N		EA	1	4	1		

100286491			KEY 547 B				
N		EA	1	2	1		

100287077			KEY 551 A 03 BLACK				
1192799	1	EA	IL 04	IN 04	MI 04	OH 04	WI 04
For controlling buzzers and bells in connection with low voltage signaling systems. Nonlocking push button key enclosed in a case of insulating material. Push button is white plastic, BSP 512-220-100.							

100287184			KEY 552 A				
N		EA	1	2	1		

100288646			KEY 622 A				
N		EA	1	2	1		

101879882			KEY 635 A5C				
2718866	1	EA	IL 04	IN 04	MI 04	OH 04	WI 04
Consists of six illuminated locking buttons topped with square caps for 5 pickups and 1 hold. Use on Set tel 630, BSP 502-603-100.							

TELEPHONE EQUIPMENT - MISCELLANEOUS

PRODUCT IDENTIFIER		DESCRIPTION				
ITEM NUMBER	ORD. MULT.	SELL UNIT	STD. PKG. STOCK AVAILABILITY / PA	LEAD TIME	MIN. ORD.	A C
101915569	N	KEY EA	635 1	AE5C 4	1	
101915593	N	KEY EA	635 1	AH5C 4	1	
102232923	N	KEY EA	635 1	BD5C 4	1	
102390127	N	KEY EA	635 1	BM5C 8	1	
101538775	2771287 1	KEY EA	647 1	A5 IL IN MI OH WI 04 04 04 04 04		
A 10 button key equipped with 9 clear buttons and one red hold button used for 10 and 20 button key sets, BSP 512-230-101.						
101538783	N	KEY EA	647 1	B5 2	1	
102419074	N	KEY EA	651 1	E 2	1	
102278967	N	KEY EA	652 1	A-05 SP 2	1	
101637346	1167189 1	KEY EA	656 1	A IL IN MI OH WI 04 04 04 04 04		
A six line pick-up key for use in call director 400 type key mountings and 6050 and 6051 keys. Replaces 598A key, BSP 512-230-100.						
101771319	1142356 1	KEY EA	657 1	A IL IN MI OH WI 04 04 04 04 04		
Designed primarily for use in call directors 400, 6050, 6051 Key Mountings interchangeable with 599 A Key, BSP 512-230-100.						
100290261	N	KEY EA	6026 1	B 2	1	
100290287	N	KEY EA	6026 1	D 2	1	
100304138	N	KEY EA	B1GU 1	2	1	
100304351	N	KEY EA	B1JC 1	2	1	
Used for dialing, talking and two-way ringing. BSP 032-703-801.						
100316645	1224535 1	LAMP EA	51A IL IN MI OH WI 31 31 31 31 31			
A tungsten filament lamp requiring a special socket. Used in various telephone set mountings. Intended for use with 700 and 701 type keys, BSP 032-501-901.						

PRODUCT IDENTIFIER		DESCRIPTION				
ITEM NUMBER	ORD. MULT.	SELL UNIT	STD. PKG. STOCK AVAILABILITY / PA	LEAD TIME	MIN. ORD.	A C
101420560	2654269 10	LAMP EA	51B IL IN MI OH WI 31 31 31 31 31			
A tungsten filament lamp requiring a special socket. Used in various telephone set mountings, BSP 032-501-901.						
100316652	1197608 10	LAMP EA	52A IL IN MI OH WI 31 31 31 31 31			
A tungsten filament lamp requiring a special socket. Used in various telephone set mountings. Intend for use with 700 and 701 type keys, BSP 032-501-901.						
100316660	1174375 10	LAMP EA	53A IL IN MI OH WI 31 31 31 31 31			
Initial use 635A1 key.						
100316678	1198689 1	LAMP EA	53B 6 VOLTS IL IN MI OH WI 31 31 31 31 31			
Lamp for illuminating the dial number plate on a trimline handset. Also used with 801A and 850A type telephone sets, BSP 503-320-400.						
997782297	1198549 1	LAMP EA	KS 19527 L1 IL IN MI OH WI 31 31 31 31 31			
Message waiting lamp, BSP 502-501-115.						
997623632	N	LAMP EA	MINIATURE 1847 GE 10		1 10	
A bayonet base lamp intended to be used on a 2A Answering Set.						
100317379	N	LAMP EA	RESISTANCE 14A 1		1 1	
260377890	1959858 1	MACHINE EA	ANSWER CODE-A-PHONE 7530 IL IN MI OH WI 04 04 04 04 04			
A direct replacement for the CK19245 L26 and CDPN 2540. Comes e/w two each 2 hr. tapes, 1 for record and one for transmit.						
103802088	N	MEMORY EA	2870C 1		5 1	
Memory and button field for 2870 type telephone set. Caution should be used when handling memory module, BSP 503-300-100.						
405501024	N	MULTIPLEXER EA	SPM 1945R-110 1		4 1	
804265353	N	P426535 ADAPTER EA	100		8 100	
260000112	1996587 1	PANEL EA	620A2 IL IN MI OH WI 04 04 04 04 04			
A modular panel e/w eight 913B Connectors, quick connect terminal field, and lamp/fuse block assembly, BSP 518-215-419.						

DISTRIBUTION SERVICES

NETWORK SERVICES

TOOLS

BUILDING JANITORIAL

AUTOMOTIVE

FORMS/OFFICE SUPPLIES

GENERAL

DATA VOICE

TELEPHONE EQUIPMENT - MISCELLANEOUS

DISTRIBUTION SERVICES

PRODUCT IDENTIFIER		DESCRIPTION					
ITEM NUMBER	ORD. MULT.	SELL UNIT	STD. PKG. STOCK AVAILABILITY / PA	LEAD TIME	MIN. ORD.	A C	
840597611		PANEL REAR RED					
N		EA	1	2	1		
225.00 set-up charge for quantities of less than 100 pieces							

NETWORK SERVICES

PRODUCT IDENTIFIER		DESCRIPTION					
ITEM NUMBER	ORD. MULT.	SELL UNIT	STD. PKG. STOCK AVAILABILITY / PA	LEAD TIME	MIN. ORD.	A C	
103015962		PLATE FACE 65A 50					
1166488	1	EA	IL 18	IN 18	MI 18	OH 18	WI 18
A universal bracket and face plate for mounting 625 F connecting block, 541A and 548A jacks and 47 type connecting block to 63B bracket and electrical outlet box, BSP 461-630-100.							

TOOLS

PRODUCT IDENTIFIER		DESCRIPTION					
ITEM NUMBER	ORD. MULT.	SELL UNIT	STD. PKG. STOCK AVAILABILITY / PA	LEAD TIME	MIN. ORD.	A C	
103111209		PLATE FACE 400A 50					
N		EA	1	4	1		
102598729		PLATE FACE 2830B 70					
1301390	1	EA	IL 04	IN 04	MI 04	OH 04	WI 04
For set tel 2830 A1M, charcoal, BSP 503-701-101. DISCONTINUE UPON STOCK DEPLETION							

BUILDING JANITORIAL

PRODUCT IDENTIFIER		DESCRIPTION					
ITEM NUMBER	ORD. MULT.	SELL UNIT	STD. PKG. STOCK AVAILABILITY / PA	LEAD TIME	MIN. ORD.	A C	
401259635		PLATE FACE SNAP PTS13					
N		EA	1	4	100		
102434057		PLUG 523A3					
N		EA	1000	6	1000		
Plug for wall telephone sets. Fits into base of wall type phones or adapter. Available with 3 or 4 conductors. BSP 503-100-100.							

AUTOMOTIVE

PRODUCT IDENTIFIER		DESCRIPTION					
ITEM NUMBER	ORD. MULT.	SELL UNIT	STD. PKG. STOCK AVAILABILITY / PA	LEAD TIME	MIN. ORD.	A C	
103941464		PLUG 700A4 MODULAR AT&T					
1193037	1	EA	IL 08	IN 08	MI 08	OH 08	WI 08
Four position modular plug that can be attached to 22 or 25 AWG solid wire cordage, D-Station, to provide modular connection, ivory in color.							

PRODUCT IDENTIFIER		DESCRIPTION					
ITEM NUMBER	ORD. MULT.	SELL UNIT	STD. PKG. STOCK AVAILABILITY / PA	LEAD TIME	MIN. ORD.	A C	
103941472		PLUG 700A8 MODULAR AT&T					
1936559	1	EA	IL 18	IN 18	MI 18	OH 18	WI 18

FORMS/OFFICE SUPPLIES

PRODUCT IDENTIFIER		DESCRIPTION					
ITEM NUMBER	ORD. MULT.	SELL UNIT	STD. PKG. STOCK AVAILABILITY / PA	LEAD TIME	MIN. ORD.	A C	
260354410		PLUG 135 OHM MODULAR TERMINAL					
1952440	1	EA	IL 04	IN 04	MI 04	OH 04	WI 04
8P MOD. for RJ48SJ.							

PRODUCT IDENTIFIER		DESCRIPTION					
ITEM NUMBER	ORD. MULT.	SELL UNIT	STD. PKG. STOCK AVAILABILITY / PA	LEAD TIME	MIN. ORD.	A C	
102389301		PLUG 523A 4 BULK P					
N		EA	1000	6	1000		

PRODUCT IDENTIFIER		DESCRIPTION					
ITEM NUMBER	ORD. MULT.	SELL UNIT	STD. PKG. STOCK AVAILABILITY / PA	LEAD TIME	MIN. ORD.	A C	
000246777		PLUG ASSEMBLY 4-WIRE					
N		PK	10	2	94		
Package of 10.							

GENERAL

PRODUCT IDENTIFIER		DESCRIPTION					
ITEM NUMBER	ORD. MULT.	SELL UNIT	STD. PKG. STOCK AVAILABILITY / PA	LEAD TIME	MIN. ORD.	A C	
260449632		PLUG MODULAR LINE CORD 5-641335-3					
N							
A 4 conductor, 6 position modular plug manufactured by AMP for use on the modular line cord that goes from the RJ11 jack to the phone.							

PRODUCT IDENTIFIER		DESCRIPTION					
ITEM NUMBER	ORD. MULT.	SELL UNIT	STD. PKG. STOCK AVAILABILITY / PA	LEAD TIME	MIN. ORD.	A C	
102872934		RINGER E1CM 49					
2803189	1	EA	IL 04	IN 04	MI 04	OH 04	WI 04
Used for modular princess family plan, 71382713, light olive gray.							

DATA VOICE

PRODUCT IDENTIFIER		DESCRIPTION					
ITEM NUMBER	ORD. MULT.	SELL UNIT	STD. PKG. STOCK AVAILABILITY / PA	LEAD TIME	MIN. ORD.	A C	
103117016		RINGER L1AMP49					
1119867	1	EA	IL 04	IN 04	MI 04	OH 04	WI 04
A high-impedance loud sounding signal designed for indoor or outdoor use. E/W two 3in gongs, requires a 181A backboard, BSP 501-258-101.							

PRODUCT IDENTIFIER		DESCRIPTION					
ITEM NUMBER	ORD. MULT.	SELL UNIT	STD. PKG. STOCK AVAILABILITY / PA	LEAD TIME	MIN. ORD.	A C	
260369004		RINGER W1C-246					
1955542	1	EA	IL 04	IN 04	MI 04	OH 04	WI 04

PRODUCT IDENTIFIER		DESCRIPTION					
ITEM NUMBER	ORD. MULT.	SELL UNIT	STD. PKG. STOCK AVAILABILITY / PA	LEAD TIME	MIN. ORD.	A C	
280000340		SET HAND 0200-00-20M					
N		EA	1	4	1		
Black.							

PRODUCT IDENTIFIER		DESCRIPTION					
ITEM NUMBER	ORD. MULT.	SELL UNIT	STD. PKG. STOCK AVAILABILITY / PA	LEAD TIME	MIN. ORD.	A C	
280000357		SET HAND 0220-09-20M					
N		EA	1	4	1		
Ivory.							

PRODUCT IDENTIFIER		DESCRIPTION					
ITEM NUMBER	ORD. MULT.	SELL UNIT	STD. PKG. STOCK AVAILABILITY / PA	LEAD TIME	MIN. ORD.	A C	
280000365		SET HAND 0220-13-20M					
N		EA	1	4	1		
Beige.							

PRODUCT IDENTIFIER		DESCRIPTION					
ITEM NUMBER	ORD. MULT.	SELL UNIT	STD. PKG. STOCK AVAILABILITY / PA	LEAD TIME	MIN. ORD.	A C	
280000415		SET HAND 2330-00-22M					
N		EA	1	4	1		
Black.							

PRODUCT IDENTIFIER		DESCRIPTION					
ITEM NUMBER	ORD. MULT.	SELL UNIT	STD. PKG. STOCK AVAILABILITY / PA	LEAD TIME	MIN. ORD.	A C	
280000423		SET HAND 2330-09-22M					
N		EA	1	4	1		
Ivory.							

PRODUCT IDENTIFIER		DESCRIPTION					
ITEM NUMBER	ORD. MULT.	SELL UNIT	STD. PKG. STOCK AVAILABILITY / PA	LEAD TIME	MIN. ORD.	A C	
280000431		SET HAND 2330-13-22M					
1929745	1	EA	IL 04	IN 04	MI 04	OH 04	WI 04
Beige.							

PRODUCT IDENTIFIER		DESCRIPTION					
ITEM NUMBER	ORD. MULT.	SELL UNIT	STD. PKG. STOCK AVAILABILITY / PA	LEAD TIME	MIN. ORD.	A C	
280028820		SET HAND 006500-OM2 MODULAR					
1922468	1	EA	IL 04	IN 04	MI 04	OH 04	WI 04
Ivory.							

PRODUCT IDENTIFIER		DESCRIPTION					
ITEM NUMBER	ORD. MULT.	SELL UNIT	STD. PKG. STOCK AVAILABILITY / PA	LEAD TIME	MIN. ORD.	A C	
280028804		SET HAND 006509-OC2 N/M 4IN CORD					
N		EA	1	4	1		
Ivory.							

PRODUCT IDENTIFIER		DESCRIPTION					
ITEM NUMBER	ORD. MULT.	SELL UNIT	STD. PKG. STOCK AVAILABILITY / PA	LEAD TIME	MIN. ORD.	A C	
280028838		SET HAND 006509-OM2 MODULAR					
N		EA	1	4	1		
Ivory.							

PRODUCT IDENTIFIER		DESCRIPTION					
ITEM NUMBER	ORD. MULT.	SELL UNIT	STD. PKG. STOCK AVAILABILITY / PA	LEAD TIME	MIN. ORD.	A C	
280028846		SET HAND 006513-OM2 MODULAR					
N		EA	1	4	1		
Beige.							

PRODUCT IDENTIFIER		DESCRIPTION					
ITEM NUMBER	ORD. MULT.	SELL UNIT	STD. PKG. STOCK AVAILABILITY / PA	LEAD TIME	MIN. ORD.	A C	
104221445		SET HAND G 6BM-03 BLACK W/PP					
1183434	1	EA	IL 04	IN 04	MI 04	OH 04	WI 04
For use with 500, 600 and 700 type telephone sets, by customers with impaired hearing. W/PP refers to, with proof of purchase, needed for warranty purposes, BSP 501-210-100.							

PRODUCT IDENTIFIER		DESCRIPTION					
ITEM NUMBER	ORD. MULT.	SELL UNIT	STD. PKG. STOCK AVAILABILITY / PA	LEAD TIME	MIN. ORD.	A C	
104126206		SET HAND G 6BM-50 IVORY W/PP					
1137778	1	EA	IL 04	IN 04	MI 04	OH 04	WI 04
For use with 500, 600 and 700 type telephone sets, by customers with impaired hearing. W/PP refers to, with proof of purchase, needed for warranty purposes, BSP 501-210-100.							

TELEPHONE EQUIPMENT - MISCELLANEOUS

PRODUCT IDENTIFIER								DESCRIPTION								
ITEM NUMBER	ORD. MULT.	SELL UNIT	STD. PKG. STOCK	PKG. AVAILABILITY	LEAD TIME / PA	MIN. ORD.	A C									
104221452		SET HAND G	6BM-51	GREEN	W/PP											
N		EA	1		1	1										
104221460		SET HAND G	6BM-56	YELLOW												
N		EA	1		6	1										
102725967		SET HAND G	6BM-58	WHITE												
1158550	1	EA	IL	IN	MI	OH	WI	04	04	04	04					
104221478		SET HAND G	6BM-60	BEIGE	W/PP											
1220830	1	EA	IL	IN	MI	OH	WI	04	04	04	04					
For use with 500, 600 and 700 type telephone sets, by customers with impaired hearing. W/PP refers to, with proof of purchase, needed for warranty purposes, BSP 501-210-100.																
102936952		SET HAND G	7BM60													
N		EA	1		3	1										
102936895		SET HAND G	7BM-50	IVORY												
N		EA	1		2	1										
102937059		SET HAND G	8BM-60	BEIGE												
N		EA	1		4	1										
101978443		SET HAND G15	A-03													
N		EA	1		3	1										
101978450		SET HAND G15	A-50	IVORY												
1191494	1	EA	IL	IN	MI	OH	WI	04	04	04	04					
101978518		SET HAND G15	A-60	BEIGE												
1144071	1	EA	IL	IN	MI	OH	WI	04	04	04	04					
Handset for use with modular telephones, to be used with H4DU handset cord, cord not included, BSP 503-100-100.																
103755534		SET HAND K	2D 50	IVORY												
1195891	1	EA	IL	IN	MI	OH	WI	04	04	04	04					
Handset for Touch-A-Matic and Design Line Telephones, BSP 503-200-XXX.																
103942611		SET LOUD SPEAKER	107B	03	BLACK											
N		EA	1		4	1										
Used with all telephone sets, designed to permit a small group of people to hear both sides of a telephone conversation.																
103873873		SET LOUD SPEAKER	108AA	03	ATTIS											
1230847	1	EA	IL	IN	MI	OH	WI	04	04	04	04					
Part of the 4A Speakerphone System. Contains relay and circuitry necessary to couple to the telephone system.																
103873881		SET LOUD SPEAKER	108AA	50	ATTIS											
1130252	1	EA	IL	IN	MI	OH	WI	04	04	04	04					
103873907		SET LOUD SPEAKER	108AA	60	BEIGE											
1108795	1	EA	IL	IN	MI	OH	WI	04	04	04	04					

PRODUCT IDENTIFIER								DESCRIPTION								
ITEM NUMBER	ORD. MULT.	SELL UNIT	STD. PKG. STOCK	PKG. AVAILABILITY	LEAD TIME / PA	MIN. ORD.	A C									
105753628		SPEAKERPHONE	732	TWO-LINE												
N		EA	3		2	3										
260417100		SPEAKERPHONE	AEC-40													
N		EA	1			1										
280038571		SPEAKERPHONE	COMPANION	IVS	BK											
N		EA	1		3	1										
102599354		TRANSFORMER	2012	D	49											
1191254	1	EA	IL	IN	MI	OH	WI	04	04	04	04					
Used to power such devices as control units for 3 type speakerphones, 115 volt, BSP 501-136-100.																
101379097		TRANSFORMER	2552	Y												
5343467	1	EA	IL	IN	MI	OH	WI	04								
100773456		TRANSFORMER	2616	A	CB											
N		EA	1		3	1										
280000738		TRANSFORMER	000031-00A	15-18	VOLTS											
N		EA	1		4	1										
T 60HZ 1.75VA																
280000746		TRANSFORMER	000031-101	6-8	VOLTS											
N		EA	1		4	1										
OH HZ 1.75VA																
280000753		TRANSFORMER	000041-101	9	VOLT	60										
N		EA	1		4	1										
HAX 1VA																
102600517		TRANSFORMER	2012	D5												
N		EA	1		4	1										
401348529		TRANSMITTER	CK16664	L3	03	BLACK										
1205054	1	EA	IL	IN	MI	OH	WI	04	04	04	04					
Noise cancelling, CONFIDENCER. Used to cancel background noise during telephone conversations, BSP 501-230-100.																
103225017		UNIT POWER	19	B	4											
N		EA	1		2	1										
103232773		UNIT POWER	28	D	2											
N		EA	1		5	1										
103225132		UNIT POWER	29	B	2											
N		EA	1		13	1										
Wall mounting.																
103225140		UNIT POWER	29	C	2											
N		EA	1		6	1										
103225181		UNIT POWER	30	B	2											
N		EA	1		2	1										
Used when IA2 key equipment is required. NOTE: Do not use when IA1 or other type equipment is used, BSP 167-446-101, BSP 167-447-100.																

DISTRIBUTION SERVICES

NETWORK SERVICES

TOOLS

BUILDING JANITORIAL

AUTOMOTIVE

FORMS/OFFICE SUPPLIES

GENERAL

DATA VOICE

TELEPHONE EQUIPMENT - MISCELLANEOUS

DISTRIBUTION SERVICES

PRODUCT IDENTIFIER		DESCRIPTION					
ITEM NUMBER	ORD. MULT.	SELL UNIT	STD. PKG. STOCK AVAILABILITY / PA	LEAD TIME	MIN. ORD.	A	C
103232815		UNIT POWER	67 B 2				
N		EA	1	17	1		

NETWORK SERVICES

PRODUCT IDENTIFIER		DESCRIPTION					
ITEM NUMBER	ORD. MULT.	SELL UNIT	STD. PKG. STOCK AVAILABILITY / PA	LEAD TIME	MIN. ORD.	A	C
103225231		UNIT POWER	79 B 5				
1197517	1	EA	IL IN MI OH WI 04 04 04 04 04				
For use with modular key systems. Used with 620A panels, BSP 518-215-419.							
102139938		UNIT POWER	85 B 1				
1149724	1	EA	IL IN MI OH WI 04 04 04 04 04				
Power supply for a 4A speakerphone system, BSP 512-700-100.							

TOOLS

103051462		UNIT POWER	284 B 1				
N		EA	1	14	1		
103824942		UNIT POWER	484 A A				
N		EA	1	2	1		

BUILDING JANITORIAL

PRODUCT IDENTIFIER		DESCRIPTION					
ITEM NUMBER	ORD. MULT.	SELL UNIT	STD. PKG. STOCK AVAILABILITY / PA	LEAD TIME	MIN. ORD.	A	C
103314324		UNIT RECEIVER	U3-U5 0388				
1111716	1	EA	IL IN MI OH WI 59 59 59 59 59				
002056489		UNIT TELEPHONE KEY	RT1900				
N		EA	1	4	1		
A 19 code single path intercom utilizing a combination of touch tone and rotary dial telephone sets.							

AUTOMOTIVE

100830298		WEIGHT CORD	119				
N		EA	5	13	5		

FORMS/OFFICE SUPPLIES

TELEPHONE SYSTEM - CENTRAMAX							
ITEM NUMBER	ORD. MULT.	SELL UNIT	STD. PKG. STOCK AVAILABILITY / PA	LEAD TIME	MIN. ORD.	A	C
402086250		ADAPTER EAST-1B					
N		EA	1	4	1		
260392550		CABINET BUD C	42801045				
N		EA	1	4	1		
260392600		CARD DIAL TONE	25608048				
N		EA	1	4	1		
260392584		CARD EXPANDER	25608060				
N		EA	1	4	1		
260419494		CARD INTERFACE	KFC 25608033				
N		EA	1	4	1		
260419502		CARD INTERFACE SHELF	22608055				
N		EA	1	4	1		
260419510		CARD INTERFACE SHELF	24608604				
N		EA	1	4	1		
260303946		CARD INTERRUPTER	P/N 25608047				
N		EA	1	4	1		
260403688		CARD RING BIT DELAY	25608063				
N		EA	1	4	1		

GENERAL

DATA VOICE

PRODUCT IDENTIFIER		DESCRIPTION					
ITEM NUMBER	ORD. MULT.	SELL UNIT	STD. PKG. STOCK AVAILABILITY / PA	LEAD TIME	MIN. ORD.	A	C
260303953		CARD STATION CONTROLLER	8 LINE				
N		EA	1	4	1		
P/N 25608061.							
260392634		CONNECTOR RIBBON	29608001 CENTRAMAX				
N		EA	1	4	1		
2 CARD.							
260392642		CONNECTOR RIBBON	29608001 CENTRAMAX				
N		EA	1	4	1		
3 CARD.							
260392659		CONNECTOR RIBBON	29608001 CENTRAMAX				
N		EA	1	4	1		
4 CARD.							
260419452		KIT WALL MOUNT	24608605				
N		EA	1	4	1		
260392675		KIT WIRING CONT CABLE SHELF	24608601				
N		EA	1	4	1		
260392683		KIT WIRING LINE CABLE SHELF	24608603				
N		EA	1	4	1		
260392568		MODULE ADD-ON	06089				
N		EA	1	4	1		
260419486		OVERLAY CLEAR	44608605				
N		EA	1	4	1		
260392691		PACK POWER	18 VOLT 23306037				
N		EA	1	4	1		
260419460		SET HAND ASSEMBLY	51608608				
N		EA	1	4	1		
260392543		SET TELEPHONE	21608605				
N		EA	1	4	1		
260392592		SHELF CONTROLLER CARD	22608014				
N		EA	1	4	1		
260392626		SHELF LINE CARD	22608013				
N		EA	1	4	1		
260392667		SUPPLY POWER TUC	23303113				
N		EA	1	4	1		
260419478		UNDERLAY PAPER	GRAY 44608601				
N		EA	1	4	1		

TELEPHONE SYSTEM DAVID							
ITEM NUMBER	ORD. MULT.	SELL UNIT	STD. PKG. STOCK AVAILABILITY / PA	LEAD TIME	MIN. ORD.	A	C
260416599		ADAPTER DAVID	ADA WITH POWER 8602-01				
1972752	1	EA					
260416698		ADAPTER DAVID	DADA WITH POWER 8601-08				
1972760	1	EA	IL IN MI OH WI 04				

TELEPHONE SYSTEM EMERGENCY - 911

PRODUCT IDENTIFIER							DESCRIPTION						
ITEM	ORD.	SELL	STD. PKG.	LEAD TIME	MIN.	A	ITEM	ORD.	SELL	STD. PKG.	LEAD TIME	MIN.	A
NUMBER	MULT.	UNIT	STOCK AVAILABILITY / PA		ORD.	C	NUMBER	MULT.	UNIT	STOCK AVAILABILITY / PA		ORD.	C

260416391 SET TELEPHONE DAVID EXECUTIVE DISPLAY
 1972737 1 EA IL IN MI OH WI
 04 04
 DS8703-00, provides Centrex users a digital feature phone with multiline capabilities, 8 configurable buttons, built-in speakerphone, uses twisted pair telephone wire.

260416490 SET TELEPHONE DAVID PREMIER DISPLAY
 1972745 1 EA IL IN MI OH WI
 04 04
 DS8735-00, provides Centrex users a digital feature phone with multiline capabilities, 35 configurable buttons, built-in speakerphone, uses twisted pair telephone wire.

260416292 SET TELEPHONE DAVID STANDARD PLUS
 1972729 1 EA IL IN MI OH WI
 04 04
 DS8701-00, provides Centrex users a digital feature phone with multiline capabilities, 8 configurable buttons, built-in speakerphone, uses twisted pair telephone wire.

TELEPHONE SYSTEM EMERGENCY - 911

405892670 E-911 CABINET SMALL NJ03510J-1 L7
 N EA 1 10 1

260382114 E-911 CABLE NJ03510J-1 L15
 1961508 1 EA IL IN MI OH WI
 04
 E-911 support call stalker, EPIC 1A2 ANI2 system, trunk shelf, public safety answering point.

260381975 E-911 CABLE NJ03510K-1 L15
 1961193 1 EA IL IN MI OH WI
 18
 E-911 ANI2/VX system, public safety answering point. Trunk shelf cable.

405876285 E-911 CARD EXPANSION I/O NJ03510J-1 L3
 N EA 1 10 1

260382122 E-911 CARD EXPANSION I/O NJ03510J-1 L3
 1961334 1 EA IL IN MI OH WI
 04
 I/O expansion card for E-911 ANI2/1A2 key equipment.

260382130 E-911 CARD I/O NJ03510K-1 L3 VX
 1961342 1 EA IL IN MI OH WI
 04
 VX I/O expansion card for E-911 ANI2/VX.

405876269 E-911 CARD TRUNK NJ03510J-1 L4
 N EA 1 10 1

405892621 E-911 CONNECTOR RIBBON NJ03510J-1 L15
 N EA 1 10 1
 20 PIN. Spare.

601239528 E-911 DISPLAY ALI S/A NJ00514A1 L1
 N EA 1 12 1

PRODUCT IDENTIFIER							DESCRIPTION						
ITEM	ORD.	SELL	STD. PKG.	LEAD TIME	MIN.	A	ITEM	ORD.	SELL	STD. PKG.	LEAD TIME	MIN.	A
NUMBER	MULT.	UNIT	STOCK AVAILABILITY / PA		ORD.	C	NUMBER	MULT.	UNIT	STOCK AVAILABILITY / PA		ORD.	C

405876244 E-911 DISPLAY ANI NJ03510J-1 L5
 N EA 1 10 1

260381918 E-911 DISPLAY INFORMER M 911
 N EA 1 8 1
 E-911 support ALI display, table top, green 6in screen, informer # 99965-007.

260381892 E-911 DISPLAY INFORMER RACKMOUNT 911
 N EA 1 8 1
 E-911 support ALI display, rack mounted, green 6in screen, informer # 99965-008.

260381934 E-911 DISPLAY NJ00514A-1 L4 SPECIAL
 1961151 1 EA IL IN MI OH WI
 04
 E-911 support ALI display, flushmount, special order mounted on right side.

260382056 E-911 DISPLAY NJ03510J-1 L5
 1961276 1 EA IL IN MI OH WI
 04
 E-911 ANI2/1AZ system, public safety answering point.

260382031 E-911 DISPLAY NJ03510K-1 L5
 1961250 1 EA IL IN MI OH WI
 04
 E-911 ANI2/VX system, public safety answering point.

260302955 E-911 DISPLAY TABLE ALI NJ00514A1L1A
 1939975 1 EA IL IN MI OH WI
 04
 Used with the enhanced E911 Emergency Reporting System.

405654377 E-911 GENERATOR RING NJ06510J-1 L6
 N EA 1 10 1

601280324 E-911 MULTIPLEXER NJ03510H-1 L1E ALI II
 N EA 1 10 1

260303011 E-911 PACK CIRCUIT ADESM001
 1940007 1 EA IL IN MI OH WI
 18 18
 Used with the enhanced E911 Emergency Reporting System.

260303201 E-911 PACK CIRCUIT LC 78B
 1939736 1 EA IL IN MI OH WI
 18
 Used with the Enhanced E911 Emergency Reporting System.

103666236 E-911 PACK CIRCUIT LC 103B
 N EA 1 8 1
 Inspection required.

103232161 E-911 PACK CIRCUIT LC 169B
 N EA 1 23 1

103231403 E-911 PACK CIRCUIT LC 255B
 1939843 1 EA IL IN MI OH WI
 18 18
 Used with the Enhanced E911 Emergency Reporting System.

DISTRIBUTION SERVICES

NETWORK SERVICES

TOOLS

BUILDING JANITORIAL

AUTOMOTIVE

FORMS/OFFICE SUPPLIES

GENERAL

DATA VOICE

TELEPHONE SYSTEM EMERGENCY - 911

DISTRIBUTION SERVICES
 NETWORK SERVICES
 TOOLS
 BUILDING JANITORIAL
 AUTOMOTIVE
 FORMS/OFFICE SUPPLIES
 GENERAL
 DATA VOICE

PRODUCT IDENTIFIER		DESCRIPTION						
ITEM NUMBER	ORD. MULT.	SELL UNIT	STD. PKG. STOCK AVAILABILITY / PA	LEAD TIME		MIN. ORD.	A C	
103231411 E-911 PACK CIRCUIT LC 256B								
1970889	1	EA	IL IN MI OH WI	18	18			
Used with the Enhanced E911 Emergency Reporting System.								
102988888 E-911 PACK CIRCUIT LC 257								
1939868	1	EA	IL IN MI OH WI	18	18	18		
Used with the Enhanced E911 Emergency Reporting System.								
103231429 E-911 PACK CIRCUIT LC 258B								
1939876	1	EA	IL IN MI OH WI	18	18			
Used with the Enhanced E911 Emergency Reporting System.								
260391321 E-911 PACK CIRCUIT LC 265B								
1965939	1	EA	IL IN MI OH WI	18	18			
103230876 E-911 PACK CIRCUIT LC 267								
1939934	1	EA	IL IN MI OH WI	18	18			
Used with the Enhanced E911 Emergency Reporting System.								
260432620 E-911 PACK CIRCUIT MC2P0								
N								
103205209 E-911 PACK CIRCUIT RT 5B								
N		EA	1	13		1		
103800116 E-911 PACK CIRCUIT TC 6								
N		EA	1	13		1		
260382049 E-911 PACK TRUNK NJ03510J-1 L4								
1961268	1	EA	IL IN MI OH WI	04				
E-911 ANI2/1AZ system, public safety answering point.								
260382023 E-911 PACK TRUNK NJ03510K-1 L4								
1961243	1	EA	IL IN MI OH WI	18				
E-911 ANI2/VX system, public safety answering point.								
260382015 E-911 PROCESSOR UNIT NJ03510K-1 L10								
1961235	1	EA	IL IN MI OH WI	04				
E-911 ANI2/VX system, public safety answering point. Central processor unit.								
102995891 E-911 SELECTOR CONSOLE 10A150								
1939777	1	EA	IL IN MI OH WI	09	09			
Used with the E911 Emergency Reporting System.								
405373416 E-911 SENSOR OFF-HOOK NJ03510L-1 L74								
N		EA	1	8		1		

PRODUCT IDENTIFIER		DESCRIPTION						
ITEM NUMBER	ORD. MULT.	SELL UNIT	STD. PKG. STOCK AVAILABILITY / PA	LEAD TIME		MIN. ORD.	A C	
260381868 E-911 SET HAND NJ03510L-1 L26								
1961086	1	EA	IL IN MI OH WI	04				
EMERGENCY-911 support VIAX telephone system/backroom and line interface equipment.								
260381850 E-911 SET TEL 30/ 30 NJ03510L-1 L 1								
1961078	1	EA	IL IN MI OH WI	04				
E-911 support VIAX telephone system/backroom and line interface equipment. 30 line/30 button.								
260381876 E-911 SET TEL 90/120 NJ03510L-1 L18								
1961094	1	EA	IL IN MI OH WI	04				
90 line/120 button.								
260381884 E-911 SET TEL 90/120 NJ03510M-1 L18								
1961102	1	EA	IL IN MI OH WI	04				
90 line/120 button, DPLX.								
405876210 E-911 SHELF CPU SPARE NJ03510J-1 L11								
N		EA	1	10		1		
260382072 E-911 SHELF PROCESSOR NJ03510J-1 L11								
1961292	1	EA	IL IN MI OH WI	04				
EMERGENCY-911 ANI2/1AZ system, CP shelf, public safety answering point.								
260381991 E-911 SHELF PROCESSOR NJ03510K-1 L11								
1961219	1	EA	IL IN MI OH WI	04				
EMERGENCY-911 ANI2/VX system, public safety answering point. Central processor shelf.								
260382080 E-911 SHELF TRUNK NJ03510J-1 L2								
1961300	1	EA	IL IN MI OH WI	04				
EMERGENCY-911 ANI2/1AZ system, public safety answering point.								
405876343 E-911 SHELF TRUNK NJ03510J-1 L2								
N		EA	1	10		1		
260382007 E-911 SHELF TRUNK NJ03510K-1 L2								
1961227	1	EA	IL IN MI OH WI	04				
EMERGENCY-911 ANI2/VX system, public safety answering point.								
601312903 E-911 SOFTWARE NJ03510H-1 L MAR								
N		EA	1	10		1		
ALI/MUX II.								
260302971 E-911 SUPPLY POWER ALI MUX								
N		EA	1	17		1		
Used with the enhanced E911 Emergency Reporting System.								
260382098 E-911 SUPPLY POWER NJ03510J-1 L13								
1961318	1	EA	IL IN MI OH WI	04				
E-911 support call stalker, EPIC 1A2 ANI2 system, -48V DC, public safety answering point.								

PRODUCT IDENTIFIER		DESCRIPTION					
ITEM NUMBER	ORD. MULT.	SELL UNIT	STD. PKG. STOCK AVAILABILITY / PA	LEAD TIME	MIN. ORD.	A C	
405892654	E-911	N	SUPPLY POWER NJ03510J-1 L13	-48V	1	10	1
405892662	E-911	N	SUPPLY POWER NJ03510J-1 L14	ANI DISPLAY. Spare.	1	10	1
260382106	E-911	1961326	SUPPLY POWER NJ03510J-1 L14	IL IN MI OH WI 04	1		
E-911 support call stalker, EPIC 1A2 ANI2 system, public safety answering point.							
260381983	E-911	1961201	SUPPLY POWER NJ03510K-1 L13	IL IN MI OH WI 04	1		
E-911 ANI2/VX system, 48V DC, public safety answering point.							
260381967	E-911	1961185	SUPPLY POWER NJ03510K-1 L14	IL IN MI OH WI 04	1		
E-911 ANI2/VX system, public safety answering point.							
406402875	E-911	N	SUPPLY POWER NJ03510N-1 L16	UNINTRPL 1-KUA.	1	10	1
405876376	E-911	N	SYSTEM BASE 1A2 NJ03510J-1 L1		1	10	1
260381942	E-911	1961169	UNIT ALI MUX2 NJ03510-H L1	IL IN MI OH WI 04	1		
E-911 support ALI Multiplexor II. 1-15 position.							
260381843	E-911	1961060	UNIT LINE CARD NJ03510L L-57 CO	IL IN MI OH WI 04	1		
E-911 support VIAX telephone system/backroom and line interface equipment.							
260381835	E-911	1961052	UNIT LINE INTER NJ03510L-1 L56	IL IN MI OH WI	1		
260382064	E-911	1961284	UNIT PROCESSOR NJ03510J L10	IL IN MI OH WI 04	1		
E-911 ANI2/1AZ system, CPU, public safety answering point.							
260381959	E-911	1961177	UNIT W/EXPANSION NJ03510 L2	IL IN MI OH WI 04	1		
E-911 support ALI Multiplexor II. 1-45 position.							

TELEPHONE SYSTEM NORSTAR

260449244	BAR POWER A0349107	N	Used to power the modular peripheral equipment. Each outlet powers up to 2 modules.
-----------	--------------------	---	---

PRODUCT IDENTIFIER		DESCRIPTION					
ITEM NUMBER	ORD. MULT.	SELL UNIT	STD. PKG. STOCK AVAILABILITY / PA	LEAD TIME	MIN. ORD.	A C	
260449145	CABINET KSU 8X24 A0365885	N	For the Northern Telecom Norstar telephones. This is a key service unit cabinet that supports up to 8 CO lines & 24 digital station telephone sets.				
260449178	CARTRIDGE 2 PORT EXPANSION A0338794	N	Northern Telecom Norstar System. For use with the 8X24 System. Allows the addition of 2 trunk or station modules.				
260449186	CARTRIDGE 6 PORT EXPANSION A0338796	N	Northern Telecom Norstar System. For use with the 8X24 System. Allows the addition of 6 trunk or station modules.				
260449236	CARTRIDGE TRUNK A0366477	N	Installed into a trunk module to allow up to 4 new CO lines. With the 8X24 KSU and DR 3 Software, will provide disconnect supervision to CO lines (8X24 System).				
260449228	MODULE STATION A0338808	N	Installed in conjunction with the 2 or 6 port expansion cartridge. Allows the addition of up to 16 station sets (for use in the 8x24 system only).				
260420401	SET TELEPHONE M7310 A033 GRAY	N	Northern Telecom Norstar telephone.				
260412176	SET TELEPHONE M7310 A0338816 ASH	1983718	EA IL IN MI OH WI 1				
Northern Telecom Norstar System. Feature set has 2-line LED with 3 soft keys, programmable speakerphone, 10 programmable buttons which allow up to 8 line appearances, add.24 programmable feature btn.							
260428685	SET TELEPHONE M7310 A0338998 BLACK	1978080	1 EA IL IN MI OH WI 04				
260412168	SET TELEPHONE M7324 A0338825 ASH	1983700	EA IL IN MI OH WI 1				
Northern Telecom Norstar System telephone. Expanded version has 2-line LED with 3 soft keys, programmable speakerphone, 24 programmable keys which allow up to 20 line appearances.							
260428677	SET TELEPHONE M7324 A0339006 BLACK	1978098	EA IL IN MI OH WI 1 04				
Northern Telecom ISDN telephone.							
260449152	SOFTWARE DR2 MODULAR A0359274	N	Northern Telecom software for Norstar Telephone System. Features system speed dial, delayed ring transfer, automatic set relocation, call park, & flexible night service as main features.				

DISTRIBUTION SERVICES

NETWORK SERVICES

TOOLS

BUILDING JANITORIAL

AUTOMOTIVE

FORMS/OFFICE SUPPLIES

GENERAL

DATA VOICE

TELEPHONE SYSTEM NORSTAR

DISTRIBUTION SERVICES

PRODUCT IDENTIFIER		DESCRIPTION					
ITEM NUMBER	ORD. MULT.	SELL UNIT	STD. PKG. STOCK AVAILABILITY / PA	LEAD TIME	MIN. ORD.	A C	

260449160 SOFTWARE DR3 MODULAR A0372031

N

Northern Telecom software for the Norstar Telephone System. Main features are line supervision, call forward on busy, enhanced central answering position functions & enhanced night service.

NETWORK SERVICES

TELEPHONE SYSTEM PAGING/HARRIS

260426978 PAGING - BARS SUPPORT P/N22210-000

N

EA 1 1 1
For Master Access Card.

260426929 PAGING - CARD C APPLIQUE P/N22082-008

N

EA 1 1 1

260427018 PAGING - CARD FM TUNER P/N22083-001

N

EA 1 1 1

260427026 PAGING - CARD MASTER ZONE P/N22081-000

N

EA 1 1 1

260426994 PAGING - CARD TALKBACK P/N22080-003

N

EA 1 1 1

260426937 PAGING - CARD TYPE 1 AUX P/N22081-001

N

EA 1 1 1

260426887 PAGING - CARD TYPE 2 AUX P/N22081-002

N

EA 1 1 1

260426895 PAGING - CARD TYPE 3 AUX P/N22081-003

N

EA 1 2 1

260426903 PAGING - CARD TYPE 4 AUX P/N22081-005

N

EA 1 1 1

260427067 PAGING - HORN 70V 4/15 WATT P/N22001-003

N

EA 1 1 1

300028743 PAGING - ORN CFID 15T TALK BACK

N

EA 1 2 1

260426952 PAGING - PAGEPAC 50 P/N22073-001

N

EA 1 1 1

260426960 PAGING - PAGEPAC 100 P/N22074-000

N

EA 1 1 1

260426911 PAGING - PAGEPAC 200 P/N22075-000

N

EA 1 1 1

260426945 PAGING - PAGEPAC VS P/N22070-001

N

EA 1 1 1

260427034 PAGING - SPEAKER CEILING P/N22016-163

N

EA 1 1 1
Round recessed.

260427042 PAGING - SPEAKER UNIVERSAL WALL

N

EA 1 1 1
P/N 22016-052.

TOOLS

BUILDING JANITORIAL

AUTOMOTIVE

FORMS/OFFICE SUPPLIES

GENERAL

DATA VOICE

PRODUCT IDENTIFIER		DESCRIPTION					
ITEM NUMBER	ORD. MULT.	SELL UNIT	STD. PKG. STOCK AVAILABILITY / PA	LEAD TIME	MIN. ORD.	A C	

260426986 PAGING - WIRE SPEAKER P/N22400-003

N

EA 1 1 1

TERMINAL

260425103 APPERTUS/LEE DATA TERMINAL SYNCH 1179

N

EA 1 1

260425111 APPERTUS/LEE DATA TERMINAL SYNCH 2134

N

EA 1 1

260427372 AT&T/NCR TERMINAL ASYNCHRONOUS CC 501006

N

EA 1 1
AT&T Model 615MT Green.

260427380 AT&T/NCR TERMINAL ASYNCHRONOUS CC 501007

N

EA 1 1
AT&T Model 615MT Amber.

260427364 AT&T/NCR TERMINAL ASYNCHRONOUS CC 501009

N

EA 1 4 1
AT&T Model 615CMT.

260427398 AT&T/NCR TERMINAL ASYNCHRONOUS CC 501013

N

EA 1 1
AT&T Model 705MT Green.

260427406 AT&T/NCR TERMINAL ASYNCHRONOUS CC 501013

N

EA 1 1
AT&T Model 705MT Amber.

260432836 AT&T/NCR TERMINAL W/ KEYBD 710-MT

N

EA 1 2 1
2960-1301-7100 White.

260432810 AT&T/NCR TERMINAL W/KEYBD 710-MT

N

EA 1 2 1
2960-8000-7100 Amber.

260432828 AT&T/NCR TERMINAL W/O KEYBD 710-MT

N

EA 1 2 1
1064634330 Amber.

260432844 AT&T/NCR TERMINAL W/O KEYBD 710-MT

N

EA 1 2 1
1064634660 White.

260434600 IBM TERMINAL 3472-HC1 W/STAND & KEYBOARD

N

EA 1 4 1
Color Terminal Display Station with F/N5801 Stand & F/N 9122 Keyboard, all packaged in one carton.

280079328 IBM TERMINAL MULTIPLEXER 3299-002

1935817 1 EA IL IN MI OH WI
01 01 01

TERMINAL X-TYPE OPTIONS AND COMPONENTS

PRODUCT IDENTIFIER DESCRIPTION

ITEM NUMBER	ORD. MULT.	SELL UNIT	STD. PKG. STOCK AVAILABILITY / PA	LEAD TIME	MIN. ORD.	A C
-------------	------------	-----------	-----------------------------------	-----------	-----------	-----

260425095 IBM TERMINAL SYNCHRONOUS MODEL 3194-QDO

N		EA	1		1	
---	--	----	---	--	---	--

260304100 LIBERTY TERMINAL ASSEMBLY 1-2-111519

1940650	1	EA	IL 04	IN 04	MI 04	OH 04	WI 04
---------	---	----	-------	-------	-------	-------	-------

Liberty Freedom I, turbo, amber. Keyboard is ordered separately (260304092).

260425079 MEMOREX/TELEX-STP TERMINAL SYNCH 6520

N		EA	1		1	
---	--	----	---	--	---	--

260406921 TERMINAL 6471F AMBER #64106070345

N		EA	1	4	1	
---	--	----	---	---	---	--

300073111 WYSE ASCII TERMINAL DISPLAY 50

1136051	1	EA	IL 04	IN 04	MI 04	OH 04	WI 04
---------	---	----	-------	-------	-------	-------	-------

Alpha numeric display terminal for use with computer system.

260318290 WYSE TERMINAL CRT 85 AMBER M/D NO REPLAC

N		EA	1	13	1	
---	--	----	---	----	---	--

With word processing, keyboard gold.

260411350 WYSE TERMINAL DISPLAY 185A

1971242	1	EA	IL 03	IN 03	MI 03	OH 03	WI 03
---------	---	----	-------	-------	-------	-------	-------

Amber, standard keyboard. REPLACES PID 260392188

300088663 WYSE TERMINAL DISPLAY 85

1920470	1	EA	IL 03	IN 03	MI 03	OH 03	WI 03
---------	---	----	-------	-------	-------	-------	-------

REPLACED BY PID 260411350, TERMINAL DISPLAY WYSE 185A

TERMINAL X-TYPE OPTIONS AND COMPONENTS

260438494 NCR X-TERMINAL 14IN COLOR CONFIG 1

N		EA	1	4	1	
---	--	----	---	---	---	--

Consists of: 1 XL14ME W/Lanboot & 8MB(# 3414-4610-7182), 1 Display(# 3415-1001-7190), 1 Keyboard U.S. English(3413-K440-0000) and 2 Power Cords U.S.(1249-C001-0030).

260438502 NCR X-TERMINAL 14IN COLOR CONFIG 2

N		EA	1	4	1	
---	--	----	---	---	---	--

Consists of: 1 XL14CE W/Enhanced Prom & 8MB(# 3414-4710-7182), 1 Display(# 3415-1001-7190), 1 Keyboard U.S. English(3413-K440-0000) and 2 Power Cords U.S.(1249-C001-0030).

260438452 NCR X-TERMINAL 15IN MONO CONFIGURATION 1

N		EA	1	4	1	
---	--	----	---	---	---	--

Consists of: 1 XL15ME W/Lanboot & 4MB(# 3413-1101-7182), 1 Display(# 3415-0101-7190), 1 Keyboard U.S. English(3413-K440-0000) and 2 Power Cords U.S.(1249-C001-0030).

PRODUCT IDENTIFIER DESCRIPTION

ITEM NUMBER	ORD. MULT.	SELL UNIT	STD. PKG. STOCK AVAILABILITY / PA	LEAD TIME	MIN. ORD.	A C
-------------	------------	-----------	-----------------------------------	-----------	-----------	-----

260438460 NCR X-TERMINAL 15IN MONO CONFIGURATION 2

N		EA	1	4	1	
---	--	----	---	---	---	--

Consists of: 1 XL15ME W/Enhanced Prom & 4MB(# 3413-1801-7182), 1 Display(# 3415-0101-7190), 1 Keyboard U.S. English(3413-K440-0000) and 2 Power Cords U.S.(1249-C001-0030).

260438510 NCR X-TERMINAL 17IN COLOR CONFIG 1

N		EA	1	4	1	
---	--	----	---	---	---	--

Consists of: 1 XL17CE W/Lanboot & 8MB(# 3414-4615-7182), 1 Display(# 3415-1501-7190), 1 Keyboard U.S. English(3413-K440-0000) and 2 Power Cords U.S.(1249-C001-0030).

260438528 NCR X-TERMINAL 17IN COLOR CONFIG 2

N		EA	1	4	1	
---	--	----	---	---	---	--

Consists of: 1 XL17CE W/Enhanced Prom & 8MB(# 3414-4715-7182), 1 Display(# 3415-1501-7190), 1 Keyboard U.S. English(3413-K440-0000) and 2 Power Cords U.S.(1249-C001-0030).

260438478 NCR X-TERMINAL 19IN MONO CONFIGURATION 1

N		EA	1	4	1	
---	--	----	---	---	---	--

Consists of: 1 XL19ME W/Lanboot & 4MB(# 3413-1122-7182), 1 Display(# 3415-2201-7190), 1 Keyboard U.S. English(3413-K440-0000) and 2 Power Cords U.S.(1249-C001-0030).

260438486 NCR X-TERMINAL 19IN MONO CONFIGURATION 2

N		EA	1	4	1	
---	--	----	---	---	---	--

Consists of: 1 XL19ME W/Enhanced Prom & 4MB(# 3413-1822-7182), 1 Display(# 3415-2201-7190), 1 Keyboard U.S. English(3413-K440-0000) and 2 Power Cords U.S.(1249-C001-0030).

DISTRIBUTION SERVICES

NETWORK SERVICES

TOOLS

BUILDING JANITORIAL

AUTOMOTIVE

FORMS/OFFICE SUPPLIES

GENERAL

DATA VOICE

NOTES