

MX•COM, INC. MiXed Signal ICs

DATA BULLETIN

MX929B

4-Level FSK Modem Data Pump

PRELIMINARY INFORMATION

Features

- 4-Level Root Raised Cosine FSK Modulation
- Half Duplex, 4800 to 19.2kbps
- Increase Channel Bit Rate/Hz
- Full Data Packet Framing
- Impulse and NRZ Signal Modes
- Enhanced Performance in Noisy Conditions
- Error Detection and Error Correction
- Low Power 3.3V/5.0V Operation

Applications

- RD-LAP™ Systems
- RCR STD-47 Systems
- Two Way Paging Systems
- Mobile Data Systems
- Wireless Telemetry
- DataTAC™ Terminals
- Portable Wireless Data Equipment

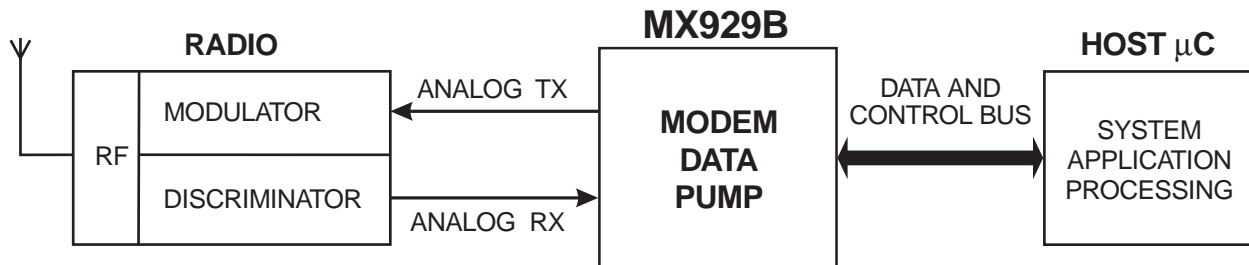

The MX929B is a low voltage CMOS device containing all of the baseband signal processing and Medium Access Control (MAC) protocol functions required for a high performance 4-level FSK Wireless Packet Data Modem. It interfaces with the modem host μ C and the radio modulation/demodulation circuits to deliver reliable two-way transfer of the application data over a wireless link.

The MX929B assembles application data received from the host μ C, adds forward error correction (FEC) and error detection (CRC) information, and interleaves the result for burst-error protection. After automatically adding symbol and frame sync codewords, the data packet is converted into filtered 4-level analog signals for modulating the radio transmitter.

In receive mode, the MX929B performs the reverse function using the analog signals from the receiver discriminator. After error correction and removal of the packet overhead, the recovered application data is supplied to the host μ C. CRC detected residual uncorrected data errors will be flagged. Readout of the SNR value during receipt of a packet is also provided.

The MX929B uses data block sizes and FEC/CRC Algorithms that are compatible with RD-LAP™ and RCR STD-47 over-air-standards. The device is programmable to operate at standard bit rates from a wide range of Xtal/clock frequencies.

The MX929B may be used with a 3.0V to 5.5V power supply and is available in the following package styles: 24-pin SSOP (MX929BDS), 24-pin SOIC (MX929BDW), and 24-pin PDIP (MX929BP).

CONTENTS

Section	Page
1 Block Diagram	6
2 Signal List	7
3 External Components	8
4 General Description	9
4.1 Description of Blocks	9
4.1.1 Data Bus Buffers.....	9
4.1.2 Address and R/W Decode	9
4.1.3 Status and Data Quality Registers	9
4.1.4 Command, Mode, and Control Registers.....	9
4.1.5 Data Buffer.....	9
4.1.6 CRC Generator/Checker.....	9
4.1.7 FEC Generator/Checker	9
4.1.8 Interleave/De-Interleave Buffer	10
4.1.9 Frame Sync Detect	10
4.1.10 Rx Input Amp	10
4.1.11 RRC Low Pass Filter.....	10
4.1.12 Tx Output Buffer.....	11
4.1.13 Rx Level/Clock Extraction	12
4.1.14 Clock Oscillator and Dividers	12
4.2 Modem - μ C Interaction	12
4.3 Binary to Symbol Translation.....	13
4.4 Frame Structure.....	14
4.5 The Programmer's View	15
4.5.1 Data Block Buffer	15
4.5.2 Command Register	16
4.5.2.1 Command Register B7: AQSC - Acquire Symbol Clock	16
4.5.2.2 Command Register B6: AQLEV - Acquire Receive Signal Levels	16
4.5.2.3 Command Register B5: CRC	16
4.5.2.4 Command Register B4: TXIMP - Tx Level/Impulse Shape	16
4.5.2.5 Command Register B3 - Reserved	16
4.5.2.6 Command Register B2, B1, B0: TASK.....	17
4.5.2.7 NULL: No effect	18
4.5.2.8 SFP: Search for Frame Preamble.....	18
4.5.2.9 RHB: Read Header Block	19
4.5.2.10 RILB: Read 'Intermediate' or 'Last' Block.....	19
4.5.2.11 SFS: Search for Frame Sync	19
4.5.2.12 R4S: Read 4 Symbols.....	19
4.5.2.13 RSID: Read Station ID	19
4.5.2.14 T24S: Transmit 24 Symbols.....	20
4.5.2.15 THB: Transmit Header Block	20

4.5.2.16	TIB: Transmit Intermediate Block.....	20
4.5.2.17	TLB: Transmit Last Block.....	20
4.5.2.18	T4S: Transmit 4 Symbols.....	20
4.5.2.19	TSID: Transmit Station ID	21
4.5.2.20	RESET: Stop any current action	21
4.5.2.21	Task Timing	21
4.5.2.22	RRC Filter Delay	22
4.5.3	Control Register	23
4.5.3.1	Control Register B7, B6: CKDIV - Clock Division Ratio	23
4.5.3.2	Control Register B5, B4: FSTOL - Frame Sync Tolerance to Inexact Matches	23
4.5.3.3	Control Register B3, B2: LEVRES - Level Measurement Modes.....	23
4.5.3.4	Control Register B1, B0: PLLBW - Phase-Locked Loop Bandwidth Modes	24
4.5.4	Mode Register.....	25
4.5.4.1	Mode Register B7: IRQEN - $\overline{\text{IRQ}}$ Output Enable.....	25
4.5.4.2	Mode Register B6: INVSYM - Invert Symbols.....	25
4.5.4.3	Mode Register B5: TX/ $\overline{\text{RX}}$ - Tx/Rx Mode.....	25
4.5.4.4	Mode Register B4: RXEYE - Show Rx Eye	25
4.5.4.5	Mode Register B3: PSAVE - Powersave	26
4.5.4.6	Mode Register B2: SSIEN - 'S' Symbol IRQ Enable	26
4.5.4.7	Mode Register B1, B0: SSYM - 'S' Symbol To Be Transmitted	26
4.5.5	Status Register	26
4.5.5.1	Status Register B7: IRQ - Interrupt Request.....	27
4.5.5.2	Status Register B6: BFREE - Data Block Buffer Free.....	27
4.5.5.3	Status Register B5: IBEMPTY - Interleave Buffer Empty.....	27
4.5.5.4	Status Register B4: DIBOVF - De-Interleave Buffer Overflow	27
4.5.5.5	Status Register B3: CRCERR - CRC Checksum Error.....	27
4.5.5.6	Status Register B2: 'S' Symbol Ready	28
4.5.5.7	Status Register B1, B0: SVAL - Received 'S' Symbol Value	28
4.5.6	Data Quality Register	28
4.6	CRC, FEC and Interleaving	29
4.6.1	Cyclic Redundancy Codes.....	29
4.6.1.1	CRC0	29
4.6.1.2	CRC1	29
4.6.1.3	CRC2	29
4.6.1.4	Forward Error Correction	29
4.6.1.5	Interleaving	29
4.7	Transmitted Symbol Shape	30
5	Application	32
5.1	Transmit Frame Example	32
5.2	Receive Frame Example	35
5.3	Clock Extraction and Level Measurement Systems	38
5.3.1	Supported Types of Systems.....	38
5.3.2	Clock and Level Acquisition Procedures with RF Carrier Detect	38
5.3.3	Clock and Level Acquisition Procedure without RF Carrier Detect.....	38

5.3.4	Automatic Acquisition Functions	39
5.4	AC Coupling	39
5.5	Radio Performance.....	40
5.6	Received Signal Quality Monitor	42
6	Performance Specification.....	43
6.1	Electrical Performance	43
6.1.1	Absolute Maximum Ratings	43
6.1.2	Operating Limits.....	43
6.1.3	Operating Characteristics	44
6.1.4	Operating Characteristics Notes:	45
6.1.5	Timing	45
6.1.6	Typical Bit Error Rate.....	47
6.2	Packaging.....	48

MX-COM, Inc. Reserves the right to change specifications at any time and without notice

Figures

Figure	Page
Figure 1: Block Diagram	6
Figure 2: Recommended External Components.....	8
Figure 3: Typical Modem • C connections.....	9
Figure 4: Translation of Binary Data to Filtered 4-Level Symbols in Tx Mode.....	10
Figure 5: RRC Filter Frequency Response vs. Bit Rate (including the external RC filter R4/C5).....	11
Figure 6: RRC Filter Frequency Response vs. Symbol Rate (including the external RC filter R4/C5).....	11
Figure 7: Over-Air Signal Format.....	14
Figure 8: Alternative Frame Structures.....	15
Figure 9: Transmit Task Overlapping.....	17
Figure 10: Receive Task Overlapping.....	18
Figure 11: Transmit Task Timing Diagram.....	22
Figure 12: Receive Task Timing Diagram.....	22
Figure 13: RRC Low Pass Filter Delay	22
Figure 14: Ideal 'RXEYE' Signal	26
Figure 15: Typical Data Quality Reading vs S/N.....	28
Figure 16: Input Signal to RRC Filter in Tx Mode for TXIMP = 0 and 1	30
Figure 17: Tx Signal Eye TXIMP = 0.....	30
Figure 18: Tx Signal Eye TXIMP = 1.....	31
Figure 19: Transmit Frame Example Flowchart, Main Program	33
Figure 20: Tx Interrupt Service Routine	34
Figure 21: Receive Frame Example Flowchart, Main Program	36
Figure 22: Rx Interrupt Service routine	37
Figure 23: Acquisition Sequence Timing	38
Figure 24: Effect of AC Coupling on BER (without FEC).....	39
Figure 25: Decay Time - AC Coupling	40
Figure 26: Typical Connections between Radio and MX929B.....	41
Figure 27: Received Signal Quality Monitor Flowchart.....	42
Figure 28: μ C Parallel Interface Timings	46
Figure 29: Typical Bit Error Rate With and Without FEC.....	47
Figure 30: 24-pin SOIC Mechanical Outline: <i>Order as part no. MX929BDW</i>	48
Figure 31: 24-pin SSOP Mechanical Outline: <i>Order as part no. MX929BDS</i>	48
Figure 32: 24-pin PDIP Mechanical Outline: <i>Order as part no. MX929BP</i>	49

1 Block Diagram

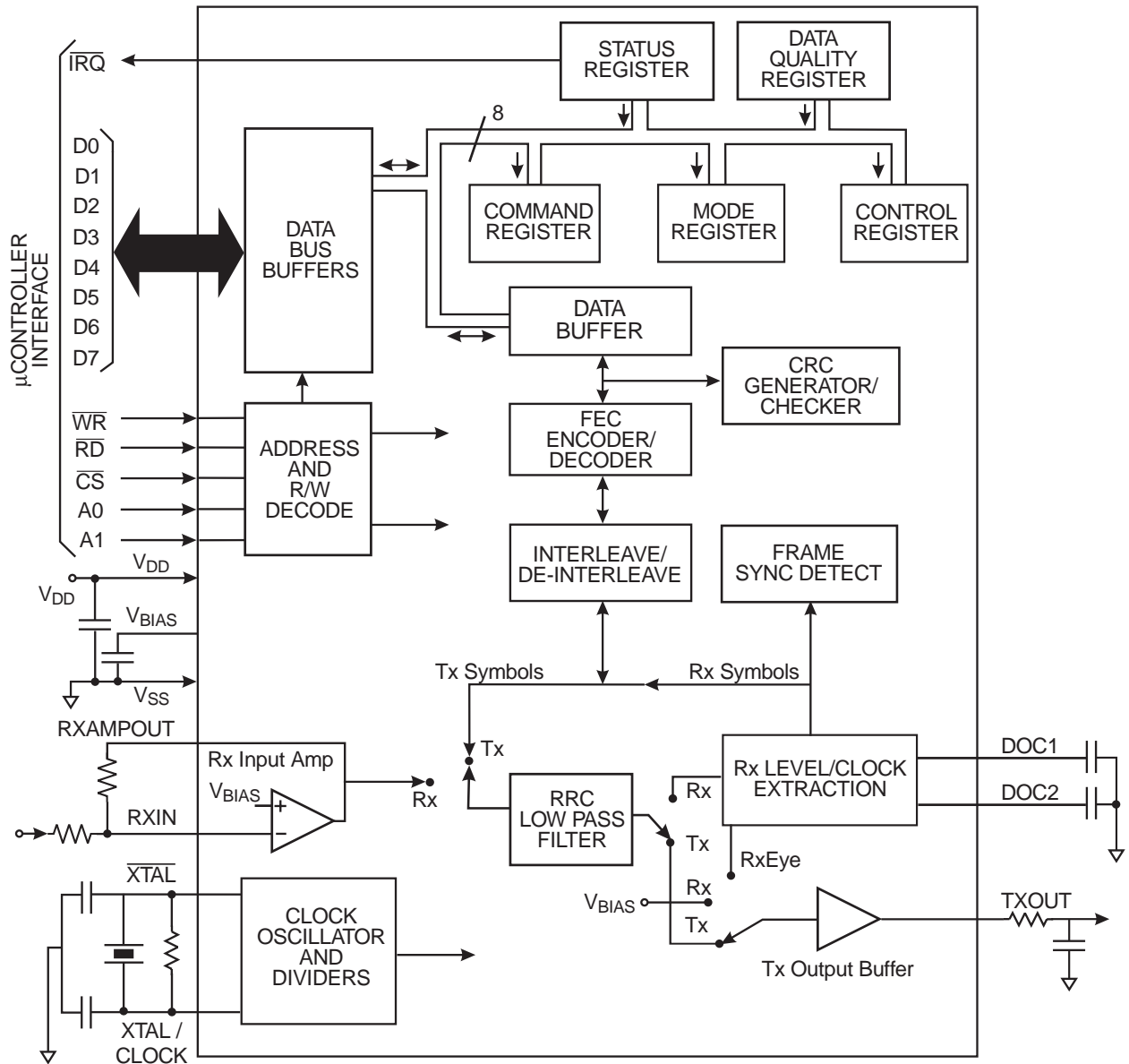

Figure 1: Block Diagram

2 Signal List

Pin No.	Signal	Type	Description
1	\overline{IRQ}	output	A 'wire-ORable' output for connection to the host μC 's Interrupt Request input. When active, this output has a low impedance pull down to V_{SS} . It has high impedance when inactive.
2	D7	BUS	Pins 2-9 (D7-D0) are 8-bit, bi-directional, 3-state μC interface data lines
3	D6	BUS	
4	D5	BUS	
5	D4	BUS	
6	D3	BUS	
7	D2	BUS	
8	D1	BUS	
9	D0	BUS	
10	\overline{RD}	input	Read. An active low logic level input used to control the reading of data from the modem into the host μC .
11	\overline{WR}	input	Write. An active low logic level input used to control the writing of data into the modem from the host μC .
12	V_{SS}	power	Negative supply (ground).
13	\overline{CS}	input	Chip Select. An active low logic level input to the modem used to enable a data read or write operation.
14	A0	input	Logic level modem register select input
15	A1	input	Logic level modem register select input
16	\overline{XTAL}	output	Output of the on-chip oscillator.
17	XTAL/CLOCK	input	Input to the on-chip oscillator, for an external Xtal circuit or clock.
18	DOC 2	output	Connection to the Rx level measurement circuitry. Should be capacitive coupled to V_{SS} .
19	DOC 1	output	Connection to the Rx level measurement circuitry. Should be capacitive coupled to V_{SS} .
20	TXOUT	output	Tx signal output from the modem.
21	V_{BIAS}	output	A bias line for the internal circuitry held at $V_{DD}/2$. This pin must be bypassed to V_{SS} by a capacitor mounted close to the device pins.
22	RXIN	input	Input to the Rx input amplifier.
23	RXAMPOUT	output	Output of the Rx input amplifier.
24	V_{DD}	power	Positive supply. Levels and voltages are dependent upon this supply. This pin should be bypassed to V_{SS} by a capacitor mounted close to the device pins.

Note: Internal protection diodes are connected from each signal pin to V_{DD} and V_{SS} .

3 External Components

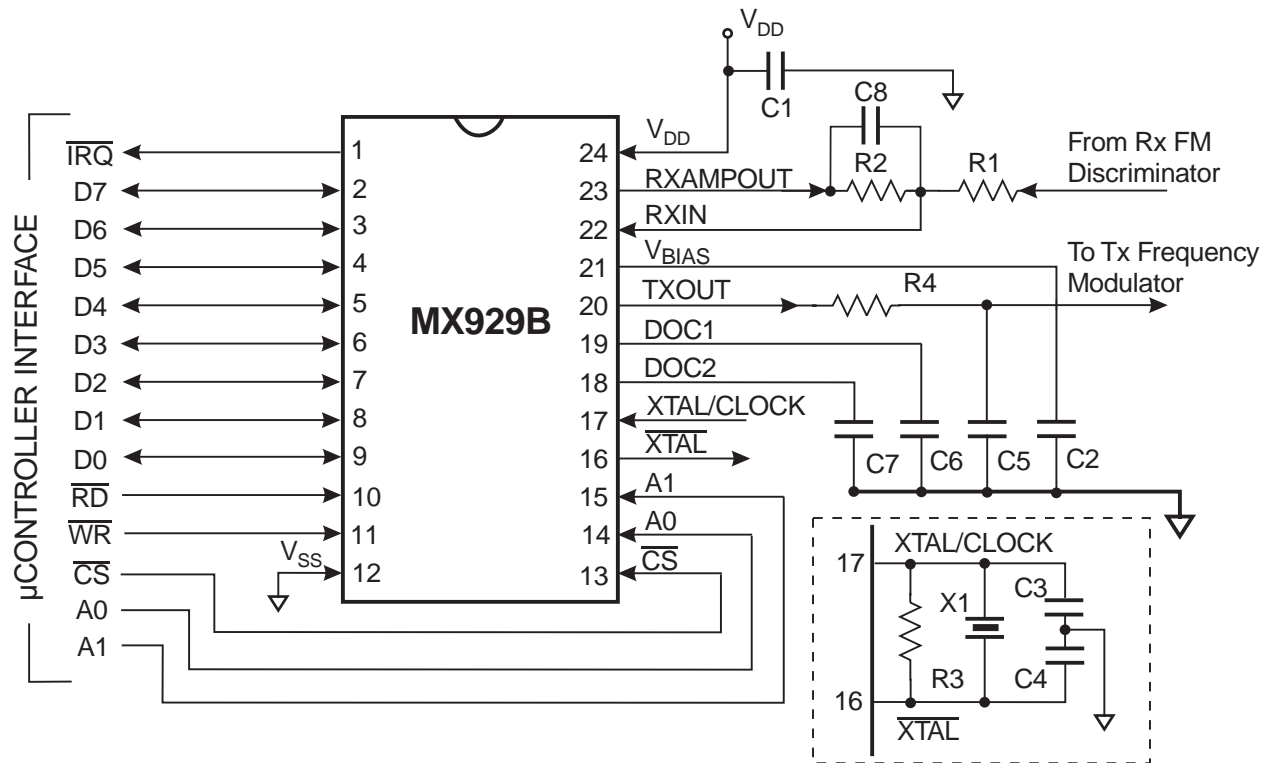

Figure 2: Recommended External Components

Component	Notes	Value	Tolerance
R1	1		±20%
R2		100kΩ	±5%
R3		1MΩ	±20%
R4		100kΩ	±5%
C1		0.1 μF	±20%
C2		0.1 μF	±20%
C3	3		±20%

Component	Notes	Value	Tolerance
C4	3		±20%
C5	4		±5%
C6	5		±20%
C7	5		±20%
C8	4		±5%
X1	2		

Recommended External Component Notes:

- See Section 4.1.10 Rx Input Amp.
- For best results, a crystal oscillator design should drive the clock inverter input with signal levels of at least 40% of V_{DD} , peak to peak. Tuning fork crystals generally cannot meet this requirement. To obtain crystal oscillator design assistance, consult your crystal manufacturer.
- The values used for C3 and C4 should be suitable for the frequency of the crystal X1. As a guide, values (including stray capacitance) of 33pF at 1MHz falling to 18pF at 10MHz will generally prove suitable. Crystal frequency tolerances are discussed in Section 4.5.3.4 Control Register B1, B0: PLLBW - Phase-Locked Loop Bandwidth Modes.
- Values C5 and C8 should be equal to $750,000 / \text{symbol rate}$, e.g.

Symbol Rate	C5 and C8
2400 symbols/second	330pF
4800 symbols/second	150pF
9600 symbols/second	82pF

5. Values C6 and C7 should be equal to 50,000 / symbol rate, e.g.

Symbol Rate	C6 and C7
2400 symbols/second	0.022 μ F
4800 symbols/second	0.01 μ F
9600 symbols/second	4700pF

4 General Description

4.1 Description of Blocks

4.1.1 Data Bus Buffers

Eight bi-directional 3-state logic level buffers between the modem's internal registers and the host μ C's data bus lines.

4.1.2 Address and R/W Decode

This block controls the transfer of data bytes between the μ C and the modem's internal registers according to the state of the Write and Read Enable inputs (\overline{WR} and \overline{RD}), the Chip Select input (\overline{CS}), and the Register Address inputs A0 and A1.

The Data Bus Buffers, Address, and R/W Decode blocks provide a byte-wide parallel μ C interface, which can be memory-mapped, as shown in Figure 3.

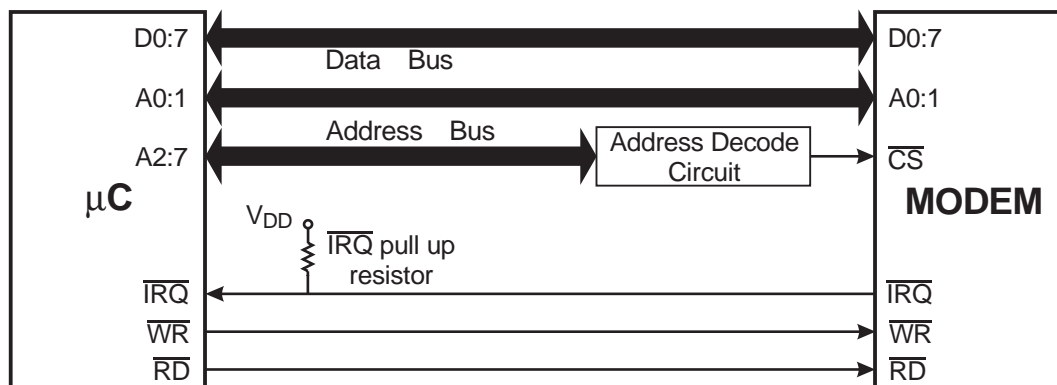

Figure 3: Typical Modem μ C connections

4.1.3 Status and Data Quality Registers

Two 8-bit registers which the μ C can read to determine the status of the modem and received data quality.

4.1.4 Command, Mode, and Control Registers

The values written by the μ C to these 8-bit registers control the operation of the modem.

4.1.5 Data Buffer

A 12-byte buffer used to hold, receive or transmit data to or from the μ C.

4.1.6 CRC Generator/Checker

A circuit which generates (in transmit mode) or checks (in receive mode) the Cyclic Redundancy Checksum bits, which may be included in the transmitted data blocks so the receive modem can detect transmission errors.

4.1.7 FEC Generator/Checker

In transmit mode, this circuit adds Forward Error Correction bits to the transmitted data, resulting in the conversion of binary data to 4-level symbols. In receive mode, this circuit translates received 4-level symbols to binary data, using the FEC information to correct a large proportion of transmission errors.

4.1.8 Interleave/De-Interleave Buffer

This circuit interleaves data symbols within a block before transmission and de-interleaves the received data so that the FEC system is best able to handle short noise bursts or fades.

4.1.9 Frame Sync Detect

This circuit, which is only active in receive mode, is used to look for the 24-symbol Frame Synchronization pattern that is transmitted to mark the start of every frame.

4.1.10 Rx Input Amp

This amplifier allows the received signal input to the modem to be set to the optimum level by suitable selection of the external components R1 and R2. The value of R1 should be calculated to give $0.2 \times V_{DD}$ volts_{p-p} at the RXAMPOUT pin for a received '...+3 +3 -3 -3 ...' sequence.

A capacitor may be placed in series with R1 if ac coupling of the received signal is desired (see Section 5.4AC Coupling), otherwise the DC level of the received signal should be adjusted so that the signal at the modem's RXAMPOUT pin is centered around V_{BIAS} ($V_{DD}/2$).

4.1.11 RRC Low Pass Filter

This filter, which is used in both transmit and receive modes, is a linear-phase lowpass filter with a 'Root Raised Cosine' frequency response defined by:

$$H(f) = 1 \text{ for } 0 \leq f < \frac{1-b}{2T}$$

$$H(f) = \sqrt{\frac{1}{2} - \frac{\sin\left(\frac{(\pi T f - \frac{\pi}{2})}{b}\right)}{2}} \text{ for } \frac{1-b}{2T} \leq f \leq \frac{1+b}{2T}$$

$$H(f) = 0 \text{ for } f > \frac{1+b}{2T}$$

$$\text{Where } b=0.2, \quad T = \frac{1}{\text{symbol rate}}$$

This frequency response is illustrated in Figure 5 and Figure 6.

In transmit mode, the 4-level symbols are passed through this filter to eliminate the high frequency components which would otherwise cause interference into adjacent radio channels. The input applied to the RRC Tx filter may be impulses or full-width symbols depending on the setting of the Command Register TXIMP bit. See Section 4.7 Transmitted Symbol Shape.

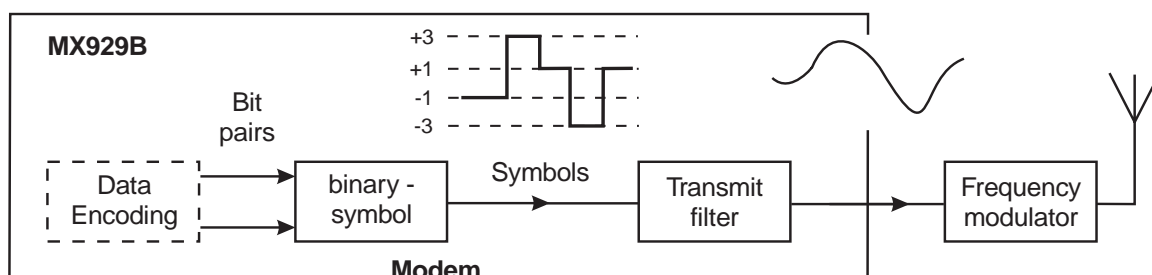

Figure 4: Translation of Binary Data to Filtered 4-Level Symbols in Tx Mode

In receive mode, the filter is used to reject HF noise and to equalize the received signal to a form suitable for extracting the 4-level symbols. The equalization characteristics are determined by the setting of the Command Register TXIMP bit.

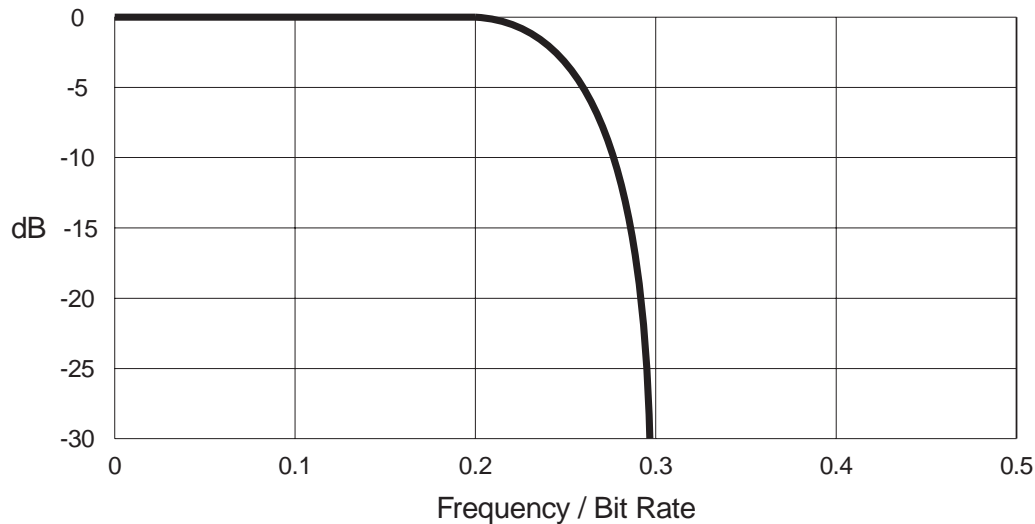

Figure 5: RRC Filter Frequency Response vs. Bit Rate (including the external RC filter R4/C5)

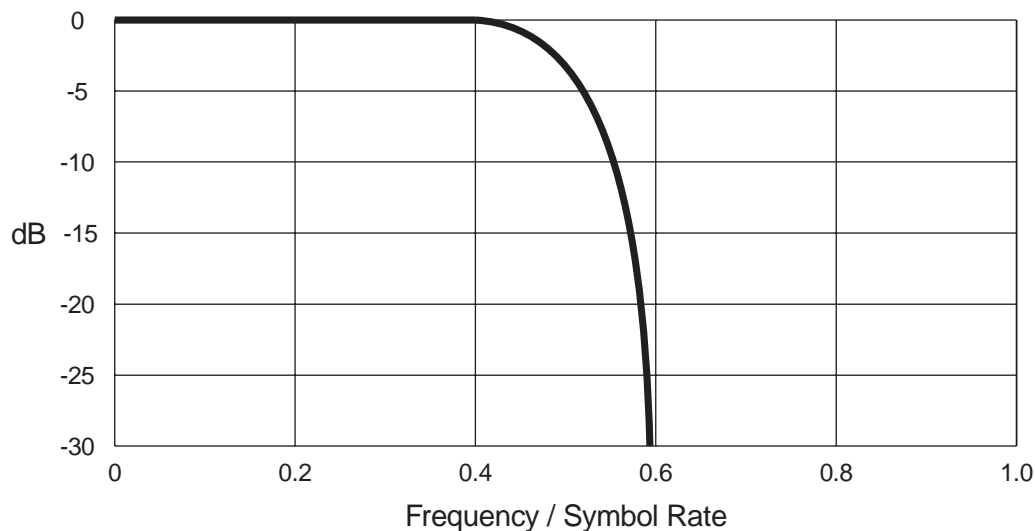

Figure 6: RRC Filter Frequency Response vs. Symbol Rate (including the external RC filter R4/C5)

4.1.12 Tx Output Buffer

This is a unity gain amplifier used in the transmit mode to buffer the output of the Tx low pass filter. In receive mode, the input of this buffer is connected to V_{BIAS} , unless the RXEYE bit of the Control Register is '1', in which case it is connected to the received signal. When changing from Rx to Tx mode, the input to this buffer will be connected to V_{BIAS} for 8 symbol times while the RRC filter settles.

Note: The RC low pass filter formed by the external components R4 and C5 between the TXOUT pin and the input to the radio's frequency modulator forms an important part of the transmit signal filtering. These components may form part of any DC level-shifting and gain adjustment circuitry. The value used for C5 should take into account stray circuit capacitance, and its ground connection should be positioned to give maximum attenuation of high frequency noise into the modulator.

The signal at the TXOUT pin is centered around V_{BIAS} . It is approximately $0.2 \times V_{DD}$ volts_{P-P} for a continuous '+3 +3 -3 -3...' pattern with TXIMP = 0. For typical Tx Eye Diagrams refer to Section 4.7 Transmitted Symbol Shape, Figure 17 and Figure 18. For typical Rx Eye Diagrams refer to Section 4.5.4.4 Mode Register B4: RXEYE - Show Rx Eye, Figure 14.

A capacitor may be placed in series with the input to the frequency modulator if AC coupling is desired. See Section 5.4 AC Coupling.

4.1.13 Rx Level/Clock Extraction

These circuits, which operate only in receive mode, derive a symbol rate clock from the received signal and measure the received signal amplitude and DC offset. This information is then used to extract the received 4-level symbols and also to provide an input to the received Data Quality measuring circuit. The external capacitors C6 and C7 form part of the received signal level measuring circuit.

The capacitors C6 and C7 are driven from a very high impedance source so any measurement of the voltages on the DOC pins must be made via high input impedance (MOS input) voltage followers to avoid disturbance of the level measurement circuits.

Further details of the level and clock extraction functions are given in Section 5.3 Clock Extraction and Level Measurement Systems.

4.1.14 Clock Oscillator and Dividers

These circuits derive the transmit symbol rate (and the nominal receive symbol rate) by frequency division of a reference frequency which may be generated by the on-chip Xtal oscillator or applied from an external source.

Note: If the on-chip Xtal oscillator is to be used, then the external components X1, C3, C4, and R3 are required. If an external clock source is to be used, then it should be connected to the XTAL/CLOCK input pin, the $\overline{\text{XTAL}}$ pin should be left unconnected, and X1, C3, C4, and R3 should not be installed.

4.2 Modem - μC Interaction

In general, data is transmitted over-air in the form of messages, or 'Frames', consisting of a 'Frame Preamble' followed by one or more formatted data blocks. The Frame Preamble includes a Frame Synchronization pattern designed to allow the receiving modem to identify the start of a frame. The following data blocks are constructed from the 'raw' data using a combination of CRC (Cyclic Redundancy Checksum) generation, Forward Error Correction coding, and Interleaving. Details of the message formats handled by the modem are provided in Section 4.3 Binary to Symbol Translation, Figure 7, and Figure 8.

To reduce the processing load on the associated μC , the MX929B modem has been designed to perform as much of the computationally intensive work involved in Frame formatting and de-formatting and (when in receive mode) searching for and synchronizing onto the Frame Preamble. In normal operation, the modem will only require servicing by the μC once per received or transmitted block.

Therefore, to transmit a block, the controlling μC needs only to load the unformatted 'raw' binary data into the modem's Data Block Buffer, then instruct the modem to format and transmit that data. The modem will then calculate and add the CRC bits as required, encode the result as 4-level symbols (with Forward Error Correction coding), and interleave the symbols before transmission.

In receive mode, the modem can be instructed to assemble a block's worth of received symbols, de-interleave the symbols, translate them to binary, perform Forward Error Correction, and check the resulting CRC before placing the received binary data into the Data Block Buffer for the μC to read.

The modem can also handle the transmission and reception of unformatted data using the T4S, T24S, and R4S tasks as described in Sections 4.3 Binary to Symbol Translation and 4.5.2 Command Register. These tasks are normally used for the transmission of Symbol and Frame Synchronization sequences. These tasks may also be used for the transmission and reception of special test patterns or special data formats. In such a case, care should be taken to ensure that the transmitted TXOUT signal contains enough level and timing information for the receiving modem's level and clock extraction circuits to function correctly. See Section 5.3 Clock Extraction and Level Measurement Systems.

4.3 Binary to Symbol Translation

Although the over-air signal, and therefore the signals at the modem TXOUT and RXIN pins, consists of 4-level symbols, the raw data passing between the modem and the μ C is in binary form. Translation between binary data and the 4-level symbols is done in one of two ways, depending on the task being performed.

1. Direct way: (simplest form) - converts between two binary bits and a single symbol, such as the 'S' Channel Status symbol.

SYMBOL	MSB	LSB
+3	1	1
+1	1	0
-1	0	0
-3	0	1

Accordingly, 1 byte = 4 symbols = 8 bits, and one byte translates to four symbols for the T4S and R4S tasks and six bytes translates to twenty-four symbols for the T24S task described in Section 4.5.2 Command Register.

	MSB				LSB			
Bits:	7	6	5	4	3	2	1	0
Symbols:	a		b		c		d	
	sent first				sent last			

2. FEC way: (more complicated) - essentially translates groups of 3 binary bits to pairs of 4-level symbols using a Forward Error Correcting coding scheme for the block oriented tasks THB, TIB, TLB, RHB, RILB, and RSID described in Section 4.5.2 Command Register.

4.4 Frame Structure

The MX929B Frame Structure as used in a RD-LAP™ system is illustrated in Figure 7, and consists of a Frame Preamble (comprising a 24-symbol Frame Synchronization pattern and Station ID block), followed by a 'Header Block', one or more 'Intermediate Blocks', and a 'Last Block'. Channel Status (S) symbols are included at regular intervals. The first Frame of any transmission is preceded by a Symbol Synchronization pattern.

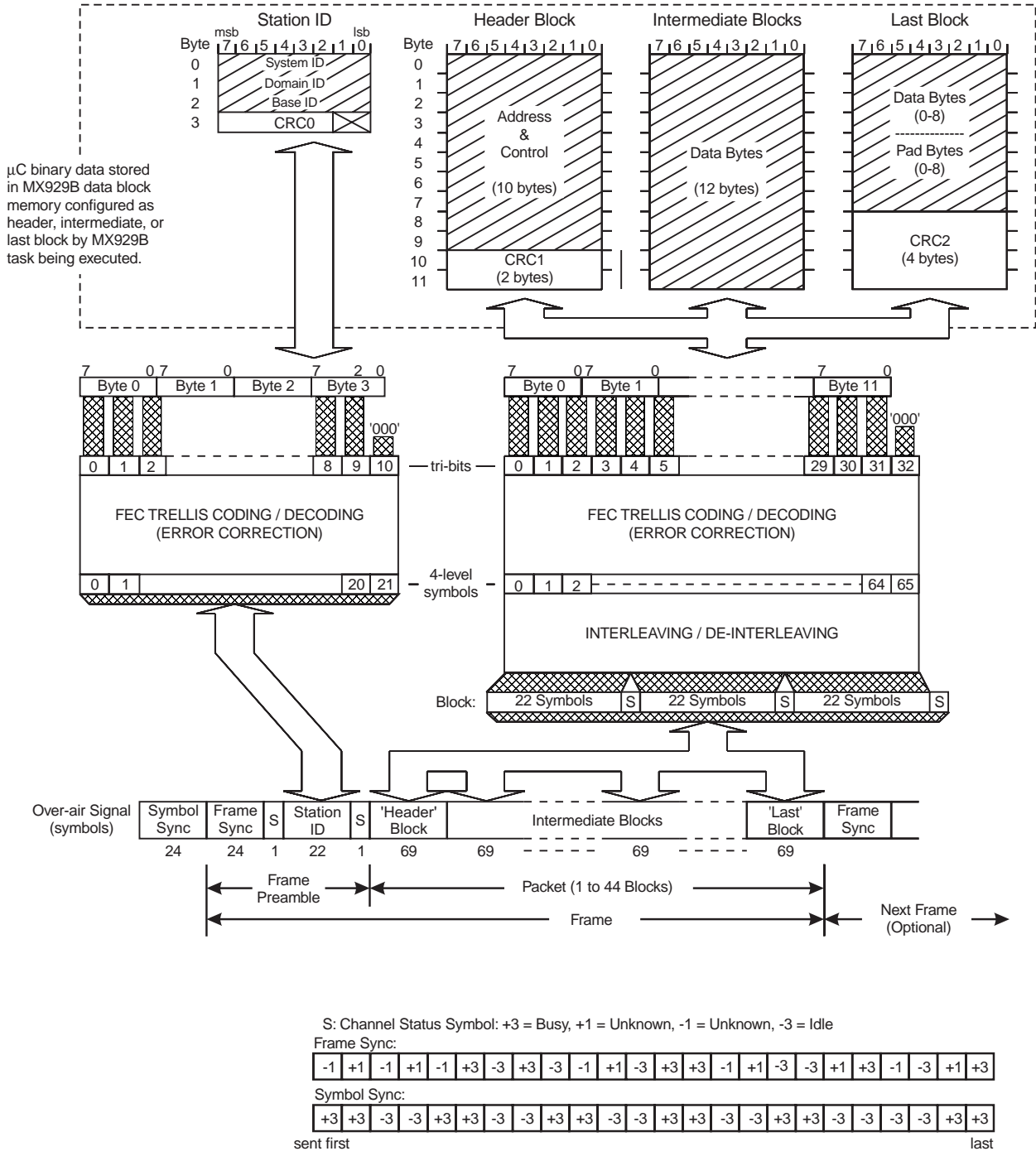

Figure 7: Over-Air Signal Format

The 'Header' block is self-contained and includes its own checksum (CRC1). It would normally carry information such as the address of the calling and called parties, the number of following blocks in the frame (if any), and miscellaneous control information. The number of following blocks (if any) is required to allow the Rx device software to expect the Last Block and interpret it as a Last Block rather than an Intermediate Block. There is no other indicator to differentiate a Last Block and an Intermediate Block.

The 'Intermediate' block(s) contain only data, the checksum at the end of the 'Last' block (CRC2) also checks the data in any preceding 'Intermediate' blocks.

Proprietary systems that do not use RD-LAP™ format may use the block structures provided by the MX929B to build alternative frame formats more suited to the particular application. Some examples are shown in Figure 7.

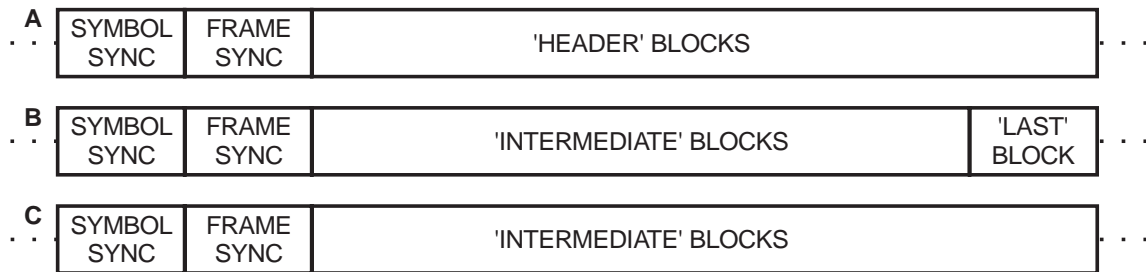

Figure 8: Alternative Frame Structures

The MX929B performs the entire block formatting and de-formatting required to convert data between the μ C binary form and the Over-Air form as shown in Figure 7.

4.5 The Programmer's View

To the programmer, the modem appears as 4 write only 8-bit registers, shadowed by 3 read only registers. The individual registers are selected by the A0 and A1 chip inputs:

A1	A0	Write to Modem	Read from Modem
0	0	Data Buffer	Data Buffer
0	1	Command Register	Status Register
1	0	Control Register	Data Quality Register
1	1	Mode Register	not used

Note: There is a minimum time allowance between accesses of the modem's registers, see Section 6.1.5 Timing.

4.5.1 Data Block Buffer

This is a 12-byte read/write buffer used to transfer data (as opposed to command, status, mode, and data quality or control information) between the modem and the host μ C.

To the μ C, the Data Block Buffer appears as a single 8-bit register. The modem ensures that sequential μ C reads or writes to the buffer are routed to the correct locations within the buffer.

The μ C should only access this buffer when the Status Register BFREE (Buffer Free) bit is '1'.

The buffer should only be written to while in Tx mode and read from while in Rx mode. Note that in receive mode, the modem will function correctly even if the received data is not read from the Data Buffer by the μ C.

4.5.2 Command Register

Writing to this register tells the modem to perform a specific task as indicated by the TASK bits and modified by the AQSC, AQLEV, CRC, and TXIMP bits.

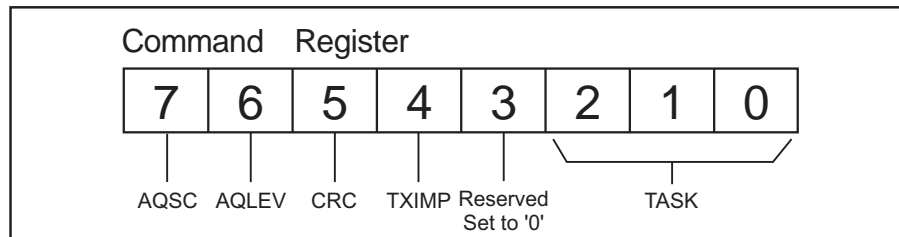

When there is no action to perform, the modem will be in an 'idle' state. If the modem is in transmit mode, the input to the Tx RRC filter will be connected to V_{BIAS} . In receive mode, the modem will continue to measure the received data quality and extract symbols from the received signal, supplying them to the de-interleave buffer, but otherwise these received symbols are ignored.

4.5.2.1 Command Register B7: AQSC - Acquire Symbol Clock

This bit has no effect in transmit mode.

In receive mode, when a byte with the AQSC bit set to '1' is written to the Command Register, and TASK is not set to RESET, it initiates an automatic sequence designed to achieve symbol timing synchronization with the received signal as quickly as possible. This involves setting the Phase Locked Loop of the received bit timing extraction circuits to its widest bandwidth, then gradually reducing the bandwidth as timing synchronization is achieved, until it reaches the 'normal' value set by the PLLBW bits of the Control Register.

Setting this bit to '0' (or changing it from '1' to '0') has no effect, however; the acquisition sequence will be re-started every time a byte written to the Command Register has AQSC = '1'.

The use of the symbol clock acquisition sequence is described in Section 5.3 Clock Extraction and Level Measurement Systems.

4.5.2.2 Command Register B6: AQLEV - Acquire Receive Signal Levels

This bit has no effect in transmit mode.

In receive mode, when a byte with the AQLEV bit set to '1' is written to the Command Register and TASK is not set to RESET, it initiates an automatic sequence designed to measure the amplitude and DC offset of the received signal as rapidly as possible. This sequence involves setting the measurement circuits to respond quickly at first, then gradually increasing their response time, therefore improving the measurement accuracy, until the 'normal' value set by the LEVRES bits of the Control Register is reached.

Setting this bit to '0' (or changing it from '1' to '0') has no effect, however; the acquisition sequence will be re-started every time a byte written to the Command Register has AQLEV = '1'.

The use of the level measurement acquisition sequence (AQLEV) is described in Section 5.3 Clock Extraction and Level Measurement Systems.

4.5.2.3 Command Register B5: CRC

This bit allows the user to select between two different initial states of the CRC0, CRC1 and CRC2 checksum generators. When this bit is set to '1' the CRC generators are initialized to 'all zeros', as required by RD-LAP™ systems. When this bit is set to '0', the CRC generators are initialized to 'all ones' as required by CCITT X25 CRC based systems. It should always be set to '1' for RD-LAP™ compatibility. Other systems may set this bit as required.

4.5.2.4 Command Register B4: TXIMP - Tx Level/Impulse Shape

This bit allows the user to choose between two transmit symbol waveform shapes as described in Section 4.7 Transmitted Symbol Shape.

Note: This bit must be set correctly every time the Command Register is written to.

4.5.2.5 Command Register B3 - Reserved

This bit should always be set to '0'.

4.5.2.6 Command Register B2, B1, B0: TASK

Operations such as transmitting or receiving a data block are treated by the modem as 'tasks' and are initiated when the μC writes a byte to the Command Register with the TASK bits set to anything other than the 'NULL' code.

The μC should not write a task (other than NULL or RESET) to the Command Register or write to or read from the Data Buffer when the BFREE (Buffer Free) bit of the Status Register is '0'.

Different tasks apply in receive and transmit modes.

When the modem is in transmit mode, all tasks other than NULL or RESET instruct the modem to transmit data from the Data Buffer, formatting it as required. The μC should therefore wait until the BFREE (Buffer Free) bit of the Status Register is '1', before writing the data to the Data Block Buffer, then it should write the desired task to the Command Register. If more than 1 byte needs to be written to the Data Block Buffer, byte number 0 of the block should be written first.

Once the byte containing the desired task has been written to the Command Register, the modem will:

Set the BFREE (Buffer Free) bit of the Status Register to '0'.

Take the data from the Data Block Buffer as quickly as it can - transferring it to the Interleave Buffer for eventual transmission. This operation will start immediately if the modem is 'idle' (i.e. not transmitting data from a previous task), otherwise it will be delayed until there is sufficient room in the Interleave Buffer.

Once all of the data has been transferred from the Data Block Buffer, the modem will set the BFREE and IRQ bits of the Status Register to '1', (causing the chip $\overline{\text{IRQ}}$ output to go low if the IRQEN bit of the Mode Register has been set to '1') to tell the μC that it may write new data and the next task to the modem.

This lets the μC write the next task and its associated data to the modem while the modem is still transmitting the data from its previous task.

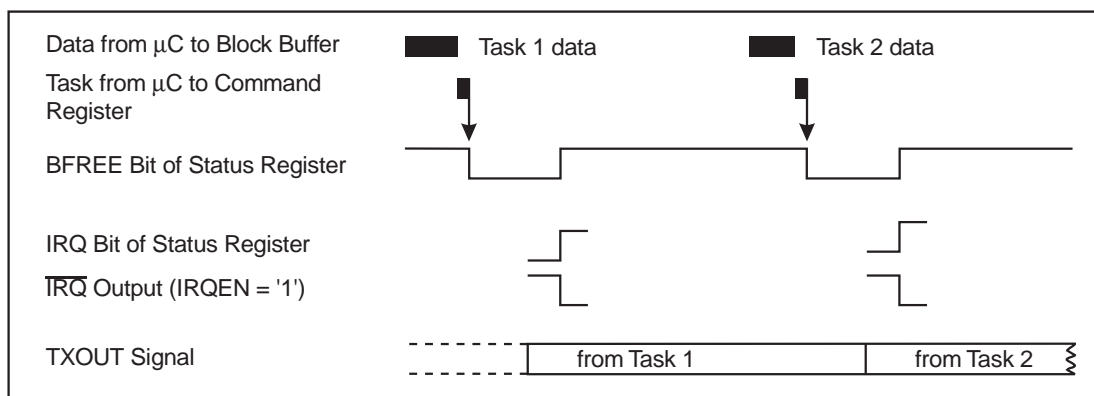

Figure 9: Transmit Task Overlapping

When the modem is in receive mode, the μC should wait until the BFREE bit of the Status Register is '1', then write the desired task to the Command Register.

Once the byte containing the desired task has been written to the Command Register, the modem will:

Set the BFREE bit of the Status Register to '0'.

Wait until enough received symbols are in the De-interleave Buffer.

Decode them as needed and transfer the resulting binary data to the Data Block Buffer

Then the modem will set the BFREE and IRQ bits of the Status Register to '1', (causing the $\overline{\text{IRQ}}$ output to go low if the IRQEN bit of the Mode Register has been set to '1') to tell the μC that it may read from the Data Block Buffer and write the next task to the modem. If more than 1 byte is contained in the buffer, byte number 0 of the data will be read out first.

In this way, the μC can read data and write a new task to the modem while the received symbols needed for this new task are being received and stored in the De-interleave Buffer.

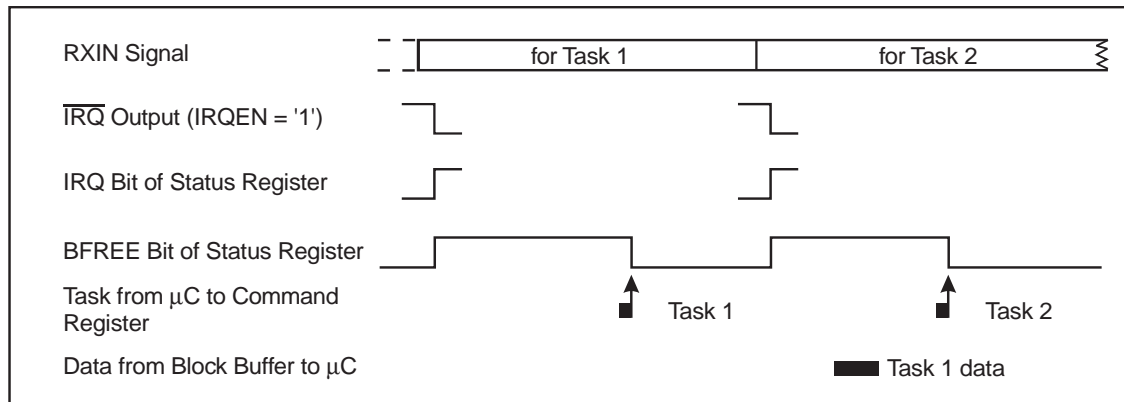

Figure 10: Receive Task Overlapping

Detailed timings for the various tasks are provide in Figure 11 and Figure 12.

MX929B Modem Tasks:

B2	B1	B0	Receive Mode		Transmit Mode	
0	0	0	NULL		NULL	
0	0	1	SFP	Search for Frame Preamble	T24S	Transmit 24 symbols
0	1	0	RHB	Read Header Block	THB	Transmit Header Block
0	1	1	RILB	Read Intermediate or Last Block	TIB	Transmit Intermediate Block
1	0	0	SFS	Search for Frame Sync	TLB	Transmit Last Block
1	0	1	R4S	Read 4 symbols	T4S	Transmit 4 symbols
1	1	0	RSID	Read Station ID	TSID	Transmit Station ID
1	1	1	RESET	Cancel any current action	RESET	Cancel any current action

4.5.2.7 NULL: No effect

This is provided so an AQSC or AQLEV command can be initiated without loading a new task.

4.5.2.8 SFP: Search for Frame Preamble

This task causes the modem to search the received signal for a valid 24-symbol Frame Preamble, consisting of a 24-symbol Frame Sync sequence followed by Station ID Block which has a correct CRC0 checksum.

The task continues until a valid Frame Preamble has been found.

The search consists of four stages:

First the modem will attempt to match the incoming symbols against the Frame Synchronization pattern to within the tolerance defined by the FSTOL bits of the Control Register.

Once a match has been found, the modem will read in the following 'S' symbol, place it in the SVAL bits of the Status Register then set the SRDY bit to '1'. (The IRQ bit of the Status Register will also be set to '1' at this time if the SSIEN bit of the Mode Register is '1').

The modem will then read the next 22 symbols as station ID data. They will be decoded and the CRC0 checked. If this is incorrect, the modem will resume the search, looking for a fresh Frame Sync pattern.

If the received CRC0 is correct, the following 'S' symbol will be read into the SVAL bits of the Status Register and the SRDY, BFREE, and IRQ bits set to '1', the CRCERR bit cleared to '0', and the three decoded Station ID bytes placed into the Data Block Buffer.

Upon detecting that the BFREE bit of the Status Register has gone to '1', the μ C should read the three Station ID bytes from the Data Block Buffer and then write the next task to the modem's Command Register.

4.5.2.9 RHB: Read Header Block

This task causes the modem to read the next 69 symbols as a 'Header' Block. It will strip out the 'S' symbols then de-interleave and decode the remaining 66 symbols, placing the resulting 10 data bytes and the 2 received CRC1 bytes into the Data Block Buffer and, when the task is complete, setting the BFREE and IRQ bits of the Status Register to '1' to indicate that the μ C may read the data from the Data Block Buffer and write the next task to the modem's Command Register.

The CRCERR bit of the Status Register will be set to '1' or '0' depending on the validity of the received CRC1 checksum bytes.

As each of the three 'S' symbols of a block is received, the SVAL bits of the Status Register will be updated and the SRDY bit set to '1'. (If the SSIEN bit of the Mode Register is '1', then the Status Register IRQ bit will also be set to '1'.) Note that when the third 'S' symbol is received, the SRDY bit will be set to '1' coincidentally with the BFREE bit also being set to '1'.

4.5.2.10 RILB: Read 'Intermediate' or 'Last' Block

This task causes the modem to read the next 69 symbols as an 'Intermediate' or 'Last' block. (The μ C can tell from the 'Header' block how many blocks are in the frame and therefore when to expect the 'Last' block).

In each case, it will strip out the three 'S' symbols, de-interleave, and decode the remaining 66 symbols and place the resulting 12 bytes into the Data Block Buffer, setting the BFREE and IRQ bits of the Status Register to '1' when the task is complete.

If an 'Intermediate' block is received, then the μ C should read out all 12 bytes from the Data Block Buffer and ignore the CRCERR bit of the Status Register. For a 'Last' block the μ C need only read the first 8 bytes from the Data Block Buffer, and the CRCERR bit in the Status Register will reflect the validity of the received CRC2 checksum.

As each of the three 'S' symbols of the block is received, the SVAL bits of the Status Register will be updated and the SRDY bit set to '1'. (If the SSIEN bit of the Mode Register is '1', then the Status Register IRQ bit will also be set to '1'.) Note that when the third 'S' symbol is received, the SRDY bit will be set to '1' coincidentally with the BFREE bit also being set to '1'.

4.5.2.11 SFS: Search for Frame Sync

This task, which is intended for special test and channel monitoring purposes, performs the first two parts only of a SFP task. It causes the modem to search the received signal for a 24-symbol sequence, which matches the required Frame Synchronization pattern to within the tolerance defined by the FSTOL bits of the Mode Register.

When a match is found the modem will read in the following 'S' symbol, then set the BFREE, IRQ, and SRDY bits of the Status Register to '1' and update the SVAL bits. The μ C may then write the next task to the Command Register.

4.5.2.12 R4S: Read 4 Symbols

This task causes the modem to read the next 4 symbols and translate them directly (without de-interleaving or FEC) to an 8-bit byte which is placed into the Data Block Buffer. The BFREE and IRQ bits of the Status Register are then set to '1' to indicate that the μ C may read the data byte from the Data Block Buffer and write the next task to the Command Register.

This task is intended for special tests and channel monitoring - perhaps preceded by a SFS task.

Note: It is possible to construct message formats, which do not rely on the block formatting of the THB, TIB, and TLB tasks. This can be accomplished by using T4S or T24S tasks to transmit and R4S to receive the user's data. One should be aware, that the receive level and timing measurement circuits need to see a reasonably 'random' distribution of all four possible symbols in the received signal to operate correctly. Accordingly, binary data may benefit from scrambling before transmission if it is not reasonably 'random' to start with.

4.5.2.13 RSID: Read Station ID

This task causes the modem to read in and decode the following 23 symbols as Station ID data followed by an 'S' symbol. It is similar to the last two parts of a SFP task except that it will not restart if the received CRC0 is incorrect. It would normally follow a SFS task.

The three decoded bytes will be placed into the Data Block Buffer, and the CRCERR bit of the Status Register set to '1' if the received CRC0 is incorrect, otherwise it will be cleared to '0'. The SVAL bits of the Status Register will be updated and the BFREE, SRDY, and IRQ bits set to '1' to indicate that the μ C may read the three received bytes from the Data Block buffer and write the next task to the modem's Command Register.

4.5.2.14 T24S: Transmit 24 Symbols

This task, which is intended to facilitate the transmission of Symbol and Frame Sync patterns as well as special test sequences, takes 6 bytes of data from the Data Block Buffer and transmits them as 24 4-level symbols without any CRC, FEC, interleaving, or adding any 'S' symbols.

Byte 0 of the Data Block Buffer is sent first, byte 5 last.

Once the modem has read the data bytes from the Data Block Buffer, the BFREE and IRQ bits of the Status Register will be set to '1', indicating to the μ C that it may write the data and command byte for the next task to the modem.

The tables below show what data needs to be written to the Data Block Buffer to transmit the MX929B Symbol and Frame Sync sequences:

'Symbol Sync'				Values written to Data Block Buffer		
Symbols					Binary	Hex
+3	+3	-3	-3	Byte 0:	11110101	F5
+3	+3	-3	-3	Byte 1:	11110101	F5
+3	+3	-3	-3	Byte 2:	11110101	F5
+3	+3	-3	-3	Byte 3:	11110101	F5
+3	+3	-3	-3	Byte 4:	11110101	F5
-3	-3	+3	+3	Byte 5:	01011111	5F

'Frame Sync'				Values written to Data Block Buffer		
Symbols					Binary	Hex
-1	+1	-1	+1	Byte 0:	00100010	22
-1	+3	-3	+3	Byte 1:	00110111	37
-3	-1	+1	-3	Byte 2:	01001001	49
+3	+3	-1	+1	Byte 3:	11110010	F2
-3	-3	+1	+3	Byte 4:	01011011	5B
-1	-3	+1	+3	Byte 5:	00011011	1B

4.5.2.15 THB: Transmit Header Block

This task takes 10 bytes of data (Address and Control) from the Data Block Buffer, calculates and appends the 2-byte CRC1 checksum, translates the result to 4-level symbols (with FEC), interleaves the symbols, and transmits the result as a formatted 'Header' Block, inserting 'S' symbols at 22 symbol intervals.

Once the modem has read the data bytes from the Data Block Buffer, the BFREE and IRQ bits of the Status Register will be set to '1'.

4.5.2.16 TIB: Transmit Intermediate Block

This task takes 12 bytes of data from the Data Block Buffer, updates the 4-byte CRC2 checksum for inclusion in the 'Last' block, translates the 12 data bytes to 4-level symbols (with FEC), interleaves the symbols, and transmits the result as a formatted 'Intermediate' Block, inserting 'S' symbols at 22-symbol intervals.

Once the modem has read the data bytes from the Data Block Buffer, the BFREE and IRQ bits of the Status Register will be set to '1'.

4.5.2.17 TLB: Transmit Last Block

This task takes 8 bytes of data from the Data Block Buffer, updates and appends the 4-byte CRC2 checksum, translates the resulting 12 bytes to 4-level symbols (with FEC), interleaves the symbols, and transmits the result as a formatted 'Last' Block, inserting 'S' symbols at 22-symbol intervals.

Once the modem has read the data bytes from the Data Block Buffer, the BFREE and IRQ bits of the Status Register will be set to '1'.

4.5.2.18 T4S: Transmit 4 Symbols

This task is similar to T24S but takes only one byte from the Data Block Buffer, transmitting it as four 4-level symbols.

4.5.2.19 TSID: Transmit Station ID

This task takes three ID bytes from the Data Block Buffer, calculates and appends the 6-bit CRC0 checksum, translates the result to 4-level symbols (with FEC) and transmits the resulting 22 symbols preceded and followed by 'S' symbols.

Once the modem has read the data bytes from the Data Block Buffer, the BFREE and IRQ bits of the Status Register will be set to '1'.

4.5.2.20 RESET: Stop any current action

This task takes effect immediately, and terminates any current action (task, AQSC or AQLEV) the modem may be performing and sets the BFREE bit of the Status Register to '1', without setting the IRQ bit. It should be used after V_{DD} is applied first to set the modem into a known state.

Note: Due to delays in the RRC filter, it will take several symbol times for any change caused by RESET to appear at the TXOUT pin.

4.5.2.21 Task Timing

The following table and figures describe the duration of tasks and timing sequences for Tx and Rx operation.

		Task	Time (symbol times)
t ₁	Modem in idle state. Time from writing first task to application of first transmit bit to Tx RRC filter	Any	1 to 2
t ₂	Time from application of first symbol of the task to the Tx RRC filter until BFREE goes to a logic '1'	T24S TSID THB/TIB/TLB T4S	5 6 16 0
t ₃	Time to transmit all symbols of the task	T24S/TSID THB/TIB/TLB T4S	24 69 4
t ₄	Max time allowed from BFREE going to a logic '1' (high) for next task (and data) to be written to modem	T24S TSID THB/TIB/TLB T4S	18 17 52 3
t ₅	Time to receive all symbols of task	SFS SFP RSID RHB/RILB R4S	25 (minimum) 48 (minimum) 23 69 4
t ₆	Maximum time between first symbol of task entering the de-interleave circuit and the task being written to modem	SFS SFP RSID RHB/RILB R4S	21 21 15 51 3
t ₇	Maximum time from the last bit of the task entering the de interleave circuit to BFREE going to a logic '1' (high)	Any	1

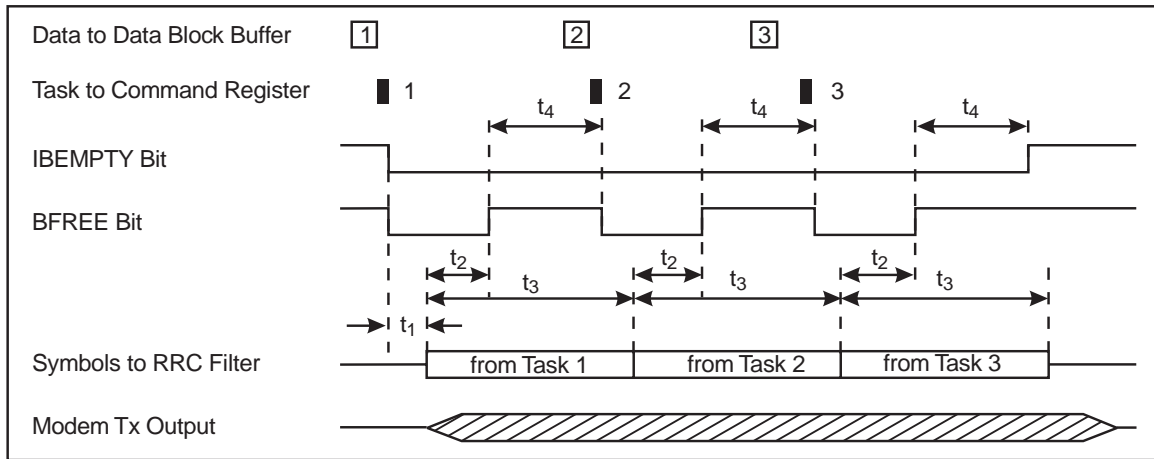

Figure 11: Transmit Task Timing Diagram

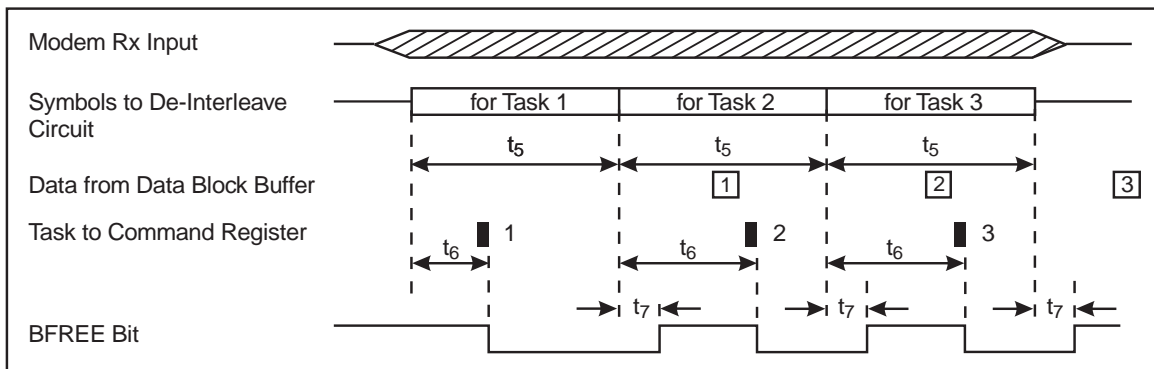

Figure 12: Receive Task Timing Diagram

4.5.2.22 RRC Filter Delay

The previous task timing figures are based on the signal at the input to the RRC filter (in transmit mode) or the input to the de-interleave buffer (in receive mode). There is an additional delay of about 8 symbol times through to the RRC filter in both transmit and receive modes, as illustrated below:

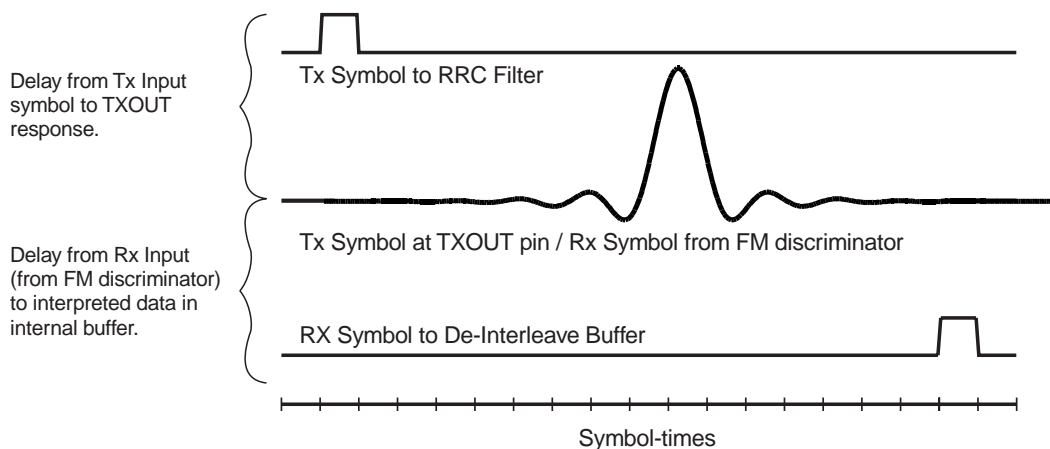
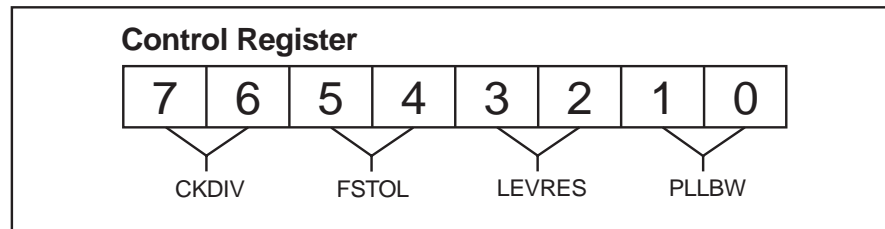

Figure 13: RRC Low Pass Filter Delay

4.5.3 Control Register

This 8-bit write-only register controls the modem's symbol rate, the response times of the receive clock extraction, signal level measurement circuits, and the Frame Sync pattern recognition tolerance to inexact matches.



4.5.3.1 Control Register B7, B6: CKDIV - Clock Division Ratio

These bits control a frequency divider driven from the clock signal present at the \overline{XTAL} pin, therefore determining the nominal symbol rate. Because each symbol represents two bits, bit rates are 2x the symbol rates. The table below shows how symbol rates of 2400/4800/9600 symbols/sec (4800/9600/19200bps) may be obtained from common Xtal frequencies:

		Xtal Frequency (MHz)			
		2.4576	4.9152	9.8304	
B7	B6	Division Ratio: Xtal Frequency/Symbol Rate	Symbol Rate (symbols/sec) / Bit Rate (bps)		
0	0	512	4800/9600	9600/19200	
0	1	1024	2400/4800	4800/9600	9600/19200
1	0	2048		2400/4800	4800/9600
1	1	4096			2400/4800

Note: Device operation is not guaranteed below 2400 symbols/sec (4800bps) or above 9600 symbols/sec (19200bps).

4.5.3.2 Control Register B5, B4: FSTOL - Frame Sync Tolerance to Inexact Matches

These two bits have no effect in transmit mode. In receive mode, they define the maximum number of mismatches allowed during a search for the Frame Sync pattern:

B5	B4	Mismatches allowed
0	0	0
0	1	2
1	0	4
1	1	6

Note: A single 'mismatch' is defined as the difference between two adjacent symbol levels, thus if the symbol '+1' were expected, then received symbol values of '+3' and '-1' would count as 1 mismatch, a received symbol value of '-3' would count as 2 mismatches. A setting of '4 mismatches' is recommended for normal use.

4.5.3.3 Control Register B3, B2: LEVRES - Level Measurement Modes

These two bits have no effect in transmit mode. In receive mode they set the 'normal' or 'steady state' operating mode of the Rx signal amplitude and DC offset measuring and tracking circuits. These circuits analyze the Rx signal envelope and charge the DOC1 and DOC2 capacitors to 'store' signal maximum and minimum references that are used in the data reception process. This setting is temporarily overridden during the automatic sequencing triggered by an AQLEV command when level is initially being acquired as described in Section 5.3 Clock Extraction and Level Measurement Systems.

B3	B2	Mode
0	0	Hold
0	1	Level Track
1	0	Lossy Peak Detect
1	1	Slow Peak Detect

In normal use the LEVRES bits should be set to '0 1' (Level Track). The other modes are intended for special purposes, for device testing, or are invoked automatically during an AQLEV sequence.

In 'Slow Peak Detect' modes, the positive and negative excursions of the received signal (after filtering) are measured by peak rectifiers driving the DOC1 and DOC2 capacitors to establish the amplitude of the signal and any DC offset with regards to V_{BIAS} . This mode provides good overall performance, particularly when acquiring level information at the start of a received message, but does not work as well with certain long sequences of repeated data byte values. It is also susceptible to large amplitude noise spikes, which can be caused by deep fades.

The 'Lossy Peak Detect' mode is similar to 'Slow Peak Detect' but the capacitor discharge time constant is much shorter so this mode is not suitable for normal data reception and is only used within part of the automatic AQLEV acquisition sequence.

In 'Level Track' mode the DOC capacitor voltages are slowly adjusted by the MX929B in such a way as to minimize the average errors seen in the received signal. This mode provides the best overall performance, being much more accurate than 'Slow Peak Detect' when receiving large amplitude noise spikes on long sequences of repeated data byte values. It does, however, depend on the measured levels and timing being approximately correct. If either of these is significantly wrong then the correction algorithm used by the 'Level Track' mode can actually drive the voltages on the DOC capacitors away from their optimum levels. For this reason, the automatic AQLEV acquisition sequence (see Section 5.3 Clock Extraction and Level Measurement Systems) forces the level measuring circuits into 'Slow Peak Detect' mode until a Frame Sync pattern has been found.

In 'HOLD' mode the DOC Capacitors are isolated from the charging and discharging circuits, allowing their voltages to remain constant.

4.5.3.4 Control Register B1, B0: PLLBW - Phase-Locked Loop Bandwidth Modes

These two bits have no effect in transmit mode. In receive mode, they set the 'normal' or 'steady state' bandwidth of the Rx clock extraction Phase Locked Loop circuit. The PLL circuit synchronizes itself with the Rx Signal to develop a local clock signal used in the data clock recovery process. This setting will be temporarily overridden during the automatic sequencing of an AQSC command when Rx clock extraction circuits are initially being trained as described in Section 5.3 Clock Extraction and Level Measurement Systems.

B1	B0	PLL Mode
0	0	Hold
0	1	Narrow Bandwidth
1	0	Medium Bandwidth
1	1	Wide Bandwidth

The normal setting for the PLLBW bits should be 'Medium Bandwidth' when the received symbol rate and the frequency of the receiving modem's crystal are both within ± 100 ppm of nominal, except at the start of a symbol clock acquisition sequence (AQSC) when 'Wide Bandwidth' should be selected as described in Section 5.3 Clock Extraction and Level Measurement Systems.

If the received symbol rate and the crystal frequency are both within ± 20 ppm of nominal then selection of the 'Narrow Bandwidth' setting will provide better performance especially through fades or noise bursts which may otherwise pull the PLL away from its optimum timing. In this case however; it is recommended that the PLLBW bits only be set to 'Narrow Bandwidth' after the modem has been running in 'Medium Bandwidth' mode for about 200 symbol times to ensure accurate lock has first been achieved.

The 'Hold' setting disables the feedback loop of the PLL which continues to run at a rate determined only by the actual crystal frequency and the setting of the Control Register CKDIV bits, not the PLL's operating frequency immediately prior to the 'Hold' setting.

4.5.4 Mode Register

The contents of this 8-bit write only register control the basic operating modes of the modem:

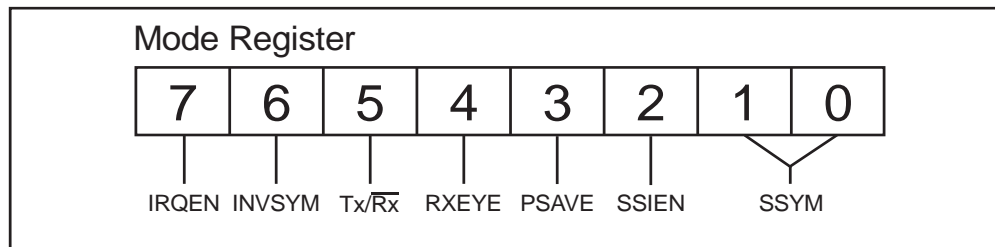

4.5.4.1 Mode Register B7: IRQEN - $\overline{\text{IRQ}}$ Output Enable

When this bit is set to '1', the $\overline{\text{IRQ}}$ chip output pin is pulled low (V_{SS}) given the IRQ bit of the Status Register is a '1'.

4.5.4.2 Mode Register B6: INVSYM - Invert Symbols

This bit controls the polarity of the transmitted and received symbol voltages.

B6	Symbol	Signal at TXOUT	Signal at RXAMPOUT
0	'+3'	Above V_{BIAS}	Below V_{BIAS}
	'-3'	Below V_{BIAS}	Above V_{BIAS}
1	'+3'	Below V_{BIAS}	Above V_{BIAS}
	'-3'	Above V_{BIAS}	Below V_{BIAS}

Note: B6 must be normally set to the same value in Tx and Rx devices for successful communication between them.

4.5.4.3 Mode Register B5: TX/RX - Tx/Rx Mode

Setting this bit to '1' places the modem into the Transmit mode, clearing it to '0' puts the modem into the Receive mode.

Note: Changing between receive and transmit modes will cancel any current task.

4.5.4.4 Mode Register B4: RXEYE - Show Rx Eye

This bit should normally be set to '0'. Setting it to '1' when the modem is in receive mode configures the modem for a special test mode, in which the input of the Tx output buffer is connected to the Rx Symbol/Clock extraction circuit at a point which carries the equalized receive signal. This may be monitored with an oscilloscope (at the TXOUT pin itself), to assess the quality of the complete radio channel including the Tx and Rx modem filters, the Tx modulator and the Rx IF filters, and FM demodulator.

This mode is provided because observation of the direct discriminator output of a root raised cosine Tx filtered signal (before Rx equalization) is not very recognizable so it is generally not useful.

The resulting eye diagram (for reasonably random data) should ideally be as shown Figure 14, with 4 distinct and equally spaced level crossing points.

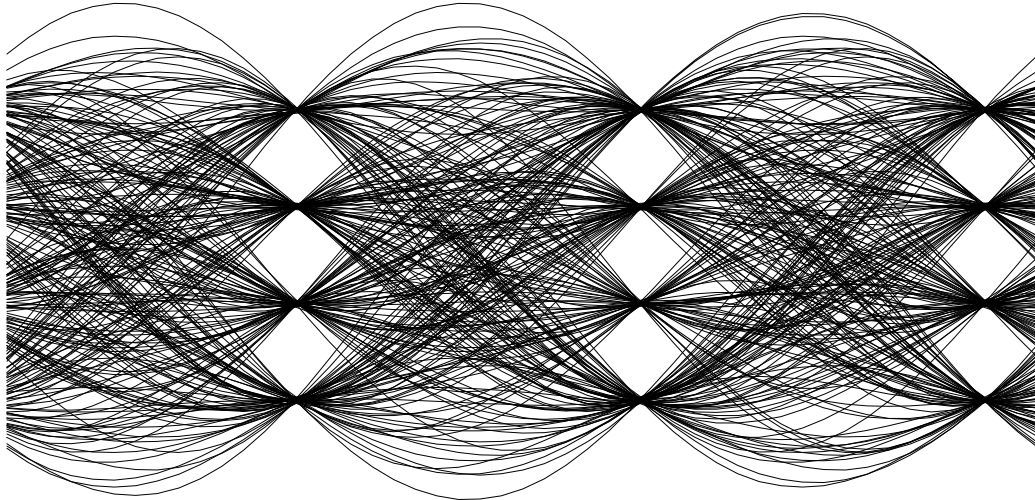

Figure 14: Ideal 'RXEYE' Signal

4.5.4.5 Mode Register B3: PSAVE - Powersave

When this bit is a '1', the modem will be in a 'powersave' mode in which the internal filters, the Rx Symbol and Clock extraction circuits, and the Tx output buffer will be disabled. The TXOUT pin will be connected to V_{BIAS} through a high value internal resistance. The Xtal clock oscillator, Rx input amplifier and the μC interface logic will continue to operate.

Setting the PSAVE bit to '0' restores power to all of the chip circuitry.

Note: The internal filters, and therefore the TXOUT pin in transmit mode, will take approximately 20 symbol-times to settle after the PSAVE bit has gone from '1' to '0'.

4.5.4.6 Mode Register B2: SSIEN - 'S' Symbol IRQ Enable

In receive mode, setting this bit to '1' causes the IRQ bit of the Status Register to be set to '1' whenever a new 'S' symbol has been received. (The SRDY bit of the Status Register will also be set to '1' at the same time, and the SVAL bits updated to reflect the received 'S' symbol.)

In transmit mode, setting this bit to '1' causes the IRQ bit of the Status Register to be set to '1' whenever a 'S' symbol has been transmitted. (The SRDY bit of the Status Register will also be set to '1' at the same time.)

4.5.4.7 Mode Register B1, B0: SSYM - 'S' Symbol To Be Transmitted

In transmit mode, these two bits define the next 'S' symbol to be transmitted. These bits have no effect in receive mode.

4.5.5 Status Register

This register may be read by the μC to determine the current state of the modem.

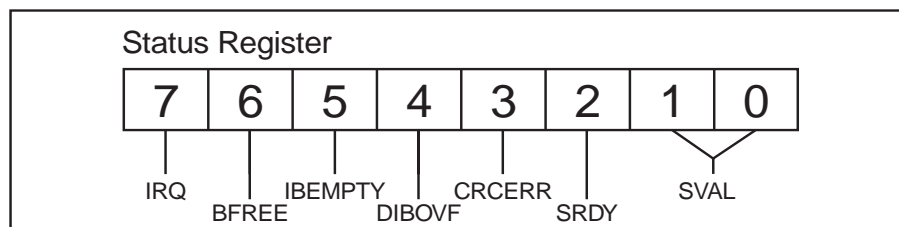

4.5.5.1 Status Register B7: IRQ - Interrupt Request

This bit is set to '1' by:

- The Status Register BFREE bit going from '0' to '1', unless this is caused by a RESET task or by a change to the Mode Register TX/RX or PSAVE bits
- or The Status Register IBEMPTY bit going from '0' to '1', unless this is caused by a RESET task or by changing the Mode Register TX/RX or PSAVE bits.
- or The Status Register DIBOVF bit going from '0' to '1'.
- or The Status Register SRDY bit being set to '1' (due to a 'S' symbol being received or transmitted) if the Mode Register SSIEN bit is '1'.

The IRQ bit is cleared to '0' immediately after a read of the Status Register.

If the IRQEN bit of the Mode Register is '1', then the chip $\overline{\text{IRQ}}$ output will be pulled low (V_{SS}) when the IRQ bit is set to '1', and will go high impedance when the Status Register is read.

4.5.5.2 Status Register B6: BFREE - Data Block Buffer Free

This bit reflects the availability of the Data Block Buffer and is cleared to '0' when a task other than NULL or RESET is written to the Command Register.

In transmit mode, the BFREE bit will be set to '1' (also setting the Status Register IRQ bit to '1') by the modem when the modem is ready for the μC to write new data to the Data Block Buffer and the next task to the Command Register.

In receive mode, the BFREE bit is set to '1' (also setting the Status Register IRQ bit to '1') by the modem when it has completed a task and any data associated with that task has been placed into the Data Block Buffer. The μC may then read that data and write the next task to the Command Register.

The BFREE bit is also set to '1' - but without setting the IRQ bit - by a RESET task or when the Mode Register TX/RX or PSAVE bits are changed.

4.5.5.3 Status Register B5: IBEMPTY - Interleave Buffer Empty

In transmit mode, this bit will be set to '1' - also setting the IRQ bit - when less than two symbols remain in the Interleave Buffer. Any transmit task written to the modem after this bit goes to '1' will be too late to avoid a gap in the transmit output signal.

The bit is also set to '1' by a RESET task or by a change of the Mode Register TX/RX or PSAVE bits, but in these cases the IRQ bit will not be set.

The bit is cleared to '0' within one symbol time after a task other than NULL or RESET is written to the Command Register.

Note: When the modem is in transmit mode and the Interleave Buffer is empty, a mid-level (halfway between '+1' and '-1') signal will be sent to the RRC filter.

In receive mode this bit will be '0'.

4.5.5.4 Status Register B4: DIBOVF - De-Interleave Buffer Overflow

In receive mode this bit will be set to '1' - also setting the IRQ bit - when a RHB, RILB, RSID, or R4S task is written to the Command Register too late to allow continuous reception.

The bit is cleared to '0' immediately after reading the Status Register, by writing a RESET task to the Command Register or by changing the TX/RX or PSAVE bits of the Mode Register.

In transmit mode this bit is '0'.

4.5.5.5 Status Register B3: CRCERR - CRC Checksum Error

In receive mode, this bit will be updated at the end of a SFP, RHB, RILB, or RSID task to reflect the result of the receive CRC check. '0' indicates that the CRC was received correctly, '1' indicates an error.

Note: This bit should be ignored when an 'Intermediate' block (which does not have an integral CRC) is received.

The bit is cleared to '0' by a RESET task or by changing the TX/RX, or PSAVE bits of the Mode Register. In transmit mode this bit is '0'.

4.5.5.6 Status Register B2: 'S' Symbol Ready

In receive mode, this bit is set to '1' whenever an 'S' symbol has been received. The μ C may then read the value of the symbol from the SVAL field of the Status Register. In transmit mode, this bit is set to '1' whenever an 'S' symbol has been transmitted.

The bit is cleared to '0' immediately after a read of the Status Register, by a RESET task or by changing the TX/ $\overline{\text{RX}}$ or PSAVE bits of the Mode Register.

4.5.5.7 Status Register B1, B0: SVAL - Received 'S' Symbol Value

In receive mode, these two bits reflect the value of the latest received 'S' symbol. In transmit mode, these two bits will be '0'.

4.5.6 Data Quality Register

In receive mode, the MX929B continually measures the 'quality' of the received signal, by comparing the actual received waveform over the previous 64 symbol times against an internally generated 'ideal' 4-level FSK baseband signal.

The result is placed into bits 3-7 of the Data Quality Register for the μ C to read at any time, bits 0-2 being always set to '0'. Figure 15 shows how the value (0-255) read from the Data Quality Register varies with received signal-to-noise ratio:

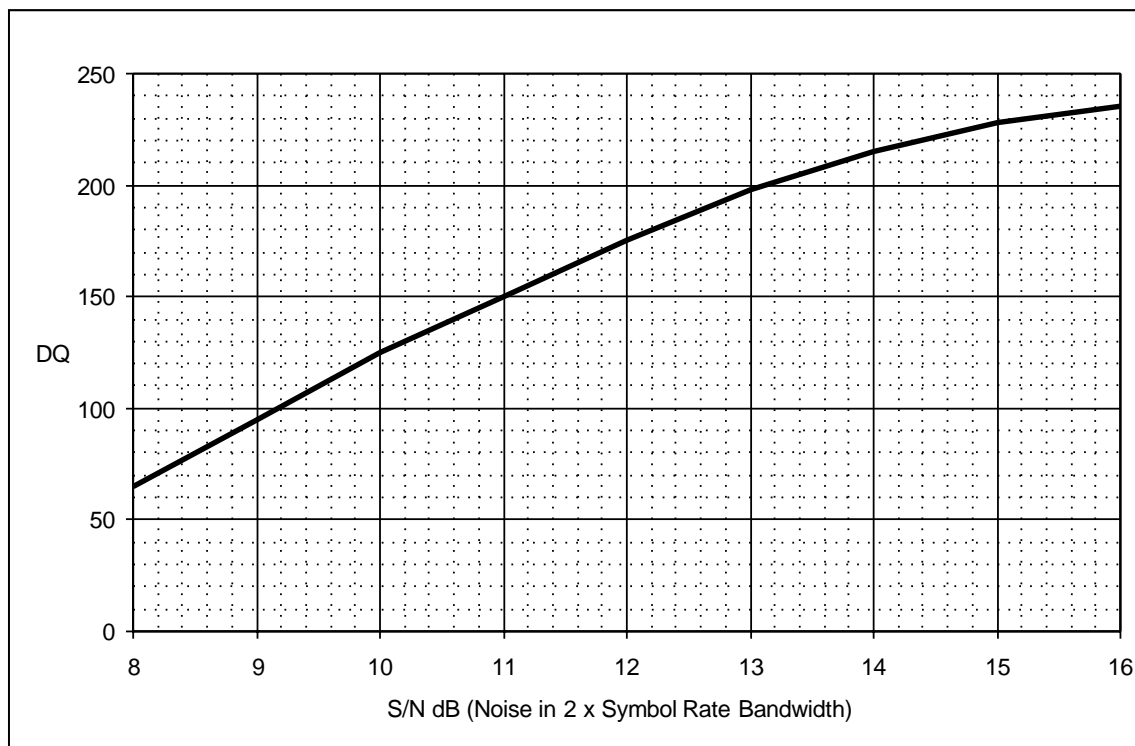

Figure 15: Typical Data Quality Reading vs S/N

The Data Quality readings are only valid when the modem has successfully acquired signal level and timing lock for at least 64 symbol times. It is invalid when an AQSC or AQLEV sequence is being performed or when the LEVRES setting is 'Lossy Peak Detect'. A low reading will be obtained if the PLLBW bits are set to 'Wide' or if the received signal waveform is distorted in any significant way.

Section 5.6 Received Signal Quality Monitor describes how monitoring the Data Quality reading can help improve the overall system performance in some applications.

4.6 CRC, FEC and Interleaving

4.6.1 Cyclic Redundancy Codes

4.6.1.1 CRC0

This is a six-bit CRC check code used in the Station ID Block. It is calculated by the modem from the first 24 bits of the block (Bytes 0, 1, and 2) as follows:

The 24 bits are considered as the coefficients of a polynomial $M(x)$ of degree 23 such that the MSB bit (7) of byte 0 is the coefficient of x^{23} , and bit 0 of byte 2 is the coefficient of x^0 .

The polynomial $F(x)$ of degree 5 is calculated as being the remainder of the modulo-2 division.

$$\frac{x^6 M(x)}{(x^6 + x^4 + x^3 + 1)}$$

The polynomial $x^5 + x^4 + x^3 + x^2 + x^1 + x^0$ is added (modulo-2) to $F(x)$.

The coefficients of $F(x)$ are placed in the 6-bit CRC0 field, such that the coefficient of x^5 corresponds to the MSB of CRC0

4.6.1.2 CRC1

This is a sixteen-bit CRC check code contained in bytes 10 and 11 of the Header Block, which provides error detection coverage for the Header Block of a message. It is calculated by the modem from the first 80 bits of the Header Block (Bytes 0 to 9 inclusive) using the generator polynomial:

$$x^{16} + x^{12} + x^5 + 1$$

4.6.1.3 CRC2

This is a thirty-two-bit CRC check code contained in bytes 8 to 11 of the 'Last' Block, which provides error detection coverage for the combined Intermediate Blocks and Last Block of a message. It is calculated by the modem from all of the data and pad bytes in the Intermediate Blocks and in the first 8 bytes of the Last Block using the generator polynomial:

$$x^{32} + x^{26} + x^{23} + x^{22} + x^{16} + x^{12} + x^{11} + x^{10} + x^8 + x^7 + x^5 + x^4 + x^2 + x^1 + 1$$

Note: In receive mode the CRC2 checksum circuits are initialized on completion of any task other than NULL or RILB. In transmit mode the CRC2 checksum circuits are initialized on completion of any task other than NULL, TIB, or TLB.

Command Register bit B5 (CRC) allows the user to select between two different forms of the CRC0, CRC1 and CRC2 checksums. When this bit is set to '1' the CRC generators are initialized to 'all zeros', as required by RD-LAP™ systems. When this bit is set to '0', the CRC generators are initialized to 'all ones' for calculations such as CCITT X25 based systems. It should always be set to '1' for RD-LAP™ compatibility, other systems may set this bit as required.

4.6.1.4 Forward Error Correction

In transmit mode, the MX929B uses a Trellis Encoder to translate the 96 bits (12 bytes) of a 'Header', 'Intermediate', 'Last' Block, into a 66 symbol (132 bits) sequence which includes FEC information. Station ID Blocks (30 bits) are translated into a 22 symbol (44 bit) sequence which includes FEC information.

In receive mode, the MX929B decodes the received 22 or 66 symbols of a block into 30 or 96 bits of binary data using a 'Soft Decision' Viterbi algorithm to perform decoding and error correction.

4.6.1.5 Interleaving

The 66 symbols of a 'Header', 'Intermediate' or 'Last' block are interleaved by the modem before transmission (and before the 'S' symbols are added) to provide protection against the effects of noise bursts and short fades. The 22 symbols of a 'Station ID' Block are not interleaved.

In receive mode, the MX929B strips out the 'S' symbols and then de-interleaves the received symbols. FEC and decoding follow.

4.7 Transmitted Symbol Shape

Bit 4 of the Command Register (TXIMP) selects the transmit baseband signal and the receive signal equalization as follows:

If the TXIMP bit is '0', then the transmit baseband signal is generated by feeding full-symbol-time-width 4-level symbols into the RRC lowpass filter and the receive signal equalization is optimized for this type of signal. With this setting, the MX929B is compatible with the MX929A device, another member of the MX929 device family.

If the TXIMP bit is set to '1,' impulses, rather than full-symbol-time-width symbols are fed into the RRC filter when in TX mode and the receive signal equalization is suitably adjusted in RX mode.

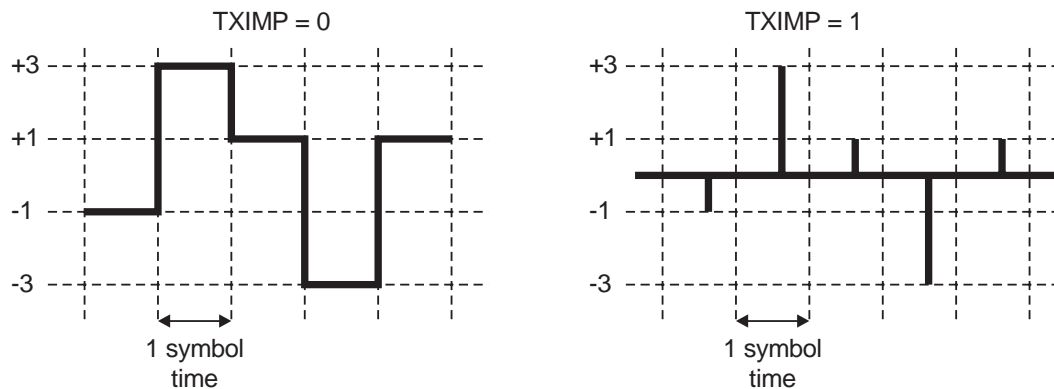

Figure 16: Input Signal to RRC Filter in Tx Mode for TXIMP = 0 and 1

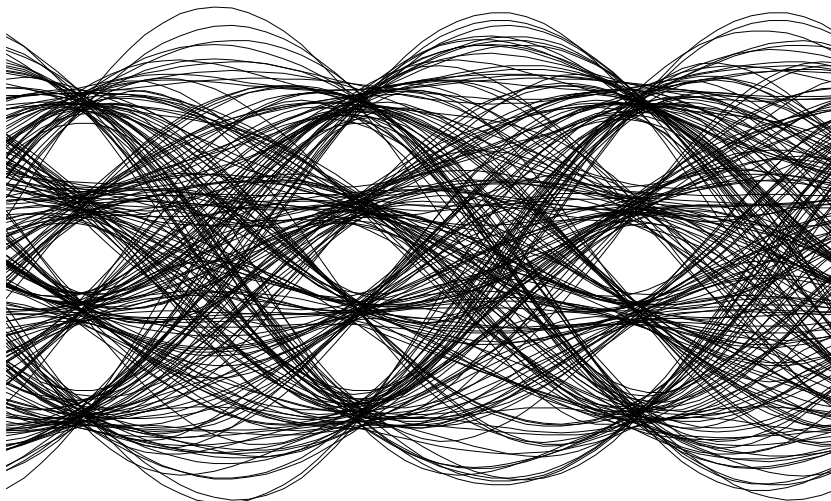

Figure 17: Tx Signal Eye TXIMP = 0

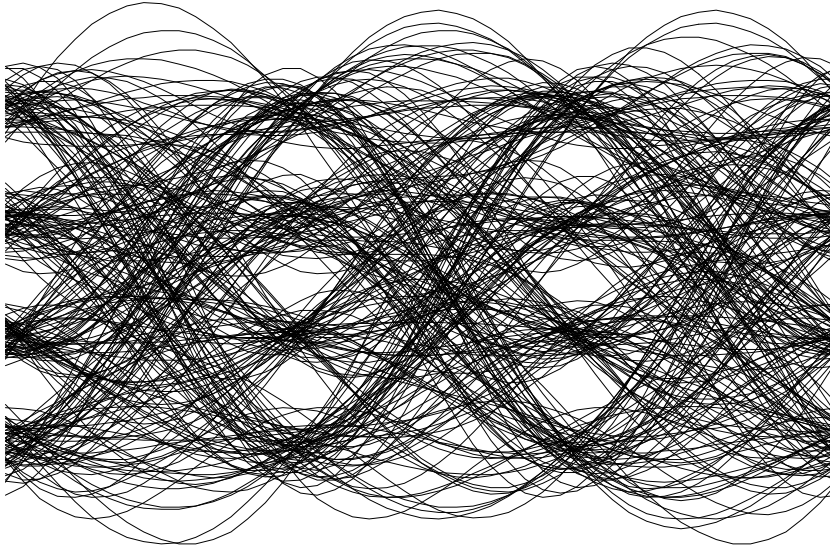

Figure 18: Tx Signal Eye TXIMP = 1

Note: Setting TXIMP to '1' affects the Tx output signal level as shown in Section 6.1 Electrical Performance and the table below.

	TXIMP = 0	TXIMP = 1
Nominal Voltage difference between continuous '+3' and continuous '-3' symbol outputs.	0.157V _{DD}	0.157V _{DD}
Nominal V _{P-P} for continuous '+3 +3 -3 -3...' symbol pattern.	0.20V _{DD}	0.22V _{DD}

5 Application

5.1 Transmit Frame Example

The operations needed to transmit a single Frame consisting of Symbol and Frame Sync sequences, and one each Header, Intermediate and Last blocks are provided below:

1. Ensure that the Control Register has been loaded with a suitable CKDIV value, that the IRQEN and TX/ $\overline{\text{RX}}$ bits of the Mode Register are '1', the RXEYE, PSAVE, and SSIEN bits are '0', and the INVSYM bit is set appropriately.
2. Read the Status Register to ensure that the BFREE bit is '1', then write 6 Symbol Sync bytes (a preamble) to the Data Block Buffer and a T24S task to the Command Register.
3. Wait for an interrupt from the modem, read the Status Register; the IRQ and BFREE bits should be '1' and the IBEMPTY bit should be '0'.
4. Write the 6 byte Frame Sync to the Data Block Buffer and a T24S task to the Command Register.
5. Wait for an interrupt from the modem, read the Status Register; the IRQ and BFREE bits should be '1' and the IBEMPTY bit should be '0'.
6. Write 3 Station ID bytes to the Data Block Buffer and a TSID task to the Command Register.
7. Wait for an interrupt from the modem, read the Status Register; the IRQ and BFREE bits should be '1' and the IBEMPTY bit should be '0'.
8. Write 10 Header Block bytes to the Data Block Buffer and a THB task to the Command Register.
9. Wait for an interrupt from the modem, read the Status Register; the IRQ and BFREE bits should be '1' and the IBEMPTY bit should be '0'.
10. Write 12 Intermediate Block bytes to the Data Block Buffer and a TIB task to the Command Register.
11. Wait for an interrupt from the modem, read the Status Register; the IRQ and BFREE bits should be '1' and the IBEMPTY bit should be '0'.
12. Write 8 Last Block bytes to the Data Block Buffer and a TLB task to the Command Register.
13. Wait for an interrupt from the modem, read the Status Register; the IRQ and BFREE bits should be '1' and the IBEMPTY bit should be '0'.
14. Wait for another interrupt from the modem, read the Status Register; the IRQ, BFREE and IBEMPTY bits should be '1'.

Notes:

1. The final symbol of the frame will start to appear approximately 2 symbol times after the Status Register IBEMPTY bit goes to '1'; a further 16 symbol times should be allowed for the symbol to pass completely through the RRC filter.
2. The SSYM bits of the Mode Register may be altered at any time to change the transmitted 'S' symbols. If a timing reference is required, then setting the Mode Register SSIEN bit to '1' will cause a μC interrupt after every 'S' symbol transmitted, in which case the μC will have to distinguish between interrupts caused by the BFREE bit going to '1', and those caused by the SRDY bit being set to '1'.
3. Figure 19 and Figure 20 illustrate the host μC routines needed to send a single Frame consisting of Symbol and Frame Sync patterns, a Station ID Block, a Header block, and any number of Intermediate blocks and one Last Block. It is assumed that the Tx Interrupt Service Routine Figure 20 is called every time the MX929B $\overline{\text{IRQ}}$ output line goes low.

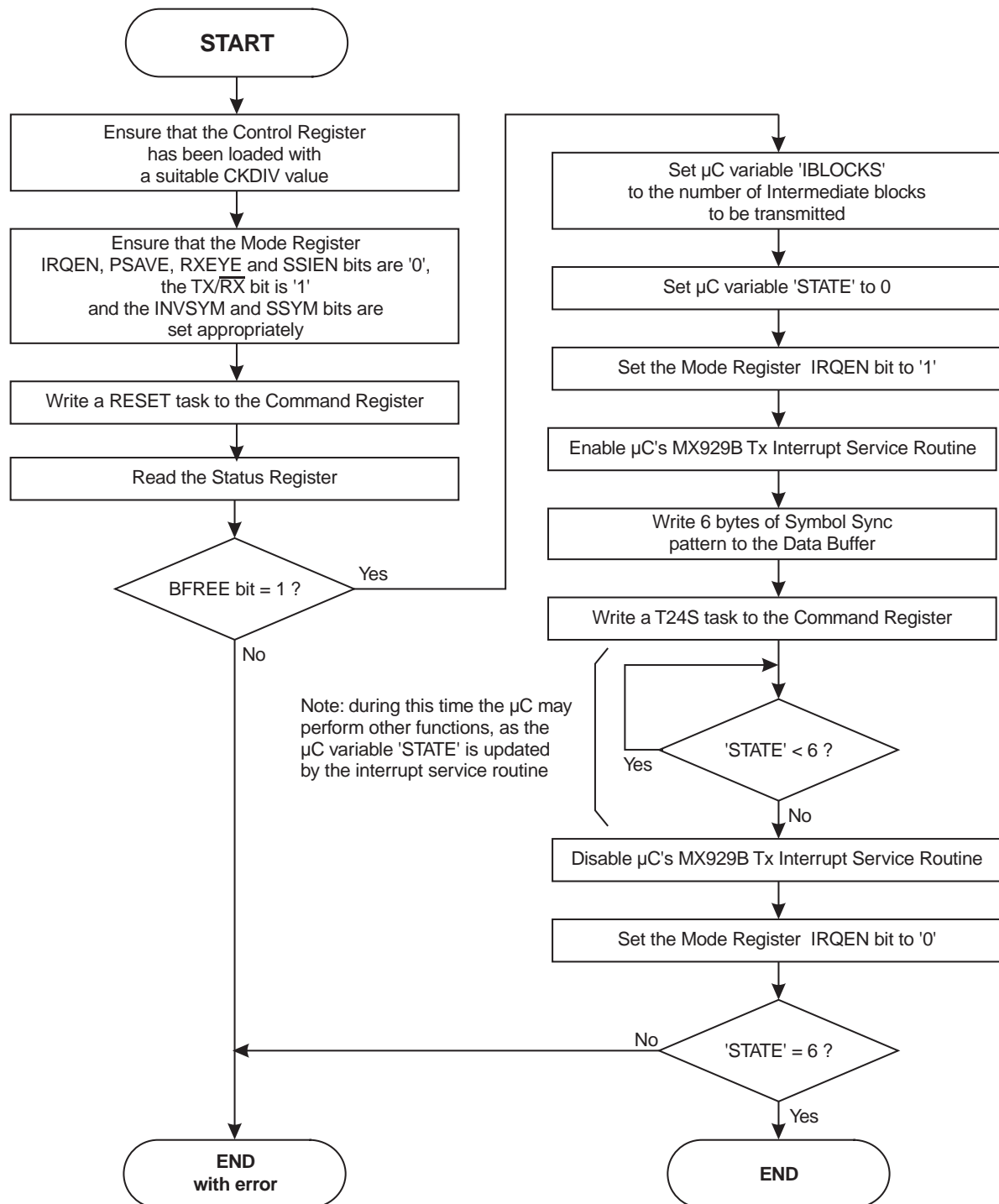

Figure 19: Transmit Frame Example Flowchart, Main Program

Notes:

1. The RESET command in Figure 19 and the practice of disabling the MX929B's $\overline{\text{IRQ}}$ output when not needed are not essential but can eliminate problems during debugging and if errors occur in operation
2. The CRC and TXIMP bits should be set appropriately every time a byte is written to the Command Register.

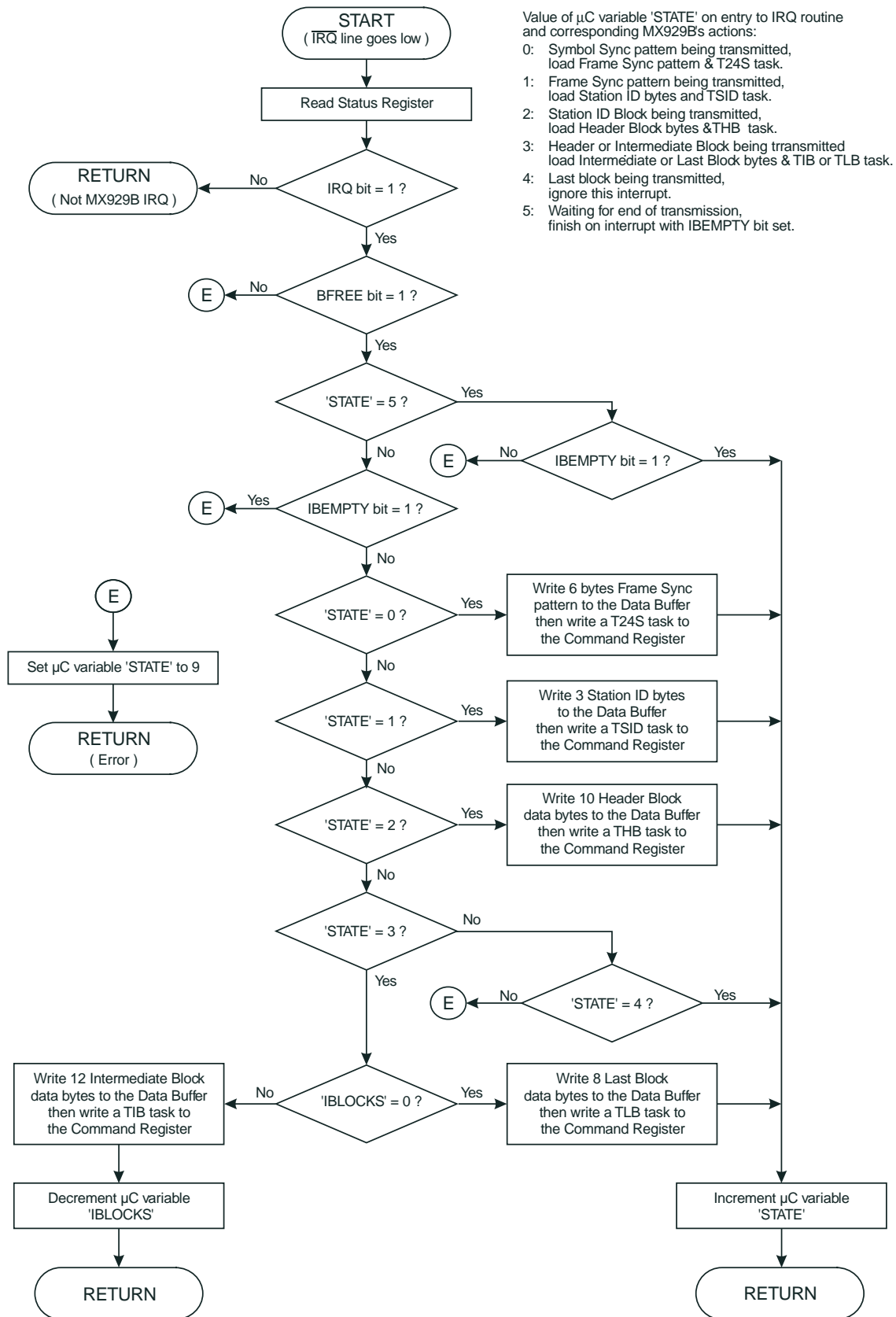

Figure 20: Tx Interrupt Service Routine

5.2 Receive Frame Example

The operations needed to receive a single Frame consisting of Symbol and Frame Sync sequences, Station ID Block, and one each Header, Intermediate and Last blocks are shown below;

1. Ensure that the Control Register has been loaded with suitable CKDIV, FSTOL, LEVRES and PLLBW values, and that the IRQEN bit of the Mode Register is '1', the TX/ $\overline{\text{RX}}$, RXEYE, PSAVE, and SSIEN bits are '0', and the INVSYM bit is set appropriately.
2. Wait until the received carrier has been present for at least 8 symbol times (see Section 5.3 Clock Extraction and Level Measurement Systems).
3. Read the Status Register to ensure that the BFREE bit is '1'.
4. Write a byte containing a SFP task and with the AQSC and AQLEV bits set to '1' to the Command Register.
5. Wait for an interrupt from the modem, read the Status Register; the IRQ and BFREE bits should be '1' and the CRCERR and DIBOVF bits should be '0'.
6. Read 3 Station ID bytes from the Data Block Buffer.
7. Write a RHB task to the Command Register.
8. Wait for an interrupt from the modem, read the Status Register; the IRQ and BFREE bits should be '1' and the DIBOVF bit '0'.
9. Check that the CRCERR bit of the Status Register is '0' and read 10 Header Block bytes from the Data Block Buffer.
10. Write a RILB task to the Command Register.
11. Wait for an interrupt from the modem, read the Status Register; the IRQ and BFREE bits should be '1' and the DIBOVF bit '0'.
12. Read 12 Intermediate Block bytes from the Data Block Buffer.
13. Write a RILB task to the Command Register.
14. Wait for an interrupt from the modem, read the Status Register; the IRQ and BFREE bits should be '1' and the DIBOVF bit '0'.
15. Check that the CRCERR bit of the Status Register is '0' and read the 8 Last Block bytes from the Data Buffer.

Note:

1. The value of the latest 'S' symbol received will be contained in the SVAL bits each time the Status Register is read. If desired, the Mode Register SSIEN bit may be set to '1', which will cause a μC interrupt after every 'S' symbol received, in which case the μC will have to distinguish between interrupts caused by the BFREE bit going to '1' and those caused by SRDY bit being set to '1'.
2. Figure 21 and Figure 22 illustrate the host μC routines needed to receive a single Frame consisting of Symbol and Frame Sync patterns, a Station ID Block, a Header Block, any number of Intermediate blocks and one Last block. It is assumed that the Rx Interrupt Service Routine Figure 22 is called every time the MX929B's $\overline{\text{IRQ}}$ output goes low.

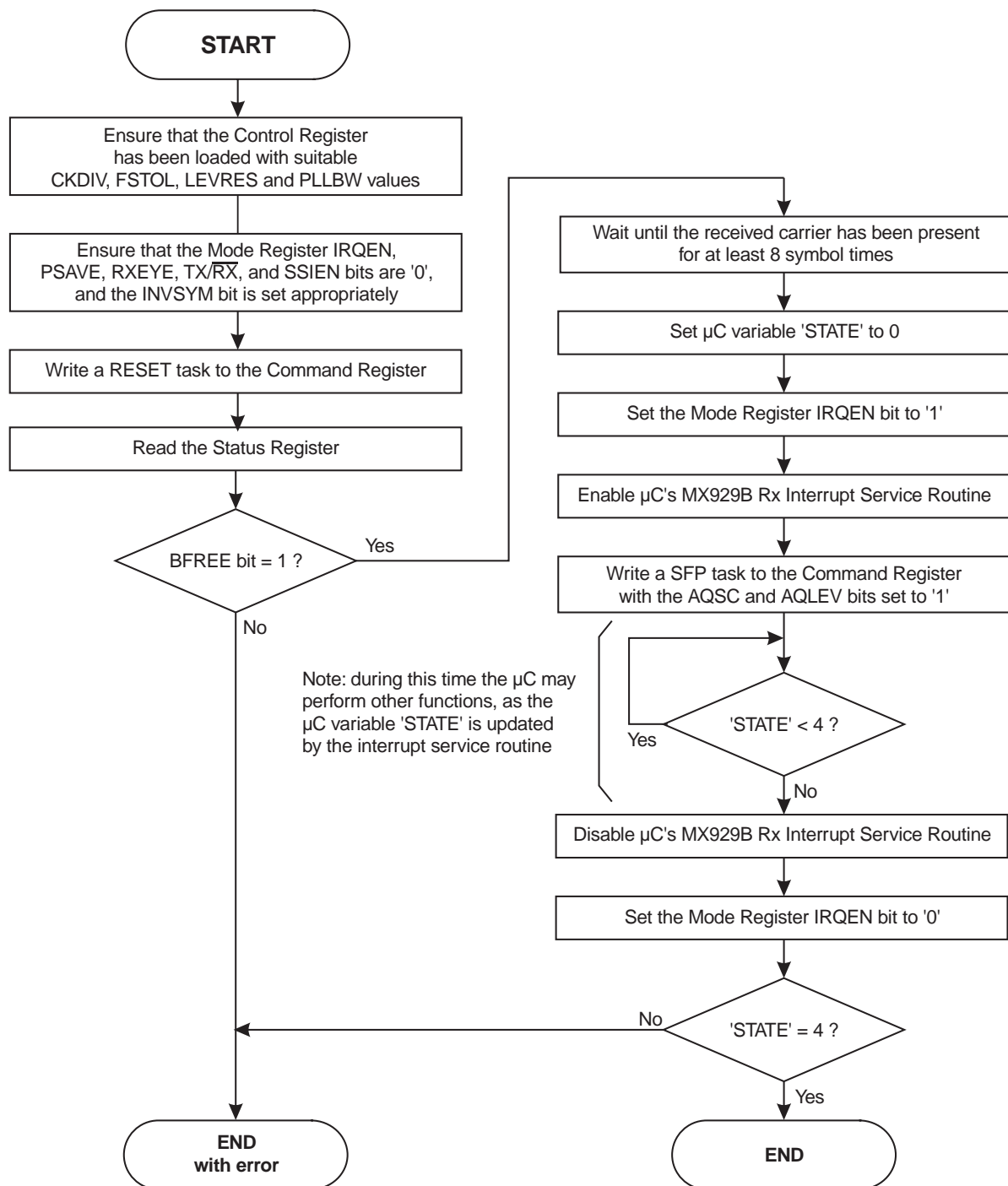

Figure 21: Receive Frame Example Flowchart, Main Program

Notes

1. The RESET command in Figure 21 and the practice of disabling the MX929B's $\overline{\text{IRQ}}$ output when not needed are not essential but can eliminate problems during debugging and if errors occur in operation.
2. The CRC and TXIMP bits should be set appropriately every time a byte is written to the Command Register.

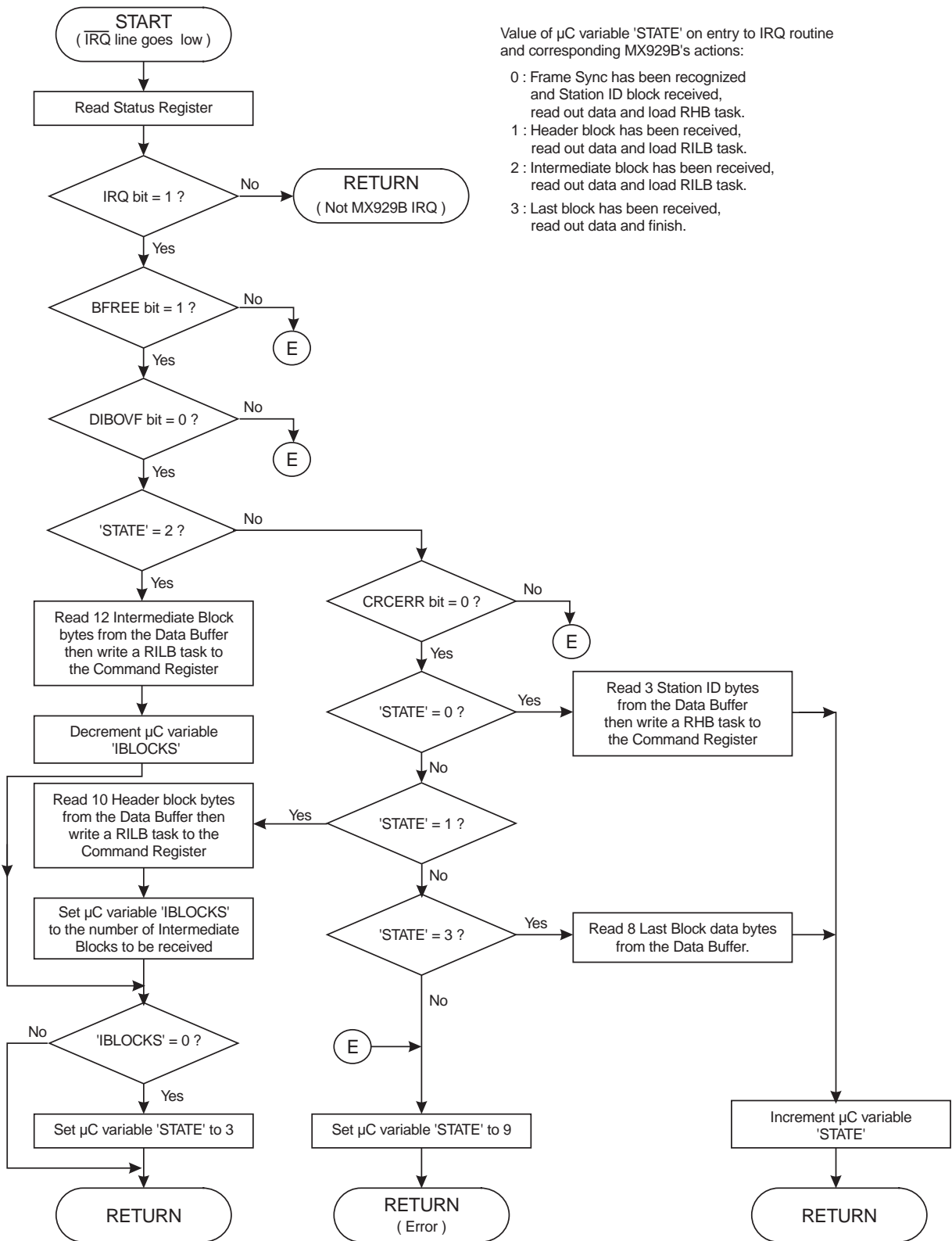

Figure 22: Rx Interrupt Service routine

Note: This routine assumes that the number of Intermediate blocks in the Frame is contained within the Header Block Data.

5.3 Clock Extraction and Level Measurement Systems

5.3.1 Supported Types of Systems

The MX929B is intended for use in systems where:

1. The Symbol Sync pattern is transmitted immediately on start-up of the transmitter, before the first Frame Sync pattern (see Figure 23).
2. A Base Station may remain powered up indefinitely, transmitting concatenated Frames with or without intervening Symbol Sync patterns (each Frame starting with the Frame Sync pattern and symbol timing being maintained from one Frame to the next).
3. A receiving modem may be switched onto a channel before the distant transmitter has started up or may be switched onto a channel where the transmitting station is already sending concatenated Frames.

5.3.2 Clock and Level Acquisition Procedures with RF Carrier Detect

When the receiving modem is enabled or switched onto a channel, it needs to establish the received symbol levels, clock timing, and look for a Frame Sync pattern in the incoming signal. This is best done by the following procedure:

1. Ensure that the Control Register's PLLBW bits are set to 'Wide' and the LEVRES bits to 'Level Track'.
2. Wait until a received carrier has been present for 8 symbol times. This 8-symbol delay gives time for the received signal to propagate through the modem's RRC filter. An 'RF received 8 symbol times' qualifying function can be included in a radio's carrier detect circuitry to take this into account.
3. Write a SFS or SFP task to the Command Register with the AQSC and the AQLEV bits set to '1'.
4. When the modem interrupts to signal that it has recognized a Frame Sync pattern (or completed the SFP task) then change the PLLBW bits to 'Medium'.

Once the receiving modem has achieved level and symbol timing synchronization with a particular channel - as evidenced by recognition of a Frame Sync pattern - then subsequent concatenated Frames can be read by simply issuing SFS or SFP tasks at appropriate times, keeping the ASQSC and AQLEV bits at zero, and the PLLBW and LEVRES bits at their current 'Medium' and 'Level Track' settings, respectively.

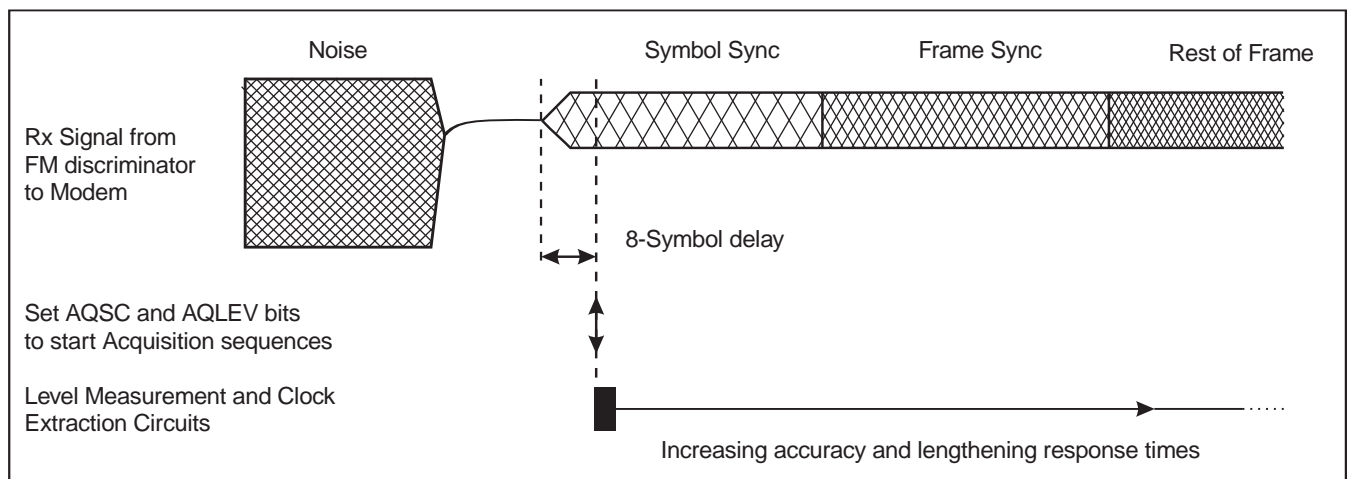

Figure 23: Acquisition Sequence Timing

5.3.3 Clock and Level Acquisition Procedure without RF Carrier Detect

It is also possible to use the modem in a non-standard system where there is an indeterminate delay between the RF transmitter turn on time and the transmission moment of the Symbol Sync pattern, or where a receive carrier detect signal is not available to the controlling μC , or where the transmitting terminal can send separate unsynchronized Frames. In these cases, each Frame should be preceded by a Symbol Sync pattern which should be extended to about 100 symbols and the procedure provided in Section 5.3.2 Clock and Level Acquisition Procedures with RF Carrier Detect used.

5.3.4 Automatic Acquisition Functions

Setting the AQSC and AQLEV bits to '1' triggers the modem's automatic Symbol Clock Extraction and Level Measurement acquisition sequences, which are designed to measure the received symbol timing, amplitude, and DC offset as quickly as possible before switching to accurate - but slower - measurement modes. These acquisition sequences act very quickly if triggered at the start of a received Symbol Sync pattern (as shown in Figure 23), but will still function correctly, although more slowly, if started any time during a normal Frame as when the receiver is switched onto a channel where the transmitter is operating continuously.

The automatic AQLEV Level Measurement acquisition sequence starts with the level measurement circuits being put into 'Clamp' Mode for one symbol time to quickly set the voltages on the DOC pins to approximately correct levels. The level measurement circuits are then automatically set to 'Lossy Peak Detect' mode for 15 symbol times, then 'Slow Peak Detect' until a received Frame Sync pattern is recognized, after which the automatic sequence ends and the level measurement circuit mode reverts to the mode set by the LEVRES bits of the Control Register (normally 'Level Track').

The peak detectors used in both 'Slow' and 'Lossy Peak Detect' modes include additional low pass filtering of the received signal. This greatly reduces the effect of pattern noise on the reference voltages held on the external DOC capacitors but means that pairs of '+3' (and '-3') symbols need to be received to establish the correct levels. Two pairs of '+3' and two pairs of '-3' symbols received after the start of an AQLEV sequence are sufficient to correctly set the levels on the DOC capacitors.

The automatic AQSC Symbol Clock acquisition sequence sets the PLL to 'Extra Wide Bandwidth' mode for 16 symbol times (this mode is not one of those which can be selected by the Control Register PLLBW bits) then changes to 'Wide' bandwidth. After 45 symbol times, the PLL mode will revert to that set by the Control Register PLLBW bits.

5.4 AC Coupling

For a practical circuit, ac coupling between the modem's transmit output to the frequency modulator and between the receiver's frequency discriminator and the receive input of the modem may be desired. There are, however, two issues which deserve consideration:

1. AC coupling of the signal degrades the Bit Error Rate performance of the modem. The following graph illustrates the typical bit error rates at 4800 symbols/sec (9600bps) without FEC for reasonably random data with differing degrees of AC coupling:

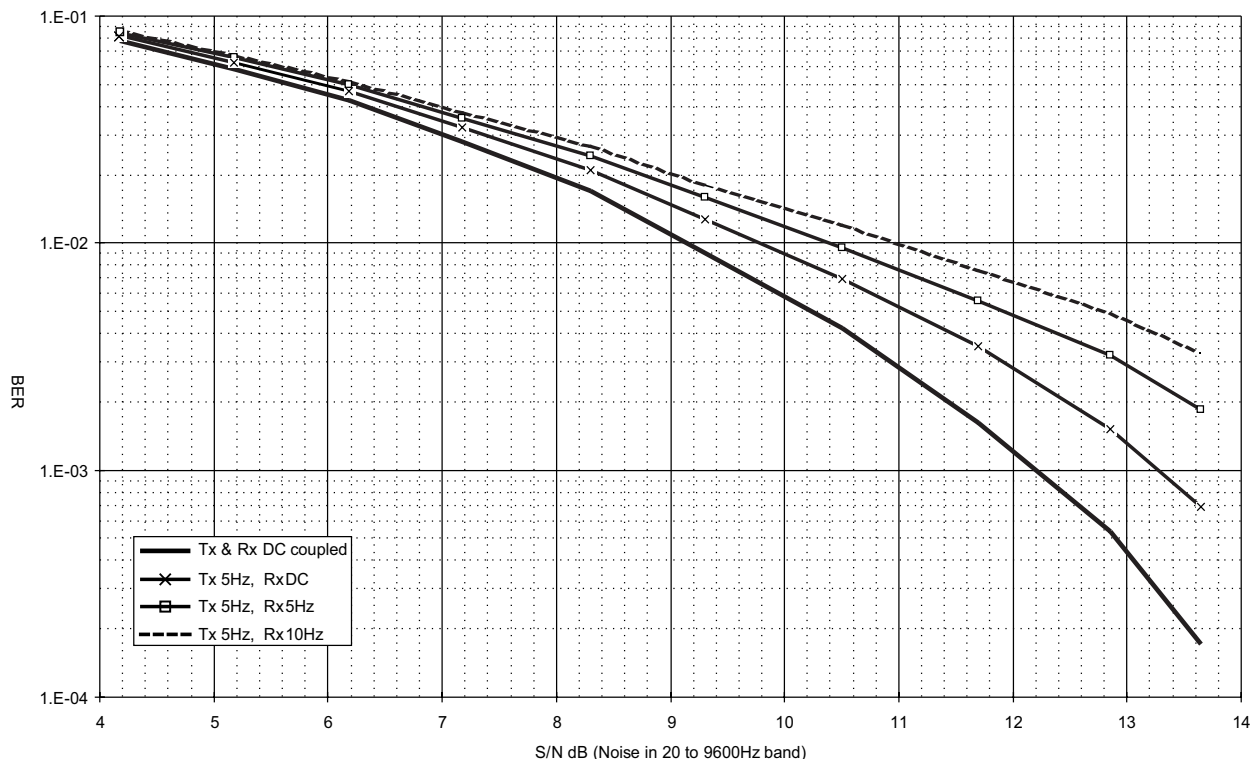

Figure 24: Effect of AC Coupling on BER (without FEC)

2. Any AC coupling at the receive input will transform any step in the voltage at the discriminator output to a slowly decaying pulse which can confuse the modem's level measuring circuits. As illustrated in Figure 25 below, the time for this step to decay to 37% of its original value is 'RC' where:

$$RC = \frac{1}{2\pi(3\text{dB cut-off frequency of the RC network})}$$

which is 32ms, or 153 symbol times at 4800 symbols/sec (9600bps) for a 5Hz network.

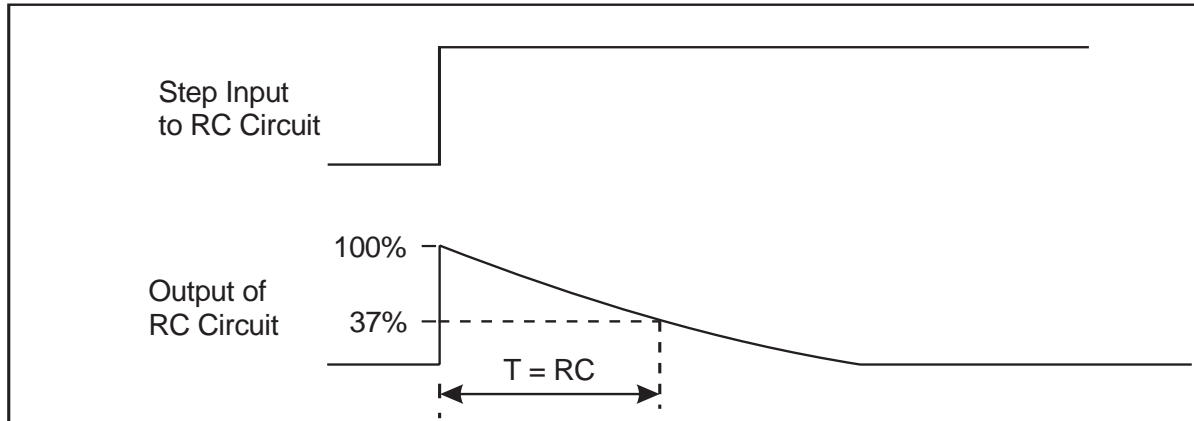

Figure 25: Decay Time - AC Coupling

In general, it is best to DC couple the receiver discriminator to the modem and ensure that any AC coupling to the transmitter's frequency modulator has a -3dB cut-off frequency of no higher than 5Hz for 4800 symbols/sec (9600bps).

5.5 Radio Performance

The maximum data rate that can be transmitted over a radio channel using this modem depends on:

- RF channel spacing.
- Allowable adjacent channel interference.
- Symbol rate.
- Peak carrier deviation (modulation index).
- Tx and Rx reference oscillator accuracy.
- Modulator and demodulator linearity.
- Receiver IF filter frequency and phase characteristics.
- Use of error correction techniques.
- Acceptable error rate.

As a guide, 4800 symbols/sec (9600bps) can be achieved (subject to local regulatory requirements) over a system with 12.5kHz channel spacing if the transmitter frequency deviation is set to $\pm 2.5\text{kHz}$ peak for a repetitive '+3 +3 -3 -3 ...' pattern and the maximum difference between transmitter and receiver 'carrier' frequencies is less than 2400Hz.

The modulation scheme employed by these modems is designed to achieve high data throughput by exploiting as much as possible of the RF channel bandwidth. However, this does place constraints on the performance of the radio. Particular attention must be paid to:

- Linearity, frequency, and phase response of the Tx Frequency Modulator. For a 4800 symbols/sec (9600bps) system, the frequency response should be within $\pm 2\text{dB}$ over the range 3Hz to 5kHz, relative to 2400Hz.
- The bandwidth and phase response of the receiver's IF filters.
- Accuracy of the Tx and Rx reference oscillators, as any difference will shift the received signal towards the skirts of the IF filter response and cause a DC offset at the discriminator output.

Viewing the equalized received signal eye diagram, using the Mode Register RXEYE function, provides a good indication of the overall RF transmitter/receiver performance.

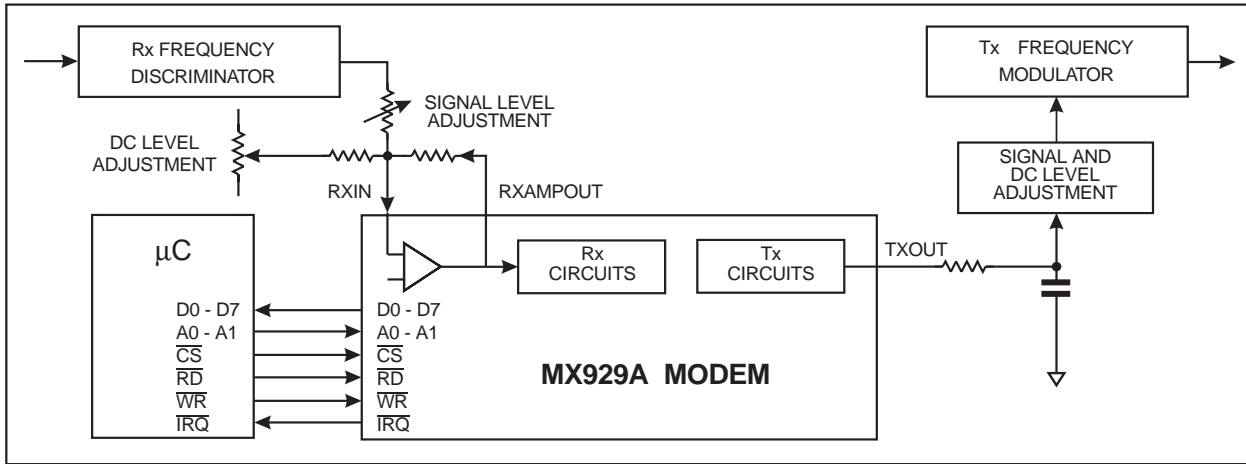

Figure 26: Typical Connections between Radio and MX929B

5.6 Received Signal Quality Monitor

In applications where the modem has to monitor a long transmission containing a number of concatenated Frames, it is recommended that the controlling software include a function which regularly checks that the modem is still receiving a good data signal and triggers a re-acquisition and possibly changes to another channel if a problem is encountered. This strategy has been shown to improve the system's overall performance in situations where fading, large noise bursts, severe co-channel interference, or loss of the received signal for long periods are likely to occur.

Such a function can be simply implemented by regularly reading the Data Quality Register, which gives a measure of the overall quality of the received signal, as well as the current effectiveness of the modem's clock extraction and level measurement systems. Experience has shown that if two consecutive DQ readings are both less than 50 then it is worth instructing the MX929B to re-acquire the received signal levels and timing once it has been established that the received carrier level is satisfactory. Re-acquisition should follow the procedure given in Section 5.3 Clock Extraction and Level Measurement Systems.

The interval between Data Quality readings is not critical, but should be a minimum of 64 symbol times except for the first reading made after triggering the AQSC and AQLEV automatic acquisition sequences, which should be delayed for about 250 symbol times.

A suitable algorithm is shown in Figure 27.

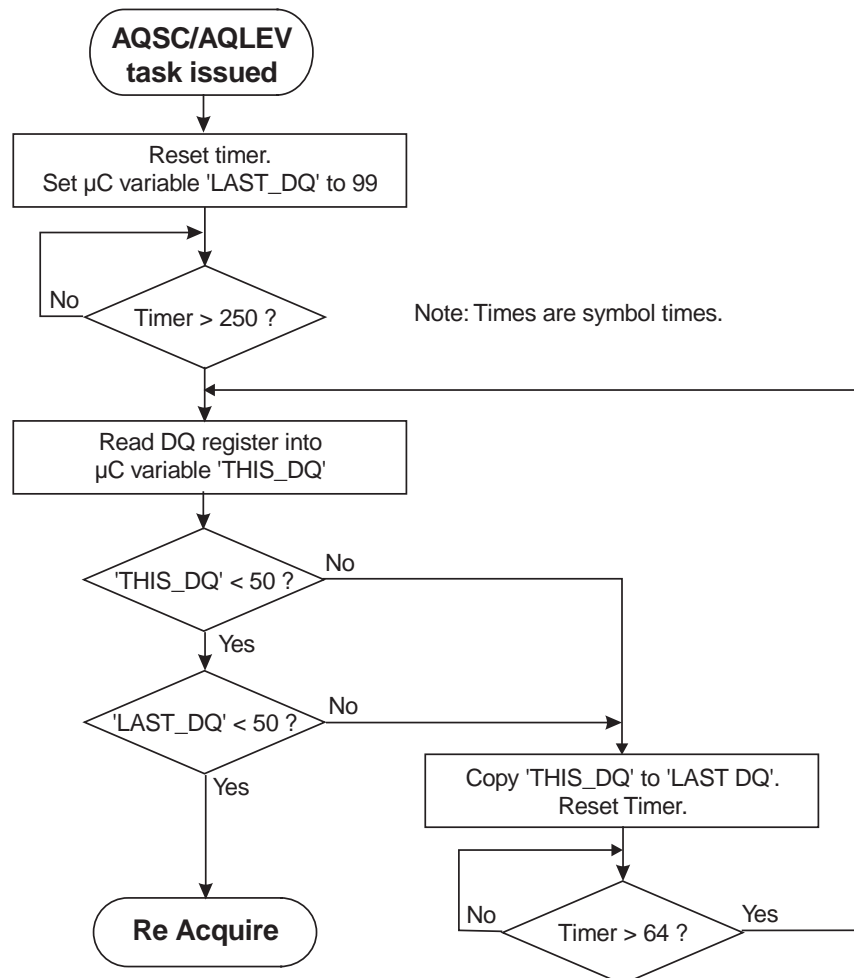

Figure 27: Received Signal Quality Monitor Flowchart

6 Performance Specification

6.1 Electrical Performance

6.1.1 Absolute Maximum Ratings

Exceeding these maximum ratings can result in damage to the device.

General	Min.	Max.	Units
Supply ($V_{DD} - V_{SS}$)	-0.3	7.0	V
Voltage on any pin to V_{SS}	-0.3	$V_{DD} + 0.3$	V
Current			
V_{DD}	-30	30	mA
V_{SS}	-30	30	mA
Any other pin	-20	20	mA
DW and P Packages	Min.	Max.	Units
Total Allowable Power Dissipation at $T_{AMB} = 25^{\circ}\text{C}$		800	mW
Derating above 25°C		13	mW/ $^{\circ}\text{C}$ above $^{\circ}\text{C}$
Storage Temperature	-55	125	$^{\circ}\text{C}$
Operating Temperature	-40	85	$^{\circ}\text{C}$
DS Package	Min.	Max.	Units
Total Allowable Power Dissipation at $T_{AMB} = 25^{\circ}\text{C}$		550	mW
Derating above 25°C		9	mW/ $^{\circ}\text{C}$ above $^{\circ}\text{C}$
Storage Temperature	-55	125	$^{\circ}\text{C}$
Operating Temperature	-40	85	$^{\circ}\text{C}$

6.1.2 Operating Limits

Correct operation of the device outside these limits is not implied.

	Notes	Min.	Max.	Units
Supply ($V_{DD} - V_{SS}$)		3.0	5.5	V
Symbol Rate		2400	9600	Symbols/sec
Temperature		-40	85	$^{\circ}\text{C}$
Xtal Frequency		1.0	10.0	MHz

6.1.3 Operating Characteristics

For the following conditions unless otherwise specified:

Xtal Frequency = 4.9152MHz, Symbol Rate = 4800 symbols/sec (9600bps),

Noise Bandwidth = 0 to 9600Hz, $V_{DD} = 3.3V$ to $5.0V$ @ $T_{AMB} = 25^{\circ}C$

	Notes	Min.	Typ.	Max.	Units
DC Parameters					
I_{DD}	1		4.0	10.0	mA
I_{DD} ($V_{DD} = 3.3V$)	1		2.5	6.3	mA
I_{DD} (Powersave Mode)	1		1.5		mA
I_{DD} (Powersave Mode, $V_{DD} = 3.3V$)	1		0.6		mA
AC Parameters					
Tx Output					
TXOUT Impedance	2		1.0	2.5	k Ω
Signal Level					
TXIMP = 0	3	0.8	1.0	1.2	V_{P-P}
TXIMP = 1	3	0.88	1.1	1.32	V_{P-P}
Output DC Offset with respect to $V_{DD} / 2$	4	-0.25		0.25	V
Rx Input					
RXIN Impedance (at 100Hz)			10.0		M Ω
RXIN Amp Voltage Gain (input = $1mV_{RMS}$ at 100Hz)			300		V/V
Input Signal Level	5	0.7	1.0	1.3	V_{P-P}
DC Offset with respect to $V_{DD} / 2$	5	-0.5		0.5	V
Xtal/Clock Input					
'High' Pulse Width	6	40			ns
'Low' Pulse Width	6	40			ns
Input Impedance (at 100Hz)		10.0			M Ω
Inverter Gain (input = $1mV_{RMS}$ at 100Hz)		20			dB
μC Interface					
Input Logic "1" Level	7, 8	70%			V_{DD}
Input Logic "0" Level	7, 8			30%	V_{DD}
Input Leakage Current ($V_{IN} = 0$ to V_{DD})	7, 8	-5.0		5.0	μA
Input Capacitance	7, 8		10.0		pF
Output Logic "1" Level ($I_{OH} = 120\mu A$)	8	92%			V_{DD}
Output Logic "0" Level ($I_{OL} = 360\mu A$)	8, 9			8%	V_{DD}
'Off' State Leakage Current ($V_{OUT} = V_{DD}$)	9			10.0	μA

6.1.4 Operating Characteristics Notes:

1. Not including any current drawn from the modem pins by external circuitry other than the Xtal oscillator.
2. Small signal impedance.
3. Measured after the external RC filter (R4/C5) for a "+3 +3 -3 -3..." symbol sequence. (Tx output level is proportional to V_{DD}).
4. Measured at the TXOUT pin with the modem in the Tx idle mode.
5. For optimum performance, measured at RXAMPOUT pin, for a "...+3 +3 -3 -3..." symbol sequence, TXIMP = 0 or 1. The optimum level and DC offset values are proportional to V_{DD} .
6. Timing for an external input to the XTAL/Clock pin.
7. \overline{WR} , \overline{RD} , \overline{CS} , A0 and A1 pins.
8. D0 - D7 pins.
9. \overline{IRQ} pin.

6.1.5 Timing

μ C Parallel Interface Timings (ref. Figure 28)		Notes	Min.	Typ.	Max.	Units
t_{ACSL}	Address valid to \overline{CS} low time		0			ns
t_{AH}	Address hold time		0			ns
t_{CSH}	\overline{CS} hold time		0			ns
t_{CSHI}	\overline{CS} high time	1	6.0			clock cycles
t_{CSRWL}	\overline{CS} to \overline{WR} or \overline{RD} low time		0			ns
t_{DHR}	Read data hold time		0			ns
t_{DHW}	Write data hold time		0			ns
t_{DSW}	Write data setup time		90.0			ns
t_{RHCSL}	\overline{RD} high to \overline{CS} low time (write)		0			ns
t_{RACL}	Read access time from \overline{CS} low	2			175	ns
t_{RARL}	Read access time from \overline{RD} low	2			145	ns
t_{RL}	\overline{RD} low time		200			ns
t_{RX}	\overline{RD} high to D0-D7 3-state time				50	ns
t_{WHCSL}	\overline{WR} high to \overline{CS} low time (read)		0			ns
t_{WL}	\overline{WR} low time		200			ns

Timing Notes:

1. Xtal/Clock cycles at the XTAL/CLOCK pin.
2. With 30pF max to V_{SS} on D0 - D7 pins.

6.1.6 Typical Bit Error Rate

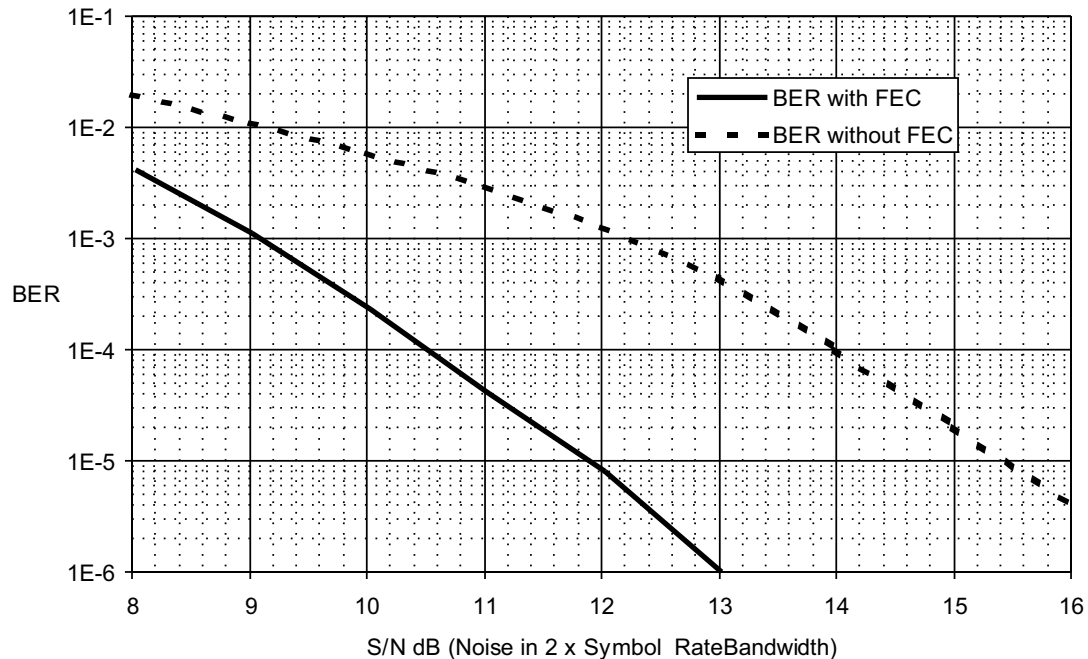

Figure 29: Typical Bit Error Rate With and Without FEC

Measured under nominal working conditions, LEVRES bits set to 'Level Track' or 'Slow Peak Detect' and PLLBW bits set to 'Medium' or 'Narrow' Bandwidth, Command Register TXIMP bit set to '0' or '1' (same for Tx and Rx devices), with pseudo-random data.

Note: S/N calculates as $20\log_{10}\left(\frac{\text{Signal Voltage}}{\text{Noise Voltage}}\right)$

Where: Signal Voltage is the measured V_{RMS} of a random 4-level signal.

Noise Voltage is the V_{RMS} of a flat Gaussian noise signal having a bandwidth from a few Hz to twice the symbol rate (e.g. to 9600Hz when measuring a 4800 symbol/sec (9600bps) system).

Both signals are measured at the same point in the test circuit.

6.2 Packaging

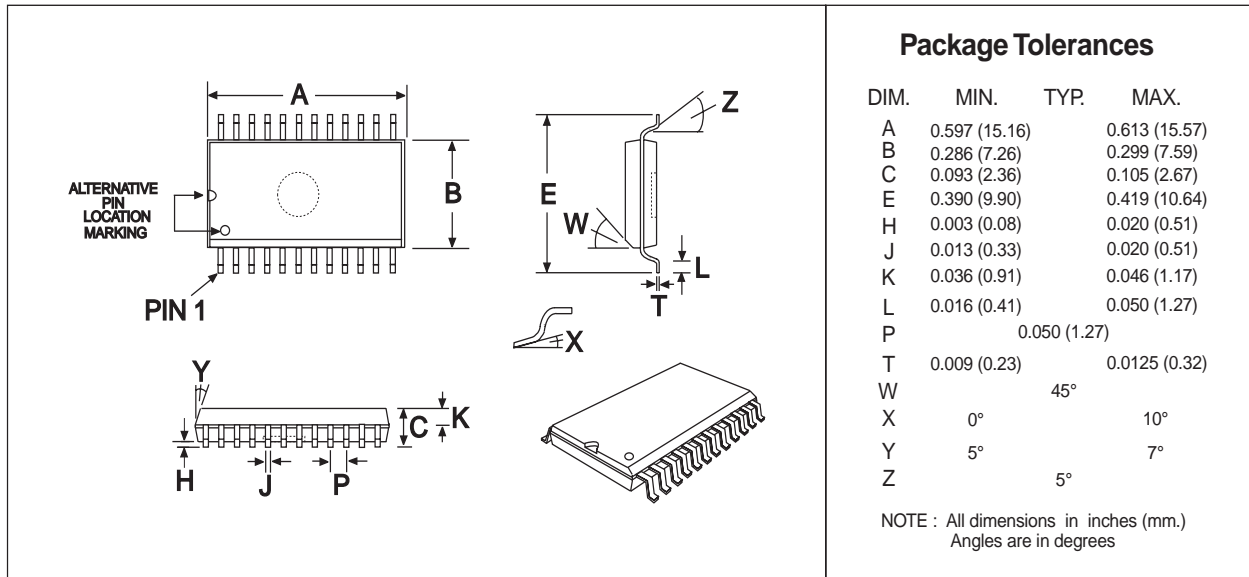

Figure 30: 24-pin SOIC Mechanical Outline: Order as part no. MX929BDW

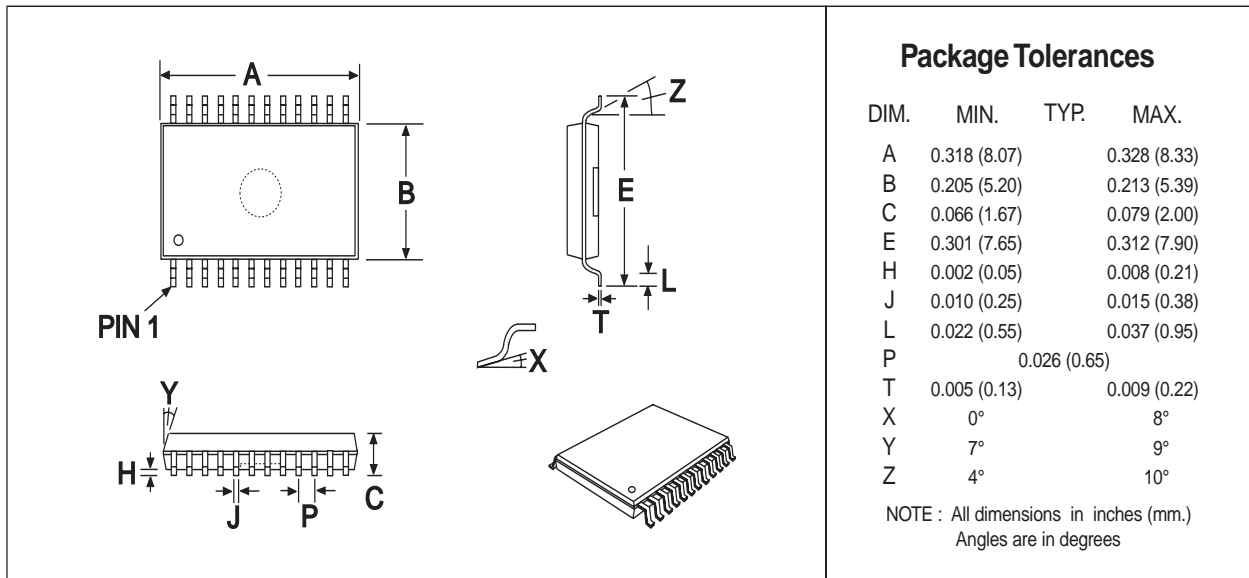

Figure 31: 24-pin SSOP Mechanical Outline: Order as part no. MX929BDS

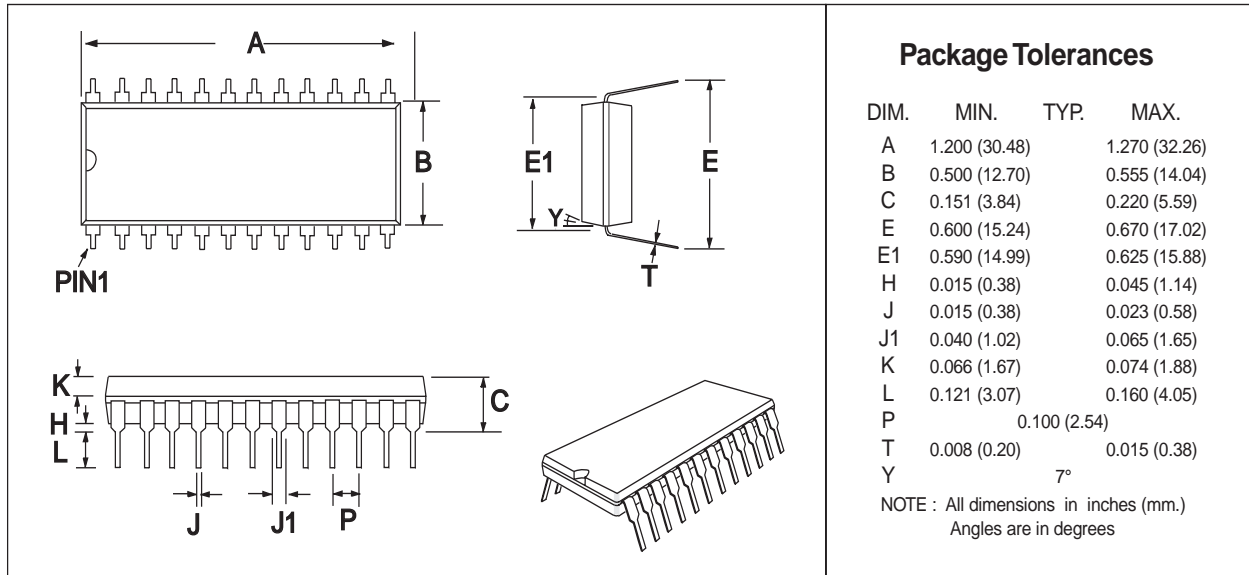

Figure 32: 24-pin PDIP Mechanical Outline: *Order as part no. MX929BP*

This datasheet has been download from:

www.datasheetcatalog.com

Datasheets for electronics components.