

ElectricSpacecraft

A JOURNAL OF INTERACTIVE RESEARCH

73 Sunlight Drive

Leicester, NC 28748

Tel 704 683-0313

Fax 704 683-3511

August 20, 1997

John Hutchison
Apt. 305
727 5th Avenue
New Westminster, BC
Canada V3M 1X8

Dear John:

I would like to inform you that the Hutchison effect was mentioned in a poster presentation recently delivered to NASA's Breakthrough Physics Propulsion Workshop. The poster was designed to communicate some of the ideas submitted to *ESJ* through the years that might have the most potential for applications in the future of space travel. Copies of the poster and the accompanying paper, which were made available to many prominent space scientists and engineers, are enclosed. Thank you for your contributions to this poster and *ESJ*.

Sincerely,

Charles A. Yost

The Hutchison Effect Apparatus

By John Hutchison and ESJ staff

There have been some serious investigations into the Hutchison Effect in Canada, the United States, and Germany. (See articles in ESJ #4.) The reality of objects being moved, levitated, or restructured by magnetic and electric field effects does not seem to be in question. Just how or why the events happen is the questionable part. John Hutchison has been providing ESJ with details on his work, as have a few others who have worked with him over the years. The picture consistently described is that of numerous experimental apparatus being operated simultaneously and interactively. "Events" occur, somewhat unpredictably. This is a format of accidental discovery through undefined mixture. It is exciting to the experimenter, yet frustrating to the scientist trying to sort out the interaction of the variables. Although recollection and details are difficult, Mr. Hutchison describes some of his apparatus in this attempt to share with other experimenters.



John Hutchison—1985

I will attempt to explain details of the apparatus used in my experiments and will start with the input power used to trigger the host of Tesla coils, static generators, transformers, interferometers, magnetics, metal masses, and nuclear sources, etc. The source power was 110-volts AC operated at 400 watts to 4000 watts. One side of the AC line had a power factor capacitor (60 cycles, 250 volt), and a 100-amp current limiter. The magnetics of the current limiter were also used in the experiment interactions.

This power source was divided up in a function box and, through switching, went to variacs. The variac outputs were monitored by wattmeters, ammeters, and voltmeters, and supplied

up to fourteen transformers. These included twelve-volt transformers for vacuum tubes, 400,000-volt AC transformers, a Siemens 250,000-volt DC X-ray transformer, and other items. Regeneration equipment of 450 kHz up to 2500 MHz was also operated.

The general power circuit is shown in Figure 1. A and B are current limiters which ranged from two to seven amps. By this means some transformers were limited to this amperage instead of the fifty amps that might otherwise be drawn. The current limiters were adjustable and the magnetics from them were used in close proximity to the spark gaps and an alpha-beta emission unit. I had bypass switches on each

Warning: The re-creation of certain aspects of these experiments is extremely dangerous and should not be attempted without proper training or guidance.

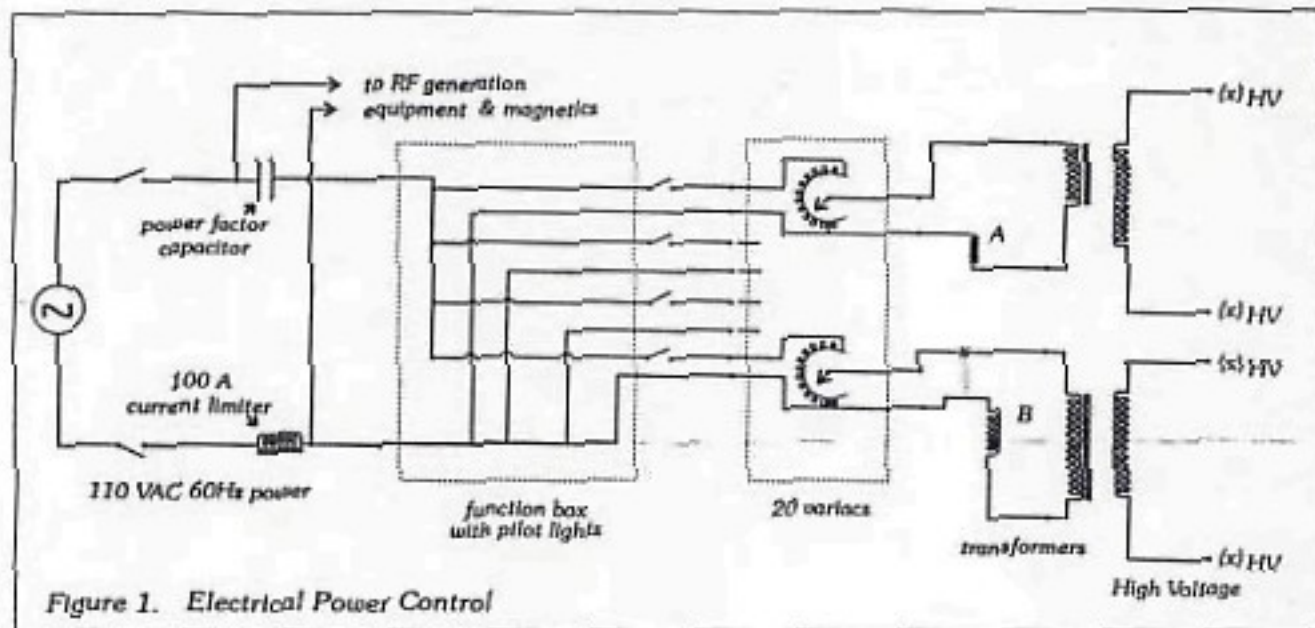

current limiter which I used often. Unfortunately there was an incident one time in which the outside pole transformer blew up when using the bypass switch.

The symbol (x) is used to represent the high potential leads in Figures 1, 5-7, and 17. These figures are rough schematics of some circuits.

My favorite Tesla coils are shown in Figures 2 and 3. Other Tesla coils I had were of the flat pancake-type with 1-inch copper tube in the

primary and 10,000 turns of number 32 wire on an 8-inch diameter secondary tube. Another coil used twelve-gauge wire on a 24-inch diameter tube, mounted horizontally. These are not shown.

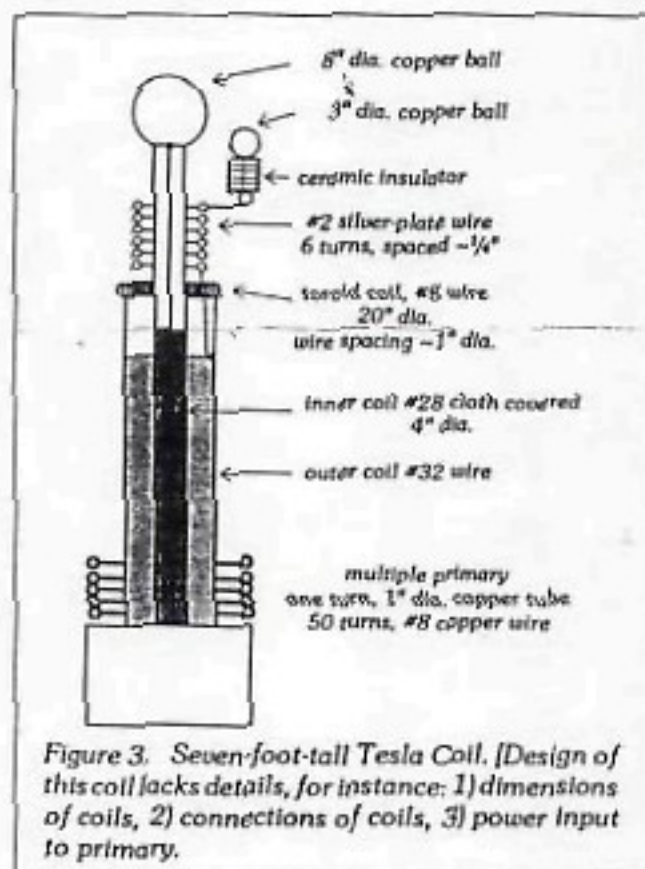
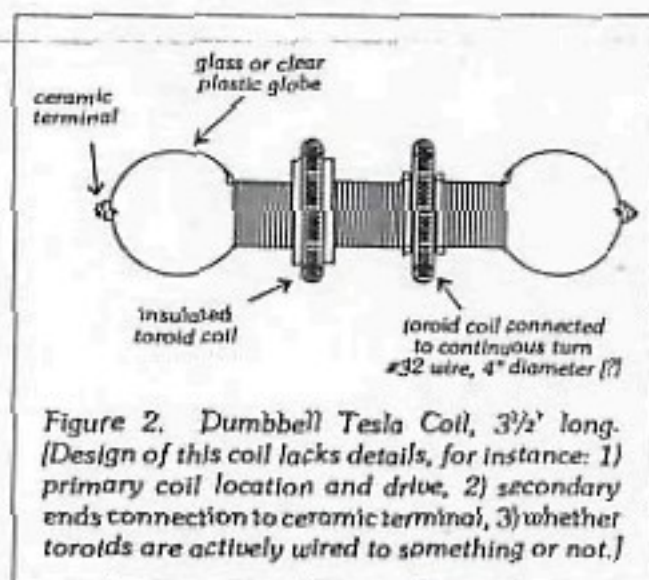

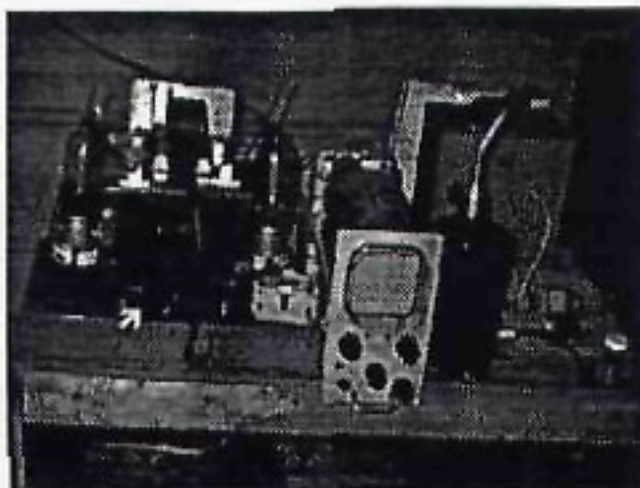

Figure 4. Vacuum Tube Tesla Coil Drive

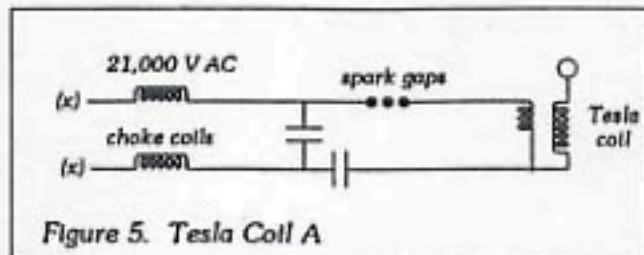

Figure 5. Tesla Coil A

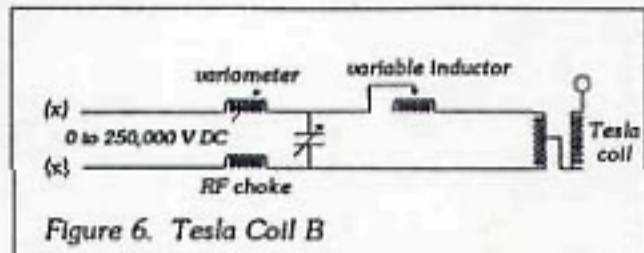

Figure 6. Tesla Coil B

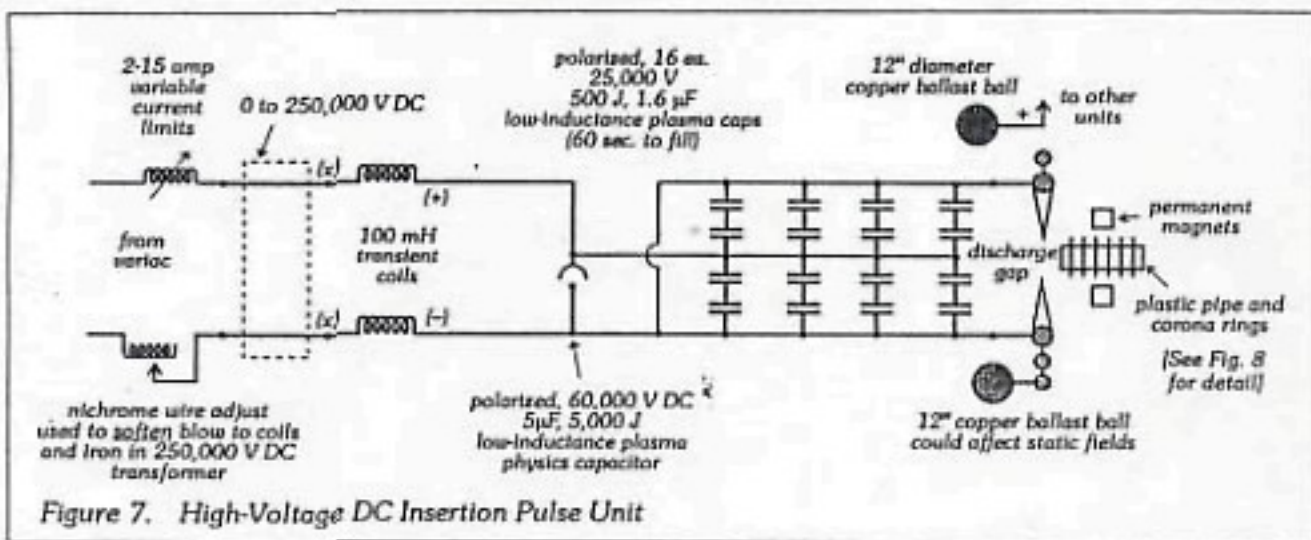

Figure 7. High-Voltage DC Insertion Pulse Unit

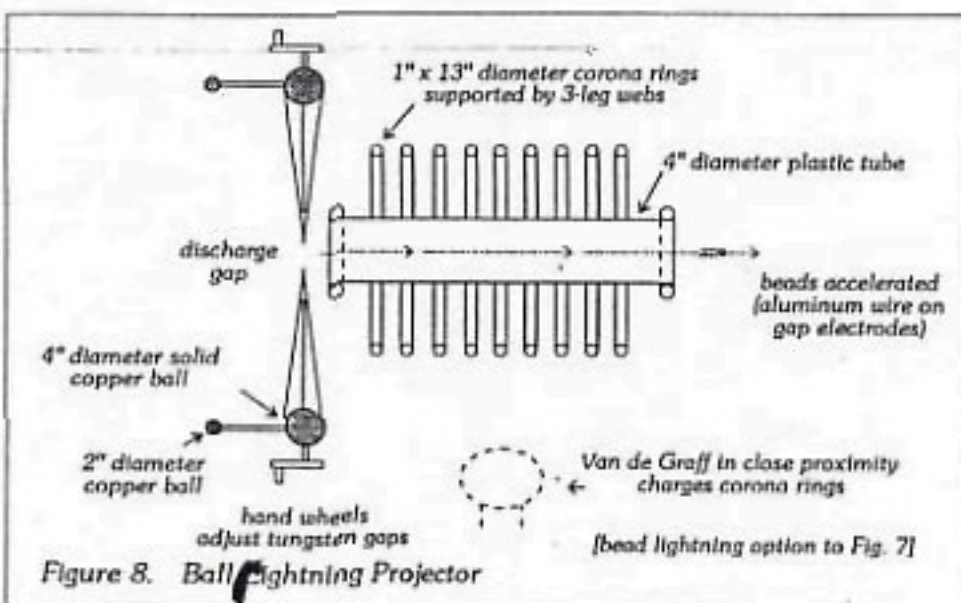

Figure 8. Ball Lightning Projector

The electronics of a vacuum tube Tesla coil are shown in Figure 4. Figures 5 and 6 show rough schematics of the Tesla coil circuits.

The schematic of Figure 7, powered by a high-voltage transformer, generated strong electric field pulses for a number of uses, including the projection of bead lightning, as illustrated in Figure 8.

One set-up, illustrated in Figure 9, seemed to produce changes in the cosmic background radiation.

If I increased the variac output to the Siemens transformer to increase the high-voltage DC on the large toroid, while keeping the rest of the laboratory system running, the Geiger counter would drop to near zero counts per minute within a 75-foot diameter zone. Yet, the reverse was possible (to increase counts) if I dropped the toroid voltage and increased all DC voltages to the laboratory system of Tesla coils (via tank circuits), RF coils, spark gaps, toroidal coils, and tension on the nuclear unit. The AC part of the laboratory system would be maintained at the same level. Figure 10 shows a schematic of pulsing to the large main toroid.

Some years ago, Drs. Lakken and Wilson argued over whether a "ball" of alpha-beta flux formed and deposited on the test samples. I personally don't believe so. I believe the alpha-beta flux was guided to the masses by being connected to high-voltage DC levels, by magnetic pulse fields, and excited by my mechanically-pulsed magnetron which excited the geometric metal. The idea is to excite the surface skin of the masses and their atoms to create an unstable space-time situation. This might allow the fields from the Tesla coils and RF generation equipment to lock up in a local space-time situation. My thought is that now a small amount of energy is released from the vast reservoir in space-time at the sub-atomic level to create a disruptive or movement effect.

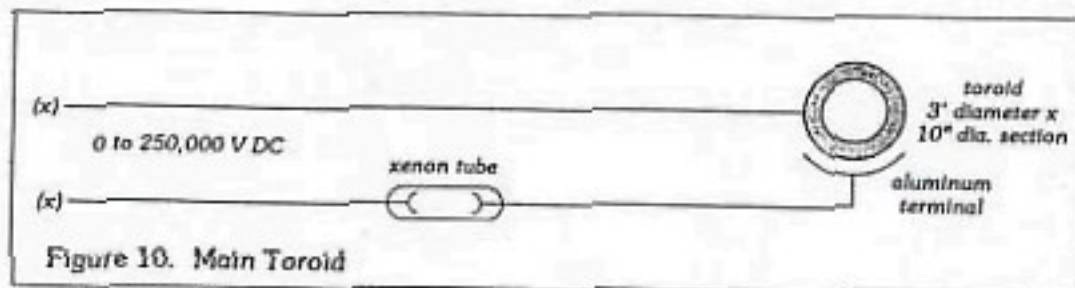
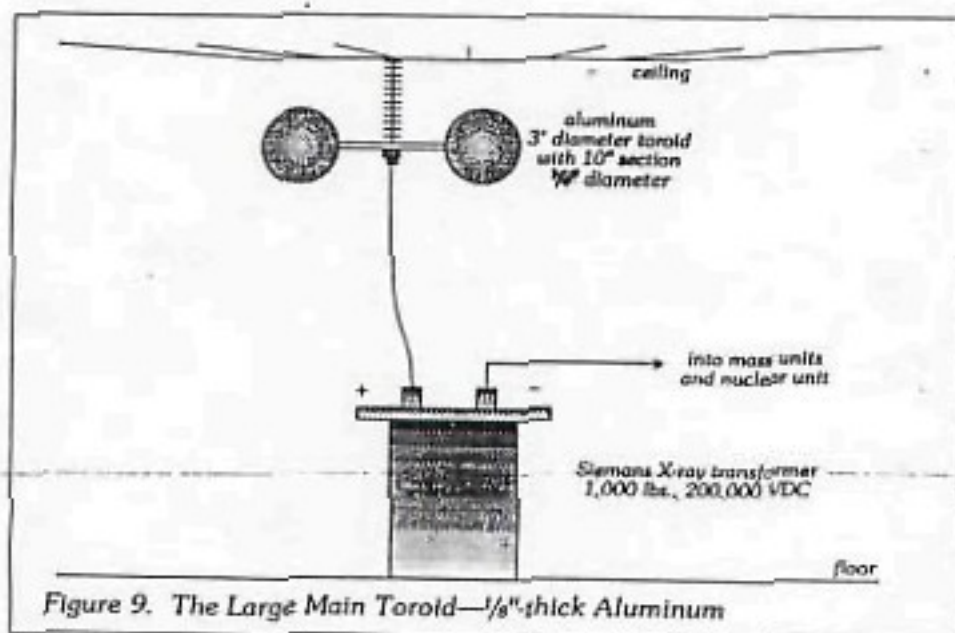
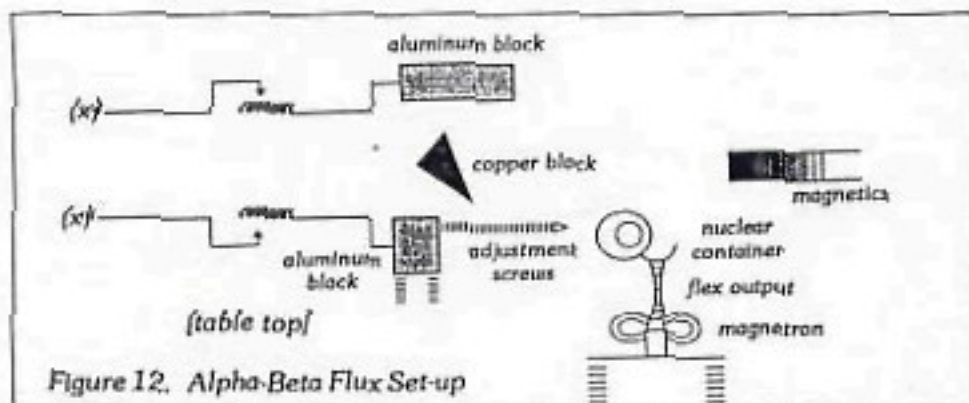
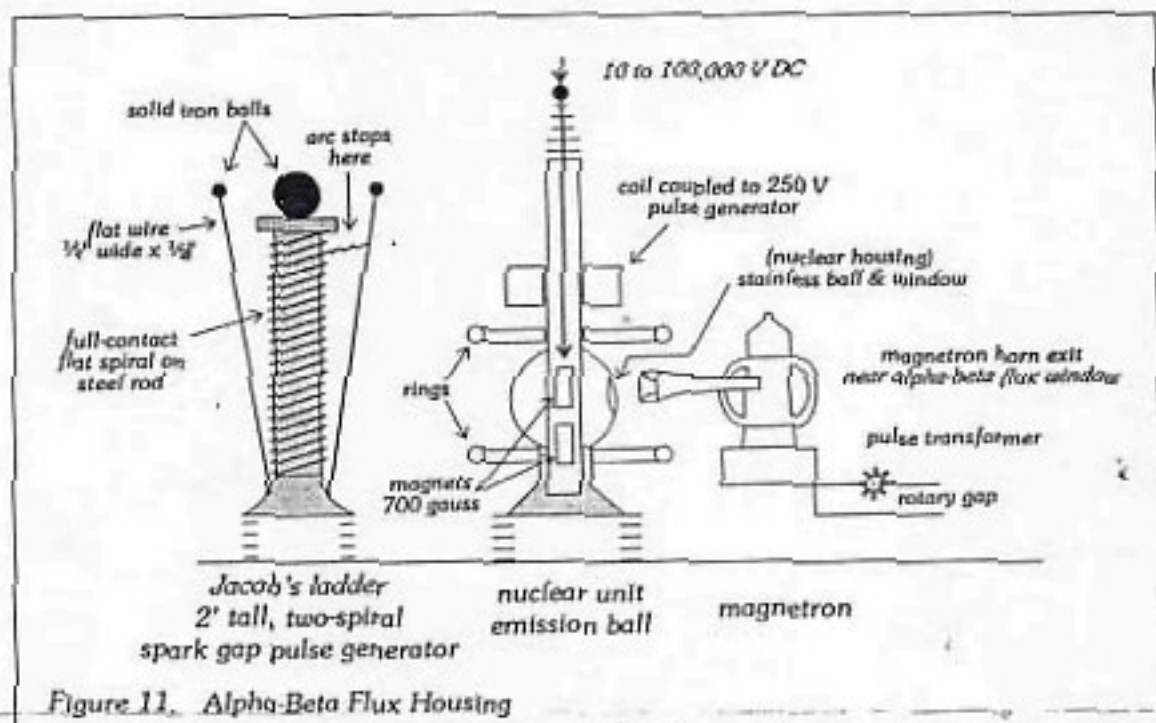

Figure 11 is a cutaway showing the nuclear section in the center of a Tesla coil. Note how I have the feed horn close to the window area. This area was also bathed in a 30,000-volt static electric field plus a weak magnetic field of only 700 gauss which was variable. A two-spiral spark gap unit is also shown in Figure 11.

The radioactive material to provide alpha-beta emissions was contained in a stainless steel ball which had a thin window section. A four-

gigahertz magnetron pulsed by an old rotary spark gap system sent microwaves by the window exit section. Small masses were placed close to the influence of the alpha-beta flux. The radioactive source was also under high-voltage DC and pulsed coils (50,000 to 100,000 turns) to produce traveling wave type magnetics and electrostatics to assist alpha-beta flux bunching and guidance. This all interacted with other surrounding equipment. Some additional arrangement is shown in Figure 12.



Magnetics

A current limiter was used on "Big Red," a fifty-kVA, 89,000-volt transformer. A five-Hz spark-gap discharge went simply to a copper ground plate. The plate was movable and placement of the plate proved successful to later experiments.

My current limiter was made from 4" by 4" laminations stacked fifteen-inches high and number-eight wire wound six layers thick. The pulsing of the iron core proved its worth in tests. Its location was near the heart of my apparatus. Because it was a heavy unit, casters were needed to move it. The units pulse affected the electrostatics and Alpha flux, when close. The Alpha flux dropped off at two feet. Two other units in the set-up were double-loop brass ship antennas five-feet high, as shown in Figure 13.

These are some basics of my laboratory. I excluded RF generation and coupling and all the radar-jamming devices I used later. I could precisely set up a pattern at 2000 MHz at 100 milliwatts. I could give or take (\pm) 1000 MHz, add pulse rate, CW or modulation of any form.

Placement geometry is of great importance to key units of the electrostatic field and spark gaps. The electrostatic field must cover all components. Helping to do this are copper balls mounted on insulators. The large ball keeps its charge longer while small ones discharge faster. In a way, you have a pulse network working along with dynamic electricity, and the small influence of the 250-milliwatt magnetron close to the alpha-beta flux. In the zone is weak magnetics, permanent magnets,

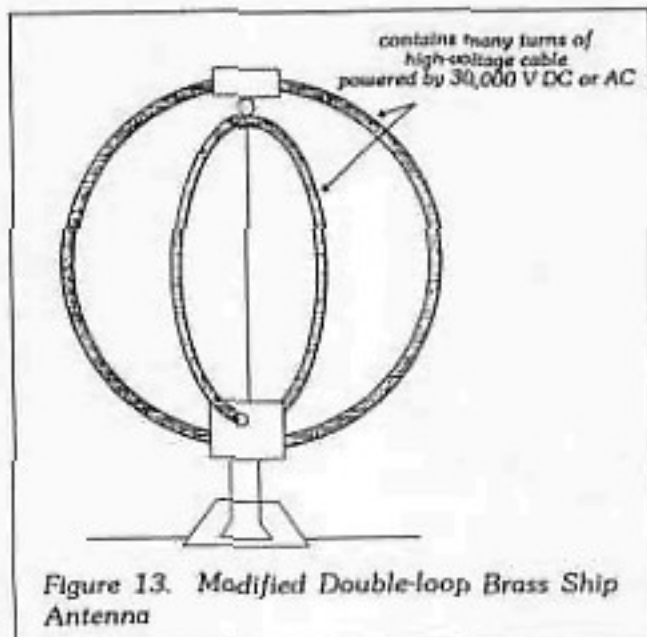

and electromagnets of the traveling wave tube (TWT) barrel types. Thus, perhaps a transformation takes place on the subatomic level in all of this, and a conversion zone takes form from the surrounding equipment. This zone seems to transform again to zones beyond the lab, up to 500 feet away, in the form of a cylinder. There appeared to be a zone at a distance of fifteen feet. Samples placed in it sometimes levitated or broke apart.

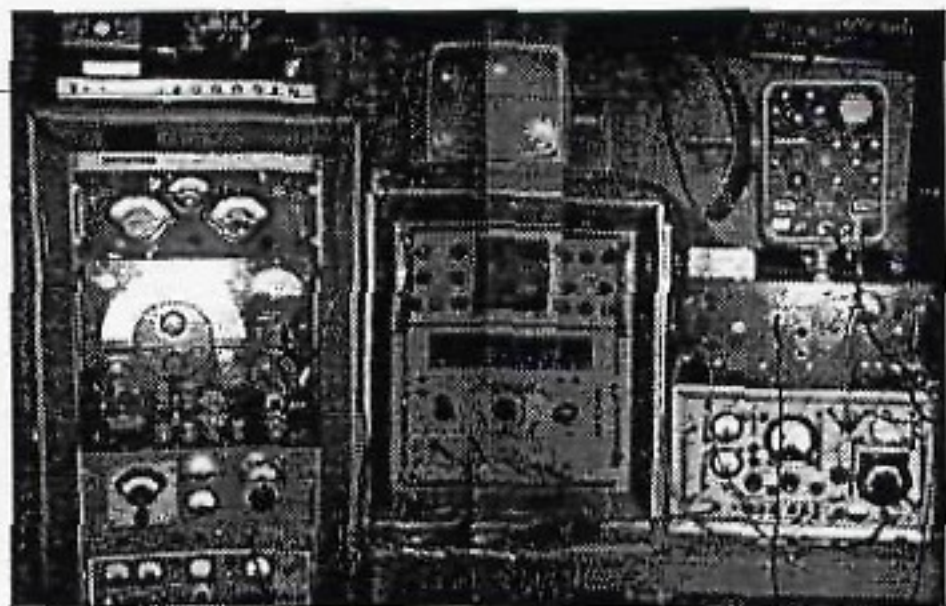

Figure 14. Hutchison's Set-up of Receivers and Monitors

Sample Reactions (Extracted from Reports)

The effects of unexpected field interactions are shown in *Figures 15 and 16*. One sample, a piece of aluminum four-inches long by 1/2-inch square, had been shattered in the center. It would be expected that only a few watts were in this zone, compared to the 4000-watt input feeding all the equipment. Our sample had exploded from inside out, torn into thousands of filaments. The filaments measured .010" to 0.50" long and .008" to .012" thick. The event volume expanded outward from the mass center in seeming reaction to a force of mutual repulsion between filaments.

The field lines picturesquely frozen in the aluminum filaments are functionally identical to those we observed at a point of fracture of a permanent bar magnet of the same geometry. The force exerted on the aluminum filaments was sufficient to split a large number of the outermost strands and fold them back along the "field lines" to such a degree, that layers of them are compacted together, against the solid surfaces of the sample.

The material within the event volume was much harder and quite brittle compared to the original extrusion alloy, which was quite soft. All surfaces evidenced a mottled appearance and regular struc-

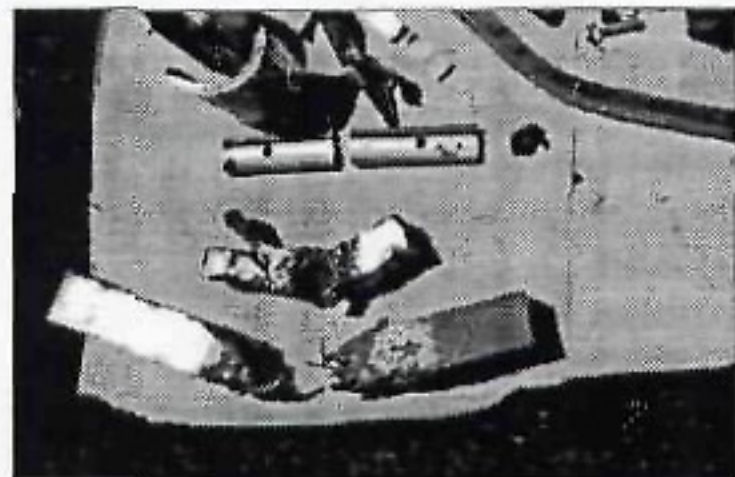

Figure 15. Aluminum and Brass Bars After the Effect

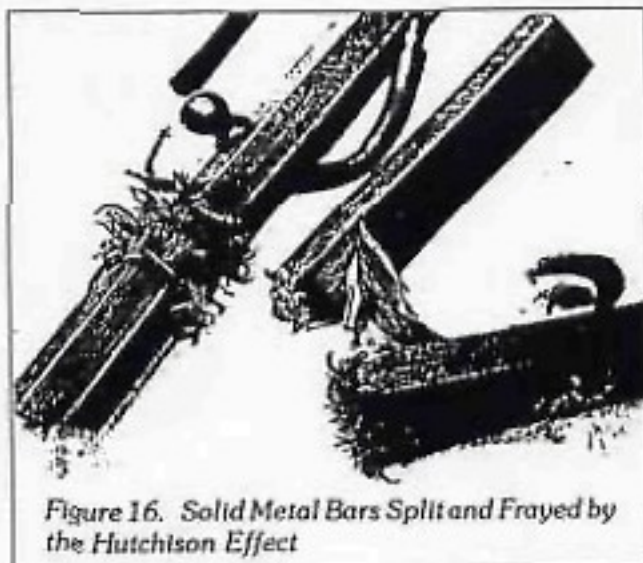

Figure 16. Solid Metal Bars Split and Frayed by the Hutchison Effect

ture, while having none of the characteristics associated with plastic deformation or melting. Physical characteristics were typical of crystalline materials sheared along bonding planes. The number of filaments probably exceeded 100,000, effectively increasing the surface area within the event by tens of thousands of times.

Another sample showed inexplicable material mixtures: wood was found in an aluminum block tested by Siemens Laboratory, Germany. Also, dense, impossible alloys of elements forming unknown materials were found by work of Max Planck Institute, Germany. Because so many different effects happen, including levitation, we can speculate the RF and support field operators are working in a narrow region of the "zone of effects." These random events sometimes happened at about five-per-hour in 1987, '88, and '89.

It is an unpredictable probability for all operators to synchronously combine to cause an effect. For events like slow lift and slow disruption, the operators combine under simple stable outputs, amplitudes, and frequency. Our space-time window would have to be described on the subatomic level for the understanding of the Hutchison Effects.

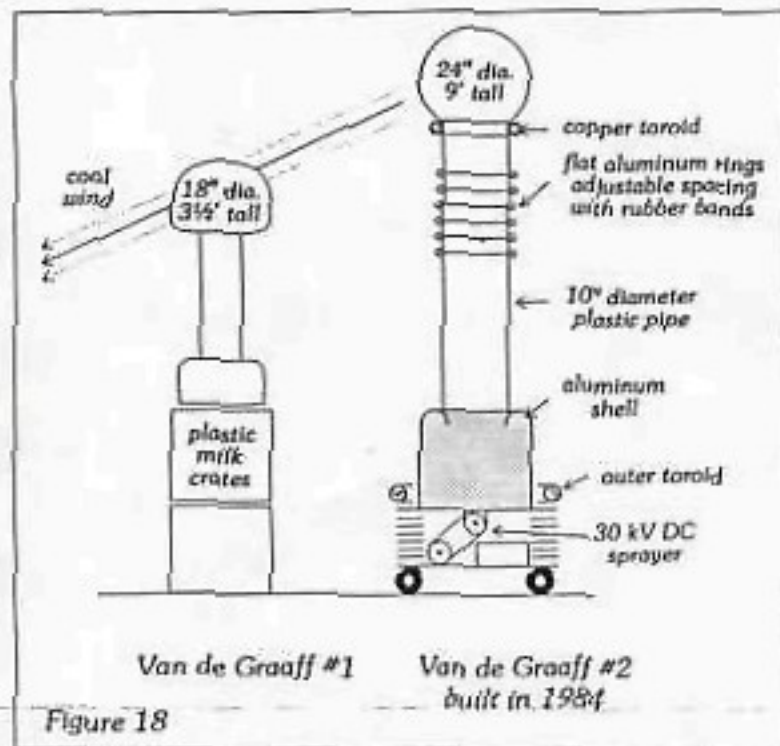
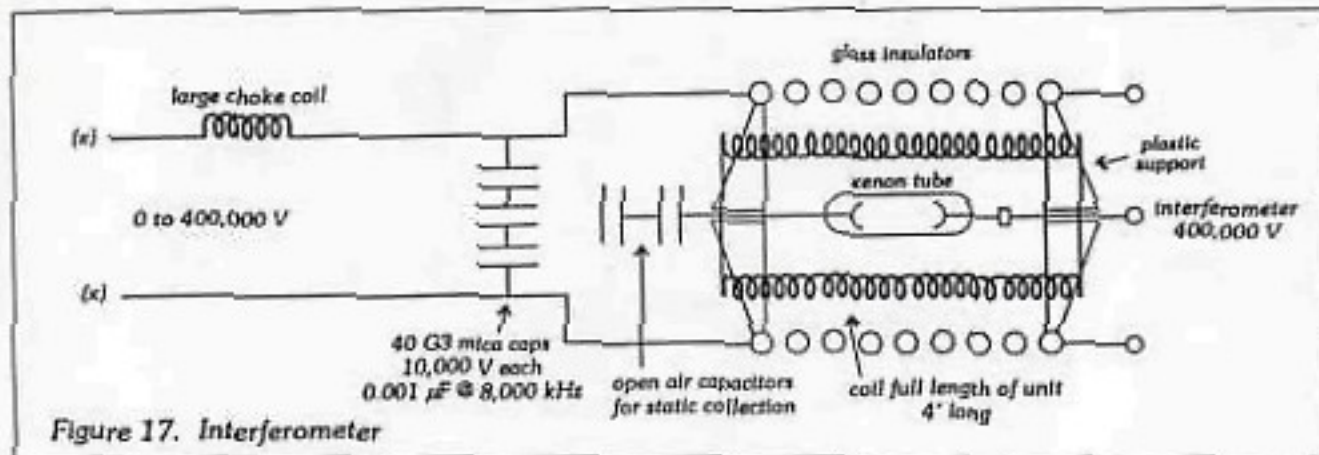

Figure 17 is another pulsing circuit device I call the interferometer. Electrostatics were produced with two Van de Graaff generators. When arranged as shown in Figure 18, cool wind effects could be produced. These machines were used to impose an electrostatic field in the test area.

Acknowledgments

I would like to thank those individuals associated with Pharos Technology, the Max Planck Institute, Los Alamos, McDonnell Douglas, BAM Labs Germany, Fraunhofer, the Austrian and German groups, the DOD groups, and individual input from Japan, Greece, England, Canada, USA, Switzerland, France and the Yin Gazda International Filmmaker, for the interest and support they all have shown.

About the Author

John Hutchison is the classic independent individual experimenter—the "Sorcerer's Apprentice." Mr. Hutchison can be reached by mail at 911 Dublin Street, New Westminster, British Columbia, Canada, V3M 2Y5 •

ElectricSpacecraft

A JOURNAL OF INTERACTIVE RESEARCH

73 Sunlight Drive

Leicester, NC 28748

Tel 704 683-0313

Fax 704 683-3511

August 20, 1997

John Hutchison
Apt. 305
727 5th Avenue
New Westminster, BC
Canada V3M 1X8

Dear John:

I would like to inform you that the Hutchison effect was mentioned in a poster presentation recently delivered to NASA's Breakthrough Physics Propulsion Workshop. The poster was designed to communicate some of the ideas submitted to *ESJ* through the years that might have the most potential for applications in the future of space travel. Copies of the poster and the accompanying paper, which were made available to many prominent space scientists and engineers, are enclosed. Thank you for your contributions to this poster and *ESJ*.

Sincerely,

Charles A. Yost

The Hutchison Effect Apparatus

By John Hutchison and ESJ staff

There have been some serious investigations into the Hutchison Effect in Canada, the United States, and Germany. (See articles in ESJ #4.) The reality of objects being moved, levitated, or restructured by magnetic and electric field effects does not seem to be in question. Just how or why the events happen is the questionable part. John Hutchison has been providing ESJ with details on his work, as have a few others who have worked with him over the years. The picture consistently described is that of numerous experimental apparatus being operated simultaneously and interactively. "Events" occur, somewhat unpredictably. This is a format of accidental discovery through undefined mixture. It is exciting to the experimenter, yet frustrating to the scientist trying to sort out the interaction of the variables. Although recollection and details are difficult, Mr. Hutchison describes some of his apparatus in this attempt to share with other experimenters.



John Hutchison—1985

I will attempt to explain details of the apparatus used in my experiments and will start with the input power used to trigger the host of Tesla coils, static generators, transformers, interferometers, magnetics, metal masses, and nuclear sources, etc. The source power was 110-volts AC operated at 400 watts to 4000 watts. One side of the AC line had a power factor capacitor (60 cycles, 250 volt), and a 100-amp current limiter. The magnetics of the current limiter were also used in the experiment interactions.

This power source was divided up in a function box and, through switching, went to variacs. The variac outputs were monitored by wattmeters, ammeters, and voltmeters, and supplied

up to fourteen transformers. These included twelve-volt transformers for vacuum tubes, 400,000-volt AC transformers, a Siemens 250,000-volt DC X-ray transformer, and other items. Regeneration equipment of 450 kHz up to 2500 MHz was also operated.

The general power circuit is shown in Figure 1. A and B are current limiters which ranged from two to seven amps. By this means some transformers were limited to this amperage instead of the fifty amps that might otherwise be drawn. The current limiters were adjustable and the magnetics from them were used in close proximity to the spark gaps and an alpha-beta emission unit. I had bypass switches on each

Warning: The re-creation of certain aspects of these experiments is extremely dangerous and should not be attempted without proper training or guidance.

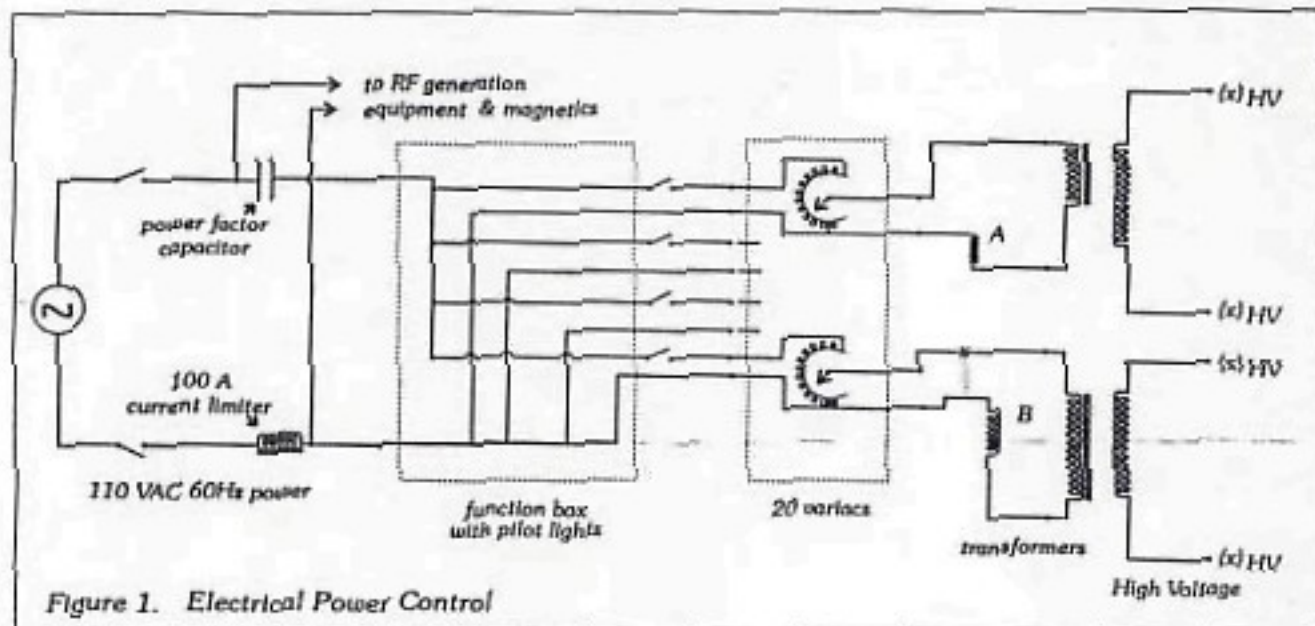

current limiter which I used often. Unfortunately there was an incident one time in which the outside pole transformer blew up when using the bypass switch.

The symbol (x) is used to represent the high potential leads in Figures 1, 5-7, and 17. These figures are rough schematics of some circuits.

My favorite Tesla coils are shown in Figures 2 and 3. Other Tesla coils I had were of the flat pancake-type with 1-inch copper tube in the

primary and 10,000 turns of number 32 wire on an 8-inch diameter secondary tube. Another coil used twelve-gauge wire on a 24-inch diameter tube, mounted horizontally. These are not shown.

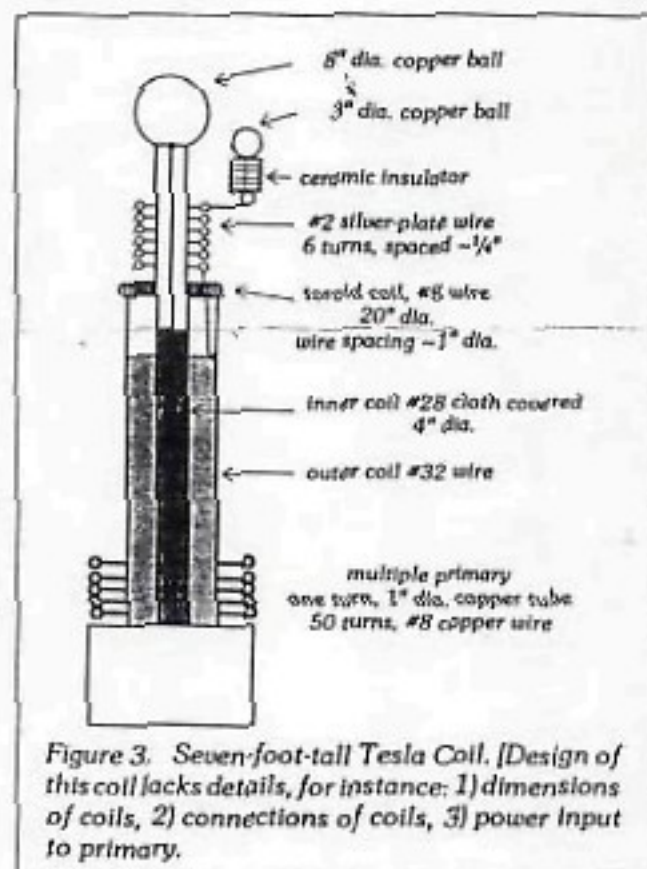
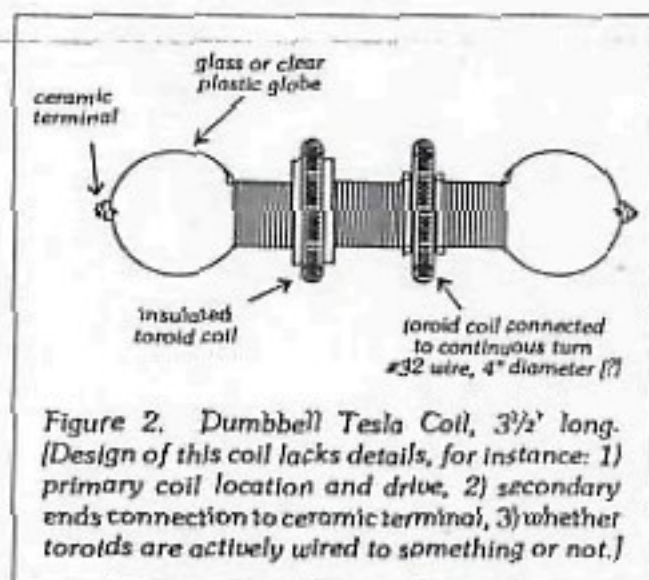

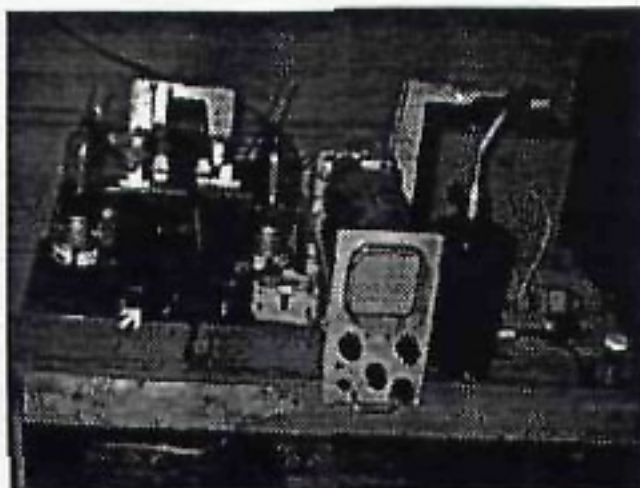

Figure 4. Vacuum Tube Tesla Coil Drive

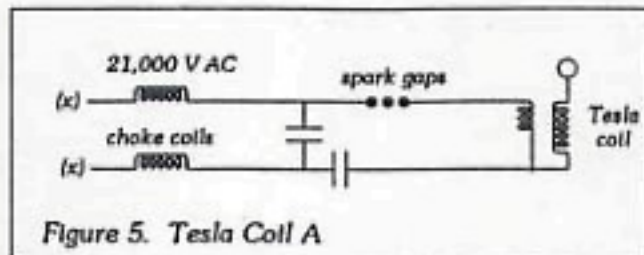

Figure 5. Tesla Coil A

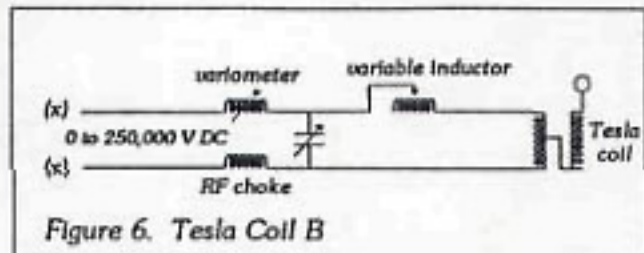

Figure 6. Tesla Coil B

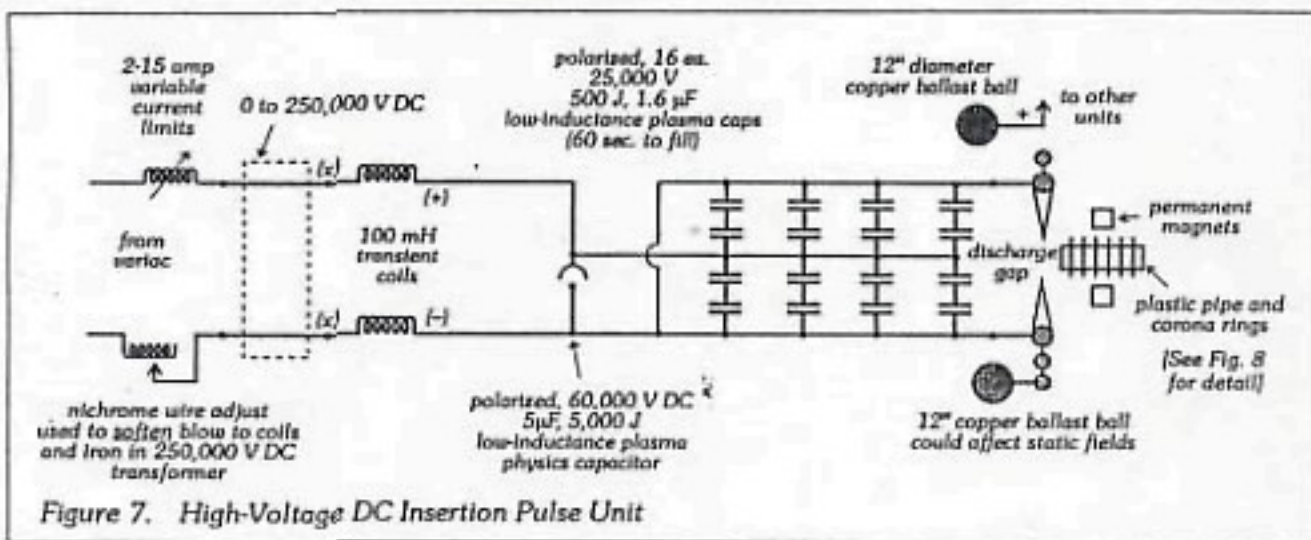

Figure 7. High-Voltage DC Insertion Pulse Unit

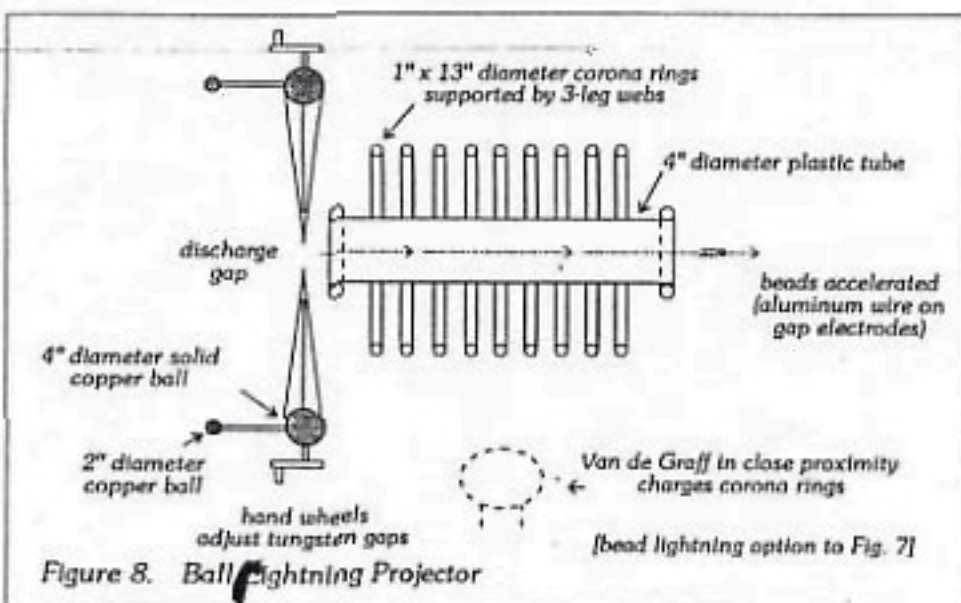

Figure 8. Ball Lightning Projector

The electronics of a vacuum tube Tesla coil are shown in Figure 4. Figures 5 and 6 show rough schematics of the Tesla coil circuits.

The schematic of Figure 7, powered by a high-voltage transformer, generated strong electric field pulses for a number of uses, including the projection of bead lightning, as illustrated in Figure 8.

One set-up, illustrated in Figure 9, seemed to produce changes in the cosmic background radiation.

If I increased the variac output to the Siemens transformer to increase the high-voltage DC on the large toroid, while keeping the rest of the laboratory system running, the Geiger counter would drop to near zero counts per minute within a 75-foot diameter zone. Yet, the reverse was possible (to increase counts) if I dropped the toroid voltage and increased all DC voltages to the laboratory system of Tesla coils (via tank circuits), RF coils, spark gaps, toroidal coils, and tension on the nuclear unit. The AC part of the laboratory system would be maintained at the same level. Figure 10 shows a schematic of pulsing to the large main toroid.

Some years ago, Drs. Lakken and Wilson argued over whether a "ball" of alpha-beta flux formed and deposited on the test samples. I personally don't believe so. I believe the alpha-beta flux was guided to the masses by being connected to high-voltage DC levels, by magnetic pulse fields, and excited by my mechanically-pulsed magnetron which excited the geometric metal. The idea is to excite the surface skin of the masses and their atoms to create an unstable space-time situation. This might allow the fields from the Tesla coils and RF generation equipment to lock up in a local space-time situation. My thought is that now a small amount of energy is released from the vast reservoir in space-time at the sub-atomic level to create a disruptive or movement effect.

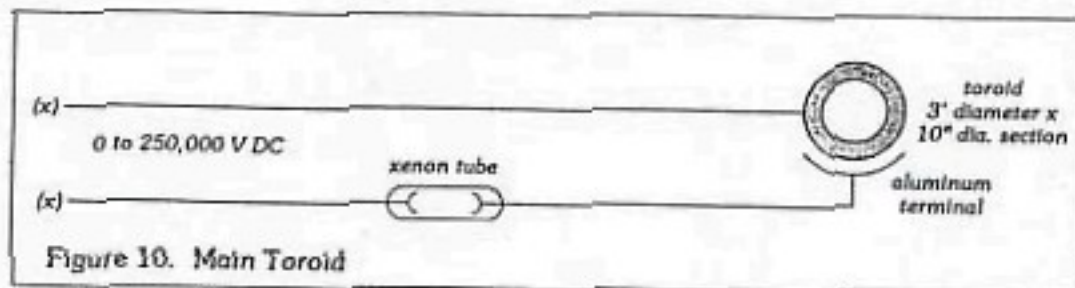
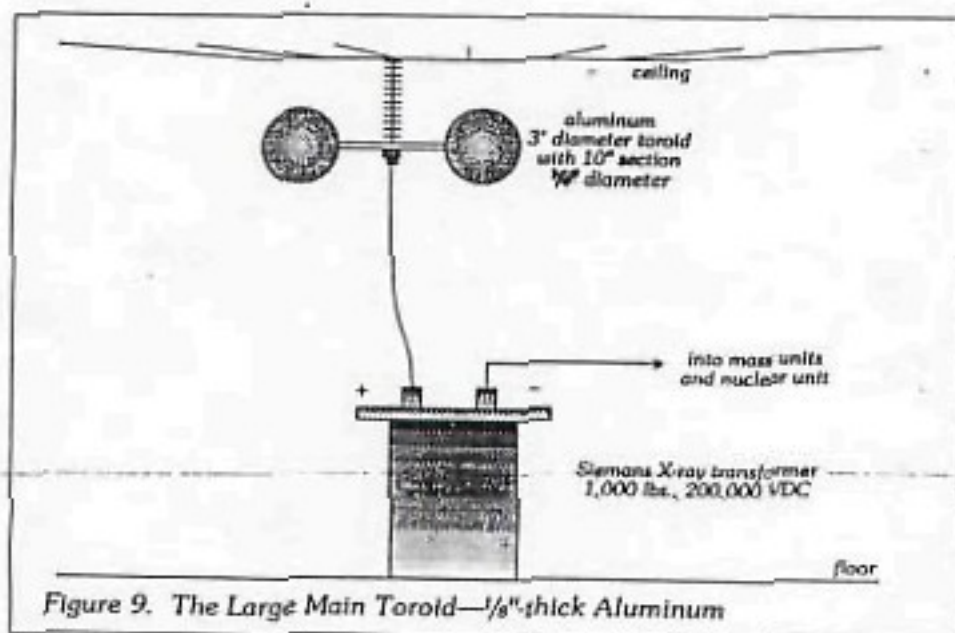
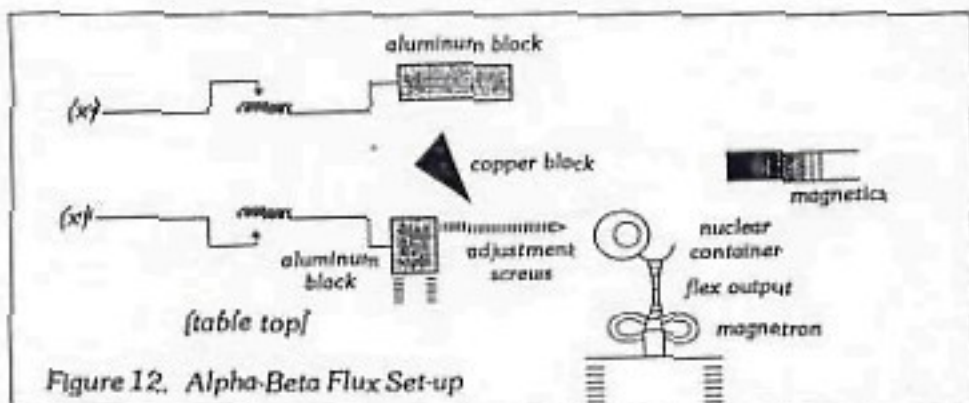
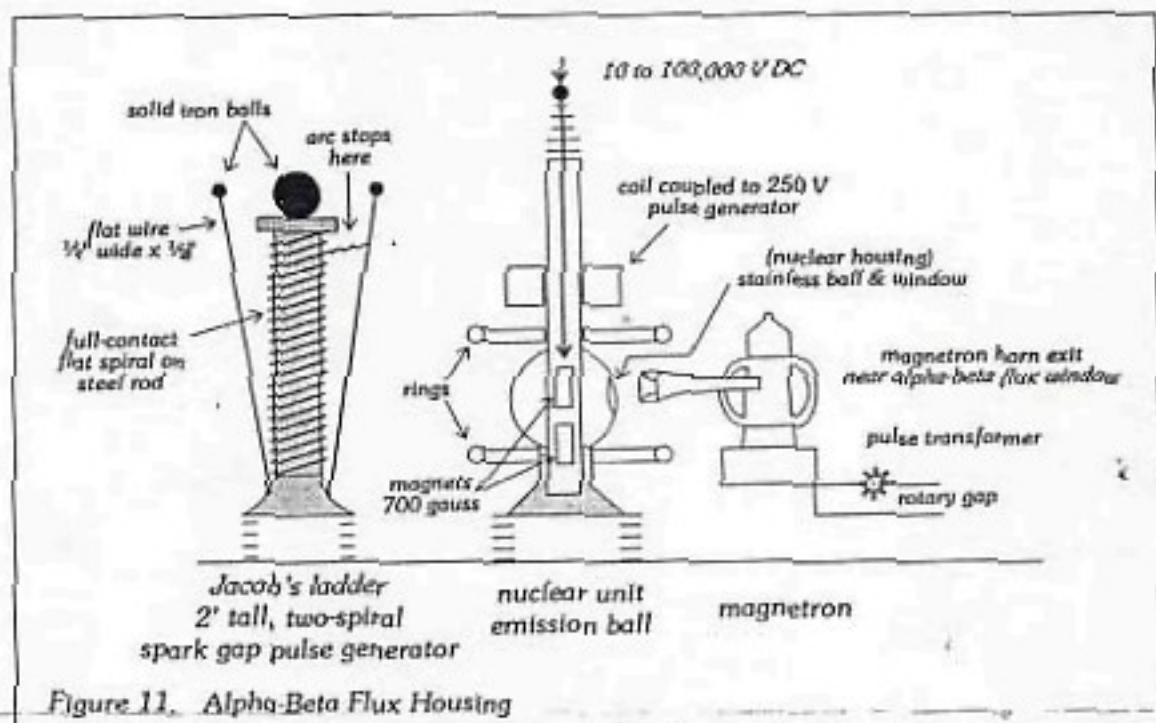

Figure 11 is a cutaway showing the nuclear section in the center of a Tesla coil. Note how I have the feed horn close to the window area. This area was also bathed in a 30,000-volt static electric field plus a weak magnetic field of only 700 gauss which was variable. A two-spiral spark gap unit is also shown in Figure 11.

The radioactive material to provide alpha-beta emissions was contained in a stainless steel ball which had a thin window section. A four-

gigahertz magnetron pulsed by an old rotary spark gap system sent microwaves by the window exit section. Small masses were placed close to the influence of the alpha-beta flux. The radioactive source was also under high-voltage DC and pulsed coils (50,000 to 100,000 turns) to produce traveling wave type magnetics and electrostatics to assist alpha-beta flux bunching and guidance. This all interacted with other surrounding equipment. Some additional arrangement is shown in Figure 12.



Magnetics

A current limiter was used on "Big Red," a fifty-kVA, 89,000-volt transformer. A five-Hz spark-gap discharge went simply to a copper ground plate. The plate was movable and placement of the plate proved successful to later experiments.

My current limiter was made from 4" by 4" laminations stacked fifteen-inches high and number-eight wire wound six layers thick. The pulsing of the iron core proved its worth in tests. Its location was near the heart of my apparatus. Because it was a heavy unit, casters were needed to move it. The units pulse affected the electrostatics and Alpha flux, when close. The Alpha flux dropped off at two feet. Two other units in the set-up were double-loop brass ship antennas five-feet high, as shown in Figure 13.

These are some basics of my laboratory. I excluded RF generation and coupling and all the radar-jamming devices I used later. I could precisely set up a pattern at 2000 MHz at 100 milliwatts. I could give or take (\pm) 1000 MHz, add pulse rate, CW or modulation of any form.

Placement geometry is of great importance to key units of the electrostatic field and spark gaps. The electrostatic field must cover all components. Helping to do this are copper balls mounted on insulators. The large ball keeps its charge longer while small ones discharge faster. In a way, you have a pulse network working along with dynamic electricity, and the small influence of the 250-milliwatt magnetron close to the alpha-beta flux. In the zone is weak magnetics, permanent magnets,

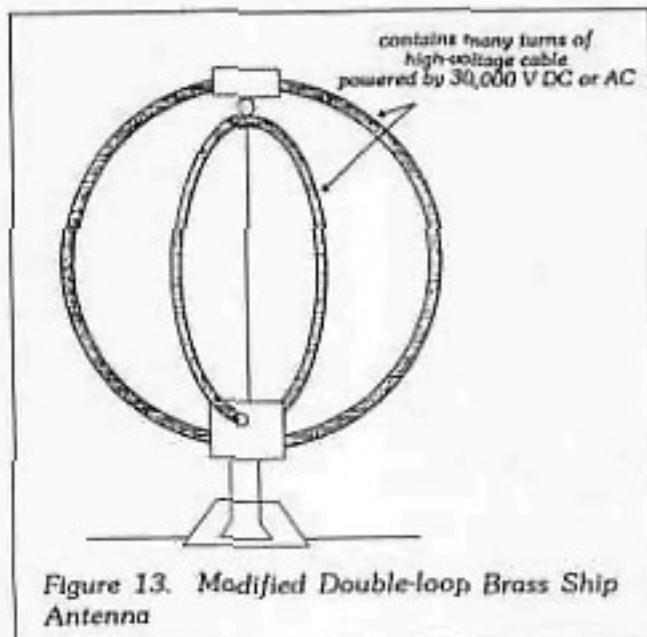

and electromagnets of the traveling wave tube (TWT) barrel types. Thus, perhaps a transformation takes place on the subatomic level in all of this, and a conversion zone takes form from the surrounding equipment. This zone seems to transform again to zones beyond the lab, up to 500 feet away, in the form of a cylinder. There appeared to be a zone at a distance of fifteen feet. Samples placed in it sometimes levitated or broke apart.

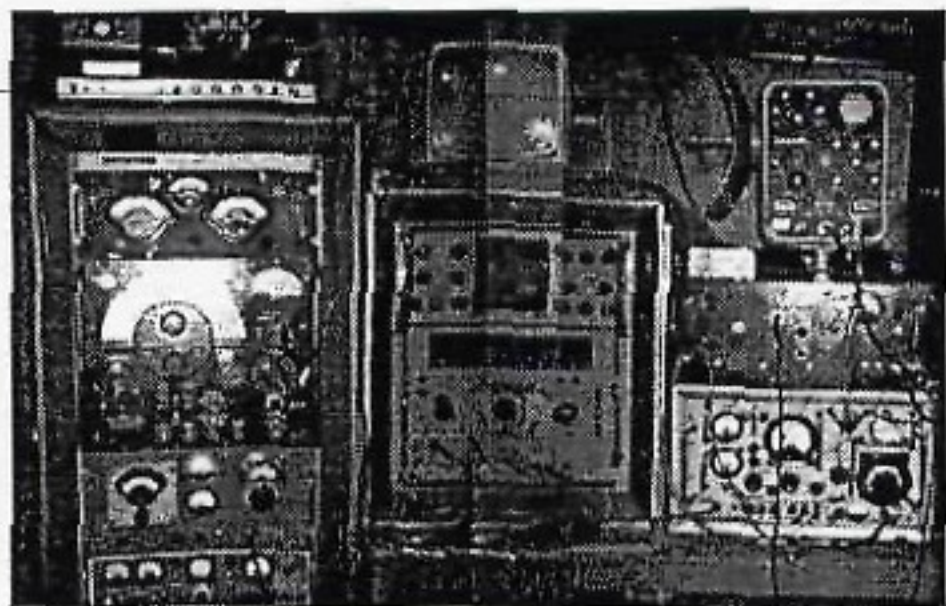

Figure 14. Hutchison's Set-up of Receivers and Monitors

Sample Reactions (Extracted from Reports)

The effects of unexpected field interactions are shown in *Figures 15 and 16*. One sample, a piece of aluminum four-inches long by 1/2-inch square, had been shattered in the center. It would be expected that only a few watts were in this zone, compared to the 4000-watt input feeding all the equipment. Our sample had exploded from inside out, torn into thousands of filaments. The filaments measured .010" to 0.50" long and .008" to .012" thick. The event volume expanded outward from the mass center in seeming reaction to a force of mutual repulsion between filaments.

The field lines picturesquely frozen in the aluminum filaments are functionally identical to those we observed at a point of fracture of a permanent bar magnet of the same geometry. The force exerted on the aluminum filaments was sufficient to split a large number of the outermost strands and fold them back along the "field lines" to such a degree, that layers of them are compacted together, against the solid surfaces of the sample.

The material within the event volume was much harder and quite brittle compared to the original extrusion alloy, which was quite soft. All surfaces evidenced a mottled appearance and regular struc-

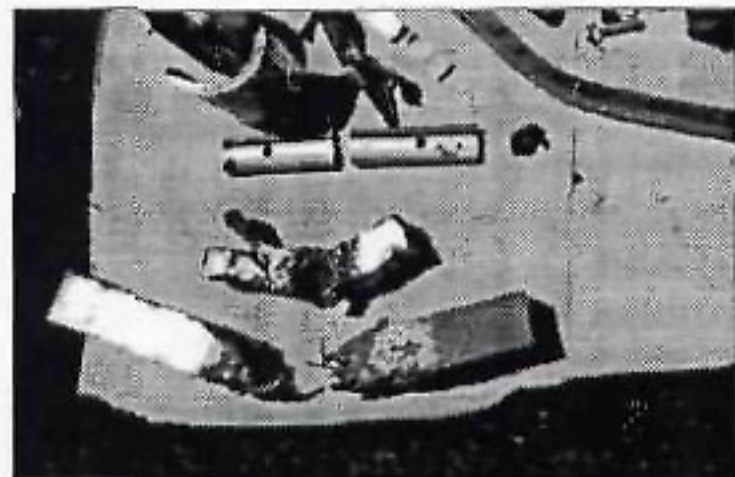

Figure 15. Aluminum and Brass Bars After the Effect

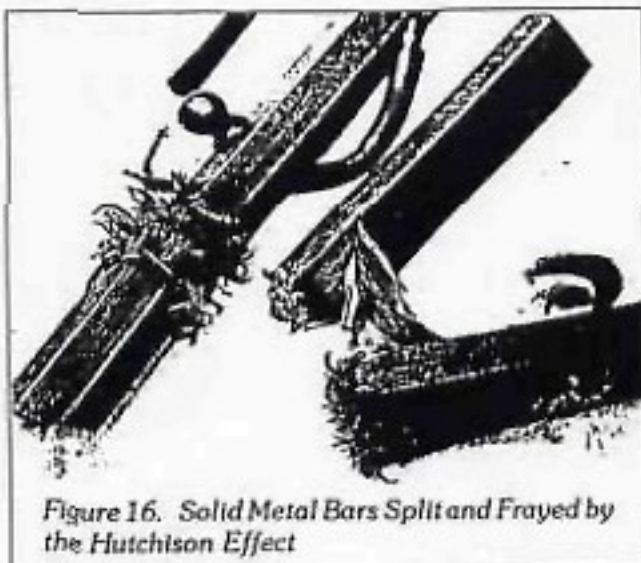

Figure 16. Solid Metal Bars Split and Frayed by the Hutchison Effect

ture, while having none of the characteristics associated with plastic deformation or melting. Physical characteristics were typical of crystalline materials sheared along bonding planes. The number of filaments probably exceeded 100,000, effectively increasing the surface area within the event by tens of thousands of times.

Another sample showed inexplicable material mixtures: wood was found in an aluminum block tested by Siemens Laboratory, Germany. Also, dense, impossible alloys of elements forming unknown materials were found by work of Max Planck Institute, Germany. Because so many different effects happen, including levitation, we can speculate the RF and support field operators are working in a narrow region of the "zone of effects." These random events sometimes happened at about five-per-hour in 1987, '88, and '89.

It is an unpredictable probability for all operators to synchronously combine to cause an effect. For events like slow lift and slow disruption, the operators combine under simple stable outputs, amplitudes, and frequency. Our space-time window would have to be described on the subatomic level for the understanding of the Hutchison Effects.

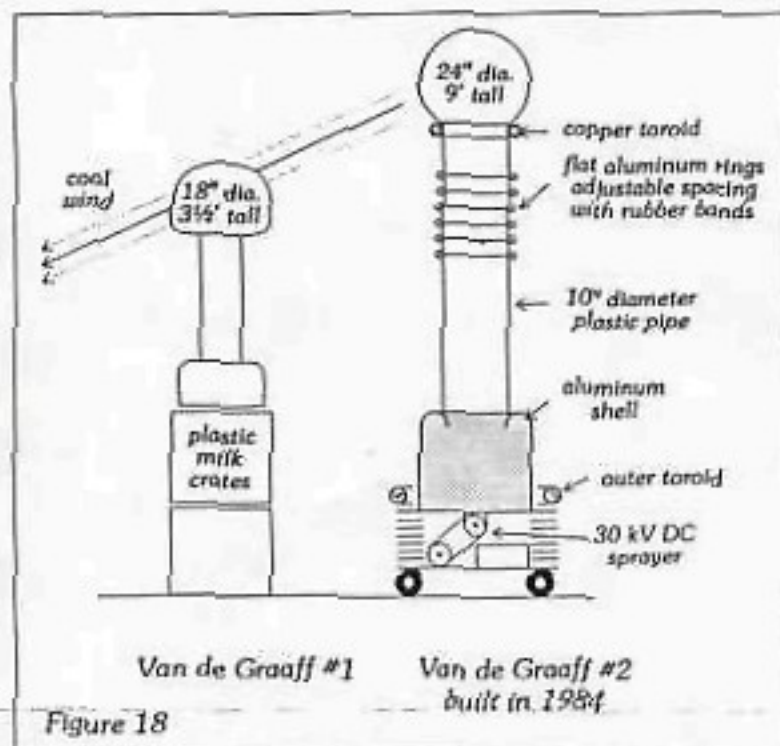
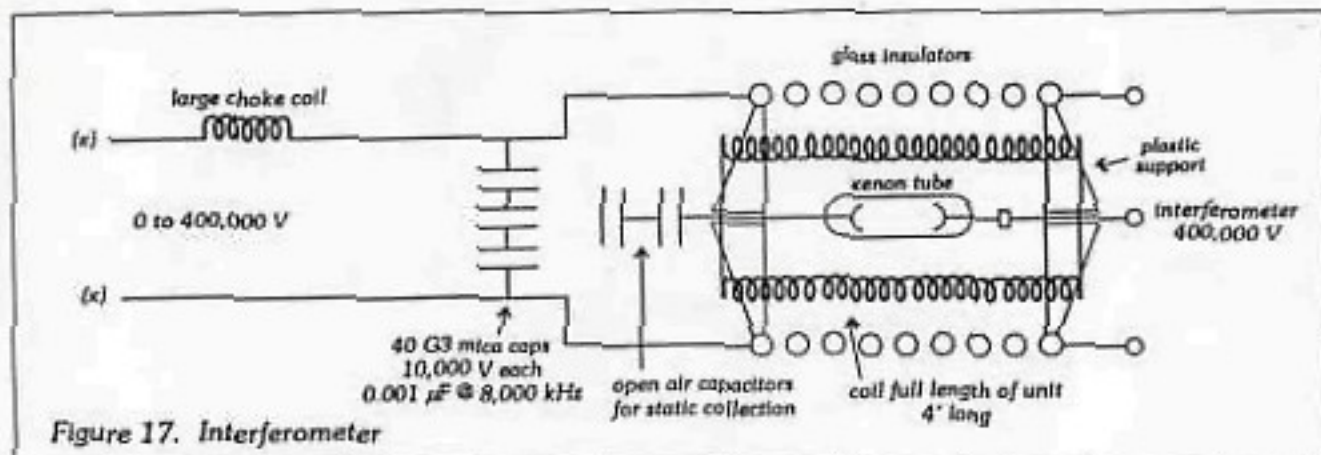

Figure 17 is another pulsing circuit device I call the interferometer. Electrostatics were produced with two Van de Graaff generators. When arranged as shown in Figure 18, cool wind effects could be produced. These machines were used to impose an electrostatic field in the test area.

Acknowledgments

I would like to thank those individuals associated with Pharos Technology, the Max Planck Institute, Los Alamos, McDonnell Douglas, BAM Labs Germany, Fraunhofer, the Austrian and German groups, the DOD groups, and individual input from Japan, Greece, England, Canada, USA, Switzerland, France and the Yin Gazda International Filmmaker, for the interest and support they all have shown.

About the Author

John Hutchison is the classic independent individual experimenter—the "Sorcerer's Apprentice." Mr. Hutchison can be reached by mail at 911 Dublin Street, New Westminster, British Columbia, Canada, V3M 2Y5 •

The Hutchison effect - a lift and disruption system

George D. Hathaway

reprinted from: *New Energy Technology*, published by the Planetary Association for Clean Energy, 1990, p. 77-103.

The following may shed light on a most unusual phenomenon which we have called the "Hutchison Effect". It is a very strange arrangement of technologies including those of Nikola Tesla and Robert Van de Graaf. This is a topic that is very conducive to wandering because it brings in all of the most amazing kinds of effects that one would love to have in their basement, such as material levitating and floating around, being able to break steel bars without the use of your bare hands, and all sorts of other weird and wonderful things.

Pharos Technologies Ltd. was a company formed by myself and a gentleman by the name of Alex Pezarro, who you may recall made a presentation at the 1983 2nd International Symposium on Non-Conventional Energy Technology in Atlanta. Alex talked about one of his pet projects, which was oil and gas discovery by novel means. In 1980, we formed this small company to try to promote what we then called the Hutchison Effect. We also termed it in our early presentations: LADS or the Lift and Disruption System. The following series of graphs were created in 1984 to present to various parties interested in funding this technology. The first graph indicates the topics covered in these presentations.

I A INTRODUCTION - HISTORY

L.A.D.S. IS CAPABLE OF :

- INDUCING LIFT AND TRANSLATION IN BODIES OF ANY MATERIAL
 - SEVERELY DISRUPTING MOLECULAR BONDS IN ANY MATERIAL RESULTING IN CATASTROPHIC DISRUPTIVE FRACTURING
 - CAUSING CONTROLLED PLASTIC DEFORMATION IN METALS
 - CREATING UNUSUAL NUBRA-LINE LIGHTING EFFECTS IN VAC-UUM
 - INDUCING APPARENT LARGE-SCALE MAGNETIC MONOPOLES IN METALS
 - CAUSING CHANGES IN CHEMICAL COMPOSITION OF METALS
 - OTHER LONG-RANGE EFFECTS
- } PROPULSIVE
- } ENERGETIC

ALL AT LOW POWER AND AT A DISTANCE !

The Lift and Disruption System or the Hutchison Effect is divided primarily into two categories of phenomena: propulsive and energetic. The system is capable of inducing lift and translation in bodies of any material. That means it will propel bodies upwards, and it will also move them sideways. There are actually 4 kinds of trajectories which are capable of being produced and I'll explain these shortly. It also has very strange energetic properties including severely disrupting inter-molecular bonds in any material resulting in catastrophic and disruptive fracturing, samples of which are described here. It is also capable of causing controlled plastic deformation in metals, creating unusual aurora-like lighting effects in mid-air, causing changes in chemical composition of metals (it varies the distribution of the chemical content), and other long-range effects at distances up to around 80 feet (24 metres) away from the central core of the apparatus -- all at low power and at a distance.

I INTRODUCTION + HISTORY

- UNPRECEDENTED ACTIVITY FROM A SINGLE SYSTEM
- TRUE SYSTEM WITH MANY INTERRELATED PARTS
- DEVELOPED TOTALLY FORTUITOUSLY FROM EXPERIMENTATION WITH EARLY A.C. AND STATIC MACHINES
- BASED ON IDEA OF INDUCING "SWIRL" OR ROTATION IN EM FIELDS
- EARLY EVIDENCE OF POWER OF L.A.D.S.
- PHASE 0 DEVELOPMENT OF PROGRAM BY PHAROS TECHNOLOGIES LTD.
- UNPREDICTABILITY OF L.A.D.S. IN EARLY TRIALS
- RE-ESTABLISHMENT OF L.A.D.S. LAB UNDER PHASE 1 PROGRAM
- SUCCESS AT RE-CONSTRUCTING L.A.D.S. IN NEW ENVIRONMENT

II VISUAL EVIDENCE - FILM + STILLS

- OVERVIEW OF CROGGED, PRIMITIVE ORIGINAL LAB
- STATE OF ORIGINAL SET-UP
 - POOR CONNECTIONS
 - HAND-MADE COILS etc.
 - LACK OF INSTRUMENTATION
- DIFFERENCE BETWEEN ORIGINAL AND LATEST LABORATORIES
- BASEMENT OF HOUSE - L.A.D.S. DRAMS INDIUM OF 2.5 cm. FROM HOUSE PAINTS
- BEST LIFT EPISODES IN EARLY BASEMENT LAB
- POOR PHOTOGRAPHIC RECORD IN EARLIEST TRIALS
- HIGHLIGHT - BURNOUT OF AMPATURE + FIELD COILS OF SABRE SAW
- MANY MATERIALS CAPABLE OF BEING SELECTIVELY INFLUENCED
- INDEPENDENT, QUALIFIED WITNESSES.

The system is a single entity, made up of many discrete components. It has many interrelated parts, unfortunately continually being added to by the inventor. It was discovered fortuitously by Hutchison, who was experimenting with early Tesla systems and static machines such as Van de Graaf generators.

The earliest explanation was given by Mel Winfield of Vancouver, whose name may be familiar from Dr. Nieper's 1988 Congress in Germany. He suggested that the explanation for the phenomena was due to a method of making the electro-magnetic fields spin or swirl in some unknown way.

Pharos Technologies was involved in three phases of development, the first phase of which was in the basement of a house in Vancouver. This is where John Hutchison's original work was done. The collection of apparatus which will boggle the mind can be seen on the video (shown during the lecture and available from the publisher) and replicated in Figures 11 and 12. That was the Phase 0 development. Phase I was when we stepped in with some money and took the equipment from the original location and put it in a more reasonable setting. Phase II was a third location prior to its being dismantled and put into storage by John.

The main thing about this technology, apart from its unusual phenomenology, is that it is highly transitory. The phenomena come and go virtually as they please. One has to sit with this apparatus from between six hours and six days before one actually sees something occurring. This makes it virtually impossible to interest someone who would like to try to develop it, to assist in funding, for instance. You can't assume that someone will sit there who is ready to help develop a technology, and have him wait and wait, and perhaps nothing will happen. It's unusual to ask someone to wait six days for a phenomena that they're interested in developing commercially. So one can imagine that we've had some difficulty in the past in financing this program.

Note in Figure 11 one of the Tesla coils in the foreground. The main coil is 4 1/2 feet (1.4 m) high. It was extremely difficult to get around in the first lab (Phase 0). The first laboratory in Vancouver was so densely packed with equipment that you could not find a place to put your foot down. You had to step around all sorts of objects that were put on the floor.

Disruptive phenomena

In the video a bushing is shown breaking up. It was a steel bushing about 2 inches (5 cm) in diameter by 3 to 4 inches (9 cm) long. John still has that in his lab and I have some to show as well (Figures 1 and 2) .

The next part of the video is well known. I will try to explain some of its phenomenology. It starts with John warming up the system. To determine where the optimum place for positioning the test objects, which will either take off or burst, he put coins and bits of styrofoam where he believes is going to be the active zone. The first thing that happens is a quarter (\$.25 coin) starts to flip and vibrate. Now he knows he should concentrate putting specimens in that zone and he does so. We see some water in a coffee cup that appears

to be swirling, although it's not. It is merely the surface rippling by some electromagnetic means and the coffee cup is dancing around the top of a yellow milk carton. It's another way for him to determine where the zone is. Then we see a flat file 8 inches (20 cm) long breaking apart. This file broke into four more or less equal-length sections. Normally, if you break a bar magnet, you know that you break it north-south, north-south, north-south, etc.. So the parts tend to stick back together again. In this case the segments were magnetized the wrong way by some phenomena I do not know and they repel each other when they're put together at the breaks. This may be indicative of the development of large-scale monopolar regions that are of such intensity that they disrupt the material itself. It's as reasonable an explanation as I've been able to come up with, or anyone else.

Lifting phenomena

We then proceed to document some lifting phenomena. The objects that are lifted in the first part of this section are on the order of a few pounds. All of them lift off with a twist. They spiral as they lift off. There has to be a particular geometry with respect to down (gravity) for them to take off. Some objects, if you lie them on their sides, won't take off. If you turn them on their ends, they will take off. The geometrical form of the objects, their composition and their relationship to their environment, the field structure around them that is being created by the device, all play a part in how these things take off.

There are four main modes of trajectory that these objects can follow if they do choose to take off. There's a slow looping arc where the objects will basically take off very slowly in a matter of a couple of seconds and loop and fall back somewhere. It is almost as if the Earth moves underneath them while they are in flight, and they fall back in different locations. The second type of trajectory is a ballistic take-off. In other words, there's an impulse of energy at the beginning of the trajectory with no further power applied to the lifting thereafter, and the object hits the ceiling and comes back down. A third type of trajectory is a powered one where there appears to be continuous application of lifting force. I have some evidence taken from the video. The fourth trajectory is hovering - where objects just rise up and sit there. The objects can be of any material whatsoever: sheet metal, wood, styrofoam, lead, copper, zinc, amalgams and they all either take off or they burst apart, or they do nothing -- that's 99% of the time.

Lighting phenomena

Following that is a strange lighting phenomenon. This only occurred once but fortunately, while John was filming. Incidentally, this early film, with the most spectacular results observed, was taken by John himself. It was taken in 1981 and all of a sudden a sheet of iridescence descended between the camera and some of the apparatus and one sees that sheet of light. It has a strange pinkish centre to it and hovered there for a while, and then disappeared. John thought he was hallucinating,

but when we developed the film it turned out something was definitely there.

In this same video, we observe heavier objects taking off, including a 19-pound (8.6 kg) bronze bushing and water in a cup that's dancing around, the surface of which is vibrating. There are no ultrasonic or sonic devices in this particular series of experiments. There are no magnetic components underneath or over top. There are no field coils underneath or over top or anywhere within 6 feet (1.8 m). These images were taken while the apparatus was performing at peak, and shows best results for the earliest experiments.

Sometimes, instead of lifting objects, John will purposely try to destroy them. In one case, a 1/4" round rattrail file rests on a plywood base and is held down from taking off by two plywood pieces. Beside it are some quarter and penny coins. The file is glowing white hot and yet there is no scorching of the wooden plywood pieces which are holding it down. Neither are any of the coins affected. This is explainable in terms of RF heating theory because you can have eddy current heating on the surface and it's almost cool to the touch very shortly thereafter. It's still unusual that there is no conductive heat transferred to the wood.

From time to time there are scorch marks on the boards from other experiments. The apparatus makes fire spontaneously in parts of the lab if you're not careful.

The original (Phase 0) lab set-up was primitive, crowded, had poor connections, and had hand-wound coils. However, the films that have most of the best lift episodes were done in this early set-up, drawing a maximum of 1.5 kilowatts continuously from house-mains.

Disruption effects

- A VARIETY OF CONFIRMATORY PHYSICAL SAMPLES

INCLUDING :

WATER

ALUMINUM

IRON, STEEL

POLYBROMIN STEEL

WOOD

COPPER, BRONZE

• COMBINATIONS OF ABOVE

- ALL SHAPES, SIZES, AND PHASES

- CERTAIN MATERIALS SUBJECT TO CERTAIN INFLUENCES PREFERENTIALLY

RESULTS OF PHYSICAL, CHEMICAL AND ENERGETIC ANALYSES

- R.C. INSTITUTE OF TECHNOLOGY :

- HARDNESS

- BRITTLENESS & DUCTILITY

- OPTICAL MICROSCOPY

- R.C. HYDRO R/D LABORATORY :

- SCANNING ELECTRON MICROSCOPY

- ENERGY DISPERSIVE ANALYSIS

- U. of TORONTO DEPARTMENT OF METALLURGY :

- SCANNING ELECTRON MICROSCOPY

- ENERGY DISPERSIVE ANALYSIS (X-RAY)

- LOS ALAMOS TESTS

The disruption part of this Lift and Disruption System has produced confirmatory physical samples that include water, aluminum, iron, steel, molybdenum, wood, copper, bronze, etc., with many shapes, sizes and masses. Certain materials are subject to certain influences depending on shape, composition and other factors.

We have tested various pieces that have broken apart for hardness, ductility, etc.. We have used optical and electron microscopes. We have taken SEM's with EDA's (Energy Dispersive Analysis) to determine the composition at various points.

Two samples of aluminum are shown, one of which is in the centre of Figure 1, which is twisted up in a left-handed spiral, and in Figure 2 on the left which was blown into little fibers. Lying on the ruler in Figure 1 to the left of centre is a molybdenum rod used in nuclear reactors. These things are supposed to withstand temperatures of about 5,000 °F. We watched these things wiggle back and forth, and stopped the apparatus halfway through a wiggle and that's the result. Figure 2 (left) shows the piece of cast aluminum that burst apart.

In general, Figure 1 shows a collection of pieces of metal that have been blasted apart or twisted. The largest piece (in the background) is about 12 to 13 inches long. It's two inches in diameter, of regular mild steel, and a 3/8 of an inch long part was blasted off the end and crumbled like a cookie. Fragments have been analyzed to have anomalously high silicon content although the original material was not a silicon steel. The standing piece on the left is 5 - 6 inches tall, 1 and 1/4 inches in diameter. It is a piece of case-hardened steel. The case-hardening has been blown off at the top and about 3/4" of it vapourized during an experiment. Then there are various pieces of aluminum and steel. On the right of Figure 2 is a boring bar. You can still see the old tool bit that John was using through it. It was on a shelf about 10 feet away from the centre of the apparatus and he did not see it happen. It just bent up into a tight U and deposited a quantity of copper at the bend. The copper seemed to somehow magically come out of the solid solution, if it was ever in solution in the first place, and agglomerate as globs at the break. As far as the aluminum is concerned, it's a volume effect, not merely an eddy-current surface effect. The whole thing is blasted right through.

Figures 3 to 6 show some of the scanning electron microscope photos taken by the University of Toronto. Figure 3 shows an aluminum specimen at about 70 times magnification and the whole surface is torn apart, as if it was gouged randomly by some mechanical means. It has not been smoothed and polished and subject to x-ray or dispersion analysis yet. A piece of iron is shown in Figure 4, and was analyzed for composition which showed anomalously high amounts of copper.

With a little higher magnification for Figures 7 and 8, we see what happens in a polished aluminum sample under the SEM. Figure 7 shows two main horizontal fracture zones.

This is a polished sample, that is why it looks nice and clean. Notice the unusual globules forming (positions B & C). We examined these particular globules and they're virtually pure elements. One is copper, another is manganese and others are different elements. These globules seem to arrange themselves along planes and these planes are no doubt the ones that split apart and delaminate into fibers.

Figures 9 and 10 show the relative elemental abundances of locations H and D of Figures 7 and 8. Normally, the aluminum comes out looking like Figure 9. The average is mostly aluminum, of course, but with a bit of copper in it. And yet (Figure 10) shows an area around where the fractures occur and we see we have actually located one of the copper blobs, plus some chlorine from our fingers. Usually you see some chlorine and sodium from salt in your hands if you're touching samples. It's certainly telling us that something unusual is happening. I have not seen another apparatus which makes the alloying material in an alloy come out of the solid solution. Usually it's totally dispersed in the melt but in this case we're "undispersing" it somehow.

The Pharos experimental set-up for the Hutchison effect

PHASE I: PHYSICAL LAYOUT

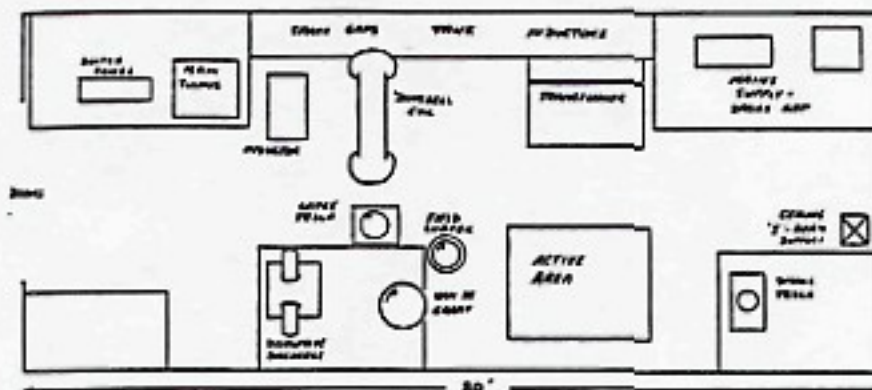

This plan view shows the first (1983) set-up under Pharos' control.

Increasing propulsive power is being applied to this as witnessed by this increasing acceleration curve. These are the actual measurements to about 0.16 seconds and beyond is an extrapolation. The -9.1 in the acceleration equation is merely an artifact of my measuring problem, analyzing that film strip. Keep in mind, this means that when it hits the ceiling, this 19 lb. bushing is traveling at 20 m/sec. (45 mph, 72 kmh) and increasing!

I am at sea in trying to determine how the device can provide a lift. In this "Theoretical background" listing, I mention a few names that might have something to do with an explanation of it.

DISCUSSION OF CURRENT & EARLY THEORIES IN
CLASSICAL & QUANTUM PHYSICS

<u>ENERGETIC EFFECTS</u>	<u>PROPULSIVE EFFECTS</u>
- G. LEBON	- HOOPER
- VALLEE	- HOLT
- BOYER	- GRAHAM & LAHOZ
- PRIGOGINE	- ZINSSER/PESCHKA

PLUS MANY OTHERS NOT MENTIONED HERE

Finally here is a listing of a few potential applications of this effect if it can be produced in such a format that it is repeatable and controllable: rocket payload assist, materials handling and warehousing, floating things into position, materials handling of hot objects, objects that are highly radioactive or dangerous, forging and casting, extruding of metals, alloying, power production, conversion, etc., and defence applications.

In conclusion, this is an extremely difficult technology to wrap one's mind around. I have had a great deal of difficulty in convincing scientists to think about this possibility, let alone try to provide some mechanisms for understanding its operation.

APPLICATIONS

- PROPULSIVE : - MICRO-GRAVITY ENVIRONMENTS ON EARTH
- ROCKET PAYLOAD BOOST ASSIST
- MATERIALS HANDLING & WHAREHOUSING
- ENERGETIC : - FORGING, CASTING, EXTRUDING OF METALS
- ALLOYING
- POWER PRODUCTION, CONVERSION & TRANSMISSION
- OTHER : - DEFENSE APPLICATIONS
- ETC. ETC. ETC.

I hope I'll be able to engender some interest so that people will think about it. Perhaps some will, if they have some equipment, do some experiments as well.

I must caution anyone who is pursuing this that it is an extremely dangerous apparatus. It has never knocked any of my fillings out, but it certainly has a potential for doing so. It has smashed mirrors, in one of its incarnations, 80 feet away. It has overturned a large metal object about 50 or 60 pounds about 100 feet away. And its effects can't be pinpointed unless we're lucky. We try to find the active area and then we hope that something will happen but perhaps something very far away will happen. The apparatus is capable of starting fires anywhere. It will start fires in concrete, little bursts of flame here and there and it will cause your main circuits to have problems. We've blown fuses out as well as circuit-breakers and large lights.

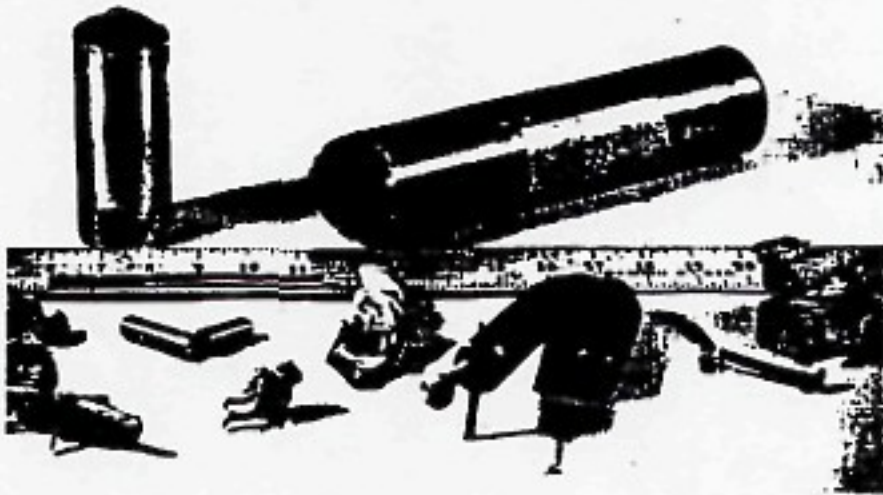

Figure 1. Examples of disruptive phenomena, including a broken bushing.



Figure 2. Two samples of disruptive phenomena: contorsion and segmentalisation.



Figure 3. Aluminium specimen from one of John Hutchison's experiments October 1984 (70x magnification)

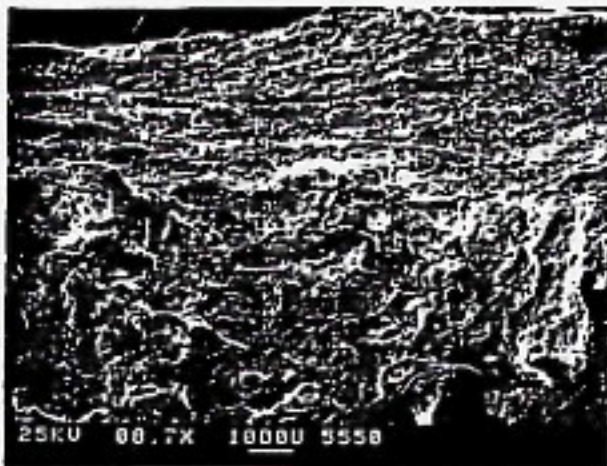

Figure 4. Fractured iron rod/bar which includes regions which were mapped by x-ray: see also figures 9 and 10

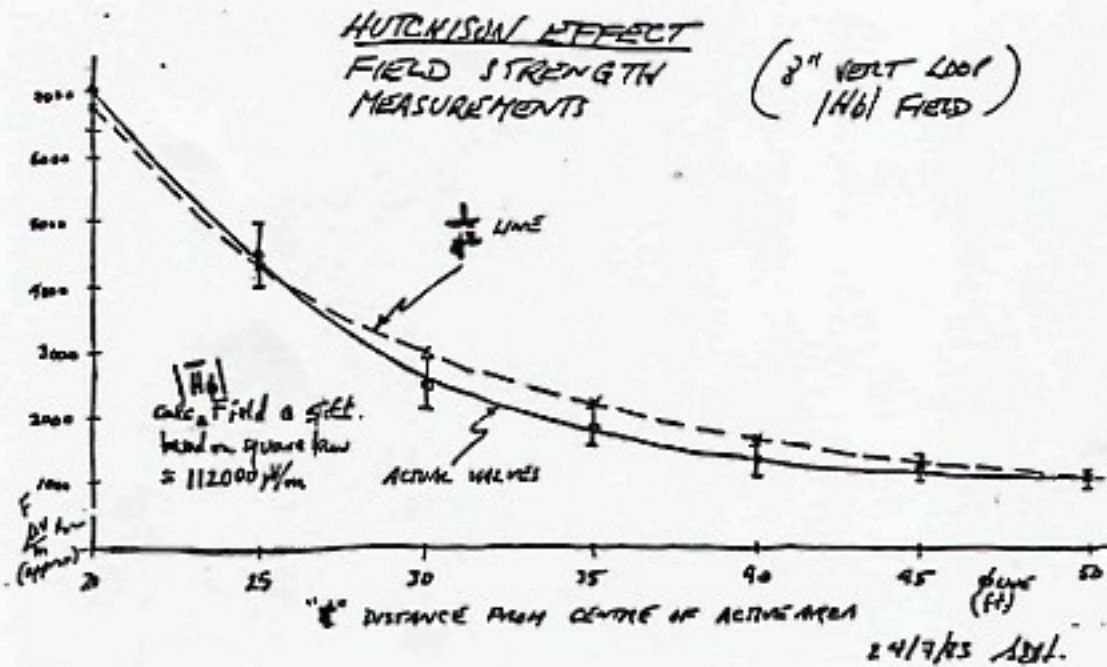

Figure 14. Field strength measurements during Hutchison effect experiments at about 350KHz, showing strength versus distance from source

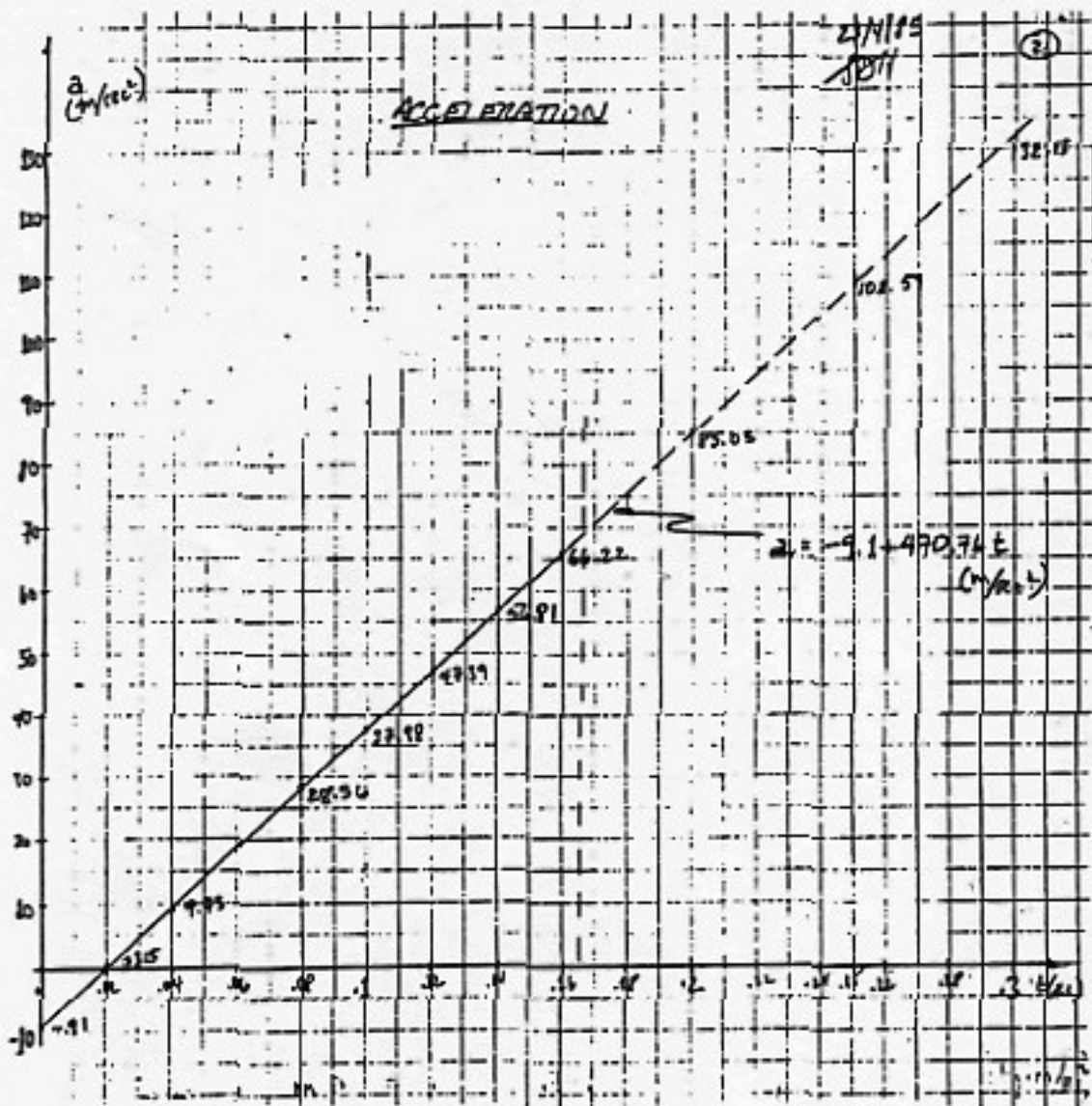

Figure 16. Plot of linearly-rising powered take-off of a 19 pound bushing calculated on an acceleration / time graph.

HEPPE

Letter from Jack Houck

February 28, 1991.

Your recent letter to me suggests you are experiencing more paranormal phenomena than the "normal" people do. Of course you know this is of great interest to me. I meet a lot of people in paranormal research activities who describe similar experiences. In general, you are having your mind to out and access (connect) with remote people and things. I am enclosing my original model paper which provides a way of thinking about how the mind can go out and access remote information. I know I sent this paper to you years ago, but it may have been misplaced with all the international traveling you have been doing.

The key point is that you can learn to control when and where you want your mind to go. Similarly, you can be open to another (e.g., Larry or Yin) accessing your thoughts or you can block that by simply mentally putting those thoughts you do not want others to access in a safe, and *close the door*.

I think that it is good to have the capability to sense things, like electromagnetic fields, when you want to. This can be controlled by setting a goal, making a mental connection to that goal, commanding it to happen, and then letting go (allowing it to happen). These are the same basic instructions I use to teach people to bend metal with their minds. The instructions work reliably when you understand how this can work, and practice. The same applies to creating additional energy in a generator. In many of your experiments there is a lot of "normal" energy around (e.g., your microwave radar). I think you want something to happen -- the goal!! Your mind goes out and coheres the local available energy which then creates a force which attempts to achieve the goal. The letting-go step seems to be the most important from all my research and you seem to do that very well. Improving your reliability requires a lot of practice, a good model, and *not thinking* about it too much. Further, by making your goals very precise and specific, this process can be perfected. Creating a peak emotional event at the time you want the phenomena event to happen also seems to be an important ingredient.

I have always said that it would be nice to have a temperature sensing device on a woman who sees her child under a car. As she lifts the car off the child, I think there will be a 20 degrees drop in the local air temperature. Clearly, she has a goal -- get the car off the child. This is a peak emotional event. She does not think about not being able to lift a car. The thermal energy in the air is extracted and a force is cohered which helps her lift the car.

John, I hope this information is useful and good luck in your continued research. Say "Hello" to Yin for me.

**Vancouver experimental observation
by Jack Houck**

Col. A. B. SCANNED
TATS JACK HOUCK

August 1985

Section 1: Summary and Conclusions

During the year 1971, John Hutchison set out to build some *Tesla coils*. He also is a collector of old high voltage and static electricity generating equipment, as well as a gun collector. One evening while tinkering with this equipment, creating large sparks and high voltage effects, he was struck on the shoulder by a piece of metal. He threw it back toward where it came from and it struck him again. He had accidentally created what we will call the *Hutchison Effect*. During the ensuing years, he found that by

COPIES CONTACTS JACK HOWLE OF
The Hutchison File MACDONALD DOUGLAS

adjusting the settings on the equipment, things would levitate, move horizontally, bend, break and explode.

Hutchison met **Alexis Pezarro** and **George Hathaway** who had formed *Pharos Technologies Ltd.* in search for new innovative technologies. Pezarro and Hathaway worked with Hutchison, conducting many experiments in attempting to replicate and understand the phenomena. They also were looking for funds to perform the research necessary to apply this knowledge. The equipment belongs to Hutchison and is in his residence. The area in which the majority of the effects occur is determined empirically. Often major events occur outside the intended "target area" where test objects were placed. In the early days of their experimentation, many hovering and apparently antigravity-type events occurred.

Hutchison and the equipment have moved twice in last few years, requiring many months to again obtain effects. During this time, more power and equipment have been added to the "system". Lately, most of the observed effects have been metal exploding or bending, and objects moving horizontally or expanding and contracting. A group of scientists from Los Alamos had witnesses and experiment last year with no results.

On August 13 and 14, 1985, this author had the opportunity to witness two evenings of experiments. I had taken a number of samples to put in the vicinity of the equipment at the intended target area. Most of the samples and controls left in Southern California. I took 35 mm pictures, and rented a 1/2-inch home video recording system for documentation and assistance in observation. There were some very interesting events captured on the video tape, and some of those were observed when they happened. Aluminum foil pieces and some other samples (including plastic) were observed to slide or fall over, as if hit by an impulse at apparently random intervals throughout both evenings. At one point, one of the aluminum foil pieces appeared to move up and down, with a 1-3 second period.

I was satisfied that no fraudulence was occurring, and was impressed by the fact that most of the events were covered by the video camera. However, some of the biggest events occurred outside the intended target area. The first evening, a gun barrel and a very heavy (60 lbs) brass cylinder were hurled from a shelf in the back corner of the room onto the floor. Simultaneously, on the opposite side of the room toward the back, three other objects were hurled to the ground. One was a heavy aluminum bar (3/4" by 2-1/2" by 12"). It was bent 30 degrees. Hutchison said that it was straight at the beginning of the evening. Another object was a 15-lb brass bushing. These objects can be seen falling in the video record, but their initial location is not recorded. I am quite sure that no one was hiding in that part of the room throwing these objects. I was with both Hutchison and Pezarro during the entire experiment.

None of samples I had were affected. There was a 4 by 4 array of small magnets set up in the target area. The first evening these magnets were spread all over because a big brass cylinder fell on the board supporting them. It actually fell onto the calculator, but the calculator continued to function. However, during the second day, no objects fell

into the target area containing the 4 by 4 array, but the magnets did move around, apparently due to the same horizontal force that pushed the aluminum foil pieces off the board. More detail on the objects that moved is contained in Section 2 of this report.

Pezarro and Hutchison reported many stories about what they observed in previous experiments.

I was struck by the many similarities there were to the type of phenomena I observe at PK parties and the type of phenomena associated with other types of macro PK (psychokinesis) events. Could Hutchison be electrically stimulating the same type of energy or "fields" that are responsible for PK events? There are also some dissimilarities. This comparison will be made in a Section 3. Might they have discovered a PK amplifier? It is possible that I could be biased because of my research into the PK phenomena. Pezarro believes that they are creating some type of "field" that stimulates some energy to be dumped into the objects, or used by an object's surface to generate the observed effects. No one has a theoretical explanation for what is occurring. However, if a better understanding can be developed, then it may be possible to devise experiments whose results can be predicted. Several theoretical approaches may be relevant (e.g., [Tom E.] Bearden, Williams, [Prof. Elizabeth] Rauscher, [Prof. William] Tiller, [Prof. Jack] Dea, *et al*).

In conclusion, I believe that Hutchison is creating a real phenomena with his equipment that is somehow being stimulated by some combination of the electrical fields being emitted. Currently, the effects are so random in both time and space that it is very difficult to conduct meaningful experiments. However, if someone can figure out a way to focus the effects consistently in a target area, then much more anomalistic data would be produced. Ideas were discussed on how to accomplish this focusing. There are many other parameters involved in each of the elements of the equipment that need to be better understood in order to obtain consistent effects. It is likely that effects are being created that cannot be explained by conventional physics and, therefore, some of new models being created to extend physics, in attempts to explain anomalous phenomena, could be examined in conjunction with the *Hutchison Effect*.

Section 2: Experimental Data

On August 13, 1985, I flew to Vancouver, B.C., Canada, from Los Angeles to observe the *Hutchison Effect*. Pezarro met me at the airport and helped me get settled into the hotel. Pezarro talked about their experiments. I rented a video camera and recording equipment. We took the equipment to Hutchison's residence and set up the equipment and samples in the target area. They cannot run the equipment during the day because it disturbs all the electrical equipment of the neighborhood. The video camera was placed on a ladder, about 15 feet from the target area and cabled to the recording equipment located in another room. The room which contains the equipment has two narrow walkways, and old electronic equipment is stacked to the ceiling on the outside of both walkways.

The center of the room contains a massive amount of equipment, including a lot of power conditioning equipment, two very large *Tesla coils*, several *Van de Graaff generators* (only working as part of the "system"), a *Jacob's ladder*, and a big spark gap generator. I did not get into the details of the equipment because that is not my field, and Pezarro said there were "secret" elements. The first evening, August 13, we started the experiment at 8:45 p.m.

Table 1 lists the major events that I recorded.

Time	Event
8:45 p.m.	Start.
9:10 p.m.	Big brass bushing - 17 lbs - fall over onto the area of my samples; knocked the magnets around. Aluminum foil behind bushing was moving up and down slightly.
9:46 p.m.	Large pieces of aluminum foil fell off left side.
9:50 p.m.	Large pieces of aluminum foil fell off left side.
10:00 p.m.	Something fell off the shelf in the back part of the room (left side) as well as directly behind the target area.
10:19 p.m.	Lights and fuses blew out.

Table 1. Table of events on August 13, 1985.

Figure 1 is a sketch of the room and shows where things were generally located. It is not to scale. The direction of travel of the movement of the objects is noted in Figure 1.

Photos 1 and 2 were taken of the target area before the experiment began on August 13, 1985. The samples I had taken were on the "table" toward the front of the room (closest to the camera). There were two large metal rings hanging from the ceiling over the target area that slowly moved periodically throughout the evening.

Photos 3 and 4 were taken after the fuses blew out with only a candle to check things out. It can be seen that things in the target area had moved around. The cylinder on the second table fell over onto the first table. The major action during the first evening was toward the front of the second table. It can be seen in the photos that some of the aluminum foil moved around, and this is verified on the video tape.

Photo 5 was taken from the target area toward the front of the room capturing one of the *Tesla coils* and the *Van de Graaff generator*. This picture provides a sense of the amount of equipment and cramped conditions. Throughout the evening, Hutchison was constantly changing the settings on all of the room. Photo 6 was taken of the things that had fallen on the floor near the end of the first experiment. This photo was taken down the left walkway.

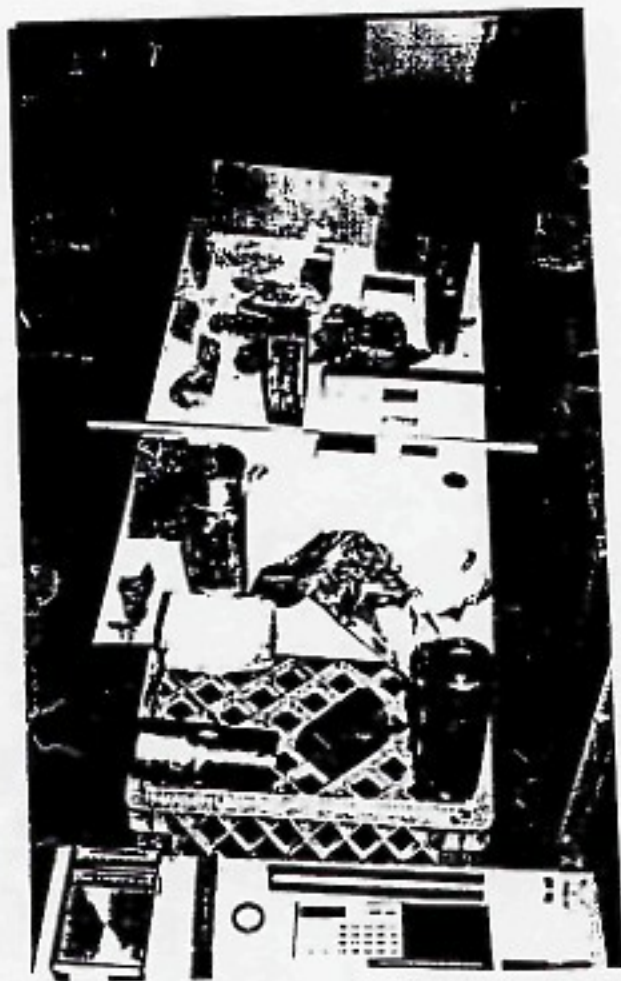

Photo 1

Target area: Hutchison samples

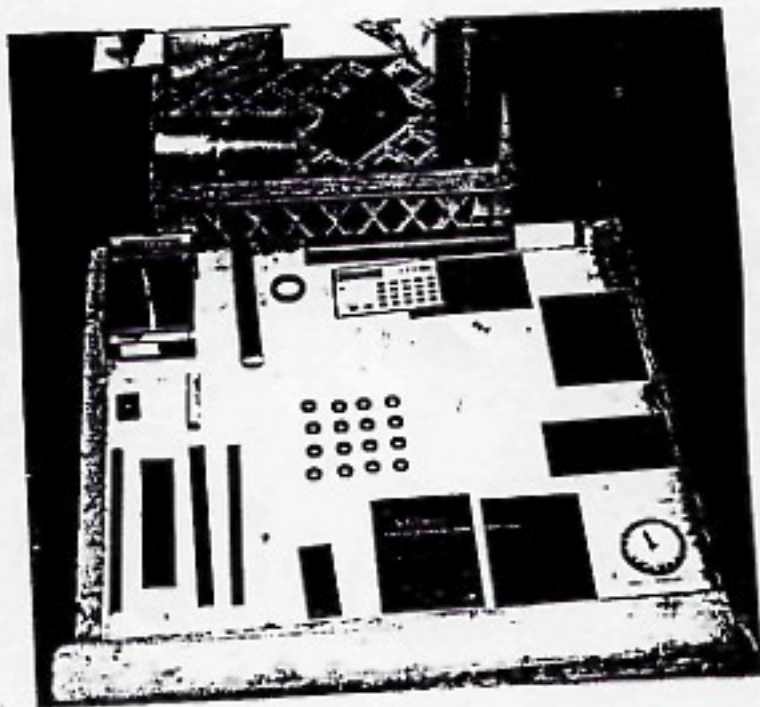

Photo 2

Target area: Jack Houck samples

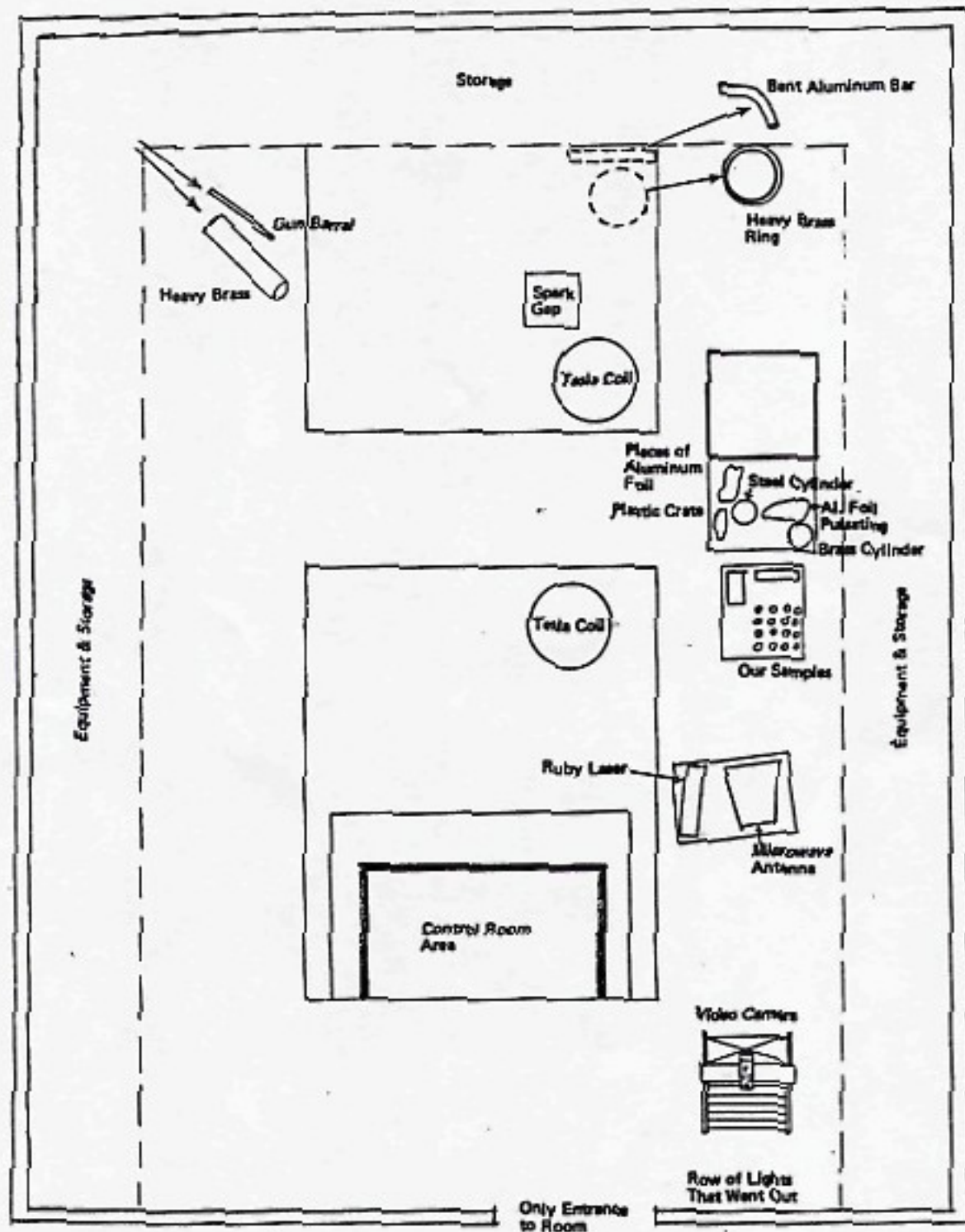

Figure 1. Sketch of the experimental set-up in room, describing location of samples, selected instruments, control area and the direction of displacement of artifacts affected by the Hutchison effect. August 13 1985. Not drawn to scale.

Mac Power Doc/AS

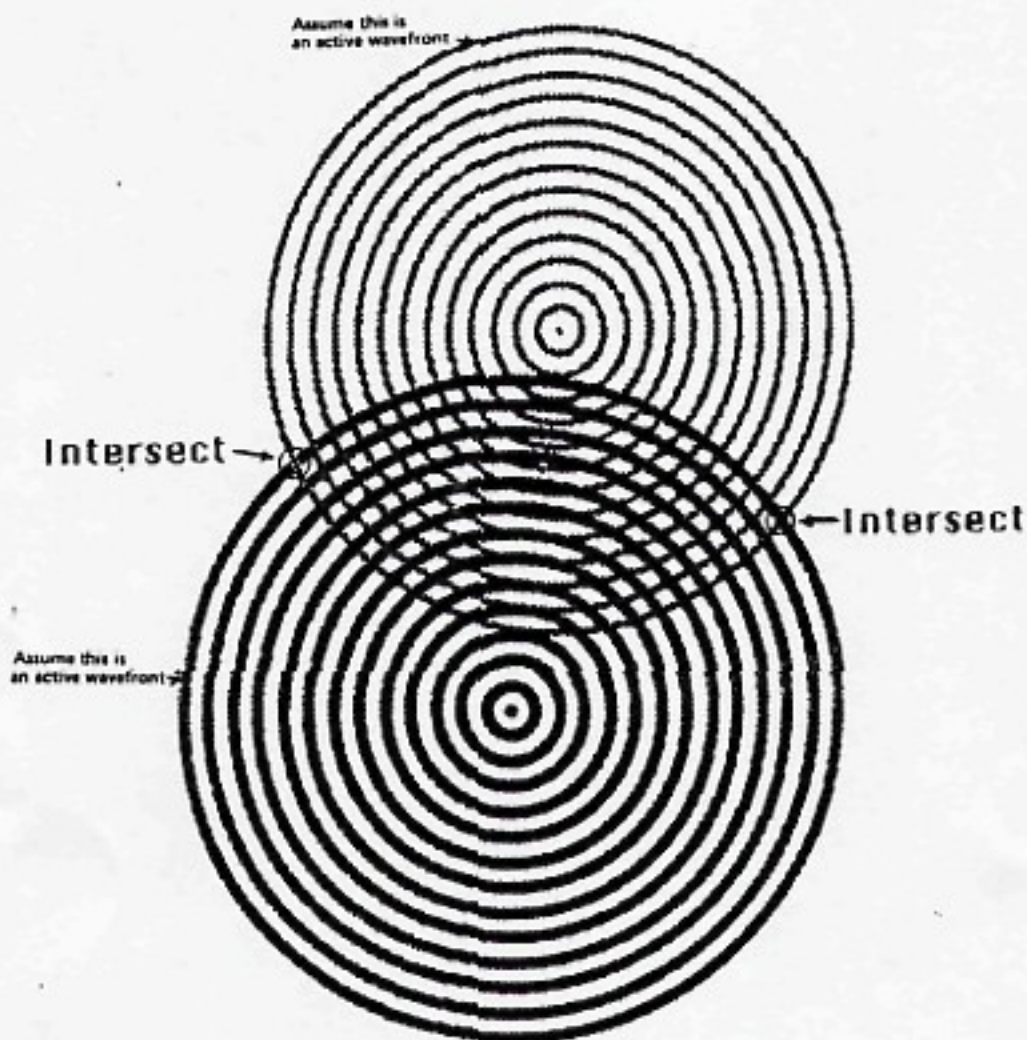

Figure 2: Wave postulation: intersection of two active monopolar antenna sourced wavefronts.

The two large events in the back of the room seemed to occur at the same time. I postulated that maybe this machine was somehow acting as two *monopole antennas* radiating waves, as shown in Figure 2. Of a wave from radiator 1, one had the right property to interact with a wave from radiator 2, then simultaneous effects should be expected at the two intersections of the circles, especially if there was something to affect at both locations. This idea prompted me to set up additional target areas in the left walkway on the second day of the experiment.

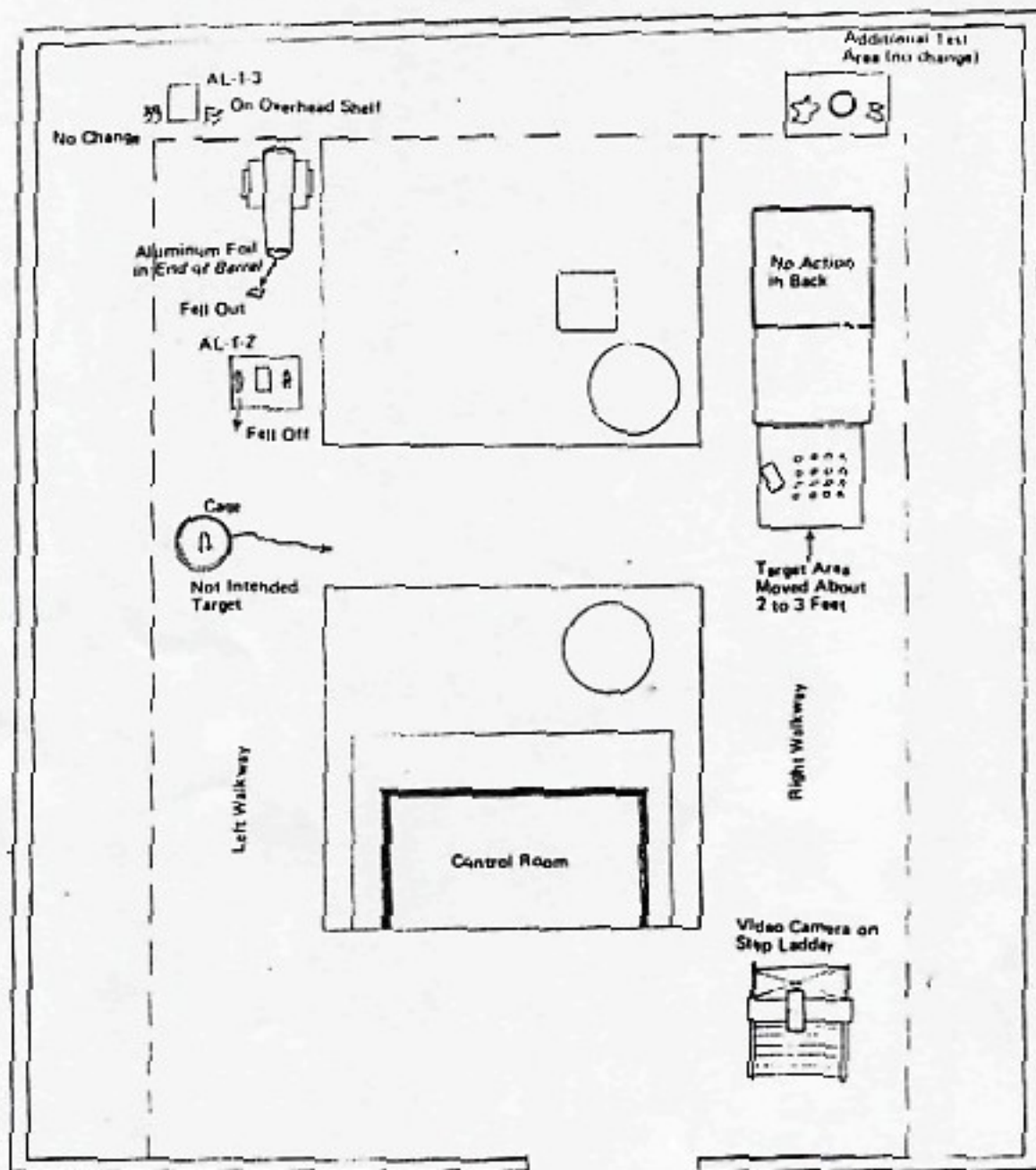
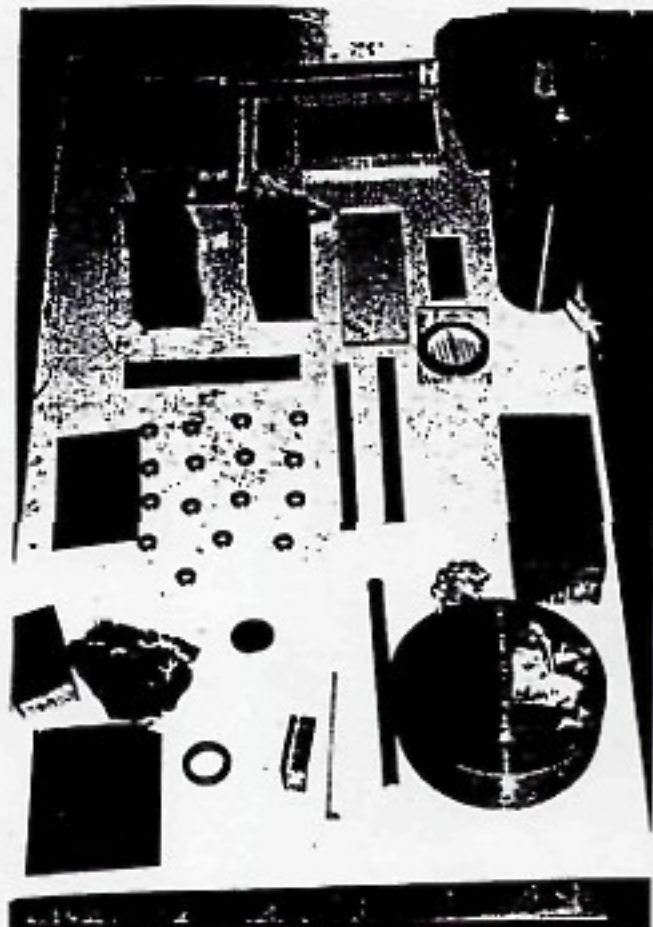
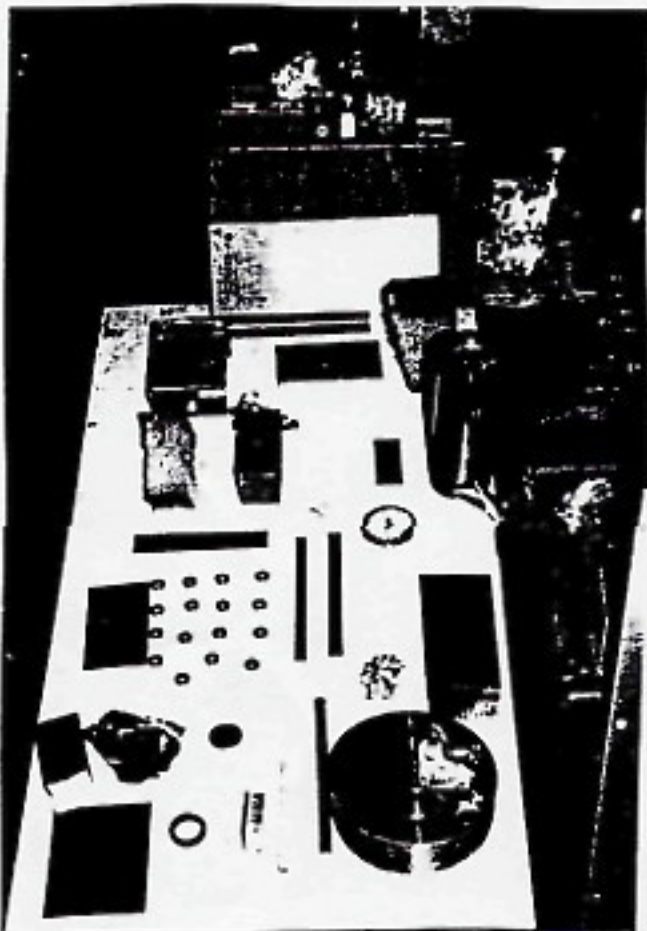

Figure 3. The set-up and noted changes for August 14, 1995 experiments

I took all of our samples back to the hotel with me so that I had control of them at all times. The geometry for the experiment on August 14, 1985 is shown in Figure 3. The record of events is presented in Table 2. With only one video camera, it was not possible to prove that we obtained simultaneous events. However, pieces of aluminum foil did move (fall to the floor) on both walkways during the evening. I set up the whole target area on the second day. I checked under the table for other equipment -- none. I moved the front table back about two or three feet from where it was on the first day. Hoping to get the major effects on the samples I took.

MACDONALD DOUGLAS



Photos 9 and 10: indications of movement of magnets and aluminum objects.

Photo 9 was taken at the break. A new video tape was also put in the recorder at this time. Photo 10 was taken of the same area (front table in the target area) at the end of the experiment. Examination of the sequence of Photos 8,9,10 shows the movement of the magnets and the aluminum objects. Photo 11 verifies that nothing on the back table in the target area moved. Fortunately, some movement did occur in the area of our samples on the second day. However, nothing lifted off or hovered as I had hoped. The video record does show impulsive type movements, and there does seem to be a

2) The Electromagnetics hypothesis

Letter from Hathaway Consulting Services, Toronto

November, 1985

The best explanation for the lift so far came from Leon Dragone and Prof. Panos Pappas who postulate a charge coherence between a localized area on the earth (or "launch platform" and the specimen to be launched). This sudden coherence could affect the gravitational pull on the object and give it a thrust if properly directed. It could be stimulated by sudden discharges in spark gaps as you have. But unless these gaps are precisely turned and coordinated in phase, the lift phenomenon resulting would appear only sporadically, i.e., when a chance coherent state was achieved during spark cycle.

Letter from Prof. Dr. Panos T. Pappas, Athens

October, 1985

As I have experimentally observed gravitational like (attracting) forces between identically excited by microwave bodies, your experiments gave me the idea that you probably disturb the microwave resonance between the orbiting electrons in the mass of earth and orbiting electrons in the mass in various objects. As a result you extinguish the coupling which we know as gravity between object and earth (or even cause repulsion). I will not go into details.

Letter from Prof. Dr. Panos T. Pappas, Athens

January, 1990

I believe the effects were produced by a few elements, i.e., by the Tesla coils and sparks in tune and perhaps, by the static [Van der Graff] generator. The underlying principle should be simpler, however, having so many equipments the essence is lost. The essence, I believe, was around the sparks and devices that they produced them.

Richard Sparks

Scientific and Technical Intelligence / SBIR, Ottawa



The Experiment

A complex high voltage, high frequency apparatus was assembled which when properly adjusted caused various material objects to accelerate in a vertical direction, against the gravitational field. Under some set of as yet undefined conditions, and particularly when " lift " does not take place, a target specimen will be fractured or disrupted in a catastrophic manner. A less frequent phenomenon is the apparent heating to incandescence of iron and steel specimens having high length to width ratios. This event is not accompanied by the heating, charring or the burning of combustible materials in contact with the specimen throughout the duration of the event of about two minutes. The fracturing of certain iron and steel geometries accompanied by an anomalous residual magnetic field, permanent in nature, is not uncommon. Permanent and dramatic alterations in the physical and chemical structure of certain metallic alloys have been documented via mass spectrographic data. These effects do not appear to be specific to any particular type or class of material.

The reaction area comprises a roughly circular cylinder about one and one half feet in diameter and of unknown height. Total energy radiated into this cylinder is on the order of a few watts, although approximately 500 watts are dissipated by the apparatus.

I have made the following observations and specified certain relationships pertaining to the action of the combined static and dynamic electric fields on an aluminum specimen of rectangular geometry and measurements of approximately $\frac{1}{4}$ " x $\frac{1}{2}$ " x 2".

The aluminum specimen was disrupted as shown in the appended photograph. The nature of the disruption is such that the material that comprises about one third the total mass of the specimen is shredded in a regular manner along the length of the object, resulting in a conversion, throughout the entire volume of the central portion of the specimen, from solid extrusion to an expanded bundle of more or less uniform " ribbons " or filaments of aluminum. The filaments vary in width from about 0.010" to 0.050" and in thickness from 0.008" to about 0.012".

The entire event volume has expanded outward from the mass center in seeming reaction to a force of mutual repulsion between filaments. The expanded filament bundle has assumed the shape and configuration of a magnetic field having it's axis oriented along the specimen. Such a field pattern would be produced as the as the result of a circular flow of electrons around the axis of a ferromagnetic specimen of identical geometry. The "field" lines frozen in the aluminum filaments are functionally identical to those observed at the point of fracture of a permanent iron bar magnet of the same geometry. The force exerted on the aluminum filaments was sufficient to split a large number of the outermost strands and fold them back along the "field lines " to such a

3

degree that layers of them are compacted together against the solid surfaces of the specimen adjacent to the event area.

The material within the event volume is much harder than the original extrusion alloy, which was quite soft, and is quite brittle. All surfaces evidence a mottled appearance, regular structure and none of the characteristics associated with plastic deformation or melting. Physical characteristics are typical of crystalline materials sheared along bonding planes. The number of filaments probably exceed 100,000; effectively increasing the surface area within the event by about 11,700 times. The initial cross section area to surface area of the event volume has increased about 78,000 times.

1. I would conservatively estimate that the energy required to accomplish the physical separation and expansion to be in the vicinity of at least 3000 Watt-sec. Under certain circumstances the requirement could be greater by two orders of magnitude.
2. Given the approximate 500 Watt input to the apparatus and the omnidirectional method of energy projection, the energy incident upon the target specimen are several orders of magnitude smaller than would be required to disrupt it.
3. If we wish to theorize that the 500 Watt RF energy field is in some fundamental way causative, it must be noted that both E and H wave components traveling in a conducting medium are attenuated by the factor (e^{-az}) as they advance along z. The attenuation is extremely rapid and varies according to the expression:

$$\mathcal{E} = 1/a = 1/\sqrt{\pi \cdot f \cdot u \cdot O} \quad (M)$$

Generally speaking, $Z = 5.0$ defines the point at which the function \mathcal{E} can be assumed to be zero. This function applied to the target specimen indicates a skin depth of about 64 micrometers.

4. Any theory requiring fundamental causation from the RF field is simply untenable.
5. By definition the *Van De Graff* field is static and cannot be considered as a source of fundamental causation of the phenomenon.
6. It is evident from observation and experimentation that neither shearing nor stress in tension or compression could have been causative in the observed disruptions.
7. The state of the specimen is consistent with the idea that an impressed force acted from within the specimen, perhaps from an origin at the center of mass.
8. Said force was impressed at, or rose to, the peak value required to disrupt the specimen and declined rapidly with rupture and subsequent expansion.

9. We may be able to infer a fundamental relationship between the observed phenomena and the mass of the target specimen.
10. We can infer a fundamental relationship between the observed phenomena and the *GEOMETRY* of the specimen. This is supported by the observation that target specimens of identical composition, but having different geometries are either not affected or are affected in different ways. Additionally, the effects due to a certain geometry are repeatable with identical geometries given the same type of material.
11. If we entertain a small transition in thought and accept the idea that according to mathematical constructs space itself has a real and definable structure, we can submit the possibility that the observed phenomena in some way a function of the geometry of space occupied by the specimen, and that the geometry of the specimen and the geometry of the occupied space are coupled at the level of the fine structure.
12. If we can define the nature of matter in terms of its energy equivalence and then relate the resulting system to the fine structure of the occupied space, we may be able to define the precise nature of the coupling and thereby define the mechanism of the dynamic system resulting in the observed phenomena as integrated functions of the couple and the electromagnetic operators.
13. For numerous reasons, both nuclear forces may be discounted as being fundamentally causative. The remaining force; that of gravitation, varies by Vallée's definition according to the expression;

$$Gp = c^2 \times k \times m / r = V^2$$

and is several order of magnitude smaller than required to account for our observations.

14. Vallée does predict a depletion of energy in the structure of space in the vicinity of an Earth-sized concentration of mass of 57000 megaJoules less per cubic meter than that of a cubic meter of interstellar space. If this is so, and the potential does exist, the energy available to produce the observed effects would be of the proper magnitude, assuming less than 100% conversion efficiency of our apparatus, and given the dimensions of our target specimen. This being the case, we can assume that the more massive the target specimen, the greater the potential energy flow.
15. Serious considerations should be given to the idea that exceeding a certain critical mass of any relatively pure material may result in a reaction that is not self-quenching.

George D. Hathaway

Historical context and relation to current Physics.

Although an attempt will be made to treat the "lift" and "disruption" aspects of the device separately, many areas of overlap will be inevitable. In general, the disruption phenomena will be analyzed in terms of invoking channeling or triggering large amounts of electromagnetic (EM) energy right in the core of materials, the lift phenomena in terms of examining both experimental evidence and *Neo-Maxwell* theories which have not been examined in sufficient detail until recently.

Until detailed measurements are made, even these tentative analyses will remain highly speculative. The intent here is to provide an initial, brief compendium of scientific and experimental investigation that appears to have the most bearing on the phenomena.

For the past dozen or so years, the latter work of American inventor **Nikola Tesla** has been under investigation by J. Hutchison, an inventor working for *Pharos Technologies*. *Pharos'* present invention consists of a particular combination of DC field-producing elements (e.g. *Van der Graaf generators*) and AC elements (e.g. *Tesla coils*). Although the actual discovery of the effects discussed herein was fortuitous it had a solid background of experimentation behind it.

As far as the lift effect is concerned, there are many other candidate systems, both conventional and non-conventional, that appear to bear some similarity, however remote. Aluminum disk are regularly suspended by *eddy currents* above toroidal AC electromagnets in first-year physics classes. Magnetic levitation trains are an engineering reality. Even with high-energy electrostatic repulsion significant lift capability is possible. They all differ from the *Pharos* device in that they:

- i) have generally much lower lift per Watt figures
- ii) act on specific materials (conductors in the first two cases, dielectrics in the third case).
- iii) generally act vertically only using cantilevered elements directly above and/or below test objects.
- iv) cannot produce the entire range of observed phenomena.

Pharos Technologies Ltd. has investigated claims made for many non-conventional lift technologies and has assessed their technical and commercial feasibility. Appendix A outlines several of these.

Canadian military perspective

Letter from Lorne A. Kuehn
Scientific and Technical Intelligence, Ottawa

June 9, 1986

The report [Richard Sparks] is a fair summary of our scientific appraisal of the phenomenon that you are investigating. We do not foresee any further consideration of support to your endeavor until such time as you can assure a reproducible effect in a particular sample in a reasonable period of time (say three or four hours). The phenomenon as demonstrated to us appear to be intermittent and unpredictable.

Letter from Lorne A. Kuehn
(to George Hathaway, Toronto)

Enclosed is a copy of my trip report, relevant to my visit to Mr. Hutchison's laboratory earlier this year. I have also enclosed a copy of the metallurgical report on the sample which you provided us, which I assume has been now returned to you.

The report is a fair summary of our scientific appraisal of the phenomena that you are investigating. We do not foresee any further consideration of support to your endeavor until such time as you can assure a reproducible effect in a particular sample in a reasonable period of time (say three or four hours). The Phenomena as demonstrated to us appear to be intermittent and unpredictable. Reproducibility of an effect would do much to strengthen your case.

I have enclosed some photos that we took for your retention and for passing to John Hutchison. Enjoyed meeting you and John and wish you well in your endeavours.

Crystal energy convertor

John Hutchison's crystal energy converter produced over 3 Watts of energy without any evident exterior input source or batteries. It put out from 0.5 to 1.7 volts at 880 to 3000 microAmps, and could be connected in series and in parallel to change the voltage and current. He is currently working on a new generation of such devices.

John Hutchison felt that it worked on the principle of altered space product of charge function barrier. If so, it would be a significant advancement, demonstrating a simple method of tapping *Zero Point Energy* and illustrating the *Casimir Effect*.

Zero Point Energy, is the energy in ordinary empty space. In quantum theory, so-called empty space is a seething sea of activity, with fields coming and going, and particles being created and annihilated on a microscopic level. *Zero-point-energy* is the remaining activity or motion left in space, even at a temperature of absolute zero -- once you "freeze out" most motions. (At minus 273 degrees Centigrade, or zero degrees Kelvin, all molecular motion stops -- and conventionally, there is no longer any energy left, except for zero-point-energy.)

This is a "mainstream concept" subscribed by Nobel Prize physicists. Indeed, it is believed by such prominent physicist as **Richard P. Feynman** and **John Archibald Wheeler** that even in less than one cubic centimeter of vacuum at the *zero-point*, there is more energy than can be produced by any power plant yet built by man, enough to evaporate all of the world's oceans ! In Victorian times, this energy field that permeates all the universe, was known by **Maxwell** as the Ether, and by **Albert Einstien** in his *General Relativity Theory* as metric plenum, and in his *Special Relativity Theory* as a true vacuum. **Heisenberg** referred to it as a plenum of vacuum field fluctuation. More popularly, it is seen as a source of "free energy".

This converter is believed to illustrate the *Casimir Effect*. **Hendrik Casimir** proved that the vacuum fluctuations really exist. Vacuum pushes plates together so much that they generate heat, and allow electrons only flow in one direction at their interface. of two dissimilar materials. If conditions are right such that it is easier for the electrons to go in one direction than the other across the interface and if and when there is an external circuit connection, this effect could be expected to drive current around continuously. The peculiar effect is by no means fully understood and can only be observed under certain conditions, which are difficult to define and to maintain.