

MFA **M. Flom Associates, Inc. - Global Compliance Center**
3356 North San Marcos Place, Suite 107, Chandler, Arizona 85225-7176
www.mflom.com general@mflom.com (480) 926-3100, FAX: 926-3598

Date of Report: August 2, 2001
Date of Submission: August 21, 2001

Federal Communications Commission
Via: Electronic Filing

Attention: Authorization & Evaluation Division

Applicant: Telex Communications, Inc.
Equipment: Telex WT-1000
Electro Voice CSB-1000

FCC ID: B5DB113
FCC Rules: 74H

Gentlemen:

On behalf of the Applicant, enclosed please find Application Form 731, Engineering Test Report and all pertinent documentation, the whole for approval of the referenced equipment as shown.

Filing fees are attached.

We trust the same is in order. Should you need any further information, kindly contact the writer who is authorized to act as agent.

Sincerely yours,

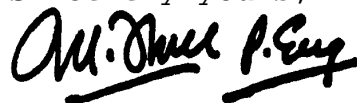

Morton Flom, P. Eng.

enclosure(s)
cc: Applicant
MF/cvr

LIST OF EXHIBITS
(FCC **CERTIFICATION** (TRANSMITTERS) - REVISED 9/28/98)

APPLICANT: Telex Communications, Inc.

FCC ID: B5DB113

BY APPLICANT:

1. LETTER OF AUTHORIZATION
2. IDENTIFICATION DRAWINGS, 2.1033(c)(11)
 - LABEL
 - LOCATION OF LABEL
 - COMPLIANCE STATEMENT
 - LOCATION OF COMPLIANCE STATEMENT
3. PHOTOGRAPHS, 2.1033(c)(12)
4. DOCUMENTATION: 2.1033(c)
 - (3) USER MANUAL
 - (9) TUNE UP INFO
 - (10) SCHEMATIC DIAGRAM
 - (10) CIRCUIT DESCRIPTION
 - BLOCK DIAGRAM
 - PARTS LIST
 - ACTIVE DEVICES
5. PART 90.203(e) & (g) ATTESTATION

BY M.F.A. INC.

- A. TESTIMONIAL & STATEMENT OF CERTIFICATION
- B. STATEMENT OF QUALIFICATIONS

MFA **M. Flom Associates, Inc. - Global Compliance Center**
3356 North San Marcos Place, Suite 107, Chandler, Arizona 85225-7176
www.mflom.com general@mflom.com (480) 926-3100, FAX: 926-3598

TRANSMITTER CERTIFICATION

of

FCC ID: B5DB113

MODELS: Telex WT-1000 and Electro Voice CSB-1000

to

FEDERAL COMMUNICATIONS COMMISSION

Rule Part(s) 74H

DATE OF REPORT: August 2, 2001

ON THE BEHALF OF THE APPLICANT:

Telex Communications, Inc.

AT THE REQUEST OF:

P.O. 238029

Telex Communications, Inc.
8601 E. Cornhusker Highway
P.O. Box 5579
Lincoln, NE 68505-5579

Attention of:

Charles E. Conner, Project Engineer
(402) 467-5321; FAX: -3279
E-mail: charlie.conner@telex.com



SUPERVISED BY:

Morton Flom, P. Eng.

THE APPLICANT HAS BEEN CAUTIONED AS TO THE FOLLOWING:

15.21 INFORMATION TO USER.

The users manual or instruction manual for an intentional radiator shall caution the user that changes or modifications not expressly approved by the party responsible for compliance could void the user's authority to operate the equipment.

15.27(a) SPECIAL ACCESSORIES.

Equipment marketed to a consumer must be capable of complying with the necessary regulations in the configuration in which the equipment is marketed. Where special accessories, such as shielded cables and/or special connectors are required to enable an unintentional or intentional radiator to comply with the emission limits in this part, the equipment must be marketed with, i.e. shipped and sold with, those special accessories. However, in lieu of shipping or packaging the special accessories with the unintentional or intentional radiator, the responsible party may employ other methods of ensuring that the special accessories are provided to the consumer, without additional charge.

Information detailing any alternative method used to supply the special accessories for a grant of equipment authorization or retained in the verification records, as appropriate. The party responsible for the equipment, as detailed in § 2.909 of this chapter, shall ensure that these special accessories are provided with the equipment. The instruction manual for such devices shall include appropriate instructions on the first page of text concerned with the installation of the device that these special accessories must be used with the device. It is the responsibility of the user to use the needed special accessories supplied with the equipment.

TABLE OF CONTENTS

<u>RULE</u>	<u>DESCRIPTION</u>	<u>PAGE</u>
	Test Report	1
2.1033(c)	General Information Required	2
2.1033(c)(14)	Rule Summary	5
	Standard Test Conditions and Engineering Practices	6
2.1046(a)	R. F. Power Output (Radiated)	7
2.1046(a)	Carrier Output Power (Conducted)	9
2.1051	Unwanted Emissions (Transmitter Conducted)	11
2.1053(a)	Field Strength of Spurious Radiation	14
2.1049(c)(1)	Emission Masks (Occupied Bandwidth)	18
2.1047(a)	Audio Frequency Response	26
2.1047(b)	Modulation Limiting	28
2.1055(a)(1)	Frequency Stability (Temperature Variation)	30
2.1055(b)(1)	Frequency Stability (Voltage Variation)	33
2.202(g)	Necessary Bandwidth and Emission Bandwidth	34

PAGE NO. 1 of 34.

Required information per ISO/IEC Guide 25-1990, paragraph 13.2:

- a) TEST REPORT
- b) Laboratory: M. Flom Associates, Inc.
 (FCC: 31040/SIT) 3356 N. San Marcos Place, Suite 107
 (Canada: IC 2044) Chandler, AZ 85225
- c) Report Number: d0180002
- d) Client: Telex Communications, Inc.
 8601 E. Cornhusker Highway
 P.O. Box 5579
 Lincoln, NE 68505-5579
- e) Identification: FCC ID: B5DB113
 Models: Telex WT-1000
 Electro Voice CSB-1000
- EUT Description: UHF FM Beltpack Transceiver
- f) EUT Condition: Not required unless specified in individual tests.
- g) Report Date: August 2, 2001
 EUT Received: June 8, 2001
- h, j, k): As indicated in individual tests.
- i) Sampling method: No sampling procedure used.
- l) Uncertainty: In accordance with MFA internal quality manual.
- m) Supervised by: 
 Morton Flom, P. Eng.
- n) Results: The results presented in this report relate only to the item tested.
- o) Reproduction: This report must not be reproduced, except in full, without written permission from this laboratory.

PAGE NO. 2 of 34.

LIST OF GENERAL INFORMATION REQUIRED FOR CERTIFICATION

IN ACCORDANCE WITH FCC RULES AND REGULATIONS,
VOLUME II, PART 2 AND TO

74H

Sub-part 2.1033

(c)(1): NAME AND ADDRESS OF APPLICANT:

Telex Communications, Inc.
8601 E. Cornhusker Highway
P.O. Box 5579
Lincoln, NE 68505-5579

MANUFACTURER:

Applicant

(c)(2): FCC ID: B5DB113

MODEL NOS: Telex WT-1000
Electro Voice CSB-1000

(c)(3): INSTRUCTION MANUAL(S):

PLEASE SEE ATTACHED EXHIBITS

(c)(4): TYPE OF EMISSION: 92K0F3E

(c)(5): FREQUENCY RANGE, MHz: 520 to 608
614 to 746

(c)(6): POWER RATING: 10 mw to 50 mw
x Switchable ___ Variable ___ N/A

FCC GRANT NOTE: BE - The output power is continuously variable from the value listed in this entry to 15%-20% of the value listed.

(c)(7): MAXIMUM POWER RATING, Watts: .250

DUT RESULTS: Passes x Fails _____

M. Flom Associates, Inc. is accredited by the American Association for Laboratory Accreditation (A2LA) as shown in the scope below.



THE AMERICAN ASSOCIATION FOR LABORATORY ACCREDITATION

ACCREDITED LABORATORY

A2LA has accredited

M. FLOM ASSOCIATES, INC.
Chandler, AZ

for technical competence in the field of

Electrical (EMC) Testing

The accreditation covers the specific tests and types of tests listed on the agreed scope of accreditation. This laboratory meets the requirements of ISO/IEC 17025 - 1999 "General Requirements for the Competence of Testing and Calibration Laboratories" and any additional program requirements in the identified field of testing. Testing and calibration laboratories that comply with this International Standard also operate in accordance with ISO 9001 or ISO 9002.

Presented this 2nd day of March, 2001.



President
For the Accreditation Council
Certificate Number 1008.01
Valid to December 31, 2002

For tests or types of tests to which this accreditation applies, please refer to the laboratory's Electrical (EMC) Scope of Accreditation



American Association for Laboratory Accreditation

SCOPE OF ACCREDITATION TO ISO/IEC 17025:1999

M. FLOM ASSOCIATES, INC.
Electronic Testing Laboratory
3356 North San Marcos Place, Suite 107
Chandler, AZ 85225
Morton Flom Phone: 480 926 3100

ELECTRICAL (EMC)

Valid to: December 31, 2002 Certificate Number: 1008-01

In recognition of the successful completion of the A2LA evaluation process, accreditation is granted to this laboratory to perform the following electromagnetic compatibility tests:

Tests	Standard(s)
RF Emissions	FCC Part 15 (Subparts B and C) using ANSI C63.4-1992; CISPR 11; CISPR 13; CISPR 14; CISPR 22; EN 55011; EN 55013; EN 55014; EN 55022; EN 50081-1; EN 50081-2; ICES-003; AS/NZS 1044; AS/NZS 1053; AS/NZS 3548; AS/NZS 4251.1; CNS 13438
Harmonic Currents	EN 61000-3-2
Fluctuation and Flicker	EN 61000-3-3
RF Immunity	EN: 50082-1, 50082-2 (both excluding "Power Frequency Magnetic Field Immunity" and "Voltage Dips, Short Interruptions, and Line Voltage Variations"); AS/NZS 4251.1
Radiated Susceptibility	EN 61000-4-3; ENV 50140; ENV 50204; IEC 1000-4-3; IEC 801-3
EFT	EN 61000-4-4; IEC 1000-4-4; IEC 801-4
Surge	EN 61000-4-5; ENV 50142; IEC 1000-4-5; IEC 801-5
47 CFR (FCC)	2, 21, 22, 23, 24, 74, 80, 87, 90, 95, 97



5301 Buckeystown Pike, Suite 350 • Frederick, MD 21704-8373 • Phone: 301-644 3248 • Fax: 301-662 2974

"This laboratory is accredited by the American Association for Laboratory Accreditation (A2LA) and the results shown in this report have been determined in accordance with the laboratory's terms of accreditation unless stated otherwise in the report."

Should this report contain any data for tests for which we are not accredited, or which have been undertaken by a subcontractor that is not A2LA accredited, such data would not covered by this laboratory's A2LA accreditation.

PAGE NO. 4 of 34.

Subpart 2.1033 (continued)

(c)(8): VOLTAGES & CURRENTS IN ALL ELEMENTS IN FINAL R. F. STAGE, INCLUDING FINAL TRANSISTOR OR SOLID STATE DEVICE:

COLLECTOR CURRENT, A = per manual
 COLLECTOR VOLTAGE, Vdc = per manual
 SUPPLY VOLTAGE, Vdc = 9

(c)(9): TUNE-UP PROCEDURE:

PLEASE SEE ATTACHED EXHIBITS

(c)(10): CIRCUIT DIAGRAM/CIRCUIT DESCRIPTION:

Including description of circuitry & devices provided for determining and stabilizing frequency, for suppression of spurious radiation, for limiting modulation and limiting power.

PLEASE SEE ATTACHED EXHIBITS

(c)(11): LABEL INFORMATION:

PLEASE SEE ATTACHED EXHIBITS

(c)(12): PHOTOGRAPHS:

PLEASE SEE ATTACHED EXHIBITS

(c)(13): DIGITAL MODULATION DESCRIPTION:

 ATTACHED EXHIBITS
 x N/A

(c)(14): TEST AND MEASUREMENT DATA:

FOLLOWS

PAGE NO.

5 of 34.

Sub-part
2.1033(c)(14):TEST AND MEASUREMENT DATA

All tests and measurement data shown were performed in accordance with FCC Rules and Regulations, Volume II; Part 2, Sub-part J, Sections 2.947, 2.1033(c), 2.1041, 2.1046, 2.1047, 2.1079, 2.1051, 2.1053, 2.1055, 2.1057 and the following individual Parts:

- _____ 21 - Domestic Public Fixed Radio Services
- _____ 22 - Public Mobile Services
- _____ 22 Subpart H - Cellular Radiotelephone Service
- _____ 22.901(d) - Alternative technologies and auxiliary services
- _____ 23 - International Fixed Public Radiocommunication services
- _____ 24 - Personal Communications Services
- x 74 Subpart H - Low Power Auxiliary Stations
- _____ 80 - Stations in the Maritime Services
- _____ 80 Subpart E - General Technical Standards
- _____ 80 Subpart F - Equipment Authorization for Compulsory Ships
- _____ 80 Subpart K - Private Coast Stations and Marine Utility Stations
- _____ 80 Subpart S - Compulsory Radiotelephone Installations for Small Passenger Boats
- _____ 80 Subpart T - Radiotelephone Installation Required for Vessels on the Great Lakes
- _____ 80 Subpart U - Radiotelephone Installations Required by the Bridge-to-Bridge Act
- _____ 80 Subpart V - Emergency Position Indicating Radiobeacons (EPIRB'S)
- _____ 80 Subpart W - Global Maritime Distress and Safety System (GMDSS)
- _____ 80 Subpart X - Voluntary Radio Installations
- _____ 87 - Aviation Services
- _____ 90 - Private Land Mobile Radio Services
- _____ 94 - Private Operational-Fixed Microwave Service
- _____ 95 Subpart A - General Mobile Radio Service (GMRS)
- _____ 95 Subpart C - Radio Control (R/C) Radio Service
- _____ 95 Subpart D - Citizens Band (CB) Radio Service
- _____ 95 Subpart E - Family Radio Service
- _____ 95 Subpart F - Interactive Video and Data Service (IVDS)
- _____ 97 - Amateur Radio Service
- _____ 101 - Fixed Microwave Services

PAGE NO.

6 of 34.

STANDARD TEST CONDITIONS
and
ENGINEERING PRACTICES

Except as noted herein, the following conditions and procedures were observed during the testing:

In accordance with ANSI C63.4-1992/2000 Draft, section 6.1.9, and unless otherwise indicated in the specific measurement results, the ambient temperature of the actual EUT was maintained within the range of 10° to 40°C (50° to 104 °F) unless the particular equipment requirements specify testing over a different temperature range. Also, unless otherwise indicated, the humidity levels were in the range of 10% to 90% relative humidity.

Prior to testing, the EUT was tuned up in accordance with the manufacturer's alignment procedures. All external gain controls were maintained at the position of maximum and/or optimum gain throughout the testing.

Measurement results, unless otherwise noted, are worst case measurements.

PAGE NO. 7 of 34.
NAME OF TEST: R. F. Power Output (Radiated)
SPECIFICATION: 47 CFR 2.1046(a)
TEST EQUIPMENT: As per attached page

MEASUREMENT PROCEDURE (RADIATED)

1. The EUT was placed on an open-field site and its radiated field strength at a known distance was measured by means of a spectrum analyzer. Equivalent loading was calculated from the equation $P_t = ((E \times R)^2 / 49.2)$ watts, where $R = 3m$.
2. Measurement accuracy is ± 1.5 dB.

MEASUREMENT RESULTS

g0170374: 2001-Jul-31 Tue 08:27:00

STATE: 2:High Power

AMPS MODE:

<u>FREQUENCY TUNED, MHz</u>	<u>FREQUENCY EMISSION, MHz</u>	<u>METER, dBuV/m</u>	<u>CF, dB</u>	<u>ERP, dBm</u>	<u>ERP, Milliwatts</u>
722.200000	722.197500	84.79	28.5	15.9	≤ 47.01
727.000000	726.997500	85.5	28.57	16.7	≤ 47.01
738.400000	738.396300	83.83	28.71	15.2	≤ 47.01

TRANSMITTER RADIATED MEASUREMENTS

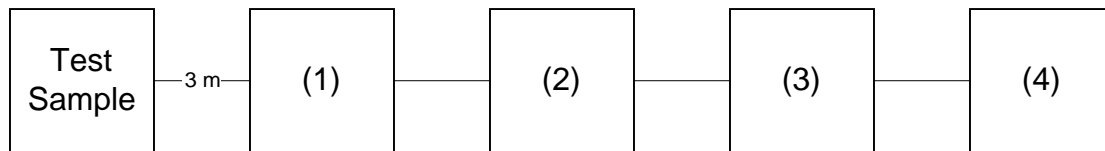

Transmitter Radiated Measurements

Asset Description (as applicable)	s/n
(1) <u>TRANSDUCER</u>	
i00091 Emco 3115	001469
i00089 Aprel Log Periodic	001500
(2) <u>HIGH PASS FILTER</u>	
i00 Narda μ PAD (In-Band Only)	
i00 Trilithic (Out-Of-Band Only)	
(3) <u>PREAMP</u>	
i00028 HP 8449 (+30 dB)	2749A00121
(4) <u>SPECTRUM ANALYZER</u>	
i00048 HP 8566B	2511A01467
i00057 HP 8557A	1531A00191
i00029 HP 8563E	3213A00104

PAGE NO. 9 of 34.
NAME OF TEST: Carrier Output Power (Conducted)
SPECIFICATION: 47 CFR 2.1046(a)
GUIDE: ANSI/TIA/EIA-603-1992, Paragraph 2.2.1
TEST EQUIPMENT: As per attached page

MEASUREMENT PROCEDURE

1. The EUT was connected to a resistive coaxial attenuator of normal load impedance, and the unmodulated output power was measured by means of an R. F. Power Meter.
2. Measurement accuracy is $\pm 3\%$.

MEASUREMENT RESULTS
(Worst case)

FREQUENCY OF CARRIER, MHz = 727.00, 722.2, 738.4

<u>POWER SETTING</u>	<u>R. F. POWER, MILLIWATTS</u>
ERP	10
ERP	50

PERFORMED BY:

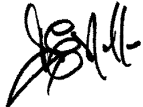
Doug Noble, B.A.S. E.E.T.

TRANSMITTER POWER CONDUCTED MEASUREMENTS

TEST 1: R. F. POWER OUTPUT
 TEST 2: FREQUENCY STABILITY

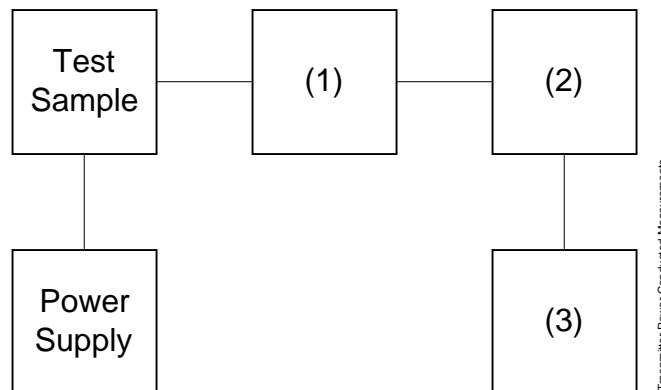

Asset	Description (as applicable)	s/n
(1)	<u>COAXIAL ATTENUATOR</u>	
i00122	Narda 766-10	7802
i00123	Narda 766-10	7802A
i00069	Bird 8329 (30 dB)	1006
i00113	Sierra 661A-3D	1059
(2)	<u>POWER METERS</u>	
i00014	HP 435A	1733A05836
i00039	HP 436A	2709A26776
i00020	HP 8901A POWER MODE	2105A01087
(3)	<u>FREQUENCY COUNTER</u>	
i00042	HP 5383A	1628A00959
i00019	HP 5334B	2704A00347
i00020	HP 8901A FREQUENCY MODE	2105A01087

PAGE NO. 11 of 34.
NAME OF TEST: Unwanted Emissions (Transmitter Conducted)
SPECIFICATION: 47 CFR 2.1051
GUIDE: ANSI/TIA/EIA-603-1992, Paragraph 2.2.13
TEST EQUIPMENT: As per attached page

MEASUREMENT PROCEDURE

1. The emissions were measured for the worst case as follows:
 - (a): within a band of frequencies defined by the carrier frequency plus and minus one channel.
 - (b): from the lowest frequency generated in the EUT and to at least the 10th harmonic of the carrier frequency, or 40 GHz, whichever is lower.
2. The magnitude of spurious emissions that are attenuated more than 20 dB below the permissible value need not be specified.
3. MEASUREMENT RESULTS: ATTACHED FOR WORST CASE

FREQUENCY OF CARRIER, MHz	=	727.00, 722.2, 738.4
SPECTRUM SEARCHED, GHz	=	0 to 10 x F _c
MAXIMUM RESPONSE, Hz	=	12600
ALL OTHER EMISSIONS	=	≥ 20 dB BELOW LIMIT

PERFORMED BY:

 Doug Noble, B.A.S. E.E.T.

TRANSMITTER SPURIOUS EMISSION

TEST A. OCCUPIED BANDWIDTH (IN-BAND SPURIOUS)
 TEST B. OUT-OF-BAND SPURIOUS

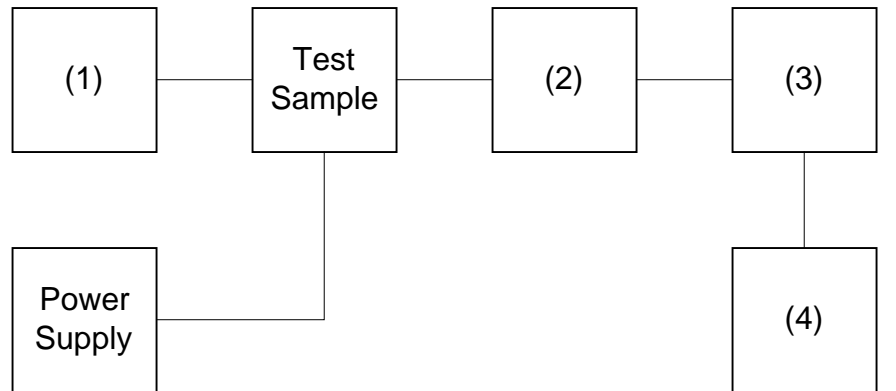

Asset Description (as applicable)	s/n
(1) <u>AUDIO OSCILLATOR/GENERATOR</u>	
i00010 HP 204D	1105A04683
i00017 HP 8903A	2216A01753
i00012 HP 3312A	1432A11250
(2) <u>COAXIAL ATTENUATOR</u>	
i00122 Narda 766-10	7802
i00123 Narda 766-10	7802A
i00069 Bird 8329 (30 dB)	1006
i00113 Sierra 661A-3D	1059
(3) <u>FILTERS; NOTCH, HP, LP, BP</u>	
i00126 Eagle TNF-1	100-250
i00125 Eagle TNF-1	50-60
i00124 Eagle TNF-1	250-850
(4) <u>SPECTRUM ANALYZER</u>	
i00048 HP 8566B	2511A01467
i00029 HP 8563E	3213A00104

PAGE NO. 13 of 34.

NAME OF TEST: Unwanted Emissions (Transmitter Conducted)

LIMIT(S), dBc: $-(43+10 \times \text{LOG } P) = -30$ (0 Watts)

STATE: 2:High Power g0170373: 2001-Jul-30 Mon 14:25:00

FREQUENCY TUNED, MHz	FREQUENCY EMISSION, MHz	LEVEL, dBm	LEVEL, dBc	MARGIN, dB
722.200000	1444.348000	-30.1	-47	-17.1
727.000000	1453.946000	-33	-49.9	-20
738.400000	1476.748000	-35.6	-52.5	-22.6
722.200000	2166.676000	-51.5	-68.4	-38.5
727.000000	2180.932000	-54.5	-71.4	-41.5
738.400000	2215.112000	-57.3	-74.2	-44.3
722.200000	2888.681000	-50.5	-67.4	-37.5
727.000000	2908.105000	-59	-75.9	-46
738.400000	2953.472000	-63.5	-80.4	-50.5
722.200000	3610.853000	-57.2	-74.1	-44.2
727.000000	3634.851000	-56.9	-73.8	-43.9
738.400000	3692.138000	-55.7	-72.6	-42.7
722.200000	4332.853000	-66.4	-83.3	-53.4
727.000000	4361.713000	-66.7	-83.6	-53.7
738.400000	4430.691000	-65.5	-82.4	-52.5
722.200000	5055.885000	-66	-82.9	-53
727.000000	5088.926000	-66.4	-83.3	-53.4
738.400000	5168.336000	-65.8	-82.7	-52.8
722.200000	5777.723000	-65.9	-82.8	-52.9
727.000000	5816.452000	-60	-76.9	-47
738.400000	5907.568000	-58.9	-75.8	-45.9
722.200000	6499.682000	-60	-76.9	-47
727.000000	6542.792000	-59.9	-76.8	-46.9
738.400000	6645.846000	-60.9	-77.8	-47.9
722.200000	7222.464000	-60.3	-77.2	-47.3
727.000000	7270.166000	-60.3	-77.2	-47.3
738.400000	7383.613000	-60.7	-77.6	-47.7
722.200000	7944.158000	-60.7	-77.6	-47.7
727.000000	7996.846000	-60.8	-77.7	-47.8
738.400000	8122.328000	-60.4	-77.3	-47.4
722.200000	8666.305000	-61	-77.9	-48
727.000000	8723.784000	-60.8	-77.7	-47.8
738.400000	8860.310000	-61.2	-78.1	-48.2
722.200000	9388.514000	-60.1	-77	-47.1
727.000000	9451.314000	-60.3	-77.2	-47.3
738.400000	9599.175000	-60.3	-77.2	-47.3
722.200000	10111.123000	-60.9	-77.8	-47.9
727.000000	10177.984000	-59.9	-76.8	-46.9
738.400000	10337.778000	-60.8	-77.7	-47.8
722.200000	10833.357000	-60.2	-77.1	-47.2
727.000000	10905.075000	-60	-76.9	-47
738.400000	11075.756000	-60.5	-77.4	-47.5

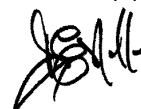

PERFORMED BY:

Doug Noble, B.A.S. E.E.T.

PAGE NO. 14 of 34.
NAME OF TEST: Field Strength of Spurious Radiation
SPECIFICATION: 47 CFR 2.1053(a)
GUIDE: ANSI/TIA/EIA-603-1992, Paragraph 1.2.12

MEASUREMENT PROCEDURE

1.2.12.1 Definition: Radiated spurious emissions are emissions from the equipment when transmitting into a non-radiating load on a frequency or frequencies which are outside an occupied band sufficient to ensure transmission of information of required quality for the class of communications desired.

1.2.12.2 Method of Measurement

- A) Connect the equipment as illustrated
- B) Adjust the spectrum analyzer for the following settings:
 - 1) Resolution Bandwidth ≤ 3 kHz.
 - 2) Video Bandwidth ≥ 10 kHz
 - 3) Sweep Speed ≤ 2000 Hz/second
 - 4) Detector Mode = Positive Peak
- C) Place the transmitter to be tested on the turntable in the standard test site. The transmitter is transmitting into a non-radiating load which is placed on the turntable. The RF cable to this load should be of minimum length.

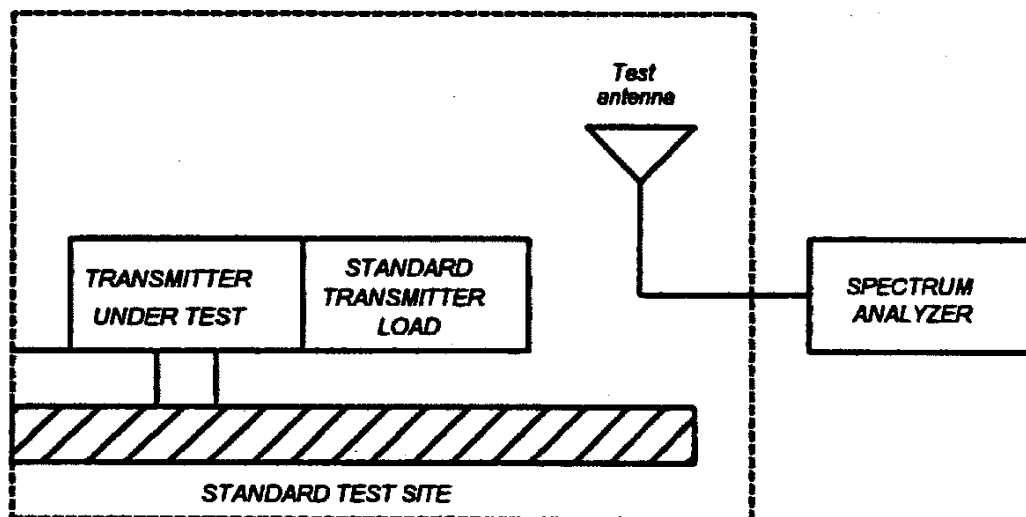

PAGE NO. 15 of 34.

NAME OF TEST: Field Strength of Spurious Radiation (Cont.)

- D) For each spurious measurement the test antenna should be adjusted to the correct length for the frequency involved. This length may be determined from a calibration ruler supplied with the equipment. Measurements shall be made from the lowest radio frequency generated in the equipment to the tenth harmonic of the carrier, except for the region close to the carrier equal to \pm the test bandwidth (see section 1.3.4.4).
- E) For each spurious frequency, raise and lower the test antenna from 1 m to 4 m to obtain a maximum reading on the spectrum analyzer with the test antenna at horizontal polarity. Repeat this procedure to obtain the highest possible reading. Record this maximum reading.
- F) Repeat step E) for each spurious frequency with the test antenna polarized vertically.

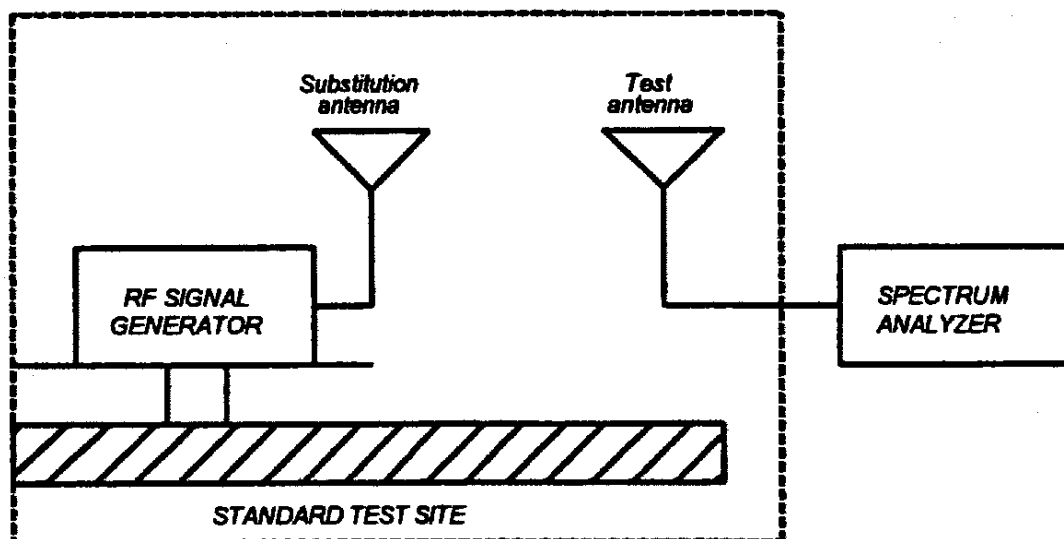

- G) Reconnect the equipment as illustrated.
- H) Keep the spectrum analyzer adjusted as in step B).
- I) Remove the transmitter and replace it with a substitution antenna (the antenna should be half-wavelength for each frequency involved). The center of the substitution antenna should be approximately at the same location as the center of the transmitter. At lower frequencies, where the substitution antenna is very long, this will be impossible to achieve when the antenna is polarized vertically. In such case the lower end of the antenna should be 0.3 m above the ground.

PAGE NO. 16 of 34.

NAME OF TEST: Field Strength of Spurious Radiation (Cont.)

- J) Feed the substitution antenna at the transmitter end with a signal generator connected to the antenna by means of a non-radiating cable. With the antennas at both ends horizontally polarized and with the signal generator tuned to a particular spurious frequency, raise and lower the test antenna to obtain a maximum reading at the spectrum analyzer. Adjust the level of the signal generator output until the previously recorded maximum reading for this set of conditions is obtained. This should be done carefully repeating the adjustment of the test antenna and generator output.
- K) Repeat step J) with both antennas vertically polarized for each spurious frequency.
- L) Calculate power in dBm into a reference ideal half-wave dipole antenna by reducing the readings obtained in steps J) and K) by the power loss in the cable between the generator and the antenna and further corrected for the gain of the substitution antenna used relative to an ideal half-wave dipole antenna.
- M) The levels recorded in step L) are absolute levels of radiated spurious emissions in dBm. The radiated spurious emissions in dB can be calculated by the following:

Radiated spurious emissions dB =
 $10 \log_{10}(\text{TX power in watts}/0.001) - \text{the levels in step l)}$

NOTE: It is permissible that other antennas provided can be referenced to a dipole.

Test Equipment:

Asset Description (as applicable)	s/n	Cycle	Last Cal
<u>TRANSDUCER</u>			
i00088 EMCO 3109-B 25MHz-300MHz	2336	12 mo.	Sep-00
i00065 EMCO 3301-B Active Monopole	2635	12 mo.	Sep-00
i00089 Aprel 2001 200MHz-1GHz	001500	12 mo.	Sep-00
i00103 EMCO 3115 1GHz-18GHz	9208-3925	12 mo.	Sep-00
<u>AMPLIFIER</u>			
i00028 HP 8449A	2749A00121	12 mo.	Mar-01
<u>SPECTRUM ANALYZER</u>			
i00029 HP 8563E	3213A00104	12 mo.	Aug-01
i00033 HP 85462A	3625A00357	12 mo.	May-01
i00048 HP 8566B	2511AD1467	6 mo.	Nov-00
<u>MICROPHONE, ANTENNA PORT, AND CABELING</u>			
Microphone	Yes/No	<u>Y</u>	Cable Length _____ Meters
Antenna Port Terminated	Yes/No	<u>Y</u>	
All Ports Terminated by	Load	<u>N/A</u>	

PAGE NO. 17 of 34.

NAME OF TEST: Field Strength of Spurious Radiation
 g0170375: 2001-Jul-31 Tue 09:10:00
 STATE: 2:High Power

FREQUENCY TUNED, MHz	FREQUENCY EMISSION, MHz	METER, dBuV	CF, dB	ERP, dBm	ERP, dbc
727.000000	1453.984166	53.33	-1.29	-45.3	≤-46.2
727.000000	2180.981667	60.33	1.66	-35.4	≤-46.2
727.000000	2907.981667	57.17	4.55	-35.7	≤-46.2
727.000000	3634.975000	61.83	6.36	-29.2	≤-46.2
727.000000	4361.975000	50.83	7.92	-38.6	≤-46.2
727.000000	5088.990834	41.17	9.39	-46.8	≤-46.2
727.000000	5815.976667	35.67	10.71	-51	≤-46.2
727.000000	6542.976667	33.33	11.95	-52.1	≤-46.2
727.000000	7269.976667	29.33	13.11	-54.9	≤-46.2

SUPERVISED BY:

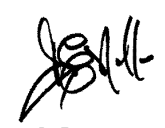
 Doug Noble, B.A.S. E.E.T.

PAGE NO. 18 of 34.
NAME OF TEST: Emission Masks (Occupied Bandwidth)
SPECIFICATION: 47 CFR 2.1049(c)(1)
GUIDE: ANSI/TIA/EIA-603-1992, Paragraph 2.2.11
TEST EQUIPMENT: As per previous page

MEASUREMENT PROCEDURE

1. The EUT and test equipment were set up as shown on the following page, with the Spectrum Analyzer connected.
2. For EUTs supporting audio modulation, the audio signal generator was adjusted to the frequency of maximum response and with output level set for $\pm 2.5/\pm 1.25$ kHz deviation (or 50% modulation). With level constant, the signal level was increased 16 dB.
3. For EUTs supporting digital modulation, the digital modulation mode was operated to its maximum extent.
4. The Occupied Bandwidth was measured with the Spectrum Analyzer controls set as shown on the test results.
5. MEASUREMENT RESULTS: ATTACHED

PAGE NO. 19 of 34.

NAME OF TEST: Emission Masks (Occupied Bandwidth)
g0170366: 2001-Jul-30 Mon 14:05:00
STATE: 2:High Power

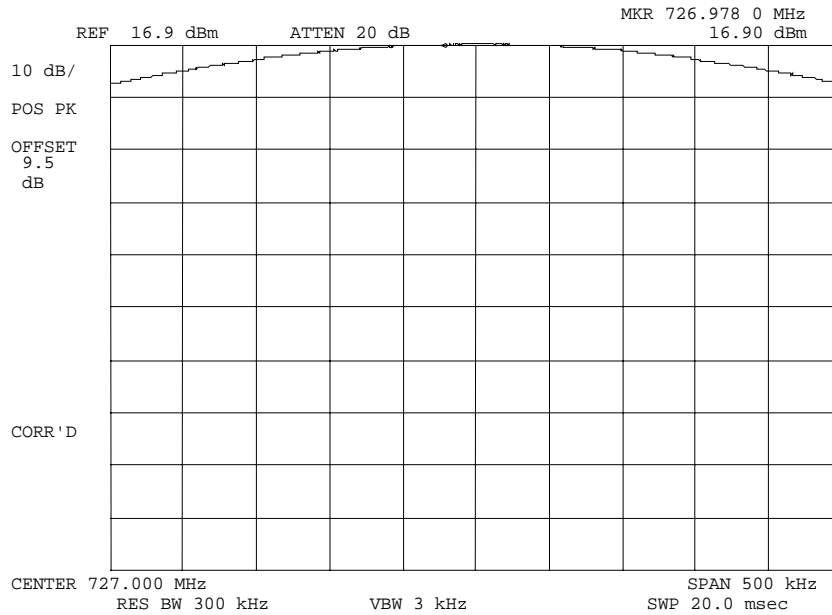

POWER: HIGH
MODULATION: NONE

PERFORMED BY:

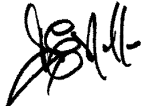
Doug Noble, B.A.S. E.E.T.

PAGE NO. 20 of 34.

NAME OF TEST: Emission Masks (Occupied Bandwidth)
g0170367: 2001-Jul-30 Mon 14:08:00
STATE: 2:High Power

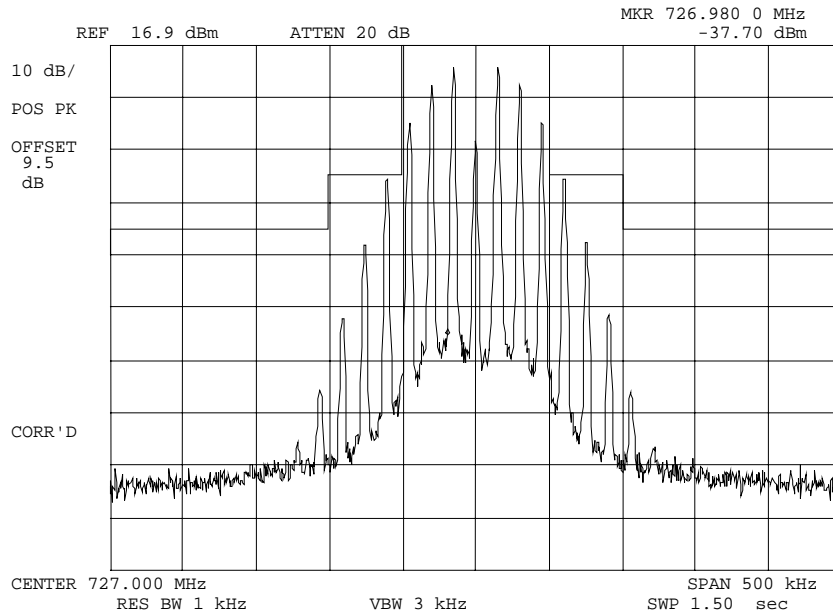

POWER: HIGH
MODULATION: 15000 HZ @ 20 DB ABOVE
REFERENCE LEVEL
MASK: Wireless Mic, 74.861

PERFORMED BY:

Doug Noble, B.A.S. E.E.T.

PAGE NO. 21 of 34.

NAME OF TEST: Emission Masks (Occupied Bandwidth)
g0170372: 2001-Jul-30 Mon 14:14:00
STATE: 2:High Power

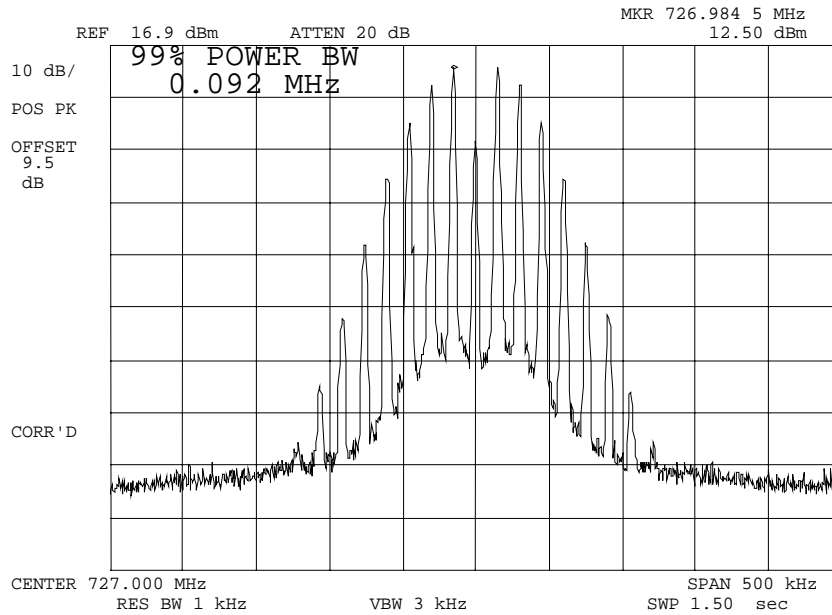

POWER:	HIGH
MODULATION:	15000 HZ @ 20 DB ABOVE REFERENCE LEVEL 99 % POWER BANDWIDTH

PERFORMED BY:

Doug Noble, B.A.S. E.E.T.

PAGE NO. 22 of 34.

NAME OF TEST: Emission Masks (Occupied Bandwidth)
g0170369: 2001-Jul-30 Mon 14:10:00
STATE: 2:High Power

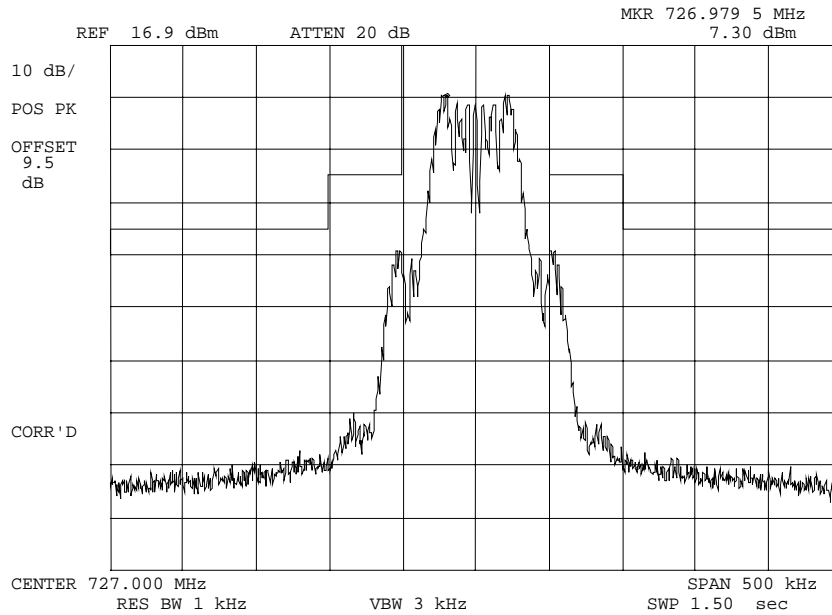

POWER: HIGH
 MODULATION: 2500 HZ @ 20 DB ABOVE REFERENCE LEVEL
 MASK: Wireless Mic, 74.861

PERFORMED BY:

Doug Noble, B.A.S. E.E.T.

PAGE NO. 23 of 34.

NAME OF TEST: Emission Masks (Occupied Bandwidth)
g0170370: 2001-Jul-30 Mon 14:12:00
STATE: 2:High Power

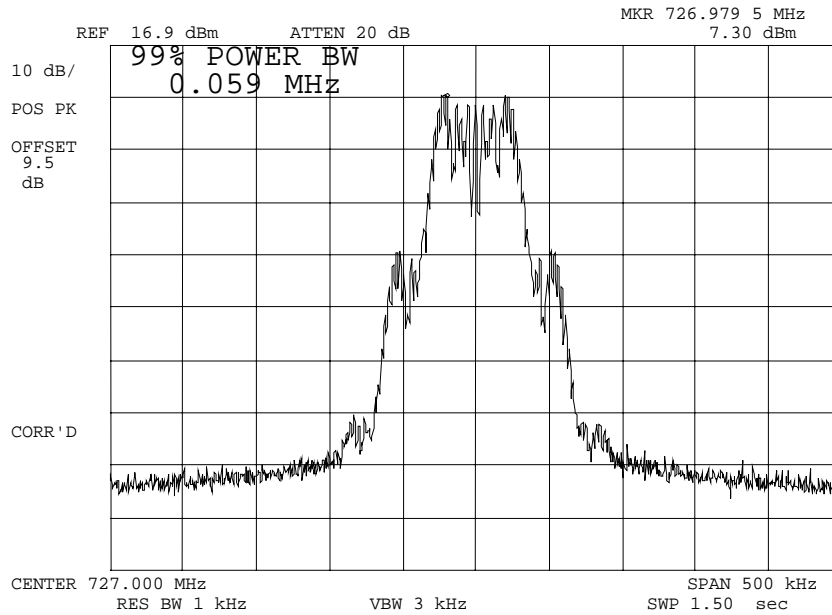

POWER:	HIGH
MODULATION:	2500 HZ @ 20 DB ABOVE REFERENCE LEVEL 99 % POWER BANDWIDTH

PERFORMED BY:

Doug Noble, B.A.S. E.E.T.

PAGE NO. 24 of 34.

NAME OF TEST: Emission Masks (Occupied Bandwidth)
g0170368: 2001-Jul-30 Mon 14:09:00
STATE: 2:High Power

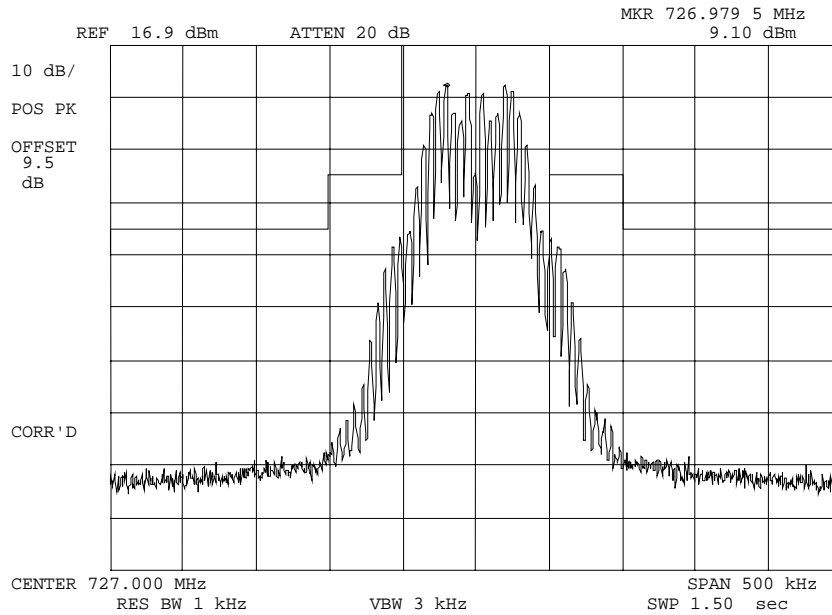

POWER:	HIGH
MODULATION:	5000 HZ @ 20 DB ABOVE REFERENCE LEVEL MASK: Wireless Mic, 74.861

PERFORMED BY:

Doug Noble, B.A.S. E.E.T.

PAGE NO. 25 of 34.

NAME OF TEST: Emission Masks (Occupied Bandwidth)
g0170371: 2001-Jul-30 Mon 14:13:00
STATE: 2:High Power

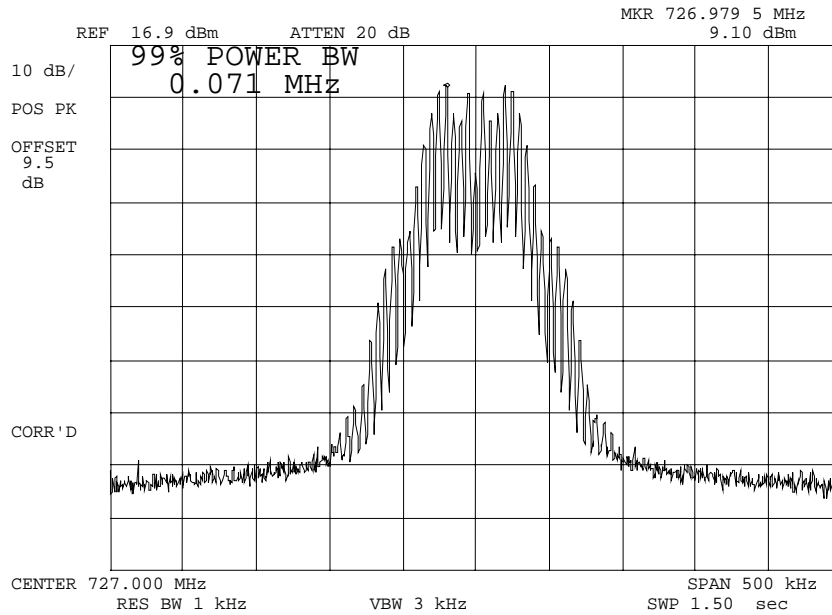

POWER:	HIGH
MODULATION:	5000 HZ @ 20 DB ABOVE REFERENCE LEVEL 99 % POWER BANDWIDTH

PERFORMED BY:

Doug Noble, B.A.S. E.E.T.

PAGE NO. 26 of 34.
NAME OF TEST: Audio Frequency Response
SPECIFICATION: 47 CFR 2.1047(a)
GUIDE: ANSI/TIA/EIA-603-1992, Paragraph 2.2.6
TEST EQUIPMENT: As per previous page

MEASUREMENT PROCEDURE

1. The EUT and test equipment were set up as shown on the following page.
2. The audio signal generator was connected to the audio input circuit/microphone of the EUT.
3. The audio signal input was adjusted to obtain 20% modulation at 1 kHz, and this point was taken as the 0 dB reference level.
4. With input levels held constant and below limiting at all frequencies, the audio signal generator was varied from 100 Hz to 50 kHz.
5. The response in dB relative to 1 kHz was then measured, using the HP 8901A Modulation Analyzer.
6. MEASUREMENT RESULTS: ATTACHED

PAGE NO. 27 of 34.

NAME OF TEST: Audio Frequency Response
 g0170299: 2001-Jul-30 Mon 10:53:00
 STATE: 0:General

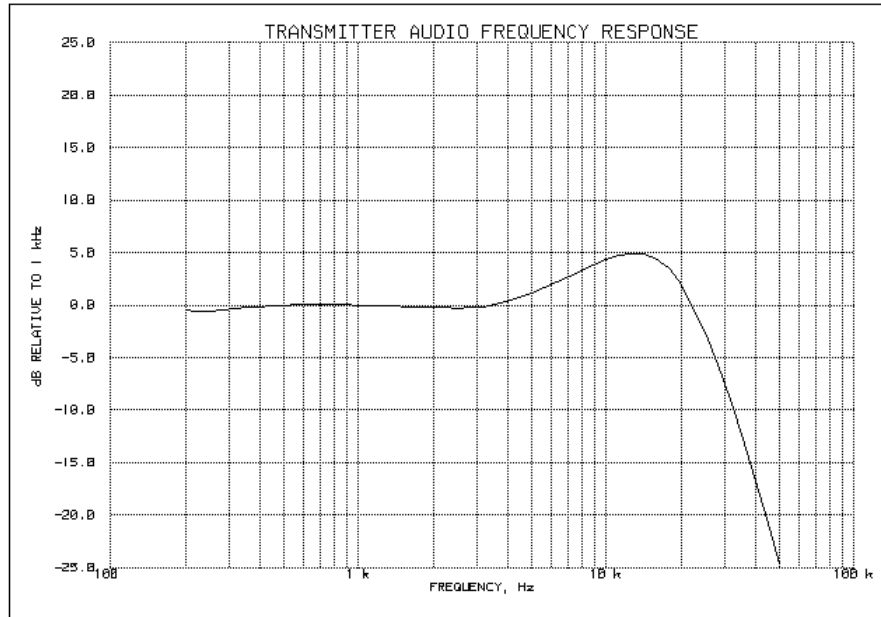

Frequency of Maximum Audio Response, Hz = 12600

Additional points:

FREQUENCY, Hz	LEVEL, dB
300	-0.44
20000	1.86
30000	-7.49
50000	-24.58

PERFORMED BY:

Doug Noble, B.A.S. E.E.T.

PAGE NO. 28 of 34.
NAME OF TEST: Modulation Limiting
SPECIFICATION: 47 CFR 2.1047(b)
GUIDE: ANSI/TIA/EIA-603-1992, Paragraph 2.2.3
TEST EQUIPMENT: As per previous page

MEASUREMENT PROCEDURE

1. The signal generator was connected to the input of the EUT as for "Frequency Response of the Modulating Circuit."
2. The modulation response was measured for each of three frequencies (one of which was the frequency of maximum response), and the input voltage was varied and was observed on an HP 8901A Modulation Analyzer.
3. The input level was varied from 30% modulation (± 1.5 kHz deviation) to at least 20 dB higher than the saturation point.
4. Measurements were performed for both negative and positive modulation and the respective results were recorded.
5. MEASUREMENT RESULTS: ATTACHED

PAGE NO.

29 of 34.

NAME OF TEST: Modulation Limiting
g0170304: 2001-Jul-30 Mon 11:27:00
STATE: 0:General

Positive
Peaks:

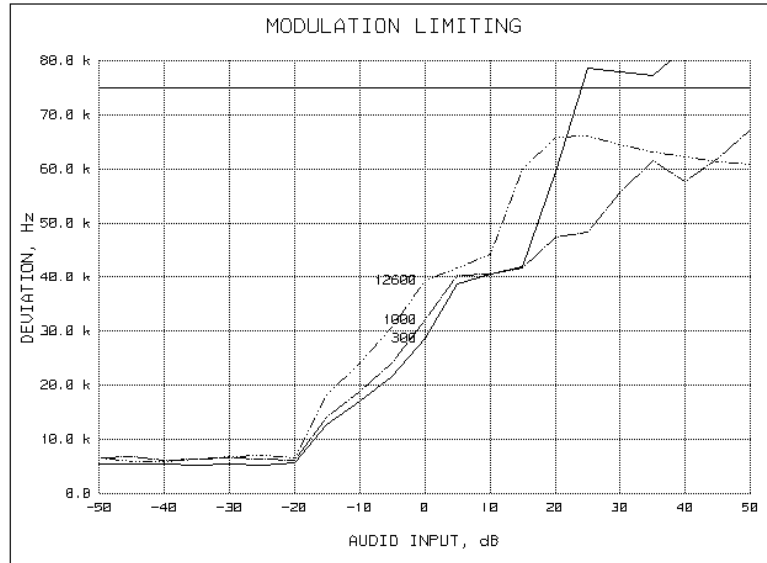

Negative
Peaks:

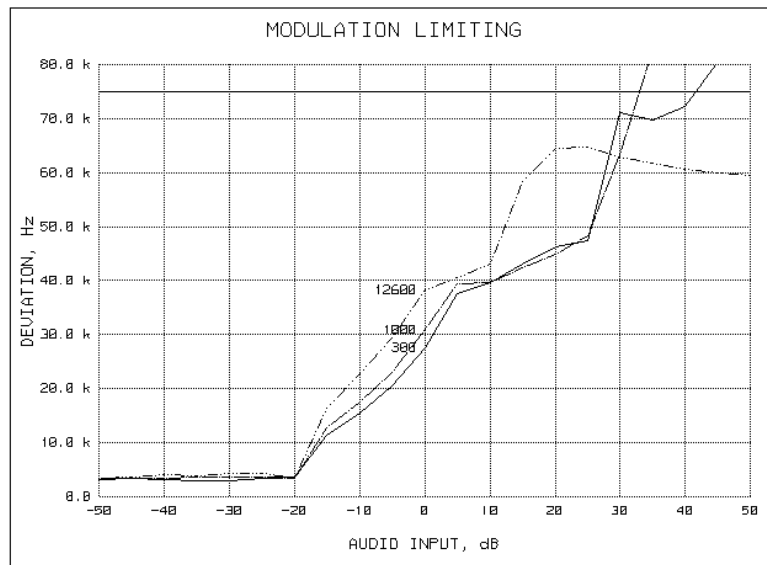

PERFORMED BY:

Doug Noble, B.A.S. E.E.T.

PAGE NO. 30 of 34.
NAME OF TEST: Frequency Stability (Temperature Variation)
SPECIFICATION: 47 CFR 2.1055(a)(1)
GUIDE: ANSI/TIA/EIA-603-1992, Paragraph 2.2.2
TEST CONDITIONS: As Indicated
TEST EQUIPMENT: As per previous page

MEASUREMENT PROCEDURE

1. The EUT and test equipment were set up as shown on the following page.
2. With all power removed, the temperature was decreased to -30°C and permitted to stabilize for three hours. Power was applied and the maximum change in frequency was noted within one minute.
3. With power OFF, the temperature was raised in 10°C steps. The sample was permitted to stabilize at each step for at least one-half hour. Power was applied and the maximum frequency change was noted within one minute.
4. The temperature tests were performed for the worst case.
5. MEASUREMENT RESULTS: ATTACHED

TRANSMITTER TEST SET-UP

- TEST A. OPERATIONAL STABILITY
- TEST B. CARRIER FREQUENCY STABILITY
- TEST C. OPERATIONAL PERFORMANCE STABILITY
- TEST D. HUMIDITY
- TEST E. VIBRATION
- TEST F. ENVIRONMENTAL TEMPERATURE
- TEST G. FREQUENCY STABILITY: TEMPERATURE VARIATION
- TEST H. FREQUENCY STABILITY: VOLTAGE VARIATION

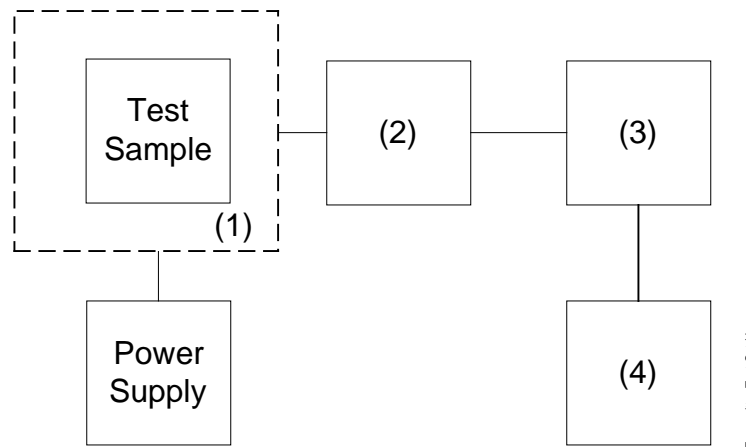

Asset Description (as applicable)	s/n
<u>(1) TEMPERATURE, HUMIDITY, VIBRATION</u>	
i00027 Tenney Temp. Chamber	9083-765-234
i00 Weber Humidity Chamber	
i00 L.A.B. RVH 18-100	
<u>(2) COAXIAL ATTENUATOR</u>	
i00122 NARDA 766-10	7802
i00123 NARDA 766-10	7802A
i00113 SIERRA 661A-3D	1059
i00069 BIRD 8329 (30 dB)	10066
<u>(3) R.F. POWER</u>	
i00014 HP 435A POWER METER	1733A05839
i00039 HP 436A POWER METER	2709A26776
i00020 HP 8901A POWER MODE	2105A01087
<u>(4) FREQUENCY COUNTER</u>	
i00042 HP 5383A	1628A00959
i00019 HP 5334B	2704A00347
i00020 HP 8901A	2105A01087

PAGE NO. 32 of 34.

NAME OF TEST: Frequency Stability (Temperature Variation)
g0170352: 2001-Jul-30 Mon 20:07:47
STATE: 0:General

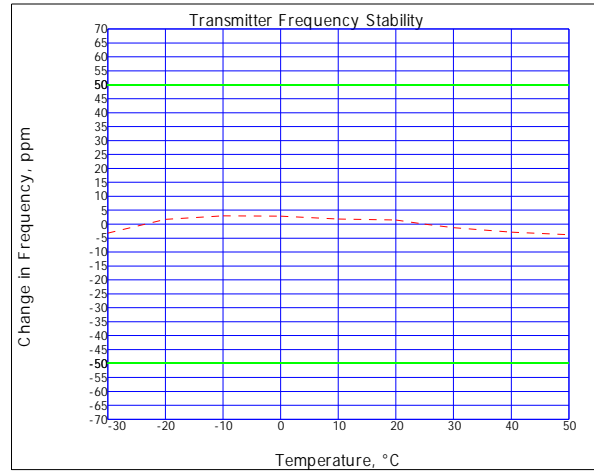

PERFORMED BY:

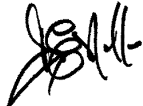
Doug Noble, B.A.S. E.E.T.

PAGE NO. 33 of 34.
NAME OF TEST: Frequency Stability (Voltage Variation)
SPECIFICATION: 47 CFR 2.1055(b)(1)
GUIDE: ANSI/TIA/EIA-603-1992, Paragraph 2.2.2
TEST EQUIPMENT: As per previous page

MEASUREMENT PROCEDURE

1. The EUT was placed in a temperature chamber at 25±5°C and connected as for "Frequency Stability - Temperature Variation" test.
2. The power supply voltage to the EUT was varied from 85% to 115% of the nominal value measured at the input to the EUT.
3. The variation in frequency was measured for the worst case.

RESULTS: Frequency Stability (Voltage Variation)
g0170355: 2001-Jul-30 Mon 11:37:07
STATE: 0:General

LIMIT, ppm = 50
LIMIT, Hz = 36350
BATTERY END POINT (Voltage) = 7.2

% of STV	Voltage	Frequency, MHz	Change, Hz	Change, ppm
85	7.65	726.999970	-30	-0.04
100	9	727.000000	0	0.00
115	10.35	726.999970	-30	-0.04
80	7.2	726.999950	-50	-0.07

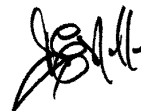

PERFORMED BY:

Doug Noble, B.A.S. E.E.T.

PAGE NO. 34 of 34.
NAME OF TEST: Necessary Bandwidth and Emission Bandwidth
SPECIFICATION: 47 CFR 2.202(g)

MODULATION = 92K0F3E

NECESSARY BANDWIDTH CALCULATION:

MAXIMUM MODULATION (M), kHz	= 15
MAXIMUM DEVIATION (D), kHz	= 31
CONSTANT FACTOR (K)	= 1
NECESSARY BANDWIDTH (B_N), kHz	= $(2 \times M) + (2 \times D \times K)$
	= 92, Measured

PERFORMED BY:

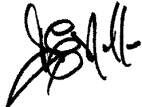
Doug Noble, B.A.S. E.E.T.

END OF TEST REPORT

TESTIMONIAL
AND
STATEMENT OF CERTIFICATION

THIS IS TO CERTIFY THAT:

1. THAT the application was prepared either by, or under the direct supervision of, the undersigned.
2. THAT the technical data supplied with the application was taken under my direction and supervision.
3. THAT the data was obtained on representative units, randomly selected.
4. THAT, to the best of my knowledge and belief, the facts set forth in the application and accompanying technical data are true and correct.

CERTIFYING ENGINEER:



Morton Flom, P. Eng.